

[▶ Troubleshooting](#)

How to Use

---

**Parts Description**

---

**Setup**

---

**Network / Internet**

---

**Connections**

---

**Settings**

---

**Other Operations**

---

**Notifications**

---

**Read This First**

Congratulations on your purchase of this computer and welcome to the on-screen **User Guide**.

**About your computer's configuration**

To find out about the configuration of your computer, visit the Sony online support website.

**About configuration differences in your computer**

Some features, options, and supplied items may not be available on your computer.

**Features**

Available features vary depending on the model or options you selected. Not all features described in this manual are available depending on your model.

**Illustrations**

Illustrations, photos, or screenshots in this manual may look slightly different depending on the model or options you selected.

**Software**

The preinstalled software may vary depending on the model or options you selected. The software described in this manual may not be preinstalled on your computer.

**Supplied manuals**

The following manuals are supplied with your computer.

**On-screen documentation**

- **User Guide - Introduction version**  
A preinstalled manual with limited information of your computer focused on support and internet connection. The **User Guide - Introduction version** is replaced with a complete version of the **User Guide** (this manual) after update. [\[Details\]](#)
- **User Guide (this manual)**  
General information and operation instruction about your computer including support and troubleshooting information

**Printed documentation**

- **Quick Start Guide**  
An overview of components connection, set-up information, etc.
- **Recovery, Backup and Troubleshooting Guide**  
Information on how to recover and back up your computer, as well as troubleshooting information
- **Safety Regulations**  
Read carefully before activating the wireless functions such as the wireless LAN and BLUETOOTH technology.

**Other references**

- **Help and Support**  
General information and technical assistance for your computer.  
To access **Help and Support**, click  (**Start**) and **Help and Support**.  
Choose from the following categories to find the answers you need.

<b>Get started with my VAIO</b>	Get help with Internet and wireless setup, security setup, personalizing your VAIO computer, creating Recovery Media, and more.
<b>Use my VAIO</b>	Get assistance with your VAIO computer by accessing useful information such as interactive VAIO tutorials, how-to articles, the VAIO technology page, specifications, and system and software information. The available information varies depending on the model you purchased.

	You can find useful documentation such as general and model specific user guide on the computer.
<b>Troubleshoot my VAIO</b>	Maintain and troubleshoot your VAIO computer with <b>VAIO Care</b> , system restore, backup and recovery, and contact Sony support.

- **Software help files**

Software help files may be included with the preinstalled software on your computer. You may be able to access the help files from the help menu.

### Notice

- Copyright 2011 Sony Corporation. All rights reserved.
- This manual and the software described herein, in whole or in part, may not be reproduced, translated, or reduced to any machine-readable form without prior written approval.
- Sony Corporation provides no warranty with regard to this manual, the software, or other information contained herein and hereby expressly disclaims any implied warranties or merchantability or fitness for any particular purpose with regard to this manual, the software, or such other information. In no event shall Sony Corporation be liable for any incidental, consequential, or special damages, whether based on tort, contract, or otherwise, arising out of or in connection with this manual, the software, or other information contained herein or the use thereof.
- In the manual, the (TM) or (R) marks are not specified.
- Sony Corporation reserves the right to make any modification to this manual or the information contained herein at any time without notice. The software described herein is governed by the terms of a separate user license agreement.
- Sony Corporation is not liable and will not compensate for any lost recordings made to your computer, external recording media, or recording devices or any relevant losses, including when recordings are not made due to reasons including the computer failure, or when the contents of a recording are lost or damaged as a result of the computer failure or repair undertaken to the computer. Sony Corporation will not restore, recover, or replicate the recorded contents made to the computer, external recording media, or recording devices under any circumstances.
- Features and specifications are subject to change without notice.

---

### Related Topic

■

---

[▶ Troubleshooting](#)

---

**How to Use**

---

**Parts Description**

---

**Setup**

---

**Network / Internet**

---

**Connections**

---

**Settings**

---

**Other Operations**

---

**Notifications**

---

## Welcome

Congratulations on the purchase of this VAIO(R) computer.

This **User Guide - Introduction Version** provides you with limited information about your VAIO computer. To update this file to the complete version of the **User Guide**, see **Updating the User Guide to the Latest Version** [\[Details\]](#) for more information.

[Updating the User Guide to the Latest Version](#)

[Connecting to the Internet](#)

[Updating Your VAIO Computer](#)

[Solving Problems on Your VAIO Computer Using VAIO Care](#)

[Finding Support Information](#)

[Trademarks](#)

[^ Go to top](#)

## Updating the User Guide to the Latest Version

The complete version of the **User Guide** is available online. Update this **User Guide - Introduction Version** to the complete version so that you can access it anytime even if you are offline.

With the complete version of the **User Guide** you can view information about:

- Parts description
- Feature and operating instructions
- Precautions
- Troubleshooting information

### Note

- You will need to connect your VAIO computer to the Internet before updating to the complete version of the **User Guide**. See **Connecting to the Internet** [\[Details\]](#) for more information on connecting the computer to the Internet.

### To get the complete version of the User Guide

By updating this **User Guide - Introduction Version**, you can get the complete version of the **User Guide** with detailed information on your VAIO computer.

1. Connect your VAIO computer to the Internet.
2. Close this window, and then click  (**Start**), **All Programs**, and **VAIO Manual** again.
3. A window prompting you to update the manual appears. Follow the on-screen instructions.

This file will automatically update to the complete version of the **User Guide**.

### Hint

- It may take some time to complete the update.
- If the window prompting you to update the **User Guide** does not appear, make sure your VAIO computer is connected to the Internet and repeat the above steps. If the update window still does not appear, launch **VAIO Update** so you can find and download the **User Guide** manually. See **Updating Your VAIO Computer** [\[Details\]](#) for more information on **VAIO Update**.

### To view help files for Windows OS and software operations

When you have trouble operating your VAIO computer, try referring to **Windows Help and Support** or help files included with your applications.

To access **Windows Help and Support**, click  (**Start**) and **Help and Support**.

[^ Go to top](#)

## Connecting to the Internet

You will need to connect your VAIO computer to the Internet before updating to the complete version of the **User Guide**.

### Before connecting to the Internet

Before using the Internet, you will need to sign up with an Internet Service Provider (ISP) and set up devices required for connecting your VAIO computer to the Internet.

The following types of Internet connection services may be available from your ISP:

- Fiber to the Home (FTTH)
- Digital Subscriber Line (DSL)
- Cable modem
- Satellite
- Dial-up

For more information on devices required for Internet access and how to connect your VAIO computer to the Internet, ask your ISP.

The following is one of the Internet connection methods as an example.

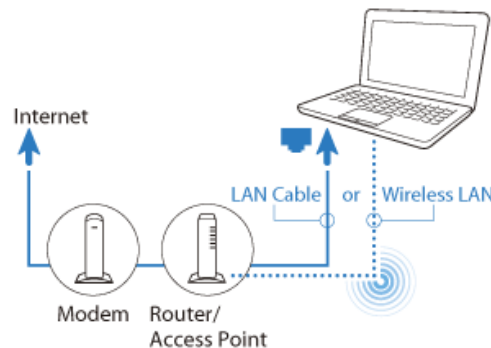

### To use the network (LAN)

You can connect your VAIO computer to networks with a LAN cable (not supplied). Connect one end of a LAN cable (not supplied) to the LAN port on the computer and the other end to your network administrator.

#### Note

- The connection, setting method, or required devices may vary depending on your network environment.

### To use the wireless LAN network (Wi-Fi)

You first need to establish wireless LAN communications between your VAIO computer and an access point (not supplied). See **Windows Help and Support** for more information.

### To start wireless LAN communications with VAIO Easy Connect

You can easily set up wireless LAN communications by following the instructions in **VAIO Easy Connect**. **VAIO Easy Connect** supports you especially when you first set up a wireless Internet connection at home or when you connect to a public wireless network (Wi-Fi hotspot).

1. Click  (Start), **All Programs**, **VAIO Easy Connect**, and **Easy Internet Connection Setup**.
2. Follow the on-screen instructions to setup wireless LAN communications.

[^ Go to top](#)

## Updating Your VAIO Computer

Be sure to update your VAIO computer with the following software applications to enhance the computer's efficiency, security, and functionality.

#### Note

- Your VAIO computer must be connected to the Internet to download the updates.

### To use Windows Update

**Windows Update** enables you to make your VAIO computer more stable.

1. Click  (Start), **All Programs**, and **Windows Update**.
2. Follow the on-screen instructions.

### To use VAIO Update

**VAIO Update** automatically notifies you of new updates available on the Internet then downloads and installs them on your VAIO computer.

1. Click  (Start), **All Programs**, and **VAIO Update**.

2. Follow the on-screen instructions.

### To update antivirus software

Help protect your VAIO computer against security threats by keeping Internet security programs current with the latest updates. You can download and install the updates from the website of the manufacturer.

1. Click  (**Start**), **All Programs**, and select the antivirus software.
2. Follow the on-screen instructions to complete the updates.

[^ Go to top](#)

---

## Solving Problems on Your VAIO Computer Using VAIO Care

With **VAIO Care**, you can regularly conduct performance checks and system tune-ups on your VAIO computer to keep it running at optimum level. Launch **VAIO Care** whenever a problem arises.

**VAIO Care** will provide appropriate measures and support information to solve the problem.

### To launch VAIO Care

Press the **ASSIST** button while your VAIO computer is on.

#### Hint

- Alternatively, click  (**Start**), **All Programs**, and **VAIO Care** to launch **VAIO Care**.
- See the help file included with **VAIO Care** for more information.
- Pressing the **ASSIST** button while your VAIO computer is off launches **VAIO Care Rescue**. **VAIO Care Rescue** can be used to recover the computer in case of emergency, for example, when Windows does not start.

[^ Go to top](#)

---

## Finding Support Information

The Sony online support website provides instant access to information on commonly encountered problems. You can find support information such as the support website URL in **VAIO Care** or the supplied **Quick Start Guide**.

[^ Go to top](#)

---

## Trademarks

- SONY and the SONY logo are registered trademarks of Sony Corporation.
- VAIO, the VAIO logo, and other Sony product or service names are trademarks or registered trademarks of Sony Corporation.
- Windows and the Windows logo are either registered trademarks or trademarks of Microsoft Corporation in the United States and/or other countries.
- All other names of system, products, and services are trademarks of their respective owners.
- In the manual, the TM or (R) marks are not specified.

[^ Go to top](#)

---

Copyright 2011 Sony Corporation

[▶ Troubleshooting](#)

---

**How to Use**

---

**Parts Description**

---

**Setup**

---

**Network / Internet**

---

**Connections**

---

**Settings**

---

**Other Operations**

---

**Notifications**

---

## Checking Supplied Items

Check all items packed with the product before use.

**AC adapter**

**Power cord**

**Battery pack**

**Hint**

- No recovery media is included because your computer can be recovered using data stored in the hard disk drive or SSD. See **Recovering from the Recovery Area** for more information.
-



[▶ Troubleshooting](#)

## How to Use

[Parts Description](#)[Setup](#)[Network / Internet](#)[Connections](#)[Settings](#)[Other Operations](#)[Notifications](#)**Parts and Controls on the Front**

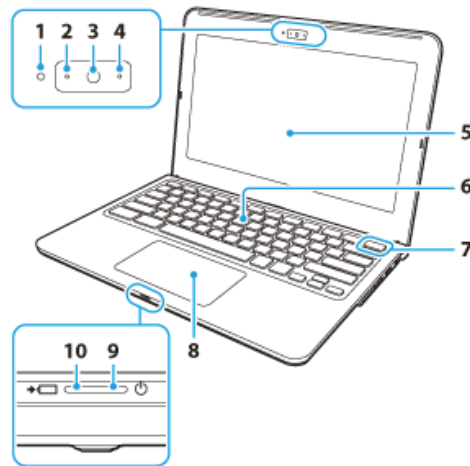
Describes the features on the front of the computer, such as buttons and indicator lights.



1. Ambient light sensor
2. Built-in microphone (monaural)
3. Built-in camera
4. Built-in camera indicator
5. LCD screen
6. Keyboard
7.  (power) key [\[Details\]](#)
8. Touch pad [\[Details\]](#) (Left/right buttons [\[Details\]](#))
9.  Power indicator [\[Details\]](#)
10.  Charge indicator [\[Details\]](#)

**Related Topic**[Parts and Controls on the Sides](#)[Parts and Controls on the Bottom](#)

[▶ Troubleshooting](#)

## How to Use

[Parts Description](#)[Setup](#)[Network / Internet](#)[Connections](#)[Settings](#)[Other Operations](#)[Notifications](#)

## Parts and Controls on the Sides

Describes the features on the sides of the computer, such as connection ports.

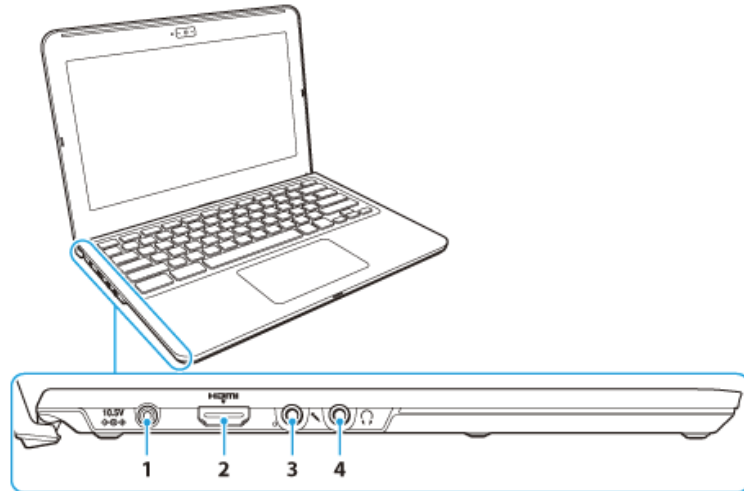

1. DC IN port [\[Details\]](#)
2. HDMI output port [\[Details\]](#)
3. Microphone jack [\[Details\]](#)
4. Headphones jack [\[Details\]](#)

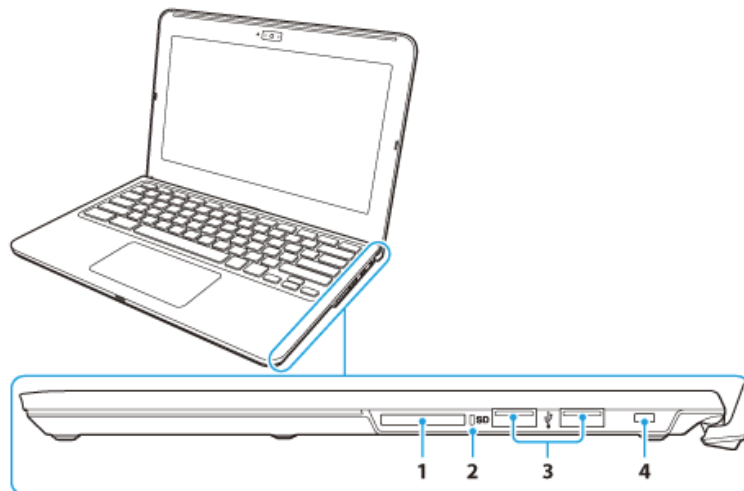

1. SD memory card slot [\[Details\]](#)
2. SD memory card indicator [\[Details\]](#)
3. USB ports [\[Details\]](#)
4. Security slot

### Related Topic

[Parts and Controls on the Sides](#)[Parts and Controls on the Bottom](#)



[▶ Troubleshooting](#)

---

**How to Use**

---

**Parts Description**

---

**Setup**

---

**Network / Internet**

---

**Connections**

---

**Settings**

---

**Other Operations**

---

**Notifications**

---

**Parts and Controls on the Bottom**

Describes the features on the bottom of the computer.

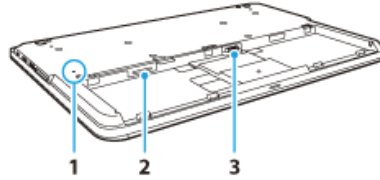

1. Recovery button
2. SIM card slot
3. Battery connector [\[Details\]](#)

---

**Related Topic**

[Parts and Controls on the Front](#)

[Parts and Controls on the Sides](#)

---

[▶ Troubleshooting](#)[How to Use](#)[Parts Description](#)[Setup](#)[Network / Internet](#)[Connections](#)[Settings](#)[Other Operations](#)[Notifications](#)

## Installing/Removing the Battery Pack

Install the battery pack into the battery compartment on the bottom of your computer.  
**Do not use the computer without installing the battery pack as it may cause the computer to malfunction.**

### To install the battery pack

1. Turn off your computer and close the LCD screen lid.
2. Slide the battery **LOCK** switches (1) inward.

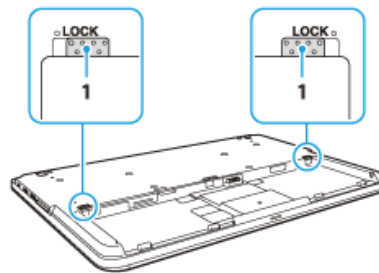

3. Place the battery pack into the battery compartment until the projections (2) on either side of the battery pack fit into the grooves (1).

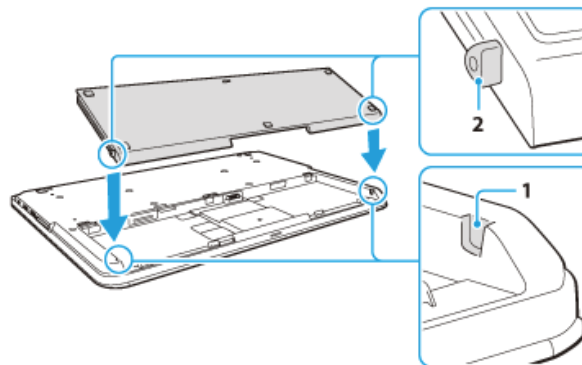

4. Push down the circled area on the battery pack until the battery pack clicks into place.

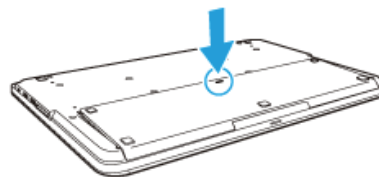

5. Slide the battery **LOCK** switches outward to secure the battery pack on your computer.

### To remove the battery pack

1. Turn off your computer and close the LCD screen lid.
2. Slide the battery **LOCK** switches inward.
3. Slide and hold the battery **RELEASE** latch (1), put your fingertip underneath the tab (2) on the battery pack, and lift the battery pack in the direction of the arrow.

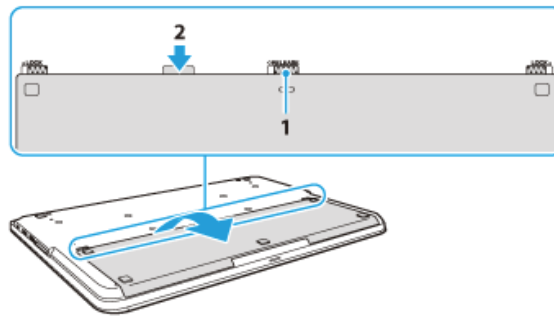

4. Slide the battery pack diagonally to take out from the computer.

**Note**

- You will lose all unsaved data if you remove the battery pack while your computer is on or in Sleep mode and not connected to the AC adapter.  
Be sure to turn off the computer before removing the battery pack.

---

**Related Topic**

[Charging the Battery Pack](#)

[Notes on Using the Battery Pack](#)

[Shutting Down Your Computer](#)

---

[▶ Troubleshooting](#)

---

**How to Use**

---

**Parts Description**

---

**Setup**

---

**Network / Internet**

---

**Connections**

---

**Settings**

---

**Other Operations**

---

**Notifications**



---

## Charging the Battery Pack

The battery pack can be charged even while you are using your computer when the computer is connected to a power source. The charging time may vary depending on operating conditions.

1. Install the battery pack into your computer. [\[Details\]](#)
2. Plug the computer into an AC outlet. [\[Details\]](#)

**Hint**

- The charging time varies depending on ambient temperature.  
Note that at a low ambient temperature, it takes longer time to charge the battery pack.
- To check the battery status of your computer, click the battery icon, such as  (on battery) or  (plugged in), in the desktop notification area.

---

**Related Topic**[Charge Indicator Status List](#)

[▶ Troubleshooting](#)

---

**How to Use**

---

**Parts Description**

---

**Setup**

---

**Network / Internet**

---

**Connections**

---

**Settings**

---

**Other Operations**

---

**Notifications**

---

## Notes on Using the Battery Pack

Before using the battery pack, read the following precautions for correct use.

### About the battery pack

- The supplied battery pack is designed specifically for your computer.
- For your safety, only use the supplied battery pack or an optional battery pack that is specified by Sony.
- For safety reasons, battery charging may be suspended at higher or lower temperatures.
- While your computer is connected to an AC outlet with the AC adapter, it runs on AC power, even if the battery pack is installed.
- The battery pack is not fully charged at the time of delivery.
- While the battery pack is in use or being charged, heat builds up in the battery pack. This is normal and is not cause for concern.
- Do not use your computer without installing the battery pack as it may cause the computer to malfunction.

### About battery discharge

After battery charge, the battery pack will gradually discharge over time even while not in use. If it is left unused for an extended period of time, the battery power may be depleted. It is recommended that you recharge the battery pack before use.

### About battery life

Battery life varies depending on usage and settings.

### About battery deterioration and replacement

- The battery pack is consumable. The capacity gradually declines through repeated cycles of recharging and discharging. As a result, the battery life becomes short even if it is fully charged and eventually the battery pack reaches the end of its life.
- If the battery pack quickly runs out of power after being fully charged or it has reached the end of its life, replace it with a new one.

### When using the power saving mode

If the battery pack runs out during Sleep mode, all unsaved data before your computer enters Sleep mode will be lost and cannot be restored. Be sure to save all data before placing the computer into Sleep mode.

In Hibernate mode, all data and status (such as window position, size, etc.) are saved to the built-in storage device, so no data will be lost even if the battery pack runs out. If you cannot connect the computer to an AC power source for an extended period of time, place the computer into Hibernate mode.

### When the battery pack is running out of power

If the battery pack runs out during your absence, power will be cut off and any data you are working on will be lost.

While your computer is running on battery power, save data frequently and manually place the computer into Hibernate mode if necessary.

---

**Related Topic**

[Notes on Using the Power Source](#)

---

[▶ Troubleshooting](#)

---

**How to Use**

---

**Parts Description**

---

**Setup**

---

**Network / Internet**

---

**Connections**

---

**Settings**

---

**Other Operations**

---

**Notifications**

---

## Connecting a Power Source

Connect your computer to an AC power source. Carefully read the precautions in **Notes on Using the Power Source** before connection. [\[Details\]](#)

1. Plug one end of the power cord (1) into the AC adapter (3).
2. Plug the other end of the power cord into an AC outlet (2).
3. Plug the cable from the AC adapter (3) into the DC IN port (4) on your computer.

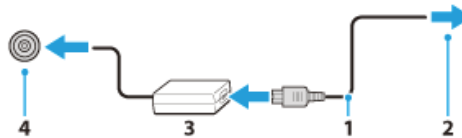
**Note**

- Do not plug more than one device into the same AC outlet.
- The shape of the AC adapter varies depending on the model you purchased.
- Make sure that the power plug is firmly plugged into your computer.

**Hint**

- You can purchase a power strip with a surge protector to help prevent damage to your computer caused by sudden power surges (in an electrical storm, for example).

---

**Related Topic**[Installing/Removing the Battery Pack](#)[Charging the Battery Pack](#)[Notes on Using the Battery Pack](#)[Turning on Your Computer](#)[Shutting Down Your Computer](#)[Notes on Using the Power Source](#)

---

[▶ Troubleshooting](#)

---

**How to Use**

---

**Parts Description**

---

**Setup**

---

**Network / Internet**

---

**Connections**

---

**Settings**

---

**Other Operations**

---

**Notifications**

---

## Turning on Your Computer

Turn on your computer to start Chrome OS.

Carefully read the precautions in **Notes on Using the Power Source** before turning on.

[\[Details\]](#)

1. Install the battery pack on your computer [\[Details\]](#), and then connect to an AC outlet.  
[\[Details\]](#)
2. Lift the LCD screen lid.  
The computer automatically turns on and Chrome OS starts.

**Note**

- Pressing the  (power) key activates a screen saver.  
If, however, you press and hold down the power key for more than four seconds, your computer will be turned off.
- Do not use your computer without installing the battery pack as it may cause the computer to malfunction.
- When opening the LCD screen lid, do not hold the built-in camera as it may cause your computer to malfunction. (Built-in camera equipped models)

**Hint**

- By default, your computer automatically enters Sleep mode after a certain period of inactivity while the computer is connected to an AC outlet. 

---

**Related Topic**

[Installing/Removing the Battery Pack](#)

[Charging the Battery Pack](#)

[Notes on Using the Battery Pack](#)

[Connecting a Power Source](#)

[Shutting Down Your Computer](#)



[Notes on Using the Power Source](#)

---

[▶ Troubleshooting](#)

---

**How to Use**

---

**Parts Description**

---

**Setup**

---

**Network / Internet**

---

**Connections**

---

**Settings**

---

**Other Operations**

---

**Notifications**

---

## Shutting Down Your Computer

Shut down your computer properly to avoid losing unsaved data.

1. Turn off any peripherals connected to your computer.
2. Save your data and close all running software applications.
3. Close the LCD screen lid.

The computer and the green power indicator light are automatically turned off.

**Note**

- An improper shutdown may cause loss of unsaved data or your computer to malfunction.
- To disconnect your computer completely from an AC power source, turn off the computer and unplug the power cord from the AC outlet.

---

**Related Topic**

[Turning on Your Computer](#)

<

[Notes on Using the Power Source](#)

---



[▶ Troubleshooting](#)

How to Use

---

**Parts Description**

---

**Setup**

---

**Network / Internet**

---

**Connections**

---

**Settings**

---

**Other Operations**



---

**Notifications**

---

### Charge Indicator Status List

The charge indicator light  turns on or blinks differently according to conditions.

Lit in orange	The battery pack is charging. (Turns off when charging is completed.)
Blinks along with the green power indicator 	The battery pack is running out of power. (Normal mode)
Blinks along with the orange power indicator 	The battery pack is running out of power. (Sleep mode)
Blinks fast in orange	A battery error has occurred due to a failed battery pack or an unlocked battery pack.

---

**Related Topic**

[Charging the Battery Pack](#)

[▶ Troubleshooting](#)

---

**How to Use**

---

**Parts Description**

---

**Setup**

---

**Network / Internet**

---

**Connections**

---

**Settings**

---

**Other Operations**

---

**Notifications**

---

## Notes on Using the Power Source

Read the following precautions before plugging your computer into an AC power source.

- If you remove the battery pack while your computer is turned on or in Sleep mode but it is disconnected from an AC power source, you will lose all unsaved data.
- If you do not intend to use your computer for an extended period of time while it is disconnected from an AC power source, place the computer into Hibernate mode or turn it off.

### Notes on the AC adapter

- Use the AC adapter supplied with your computer or genuine Sony products. Do not use any other AC adapter as it may cause a malfunction.
- Do not connect the AC adapter to a power conversion device such as a travel power converter. It may cause overheating or a malfunction.
- If the AC adapter cable becomes damaged or broken, do not use it.

### Notes on turning on your computer

- Because your computer contains magnetic components, keep magnetic storage media, such as floppy disks, away from the computer, as it may cause data corruption.
- Your computer will automatically enter Sleep mode (with the default settings) when you move magnetic devices closer to the computer. Keep magnetic devices away from the computer.

---

#### Related Topic

[Connecting a Power Source](#)

[Turning on Your Computer](#)

[Shutting Down Your Computer](#)

---

## ▶ Troubleshooting

### How to Use

---

#### Parts Description

---

#### Setup

---

#### Network / Internet

---

#### Connections

---

#### Settings

---

#### Other Operations

---

#### Notifications

---

## Using the Touch Pad

By sliding your finger on the touch pad, you can move the pointer on the computer screen. With the pointer on your desired item or object, press the left button or the right button to execute various commands or display menus.

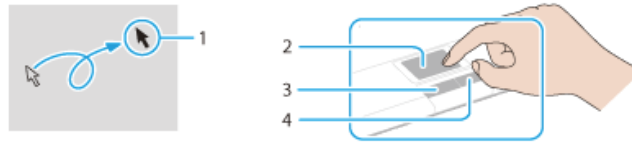

#### To click

With the pointer (1) on your desired item or object, press the left button (3) once. Alternatively, tap on the touch pad (2) once.

#### To double-click

With the pointer on your desired item or object, press the left button twice in a row. Alternatively, tap on the touch pad twice quickly.

#### To right-click

With the pointer on your desired item or object, press the right button (4) once. Depending on the location of the pointer, you can display various shortcut menus.

#### To drag

With the pointer on your desired object, press the left button once, and while holding down the button, slide your finger on the touch pad. Alternatively, tap on the touch pad twice quickly, and on the second tap, slide your finger.

#### To drag and drop

Drag an icon, such as a file, to a folder, a window, or a software icon to your desired location and release the left button.

Alternatively, tap the icon twice quickly, and on the second tap, slide your finger to your desired location and lift the finger off the touch pad.

#### To scroll

Slide your finger along the right edge up and down to scroll vertically in the active window. Slide your finger along the bottom edge from side to side to scroll horizontally in the active window.

Once vertical or horizontal scrolling is engaged, you can move your finger in circles on the touch pad to keep scrolling without taking the finger off the touch pad. Move the finger in circles from the right edge of the touch pad to scroll vertically, or from the bottom edge of the touch pad to scroll horizontally. (The scroll function works only with applications that support the function.)

#### To back or forward without moving the pointer

On the software that supports the back/forward function, such as a web browser, put two fingers on the touch pad and slide them from side to side to perform the back/forward operation without moving the pointer.

#### To zoom in or out

With some software applications, such as a photo viewer, pinch on the touch pad with two fingers for zooming. Pinch open to zoom in or pinch close to zoom out.

#### Note

- The scroll function and the zoom function may not work depending on the software you are using.
- The scroll function and the zoom function may be disabled by default.

#### Hint

- Refer to the help file of the touch pad for detailed information on how to use the touch pad.

---

#### Related Topic





▶ [Troubleshooting](#)

How to Use

---

**Parts Description**

---

**Setup**

---

**Network / Internet**

---

**Connections**

---

**Settings**

---

**Other Operations**

---

**Notifications**

---

### Connecting a TV with an HDMI Input Port

You can connect a TV with an HDMI input port to your computer with an HDMI cable (not supplied).

Refer to the manual that came with your TV for more information on installation and use.

1. Plug the power cord of your TV into an AC outlet.
2. Connect one end of an HDMI cable to the **HDMI** output port [\[Details\]](#) on your computer and the other end to the TV.
3. Set the TV input to the external input.  
The screen image of your computer is displayed on the TV.

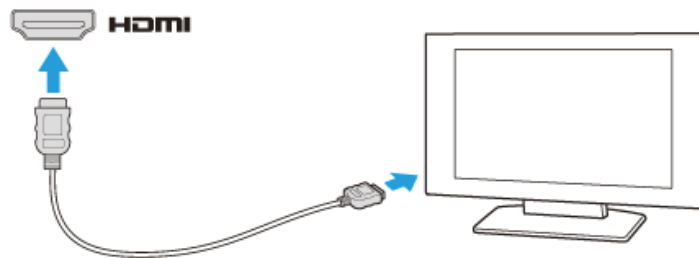

**Note**

- If a device driver other than the one provided by Sony is used, the image will not be displayed and audio will not be heard. Always use the device driver provided by Sony for updates.

---

**Related Topic**



[▶ Troubleshooting](#)

---

**How to Use**

---

**Parts Description**

---

**Setup**

---

**Network / Internet**

---

**Connections**

---

**Settings**

---

**Other Operations**

---

**Notifications**

---

## Adjusting the Speakers Volume

You can change the volume level of the speakers and headphones.

### To decrease the volume using the volume control key

1. Press and hold down the  (volume down) key.  
The volume is turned down.

### To increase the volume using the volume control key

1. Press and hold down the  (volume up) key.  
The volume is turned up.

### To turn on/off the volume using the muting key

1. Press the  (muting) key.  
The volume is turned off.  
Press the key again to turn on the volume.

---

**Related Topic**

[Connecting External Speakers or Headphones](#)

---

[▶ Troubleshooting](#)

---

**How to Use**

---

**Parts Description**

---

**Setup**

---

**Network / Internet**

---

**Connections**

---

**Settings**

---

**Other Operations**

---

**Notifications**

---

## Connecting External Speakers or Headphones

You can connect external sound output devices (such as speakers or headphones) to your computer.

1. Connect external speakers to the headphones jack [\[Details\]](#) with a speaker cable (not supplied).

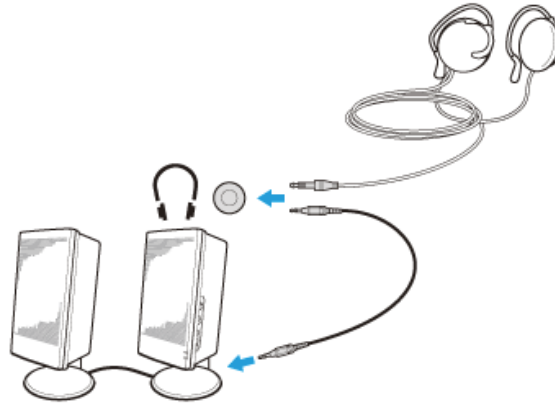
**Note**

- Turn down the volume of the speakers before turning them on.

**Hint**

- Refer to the manual that came with your speakers or headphones.

---

**Related Topic**[Adjusting the Speakers Volume](#)[Connecting an External Microphone](#)

[▶ Troubleshooting](#)

---

**How to Use**

---

**Parts Description**

---

**Setup**

---

**Network / Internet**

---

**Connections**

---

**Settings**

---

**Other Operations**

---

**Notifications**

---

## Connecting an External Microphone

You can connect an external microphone to your computer and enjoy voice chat, etc.

1. Plug the microphone cable into the microphone jack [▶ \[Details\]](#).

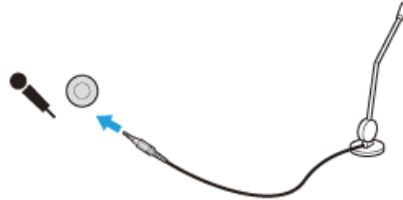
**Note**

- If you connect or disconnect the microphone to/from your computer while running voice recording software, voice recording may fail or the software may exit. Connect the microphone and select it as the sound recording device for Windows before starting the software.

**Hint**

- Use a plug-in-power microphone.
- Refer to the manual that came with your microphone.
- If microphone feedback occurs, move the microphone away from your speakers.

---

**Related Topic**

[Connecting External Speakers or Headphones](#)

---



[▶ Troubleshooting](#)

---

**How to Use**

---

**Parts Description**

---

**Setup**

---

**Network / Internet**

---

**Connections**

---

**Settings**

---

**Other Operations**

---

**Notifications**

---

## About the Internet Connection Services

The following types of Internet connection services are available. You can select from among the services according to your preference, for example, communication speed or a usage fee. For detailed information on a variety of connection services, contact Internet Service Providers (ISPs).

- Fiber to the Home (FTTH)
- Cable modem
- Digital Subscriber Line (DSL)
- Satellite

---

**Related Topic**[<](#)[Starting Wireless LAN Communications](#)

---

[▶ Troubleshooting](#)

---

**How to Use**

---

**Parts Description**

---

**Setup**

---

**Network / Internet**

---

**Connections**

---

**Settings**

---

**Other Operations**

---

**Notifications**

---

## About the Wireless LAN Standards

The Wireless Local Area Network (WLAN) allows your computer to connect to a network through a wireless connection.

The WLAN uses the following IEEE 802.11a/b/g/n standard, which specifies the type of technology used.

Refer to the specifications to find out about the configuration of the computer.

WLAN standard	Frequency band	Remarks
IEEE 802.11a	5 GHz	Exclusive to models compliant with the IEEE 802.11a/b/g/n standard.
IEEE 802.11b/g	2.4 GHz	The IEEE 802.11g standard provides higher-speed communications than the IEEE 802.11b.
IEEE 802.11n	5 GHz/2.4 GHz	For models compliant with the IEEE 802.11b/g/n standard, only 2.4 GHz band can be used.

---

**Related Topic**

[Starting Wireless LAN Communications](#)

[Stopping Wireless LAN Communications](#)

[Notes on Using the Wireless LAN Function](#)

---

▶ Troubleshooting

How to Use

---

Parts Description

---

Setup

---

Network / Internet

---

Connections

---

Settings

---



Other Operations

---

Notifications

---

## Starting Wireless LAN Communications

You can connect your computer to a Wi-Fi network and access the Internet wirelessly. Click  (the network icon) in the upper right corner to detect available Wi-Fi networks in range. The secure network is displayed with  and you will be prompted to enter user information for the network.

### About supported types of Wi-Fi networks

Sony Chromebook (TBD) supports the following wireless standards and security protocols.

- Wireless standards: 802.11a/b/g/n
- Security protocols: WEP, WPA-PSK, WPA-Enterprise, (TBD)

Sony Chromebook does not support networks which require security credentials as of now.

### To enable Wi-Fi on your computer

1. Click  (the network icon) in the upper right corner.
2. Select **@@@Enable Wi-Fi@@@** to enable Wi-Fi.  
Your computer automatically detects available networks in range and displays them on the network menu.

**Hint**

- When **@@@Disable Wi-Fi@@@** is displayed on the menu, it indicates Wi-Fi is currently enabled.



3. Select your desired network.  
You will be prompted to enter a password when connecting the computer to the network protected by the password.  
To use the security protocol (WPA or WPA2-Personal), select **WPA**.

The network icon flashes while the Wi-Fi connection is established. When the connection is lost,  is displayed.

Some networks allow access only to certain MAC addresses. To check the MAC address of your computer, click [here](#).

### About the network status

When your computer is connected to the Internet using a Wi-Fi network, the network status icon in the upper right corner shows the current status of the network connection.

	Indicates your computer is connected to a Wi-Fi network. The number of lit bars indicates the strength of the network connection.
	Indicates your computer is not connected to a Wi-Fi network.

**Hint**

- You can automatically connect your computer to the Wi-Fi network that is saved as a network profile on the computer.

[▶ Troubleshooting](#)

---

**How to Use**

---

**Parts Description**

---

**Setup**

---

**Network / Internet**

---

**Connections**

---

**Settings**

---

**Other Operations**

---

**Notifications**

---

## Stopping Wireless LAN Communications

To stop wireless LAN (Wi-Fi) communications, follow these steps.

1. Click  (the network icon) in the upper right corner.
  2. Select **@@@Disable Wi-Fi@@@**.  
When **@@@Enable Wi-Fi@@@** is displayed on the menu, it indicates Wi-Fi is currently disabled.
-

[▶ Troubleshooting](#)**How to Use****Parts Description****Setup****Network / Internet****Connections****Settings****Other Operations****Notifications****Notes on Using the Wireless LAN Function**

Before using the wireless LAN function, read the following precautions for correct use.

- In some countries or regions, using the Wireless LAN products may be restricted by the local regulations.
- Wireless LAN devices work on the 2.4 GHz band, which is used by a variety of devices. Wireless LAN devices use the technology to minimize radio interference from other devices that use the same band; however, radio interference may still slow communication speeds, reduce communication range, or cause communication failure.
- If both the BLUETOOTH function and the 2.4 GHz wireless LAN function of your computer are enabled, interference may occur and cause slower communication speeds or other problems.
- To communicate via a wireless LAN while you are on the road, you may need to contract with a wireless LAN connection service provider.
- If your computer is equipped with the IEEE 802.11a/b/g/n standard, outdoor use of the 5 GHz wireless LAN function is prohibited by law.
- The communication speed and range may vary depending on the following conditions:
  - Distance between devices
  - Existence of obstacles between devices
  - Device configuration
  - Radio conditions
  - Ambient environment (including wall material, etc.)
  - Software in use

Communications may be cut off depending on radio conditions.
- The data transfer rate specified in the specification is the theoretical maximum, and may not reflect actual data transfer rate.
- Actual communication speed may not be as fast as the one displayed on your computer.
- The 2.4 GHz Wireless LAN and 5 GHz Wireless LAN frequency bands are not communicable with one another.
- The data transfer rate of IEEE 802.11g and IEEE 802.11n (2.4 GHz) may be affected by interference when used with an IEEE 802.11b product. Also, IEEE 802.11g and IEEE 802.11n automatically lower the transfer rate to maintain compatibility with an IEEE 802.11b product. The transfer rate may be regained by changing the channel settings of your access point.
- The IEEE 802.11a standard and the IEEE 802.11n standard are not available on ad-hoc networks.
- To stop the wireless LAN function abruptly, turn off your computer.
- The WLAN standard includes the encryption methods: Wired Equivalent Privacy (WEP), which is a security protocol, Wi-Fi Protected Access 2 (WPA2), and Wi-Fi Protected Access (WPA). Proposed jointly by the IEEE and Wi-Fi Alliance, both WPA2 and WPA are specifications of standards based on interoperable security enhancements that increase the level of data protection and access control for existing Wi-Fi networks. WPA is designed to be forward compatible with the IEEE 802.11i specification. It utilizes the enhanced data encryption Temporal Key Integrity Protocol (TKIP) in addition to user authentication using 802.1X and Extensible Authentication Protocol (EAP). Data encryption protects the vulnerable wireless link between clients and access points. Besides that, there are other typical LAN security mechanisms to ensure privacy, such as: password protection, end-to-end encryption, virtual private networks, and authentication. WPA2, the second generation of WPA, provides stronger data protection and network access control and is also designed to secure all versions of 802.11 devices, including 802.11b, 802.11a, 802.11g, and 802.11n standards, multi-band and multi-mode. In addition, based on the ratified IEEE 802.11i standard, WPA2 provides government grade security by implementing the National Institute of Standards and Technology (NIST) FIPS 140-2 compliant AES encryption algorithm and 802.1X-based authentication. WPA2 is backward compatible with WPA.

**Related Topic**

[About the Wireless LAN Standards](#)

[Starting Wireless LAN Communications](#)

[Stopping Wireless LAN Communications](#)

[▶ Troubleshooting](#)

---

**How to Use**

---

**Parts Description**

---

**Setup**

---

**Network / Internet**

---

**Connections**

---

**Settings**

---

**Other Operations**

---

**Notifications**

---

## Using the Wireless WAN

This topic describes how to connect your computer to the Internet using the wireless WAN (WWAN).

1. Sign up with a telecommunications carrier that provides the wireless WAN service. Once you have signed up with the carrier, you will receive documents, such as a manual, from the carrier.
2. Follow the instructions in the manual provided by the carrier.
3. Configure the connection settings on your computer. Refer to the Google website for more information on how to configure the wireless WAN connection settings.

**Note**

- Be sure to follow the instructions in the manual provided by the carrier.
  - Be sure to establish security measures against unauthorized access to your computer before using the wireless WAN for the first time.
  - You may be asked to provide your credit card information by the carrier you sign up with.
  - Charges vary depending on the carrier you sign up with.
-

[▶ Troubleshooting](#)**How to Use****Parts Description****Setup****Network / Internet****Connections****Settings****Other Operations****Notifications****Connecting a USB Device**

You can connect a Universal Serial Bus (USB) device such as a mouse, floppy disk drive, speaker or printer to your computer. Installation of the device driver software supplied with the USB device may be required when connecting. Refer to the manual that came with the device for more information.

1. Choose the USB port (1) you prefer to use.
2. Plug the USB device cable (2) (not supplied) into the USB port.

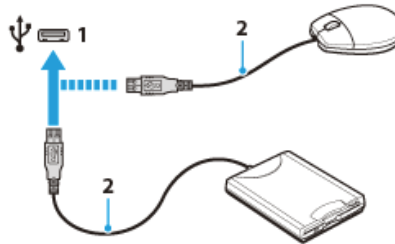
**Note**

- You may need to install the driver software supplied with your USB device before use. Refer to the manual that came with the USB device for more information.
- In order to print documents, be sure the USB printer is compatible with your version of Windows.
- Before disconnecting USB speakers from your computer, stop DVD or music playback or turn off the computer. If you disconnect the USB speakers during playback, it may cause a malfunction.  
For information on how to remove a USB device, refer to the manual that came with the device.
- To protect your computer and/or USB devices from damage, observe the following:
  - When moving your computer with USB devices connected, avoid exposing the USB ports to shock or impact.
  - Do not put your computer in a bag or carrying case with USB devices connected.

**Hint**

- The USB ports on your computer are compliant with the USB 2.0 standard.

**Related Topic**

[▶ Troubleshooting](#)

---

**How to Use**

---

**Parts Description**

---

**Setup**

---

**Network / Internet**

---

**Connections**

---

**Settings**

---

**Other Operations**

---

**Notifications**

---

## Inserting/Removing SD Memory Cards

Your computer is equipped with an **SD** memory card slot. You can use this slot to transfer data among digital cameras, camcorders, music players, and other audio/video devices.

The **SD** memory card slot on the computer can accommodate the following memory cards:

- SD memory card
- SDHC memory card
- SDXC memory card

### To insert an SD memory card

1. Locate the **SD** memory card slot.
2. Hold the SD memory card with the arrow pointing toward the slot, and carefully slide it into the slot until it clicks into place.

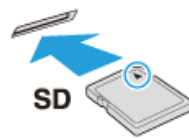

The SD memory card icon will appear in the **Computer** window after you insert the card into the slot.

#### Note

- Be careful not to insert an SD memory card with wrong orientation. If you force it into the slot upside down, the slot may be damaged. Refer to the manual that came with the SD memory card for more information.
- The SD memory card icon will not appear in the **Computer** window until you insert the card into the slot.

#### Hint

- When you insert the SD memory card into the slot for the first time, you may be prompted to install driver software. If prompted, follow the on-screen instructions to install the software.
- While data is being read from or written to the SD memory card, the media access indicator light is on.

### To remove an SD memory card

1. Locate the **SD** memory card slot.
2. Check that the media access indicator light is off.
3. Push in the SD memory card toward your computer and release.
4. Pull the SD memory card out of the slot.

---

#### Related Topic

[Notes on Using SD Memory Cards](#)

---



[▶ Troubleshooting](#)

---

**How to Use**

---

**Parts Description**

---

**Setup**

---

**Network / Internet**

---

**Connections**

---

**Settings**

---

**Other Operations**

---

**Notifications**

---

## Notes on Using SD Memory Cards

Before using SD memory cards, read the following precautions for correct use.

- Keep an SD memory card out of reach of children. There is a risk of swallowing it.
- Do not touch the SD memory card connector with your finger or metal objects.
- An SD memory card contains delicate electronic components. Do not impact, bend or drop it.
- Do not disassemble or modify an SD memory card.
- Do not wet an SD memory card.
- Do not use or store in a location subject to:
  - Extremely high temperature, such as in a car parked in the sun
  - Direct sunlight
  - High humidity or corrosive substances
  - Excessive dust
- Be sure to use SD memory cards and adaptors that are compliant with the standards supported by your computer. Incompatible cards and adaptors may get stuck in the slot, causing damage to the computer.
- You cannot write data to an SD memory card that is write-protected.
- It is recommended that you make a backup copy of important data.
- Stored data may be lost or corrupted if:
  - You remove an SD memory card or turn off your computer while the media access indicator light is on.
  - You use an SD memory card at a place where static electricity or electrical noise may disturb the card.
- When carrying an SD memory card, be sure to put it in its case to avoid static electricity.
- Before using an SD memory card with a device other than a computer, such as a digital camera or a portable audio, format (initialize) the SD memory card using the device. Some devices may not support the file format for computers and show you a message that recommends you to format the SD memory card. In this case, copy data from the card to your computer and format the card using the device. All data in the SD memory card will be deleted when you format it. Refer to the manual that came with the device for more information.
- Do not insert foreign objects into the SD memory card slot.
- The SD memory card slot can be used for reading/writing supported memory cards only, and cannot be used for other purposes.
- SD memory cards (up to 2 GB), SDHC memory cards (up to 32 GB) and SDXC memory cards (up to 64 GB) available as of June 2011 have been tested and found compatible with your computer. However, it is not guaranteed that all SD memory cards, SDHC memory cards or SDXC memory cards will be compatible with the computer.
- Do not attempt to insert a memory card or memory card adaptor of a different type into the memory card slot. An incompatible memory card or memory card adaptor may get stuck in the slot, causing damage to your computer.
- Some types of SD memory cards, for example ones with the UHS (Ultra High Speed data transfer feature), may become extremely hot due to continuous access to the memory cards. In such a case, wait for a while before removing the memory card until it cools down.

---

**Related Topic**

[Inserting/Removing SD Memory Cards](#)

---