

**SONY**<sup>®</sup>

# User Guide

Personal Computer  
VPCZ11 Series



# Contents

Before Use.....	4	Using the Bluetooth Function .....	67
Finding More about Your VAIO Computer .....	5	Using Fingerprint Authentication .....	72
Ergonomic Considerations .....	9	Using the TPM .....	79
Getting Started.....	11	Using Peripheral Devices .....	89
Locating Controls and Ports.....	12	Using the Noise Canceling Headphones.....	90
About the Indicator Lights .....	18	Connecting a Port Replicator.....	97
Connecting a Power Source .....	19	Connecting External Speakers or Headphones .....	105
Using the Battery Pack.....	21	Connecting an External Display .....	106
Shutting Down Your Computer Safely .....	28	Selecting Display Modes .....	113
Using the Power Saving Modes .....	29	Using the Multiple Monitors Function .....	114
Updating Your Computer .....	31	Connecting an External Microphone .....	116
Using Your VAIO Computer.....	32	Connecting a USB Device .....	117
Using the Keyboard.....	33	Customizing Your VAIO Computer.....	119
Using the Touch Pad.....	36	Selecting Performance Modes .....	120
Using Special-function Buttons .....	37	Setting the Password.....	123
Using the Built-in Camera .....	38	Using Intel(R) VT .....	130
Using the Optical Disc Drive .....	39	Using the VAIO Control Center .....	131
Using "Memory Stick" .....	46	Using the VAIO Power Management.....	132
Using Other Modules / Memory Cards.....	53	Upgrading Your VAIO Computer.....	133
Using the Internet.....	61	Adding and Removing Memory .....	134
Using the Network (LAN) .....	62		
Using the Wireless LAN .....	63		

<ul style="list-style-type: none"> <li>Precautions..... 140           <ul style="list-style-type: none"> <li>Safety Information..... 141</li> <li>Care and Maintenance Information..... 144</li> <li>Handling Your Computer..... 145</li> <li>Handling the LCD Screen ..... 147</li> <li>Using the Power Source ..... 148</li> <li>Handling the Built-in Camera ..... 149</li> <li>Handling Discs ..... 150</li> <li>Using the Battery Pack..... 151</li> <li>Handling "Memory Stick"..... 152</li> <li>Handling the Built-in Storage Device ..... 153</li> <li>Using Fingerprint Authentication ..... 154</li> <li>Using the TPM ..... 155</li> </ul> </li> <li>Troubleshooting ..... 157           <ul style="list-style-type: none"> <li>Computer Operations..... 159</li> <li>System Update / Security..... 165</li> <li>Recovery ..... 167</li> <li>Battery Pack..... 169</li> <li>Built-in Camera ..... 172</li> <li>Networking (LAN/Wireless LAN) ..... 174</li> <li>Bluetooth Technology ..... 177</li> <li>Optical Discs ..... 181</li> <li>Display ..... 186</li> <li>Printing..... 190</li> </ul> </li> </ul>	<ul style="list-style-type: none"> <li>Microphone..... 191</li> <li>Speakers ..... 192</li> <li>Touch Pad ..... 194</li> <li>Keyboard ..... 195</li> <li>Floppy Disks ..... 196</li> <li>Audio/Video ..... 197</li> <li>"Memory Stick" ..... 199</li> <li>Peripherals ..... 200</li> <li>Port Replicator..... 201</li> <li>Trademarks ..... 202</li> <li>Notice ..... 204</li> </ul>
--	--

# Before Use

Congratulations on your purchase of this Sony VAIO® computer and welcome to the on-screen **User Guide**. Sony has combined leading-edge technology in audio, video, computing, and communications to provide you with a state-of-the-art computing experience.



External views illustrated in this manual may look slightly different from those of your computer.



## How to find specifications

Some features, options, and supplied items may not be available on your computer.

To find out about the configuration of your computer, visit the Sony online support web site at the following URLs:

- ❑ For customers in USA  
<http://esupport.sony.com/EN/VAIO/>
- ❑ For customers in Canada  
<http://sony.ca/support/>
- ❑ For customers in Spanish-speaking Latin American countries or areas  
<http://esupport.sony.com/ES/VAIO/LA>
- ❑ For customers in Brazil  
<http://esupport.sony.com/PT/VAIO/BR/>

## Finding More about Your VAIO Computer

This section provides support information about your VAIO computer.

### 1. Printed Documentation

- Quick Start Guide** — An overview of components connection, set-up information, etc.
- Safety Information** — Safety guidelines and owner information.

### 2. On-screen Documentation

- Help and Support** — General information and technical assistance for your VAIO computer.

To access **Help and Support**:

- 1 Click **Start**  and **Help and Support**.
- 2 Choose from the following categories to find the answers you need.

<b>Get started with my VAIO</b>	Get help with Internet and wireless setup, security setup, personalizing your VAIO computer, creating recovery discs, and more.
<b>Use my VAIO</b>	Access interactive help in the form of VAIO tutorials, how-to articles, the VAIO technology page, specifications, and system and software information. You can find useful documentation such as below: - <b>VAIO User Guide</b> (This manual) - <b>VAIO Recovery Center User Guide</b> - Information about restoring individual software programs, hardware drivers, and drive partition(s) or your entire built-in storage device to the original factory settings - <b>Software Information</b>
<b>Troubleshoot my VAIO</b>	Maintain and troubleshoot your VAIO computer with VAIO Care, system restore, backup and recovery, and contact Sony support.

- ❑ **Program help files** — May be included with the preinstalled software programs on your computer. You may be able to access the help files from the help menu on a specific program.
- ❑ **SmartWi™ Connection Utility Help** — Information about setting up Bluetooth®, wireless LAN, GPS, and wireless WAN functions.



Some features and options may not be available on your computer.  
See the specifications to find out about the configuration of your computer.

To access this on-screen guide:

- 1 Click **Start, All Programs, and SmartWi Connection Utility.**
- 2 Click **SmartWi Connection Utility Help.**

### 3. Support Web Sites

#### ❑ **Sony online support web site**

The Sony online support web site provides instant access to information on commonly encountered problems. Type a description of the problem and the Knowledge Database searches for the corresponding solutions online.

- ❑ For customers in USA

<http://esupport.sony.com/EN/VAIO/>

- ❑ For customers in Canada

<http://sony.ca/support/>

- ❑ For customers in Spanish-speaking Latin American countries or areas

<http://esupport.sony.com/ES/VAIO/LA>

- ❑ For customers in Brazil

<http://esupport.sony.com/PT/VAIO/BR/>

#### ❑ **Operating system online support web site**

Your computer comes preinstalled with a Microsoft Windows operating system. For operating system support, you can visit Microsoft customer support at <http://support.microsoft.com/directory/>.

## 4. Customer Information Center

If you do not find the information you are looking for at our site, you may call Sony directly. You can find the contact numbers on the Sony online support web site. In order to receive the fastest and most efficient services, have the following information readily available:

**1** Your VAIO computer model

You can find it at the lower right corner of the display on the computer.

**2** Your computer's serial number

You can find it on the bottom, the back panel, or inside the battery compartment of your Sony VAIO computer. The serial number is the last 7 digits of the number below the barcode.

**3** The operating system on your computer

**4** The hardware component or the software program that is causing the problem

**5** A brief description of the problem

## 5. In Store Service & Support (available in USA only)

Make an appointment with a Sony certified technician at a U.S. Sony Style store and get personalized service and support for your VAIO PC. Sony Style Backstage Technicians can assist with the setup of your new VAIO PC, system optimization, data rescue, and any repair service you might need.

Visit the web site at [www.sonystyle.com/backstage](http://www.sonystyle.com/backstage) to find the nearest location.



## Ergonomic Considerations

You will be using your computer as a portable device in a variety of environments. Whenever possible, you should attempt to take account of the following ergonomic considerations for both stationary and portable environments:

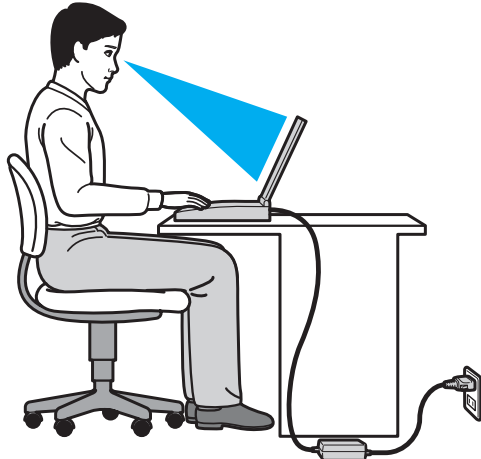

- ❑ **Position of your computer** – Place the computer directly in front of you. Keep your forearms horizontal, with your wrists in a neutral, comfortable position while using the keyboard or the pointing device. Let your upper arms hang naturally at your sides. Take frequent breaks while using your computer. Excessive use of the computer may strain eyes, muscles, or tendons.
- ❑ **Furniture and posture** – Sit in a chair with good back support. Adjust the level of the chair so your feet are flat on the floor. A footrest may make you more comfortable. Sit in a relaxed, upright posture and avoid slouching forward or leaning far backwards.

- ❑ **Viewing angle of the computer display** – Use the display tilting feature to find the best position. You can reduce eye strain and muscle fatigue by adjusting the tilt of the display to the proper position. Adjust the brightness level of the display as well.
- ❑ **Lighting** – Choose a location where windows and lights do not cause glare and reflection on the display. Use indirect lighting to avoid bright spots on the display. Proper lighting adds to your comfort and work efficiency.
- ❑ **Positioning an external display** – When using an external display, set the display at a comfortable viewing distance. Make sure the display screen is at or slightly below eye level when you are sitting in front of the monitor.

# Getting Started

This section describes how to get started with using your VAIO computer.

**!** Before starting your computer for the first time, do not connect any other hardware that did not originally come with your computer. Upon completion, connect one device (for example, a printer, an external hard disk drive, a scanner, and so on) at a time, following the manufacturer's instructions.

- ❑ **Locating Controls and Ports** ([page 12](#))
- ❑ **About the Indicator Lights** ([page 18](#))
- ❑ **Connecting a Power Source** ([page 19](#))
- ❑ **Using the Battery Pack** ([page 21](#))
- ❑ **Shutting Down Your Computer Safely** ([page 28](#))
- ❑ **Using the Power Saving Modes** ([page 29](#))
- ❑ **Updating Your Computer** ([page 31](#))

## Locating Controls and Ports

Take a moment to identify the controls and ports shown on the following pages.

! The appearance of your computer may be different from those illustrated in this manual due to variations in specifications. It may also vary in some countries or areas.

### Front

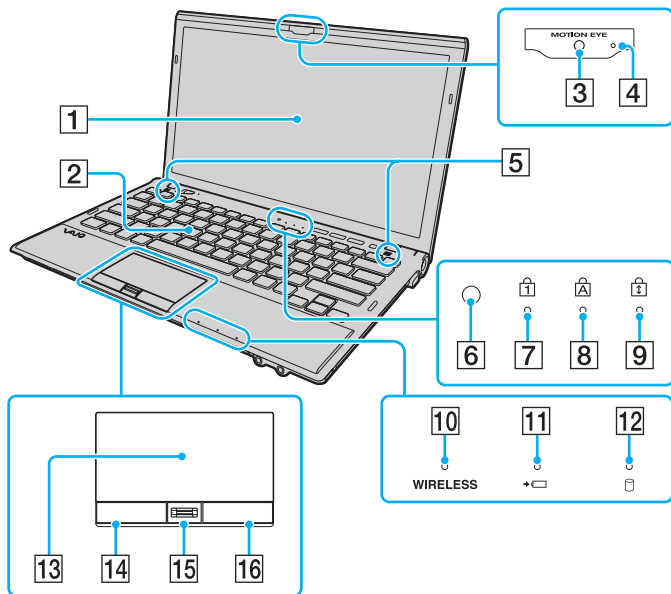

- 1 LCD screen ([page 147](#))
- 2 Keyboard ([page 33](#))
- 3 Built-in **MOTION EYE** camera ([page 38](#))
- 4 Built-in **MOTION EYE** camera indicator ([page 18](#))
- 5 Built-in speakers (stereo)
- 6 Ambient light sensor ([page 35](#)), ([page 188](#))  
Measures ambient light intensity for automatically adjusting the LCD brightness to an optimum level.
- 7 Num lock indicator ([page 18](#))
- 8 Caps lock indicator ([page 18](#))
- 9 Scroll lock indicator ([page 18](#))
- 10 **WIRELESS** indicator ([page 18](#))
- 11 Charge indicator ([page 18](#))
- 12 Disc drive indicator ([page 18](#))
- 13 Touch pad ([page 36](#))
- 14 Left button ([page 36](#))
- 15 Fingerprint sensor ([page 72](#))
- 16 Right button ([page 36](#))

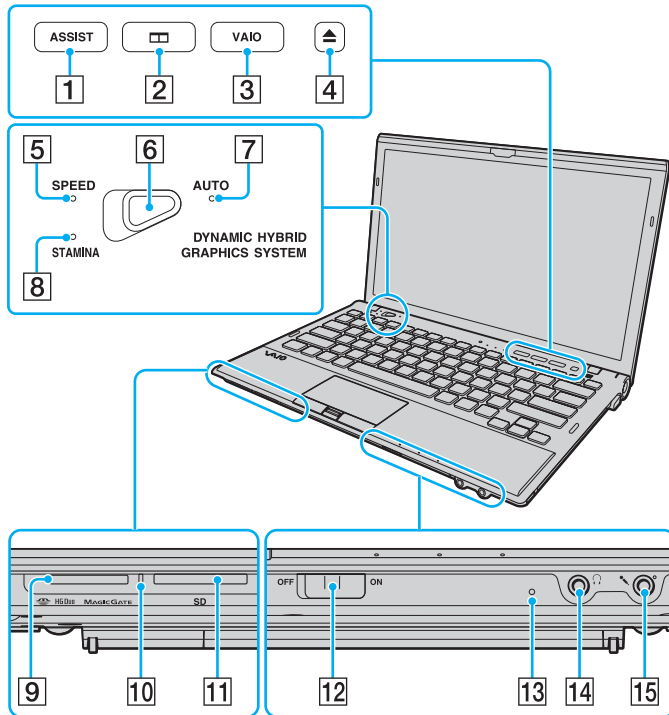

- 1 **ASSIST** button (page 37)
- 2 Window arrangement button (page 37)
- 3 **VAIO** button (page 37)
- 4 Drive eject button (page 37), (page 39)
- 5 **SPEED** mode indicator (page 18), (page 120)
- 6 Performance selector switch (page 120)
- 7 **AUTO** mode indicator (page 18), (page 120)
- 8 **STAMINA** mode indicator (page 18), (page 120)
- 9 "Memory Stick Duo" slot\* (page 46)
- 10 Media Access indicator (page 18)
- 11 **SD** memory card slot (page 57)
- 12 **WIRELESS** switch (page 63), (page 67)
- 13 Built-in microphone (monaural)
- 14 Headphones jack (page 105), (page 90)
- 15 Microphone jack (page 116)

\* Your computer supports only Duo-size "Memory Stick".

## Back

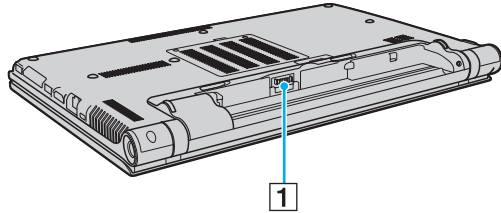

**1** Battery connector ([page 21](#))

## Right

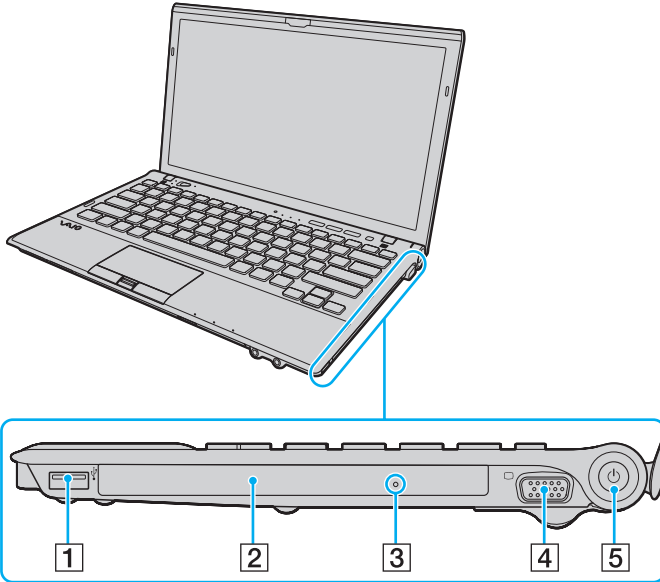

- 1 USB port<sup>\*1</sup> ([page 117](#))
- 2 Optical disc drive ([page 39](#))
- 3 Manual eject hole ([page 181](#))
- 4 Monitor port<sup>\*2</sup> ([page 107](#))
- 5 Power button/Power indicator ([page 18](#))

<sup>\*1</sup> Compliant with the USB 2.0 standard and supports high-/full-/low- speeds.

<sup>\*2</sup> Not accessible when your computer is attached to the port replicator.

## Left

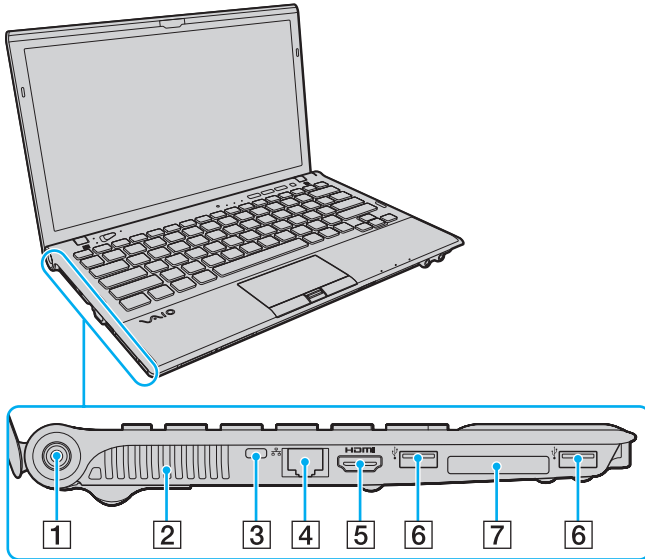

- 1 DC IN port ([page 19](#))
- 2 Air vent
- 3 Security slot
- 4 Network (LAN) port<sup>\*1</sup> ([page 62](#))
- 5 HDMI output port<sup>\*2</sup> ([page 110](#))
- 6 USB ports<sup>\*3</sup> ([page 117](#))
- 7 ExpressCard/34 slot ([page 53](#))

\*1 Not accessible when your computer is attached to the port replicator.

\*2 There may be no sound from an output device connected to the **HDMI** output port for the first few seconds after playback starts. This is not a malfunction.

\*3 Compliant with the USB 2.0 standard and support high-/full-/low- speeds.

**HDMI**™  
HIGH-DEFINITION MULTIMEDIA INTERFACE





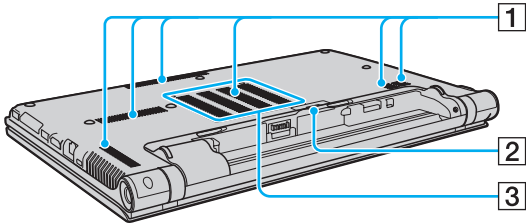



## Bottom



- 1 Air vents
- 2 Port replicator connector cover ([page 98](#))
- 3 Memory module compartment cover ([page 134](#))

## About the Indicator Lights

Your computer is equipped with the following indicator lights:

Indicator	Functions
Power 	Illuminates in green while the computer is on, blinks slowly in orange while the computer is in Sleep mode, and turns off when the computer is turned off or enters Hibernate mode.
Charge 	Illuminates while the battery pack is charging. See <b>Charging the Battery Pack (page 25)</b> for more information.
Built-in <b>MOTION EYE</b> camera	Illuminates while the built-in camera is in use.
Media Access	Illuminates while data access to a memory card, such as "Memory Stick" and an SD memory card, is in progress. (Do not place the computer into Sleep mode or turn it off while this indicator light is lit.) When the indicator light is unlit, the memory card is not in use.
<b>AUTO</b> mode	Illuminates while the computer is in <b>AUTO</b> mode to provide optimum performance.
<b>STAMINA</b> mode	Illuminates while the computer is in <b>STAMINA</b> mode to conserve battery power.
<b>SPEED</b> mode	Illuminates while the computer is in <b>SPEED</b> mode to provide faster performance.
Disc drive 	Illuminates while data access to the built-in storage device or the optical disc drive is in progress. Do not place the computer into Sleep mode or turn it off while this indicator light is lit.
Num lock 	Press the <b>Num Lk</b> key to activate the numeric keypad. Press it a second time to deactivate the numeric keypad. The numeric keypad is not active when the indicator light is unlit.
Caps lock 	Press the <b>Caps Lock</b> key to type letters in uppercase. Letters appear in lowercase if you press the <b>Shift</b> key while the indicator light is lit. Press the key a second time to turn off the indicator light. Normal typing resumes when the Caps lock indicator light is turned off.
Scroll lock 	Press the <b>Fn+Scr Lk</b> keys to change how you scroll the display. Normal scrolling resumes when the Scroll lock indicator light is turned off. The <b>Scr Lk</b> key functions differently depending on the program you are using and does not work with all programs.
<b>WIRELESS</b>	Illuminates while one or more wireless options are enabled.

## Connecting a Power Source

You can use either an AC adapter or a rechargeable battery pack for supplying power to your computer.

### Using the AC Adapter

While your computer is directly connected to an AC power source and has a battery pack installed, it uses power from the AC outlet.



Use only the supplied AC adapter for your computer.

To use the AC adapter

- 1 Plug one end of the power cord (1) into the AC adapter (3).
- 2 Plug the other end of the power cord into an AC outlet (2).
- 3 Plug the cable from the AC adapter (3) into the DC IN port (4) on the computer or on the optional port replicator.

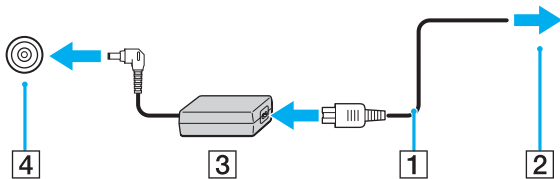

! The shape of the DC In plug varies depending on the AC adapter.



To disconnect your computer completely from an AC power source, unplug the AC adapter from the AC outlet.

Make sure that the AC outlet is easily accessible.

If you do not intend to use your computer for an extended period of time, place the computer into Hibernate mode. See **Using Hibernate Mode (page 30)**.

## Using the Battery Pack

The battery pack is already installed on your computer at the time of delivery but is not fully charged.

**!** Do not use your computer without installing the battery pack as it may cause the computer to malfunction.

### Installing/Removing the Battery Pack

To install the battery pack

- 1 Turn off the computer and close the LCD screen lid.
- 2 Slide the battery **LOCK** switch (1) outward.

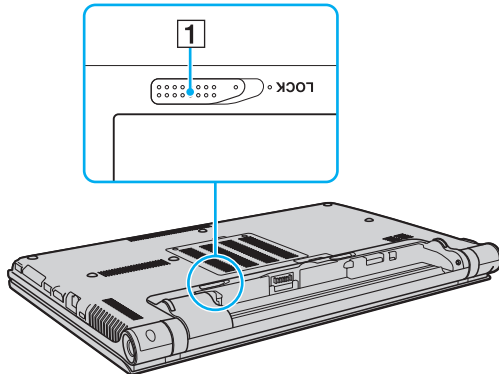

- 3 Slide the battery pack diagonally into the battery compartment until the projection (2) on either side of the battery compartment fits into the U-shaped cut (3) on either side of the battery pack.

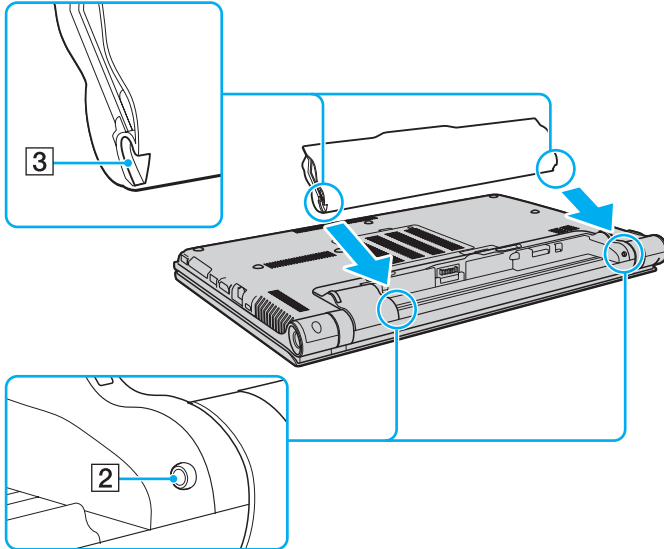

- 4 Push the battery pack down into the compartment until it clicks into place.

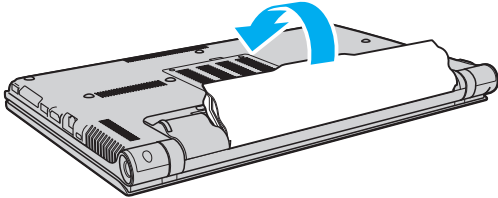

- 5 Slide the battery **LOCK** switch inward to secure the battery pack on the computer.

## To remove the battery pack

! You may lose data if you remove the battery pack while your computer is on and not connected to the AC adapter or if you remove the battery pack while the computer is in Sleep mode.

- 1 Turn off the computer and close the LCD screen lid.
- 2 Slide the battery **LOCK** switch (1) outward.
- 3 Slide and hold the battery **RELEASE** latch (2) outward, put your fingertip underneath the tab (3) on the battery pack, and lift the battery pack in the direction of the arrow, and then slide it away from the computer.

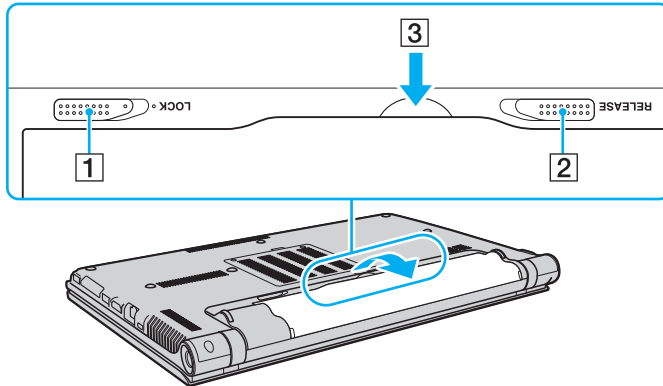

! This computer is designed to operate only with genuine Sony battery packs.



## Charging the Battery Pack

The battery pack supplied with your computer is not fully charged at the time of delivery.

To charge the battery pack

- 1 Install the battery pack.
- 2 Connect the computer to a power source with the AC adapter.  
The charge indicator light is on while the battery pack is charging. When the battery pack charges close to the maximum charge level you selected, the charge indicator turns off.

Charge indicator status	Meaning
Lit in orange	The battery pack is charging.
Blinks along with the green power indicator	The battery pack is running out of power. (Normal mode)
Blinks along with the orange power indicator	The battery pack is running out of power. (Sleep mode)
Blinks fast in orange	A battery error has occurred due to a failed battery pack or an unlocked battery pack.

**!** Charge the battery pack as described in this manual from your first battery charge.



Keep the battery pack in your computer while it is directly connected to an AC power source. The battery pack continues to charge while you are using the computer.

When the battery pack is running out of power and both the charge and power indicator lights blink, you should either connect the AC adapter to recharge the battery pack or shut down your computer and install a fully charged battery pack.

Your computer is supplied with a lithium ion battery pack and can be recharged any time. Charging a partially discharged battery pack does not affect the life of battery.

While some software applications or peripheral devices are in use, your computer may not enter Hibernate mode even when the remaining battery life becomes short. To avoid loss of data while the computer is running on the battery, you should save your data frequently and manually activate a power management mode, such as Sleep or Hibernate.

If the battery pack runs out of power while the computer is in Sleep mode, you will lose all unsaved data. Going back to the previous work state is impossible. To avoid loss of data, you should save your data frequently.

## Checking the Battery Charge Capacity

The battery charge capacity gradually decreases as the number of battery charging increases or the duration of use of the battery pack extends. To get the most out of the battery pack, check the battery charge capacity and change the battery settings.

To check the battery charge capacity

- 1 Click **Start**, **All Programs**, and **VAIO Control Center**.
- 2 Click **Power Management** and **Battery**.



Additionally, you can enable the battery care function to extend the life of the battery pack.

## Extending the Battery Life

When your computer is running on battery power, you can extend the battery life using the following methods.

- Decrease the LCD brightness of your computer screen.
- Use the power saving mode. See **Using the Power Saving Modes (page 29)** for more information.
- Change the power saving settings on the **Power Options**. See **Using the VAIO Power Management (page 132)** for more information.
- Set the wallpaper in **Long Battery Life Wallpaper Setting** as your desktop background with the **VAIO Control Center**.

## Shutting Down Your Computer Safely

To avoid losing unsaved data, be sure to shut down your computer properly, as described below.

To shut down your computer

- 1 Turn off any peripherals connected to the computer.
- 2 Click **Start** and the **Shut down** button.
- 3 Respond to any prompts warning you to save documents or to consider other users and wait for the computer to turn off automatically.  
The power indicator light turns off.

## Using the Power Saving Modes

You can take advantage of the power management settings to conserve battery life. In addition to the normal operating mode, your computer has two distinct power saving modes to suit your preference: Sleep and Hibernate.

! If you do not intend to use your computer for an extended period of time while it is disconnected from an AC power source, place the computer into Hibernate mode or turn it off.

If the battery pack runs out of power while your computer is in Sleep mode, you will lose all unsaved data. Going back to the previous work state is impossible. To avoid loss of data, you should save your data frequently.

Mode	Description
Normal mode	This is the normal state of your computer while it is in use. The green power indicator light is lit while the computer is in this mode.
Sleep mode	Sleep mode turns off the LCD screen and places the built-in storage device(s) and the CPU into a low power consumption mode. The orange power indicator light blinks slowly while your computer is in this mode. Your computer comes out of Sleep mode quicker than out of Hibernate mode. However, Sleep mode uses more power than Hibernate mode.
Hibernate mode	While your computer is in Hibernate mode, the state of the system is saved on the built-in storage device(s) and power is turned off. Even when the battery pack runs out of power, no data will be lost. The power indicator light is unlit while your computer is in this mode.

## Using Sleep Mode

To activate Sleep mode

Click **Start**, the arrow  next to the **Shut down** button, and **Sleep**.

To return to Normal mode

- Press any key.
- Press the power button on your computer.

! If you press and hold the power button for more than four seconds, your computer will turn off automatically. You will lose all unsaved data.

## Using Hibernate Mode

To activate Hibernate mode

Press the **Fn+F12** keys.

Alternatively, you can click **Start**, the arrow next to the **Shut down** button, and **Hibernate**.

! Do not move your computer before its power indicator light turns off.

To return to Normal mode

Press the power button.

! If you press and hold the power button for more than four seconds, your computer will turn off automatically.

## Updating Your Computer

Be sure to update your VAIO computer with the following software applications so that the computer can run more efficiently and securely.

The **VAIO Update** automatically notifies you of new updates for enhancing your computer's performance available on the Internet, and downloads and installs them on the computer.

**Windows Update**

Click **Start, All Programs**, and **Windows Update** and then follow the on-screen instructions.

**VAIO Update 5**

Click **Start, All Programs**, and **VAIO Update 5** and then follow the on-screen instructions.



Your computer must be connected to the Internet to download the updates.

# Using Your VAIO Computer

This section describes how to get the most out of using your VAIO computer.

- ❑ **Using the Keyboard** ([page 33](#))
- ❑ **Using the Touch Pad** ([page 36](#))
- ❑ **Using Special-function Buttons** ([page 37](#))
- ❑ **Using the Built-in Camera** ([page 38](#))
- ❑ **Using the Optical Disc Drive** ([page 39](#))
- ❑ **Using "Memory Stick"** ([page 46](#))
- ❑ **Using Other Modules / Memory Cards** ([page 53](#))
- ❑ **Using the Internet** ([page 61](#))
- ❑ **Using the Network (LAN)** ([page 62](#))
- ❑ **Using the Wireless LAN** ([page 63](#))
- ❑ **Using the Bluetooth Function** ([page 67](#))
- ❑ **Using Fingerprint Authentication** ([page 72](#))
- ❑ **Using the TPM** ([page 79](#))















## Using the Keyboard



Your keyboard has additional keys that perform model-specific tasks.

### Combinations and Functions with the Fn Key



Some keyboard functions can be used only after the operating system is finished launching.

Combination/Feature	Function
<b>Fn +  (F2): muting</b>	Turns on and off the built-in speakers or the headphones.
<b>Fn +  (F3/F4): volume control</b>	Changes the volume level. To increase the volume, press the <b>Fn+F4</b> keys and then the  or  key, or keep pressing the <b>Fn+F4</b> keys. To decrease the volume, press the <b>Fn+F3</b> keys and then the  or  key, or keep pressing the <b>Fn+F3</b> keys.
<b>Fn +  (F5/F6): brightness control</b>	Changes the LCD brightness of your computer screen. To increase lighting intensity, keep pressing the <b>Fn+F6</b> keys or press the <b>Fn+F6</b> keys and then the  or  key. To decrease lighting intensity, keep pressing the <b>Fn+F5</b> keys or press the <b>Fn+F5</b> keys and then the  or  key.
<b>Fn +  /  (F7): display output</b>	Switches the display output between your computer screen, an external display, simultaneous output to both, and multiple displays with both that function as a single desktop. Press the <b>Enter</b> key to select the display output.  <b>!</b> If you disconnect a display cable from your computer while an external display is selected as the display output destination, the computer screen goes blank. In such a case, press the <b>F7</b> key twice while holding down the <b>Fn</b> key, and then press the <b>Enter</b> key to switch the display output to the computer screen.  Multiple displays may not be supported depending on the operating system on your computer.

Combination/Feature	Function
Fn +  /  (F9/F10): zooming	<p>Changes the size of an image or a document displayed on some software.</p> <p>To make the view look smaller and further away (zoom out), press the <b>Fn+F9</b> keys.</p> <p>To make the view look bigger and closer (zoom in), press the <b>Fn+F10</b> keys.</p> <p>See the help file included with the <b>VAIO Control Center</b> for more information.</p>
Fn +  (F12): hibernation	<p>Provides the lowest level of power consumption. When you execute this command, the states of the system and the connected peripheral devices are saved to the built-in storage device and the system power is turned off. To return the system to its original state, use the power button to turn on the power.</p> <p>For details on power management, see <b>Using the Power Saving Modes</b> (<a href="#">page 29</a>).</p>

## Changing the Backlit Keyboard Settings



Some features and options may not be available on your computer.

If your computer is equipped with a backlit keyboard, you can set the keyboard light to automatically turn on and off according to ambient light intensity.

Additionally, you can set a time period to turn off the keyboard backlight after inactivity of keyboard operations.

To change the backlit keyboard settings

- 1 Click **Start**, **All Programs**, and **VAIO Control Center**.
- 2 Click **Keyboard and Mouse** and **Backlit KB**.



Ambient light intensity is measured by the ambient light sensor. Blocking the ambient light sensor may turn on the keyboard backlight.

## Using the Touch Pad

You can point to, select, drag, and scroll objects on the screen using the touch pad.

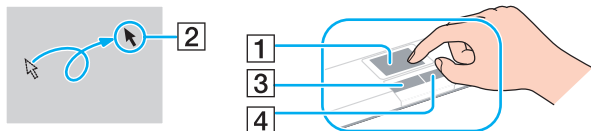

Action	Description
Point	Slide your finger on the touch pad (1) to place the pointer (2) on an item or object.
Click	Press the left button (3) once.
Double-click	Press the left button twice in a row.
Right-click	Press the right button (4) once. With many applications, this action displays a context-sensitive shortcut menu (if any).
Drag	Slide your finger on the touch pad while pressing the left button.
Scroll	Slide your finger along the right edge of the touch pad to scroll vertically. Slide your finger along the bottom edge to scroll horizontally. Once vertical or horizontal scrolling is engaged, you can move your finger in circles on the touch pad to keep scrolling without taking the finger off the touch pad (the scroll function is available only with applications that support a touch pad scroll feature).
Flick	Slide two fingers linearly in quick motion on the touch pad. On web browser software or image viewer software, you can flick left to move backward and flick right to move forward.
Pinch	With some software applications, you can pinch on the touch pad with two fingers for zooming. Pinch open to zoom in or pinch close to zoom out.







You can disable/enable the touch pad while a mouse is connected to your computer. To change the touch pad settings, use the **VAIO Control Center**.



Be sure to connect a mouse before disabling the touch pad. If you disable the touch pad before connecting a mouse, you will be able to use only the keyboard for pointer operations.

## Using Special-function Buttons

Your computer is equipped with special buttons to help you use specific functions of the computer.

Special-function button	Functions
<b>ASSIST</b> button 	Launches the <b>VAIO Care</b> while the computer is in Normal mode or Sleep mode. While the computer is off or in Hibernate mode, the <b>ASSIST</b> button launches the <b>VAIO Recovery Center</b> .
Window arrangement button 	By default, the window arrangement button shows all open windows by resizing the windows so that they all fit on the desktop. To resume the previous window state, press this button once again. You can change the default assignment with the <b>VAIO Control Center</b> .
<b>VAIO</b> button 	Launches the <b>Media Gallery</b> or turns the volume on and off, depending on your model.
Drive eject button 	Ejects the optical disc drive tray.

## Using the Built-in Camera

Your computer is equipped with a built-in **MOTION EYE** camera.

With the preinstalled image capture software, you can perform the following:

- ❑ Capture still images and movies
- ❑ Sense and capture object movements for monitoring purposes
- ❑ Edit captured data



Turning on the computer activates the built-in camera.

Video conferences are possible with the appropriate software.



Launching or exiting your instant messaging or video editing software does not activate or deactivate the built-in camera.

Do not place your computer into Sleep or Hibernate mode while you are using the built-in camera.

### To use the preinstalled image capture software

- 1 Click **Start**, **All Programs**, **ArcSoft WebCam Companion 3**, and **WebCam Companion 3**.
- 2 Click your desired icon in the main window.  
For detailed information on how to use the software, see the help file included with the software.



When capturing an image or a movie in a dark place, click the **Capture** icon in the main window, and then click the **WebCam Settings** icon and select the low light or low light compensation option in the properties window.

## Using the Optical Disc Drive

Your computer is equipped with a built-in optical disc drive.



Some features and options in this section may not be available on your computer.  
See the specifications to find out about the configuration of your computer.

### To insert a disc

- 1 Turn on the computer.
- 2 Press the drive eject button (1) to open the drive.  
The drive tray slides out.
- 3 Place a disc in the middle of the drive tray with the label side facing upward and gently push it down until the disc clicks into place.

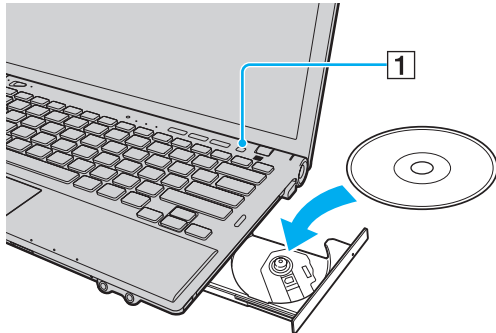

**!** Do not exert pressure on the drive tray. Be sure to hold the bottom of the drive tray when placing/removing a disc onto/from the tray.

- 4 Close the drive tray by pushing it in gently.

! Do not remove the optical disc while your computer is in a power saving mode (Sleep or Hibernate). Be sure to bring the computer back into Normal mode before removing the disc.



## Supported Disc Media

Your computer plays and records CDs, DVDs, and Blu-ray Disc™ media, depending on the model you purchased. See the reference chart below to find out which type of optical disc drive supports which types of media.

PR: playable and recordable  
P: playable but not recordable  
–: not playable or recordable

	CD-ROM	Video CD	Music CD	CD Extra	CD-R/RW	DVD-ROM	DVD-Video	DVD-R/RW	DVD+R/RW	DVD+R DL (Double Layer)	DVD-R DL (Dual Layer)	DVD-RAM <sup>*1 *2</sup>	BD-ROM	BD-R/RE <sup>*3</sup>
DVD±RW/±R DL/RAM	P	P	P	P	PR <sup>*5</sup>	P	P	PR	PR	PR	PR	PR	–	–
Blu-ray Disc	P	P	P	P	PR <sup>*5</sup>	P	P	PR	PR	PR	PR	PR	P	PR <sup>*4</sup>
Blu-ray Disc Combo	P	P	P	P	PR <sup>*5</sup>	P	P	PR	PR	PR	PR	PR	P	P

<sup>\*1</sup> The DVD±RW/RAM disc drive on your computer does not support the DVD-RAM cartridge. Use non-cartridge discs or discs with a removable cartridge.

<sup>\*2</sup> Writing data to single-sided DVD-RAM discs (2.6 GB) compliant with DVD-RAM Version 1.0 is not supported. DVD-RAM Version 2.2/12X-SPEED DVD-RAM Revision 5.0 disc is not supported.

<sup>\*3</sup> The Blu-ray Disc drive on your computer does not support BD-RE Disc media in Version 1.0 format and Blu-ray Disc media with a cartridge.

<sup>\*4</sup> Supports writing data to BD-R Part1 Version 1.1/1.2/1.3 discs (single-layer discs with the capacity of 25 GB, dual-layer discs with the capacity of 50 GB) and BD-RE Part1 Version 2.1 discs (single-layer discs with the capacity of 25 GB, dual-layer discs with the capacity of 50 GB).

<sup>\*5</sup> Writing data to Ultra Speed CD-RW discs is not supported.

! This unit is designed to playback discs that conform to the Compact Disc (CD) standard. DualDiscs and some music discs encoded with copyright protection technologies do not conform to the Compact Disc (CD) standard. Therefore, these discs may not be compatible with this unit.

When you buy pre-recorded or blank discs for use with your VAIO computer, be sure to read the notices on the disc package carefully to check both playback and recording compatibility with your computer's optical disc drives. Sony does NOT guarantee the compatibility of VAIO optical disc drives with discs that are not compliant with the official "CD," "DVD," or "Blu-ray Disc" standard. USING NON-COMPLIANT DISCS CAN CAUSE FATAL DAMAGE TO YOUR VAIO PC OR CREATE SOFTWARE CONFLICTS AND CAUSE SYSTEM HANGING.

For inquiries about disc formats, contact the individual publisher of the pre-recorded disc or the manufacturer of the recordable disc.



8 cm disc writing is not supported.

! To play copyright protected Blu-ray Disc media continually, update the AACS key. The AACS key update requires Internet access.

As with other optical media devices, circumstances may limit compatibility or prevent Blu-ray Disc media playback. VAIO computers may not support movie playback on packaged media recorded in AVC or VC1 formats at high bit rates.

Region settings are required for some contents of DVD and BD-ROM Disc media. If the region setting on the optical disc drive does not match the region coding on the disc, playback is not possible.

Unless your external display is compliant with the High-bandwidth Digital Content Protection (HDCP) standard, you cannot play or view the contents of copyright protected Blu-ray Disc media.

Some content may restrict video output to standard definition or prohibit analog video output. When you output video signals through digital connections, such as an HDMI connection or a DVI connection, it is strongly recommended that a digital HDCP compliant environment be implemented for optimum compatibility and viewing quality.

Exit all memory-resident utility software before playing or writing a disc as it may cause the computer to malfunction.

## Notes on Using the Optical Disc Drive

### Notes on writing data to a disc

- ❑ Only use circular discs. Do not use discs in any other shape (star, heart, card, etc.), as this may damage the optical disc drive.
- ❑ Do not strike or shake your computer while the optical disc drive is writing data to a disc.
- ❑ Do not plug or unplug the power cord or the AC adapter while the optical disc drive is writing data to a disc.
- ❑ Do not attach or disconnect your computer to or from the port replicator (optional) while the optical disc drive is writing data to a disc.

### Notes on playing discs

To achieve optimum performance of disc playback, you should follow these recommendations:

- ❑ Some CD players and computer optical disc drives may not be able to play audio CDs created with the CD-R or CD-RW media.
- ❑ Some DVD players and computer optical disc drives may not be able to play DVDs created with the DVD+R DL, DVD-R DL, DVD+R, DVD+RW, DVD-R, DVD-RW, or DVD-RAM media.
- ❑ You may not be able to play some Blu-ray Disc content on your computer, or the computer may become unstable during Blu-ray Disc playback. To play content normally, download and install the latest updates for the **WinDVD BD** using the **VAIO Update**.  
For information on how to use the **VAIO Update**, see **Updating Your Computer (page 31)**.
- ❑ Video playback may be interrupted, depending on the type or bit rate of the video.
- ❑ Depending on system environment, you may find sound interruptions and/or dropped frames during AVC HD playback.
- ❑ Do not place your computer into either of the power saving modes while your computer is playing a disc.

## Notes on region codes

Region code indicators are labeled on the discs or packages to indicate in which region and on what type of player you can play the disc. If the region code indicates "all," you can play this disc in most regions of the world. If the region code for your residence area is different from the label, you cannot play the disc on your computer.

## Playing Discs

To play a disc

- 1 Insert a disc into the optical disc drive.



Connect the AC adapter to the computer and close all running software applications before playing a disc.

- 2 If nothing appears on the desktop, click **Start, All Programs**, and your desired software to play the disc.  
For instructions on how to use the software, see the help file included with the software.

## Copying Files to Discs

To copy files to a disc

- 1 Insert a recordable disc into the optical disc drive.



Connect the AC adapter to the computer and close all running software applications before copying files to a disc.

- 2 If nothing appears on the desktop, click **Start, All Programs**, and your desired disc burning software to copy files to the disc.  
For instructions on how to use the software, see the help file included with the software.

## Using "Memory Stick"

"Memory Stick" is a compact, portable, and versatile IC recording media especially designed for exchanging and sharing digital data with compatible products, such as digital cameras, mobile phones, and other devices. Because it is removable, it can be used for external data storage.

### Before You Use "Memory Stick"

The "Memory Stick Duo" slot on your computer can accommodate the following sizes and types of media:

- "Memory Stick Duo"
- "Memory Stick PRO Duo"
- "Memory Stick PRO-HG Duo"

!

Your computer supports only Duo-size "Memory stick", and does not support standard-size "Memory Stick".

For the latest information about "Memory Stick", visit [memorystick.com] at <http://www.memorystick.com/en/>.

## Inserting and Removing "Memory Stick"

To insert "Memory Stick"

- 1 Locate the "Memory Stick Duo" slot.
- 2 Hold "Memory Stick" with the arrow facing upward and pointing toward the slot.
- 3 Carefully slide "Memory Stick" into the slot until it clicks into place.  
Do not force the media into the slot.



If "Memory Stick" does not go into the slot easily, remove it gently and verify you are inserting it in the proper direction.

"Memory Stick" is automatically detected by your system and the contents of "Memory Stick" are displayed. If nothing appears on the desktop, click **Start**, **Computer**, and double-click the "Memory Stick" icon.

The "Memory Stick" icon will appear in the **Computer** window after you insert "Memory Stick" into the slot.

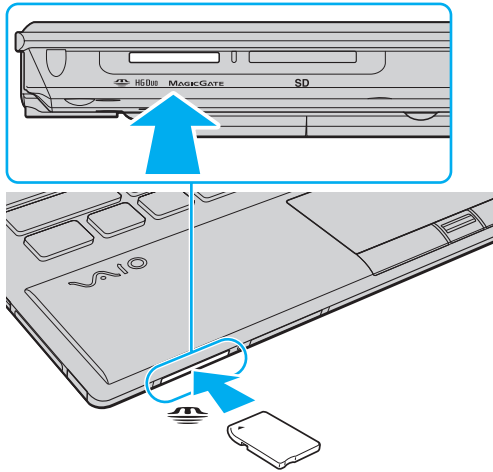

**!** Before using "Memory Stick Micro" ("M2"), be sure to insert it into an "M2" Duo adaptor. If you insert the media directly into the "Memory Stick Duo" slot without the adaptor, you may not be able to remove it from the slot.



## To remove "Memory Stick"

**!** Do not remove "Memory Stick" while the Media Access indicator light is lit. If you do, you may lose data. Large volumes of data may take time to load, so make sure the indicator light is unlit before removing "Memory Stick".

- 1** Locate the "Memory Stick Duo" slot.
- 2** Check that the Media Access indicator light is unlit.
- 3** Push in "Memory Stick" toward the computer and release.  
"Memory Stick" ejects.
- 4** Pull "Memory Stick" out of the slot.

**!** Be sure to remove "Memory Stick" gently, or it may pop out unexpectedly.

## Formatting "Memory Stick"

To format "Memory Stick"

"Memory Stick" is formatted by default and is ready for use.

If you want to reformat the media with your computer, follow these steps.

! Be sure to use the device that is designed to format the media and supports "Memory Stick" when formatting the media.

Formatting "Memory Stick" erases the entire data stored on the media. Before formatting the media, make sure that it does not contain your valuable data.

Do not remove "Memory Stick" from the slot while formatting. This could cause a malfunction.

- 1 Locate the "Memory Stick Duo" slot.
- 2 Carefully slide "Memory Stick" into the slot until it clicks into place.
- 3 Click **Start** and **Computer**.
- 4 Right-click the "Memory Stick" icon and select **Format**.
- 5 Click **Restore device defaults**.

! The size of the allocation unit and file system may change.

Do not select **NTFS** from the **File system** drop-down list as it may cause a malfunction.



The formatting process will be completed more quickly if you select **Quick Format** in **Format options**.

- 6 Click **Start**.
- 7 Follow the on-screen instructions.

! It may take time to format "Memory Stick" depending on the media type.

## Notes on Using "Memory Stick"

- ❑ Your computer has been tested and found compatible with Sony branded "Memory Stick" with capacity of up to 32 GB that are available as of September 2009. However, not all "Memory Stick" are guaranteed of compatibility.
- ❑ Be sure to hold "Memory Stick" with the arrow pointing in the correct direction as you insert it into the slot. To avoid damaging your computer or the media, do not force "Memory Stick" into the slot if you cannot insert it smoothly.
- ❑ Use care when inserting or removing "Memory Stick" from the slot. Do not force it in or out of the slot.
- ❑ Inserting "Memory Stick" with multiple conversion adaptors is not guaranteed of compatibility.
- ❑ "MagicGate" is the general name of the copyright protection technology developed by Sony. Use "Memory Stick" with the "MagicGate" logo to take advantage of this technology.
- ❑ Except for your personal use, it is against the copyright law to use any audio and/or image data you recorded without prior consent from the respective copyright holders. Accordingly, "Memory Stick" with such copyrighted data can be used only within the law.
- ❑ Do not insert more than one "Memory Stick" into the slot. Improper insertion of the media may damage both your computer and the media.

## Using Other Modules / Memory Cards

### Using the ExpressCard Module

Your computer is equipped with an ExpressCard/34 slot\* for transferring data among digital cameras, camcorders, music players, and other audio/video devices. This slot can only accommodate an ExpressCard/34 (34 mm wide) module\*.

\* Referred to as the ExpressCard slot and the ExpressCard module in this manual.

## To insert an ExpressCard module

**!** Your computer is supplied with a slot protector in the ExpressCard slot. Remove the slot protector before you use the slot.

- 1 Locate the ExpressCard slot.
- 2 Push the ExpressCard slot protector so that the protector pops out.
- 3 Gently take hold of the ExpressCard slot protector and pull it out of the slot.
- 4 Hold the ExpressCard module with the arrow facing upward and pointing toward the slot.
- 5 Carefully slide the ExpressCard module into the slot until it clicks into place.  
Do not force it into the slot.

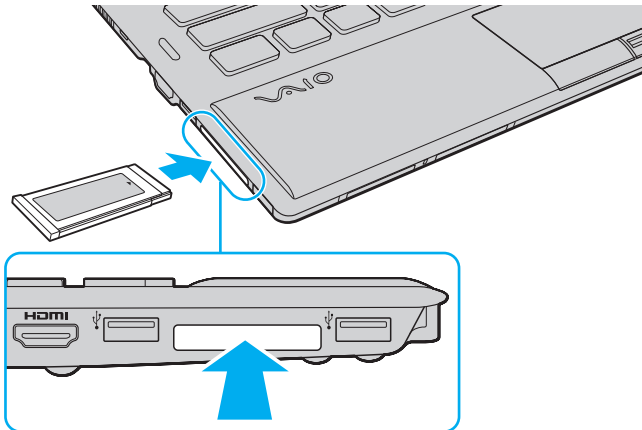



If the module does not go into the slot easily, remove it gently and verify you are inserting it in the proper direction.

Make sure you use the most recent driver software provided by the ExpressCard module manufacturer.

## To remove an ExpressCard module

! Insert the ExpressCard slot protector to block any particles from entering the slot when not using an ExpressCard module. Before moving your computer, be sure to insert the ExpressCard slot protector into the slot.



You can skip steps 1 to 4 when:

- your computer is off.
- the **Safely Remove Hardware and Eject Media** icon is not displayed on the taskbar.
- the hardware you want to unplug is not displayed in the **Safely Remove Hardware and Eject Media** window.

- 1 Locate the ExpressCard slot.
- 2 Click the **Safely Remove Hardware and Eject Media** icon on the taskbar.
- 3 Select the hardware you want to unplug.
- 4 Follow the on-screen instructions for removing the ExpressCard module.
- 5 Push in the ExpressCard module toward the computer so that the module pops out.
- 6 Gently take hold of the ExpressCard module and pull it out of the slot.



## Using the SD Memory Card

Your computer is equipped with an **SD** memory card slot. You can use this slot to transfer data among digital cameras, camcorders, music players, and other audio/video devices.

### Before you use the SD memory card

The **SD** memory card slot on your computer can accommodate the following memory cards:

- SD memory card
- SDHC memory card

For the latest information on compatible memory cards, see **Finding More about Your VAIO Computer (page 5)** to visit the appropriate support web site.

## To insert an SD memory card

- 1 Locate the **SD** memory card slot.
- 2 Hold the SD memory card with the arrow facing upward and pointing toward the slot.
- 3 Carefully slide the SD memory card into the slot until it clicks into place.  
Do not force the card into the slot.

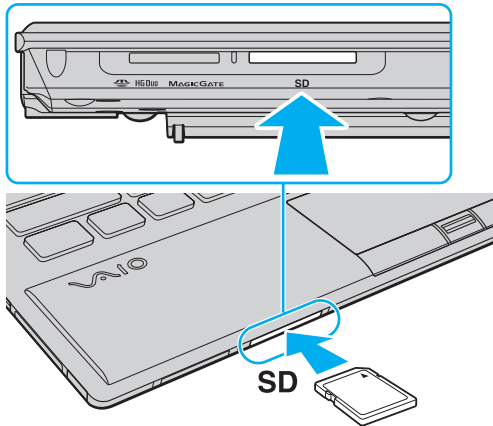

The SD memory card icon will appear in the **Computer** window after you insert the card into the slot.

## To remove an SD memory card

- 1 Locate the **SD** memory card slot.
- 2 Check that the Media Access indicator light is unlit.
- 3 Push in the SD memory card toward the computer and release.  
The SD memory card ejects.
- 4 Pull the SD memory card out of the slot.

## Notes on Using Memory Cards

### General notes on using the memory card

- ❑ Be sure to use memory cards that are compliant with the standards supported by your computer.
- ❑ Be sure to hold the memory card with the arrow pointing in the correct direction as you insert it into the slot. To avoid damaging your computer or the media, do not force the memory card into the slot if you cannot insert it smoothly.
- ❑ Use care when inserting or removing the memory card from the slot. Do not force it in or out of the slot.
- ❑ Do not remove the memory card while the media access indicator light is lit. If you do, you may lose data.
- ❑ Do not attempt to insert a memory card or memory card adaptor of a different type into the memory card slot. An incompatible memory card or memory card adaptor may cause difficulty in removing from the slot and can cause damage to your computer.

### Notes on using the SD memory card

- ❑ Your computer has been tested and found compatible only with major memory cards available as of September 2009. However, not all memory cards are guaranteed of compatibility.
- ❑ SD memory cards with capacity of up to 2 GB and SDHC memory cards with capacity of up to 32 GB have been tested and found compatible with your computer.

## Using the Internet

Before using the Internet, you need to sign up with an Internet Service Provider (ISP) and set up devices required for connecting your computer to the Internet.

The following types of Internet connection services may be available from your ISP:

- Fiber to the Home (FTTH)
- Digital Subscriber Line (DSL)
- Cable modem
- Satellite
- Dial-up

For detailed information on devices required for Internet access and how to connect your computer to the Internet, ask your ISP.



To connect your computer to the Internet using the wireless LAN function, you need to set up the wireless LAN network. See **Using the Wireless LAN (page 63)** for more information.



When you connect your computer to the Internet, be sure to take appropriate security measures to protect the computer against online threats.

Depending on the service contract with your ISP, you may need to connect an external modem device, for example a USB telephone modem, a DSL modem, or a cable modem, to your computer to connect to the Internet. For detailed instructions on connection setups and modem configuration, see the manual that came with your modem.

## Using the Network (LAN)

You can connect your computer to 1000BASE-T/100BASE-TX/10BASE-T type networks with a LAN cable. Connect one end of a LAN cable (not supplied) to the network (LAN) port on the computer or the optional port replicator and the other end to your network. For detailed settings and devices required for LAN access, ask your network administrator.

! The network (LAN) port on your computer is not accessible when the computer is attached to the optional port replicator.

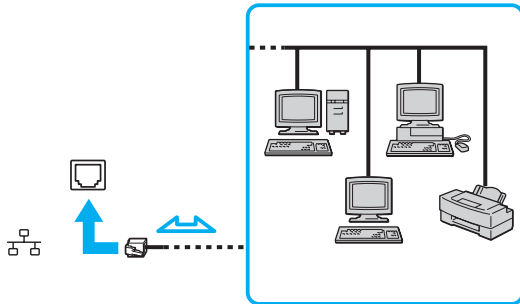

 You can connect your computer to any network without changing the default settings.

! Do not plug a telephone cable into the network (LAN) port on your computer. If the network (LAN) port is connected to one of the telephone lines mentioned below, high electric current to the port may cause damage, overheating, or fire.

- Home (intercom speakerphone) or business-use telephone lines (multi-line business telephone)
- Public telephone subscriber line
- Private branch exchange (PBX)

## Using the Wireless LAN

The Wireless LAN (WLAN) allows your computer to connect to a network through a wireless connection.



The WLAN uses the following IEEE 802.11a/b/g/n standard, which specifies the type of technology used. See the specifications to find out about the configuration of your computer.

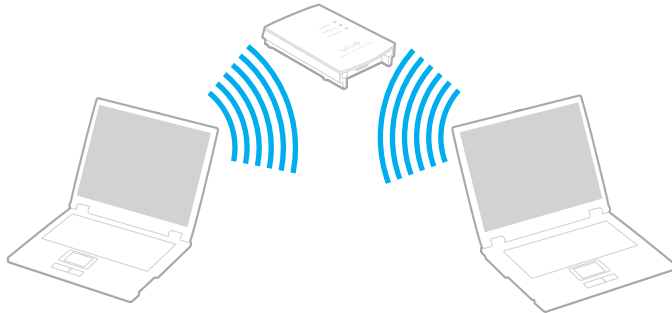

WLAN standard	Frequency band	Remarks
IEEE 802.11a	5 GHz	-
IEEE 802.11b/g	2.4 GHz	The IEEE 802.11g standard provides higher-speed communications than the IEEE 802.11b standard.
IEEE 802.11n	5 GHz/2.4 GHz	On models compliant with the IEEE 802.11b/g/n standard, only the 2.4 GHz band can be used.

## Notes on Using the Wireless LAN Function

### General notes on using the wireless LAN function

- ❑ In some countries, using WLAN products may be restricted by the local regulations (e.g. limited number of channels). Before activating the WLAN function, read the **Safety Information** carefully.
- ❑ The IEEE 802.11a standard and the IEEE 802.11n standard are not available on ad-hoc networks.
- ❑ The 2.4 GHz band used by wireless LAN compatible devices is also used by other various devices. Although technologies to minimize interference from other devices that use the same band are employed on wireless LAN compatible devices, such interference may cause lower communication speed, narrower communication range, or broken wireless connections.
- ❑ The communication speed and range may vary depending on the following conditions:
  - ❑ Distance between communication devices
  - ❑ Existence of obstacles between devices
  - ❑ Device configuration
  - ❑ Radio conditions
  - ❑ Ambient environment that includes existence of walls and materials of such walls
  - ❑ Software in use
- ❑ Communications may be cut off depending on radio conditions.
- ❑ Actual communication speed may not be as fast as the one displayed on your computer.
- ❑ Deploying WLAN products compliant with different standards that use the same band on the same wireless network may reduce the communication speed due to radio interference. Taking this into consideration, WLAN products are designed to reduce the communication speed to ensure communications with another WLAN product if it is compliant with a different standard that uses the same band. When the communication speed is not as fast as expected, changing the wireless channel on the access point may increase the communication speed.



## Note on the data encryption

The WLAN standard includes the encryption methods: Wired Equivalent Privacy (WEP), which is a security protocol, Wi-Fi Protected Access 2 (WPA2), and Wi-Fi Protected Access (WPA). Proposed jointly by the IEEE and Wi-Fi Alliance, both WPA2 and WPA are specifications of standards based on interoperable security enhancements that increase the level of data protection and access control for existing Wi-Fi networks. WPA is designed to be forward compatible with the IEEE 802.11i specification. It utilizes the enhanced data encryption Temporal Key Integrity Protocol (TKIP) in addition to user authentication using 802.1X and Extensible Authentication Protocol (EAP). Data encryption protects the vulnerable wireless link between clients and access points. Besides that, there are other typical LAN security mechanisms to ensure privacy, such as: password protection, end-to-end encryption, virtual private networks, and authentication. WPA2, the second generation of WPA, provides stronger data protection and network access control and is also designed to secure all versions of 802.11 devices, including 802.11b, 802.11a, 802.11g, and 802.11n standards, multi-band and multi-mode. In addition, based on the ratified IEEE 802.11i standard, WPA2 provides government grade security by implementing the National Institute of Standards and Technology (NIST) FIPS 140-2 compliant AES encryption algorithm and 802.1X-based authentication. WPA2 is backward compatible with WPA.

## Using the Wireless LAN Function

! Be sure to turn on the **WIRELESS** switch before starting the wireless LAN function.

To use the wireless LAN function, you first need to set up the wireless LAN function.

Use the **SmartWi Connection Utility** to set up the wireless LAN function. See the **SmartWi Connection Utility Help** for more information.

To access this on-screen guide:

- 1 Click **Start, All Programs**, and **SmartWi Connection Utility**.
- 2 Click **SmartWi Connection Utility Help**.

## Using the Bluetooth Function

You can establish wireless communications between your computer and other Bluetooth devices such as another computer or a mobile phone. You can transfer data between these devices without cables at a range of up to 33 feet / 10 meters in an open area.

To use the Bluetooth function



Be sure to turn on the **WIRELESS** switch before starting the Bluetooth function.

To use the Bluetooth function, you first need to set up the Bluetooth function.

Use the **SmartWi Connection Utility** to set up the Bluetooth function. See the **SmartWi Connection Utility Help** for more information.

To access this on-screen guide:

- 1 Click **Start, All Programs**, and **SmartWi Connection Utility**.
- 2 Click **SmartWi Connection Utility Help**.

## Bluetooth Security

The Bluetooth wireless technology has an authentication function, which allows you to determine with whom you choose to communicate. With the authentication function, you can prevent any anonymous Bluetooth devices from accessing your computer.

The first time two Bluetooth devices communicate, a common passkey (a password required for authentication) should be determined for both devices to be registered. Once a device is registered, there is no need to re-enter the passkey.



The passkey can be different each time, but must be the same at both ends.

For certain devices, such as a mouse, no passkey can be entered.

## Communicating with Another Bluetooth Device

You can connect your computer to a Bluetooth device such as another computer, a mobile phone, a PDA, a headset, a mouse, or a digital camera without the use of any cables.

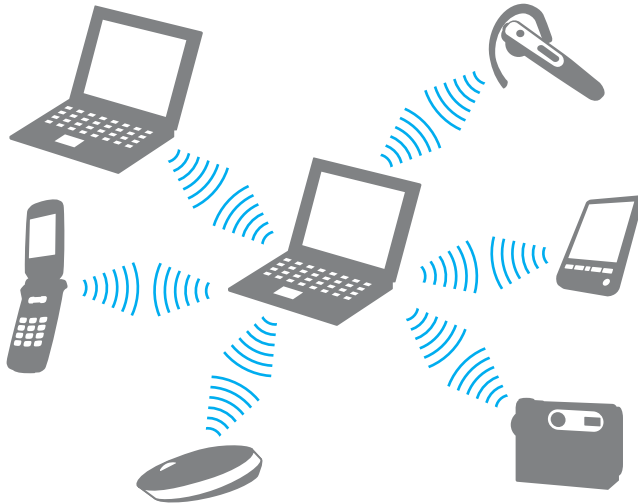

To communicate with another Bluetooth device

To communicate with another Bluetooth device, you first need to set up the Bluetooth function. For setting up and using the Bluetooth function, search **Windows Help and Support** for Bluetooth information.

! Be sure to turn on the **WIRELESS** switch before starting the Bluetooth function.

## Notes on Using the Bluetooth Function

- ❑ The data transfer rate varies, depending on the following conditions:
  - ❑ Obstacles, such as walls, located between devices
  - ❑ Distance between devices
  - ❑ Material used in walls
  - ❑ Proximity to microwaves and cordless telephones
  - ❑ Radio frequency interference and other environmental conditions
  - ❑ Device configuration
  - ❑ Type of software application
  - ❑ Type of operating system
  - ❑ Use of both wireless LAN and Bluetooth functions at the same time on your computer
  - ❑ Size of file being exchanged
- ❑ Large files may occasionally be corrupted during continuous transfer due to limitations of the Bluetooth standard and electromagnetic interference in the environment.
- ❑ All Bluetooth devices must be certified to make sure that the applicable standard requirements are maintained. Even if standards are met, individual device performance, specifications, and operation procedures can vary. Data exchange may not be possible in all situations.
- ❑ Video and audio may not be synchronized if you play videos on your computer with audio output from a connected Bluetooth device. This is a frequent occurrence with Bluetooth technology and is not a malfunction.
- ❑ The 2.4 GHz band, with which Bluetooth devices or wireless LAN devices work, is used by various devices. Bluetooth devices use the technology to minimize the interference from other devices that use the same wave length. Simultaneous use of the Bluetooth function and wireless communication devices, however, may cause radio interference and result in reduced communication speeds and distances than the standard values.

- ❑ The Bluetooth function may not work with other devices, depending on the manufacturer or the software version employed by the manufacturer.
- ❑ Connecting multiple Bluetooth devices to your computer may cause channel congestion, resulting in poor performance of the devices. This is normal with Bluetooth technology and is not a malfunction.

## Using Fingerprint Authentication

Your computer is equipped with a fingerprint sensor to provide you with additional convenience.

Once you have registered your fingerprint(s), the fingerprint authentication function offers:

- ❑ A substitute for password entry
  - ❑ Logging onto Windows ([page 77](#))  
If you have registered your fingerprints for your user account, you can substitute fingerprint authentication for password entry when logging onto Windows.
  - ❑ **Power-on Security** feature ([page 77](#))  
If you have set the power-on password ([page 124](#)), you can substitute fingerprint authentication for password entry when starting your computer.
- ❑ **Password Bank** for quick web site access  
Once you have registered your user information (user accounts, passwords, etc.) for web sites in the **Password Bank**, you can substitute fingerprint authentication for entering information required to access the password-protected web sites. For detailed information, see the help file included with the **Protector Suite**.



You may not be able to use the **Password Bank** feature depending on the web site you access.

- ❑ Archive encryption
  - ❑ **File Safe** feature to encrypt/decrypt data  
With the **File Safe** feature, you can create an encrypted archive to include a file and/or folder for protection against unauthorized access. The encrypted archive can be decrypted or unlocked for included file/folder access by swiping your finger across the fingerprint sensor or entering the backup password you specified for encryption.
  - ❑ **Personal Safe** feature  
With the **Personal Safe** feature, you can encrypt contents of any protected folder on the desktop or the built-in storage device. The encrypted folder will be hidden from other users sharing your computer.



- ❑ **Application launcher function for quick application access**  
The application launcher feature is available on your computer for launching your preferred application (executable file) that is assigned to one of your fingers with a registered fingerprint. Once you have assigned an application to your finger, you can launch the assigned application simply by swiping the finger across the fingerprint sensor.
- ❑ **Strong Password Generator function**  
The **Strong Password Generator** function allows you to enhance computer security by generating a strong password resistant to dictionary attacks. The generated password can be registered in the **Password Bank**.

## Registering a Fingerprint

To use the fingerprint authentication function, you must register your fingerprint(s) in your computer.



Set the Windows password on your computer before registration. See **Setting the Windows Password (page 128)** for the detailed instructions.

To register a fingerprint

- 1 Click **Start, All Programs, Protector Suite, and Control Center.**
- 2 Read an end user license agreement thoroughly and click **Accept.**
- 3 Follow the on-screen instructions.



For detailed information, see the help file.

If you have failed to register a fingerprint, follow these steps to try again.

- 1 Place the top joint of your finger on the fingerprint sensor (1).

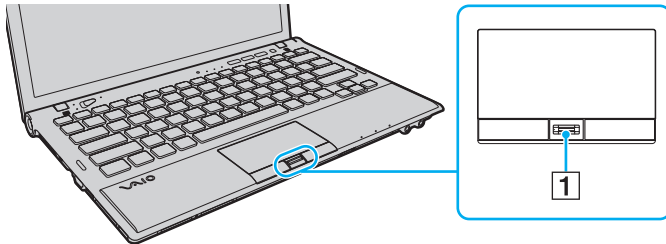

- 2 Swipe your finger perpendicularly across the fingerprint sensor.

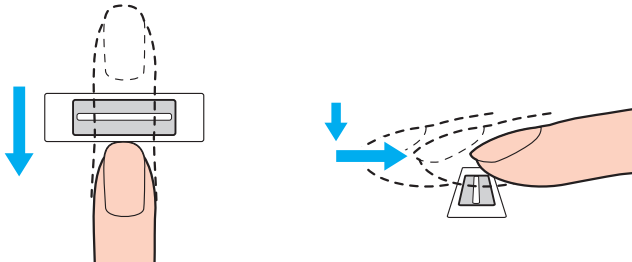

! Place your fingertip flat in the center of the fingerprint sensor.

Scan your fingerprint from the top joint of the finger to the fingertip.

Keep your finger in contact with the fingerprint sensor while swiping.

Fingerprint registration may fail if you move your finger too quickly or too slowly. Let the fingerprint sensor take about one second to scan your fingerprint.

You may not be able to register and/or have your fingerprint(s) recognized if your finger is too dry or wet, wrinkled, injured, dirty, etc.

Register more than one fingerprint in case that the fingerprint sensor fails to recognize the fingerprint.

Be sure to clean your fingertip(s) and the fingerprint sensor before swiping in order to keep good recognition performance.

You can register only the limited number of fingerprints for logging onto your system using the **Power-on Security** feature ([page 77](#)). The maximum number of fingerprints you can register varies depending on the data amount of each fingerprint.

You can also select the fingerprint you want to use for the **Power-on Security** feature later.

## Logging Onto Your System

To use the fingerprint authentication function in place of a password entry to log onto your system, you need to set the power-on and Windows passwords and configure your computer for fingerprint authentication.

For setting the power-on and Windows passwords, see **Setting the Password (page 123)**.

For detailed information, see the help file included with the **Protector Suite**.

## Logging onto Windows

If you have registered your fingerprints for your user account, you can substitute fingerprint authentication for Windows password entry. To log onto Windows, swipe the registered finger across the fingerprint sensor when the Windows log-on screen appears.

## Power-on Security feature

If you have set the power-on password ([page 124](#)), you can substitute fingerprint authentication for password entry when starting your computer.

## Erasing the Registered Fingerprints

Before disposing of your computer or transferring it to a third person, it is strongly recommended you erase the fingerprint data registered on the fingerprint sensor after erasing the data stored on your built-in storage device.

To erase the registered fingerprints

- 1 Turn on the computer.
- 2 Press the **F2** key when the VAIO logo appears.  
The BIOS setup screen appears. If the screen does not appear, restart the computer and press the **F2** key several times when the VAIO logo appears.
- 3 Press the **←** or **→** key to select **Security** to display the **Security** tab.
- 4 Press the **↓** key to select **Clear Fingerprint Data** and press the **Enter** key.
- 5 At the confirmation prompt, select **Continue** and press the **Enter** key.  
The fingerprint data registered on the fingerprint sensor is erased automatically after your system restarts.

## Using the TPM

The Trusted Platform Module (TPM) may be embedded in your computer to provide basic security functions. In combination with the TPM, you can encrypt and decrypt your data to strengthen computer security against inappropriate access.



Some features and options in this section may not be available on your computer.  
See the specifications to find out about the configuration of your computer.

TPMs are defined by Trusted Computing Group (TCG) and also called security chips.

## Important Notice

### Notes on encrypting the operating system or program files

Encrypting files used by your operating system or any software application, using the Encrypting File System (EFS) with the TPM, will disable you to launch or operate such software.

To avoid such problems, observe the following before using the EFS:

- ❑ Be sure to save data you want to encrypt to the following destinations:
  - ❑ The **Encrypted Data** folder created with the default settings in the user initialization process
  - ❑ A new encrypted folder created in the **My Documents** folder or the **Documents** folder on your account
  - ❑ The Personal Secure Drive



The Personal Secure Drive is a virtual drive that is created by using the Personal Secure Drive feature and automatically encrypts data that is saved to it.

- ❑ Do not change the following settings on the **View** tab in the **Folder Options** window displayed by clicking **Folder and search options** from **Organize** in the menu of Windows Explorer.
  - ❑ **Don't show hidden files, folders, or drives**
  - ❑ **Hide protected operating system files (Recommended)**
- ❑ Do not change the system attributes of the files, unless necessary.
- ❑ Do not encrypt the **Windows** folder, the **Program Files** folder, and all files in each folder.
- ❑ Do not encrypt the **Users** folder and all account folders in it.



## Notes on encrypting key files or files on the Personal Secure Drive

Encrypting files created in the following folders when your user account is initialized and the EFS is enabled will disable you to launch your TPM software and decrypt the encrypted data.

With the default settings, the files in the folders below cannot be encrypted because they have system attributes. Do not change the system attributes of the files in the folders below.

! The following folders are hidden by default.

- Folders containing key files
  - C:\ProgramData\Infineon
  - C:\Users\All Users\Infineon  
(C:\Users\All Users is a shortcut to C:\ProgramData.)
  - C:\Users\<account>\AppData\Roaming\Infineon
- Files on the Personal Secure Drive  
C:\Security Platform\Personal Secure Drive\System Data\xxx.FSF

## Notes on encrypting backup files or other files

Encrypting backup archive files or emergency recovery token files will disable you to recover your computer system for emergency, and encrypting password reset token files or secret files will disable you to reset the password.

Do not encrypt the following files or folders:



The default path for files below or displayed by clicking **Browse** is My Documents (or Documents)\Security Platform or Security Platform in removal media.

- Automatic backup archive file  
Default file name: SPSystemBackup.xml or SPSystemBackup\_<your computer name>.xml
- Storage folder for automatic backup archive files  
Folder name (Fixed):
  - SPSystemBackup (The folder is created as the subfolder for the SPSystemBackup.xml file.)
  - SPSystemBackup\_<your computer name> (The folder is created as the subfolder for SPSystemBackup\_<your computer name>.xml file.)
- Emergency recovery token file  
Default file name: SPEmRecToken.xml
- Password reset token file  
Default file name: SPPwResetToken.xml
- Token file for emergency recovery/password reset  
Default file name: SPToken\_<your computer name>.xml
- Password reset secret file  
Default file name: SPPwdResetSecret.xml or SPPwdResetSecret\_<your computer name>\_<user name>.<domain name>.xml

- Key and certificate backup file  
Default file name: SpBackupArchive.xml
- PSD backup file  
Default file name: <Drive name>-Personal Secure Drive.fsb
- Owner password backup file  
Default file name: SpOwner\_<your computer name>.tpm
- Protocol file  
Default file name: SpProtocol\_<your computer name>\_<user name>.<domain name>.txt

## Configuring the TPM

To use the embedded TPM, you need to:

- 1 Enable the TPM in the BIOS setup screen.
- 2 Install the **Infineon TPM Professional Package**.
- 3 Initialize and configure the TPM.

To enable the TPM in the BIOS setup screen

- 1 Turn on your computer.
- 2 Press the **F2** key when the VAIO logo appears.  
The BIOS setup screen appears. If the screen does not appear, restart the computer and press the **F2** key several times when the VAIO logo appears.
- 3 Press the **←** or **→** key to select the **Security** tab, the **↑** or **↓** key to select **Change TPM State**, and then the **Enter** key.
- 4 Press the **↑** or **↓** key to select **Enable** and then the **Enter** key.
- 5 Press the **←** or **→** key to select **Exit**, select **Exit Setup**, and then press the **Enter** key.
- 6 After your system restarts, select **Execute** in the confirmation window and then press the **Enter** key.



You can also disable the TPM and clear the TPM configuration in the BIOS setup screen.



Before enabling the TPM, be sure to set the power-on password to protect against unauthorized modification of the TPM configuration.

If the TPM is enabled, it will take longer before the VAIO logo appears due to security checks at computer startup.

You will not be able to access any TPM-protected data if you clear the TPM ownership. Before clearing the TPM configuration, be sure to make backup copies of the TPM-protected data.

## To install the Infineon TPM Professional Package

Read the Readme.txt in the **C:\Infineon\Readme** folder. Then, double-click **setup.exe** in the **C:\Infineon** folder to install the package.

To install this package, you must have administrative rights on the computer.

! You need to set a few passwords while installing the **Infineon TPM Professional Package**. Without these passwords, you will not be able to restore any TPM-protected data or backup files. Be sure to write down the passwords and keep them safe and private from other people.

## To initialize and configure the TPM

See the on-screen documentation for detailed information. To open the documentation, click **Start, All Programs, Infineon Security Platform Solution**, and **Help**.

! The maintenance and management of TPM-protected data must be carried out at your own risk. Sony assumes no liability for any defects arising out of your data maintenance and management.

## Using BitLocker Drive Encryption with the TPM

**BitLocker Drive Encryption** is a data encryption feature that is available on models with Windows 7 Ultimate. Enabling **BitLocker Drive Encryption** in conjunction with the TPM encrypts all data on the built-in storage device.

For detailed information on how to use and configure **BitLocker Drive Encryption**, see **Windows Help and Support**.



See the specifications to find out about the configuration of your computer.

### Notes on using BitLocker Drive Encryption

- ❑ Be sure to initialize the TPM with the **Infineon TPM Professional Package** before enabling **BitLocker Drive Encryption**. If you enable it without initializing the TPM, a TPM owner password is not generated, so you will not be able to configure the **Infineon TPM Professional Package**.
- ❑ The **Infineon TPM Professional Package** does not make a backup copy of a file (recovery password) for **BitLocker Drive Encryption**.
- ❑ An additional BitLocker system partition has been pre-configured. This system partition uses 100 MB of your total built-in storage device volume.
- ❑ You must enable the TPM in the BIOS setup screen in order to turn on **BitLocker Drive Encryption**.
- ❑ Do not encrypt data on a storage device (such as a USB flash memory device) on which a recovery key is stored using **BitLocker Drive Encryption**.

## To unlock the encrypted data with a recovery key stored on a USB flash memory device

To unlock the encrypted data with a recovery key stored on a USB flash memory device, your system needs to access the USB flash memory device when you boot the computer. Follow these steps to configure the boot order in the BIOS setup screen:

- 1 Turn on your computer.
- 2 Press the **F2** key when the VAIO logo appears.  
The BIOS setup screen appears. If the screen does not appear, restart the computer and press the **F2** key several times when the VAIO logo appears.
- 3 Press the **←** or **→** key to select the **Security** tab, the **↑** or **↓** key to select **Change TPM State**, and then the **Enter** key.
- 4 Press the **↑** or **↓** key to select **Enable** and then the **Enter** key.
- 5 Press the **←** or **→** key to select **Boot** and then select **Enabled** for **External Device Boot**.
- 6 Press the **↑** or **↓** key to select **Boot Priority** and then the **Enter** key.
- 7 Press the **F5** or **F6** key to change the boot device order so that **Internal Hard Disk** is listed higher than **External Device**.

! You need to move **Internal Optical Drive** to the top of the list to recover the computer system using your recovery discs.

- 8 Press the **←** or **→** key to select **Exit**, select **Exit Setup**, and then press the **Enter** key.
- 9 After your system restarts, select **Execute** in the confirmation window and then press the **Enter** key.
- 10 Follow the instructions in **Windows Help and Support** to enable **BitLocker Drive Encryption**.
- 11 Save the recovery password to the USB flash memory device in the window for saving the recovery password.
- 12 Follow the on-screen instructions.  
The encryption process will start.

! Updating your BIOS with updating software, such as the **VAIO Update**, changes the BIOS settings back to the default. You need to repeat the steps above again.

It takes several hours to complete the encryption process.



# Using Peripheral Devices

You can add functionality to your VAIO computer by using the various ports on the computer.

- ❑ **Using the Noise Canceling Headphones** ([page 90](#))
- ❑ **Connecting a Port Replicator** ([page 97](#))
- ❑ **Connecting External Speakers or Headphones** ([page 105](#))
- ❑ **Connecting an External Display** ([page 106](#))
- ❑ **Selecting Display Modes** ([page 113](#))
- ❑ **Using the Multiple Monitors Function** ([page 114](#))
- ❑ **Connecting an External Microphone** ([page 116](#))
- ❑ **Connecting a USB Device** ([page 117](#))

## Using the Noise Canceling Headphones

A pair of noise canceling headphones is supplied with your computer.

The noise canceling headphones are equipped with a built-in microphone that picks up ambient noises and outputs an antiphase sound to reduce the noises.

## Before You Use the Noise Canceling Headphones

- ❑ You can enable the noise canceling function only when the supplied noise canceling headphones are connected to the headphones jack that supports this function.
- ❑ The noise canceling function does not work on sound output with the following devices:
  - ❑ External speakers
  - ❑ Headphones without the noise canceling function
  - ❑ Sound output devices connected to your computer via a Bluetooth connection
- ❑ The noise canceling function cannot be fully in effect unless you properly wear the headphones. Be sure to fit earpieces of the headphones tightly into your ears.

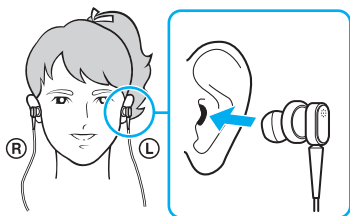

If you feel that the noise canceling function has little effect, adjust the earbud position in the earpieces of the noise canceling headphones or replace the earbuds with a pair in another size. A pair of medium-size earbuds is attached to the earpieces by default and there should be an extra pair in each small and large sizes supplied with the headphones.

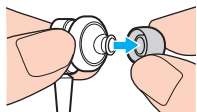

- ❑ The noise canceling function is to reduce low-frequency noise in the ambient environment but not high-frequency noise. Nor is it to implement a 100% noise-free audio environment.

- ❑ When the noise canceling function does not seem to be working, unplug the supplied noise canceling headphones completely and then plug them back again.
- ❑ Keep the built-in microphone (1) of the noise canceling headphones unblocked to ensure that the noise canceling function can be fully in effect.

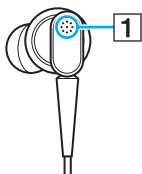

- ❑ You may hear a soft hissing noise while the noise canceling function is enabled. This is just operational noise that the function generates and does not indicate a malfunction.
- ❑ You may feel that the noise canceling function has little effect or ambient noises seem even louder, depending on the type of noise or the degree of quietness in your environment. In such a case, disable the noise canceling function.
- ❑ Use of a mobile phone may cause radio interference with the noise canceling headphones. When using the headphones, keep mobile phones away from the headphones.
- ❑ Plugging or unplugging the noise canceling headphones generates noise. This is normal and does not indicate a malfunction. Be sure to take off the headphones from your ears before plugging or unplugging the headphones.
- ❑ Enabling/disabling the noise canceling function or enabling/disabling sound with the Windows volume controls generates noise. This is caused by switching the noise canceling circuit and does not indicate a malfunction.
- ❑ Be sure to use the supplied noise canceling headphones. You can plug the headphones supplied with a Walkman® to your computer but the noise canceling function of the computer will not work well with such headphones.
- ❑ If you configure your noise canceling headphones to pick up sounds from its built-in microphone and output them through the earpieces, the sounds will be amplified. Be careful about the volume when you change the configuration.

## Connecting the Noise Canceling Headphones

To connect the noise canceling headphones

Plug the headphones cable into the headphones jack .

The  icon appears on the taskbar to indicate that the noise canceling function is enabled and a balloon message pops up from the icon.



When the  icon is on the taskbar, the noise canceling function is disabled. Right-click the icon and select **Enable Noise Canceling Function** from the menu.

If no icon is on the taskbar, see **What to do if the icon and the balloon do not appear** ([page 96](#)) to change the settings.

## Adjusting the Effect of the Noise Canceling Function

The noise canceling headphones supplied with your computer is configured to yield the optimum effect by default.

If you feel that the noise canceling function is not fully in effect, you may be able to adjust the effect with the **Noise Canceling Control** slider on the **Noise Canceling Headphones** window.

To adjust the effect of the noise canceling function

- 1 Right-click the  icon on the taskbar and select **Settings**.



If no icon is on the taskbar, see **What to do if the icon and the balloon do not appear** ([page 96](#)) to change the settings.

- 2 Drag the **Noise Canceling Control** slider toward **Mic+** or **Mic-** to select your desired noise canceling level.



The slider should be at the center of the range to yield the optimum level. Dragging the slider all the way to **Mic+** does not bring the noise canceling function fully into effect.

- 3 Click **Apply**.
- 4 Confirm that the noise canceling effect is satisfactory and then click **OK**.

## Using the microphone directivity function

Just like an ordinary microphone, the built-in microphone of the noise canceling headphones picks up ambient sounds coming from all directions. The microphone directivity (beamforming) function, however, can reduce ambient noises and pick up mainly your voice and sounds coming from your front and rear.

The microphone directivity function comes in handy when you want your voice to sound clearly while chatting or when you want to use the headphones as a microphone to record your own voice or sounds coming from your front.

### To enable the microphone directivity function

- 1 Right-click the  icon on the taskbar and select **Settings**.





If no icon is on the taskbar, see **What to do if the icon and the balloon do not appear** ([page 96](#)) to change the settings.

- 2 Click the **Microphone directivity** tab and select the **Enable the microphone directivity function** check box.
- 3 Click **OK**.



When ambient noises are extremely loud, the microphone directivity function may not become fully in effect or the volume level of the noises may fluctuate at short intervals.

## What to do if the icon and the balloon do not appear

When the noise canceling function icon (/) is not on the taskbar and the balloon message does not pop up from the icon, change the noise canceling function settings.

To display the balloon message and the icon

- 1 Click **Start** and **Control Panel**.
- 2 Click **Hardware and Sound**.
- 3 Click **Manage audio devices** under **Sound**.
- 4 On the **Playback** tab, double-click the speakers or headphones icon.
- 5 Click the **Enhancements** tab.
- 6 Click to select the **Noise Canceling Function** check box and click **Modify Settings**.



If the **Disable all enhancements** check box is selected, click to cancel the check box.

- 7 Click to select the **Display an icon for the noise canceling headphones in the task tray** or **Display a message when noise canceling headphones are connected** check box.
- 8 Click **OK**.



## Connecting a Port Replicator

Attaching an optional port replicator enables you to connect additional peripherals to your computer, such as a printer and an external display.

### Locating Ports on the Port Replicator

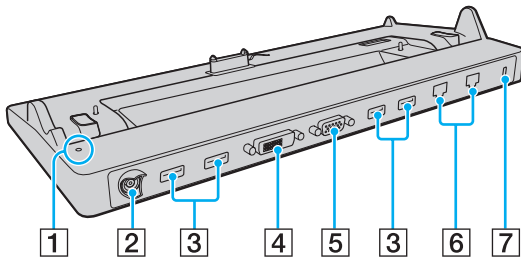

- 1 DC IN indicator  
Illuminates while the port replicator is powered.
- 2 DC IN port (page 19)
- 3 USB ports\*<sup>1</sup> (page 117)
- 4 DVI-D port (page 107)
- 5 **MONITOR** port (page 107)
- 6 Network (LAN) ports\*<sup>2</sup> (page 62)
- 7 Security slot

\*1 Compliant with the USB 2.0 standard and support high-/full-/low- speeds.

\*2 The port replicator has a protective sticker  covering each network (LAN) port. Connect a 10BASE-T, 100BASE-TX, 1000BASE-T cable to the network (LAN) port. Using an incorrect cable, such as a phone cable, may result in an electric current overload that can cause a malfunction, excessive heat, or fire in the network (LAN) port.

! Simultaneous use of the following ports is not possible.

- **HDMI** output port on your computer
- **DVI-D** port on the port replicator
- **MONITOR** port on the port replicator

## Attaching Your Computer to the Port Replicator

! Be sure to install the battery pack before attaching your computer to the port replicator.

To attach your computer to the port replicator

! Be sure to use the AC adapter supplied with the port replicator.

To prevent loss of unsaved data, be sure to turn off your computer before attaching it to the port replicator.

Do not move your computer when it is attached to the port replicator. This may detach the port replicator and cause damage to both units.

The monitor port on your computer is not accessible when the computer is attached to the port replicator. Use the **DVI-D** or **MONITOR** port on the port replicator for connecting an external display.

- 1 Disconnect all peripherals and the AC adapter from the computer.
- 2 Plug one end of the power cord (1) into the AC adapter (2) and the other end into an AC outlet.
- 3 Plug the cable connected to the AC adapter (2) into the DC IN port (3) on the port replicator (4).

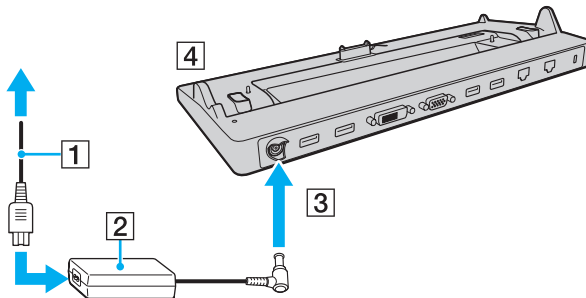

! Be sure to plug the AC adapter cable as illustrated below:

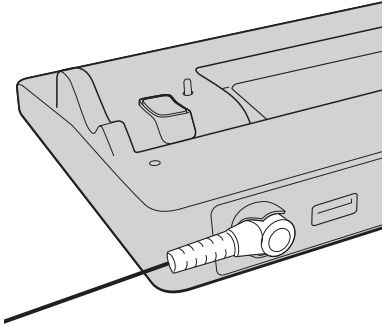

- 4 Remove the port replicator connector cover from the bottom of the computer.

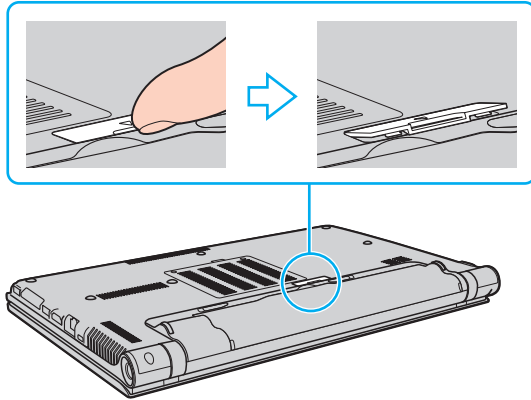

**!** You may find it difficult to remove the port replicator connector cover, as it is tight in place on your computer. Do not exert extra pressure when removing the cover so as not to damage the computer or the port replicator connector cover.



Once you have removed the port replicator connector cover, keep it in the designated space (5) on the port replicator.

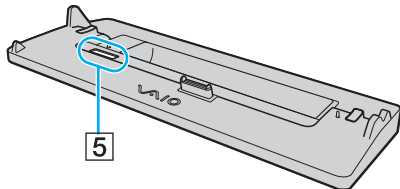

- 5 Align the rear bottom corners of the computer with the guides on the port replicator.

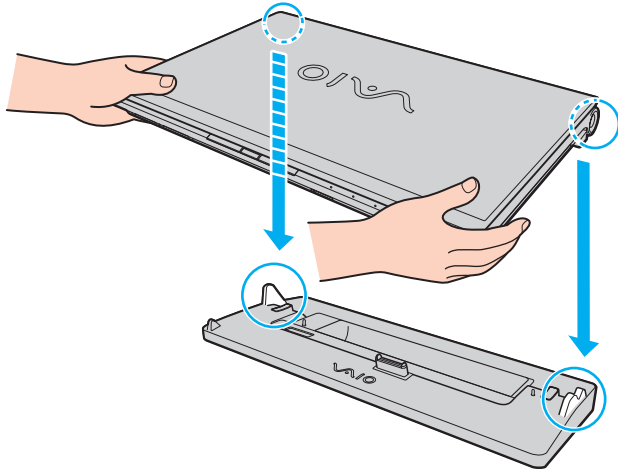

- 6 Gently push down the computer until it clicks into place.

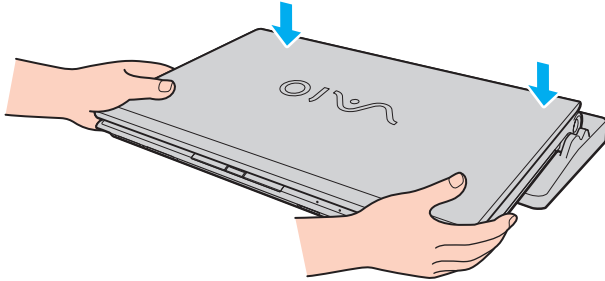

- 7 Lift open the LCD screen lid and turn on the computer.

## Disconnecting Your Computer from the Port Replicator

**!** To prevent loss of unsaved data, be sure to turn off your computer before disconnecting it from the port replicator.

When the battery pack is running out of power, disconnecting your computer from the port replicator may result in loss of unsaved data.

To disconnect your computer from the port replicator

- 1 Lift the computer away from the port replicator.

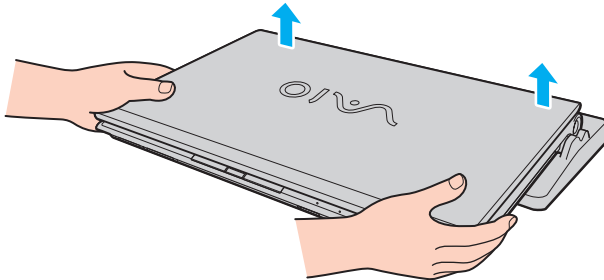

- 2 Replace the port replicator connector cover on the bottom of the computer.

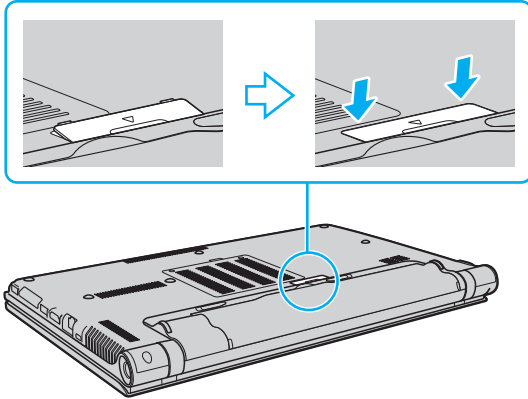

 It is extremely important that you replace the port replicator connector cover after disconnecting your computer from the port replicator. If the connector is left uncovered, dust may get inside and damage the computer.

To disconnect the port replicator completely from an AC power source, unplug the AC adapter.



## Connecting External Speakers or Headphones

You can connect external sound output devices (not supplied), such as speakers or headphones, to your computer.

To connect external speakers



Make sure your speakers are designed for computer use.



Turn down the volume of the speakers before you turn them on.

The noise canceling function does not work on sound output through external speakers.

Connect external speakers (1) to the headphones jack (2) with a speaker cable (3) (not supplied).

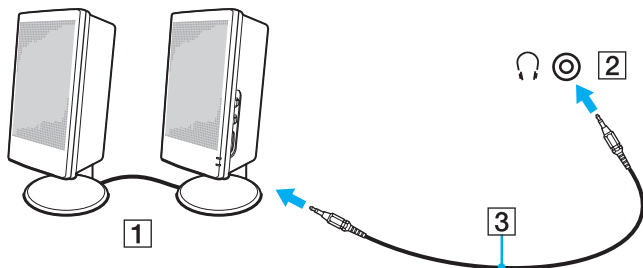

## Connecting an External Display



Some features and options in this section may not be available on your computer.



Blu-ray Disc playback on a connected external display may be interrupted, depending on the type or bit rate of the video. You may be able to solve this problem by lowering the screen resolution of the display. Follow the steps in **Why doesn't my screen display a video?** ([page 188](#)) to change the screen resolution.



If disconnecting the external display from the optional port replicator does not automatically change the LCD resolution of your computer, change the current display settings. To change the settings, see **Selecting Display Modes** ([page 113](#)).

## Connecting a Computer Display or a Projector

You can connect an external display, such as a computer display or a projector, either directly to your computer or via the optional port replicator.

To connect a computer display or a projector



The monitor port on your computer is not accessible when the computer is attached to the port replicator.

When you use the **HDMI** output port on your computer or the **DVI-D** port on the port replicator, select the **SPEED** or **AUTO** mode with the performance selector switch. See **Selecting Performance Modes (page 120)** for mode selection.

- 1 Plug the power cord (1) of your external display or the projector into the AC outlet.
- 2 Connect the external display or the projector to the monitor port (2) on the computer or the port replicator with a display cable (3).

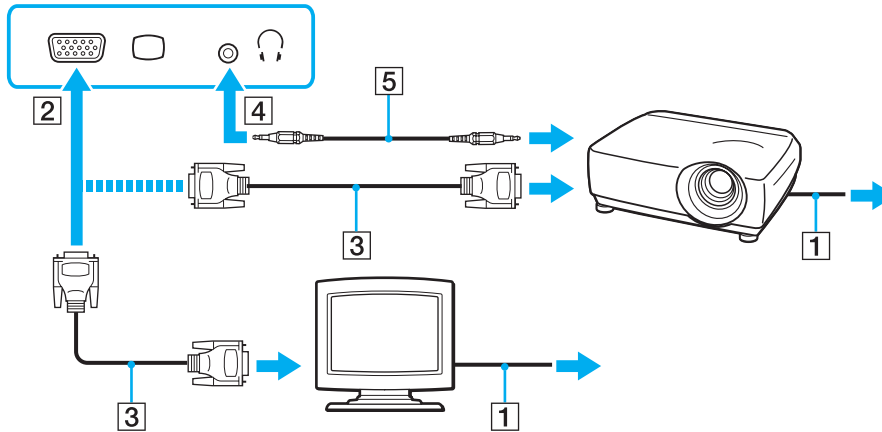

If necessary, connect the headphones jack on the projector and the headphones jack (4) on the computer with a speaker cable (5).

! Your computer is compliant with the HDCP standard and capable of encrypting the transmission channel of digital video signals for the purpose of copyright protection, which enables you to play and view a wide variety of copyright protected and high-quality content. To view the copyright protected content, connect an HDCP-compliant monitor to the **HDMI** output port on your computer or the **DVI-D** port on the port replicator. If your computer has a non-compliant monitor connected, you will not be able to play or view any copyright protected content.



If the external computer display is equipped with an HDMI input port, plug one end of an HDMI cable into the **HDMI** output port on the computer and the other end into the HDMI input port on the computer display.

To connect a TFT/DVI monitor, use an HDMI to DVI-D adapter to connect it to the **HDMI** output port on the computer; or use a display cable to connect it to the **DVI-D** port on the port replicator.

DVI-D stands for Digital Visual Interface - Digital. It is a type of DVI port that supports only digital video signals (no analog video signals). It has 24 pins.

A DVI-I (Digital Visual Interface - Integrated) port supports digital video and analog video signals. It has 29 pins.

The HDMI cable carries both video and audio signals.

## Connecting a TV with an HDMI Input Port

You can connect a TV with an HDMI input port to your computer.

To connect a TV to your computer

! To hear sound from the device connected to the **HDMI** output port, you need to change the device for sound output. For detailed instructions, see **How do I change the sound output device?** (page 197).

When you use the **HDMI** output port on your computer, select the **SPEED** or **AUTO** mode with the performance selector switch. See **Selecting Performance Modes** (page 120) for mode selection.

- 1 Plug the power cord of your TV (1) into an AC outlet.
- 2 Plug one end of an HDMI cable (2) to the **HDMI** output port (3) on the computer and the other end to the TV.
- 3 Switch the input channel of the TV to external input.
- 4 Set up the TV configuration system.

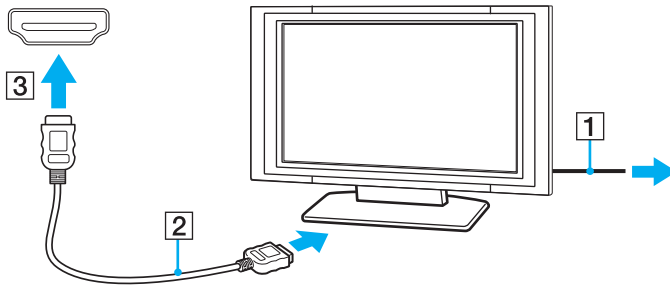

! If a device driver other than the one provided by Sony is used, the image will not be displayed and the audio will not be heard. Always use the device driver provided by Sony for updates.



See the manual that came with your TV for more information on installation and use.

The HDMI cable carries both video and audio signals.

## To connect a high-quality digital sound output device between your computer and a TV

You can connect a high-quality home theater receiver or other surround sound decoder devices between your computer and TV using an HDMI connection.



Before connecting the device to the computer, make sure the HDMI connection has been set up between the TV and the home theater receiver or surround sound decoder device first.

To hear sound from the device connected to the **HDMI** output port, you need to change the device for sound output. For detailed instructions, see **How do I change the sound output device?** ([page 197](#)).

When you use the **HDMI** output port on your computer, select the **SPEED** or **AUTO** mode with the performance selector switch. See **Selecting Performance Modes** ([page 120](#)) for mode selection.

- 1 Turn on the TV and set its input to the HDMI input.
- 2 Turn on the home theater receiver or surround sound decoder device and set its input to the HDMI input.
- 3 Plug one end of an HDMI cable to the HDMI input port on the home theater receiver or surround sound decoder device and the other end to the **HDMI** output port on the computer.



You can adjust the screen resolution of the connected TV with your computer. See **Why doesn't my screen display a video?** ([page 188](#)) for more information.

With the HDMI connection, the volume can be adjusted by the connected audio device only. Your computer has no control over the output volume of any connected devices.



## Selecting Display Modes

When an external display is connected, you can select either your computer screen or the connected display to use as the primary monitor.



The monitor port on your computer is not accessible when the computer is attached to the port replicator.

The screen resolution of your external display may change when you change the performance mode.

When you use the **HDMI** output port on your computer or the **DVI-D** port on the port replicator, select the **SPEED** or **AUTO** mode with the performance selector switch. See **Selecting Performance Modes (page 120)** for mode selection.



You may not be able to display the same content on your computer screen and the external display or projector at the same time, depending on the type of your external display or projector.

Turn on the external display before turning on your computer.

### To select a display mode with the Fn+F7 keys

You can select a display mode with the **Fn+F7** keys. See **Combinations and Functions with the Fn Key (page 33)** for more information.

### To select a display mode from the display settings

- 1 Right-click on the desktop and select **Screen resolution**.
- 2 Click the drop-down list next to **Multiple Displays**, select your desired setting, and then click **OK**.

## Using the Multiple Monitors Function

The Multiple Monitors function allows you to distribute portions of your desktop across separate displays. For example, if you have an external display connected to the monitor port, your computer screen and the external display can function as a single desktop.

You can move the cursor from one display to the other. This allows you to drag objects, such as an open application window or a toolbar, from one display to the other.

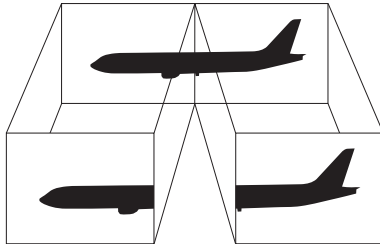

## To use the Multiple Monitors function



The monitor port on your computer is not accessible when the computer is attached to the port replicator.

The screen resolution of your external display may change when you change the performance mode.

When you use the **HDMI** output port on your computer or the **DVI-D** port on the port replicator, select the **SPEED** or **AUTO** mode with the performance selector switch. See **Selecting Performance Modes (page 120)** for mode selection.



Your external display may not support the Multiple Monitors function.

Certain software applications may not be compatible with Multiple Monitors settings.

Make sure that your computer does not enter Sleep or Hibernate mode while you are using the Multiple Monitors function, or the computer may not return to Normal mode.

If you set different colors on each display, do not expand a single window across two displays, or your software may not work properly.

- 1 Right-click on the desktop and select **Screen resolution**.
- 2 Click the drop-down list next to **Multiple Displays**, select **Extend these displays**, and then click **OK**.



You can set the display colors and resolution for each display and customize the Multiple Monitors function.

Set fewer colors or a lower resolution for each display.

## Connecting an External Microphone

You can connect an external microphone (not supplied) to your computer.

To connect an external microphone

Plug the microphone cable (1) into the microphone jack (2) .

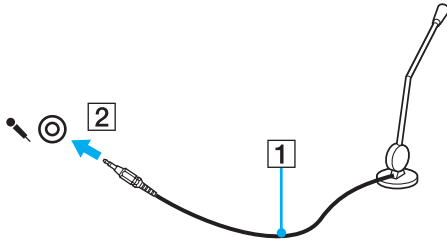

Make sure your microphone is designed for computer use.

## Connecting a USB Device

You can connect a Universal Serial Bus (USB) device to your computer, such as a mouse, floppy disk drive, speaker, and printer.

To connect a USB device

- 1 Choose the USB port (1) you prefer to use.
- 2 Plug the USB device cable (2) into the USB port.

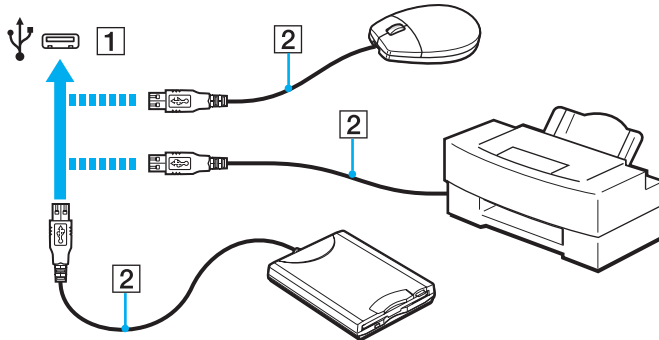

## Notes on connecting a USB device

- ❑ You may need to install the driver software supplied with your USB device before use. See the manual that came with the USB device for more information.
- ❑ Be sure to use a USB printer compatible with your version of Windows to print documents.
- ❑ For information on how to remove a USB device, see the manual that came with the device.
- ❑ To protect your computer and/or USB devices from damage, observe the following:
  - ❑ When moving the computer with USB devices connected, avoid exposing the USB ports to shock or impact.
  - ❑ Do not put the computer into a bag or carrying case when it has USB devices connected.

# Customizing Your VAIO Computer

This section briefly describes how to change the main settings of your VAIO computer. Among other things, you will learn how to use and customize the look of your Sony software and utilities.

- ❑ **Selecting Performance Modes** ([page 120](#))
- ❑ **Setting the Password** ([page 123](#))
- ❑ **Using Intel VT** ([page 130](#))
- ❑ **Using the VAIO Control Center** ([page 131](#))
- ❑ **Using the VAIO Power Management** ([page 132](#))

## Selecting Performance Modes

Your computer is equipped with the performance selector switch for changing the performance mode without restarting the computer. With this switch, you can choose one out of three performance modes: two distinct modes that use a specific video controller and another mode that automatically selects an optimum one between the two.

! While any software application that prevents your computer from changing the performance mode is in use, selecting another mode with the performance selector switch may not change the performance mode. In such a case, close the application. The selected mode will automatically be activated. Changing the performance mode without closing the application may cause loss of unsaved data.

When you use the **HDMI** output port on your computer or the **DVI-D** port on the port replicator, select the **SPEED** or **AUTO** mode with the performance selector switch.



To select a performance mode

Slide the performance selector switch (1) in the direction of your desired mode.

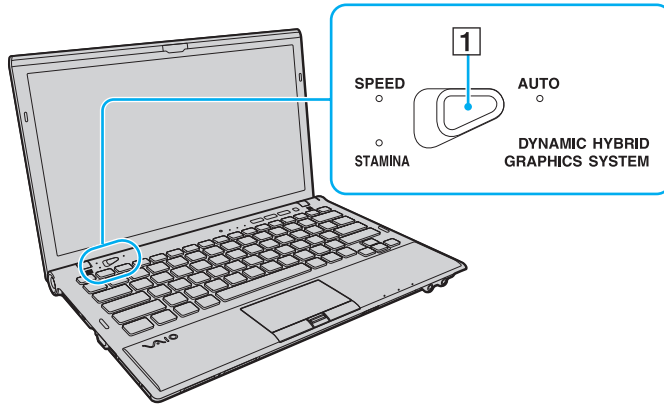

Type of Mode	Description
<b>STAMINA</b> mode	Uses the Intel Graphics Media Accelerator and disables some hardware devices on your computer to conserve battery power.
<b>SPEED</b> mode	Uses the NVIDIA video controller to provide faster performance.
<b>AUTO</b> mode	Automatically selects either <b>STAMINA</b> or <b>SPEED</b> mode to provide optimum performance when: <ul style="list-style-type: none"><li>- The AC adapter is plugged or unplugged.</li><li>- An external device is connected to or disconnected from the <b>HDMI</b> output port on your computer or the <b>DVI-D</b> port on the optional port replicator.</li><li>- Your computer is attached to or disconnected from the optional port replicator.</li></ul>



To check the current performance mode

- ❑ Find out which performance mode indicator light is lit: **STAMINA**, **SPEED**, or **AUTO**.
- ❑ Find out which performance mode icon is on the Windows desktop notification area.

## Setting the Password

Setting the password allows you to protect your computer from unauthorized access by making the user enter the password when the computer is turned on or returns to Normal mode from Sleep mode or Hibernate mode.

**!**  
Do not to forget your password. Write down the password and keep it in a secure place.

Type of Password	Description
Power-on password	<p>You can use BIOS functions to set two types of passwords:</p> <ul style="list-style-type: none"><li>- Machine password: Allows users with administrative rights to change all the setup options in the BIOS setup screen, as well as to start the computer.</li><li>- User password: Allows the standard users to change some of the BIOS setup options, as well as to start the computer. To set the user password, you must first set the machine password.</li></ul> <p> Entry of the power-on password will be prompted after the VAIO logo appears to start your computer.</p> <p><b>!</b> If you forget the machine password, the password needs to be reset and a fee will be charged. To reset the password, contact an authorized Sony service/support center. To find the nearest center or agent, see <b>Finding More about Your VAIO Computer (page 5)</b>. You can reset the user password at the BIOS setup screen by entering the machine password.</p>
Windows password	<p>Allows users to log onto your computer and protect each user account with its own password.</p> <p> Entry of the Windows password will be prompted after you select your user account.</p>

## Setting the Power-on Password

To add the power-on password (machine password)

- 1 Turn on the computer.
- 2 Press the **F2** key when the VAIO logo appears.  
The BIOS setup screen appears. If the screen does not appear, restart the computer and press the **F2** key several times when the VAIO logo appears.
- 3 Press the **←** or **→** key to select **Security** to display the **Security** tab, select **Set Machine Password**, and then press the **Enter** key.
- 4 On the password entry screen, enter the password twice and press the **Enter** key.  
The password can be up to 32 alphanumeric characters long (including spaces).
- 5 Select **Password when Power On** under **Security** and press the **Enter** key.
- 6 Change the setting from **Disabled** to **Enabled**.
- 7 Press the **←** or **→** key to select **Exit**, select **Exit Setup**, and then press the **Enter** key.  
At the confirmation prompt, press the **Enter** key.

## To add the power-on password (user password)

! Make sure you set the machine password before setting the user password.

- 1 Turn on the computer.
- 2 Press the **F2** key when the VAIO logo appears.  
The password entry screen appears. If the screen does not appear, restart the computer and press the **F2** key several times when the VAIO logo appears.
- 3 Enter the machine password and press the **Enter** key.
- 4 Press the **←** or **→** key to select **Security** to display the **Security** tab, select **Set User Password**, and then press the **Enter** key.
- 5 On the password entry screen, enter the password twice and press the **Enter** key.  
The password can be up to 32 alphanumeric characters long (including spaces).
- 6 Press the **←** or **→** key to select **Exit**, select **Exit Setup**, and then press the **Enter** key.  
At the confirmation prompt, press the **Enter** key.

## To change or remove the power-on password (machine password)

- 1 Turn on the computer.
- 2 Press the **F2** key when the VAIO logo appears.  
The password entry screen appears. If the screen does not appear, restart the computer and press the **F2** key several times when the VAIO logo appears.
- 3 Enter the machine password and press the **Enter** key.
- 4 Press the **←** or **→** key to select **Security** to display the **Security** tab, select **Set Machine Password**, and then press the **Enter** key.
- 5 On the password entry screen, enter the current password once and a new password twice, and then press the **Enter** key.  
To remove the password, leave the **Enter New Password** and **Confirm New Password** fields blank and press the **Enter** key.
- 6 Press the **←** or **→** key to select **Exit**, select **Exit Setup**, and then press the **Enter** key.  
At the confirmation prompt, press the **Enter** key.

## To change or remove the power-on password (user password)

- 1 Turn on the computer.
- 2 Press the **F2** key when the VAIO logo appears.  
The password entry screen appears. If the screen does not appear, restart the computer and press the **F2** key several times when the VAIO logo appears.
- 3 Enter the user password and press the **Enter** key.
- 4 Press the **←** or **→** key to select **Security** to display the **Security** tab, select **Set User Password**, and then press the **Enter** key.
- 5 On the password entry screen, enter the current password once and a new password twice, and then press the **Enter** key.  
To remove the password, leave the **Enter New Password** and **Confirm New Password** fields blank and press the **Enter** key.
- 6 Press the **←** or **→** key to select **Exit**, select **Exit Setup**, and then press the **Enter** key.  
At the confirmation prompt, press the **Enter** key.

## Setting the Windows Password

To add the Windows password

- 1 Click **Start** and **Control Panel**.
- 2 Click **User Accounts and Family Safety** or **User Accounts**.
- 3 Click **User Accounts**.
- 4 Click **Create a password for your account** under **Make changes to your user account**.
- 5 In the **New password** and **Confirm new password** fields, enter the password for your account.
- 6 Click **Create password**.



See **Windows Help and Support** for more information on the Windows password.

To change the Windows password

- 1 Click **Start** and **Control Panel**.
- 2 Click **User Accounts and Family Safety** or **User Accounts**.
- 3 Click **User Accounts**.
- 4 Click **Change your password**.
- 5 In the **Current password** field, enter your current password.
- 6 In the **New password** and **Confirm new password** fields, enter a new password.
- 7 Click **Change password**.



To remove the Windows password

- 1 Click **Start** and **Control Panel**.
- 2 Click **User Accounts and Family Safety** or **User Accounts**.
- 3 Click **User Accounts**.
- 4 Click **Remove your password**.
- 5 In the **Current password** field, enter the current password that you want to remove.
- 6 Click **Remove password**.

## Using Intel(R) VT

Intel(R) Virtualization Technology (VT) allows you to use hardware virtualization software for enhancing your computer's performance.

! Intel VT may not be available depending on the CPU installed on your computer.

For information on virtualization and how to use hardware virtualization software, contact the software publisher.

### To enable Intel VT

- 1 Turn on your computer.
- 2 Press the **F2** key when the VAIO logo appears.  
The BIOS setup screen appears. If the screen does not appear, restart the computer and press the **F2** key several times when the VAIO logo appears.
- 3 Press the **←** or **→** key to select **Advanced**.
- 4 Press the **↑** or **↓** key to select **Intel(R) Virtualization Technology** or **Intel(R) VT**, press the **Enter** key, select **Enabled**, and press the **Enter** key.

! If the **Advanced** tab is not displayed in the BIOS setup window or you cannot select **Intel(R) Virtualization Technology**, Intel VT is not available on the computer.

- 5 Press the **←** or **→** key to select **Exit**, select **Exit Setup**, and then press the **Enter** key.  
At the confirmation prompt, press the **Enter** key.

## Using the VAIO Control Center

The **VAIO Control Center** utility allows you to access system information and to specify preferences for system behavior.

To use the VAIO Control Center

- 1 Click **Start**, **All Programs**, and **VAIO Control Center**.
- 2 Select your desired control item and change the settings.
- 3 Once finished, click **OK**.  
The setting of the desired item is changed.



For more information about each option, see the help file included with the **VAIO Control Center**.

Some of the control items will not be visible if you open the **VAIO Control Center** as a standard user.

## Using the VAIO Power Management

Power management helps you set up power plans for running on AC or battery power to suit your requirements for power consumption.

The **VAIO Power Management** function is added to the Windows **Power Options**. With this software application, you can enhance the Windows power management functions to ensure better operation of your computer and longer battery life.

### Selecting a Power Plan

When you start the computer, a power status icon appears on the taskbar. This icon indicates what kind of power source you are currently using. Click this icon to display the window that shows your power status.

To select a power plan

- 1 Right-click the power status icon on the taskbar and select **Power Options**.
- 2 Select your desired power plan.

To change the power plan settings

- 1 Click **Change plan settings** on the right of your desired power plan in the **Power Options** window. Change the Sleep mode and display settings as needed.
- 2 If you need to change the advanced settings, click **Change advanced power settings** and go to step 3. Otherwise, click **Save changes**.
- 3 Click the **VAIO Power Management** tab. Change the settings for each item.
- 4 Click **OK**.



You can check the current power plan settings with the **VAIO Power Management Viewer** in the **VAIO Control Center**.

## Upgrading Your VAIO Computer

Your VAIO computer and memory modules use high precision components and electronic connectors technology. To avoid invalidation of the warranty during your product warranty period, we recommend that:

- You should contact your dealer to install a new memory module.
- You should not install it yourself, if you are not familiar with upgrading memory on a computer.
- You should not touch the connectors or open the memory module compartment cover.

For assistance, contact an authorized Sony Service Center. To find the nearest center or agent, see **Finding More about Your VAIO Computer** (page 5).



The type of module and the amount of memory installed on your computer may differ depending on the model you purchased. See the specifications to find out about the configuration of your computer.

## Adding and Removing Memory

If you want to expand the functionality of your computer, you can increase the amount of memory by replacing the installed memory module. Before you upgrade your computer's memory, read the notes and procedures in the following pages.

### Notes on adding memory modules

- ❑ Be sure to place your computer on a flat surface before adding or removing memory modules.
- ❑ Be careful when changing memory. Improper installation of memory modules may cause damage to your system. This damage may void your manufacturer's warranty.
- ❑ Only use memory modules that are compatible with your computer. If a memory module is not detected by the computer or the Windows operating system becomes unstable, contact the sales dealer or the manufacturer of your memory module.
- ❑ Electrostatic discharge (ESD) can damage electronic components. Before touching a memory module, ensure the following:
  - ❑ The procedures described in this document assume user familiarity with the general terminology associated with personal computers and with the safety practice and regulatory compliance requirements for using and modifying electronic equipment.
  - ❑ Turn off your computer and disconnect it from its power sources (battery pack and AC adapter) and from any telecommunication links or networks before you remove any cover or panel from the computer. Failure to do so may result in personal injury or equipment damage.
  - ❑ ESD can damage memory modules and other components. Install the memory module only at an ESD workstation. If such a station is not available, do not work in a carpeted area, and do not handle materials that produce or hold static electricity (cellophane wrappers, for example). Ground yourself by maintaining contact with an unpainted metal portion of the chassis while performing the procedure.
  - ❑ Do not open the memory module package before you are ready to change the module. The package protects the module from ESD.

- Use the special bag supplied with the memory module or wrap the module in aluminum foil to protect it from ESD.
- Introducing any liquids, foreign substances, or objects into the memory module slots or other internal components of your computer will result in damage to the computer and any repair costs will not be covered by the warranty.
- Do not place the memory module in a location subject to:
  - Heat sources such as radiators or air ducts
  - Direct sunlight
  - Excessive dust
  - Mechanical vibration or shock
  - Strong magnets or speakers that are not magnetically shielded
  - Ambient temperature of more than 95°F / 35°C or less than 41°F / 5°C
  - High humidity
- Handle the memory module with care. To avoid injuries to your hands and fingers, do not touch the edges of the components and circuit boards inside your computer.

## Removing and Installing a Memory Module

To change or add a memory module

- 1 Shut down the computer and disconnect all peripheral devices.
- 2 Unplug the computer and remove the battery pack.
- 3 Wait about an hour until the computer cools down.
- 4 Unscrew two screws (indicated by the arrows below) on the bottom of the computer and remove the memory module compartment cover.

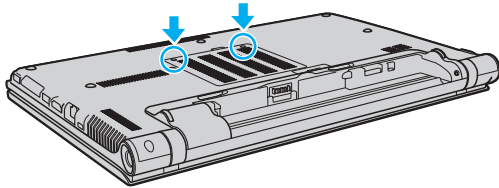

- 5 Touch a metal object to discharge static electricity.



**6** Remove the currently installed memory module as follows:

- ❑ Pull the latches in the direction of the arrows (1).  
The memory module is released.
- ❑ Make sure that the memory module tilts up and then pull it out in the direction of the arrow (2).

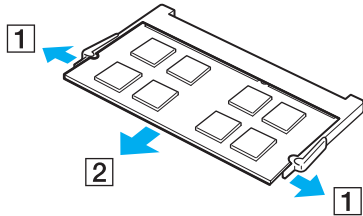

**7** Remove the new memory module from its packaging.

- 8 Slide the memory module into the memory module slot and push it in until it clicks into place.

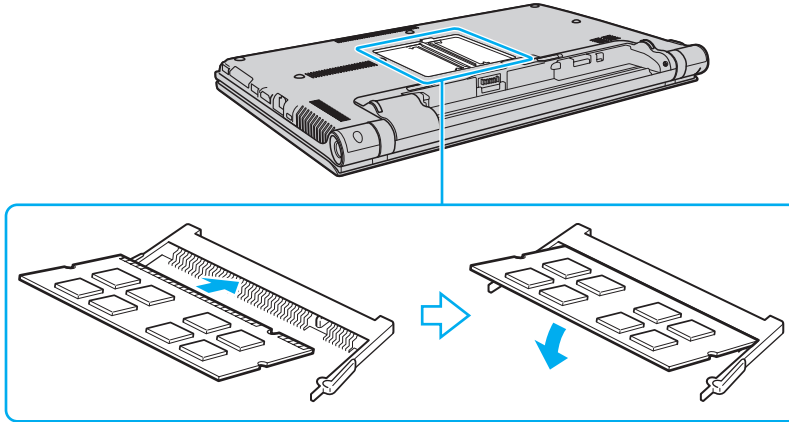

**!** Do not touch any components on the motherboard other than the memory module.

Be sure to insert the connector edge of the memory module into the slot while aligning the notch on the module with the small projection in the open slot. Do not force the memory module into the slot in a wrong orientation, as it may cause damage to the slot and the module.

- 9 Replace the memory module compartment cover.
- 10 Tighten the screw on the bottom of the computer.
- 11 Reinstall the battery pack and turn on the computer.

## Viewing the Amount of Memory

To view the amount of memory

- 1 Turn on the computer.
- 2 Click **Start, All Programs**, and **VAIO Control Center**.
- 3 Click **System Information** and **System Information**.

You can view the amount of system memory in the right pane. If the additional memory does not appear, repeat the installation procedure and restart the computer.

# Precautions

This section describes safety guidelines and precautions to help you protect your VAIO computer from potential damage.

- ❑ **Safety Information** ([page 141](#))
- ❑ **Care and Maintenance Information** ([page 144](#))
- ❑ **Handling Your Computer** ([page 145](#))
- ❑ **Handling the LCD Screen** ([page 147](#))
- ❑ **Using the Power Source** ([page 148](#))
- ❑ **Handling the Built-in Camera** ([page 149](#))
- ❑ **Handling Discs** ([page 150](#))
- ❑ **Using the Battery Pack** ([page 151](#))
- ❑ **Handling "Memory Stick"** ([page 152](#))
- ❑ **Handling the Built-in Storage Device** ([page 153](#))
- ❑ **Using Fingerprint Authentication** ([page 154](#))
- ❑ **Using the TPM** ([page 155](#))

## Safety Information

### Computer

- ❑ Use your computer on a solid, stable surface.
- ❑ Provide adequate air circulation to prevent internal overheating. Do not place your computer on porous surfaces such as rugs, blankets, couches, beds, or near draperies that may block its air vents.
- ❑ Do not use your computer directly on your lap. The temperature of the base of the unit will rise during normal operation and over time could result in discomfort or burns.
- ❑ Use only specified peripheral equipment and interface cables.

### Power Source

- ❑ Do not place the AC adapter in contact with your skin. Remove the AC adapter away from your body if it becomes warm and causes discomfort.
- ❑ Do not place heavy objects on the power cord, or this could cause a fire.
- ❑ To disconnect the cord, pull it out by holding the plug. Never pull the cord itself.
- ❑ Unplug your computer from the AC outlet if you are not planning to use the computer for an extended period of time.
- ❑ When the AC adapter is not used, unplug it from the AC outlet.
- ❑ Make sure that the AC outlet is easily accessible.

## Battery Pack

- ❑ Do not leave battery packs in temperatures above 140°F / 60°C, such as in a car parked in the sun or under direct sunlight.
- ❑ For your safety, Sony recommends using the genuine Sony battery pack and AC adapter provided with this product. If these items need to be replaced during the life of the product, be sure to use a compatible genuine Sony battery pack or AC adapter. Information about compatible models can be found at the following URLs:
  - ❑ For customers in USA  
<http://www.sonystyle.com/vaio/>
  - ❑ For customers in Canada  
<http://www.sonystyle.ca/vaio/>
  - ❑ For customers in Latin American countries or areas  
<http://vaio.sony-latin.com/>
- ❑ Sony disclaims and shall assume no responsibility in case of any losses or damages arising from:
  - ❑ The use of non-genuine Sony battery packs or AC adapters with your VAIO computer.
  - ❑ The disassembly, alteration of, or tampering of any Sony battery pack.
- ❑ Keep the battery pack away from all sources of heat.
- ❑ Keep the battery pack dry.
- ❑ Do not open or try to disassemble the battery pack.
- ❑ Do not expose the battery pack to any mechanical shock, such as dropping it on a hard surface.
- ❑ If you are not using your computer for an extended period of time, remove the battery pack from the computer to prevent damage to the battery pack.
- ❑ If you have not used the battery pack for a considerable amount of time, the remaining battery life may become short. This is normal and does not indicate a malfunction. The battery pack will gradually discharge over time even while not in use. Connect the AC adapter to your computer and recharge the battery pack before using the computer again.

## Headphones

- ❑ **Road safety** – Do not use headphones while driving, cycling, or operating any motorized vehicle. It may create a traffic hazard and is illegal in some areas. It can also be potentially dangerous to play loud music while walking, especially at pedestrian crossings.
- ❑ **Preventing hearing damage** – Avoid using headphones at high volume. Hearing experts advise against continuous, loud and extended play. If you experience a ringing in your ears, reduce the volume or discontinue use.

## "Memory Stick"

Keep "Memory Stick" and "Memory Stick" adaptors out of reach of children. There is a risk of swallowing them.

## Care and Maintenance Information

### Computer

- ❑ Clean the cabinet with a soft, dry or lightly moistened cloth with a mild detergent solution. Do not use an abrasive pad, scouring powder, or solvent such as alcohol or benzine, as these may damage the finish of your computer.
- ❑ Make sure you unplug the AC adapter and remove the battery pack before cleaning your computer.

### LCD Screen

- ❑ Use a soft, dry cloth to wipe the surface of the LCD screen. Rubbing the surface could damage the screen.
- ❑ To protect the LCD screen and keyboard from damage, for example in the case of carrying the computer, spread out the cleaning cloth with no wrinkles on the keyboard before closing the LCD screen lid.

### Built-in Camera

Clean the lens protection cover of the built-in camera with a blower brush or a soft brush. If the cover is extremely dirty, wipe it off with a soft dry cloth. Do not rub the cover, as it is sensitive to pressure.

### Discs

- ❑ Proper care of the disc is essential to its continuous reliability. Do not use solvents (such as benzine, thinner, alcohol, commercially available cleaners, or anti-static spray) which may cause damage to the disc.
- ❑ For normal cleaning, hold the disc by its edges and use a soft cloth to wipe the surface from the center out.
- ❑ If the disc is badly soiled, moisten a soft cloth with water, wring it out well, and use it to wipe the surface of the disc from the center out. Wipe off any remaining moisture with a dry soft cloth.



## Handling Your Computer

- ❑ If you drop a solid object or any liquid onto your computer, shut down the computer, unplug it, and remove the battery pack. You may want to have the computer checked by qualified personnel before operating it again.
- ❑ Do not drop your computer or place any objects on top of the computer.
- ❑ Do not place your computer in a location subject to:
  - ❑ Heat sources, such as radiators or air ducts
  - ❑ Direct sunlight
  - ❑ Excessive dust
  - ❑ Moisture or rain
  - ❑ Mechanical vibration or shock
  - ❑ Strong magnets or speakers that are not magnetically shielded
  - ❑ Ambient temperature of more than 95°F / 35°C or less than 41°F / 5°C
  - ❑ High humidity
- ❑ Do not place electronic equipment near your computer. The electromagnetic field of the equipment may cause the computer to malfunction.
- ❑ Your computer uses high-frequency radio signals and may cause interference to radio or TV reception. If this occurs, relocate the computer a suitable distance away from the set.
- ❑ Do not use cut or damaged connection cables.
- ❑ If your computer is brought directly from a cold location to a warm one, moisture may condense inside the computer. In such a case, allow at least one hour before turning on the computer. If any problems occur, unplug the computer and contact an authorized Sony Service Center. To find the nearest center or agent, see **Finding More about Your VAIO Computer (page 5)**.

- ❑ To avoid losing data when your computer is damaged, back up your data regularly.
- ❑ Do not exert pressure on the LCD screen or its edges when opening the LCD screen lid or lifting your computer. The LCD screen may be sensitive to pressure or added stress, and exerting pressure may damage the screen or cause it to malfunction. To open the computer, hold the base with one hand and gently lift the LCD screen lid with the other. To carry the computer with the lid open, be sure to hold the computer with both hands.

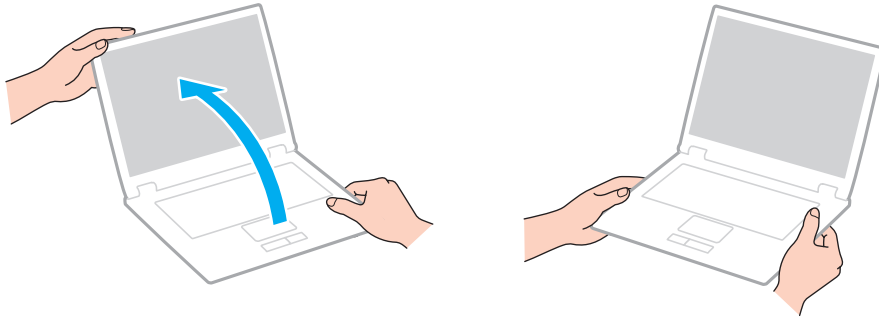

- ❑ Use a carrying case specially designed to carry your computer.

## Handling the LCD Screen

- ❑ Do not leave the LCD screen facing the sun. This could damage the LCD screen. Be sure to block direct sunlight when using your computer near a window.
- ❑ Do not scratch the surface of the LCD screen or exert pressure on it. This could cause a damage.
- ❑ Using your computer in low temperature conditions may produce a residual image on the LCD screen. This is not a malfunction. When the computer returns to normal temperature, the screen returns to normal.
- ❑ A residual image may appear on the LCD screen if the same image is displayed for an extended period of time. The residual image disappears after a while. You can use a screen saver to prevent residual images.
- ❑ The LCD screen becomes warm during operation. This is normal and does not indicate a malfunction.
- ❑ The LCD screen is manufactured using high-precision technology. You may, however, see tiny black points and/or bright points (red, blue, or green) that continuously appear on the LCD screen. This is a normal result of the manufacturing process and does not indicate a malfunction.
- ❑ Do not change the LCD screen orientation setting in the **Tablet PC Settings** window even when there are change options available for selection, as this may make your computer unstable. Sony assumes no liability for any malfunctions arising from changes to the settings.
- ❑ Do not exert pressure on the LCD screen lid with the lid closed as it may scratch the LCD screen or soil it.

## Using the Power Source



See the specifications to find out about the configuration of your computer.

- Do not share the AC outlet with other power-consuming equipment, such as a photocopier or a shredder.
- You can purchase a power strip with a surge protector. This device helps prevent damage to your computer caused by sudden power surges, in an electrical storm, for example.
- Use the AC adapter supplied with your computer or genuine Sony products. Do not use any other AC adapter as it may cause a malfunction.

## Handling the Built-in Camera

- ❑ Do not touch the lens protection cover of the built-in camera, as it may cause scratches on the cover and such scratches will appear on the captured images.
- ❑ Do not let the direct sunlight get into the lens of the built-in camera regardless of your computer's power state, as it may cause the camera to malfunction.

## Handling Discs

- ❑ Fingerprints and dust on the surface of a disc may cause read errors. Be sure to hold the disc by its edges and central hole, as shown below:

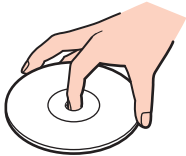

- ❑ Never affix an adhesive label to a disc. This will affect the use of the disc and may result in irreparable damage.

## Using the Battery Pack

- ❑ Battery life is shorter in a cold environment. This is due to decreased battery efficiency at low temperatures.
- ❑ Charge battery packs at temperatures between 50°F / 10°C to 86°F / 30°C. Lower temperatures require longer charging time.
- ❑ Do not charge the battery pack in any way other than as described in this user guide or as designated by Sony in writing.
- ❑ While the battery pack is in use or being charged, heat builds up in the battery pack. This is normal and is not cause for concern.
- ❑ You do not need to discharge the battery pack before recharging.
- ❑ If the battery pack quickly runs out of power after being fully charged, it may be reaching the end of its life and should be replaced.

## Handling "Memory Stick"

- ❑ Do not touch the "Memory Stick" connector with your finger or metallic objects.
- ❑ Use only the adhesive label supplied with "Memory Stick".
- ❑ Do not bend, drop, or expose "Memory Stick".
- ❑ Do not disassemble or modify "Memory Stick".
- ❑ Keep "Memory Stick" dry.
- ❑ Do not use or store "Memory Stick" in a location subject to:
  - ❑ Static electricity
  - ❑ Electrical noise
  - ❑ Extremely high temperatures, such as in a car parked in the sun
  - ❑ Direct sunlight
  - ❑ High humidity
  - ❑ Corrosive substances
- ❑ Use the storage case supplied with "Memory Stick".
- ❑ Be sure to make a backup copy of your valuable data.
- ❑ When using "Memory Stick Duo", do not use a fine-tipped pen to write on the label adhered to "Memory Stick Duo". Exerting pressure on the media may damage internal components.



## Handling the Built-in Storage Device

The built-in storage device (hard disk drive or solid state drive) has a high storage density and reads or writes data in a short time. However, it can be easily damaged if improperly used. If the built-in storage device is damaged, the data cannot be restored. To prevent losing data, you should be careful when handling your computer.



Some features and options in this section may not be available on your computer.

See the specifications to find out about the configuration of your computer.

### To avoid damaging your hard disk drive

- Do not subject your computer to sudden movements.
- Keep your computer away from magnets.
- Do not place your computer in a location subject to mechanical vibration or in an unstable position.
- Do not move your computer while the power is on.
- Do not turn off the power or restart your computer while reading or writing data to the hard disk drive.
- Do not use your computer in a place subject to extreme changes in temperature.
- Do not remove the hard disk drive from your computer.

### To avoid damaging your solid state drive

- Do not turn off the power or restart your computer while reading or writing data to the solid state drive.
- Do not remove the solid state drive from your computer.

## Using Fingerprint Authentication

- ❑ The fingerprint authentication technology does not ensure complete user authentication or complete protection of your data and hardware.  
Sony assumes no liability for any problems and damages arising out of your use of or inability to use the fingerprint sensor.
- ❑ The fingerprint recognition rate depends on your operating conditions and varies among individuals as well.
- ❑ Be sure to make a backup copy of the data stored on the built-in storage device, especially in the encrypted archives created with the **File Safe** feature, before sending your computer for repair.  
Sony assumes no liability for any loss or modification of your data that might have occurred during the course of repair.
- ❑ In case the built-in storage device has to be initialized, for example after the repair work, the fingerprint templates will be lost. You will have to register them all over again.
- ❑ The maintenance and management of data concerning fingerprint authentication must be carried out at your own risk. Sony assumes no liability for any defects arising out of your data maintenance and management.
- ❑ Before disposing of your computer or transferring it to a third person, it is strongly recommended you erase the fingerprint data registered on the fingerprint sensor after erasing the data stored on your built-in storage device. See **Erasing the Registered Fingerprints (page 78)** for the detailed procedure.
- ❑ A fingerprint sensor may malfunction or be damaged if you scratch its surface with:
  - ❑ a solid or sharp-pointed object
  - ❑ fine objects, for example swiping a finger covered with dirt across the fingerprint sensor
- ❑ Discharge static electricity from your finger by touching a metallic object especially during dry seasons (e.g. winter) before scanning your fingerprint. Static electricity may cause the fingerprint sensor to malfunction.

## Using the TPM



Some features and options in this section may not be available on your computer. See the specifications to find out about the configuration of your computer.

- ❑ Although your computer is provided with the TPM security functions, these functions do not ensure complete protection of your data and hardware. Sony assumes no liability for any problems and damages arising out of your use of the functions.
- ❑ After you have installed the **Infineon TPM Professional Package**, you need to set a few TPM passwords on your computer. Without these passwords, you will not be able to restore any TPM-protected data. Be sure to write down the passwords and keep them safe and private from other people.
- ❑ Be sure to make backup copies of the latest emergency recovery archive file, emergency recovery token file, password reset token file, and personal secret file and keep them safe and private from other people before sending your computer for repair. The data stored in the TPM that is embedded on the motherboard may be lost or corrupted during the course of repair.
- ❑ During the course of repair, the TPM will also be replaced if the motherboard needs replacement. In such a case, use the backup copies of the emergency recovery archive file, emergency recovery token file, password reset token file, and personal secret file to restore the TPM configuration.
- ❑ Be sure to make a backup copy of the data stored on the built-in storage device before sending your computer for repair. The built-in storage device may be initialized and returned after the repair work and, in such a case, you will not be able to restore the data on the device using the backup copies of the emergency recovery archive file, emergency recovery token file, password reset token file, and personal secret file.
- ❑ Make sure you set up the automatic backup operations after completing the TPM initialization wizard. If the window containing the **Run automatic backup now** check box is displayed after the setup, select the check box and update the backup files. The restore process using the backup files may fail if you do not set up the automatic backup operations.

- ❑ The maintenance and management of TPM-protected data must be carried out at your own risk. Sony assumes no liability for any defects arising out of your data maintenance and management.

# Troubleshooting

This section describes how to solve common problems you might encounter when using your VAIO computer. Many problems have simple solutions. Try these suggestions before visiting the Sony online support web site at the following URLs:

- ❑ For customers in USA  
<http://esupport.sony.com/EN/VAIO/>
- ❑ For customers in Canada  
<http://sony.ca/support/>
- ❑ For customers in Spanish-speaking Latin American countries or areas  
<http://esupport.sony.com/ES/VAIO/LA>
- ❑ For customers in Brazil  
<http://esupport.sony.com/PT/VAIO/BR/>



Some features and options in this section may not be available on your computer.

- ❑ **Computer Operations (page 159)**
- ❑ **System Update / Security (page 165)**
- ❑ **Recovery (page 167)**
- ❑ **Battery Pack (page 169)**
- ❑ **Built-in Camera (page 172)**
- ❑ **Networking (LAN/Wireless LAN) (page 174)**
- ❑ **Bluetooth Technology (page 177)**
- ❑ **Optical Discs (page 181)**



- ❑ **Display** ([page 186](#))
- ❑ **Printing** ([page 190](#))
- ❑ **Microphone** ([page 191](#))
- ❑ **Speakers** ([page 192](#))
- ❑ **Touch Pad** ([page 194](#))
- ❑ **Keyboard** ([page 195](#))
- ❑ **Floppy Disks** ([page 196](#))
- ❑ **Audio/Video** ([page 197](#))
- ❑ **"Memory Stick"** ([page 199](#))
- ❑ **Peripherals** ([page 200](#))
- ❑ **Port Replicator** ([page 201](#))

## Computer Operations

### What should I do if my computer does not start?

- ❑ Make sure your computer is securely plugged into a power source and turned on and the power indicator light is lit.
- ❑ Make sure the battery pack is installed properly and charged.
- ❑ Disconnect all connected USB devices (if any), and then restart your computer.
- ❑ Remove any extra memory modules you may have installed since purchase, and then restart your computer.
- ❑ If your computer is plugged into a power strip or an uninterruptible power supply (UPS), make sure the power strip or UPS is plugged into a power source and turned on.
- ❑ If you are using an external display, make sure it is plugged into a power source and turned on. Make sure the brightness and contrast controls are adjusted correctly. See the manual that came with your display for more information.
- ❑ Unplug the AC adapter and remove the battery pack. Wait three to five minutes. Reinstall the battery pack, plug the AC adapter, and then press the power button to turn on your computer.
- ❑ Condensation may cause your computer to malfunction. If this occurs, do not use the computer for at least one hour.
- ❑ Check that you are using the supplied Sony AC adapter. For your safety, use only the genuine Sony rechargeable battery pack and AC adapter, which are supplied by Sony for your VAIO computer.

## What should I do if the green power indicator light turns on but my screen remains blank?

- ❑ Press the **Alt+F4** keys several times to close the application window. An application error may have occurred.
- ❑ If the **Alt+F4** keys do not work, click **Start**, the arrow next to the **Shut down** button, and **Restart** to restart your computer.
- ❑ If your computer does not restart, press the **Ctrl+Alt+Delete** keys and click the arrow  next to the **Shut down**  button and **Restart**.  
If the **Windows Security** window appears, click **Restart**.
- ❑ If this procedure does not work, press and hold the power button for more than four seconds to shut down your computer. Unplug the AC adapter and leave the computer for about five minutes. Then plug the AC adapter and turn on the computer again.

**!**  
Turning off your computer with the **Ctrl+Alt+Delete** keys or the power button may cause loss of unsaved data.



## What should I do if my computer or software stops responding?

- ❑ If your computer stops responding while a software application is running, press the **Alt+F4** keys to close the application window.
- ❑ If the **Alt+F4** keys do not work, click **Start** and the **Shut down** button to turn off your computer.
- ❑ If your computer does not turn off, press the **Ctrl+Alt+Delete** keys and click the **Shut down** button. If the **Windows Security** window appears, click **Shut Down**.
- ❑ If this procedure does not work, press and hold the power button until the computer turns off.  
**!**  
Turning off your computer with the **Ctrl+Alt+Delete** keys or the power button may cause loss of unsaved data.
- ❑ Unplug the AC adapter and remove the battery pack. Wait three to five minutes. Reinstall the battery pack, plug the AC adapter, and then press the power button to turn on your computer.
- ❑ Try reinstalling the software.
- ❑ Contact the software publisher or designated provider for technical support.

## Why doesn't my computer enter Sleep or Hibernate mode?

Your computer may become unstable if the operating mode is changed before the computer completely enters Sleep or Hibernate mode.

To restore your computer to Normal mode

- 1 Close all open programs.
- 2 Click **Start**, the arrow next to the **Shut down** button, and **Restart**.
- 3 If your computer does not restart, press the **Ctrl+Alt+Delete** keys and click the arrow next to the **Shut down** button and **Restart**.  
If the **Windows Security** window appears, click **Restart**.
- 4 If this procedure does not work, press and hold the power button until the computer turns off.

**!**  
Turning off your computer with the **Ctrl+Alt+Delete** keys or the power button may cause loss of unsaved data.

## What should I do if the charge indicator light is blinking fast and my computer does not start?

- ❑ This problem could be due to the battery pack not being installed properly. To solve this problem, turn off your computer and remove the battery pack. Then reinstall the battery pack to the computer. For details, see **Installing/Removing the Battery Pack (page 21)**.
- ❑ If the problem persists, it means the installed battery pack is not compatible. Remove the battery pack and contact an authorized Sony Service Center. To find the nearest center or agent, see **Finding More about Your VAIO Computer (page 5)**.

## Why does the System Properties window display a slower CPU speed than the maximum?

This is normal. Because your computer's CPU utilizes a type of CPU speed controlling technology for power conservation purposes, System Properties may display the current CPU speed instead of the maximum speed.

## What should I do if my computer does not accept my password and returns a message, Enter Onetime Password?

If you enter a wrong power-on password three times consecutively, the **Enter Onetime Password** message appears and Windows will not start. Press and hold the power button for more than four seconds to check that the power indicator light turns off. Wait for 10 to 15 seconds, then restart your computer and enter the correct password. The password is case sensitive, so be sure to check letters for the current case before you enter the password.

## What should I do if my game software does not work or it keeps crashing?

- Check the web site of the game if there are any patches or updates to download.
- Make sure you have installed the latest video driver software.
- On some VAIO models, the graphics memory is shared with the system. The optimal graphic performance in such a case is not guaranteed.

## Why doesn't my screen turn off after the automatic turn-off time has passed?

Some software applications or screen savers are designed to temporarily disable the feature of your operating system that turns off the computer screen or places the computer into Sleep mode after a certain period of inactivity. To solve this problem, exit the running software application(s) or change the current screen saver.

## How can I change the boot device order?

You can use one of the BIOS functions to change the boot device order. Follow these steps:

- 1 Turn on your computer.
- 2 Press the **F2** key when the VAIO logo appears.  
The BIOS setup screen appears. If the screen does not appear, restart the computer and press the **F2** key several times when the VAIO logo appears.
- 3 Press the **←** or **→** key to select **Boot**.
- 4 Press the **↑** or **↓** key to select the drive whose boot device order you want to change.
- 5 Press the **F5** or **F6** key to change the boot device order.
- 6 Press the **←** or **→** key to select **Exit**, select **Exit Setup**, and then press the **Enter** key.  
At the confirmation prompt, press the **Enter** key.

## What should I do if I cannot boot my computer from the USB floppy disk drive connected to the computer?

To boot your computer from the USB floppy disk drive, you need to change the boot device.

Turn on your computer and press the **F11** key when the VAIO logo appears.

## System Update / Security

### How can I find important updates for my computer?

You can find and install the latest updates on your computer with the software applications: the **Windows Update** and the **VAIO Update**. See **Updating Your Computer (page 31)** for more information.

### How can I protect my computer against security threats, such as viruses?

The Microsoft Windows operating system is preinstalled on your computer. The best way to protect your computer against security threats, such as viruses, is to download and install the latest Windows updates regularly.

You can get important Windows updates by doing the following:



Your computer must be connected to the Internet to download the updates.

- 1 Click **Start** and **Control Panel**.
- 2 Click **System and Security**.
- 3 Click **Action Center**.
- 4 Follow the on-screen instructions to set up automatic or scheduled updates.

## How do I keep my antivirus software updated?

You can keep the **Norton Internet Security** software program current with the latest updates from Symantec Corporation.

To download and install the latest security updates, follow these steps:



Your computer must be connected to the Internet to download the updates.

- 1 Click **Start, All Programs, Norton Internet Security, and LiveUpdate**.
- 2 Follow the on-screen instructions to complete the updates.

## Recovery

### How can I create recovery discs?

You can create recovery discs using the **VAIO Recovery Center**. The discs are used to restore your computer system to its factory default settings. For information on the **VAIO Recovery Center**, click **VAIO Recovery Center User Guide** under **Use my VAIO** in **Help and Support (page 5)**.

! If your computer is not equipped with a built-in optical disc drive, you need to connect an external optical disc drive (not supplied).

### How can I restore my computer system to its factory default settings?

There are two ways to recover your computer system: from recovery discs and from a recovery partition.

See the **VAIO Recovery Center User Guide** for more information. To access the **VAIO Recovery Center User Guide**, click **VAIO Recovery Center User Guide** under **Use my VAIO** in **Help and Support (page 5)**.

### How can I reinstall the original software and drivers?

You can restore the preinstalled software and drivers using the **VAIO Recovery Center**. For information on the **VAIO Recovery Center**, click **VAIO Recovery Center User Guide** under **Use my VAIO** in **Help and Support (page 5)**.

### How do I check the volume of the recovery partition?

Your built-in storage device contains the recovery partition where the data for the system recovery is stored. To check the volume of the recovery partition, follow these steps:

- 1 Click **Start**, right-click **Computer**, and select **Manage**.
- 2 Click **Disk Management** under **Storage** in the left pane.  
The volume of the recovery partition and the total volume of the C drive are displayed in the **Disk 0** row in the center pane.

## How do I reduce the volume of the recovery partition?

Your built-in storage device contains the recovery partition where the data for the system recovery is stored. If your computer includes a solid state drive, you might want to reduce the volume of the recovery partition by following these steps:

- 1 Insert a recovery disc into the optical disc drive while your computer is on, turn off the computer, and then turn it on once again.

! Use recovery disc(s) you created upon delivery of your computer.

- 2 Select your keyboard layout from the drop-down list and click **Next**.
- 3 Select your operating system and click **Next**.
- 4 Click **VAIO Recovery Center**.
- 5 Click **Restore Complete System** and **Start**.
- 6 Select **Skip** and click **Next**.  
You will be prompted to select whether or not to keep the VAIO Value-added content.
- 7 Select **No** and click **Next**.
- 8 Follow the on-screen instructions.

! The above procedure involves system recovery. The applications and data you added on the storage drive before reducing the volume of the recovery partition will all be lost.

Once you have reduced the volume of the recovery partition, you need the recovery disc(s) for later system recovery.



## Battery Pack

### How do I find the battery charging status?

You can check the charge indicator for the battery charging status. See **Charging the Battery Pack (page 25)** for more information.

### When is my computer using AC power?

When your computer is connected to an AC outlet with the AC adapter, it uses AC power, even if the battery pack is installed.

### When should I recharge the battery pack?

Recharge the battery pack when:

- The battery pack is running out of power and both the charge and power indicator lights blink.
- You have not used the battery pack for an extended period of time.

### When should I replace the battery pack?

A message prompting you to replace the battery pack appears when the battery pack reaches the end of its life. You can check the battery charge capacity with the **Battery** function on the **VAIO Control Center**.

### Should I be concerned that the installed battery pack is warm?

No, it is normal for the battery pack to be warm while it is powering your computer.

## Can my computer enter Hibernate mode while running on battery power?

Your computer can enter Hibernate mode while running on battery power, but some software programs and peripheral devices prevent the system from entering Hibernate mode. If you are using a program that prevents the system from entering Hibernate mode, save your data frequently to avoid losing data. See **Using Hibernate Mode (page 30)** for information on how you can manually activate Hibernate mode.

## How can I conserve battery power when my computer is in Sleep mode?

The wake function of the LAN controller on your computer is enabled at the time of delivery. To conserve battery power when the computer is in Sleep mode, you need to disable this function. Follow these steps:

- 1 Click **Start**, **Control Panel**, **Hardware and Sound**, and **Device Manager**.
- 2 Double-click the network adapters and **Gigabit Network Connection**.
- 3 Click the tab for the power management settings and cancel the check box that allows the device to wake the computer.
- 4 Click **OK**.

## Why can't I fully charge my battery pack?

The battery care function is enabled to extend the life of your battery pack on the **VAIO Control Center**. Check the settings on the **VAIO Control Center**.

## What should I do if a message appears notifying of either incompatibility or the improper installation of the battery pack and my computer then enters Hibernate mode?

- ❑ This problem could be due to the battery pack not being installed properly. To solve this problem, turn off your computer and remove the battery pack. Then reinstall the battery pack to the computer. For details, see **Installing/Removing the Battery Pack (page 21)**.
- ❑ If the problem persists, it means the installed battery pack is not compatible. Remove the battery pack and contact an authorized Sony Service Center. To find the nearest center or agent, see **Finding More about Your VAIO Computer (page 5)**.

## Built-in Camera

### Why does the viewfinder show no images or poor-quality images?

- The built-in camera cannot be shared by more than one software application. Exit the current application before launching another.
- The viewfinder may show some noise, for example horizontal streaks, when you are viewing a rapid-moving object. This is normal and does not indicate a malfunction.
- If the problem persists, restart your computer.

### Why are captured images poor in quality?

- The images captured under the fluorescent light may show reflections of light.
- A dark portion in captured images may appear as a noise.
- If the lens protection cover is dirty, you cannot take a clear shot. Clean the cover. See **Built-in Camera (page 144)**.

### What should I do if captured images contain dropped frames and audio interruptions?

- The effect settings on your software application may cause dropped frames. See the help file included with your software application for more information.
- There may be more software applications running than your computer can handle. Exit the applications that you are not currently using.
- The power management function of your computer may be active. Check the CPU performance.

## What should I do if movie playback shows dropped frames while my computer is running on battery power?

The battery pack is running out of power. Connect your computer to an AC outlet.

## What should I do if captured images flicker?

This problem occurs when you use the camera under fluorescent lights due to a mismatch between the lighting output frequency and the shutter speed.

To reduce flicker noise, change the direction of the camera or the brightness of camera images. In some software applications, you can set an appropriate value to one of the camera properties (e.g. light source, flicker, etc.) to eliminate flicker noise.

## Why is the video input from the built-in camera suspended for a few seconds?

The video input may be suspended for a few seconds if:

- a shortcut key with the **Fn** key is used.
- the CPU load increases.

This is normal and does not indicate a malfunction.

## What should I do if my computer becomes unstable when it enters a power saving mode while the built-in camera is in use?

If your computer automatically enters Sleep or Hibernate mode, change the corresponding power saving mode setting. To change the setting, see **Using the Power Saving Modes (page 29)**.

## Networking (LAN/Wireless LAN)

### What should I do if my computer cannot connect to a wireless LAN access point?

- ❑ Connection capability is affected by distance and obstructions. You may need to move your computer away from obstructions or closer to any access point you may be using.
- ❑ Make sure the **WIRELESS** switch is on and the **WIRELESS** indicator light is lit on your computer.
- ❑ Make sure power to the access point is on.
- ❑ Follow these steps to check the settings:
  - 1 Click **Start** and **Control Panel**.
  - 2 Click **View network status and tasks** under **Network and Internet**.
  - 3 Click **Connect to a network** to confirm that your access point is selected.
- ❑ Make sure the encryption key is correct.
- ❑ Make sure **Maximum Performance** is selected for **Wireless Adapter Settings** in the **Power Options** window. Selecting any other option may result in a communication failure. To change the settings, follow these steps:
  - 1 Right-click the power status icon on the taskbar and select **Power Options**.
  - 2 Click **Change plan settings**.
  - 3 Click **Change advanced power settings**.
  - 4 Select the **Advanced settings** tab.
  - 5 Double-click **Wireless Adapter Settings** and **Power Saving Mode**.
  - 6 Select **Maximum Performance** from the drop-down list both for **On battery** and **Plugged in**.

## What should I do if I cannot access the Internet?

- ❑ Check the access point settings. See the manual that came with your access point for more information.
- ❑ Make sure your computer and the access point are connected to one another.
- ❑ Move your computer away from obstacles or closer to any access point you may be using.
- ❑ Make sure your computer is properly configured for Internet access.
- ❑ Make sure **Maximum Performance** is selected for **Wireless Adapter Settings** in the **Power Options** window. Selecting any other option may result in a communication failure. Follow the steps in **What should I do if my computer cannot connect to a wireless LAN access point? (page 174)** to change the settings.

## Why is the data transfer speed slow?

- ❑ The wireless LAN data transfer speed is affected by distance and obstructions between devices and access points. Other factors include device configurations, radio conditions, and software compatibility. To maximize the data transfer speed, move your computer away from obstacles or closer to any access point you may be using.
- ❑ If you are using a wireless LAN access point, the device may be temporarily overloaded depending on how many other devices are communicating via the access point.
- ❑ If your access point interferes with other access points, change the access point channel. See the manual that came with your access point for more information.
- ❑ Make sure **Maximum Performance** is selected for **Wireless Adapter Settings** in the **Power Options** window. Selecting any other option may result in a communication failure. Follow the steps in **What should I do if my computer cannot connect to a wireless LAN access point? (page 174)** to change the settings.

## How do I avoid data transfer interruptions?

- While your computer is connected to an access point, data transfer interruptions may occur if a large file is exchanged or the computer is placed in close proximity to microwaves and cordless telephones.
- Move your computer closer to the access point.
- Make sure the access point connection is intact.
- Change the access point channel. See the manual that came with your access point for more information.
- Make sure **Maximum Performance** is selected for **Wireless Adapter Settings** in the **Power Options** window. Selecting any other option may result in a communication failure. Follow the steps in **What should I do if my computer cannot connect to a wireless LAN access point? (page 174)** to change the settings.

## What are channels?

- Wireless LAN communication uses divided frequency bands known as channels. Third-party wireless LAN access point channels may be preset to different channels from Sony devices.
- If you are using a wireless LAN access point, see connectivity information contained in the manual that came with your access point.

## Why does the network connection stop when I change the encryption key?

Two computers with the wireless LAN function may lose a peer-to-peer network connection if the encryption key is changed. You can either change the encryption key back to the original profile or re-enter the key on both computers so the key matches.



## Bluetooth Technology

### What should I do if other Bluetooth devices cannot find my computer?

- ❑ Make sure both devices have the Bluetooth function enabled.
- ❑ Make sure the **WIRELESS** switch is on and the **WIRELESS** indicator light is lit on your computer.
- ❑ You cannot use the Bluetooth function while your computer is in a power saving mode. Bring the computer back to Normal mode, then turn on the **WIRELESS** switch.
- ❑ Your computer and the device may be too far apart. Wireless Bluetooth technology works best when the devices are within 33 feet / 10 meters of each other.

### What should I do if I cannot find the Bluetooth device I want to communicate with?

- ❑ Check that the Bluetooth function of the device you want to communicate with is on. See the other device's manual for more information.
- ❑ If the device you want to communicate with is already communicating with another Bluetooth device, it may not be found or it may not be able to communicate with your computer.
- ❑ To allow other Bluetooth devices to communicate with your computer, follow these steps:
  - 1 Click **Start** and **Devices and Printers**.
  - 2 Right-click the Bluetooth device icon and click **Bluetooth settings**.
  - 3 Click the **Options** tab and select the **Allow Bluetooth devices to find this computer** check box.

## What should I do if other Bluetooth devices cannot connect to my computer?

- Check the suggestions in **What should I do if I cannot find the Bluetooth device I want to communicate with?** (page 177).
- Make sure the other devices are authenticated.
- The data transfer distance can be shorter than 33 feet / 10 meters depending on existing obstacles between the two devices, on radio wave quality, and on the operating system or the software in use. Move your computer and Bluetooth devices closer to each other.

## Why is my Bluetooth connection slow?

- The data transfer speed depends on the obstructions and/or the distance between the two devices, on the radio wave quality, and on the operating system or the software in use. Move your computer and Bluetooth devices closer to each other.
- The 2.4 GHz radio frequency used by Bluetooth and wireless LAN devices is also used by other devices. Bluetooth devices incorporate technology that minimizes interference from other devices using the same wavelength, however, communication speed and connection range may be reduced. Interference from other devices may also stop communications altogether.
- Connection capability is affected by distance and obstructions. You may need to move your computer away from obstacles or closer to the device to which it is connected.
- Identify and remove obstacles between your computer and the device to which it is connected.

## Why can't I use the services supported by the connected Bluetooth device?

Connection is only possible for services also supported by the computer with the Bluetooth function. For more details, search **Windows Help and Support** for Bluetooth information.

## Can I use a device with Bluetooth technology on airplanes?

With Bluetooth technology, your computer transmits a radio frequency of 2.4 GHz. Sensitive locations, such as hospitals and airplanes, may have restrictions on use of Bluetooth devices to avoid radio interference. Check with facility staff to see if use of the Bluetooth function on the computer is permitted.

## Why can't I use the Bluetooth function when I log onto my computer as a user with a standard user account?

The Bluetooth function may not be available to a user with a standard user account on your computer. Log onto the computer as a user with administrative rights.

## Why can't I use the Bluetooth devices when I switch users?

If you switch users without logging off your system, the Bluetooth devices will not work. Be sure to log off before switching users. To log off your system, click **Start**, the arrow next to the **Shut down** button, and **Log off**.

## Why can't I exchange business card data with a mobile phone?

The business card exchange function is not supported.

## What should I do if I do not hear sound from my headphones or audio/video controller?

Check the SCMS-T settings. If your headphones or audio/video controller does not support SCMS-T content protection, you need to connect the device using the Advanced Audio Distribution Profile (A2DP). Follow these steps:

- 1 Click **Start** and **Devices and Printers**.
- 2 Right-click the icon for the device that you want to connect using the A2DP and select **Control**.
- 3 Click **SCMS-T Settings**.
- 4 Click to cancel the **Connect to a device only if it supports SCMS-T content protection** check box.

## Optical Discs

### Why does my computer freeze when I try to read a disc?

The disc that your computer is trying to read may be dirty or damaged. Follow these steps:

- 1 Press the **Ctrl+Alt+Delete** keys and click the arrow next to the **Shut down** button and **Restart** to restart the computer.



Turning off your computer with the **Ctrl+Alt+Delete** keys may cause loss of unsaved data.

- 2 Remove the disc from the optical disc drive.
- 3 Check the disc for dirt or damage. If you need to clean the disc, see **Discs (page 144)** for instructions.

### What should I do if the drive tray does not open?

- Make sure your computer is on.
- Press the drive eject button.
- If the drive eject button does not work, click **Start** and **Computer**, right-click the optical disc drive icon, and select **Eject**.
- If none of the above options work, insert a thin, straight object (such as a paper clip) into the manual eject hole on the optical disc drive.
- Try restarting your computer.

## What should I do if I cannot play a disc properly on my computer?

- Make sure the disc is inserted into the optical disc drive with the label facing upward.
- Make sure the necessary program(s) is installed according to the manufacturer's instructions.
- Blu-ray Disc playback on a connected external display may be interrupted, depending on the type or bit rate of the video. You may be able to solve this problem by lowering the screen resolution of the display. Follow the steps in **Why doesn't my screen display a video? (page 188)** to change the screen resolution.
- If a disc is dirty or damaged, your computer will stop responding. Follow these steps:
  - 1** Press the **Ctrl+Alt+Delete** keys and click the arrow next to the **Shut down** button and **Restart** to restart the computer.  
**!**  
Turning off your computer with the **Ctrl+Alt+Delete** keys may cause loss of unsaved data.
  - 2** Remove the disc from the optical disc drive.
  - 3** Check the disc for dirt or damage. If you need to clean the disc, see **Discs (page 144)** for instructions.
- If you are playing a disc and cannot hear sound, do any of the following:
  - The volume may have been turned off by the **Fn+F2** keys. Press them once again.
  - The volume may have been minimized by the **Fn+F3** keys. Keep pressing the **Fn+F4** keys to turn up the volume loud enough to hear sound.
  - Right-click the volume icon on the taskbar and click **Open Volume Mixer** to check the settings.
  - Check the volume setting in the audio mixer.
  - If you are using external speakers, check the volume settings on the speakers and the connections between the speakers and your computer.

- Make sure the correct driver software is installed. Follow these steps:
  - 1 Click **Start** and **Control Panel**.
  - 2 Click **System and Security**.
  - 3 Click **System**.
  - 4 Click **Device Manager** in the left pane.

The **Device Manager** window appears with a listing of your computer's hardware devices. If an "X" or an exclamation point appears on the listed device, you may need to enable the device or reinstall the driver software.
  - 5 Double-click the optical disc drive device to open a list of the optical disc drives of your computer.
  - 6 Double-click your desired drive.

You can confirm the driver software by selecting the **Driver** tab, and clicking **Driver Details**.
  - 7 Click **OK** to close the window.
- Make sure an adhesive label is not affixed to a disc. Adhesive labels can come off while the disc is in the optical disc drive and damage the drive or cause it to malfunction.
- If a region code warning appears, the disc may be incompatible with the optical disc drive. Check the package to make sure the region code is compatible with the optical disc drive.
- If you notice condensation on your computer, do not use the computer for at least one hour. Condensation can cause the computer to malfunction.
- Make sure your computer is running on AC power and try the disc again.

## What should I do if I cannot play Blu-ray Disc media or my computer becomes unstable during Blu-ray Disc playback?

- Check if your optical disc drive supports the Blu-ray Disc media.
- You may not be able to play some Blu-ray Disc content on your computer, or the computer may become unstable during Blu-ray Disc playback. To play content normally, download and install the latest updates for the **WinDVD BD** using the **VAIO Update**.  
For information on how to use the **VAIO Update**, see **Updating Your Computer (page 31)**.

## What should I do if I cannot write data to CD media?

- Make sure you neither launch any software application nor allow any to launch automatically, not even a screen saver.
- If you are using a CD-R/RW disc with an adhesive label affixed, replace it with one with no affixed adhesive label. Using a disc with an affixed adhesive label could cause a write error or other damage.

## What should I do if I cannot write data to DVD media?

- Make sure you are using the correct DVD recordable media.
- Check which DVD recordable format is compatible with your optical disc drive. Some brands of DVD recordable media do not work.

## Why can't I write data to Blu-ray Disc media?

- Check if your optical disc drive supports the Blu-ray Disc writing function.
- BD-R Disc media are not rewritable. You cannot add or erase data to or from the BD-R Disc media.



## What should I do if my external optical disc drive does not work properly?

Make sure that your external optical disc drive is connected to an AC power source and the USB port on your computer. If it is not connected, the external optical disc drive may not work properly.

## Display

### Why did my screen go blank?

- ❑ Your computer screen may go blank if the computer loses power or enters a power saving mode (Sleep or Hibernate). If the computer is in LCD (Video) Sleep mode, press any key to bring the computer back into Normal mode. See **Using the Power Saving Modes (page 29)** for more information.
- ❑ Make sure your computer is securely plugged into a power source and turned on and the power indicator light is lit.
- ❑ If your computer is running on battery power, make sure the battery pack is installed properly and is charged. See **Using the Battery Pack (page 21)** for more information.
- ❑ If the display output is directed to the external display, press the **Fn+F7** keys. See **Combinations and Functions with the Fn Key (page 33)** for more information.
- ❑ While a performance selection is in progress, your computer screen becomes dark and may temporarily show some noise or flicker. This is normal and does not indicate a malfunction.

## What should I do if I do not see proper images or videos?

- ❑ Be sure to select **True Color (32 bit)** for the display colors before using video/image software or starting DVD playback. Selecting any other option may prevent such software from displaying images successfully. To change the display colors, follow these steps:
  - 1 Right-click on the desktop and select **Screen resolution**.
  - 2 Click **Advanced settings**.
  - 3 Click the **Monitor** tab.
  - 4 Select **True Color (32 bit)** under **Colors**.
- ❑ Do not change the display resolution or colors while using video/image software or playing DVDs, as it may cause unsuccessful playback/display or unstable system operations. Additionally, it is recommended you disable your screen saver before starting DVD playback. If the screen saver is enabled, it may be activated during DVD playback and prevent the playback from running successfully. Some screen savers have been found to even change the display resolution and colors.

## What should I do if no image is displayed on my TV screen or external display connected to the HDMI output port?

- ❑ Make sure you are using an HDCP-compliant display. The copyright protected content is not displayed on a non-HDCP compliant display. See **Connecting a Computer Display or a Projector (page 107)** for more information.
- ❑ When you use the **HDMI** output port on your computer, select the **SPEED** or **AUTO** mode with the performance selector switch before connecting an external device to the **HDMI** output port. See **Selecting Performance Modes (page 120)** for mode selection.
- ❑ Another external display may be connected to the monitor port on your computer. Press the **Fn+F7** keys to change the display output. See **Connecting a TV with an HDMI Input Port (page 110)** or **Connecting a Computer Display or a Projector (page 107)** for more information.

## Why doesn't my screen display a video?

- ❑ If the display output is directed to the external display and the external display is disconnected, you cannot display a video on your computer screen. Stop video playback, change the display output to the computer screen, and then restart video playback. See **Selecting Display Modes (page 113)** for changing the display output. Alternatively, you can press the **Fn+F7** keys to change the display output. See **Combinations and Functions with the Fn Key (page 33)** for more information.
- ❑ The video memory of your computer may be insufficient for displaying high resolution videos. In such a case, lower the resolution of the LCD screen.

To change the screen resolution, follow these steps:

- 1 Right-click on the desktop and select **Screen resolution**.
- 2 Click the drop-down list next to **Resolution**.
- 3 Move the slider up to increase or down to decrease the screen resolution.



You can check the total amount of the graphics and video memory available. Right-click on the desktop, select **Screen resolution**, and click **Advanced Settings** and the **Adapter** tab. The displayed value may be different from the actual amount of memory on your computer.

## What should I do if my screen is dark?

- ❑ Press the **Fn+F6** keys to brighten your computer screen.
- ❑ Blocking the ambient light sensor turns your screen dark. Make sure that the sensor is unblocked.

## What should I do if the external display remains blank?

Press the **Fn+F7** keys to change the display output. See **Combinations and Functions with the Fn Key (page 33)** for more information.

## How do I run Windows Aero?

To run Windows Aero, follow these steps:

- 1 Right-click on the desktop and select **Personalize**.
- 2 Select your desired theme from **Aero Themes**.

For information about the Windows Aero features, such as Windows Flip 3D, see **Windows Help and Support**.

# Printing

## What should I do if I cannot print a document?

- ❑ Make sure your printer is on, and the printer cable is securely connected to the ports on the printer and your computer.
- ❑ Make sure your printer is compatible with the Windows operating system installed on your computer.
- ❑ You may need to install the printer driver software before you use your printer. See the manual that came with your printer for more information.
- ❑ If your printer is not functioning after your computer resumes from a power saving mode (Sleep or Hibernate), then restart the computer.
- ❑ If the bidirectional communication functions are provided with your printer, disabling the functions on your computer may enable printing. Follow these steps:
  - 1 Click **Start** and **Devices and Printers**.
  - 2 Right-click the printer icon and select **Properties**.
  - 3 Click the **Ports** tab.
  - 4 Click to cancel the **Enable bidirectional support** check box.
  - 5 Click **OK**.

This disables the bidirectional communication functions of the printer, such as data transfer, status monitoring, and remote panel.

When your printer is connected to the optional port replicator, check to see if the port replicator is connected to an AC power source.

## Microphone

### What should I do if my microphone does not work?

- ❑ If you are using an external microphone, make sure the microphone is turned on and is properly plugged into the microphone jack on your computer.
- ❑ Your sound input device may have been incorrectly configured. To configure the sound input device, follow these steps:
  - 1 Close all open programs.
  - 2 Click **Start** and **Control Panel**.
  - 3 Click **Hardware and Sound**.
  - 4 Click **Manage audio devices** under **Sound**.
  - 5 On the **Recording** tab, select your desired device for sound input and click **Set Default**.

### How can I prevent microphone feedback?

Microphone feedback occurs when the microphone receives the sound from a sound output device, such as a speaker.

To prevent this problem:

- ❑ Keep the microphone away from a sound output device.
- ❑ Turn down the volume of the speakers and the microphone.

## Speakers

### What should I do if I do not hear sound from the built-in speakers?

- ❑ If you are using a program that has its own volume control, make sure the volume control is properly set. See the program's help file for more information.
- ❑ The volume may have been turned off by the **Fn+F2** keys. Press them once again.
- ❑ The volume may have been minimized by the **Fn+F3** keys. Keep pressing the **Fn+F4** keys to turn up the volume loud enough to hear sound.
- ❑ Check the Windows volume controls by clicking the volume icon on the taskbar.
- ❑ Your sound output device may have been incorrectly configured. To change the sound output device, see **How do I change the sound output device? (page 197)**.



## What should I do if my external speakers do not work?

- ❑ Check the suggestions in **What should I do if I do not hear sound from the built-in speakers? (page 192)**.
- ❑ If you are using a program that has its own volume control, make sure the volume control is properly set. See the program's help file for more information.
- ❑ Make sure your speakers are properly connected and the volume is turned up loud enough to hear sound.
- ❑ Make sure your speakers are designed for computer use.
- ❑ If your speakers have a muting button, set the button to off.
- ❑ If your speakers require external power, make sure the speakers are connected to a power source. See the manual that came with your speakers for more information.
- ❑ Check the Windows volume controls by clicking the volume icon on the taskbar.
- ❑ Your sound output device may have been incorrectly configured. To change the sound output device, see **How do I change the sound output device? (page 197)**.

## Touch Pad

### What should I do if the touch pad does not work?

- ❑ You may have disabled the touch pad before connecting a mouse to your computer. See **Using the Touch Pad (page 36)**.
- ❑ Make sure that a mouse is not connected to your computer.
- ❑ If the pointer does not move while a software application is running, press the **Alt+F4** keys to close the application window.
- ❑ If the **Alt+F4** keys do not work, press the Windows key once and then the **→** key several times, select **Restart** with the **↑** or **↓** key, and press the **Enter** key to restart your computer.
- ❑ If your computer does not restart, press the **Ctrl+Alt+Delete** keys, select the arrow next to the **Shut down** button with the **↓** and **→** keys, press the **Enter** key, select **Restart** with the **↑** or **↓** key, and press the **Enter** key to restart your computer.
- ❑ If this procedure does not work, press and hold the power button until the computer turns off.

! Turning off your computer with the **Ctrl+Alt+Delete** keys or the power button may cause loss of unsaved data.

## Keyboard

### What should I do if the keyboard configuration is wrong?

The language layout of your computer's keyboard is labeled on the packaging box. If you choose a different regional keyboard when you complete the Windows setup, the key configuration will be mismatched.

To change the keyboard configuration, follow these steps:

- 1 Click **Start** and **Control Panel**.
- 2 Click **Clock, Language, and Region**, and then **Change keyboards or other input methods** under **Region and Language**.
- 3 Click **Change keyboards** on the **Keyboards and Languages** tab.
- 4 Change the settings as desired.

### What should I do if I cannot enter certain characters with the keyboard?

If you cannot enter **U, I, O, P, J, K, L, M**, and so on, the **Num Lk** key may be activated. Check that the Num lock indicator light is unlit. If the Num lock indicator is lit, press the **Num Lk** key to turn it off before entering these characters.

## Floppy Disks

### Why doesn't the Safely Remove Hardware and Eject Media icon appear on the taskbar when the drive is connected?

Your computer does not recognize the floppy disk drive. First, make sure the USB cable is properly connected to the USB port. If you need to secure the connection, wait a few moments for the computer to recognize the drive. If the icon still does not appear, follow these steps:

- 1 Close all programs that are accessing the floppy disk drive.
- 2 Wait until the indicator light on the floppy disk drive turns off.
- 3 Push the eject button to remove the disk, and unplug the USB floppy disk drive from your computer.
- 4 Reconnect the floppy disk drive by plugging the USB cable into the USB port.
- 5 Restart the computer by clicking **Start**, the arrow next to the **Shut down** button, and **Restart**.

### What should I do if I cannot write data to a floppy disk?

- Make sure the floppy disk is properly inserted in the drive.
- If the disk is inserted properly and you are still unable to write data to it, the disk may be full or write-protected. You can either use a floppy disk that is not write-protected or disable the write-protect feature.

## Audio/Video

### How do I turn off the Windows startup sound?

To turn off the Windows startup sound, follow these steps:

- 1 Click **Start** and **Control Panel**.
- 2 Click **Hardware and Sound**.
- 3 Click **Manage audio devices** under **Sound**.
- 4 On the **Sounds** tab, click to cancel the **Play Windows Startup sound** check box.
- 5 Click **OK**.

### How do I change the sound output device?

If you do not hear sound from the device connected to a port, such as the USB port, HDMI output port, optical output port, or headphones jack, you need to change the device for sound output.

! When you use the **HDMI** output port on your computer, select the **SPEED** or **AUTO** mode with the performance selector switch. See **Selecting Performance Modes (page 120)** for mode selection.

- 1 Close all open programs.
- 2 Click **Start** and **Control Panel**.
- 3 Click **Hardware and Sound**.
- 4 Click **Manage audio devices** under **Sound**.
- 5 On the **Playback** tab, select your desired device for sound output and click **Set Default**.

## What should I do if I do not hear the sound from the sound output device connected to the HDMI output port, optical output port, or headphones jack?

**!**  
When you use the **HDMI** output port on your computer, select the **SPEED** or **AUTO** mode with the performance selector switch. See **Selecting Performance Modes (page 120)** for mode selection.

- ❑ You need to change the sound output device if you want to hear sound from the device connected to a port, such as the HDMI output port, optical output port, or headphones jack. For the detailed procedure, see **How do I change the sound output device? (page 197)**.
- ❑ If you still hear no sound from the sound output device, follow these steps:
  - 1 Follow steps 1 to 4 in **How do I change the sound output device? (page 197)**.
  - 2 On the **Playback** tab, select the HDMI or S/PDIF icon and click **Properties**.
  - 3 Click the **Advanced** tab.
  - 4 Select the sample rate and bit depth (for example, 48000 Hz, 16 bit) which the device supports.
  - 5 Click **OK**.

## Why do sound interruptions and/or dropped frames occur when I play high-definition videos, such as those recorded with the AVCHD digital video camcorder?

Playing high-definition videos requires substantial hardware resources, such as CPU, GPU, or system memory performance on your computer. During the video playback, some operations and/or functions may become unavailable, and sound interruptions, dropped frames, and playback failure may occur depending on the configuration of your computer.

## "Memory Stick"

### What should I do if I cannot use "Memory Stick" that was formatted on a VAIO computer on other devices?

You may need to reformat your "Memory Stick".

Formatting "Memory Stick" erases all data, including music data previously saved on it. Before you reformat "Memory Stick", back up important data and confirm that "Memory Stick" does not contain files you want to keep.

- 1 Copy the data from "Memory Stick" onto your built-in storage device to save data or images.
- 2 Format "Memory Stick" by following the steps in **Formatting "Memory Stick" (page 50)**.

### Can I copy images from a digital camera using "Memory Stick"?

Yes, and you can view video clips that you have recorded with digital cameras that are compatible with "Memory Stick".

### Why can't I write data to "Memory Stick"?

Some versions of "Memory Stick" are equipped with an erasure prevention switch to protect data from unintentional erasure or overwriting. Make sure the erasure prevention switch is off.

## Peripherals

### What should I do if I cannot connect a USB device?

- ❑ If applicable, check the USB device is turned on and using its own power supply. For example, if you are using a digital camera, check if the battery is charged. If you are using a printer, check if the power cable is connected properly to the AC outlet.
- ❑ Try using another USB port on your computer. The driver software could be installed to the specific port you used the first time you connected the device.
- ❑ See the manual that came with your USB device for more information. You may need to install software before you connect the device.
- ❑ Try connecting a simple, low-powered device such as a mouse to test if the port is working at all.
- ❑ USB hubs may prevent a device from working because of a power distribution failure. We recommend you connect the device directly to your computer without a hub.



## Port Replicator

### Why can't I use my TFT/DVI monitor connected to the DVI-D port?

When you use the **DVI-D** port on the port replicator, select the **SPEED** or **AUTO** mode with the performance selector switch. See **Selecting Performance Modes** ([page 120](#)) for mode selection.

# Trademarks

© 2010 Sony Electronics Inc. All rights reserved. Reproduction in whole or in part without written permission is prohibited.

Sony, the Sony logo, "Memory Stick", "Memory Stick Duo", "MagicGate", "OpenMG", "Memory Stick PRO Duo", "Memory Stick PRO", "Memory Stick PRO-HG Duo", "Memory Stick Micro", "M2", the "Memory Stick" logo, Micro Vault, Micro Vault EX, MOTION EYE, Sony Style, i.LINK, VAIO Care, VAIO Media, Click to BD, G-Sensor, like.no.other, SmartWi, Walkman, and "BRAVIA" are trademarks or registered trademarks of Sony Corporation.

VAIO, the VAIO logo, Backstage, VAIO DIGITAL STUDIO, HDNA, and the HDNA logo are trademarks or registered trademarks of Sony Electronics Inc.

Intel, Centrino, Core, Celeron, Xeon, Pentium, and Atom are trademarks or registered trademarks of Intel Corporation in the United States and/or other countries.

Microsoft, Windows, Windows Media, Windows Mobile, Windows NT, Windows Vista, BitLocker, Outlook, Excel, MS-DOS, PowerPoint, ReadyBoost, Internet Explorer, Aero, Windows Live, and the Windows logo are trademarks or registered trademarks of Microsoft Corporation in the United States and/or other countries.

Blu-ray Disc and the Blu-ray Disc logo are trademarks of the Blu-ray Disc Association.

The Bluetooth word mark and logos are registered trademarks owned by Bluetooth SIG, Inc. and any use of such marks by Sony Corporation is under license. Other trademarks and trade names are those of their respective owners.

SD Logo is a trademark. 

SDHC Logo is a trademark. 

The ExpressCard word mark and logos are owned by the PCMCIA and any use of such marks by Sony Corporation is under license.

HDMI, the HDMI logo and High-Definition Multimedia Interface are trademarks or registered trademarks of HDMI Licensing LLC.

CompactFlash® is a trademark of SanDisk Corporation.

⋄, "XMB," and "xross media bar" are trademarks of Sony Corporation and Sony Computer Entertainment Inc.

"TransferJet" and the "TransferJet" logo are trademarks of Sony Corporation.

AVCHD" is a trademark of Panasonic Corporation and Sony Corporation.

Dolby is a registered trademark of Dolby Laboratories.

Symantec, the Symantec Logo, and Norton Internet Security are trademarks or registered trademarks of Symantec Corporation or its affiliates in the U.S. and other countries.

All other names of systems, products, and services are trademarks of their respective owners. In the manual, the ™ or ® marks may not be specified.

Features and specifications are subject to change without notice.

All other trademarks are trademarks of their respective owners.

Not all the software listed above may be delivered with your model.

# Notice

© 2010 Sony Corporation. All rights reserved.

This manual and the software described herein, in whole or in part, may not be reproduced, translated, or reduced to any machine-readable form without prior written approval.

Sony Corporation provides no warranty with regard to this manual, the software, or other information contained herein and hereby expressly disclaims any implied warranties or merchantability or fitness for any particular purpose with regard to this manual, the software, or such other information. In no event shall Sony Corporation be liable for any incidental, consequential, or special damages, whether based on tort, contract, or otherwise, arising out of or in connection with this manual, the software, or other information contained herein or the use thereof.

In the manual, the ™ or ® marks are not specified.

Sony Corporation reserves the right to make any modification to this manual or the information contained herein at any time without notice. The software described herein is governed by the terms of a separate user license agreement.

Sony Corporation is not liable and will not compensate for any lost recordings made to your computer, external recording media, or recording devices or any relevant losses, including when recordings are not made due to reasons including your computer failure, or when the contents of a recording are lost or damaged as a result of your computer failure or repair undertaken to your computer. Sony Corporation will not restore, recover, or replicate the recorded contents made to your computer, external recording media, or recording devices under any circumstances.

