

**SONY®**

# User Guide

Personal Computer  
VPCZ2 Series



# Contents

Before Use.....	4	Using the Wireless LAN.....	52
Finding More about Your VAIO Computer .....	4	Using the Wireless WAN .....	55
Ergonomic Considerations .....	7	Using the International Roaming Service .....	59
Getting Started.....	10	Using the BLUETOOTH Function.....	59
Locating Controls and Ports.....	10	Using the GPS Function .....	63
About the Indicator Lights .....	16	Using Fingerprint Authentication .....	64
Connecting a Power Source .....	17	Using the TPM.....	67
Using the Battery Pack.....	19	Using Peripheral Devices.....	74
Shutting Down Your Computer Safely .....	24	Using the Noise Canceling Headphones.....	74
Using the Power Saving Modes .....	25	Connecting a Docking Station .....	79
Keeping Your Computer in Optimum Condition .....	26	Connecting External Speakers or Headphones .....	87
Using Your VAIO Computer.....	29	Connecting an External Display .....	88
Using the Keyboard.....	30	Selecting Display Modes .....	91
Using the Touch Pad.....	32	Using the Multiple Monitors Function .....	92
Using Special-function Buttons .....	34	Connecting a USB Device .....	93
Using the Quick Web Access Function .....	35	Customizing Your VAIO Computer.....	96
Using the Built-in Camera .....	37	Setting the Password.....	96
Using the Optical Disc Drive .....	38	Using the VAIO Control Center .....	101
Using "Memory Stick".....	43	Using the VAIO Power Management.....	101
Using Other Modules / Memory Cards.....	47	Precautions .....	103
Using the Internet.....	50	Safety Information .....	103
Using the Network (LAN) .....	51	Care and Maintenance Information .....	105

Handling Your Computer.....	106	Microphone.....	141
Handling the LCD Screen .....	108	Speakers .....	142
Using the Power Source .....	109	Touch Pad .....	143
Handling the Built-in Camera .....	109	Keyboard .....	144
Handling Discs .....	109	Floppy Disks .....	144
Using the Battery Pack.....	110	Audio/Video .....	145
Handling "Memory Stick".....	110	"Memory Stick" .....	147
Handling the Built-in Storage Device .....	111	Peripherals .....	148
Using Fingerprint Authentication .....	112	Docking Station .....	148
Using the TPM .....	112	Trademarks .....	150
Troubleshooting .....	114	Notice .....	153
Computer Operations.....	115		
System Update / Security.....	120		
Recovery / Recovery Media .....	120		
Partition .....	123		
Battery Pack.....	123		
Built-in Camera .....	125		
Networking (LAN/Wireless LAN) .....	127		
Wireless WAN .....	130		
BLUETOOTH Technology.....	131		
Optical Discs .....	134		
GPS.....	137		
Display .....	137		
Printing.....	140		

## Before Use

Congratulations on your purchase of this VAIO® computer and welcome to the on-screen **User Guide**. Sony has combined leading-edge technology in audio, video, computing, and communications to provide you with a state-of-the-art computing experience.

! External views illustrated in this manual may look slightly different from those of your computer.

### How to find specifications

Some features, options, and supplied items may not be available on your computer.

To find out about the configuration of your computer, visit the Sony online support web site at the following URLs:

- ❑ For customers in USA  
<http://esupport.sony.com/EN/VAIO/>
- ❑ For customers in Canada  
<http://www.sony.ca/support/> (English)  
<http://www.fr.sony.ca/support> (French)
- ❑ For customers in Spanish-speaking Latin American countries or areas  
<http://esupport.sony.com/ES/VAIO/LA>
- ❑ For customers in Brazil  
<http://esupport.sony.com/PT/VAIO/BR/>

## Finding More about Your VAIO Computer

This section provides support information about your VAIO computer.

## 1. Printed Documentation

- ❑ **Quick Start Guide** — An overview of components connection, set-up information, etc.
- ❑ **Recovery, Backup and Troubleshooting Guide**
- ❑ **Safety Information** — Safety guidelines and owner information.



Before activating the wireless functions such as the wireless LAN and BLUETOOTH technology, read the **Safety Information** carefully.

## 2. On-screen Documentation

- ❑ **VAIO User Guide** — General information of your VAIO computer including support and troubleshooting information.

To access **VAIO User Guide**, click **Start** , **All Programs**, and **VAIO Manual**.

- ❑ **Help and Support** — General information and technical assistance for your VAIO computer.

To access **Help and Support**:

- 1 Click **Start** and **Help and Support**.
- 2 Choose from the following categories to find the answers you need.

<b>Get started with my VAIO</b>	Get help with Internet and wireless setup, security setup, personalizing your VAIO computer, creating Recovery Media, and more.
<b>Use my VAIO</b>	Get assistance with your VAIO computer by accessing useful information such as interactive VAIO tutorials, how-to articles, the VAIO technology page, specifications, and system and software information. The available information varies depending on the model you purchased. You can find useful documentation such as general and model specific user guide on your VAIO computer.
<b>Troubleshoot my VAIO</b>	Maintain and troubleshoot your VAIO computer with the <b>VAIO Care</b> , system restore, backup and recovery, and contact Sony support.

- ❑ **Program help files** — May be included with the preinstalled software programs on your computer. You may be able to access the help files from the help menu on a specific program.

### 3. Support Web Sites

#### ❑ **Sony online support web site**

The Sony online support web site provides instant access to information on commonly encountered problems. Type a description of the problem and the Knowledge Database searches for the corresponding solutions online.

- ❑ For customers in USA

<http://esupport.sony.com/EN/VAIO/>

- ❑ For customers in Canada

<http://www.sony.ca/support/> (English)

<http://www.fr.sony.ca/support> (French)

- ❑ For customers in Spanish-speaking Latin American countries or areas

<http://esupport.sony.com/ES/VAIO/LA>

- ❑ For customers in Brazil

<http://esupport.sony.com/PT/VAIO/BR/>

#### ❑ **Operating system online support web site**

Your computer comes preinstalled with a Microsoft Windows operating system. For operating system support, you can visit Microsoft customer support at <http://support.microsoft.com/directory/>.

### 4. Customer Information Center

If you do not find the information you are looking for at our site, you may call Sony directly. You can find the contact numbers on the Sony online support web site. In order to receive the fastest and most efficient services, have the following information readily available:

- 1 Your VAIO computer model

You can find it at the lower right corner of the display on the computer.

**2** Your computer's serial number

You can find it on the bottom, the back panel, or inside the battery compartment of your VAIO computer. The serial number is the last 7 digits of the number below the barcode.

**3** The operating system on your computer

**4** The hardware component or the software program that is causing the problem

**5** A brief description of the problem

## 5. In Store Service & Support (available in USA only)

Make an appointment with a Sony certified technician at a U.S. Sony Style store and get personalized service and support for your VAIO computer. Sony Style Backstage Technicians can assist with the setup of your new VAIO computer, system optimization, data rescue, and any repair service you might need.

Visit the web site at [www.sonymstyle.com/backstage](http://www.sonymstyle.com/backstage) to find the nearest location.

## Ergonomic Considerations

You will be using your computer as a portable device in a variety of environments. Whenever possible, you should attempt to take account of the following ergonomic considerations for both stationary and portable environments:

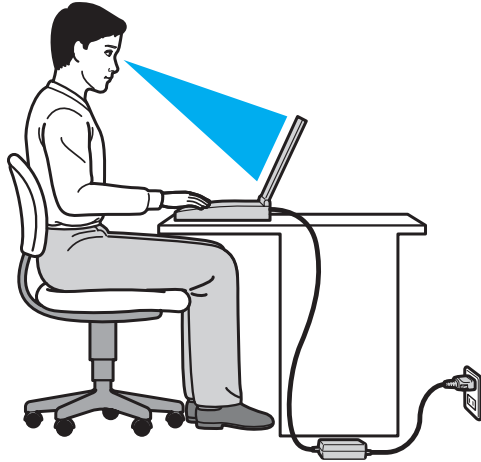

- ❑ **Position of your computer** – Place the computer directly in front of you. Keep your forearms horizontal, with your wrists in a neutral, comfortable position while using the keyboard or the pointing device. Let your upper arms hang naturally at your sides. Take frequent breaks while using your computer. Excessive use of the computer may strain eyes, muscles, or tendons.
- ❑ **Furniture and posture** – Sit in a chair with good back support. Adjust the level of the chair so your feet are flat on the floor. A footrest may make you more comfortable. Sit in a relaxed, upright posture and avoid slouching forward or leaning far backwards.
- ❑ **Viewing angle of the computer display** – Use the display tilting feature to find the best position. You can reduce eye strain and muscle fatigue by adjusting the tilt of the display to the proper position. Adjust the brightness level of the display as well.
- ❑ **Lighting** – Choose a location where windows and lights do not cause glare and reflection on the display. Use indirect lighting to avoid bright spots on the display. Proper lighting adds to your comfort and work efficiency.



- ❑ **Positioning an external display** – When using an external display, set the display at a comfortable viewing distance. Make sure the display screen is at or slightly below eye level when you are sitting in front of the monitor.

# Getting Started

This section describes how to get started using your VAIO computer.

! Before starting your computer for the first time, do not connect any other hardware that did not originally come with your computer. Upon completion, connect one device (for example, a printer, an external hard disk drive, a scanner, and so on) at a time, following the manufacturer's instructions.

- ❑ **Locating Controls and Ports** ([page 10](#))
- ❑ **About the Indicator Lights** ([page 16](#))
- ❑ **Connecting a Power Source** ([page 17](#))
- ❑ **Using the Battery Pack** ([page 19](#))
- ❑ **Shutting Down Your Computer Safely** ([page 24](#))
- ❑ **Using the Power Saving Modes** ([page 25](#))
- ❑ **Keeping Your Computer in Optimum Condition** ([page 26](#))

## Locating Controls and Ports

Take a moment to identify the controls and ports shown on the following pages.

! The appearance of your computer may be different from those illustrated in this manual due to variations in specifications.

## Front

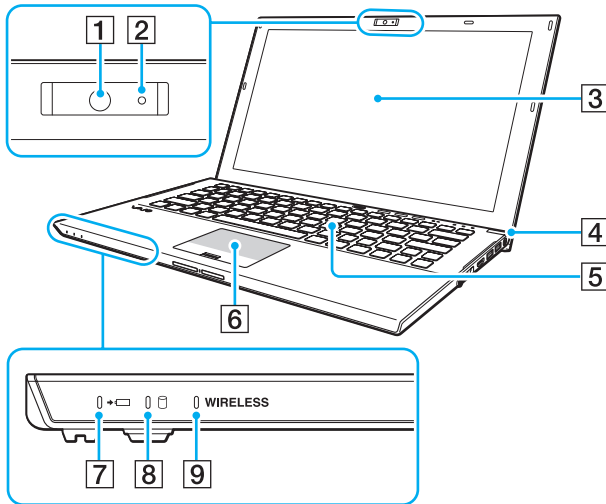

- 1 Built-in camera ([page 37](#))
- 2 Built-in camera indicator ([page 16](#))
- 3 LCD screen ([page 108](#))
- 4 Power button/Power indicator ([page 16](#))
- 5 Keyboard ([page 30](#))
- 6 Touch pad ([page 32](#))
- 7 Charge indicator ([page 16](#))
- 8 Disc drive indicator ([page 16](#))
- 9 **WIRELESS** indicator ([page 16](#))

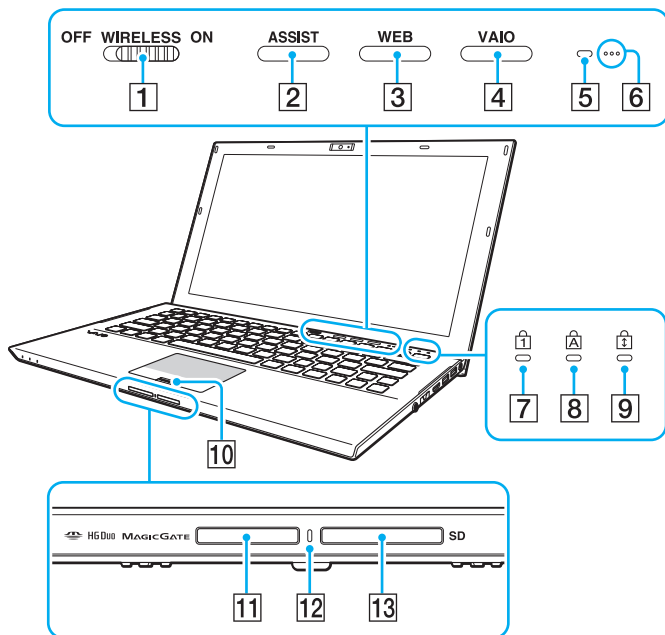

- 1 **WIRELESS** switch (page 52), (page 55), (page 59), (page 63)
- 2 **ASSIST** button (page 34)
- 3 **WEB** button (page 34)
- 4 **VAIO** button (page 34)
- 5 Ambient light sensor (page 31), (page 139)  
Measures ambient light intensity for automatically adjusting the LCD brightness to an optimum level.
- 6 Built-in microphones (monaural)
- 7 Num lock indicator (page 16)
- 8 Caps lock indicator (page 16)
- 9 Scroll lock indicator (page 16)
- 10 Fingerprint sensor (page 64)
- 11 "Memory Stick Duo" slot\* (page 43)
- 12 Media Access indicator (page 16)
- 13 **SD** memory card slot (page 47)

\* Your computer supports only Duo-size "Memory Stick".

## Back

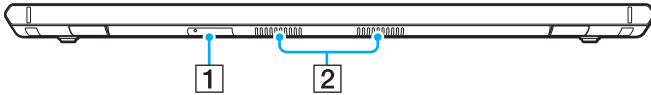

- 1 SIM card slot ([page 55](#)), ([page 59](#))
- 2 Air vents

! It is recommended that you do not use your computer with the LCD screen lid fully open for an extended period of time. If you do so, the temperature of the bottom of the unit may rise.

## Right

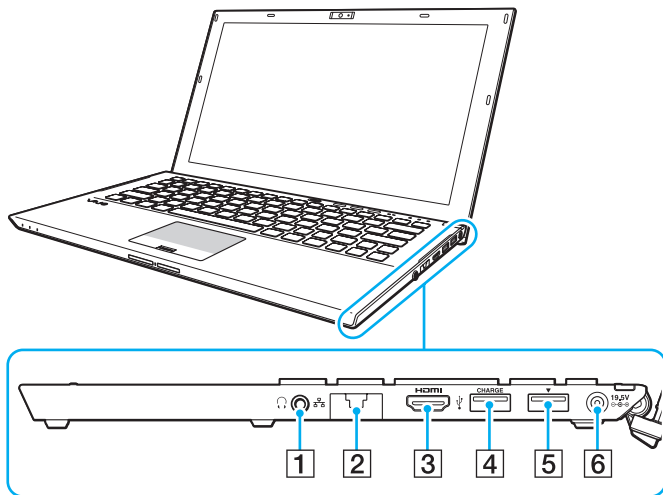

**HDMI**™  
HIGH-DEFINITION MULTIMEDIA INTERFACE

- 1 Headphones jack ([page 87](#))
- 2 LAN port ([page 51](#))  
Pull the port cover down before using the LAN port.

When the port cover disengages:

The port cover may disengage if you exert pressure on it when opening it or disconnecting a LAN cable. To attach the port cover, align the cover with the edge (1) of the port and push the cover down until it clicks into place.

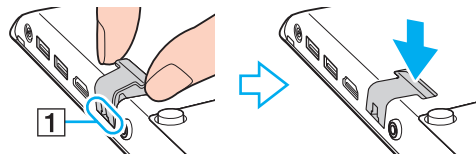

- 3 HDMI output port ([page 89](#))
- 4 USB port\*<sup>1</sup> ([page 93](#))
- 5 Docking station/USB port\*<sup>2</sup> ([page 79](#)), ([page 93](#))
- 6 DC IN port ([page 17](#))

\*<sup>1</sup> Compliant with the USB 2.0 standard.

\*<sup>2</sup> Compliant with the USB 2.0/3.0 standards. USB ports that are compliant with the USB 3.0 standard are identifiable by their blue color.

## Left

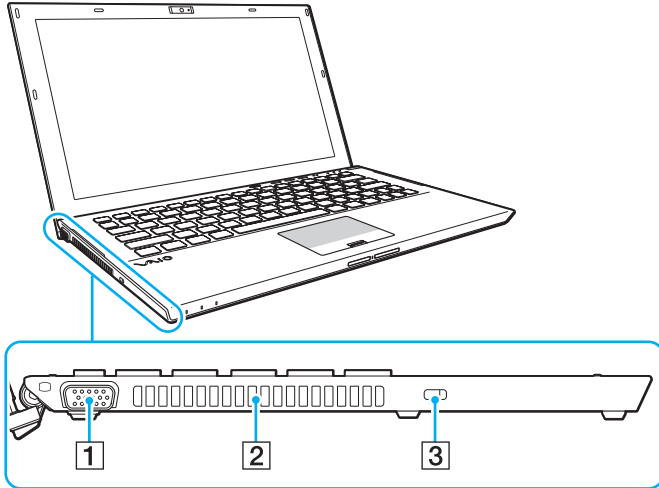

- 1 Monitor port ([page 88](#))
- 2 Air vent
- 3 Security slot

## Bottom (with the battery pack)

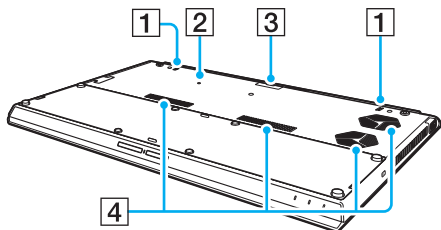

- 1 Built-in speakers (stereo)
- 2 Battery off button ([page 21](#)), ([page 125](#))
- 3 Extended battery pack connector cover\*
- 4 Air vents

\* For detailed instructions on how to attach an extended battery pack, see the manual that came with your extended battery pack. While the extended battery pack is attached to your computer, be sure to keep the removed connector cover for future use.

## Bottom (without the battery pack)

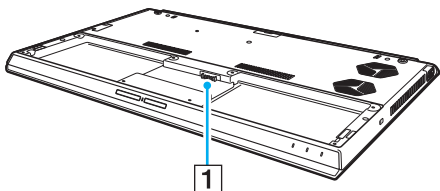





- 1 Battery connector ([page 19](#))

## About the Indicator Lights

Your computer is equipped with the following indicator lights:

Indicator	Functions
Power 	Illuminates in green while the computer is in Normal mode, blinks slowly in orange while the computer is in Sleep mode, and turns off when the computer is turned off or enters Hibernate mode.



Indicator	Functions
Charge 	Illuminates while the battery pack is charging. See <b>Charging the Battery Pack (page 21)</b> for more information.
Media Access	Illuminates while data access to a memory card, such as "Memory Stick" and an SD memory card, is in progress. (Do not place the computer into Sleep mode or turn it off while this indicator light is lit.) When the indicator light is unlit, the memory card is not in use.
Built-in camera	Illuminates while the built-in camera is in use.
Disc drive 	Illuminates while data access to the built-in storage device or the optical disc drive is in progress. Do not place the computer into Sleep mode or turn it off while this indicator light is lit.
Num lock 	Press the <b>Fn+Num Lk</b> keys to activate the numeric keypad. Press the keys a second time to deactivate the numeric keypad. The numeric keypad is not active when the indicator light is unlit.
Caps lock 	Press the <b>Caps Lock</b> key to type letters in uppercase. Letters appear in lowercase if you press the <b>Shift</b> key while the indicator light is lit. Press the key a second time to turn off the indicator light. Normal typing resumes when the Caps lock indicator light is turned off.
Scroll lock 	Press the <b>Fn+Scr Lk</b> keys to change how you scroll the display. Normal scrolling resumes when the Scroll lock indicator light is turned off. The <b>Scr Lk</b> key functions differently depending on the program you are using and does not work with all programs.
<b>WIRELESS</b>	Illuminates while one or more wireless options are enabled.

## Connecting a Power Source

You can use either an AC adapter or a rechargeable battery pack for supplying power to your computer. Before using the computer for the first time, you need to connect an AC adapter to your computer.

 Do not use your computer without installing the battery pack as it may cause the computer to malfunction.

## Using the AC Adapter

While your computer is directly connected to an AC power source and has a battery pack installed, it uses power from the AC outlet.



Use only the supplied AC adapter for your computer.

To use the AC adapter

- 1 Plug one end of the power cord (1) into the AC adapter (3).
- 2 Plug the other end of the power cord into an AC outlet (2).
- 3 Plug the cable from the AC adapter (3) into the DC IN port (4) on the computer.

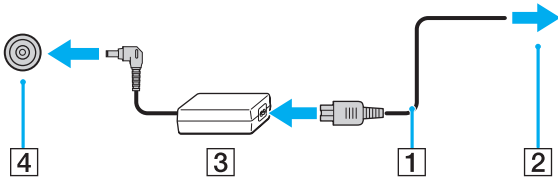

The shape of the DC In plug varies depending on the AC adapter.



To disconnect your computer completely from an AC power source, unplug the AC adapter from the AC outlet.

Make sure that an AC outlet is easily accessible.

If you do not intend to use your computer for an extended period of time, place the computer into Hibernate mode. See **Using Hibernate Mode (page 26)**.

## Using the Battery Pack

The battery pack is already installed on your computer at the time of delivery but is not fully charged.

! Do not use your computer without installing the battery pack as it may cause the computer to malfunction.

## Installing/Removing the Battery Pack

 In order to distinguish the battery pack which is installed on your computer at the time of delivery from an extended battery pack (supplied with selected models only), it may be referred to as the primary battery pack in this manual.

For detailed instructions on how to attach and charge an extended battery pack, see the manual that came with your extended battery pack.

### To install the battery pack

- 1 Turn off the computer, close the LCD screen lid, and unplug the AC adapter.
- 2 Fit the battery pack into the battery compartment.  
The battery pack should be level with the bottom of the computer.

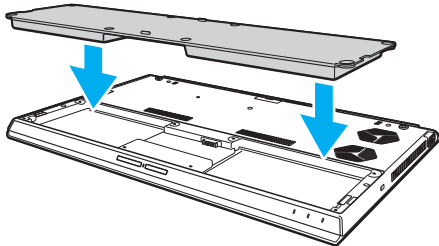

- 3 Tighten the four rubber screws (1), two short metallic screws (2), and two long metallic screws (3) with a coin.

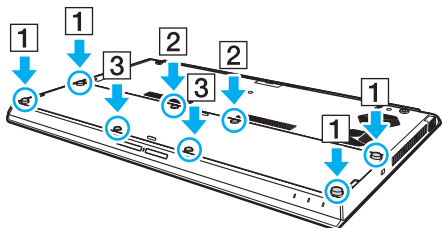

### To remove the battery pack

! You will lose all unsaved data if you remove the battery pack while your computer is on and not connected to the AC adapter.

- 1 Turn off the computer, close the LCD screen lid, and unplug the AC adapter if plugged.
- 2 Unscrew the eight screws with a coin.

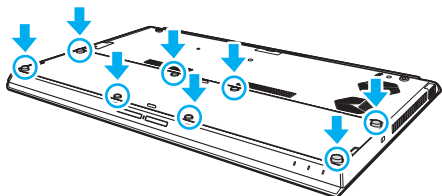

! Be careful not to lose the removed screws.

- 3 Hook your finger in the cut of the battery pack.

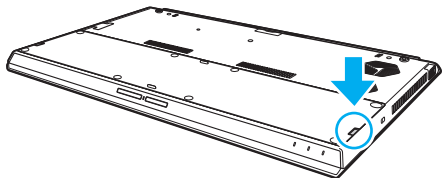

- 4 Pull the battery pack in the direction of the arrow and take it out of the battery compartment.

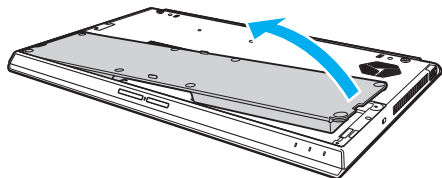

If your computer does not recognize the battery pack, turn off your computer and push and hold the battery off button for three seconds with a thin, straight object (such as a paper clip). If this does not solve the problem, remove the battery pack and install it once again.

If an extended battery pack is attached to the computer, turn off the computer and remove the extended battery pack. If this does not solve the problem, push and hold the battery off button for three seconds. If the problem persists, remove both battery packs and install them once again.



This computer is designed to operate only with genuine Sony battery packs.

## Charging the Battery Pack

The battery pack supplied with your computer is not fully charged at the time of delivery.

To charge the battery pack

- 1 Install the battery pack.

- 2 Connect the computer to a power source with the AC adapter. The charge indicator light is on while the battery pack is charging. When the battery pack charges close to the maximum charge level you selected, the charge indicator turns off.

Charge indicator status	Meaning
Lit in orange	The battery pack is charging.
Blinks along with the green power indicator	The battery pack is running out of power. (Normal mode)
Blinks along with the orange power indicator	The battery pack is running out of power. (Sleep mode)
Blinks fast in orange	A battery error has occurred due to a failed battery pack or an unlocked battery pack.

**!** Charge the battery pack as described in this manual from your first battery charge.



Keep the battery pack in your computer while it is directly connected to an AC power source. The battery pack continues to charge while you are using the computer.

When the battery pack is running out of power and both the charge and power indicator lights blink, you should either connect the AC adapter to recharge the battery pack or shut down your computer and install a fully charged battery pack.

Your computer is supplied with a lithium ion battery pack and can be recharged any time. Charging a partially discharged battery pack does not affect the life of battery.

While some software applications or peripheral devices are in use, your computer may not enter Hibernate mode even when the remaining battery life becomes short. To avoid loss of data while the computer is running on the battery, you should save your data frequently and manually activate a power management mode, such as Sleep or Hibernate.

If the battery pack runs out of power while the computer is in Sleep mode, you will lose all unsaved data. Going back to the previous work state is impossible. To avoid loss of data, you should save your data frequently.

## About the use of an extended battery pack

- ❑ If an extended battery pack is attached to your computer, the primary battery pack is charged first up to about 80% of its battery capacity. Then, the extended battery pack starts charging up to about 80%. After both battery packs are charged up to about 80%, the primary battery pack starts charging to 100%. Then, the extended battery pack starts charging to 100%.
- ❑ If an extended battery pack is attached to your computer, battery power of the extended battery pack is used first. Battery power of the primary battery pack will be used after the extended battery pack runs out of power.

## Checking the Battery Charge Capacity

The battery charge capacity gradually decreases as the number of battery charging increases or the duration of use of the battery pack extends. To get the most out of the battery pack, check the battery charge capacity and change the battery settings.

To check the battery charge capacity

- 1 Click **Start**, **All Programs**, and **VAIO Control Center**.
- 2 Click **Power Management** and **Battery**.



Additionally, you can enable the battery care function to extend the life of the battery pack.

## Extending the Battery Life

When your computer is running on battery power, you can extend the battery life using the following methods.

- Decrease the LCD brightness of your computer screen.
- Use the power saving mode. See **Using the Power Saving Modes (page 25)** for more information.
- Change the power saving settings on the **Power Options**. See **Using the VAIO Power Management (page 101)** for more information.



For more information on how to extend the battery life, see the help file after following the steps in **Checking the Battery Charge Capacity (page 23)**.

## Shutting Down Your Computer Safely

To avoid losing unsaved data, be sure to shut down your computer properly, as described below.

To shut down your computer

- 1 Turn off any peripherals connected to the computer.
- 2 Save your data and close all running software applications.
- 3 Click **Start** and the **Shut down** button.  
After a short time, the computer automatically turns off. Make sure the power indicator light turns off.



## Using the Power Saving Modes

You can take advantage of the power management settings to conserve battery life. In addition to the normal operating mode, your computer has two distinct power saving modes to suit your preference: Sleep and Hibernate.

! If you do not intend to use your computer for an extended period of time while it is disconnected from an AC power source, place the computer into Hibernate mode or turn it off.

If the battery pack runs out of power while your computer is in Sleep mode, you will lose all unsaved data. Going back to the previous work state is impossible. To avoid loss of data, you should save your data frequently.

Mode	Description
Normal mode	This is the normal state of your computer while it is in use. The green power indicator light is lit while the computer is in this mode.
Sleep mode	Sleep mode turns off the LCD screen and places the built-in storage device(s) and the CPU into a low power consumption mode. The orange power indicator light blinks slowly while your computer is in this mode. Your computer comes out of Sleep mode quicker than out of Hibernate mode. However, Sleep mode uses more power than Hibernate mode.
Hibernate mode	While your computer is in Hibernate mode, the state of the system is saved on the built-in storage device(s) and power is turned off. Even when the battery pack runs out of power, no data will be lost. The power indicator light is unlit while your computer is in this mode.

### Using Sleep Mode

To activate Sleep mode

Click **Start**, the arrow  next to the **Shut down** button, and **Sleep**.

To return to Normal mode

- ❑ Press any key.
- ❑ Press the power button on your computer.

! If you press and hold the power button for more than four seconds, your computer will turn off automatically. You will lose all unsaved data.

## Using Hibernate Mode

To activate Hibernate mode

Press the **Fn+F12** keys.

Alternatively, you can click **Start**, the arrow next to the **Shut down** button, and **Hibernate**.

! Do not move your computer before its power indicator light turns off.

To return to Normal mode

Press the power button.

! If you press and hold the power button for more than four seconds, your computer will turn off automatically.

# Keeping Your Computer in Optimum Condition

## Updating Your Computer

Be sure to update your VAIO computer with the following software applications for enhancing your computer's efficiency, security, and functionality.

The **VAIO Update** automatically notifies you of new updates available on the Internet, and downloads and installs them on the computer.

❑ **Windows Update**

Click **Start, All Programs, and Windows Update** and then follow the on-screen instructions.

❑ **VAIO Update 5**

Click **Start, All Programs, and VAIO Update** and then follow the on-screen instructions.



Your computer must be connected to the Internet to download the updates.

## Using the Antivirus Software for Your Computer

Protect your computer against computer viruses by using the antivirus software.

You can keep the antivirus software current with the latest updates by downloading and installing the updates from the web site of the manufacturer. To update the antivirus software, find the antivirus software installed on your computer from the following and follow the steps.



Your computer must be connected to the Internet to download the updates.

❑ **Trend Micro:**

- 1 Click **Start, All Programs, Trend Micro Titanium Maximum Security, and Trend Micro Titanium Maximum Security**.
- 2 Follow the on-screen instructions.

❑ **McAfee:**

- 1 Click **Start, All Programs, McAfee, and McAfee Internet Security or McAfee Total Protection**.
- 2 Follow the on-screen instructions.

❑ **Norton Internet Security:**

- 1 Click **Start, All Programs, Norton Internet Security**, and **LiveUpdate** or **Norton Internet Security**.
- 2 Follow the on-screen instructions.



See the help file included with your software program for more information.



The actual procedure may be different from the above depending on the version of the software installed on your computer. In such a case, follow the on-screen instructions.

## Using the VAIO Care

With the **VAIO Care**, you can regularly conduct performance checks and tune-ups on your computer to keep it running at an optimum level. Launch the **VAIO Care** whenever a problem is found on your computer. The **VAIO Care** will provide appropriate measures to solve the problem.

### To launch the VAIO Care

- On models with the **ASSIST** button

Press the **ASSIST** button while your computer is on.

- On models without the **ASSIST** button

Click **Start, All Programs**, and **VAIO Care**.



Do not press the **ASSIST** button while the computer is in Hibernate mode.



See the help file included with the **VAIO Care** for more information.

On models with the **ASSIST** button, pressing the **ASSIST** button while the computer is off launches the **VAIO Care Rescue**. The **VAIO Care Rescue** can be used to recover your computer in case of emergency, for example, when the Windows does not start.

# Using Your VAIO Computer

This section describes how to get the most out of using your VAIO computer.

- ❑ **Using the Keyboard** ([page 30](#))
- ❑ **Using the Touch Pad** ([page 32](#))
- ❑ **Using Special-function Buttons** ([page 34](#))
- ❑ **Using the Quick Web Access Function** ([page 35](#))
- ❑ **Using the Built-in Camera** ([page 37](#))
- ❑ **Using the Optical Disc Drive** ([page 38](#))
- ❑ **Using "Memory Stick"** ([page 43](#))
- ❑ **Using Other Modules / Memory Cards** ([page 47](#))
- ❑ **Using the Internet** ([page 50](#))
- ❑ **Using the Network (LAN)** ([page 51](#))
- ❑ **Using the Wireless LAN** ([page 52](#))
- ❑ **Using the Wireless WAN** ([page 55](#))
- ❑ **Using the International Roaming Service** ([page 59](#))
- ❑ **Using the BLUETOOTH Function** ([page 59](#))
- ❑ **Using the GPS Function** ([page 63](#))
- ❑ **Using Fingerprint Authentication** ([page 64](#))
- ❑ **Using the TPM** ([page 67](#))





## Using the Keyboard





Your keyboard has additional keys that perform model-specific tasks.

### Combinations and Functions with the Fn Key



Some keyboard functions can be used only after the operating system is finished launching.

Combination/Feature	Function
<b>Fn</b> +  ( <b>F1</b> ): touch pad operation	Disables and enables the touch pad.
<b>Fn</b> +  ( <b>F2</b> ): muting	Turns on and off the built-in speakers or the headphones.
<b>Fn</b> +  ( <b>F3/F4</b> ): volume control	Changes the built-in speaker volume level. To increase the volume, keep pressing the <b>Fn+F4</b> keys or press the <b>Fn+F4</b> keys and then the <b>↑</b> or <b>→</b> key. To decrease the volume, keep pressing the <b>Fn+F3</b> keys or press the <b>Fn+F3</b> keys and then the <b>↓</b> or <b>←</b> key.
<b>Fn</b> +  ( <b>F5/F6</b> ): brightness control	Changes the LCD brightness of your computer screen. To increase lighting intensity, keep pressing the <b>Fn+F6</b> keys or press the <b>Fn+F6</b> keys and then the <b>↑</b> or <b>→</b> key. To decrease lighting intensity, keep pressing the <b>Fn+F5</b> keys or press the <b>Fn+F5</b> keys and then the <b>↓</b> or <b>←</b> key.

Combination/Feature	Function
<b>Fn +  (F7): display output</b>	Switches the display output between your computer screen and an external display. Press the <b>Enter</b> key to select the display output.  <b>!</b> If you disconnect a display cable from your computer while an external display is selected as the display output destination, the computer screen goes blank. In such a case, press the <b>F7</b> key twice while holding down the <b>Fn</b> key, and then press the <b>Enter</b> key to switch the display output to the computer screen.  Use of multiple monitors may not be supported depending on the connected external display.
<b>Fn +  /  (F9/F10): zooming</b>	Changes the size of an image or a document displayed on some software. To make the view look smaller and further away (zoom out), press the <b>Fn+F9</b> keys. To make the view look bigger and closer (zoom in), press the <b>Fn+F10</b> keys. See the help file included with the <b>VAIO Control Center</b> for more information.
<b>Fn +  (F12): hibernation</b>	Provides the lowest level of power consumption. When you execute this command, the states of the system and the connected peripheral devices are saved to the built-in storage device and the system power is turned off. To return the system to its original state, use the power button to turn on the power. For details on power management, see <b>Using the Power Saving Modes (page 25)</b> .

## Changing the Backlit Keyboard Settings



Some features and options may not be available on your computer.

If your computer is equipped with a backlit keyboard, you can set the keyboard light to automatically turn on and off according to ambient light intensity.

Additionally, you can set a time period to turn off the keyboard backlight after inactivity of keyboard operations.

To change the backlit keyboard settings

- 1 Click **Start**, **All Programs**, and **VAIO Control Center**.

## 2 Click **Keyboard and Mouse** and **Backlit Keyboard**.



Ambient light intensity is measured by the ambient light sensor. Blocking the ambient light sensor may turn on the keyboard backlight.

## Using the Touch Pad

By sliding your finger on the touch pad (1), you can move the pointer (2) on the computer screen.

With the pointer on your desired item or object, press the left button zone or the right button zone to execute various commands or display menus.

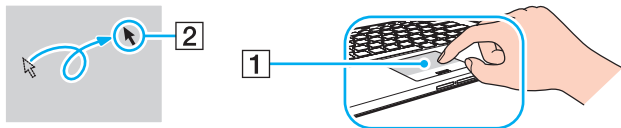

### About the touch pad zone

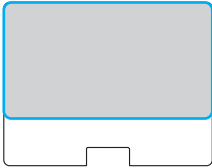
Zone	Description
<p data-bbox="121 751 233 770">Active zone</p> 	<p data-bbox="400 751 1038 770">Enables you to move the pointer by sliding your finger on this zone.</p>

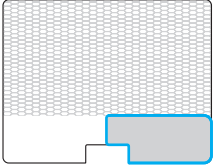
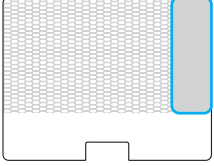

Zone	Description
<p data-bbox="113 213 277 236">Left button zone</p> 	<p data-bbox="392 213 970 236">Enables you to left-click by pressing anywhere on this zone.</p>
<p data-bbox="113 437 293 460">Right button zone</p> 	<p data-bbox="392 437 852 460">Enables you to right-click by pressing this zone.</p>
<p data-bbox="113 661 304 684">Vertical scroll zone</p> 	<p data-bbox="392 661 1283 684">Enables you to scroll up and down in the active window by sliding your finger along this zone.</p>

### To use the touch pad zone

Action	Description
Point	Slide your finger on the active zone to place the pointer on an item or object.
Click	Press the left button zone once.

Action	Description
Double-click	Press the left button zone twice in a row.
Right-click	Press the right button zone once. With many applications, this action displays a context-sensitive shortcut menu (if any).
Drag	Slide your finger on the active zone while pressing the left button zone.
Scroll vertically	Slide two fingers vertically on the active zone or slide a finger along the vertical scroll zone (the scroll function is available only with applications that support a touch pad scroll feature).
Scroll horizontally	Slide two fingers horizontally on the active zone (the scroll function is available only with applications that support a touch pad scroll feature).
Flick	Slide three fingers linearly in quick motion on the active zone. On web browser software or image viewer software, you can flick left to move backward and flick right to move forward.





You can disable/enable the touch pad by pressing the **Fn+F1** keys. You can also use the **VAIO Control Center** to change the touch pad settings.



Be sure to connect a mouse before disabling the touch pad. If you disable the touch pad before connecting a mouse, you will be able to use only the keyboard for pointer operations.

## Using Special-function Buttons

Your computer is equipped with special buttons to help you use specific functions of the computer.

Special-function button	Functions
<b>ASSIST</b> button 	Launches the <b>VAIO Care</b> while the computer is on. While the computer is off, the <b>ASSIST</b> button launches the <b>VAIO Care Rescue</b> . The <b>VAIO Care Rescue</b> can be used to recover the computer in case of emergency, for example, when the Windows does not start. See <b>Using the VAIO Care (page 28)</b> for more information.  ! Do not press the <b>ASSIST</b> button while the computer is in Hibernate mode.
<b>WEB</b> button 	While the computer is in Normal mode, the <b>WEB</b> button launches the web browser assigned to the button by default. While the computer is off, the <b>WEB</b> button activates the Quick Web Access function and launches the web browser used with this function. See <b>Using the Quick Web Access Function (page 35)</b> for more information.  ! The <b>WEB</b> button is not functional while the computer is in Sleep mode or Hibernate mode.
<b>VAIO</b> button 	Executes the task that is assigned to the button by default. You can change the default assignment with the <b>VAIO Control Center</b> .
Drive eject button *	Ejects the optical disc.

\* Located on the docking station (page 80).

## Using the Quick Web Access Function

The Quick Web Access function enables you immediately to access the Internet without launching the Windows operating system.

### Activating the Quick Web Access Function

To activate the Quick Web Access function, your computer must be off.

To activate the Quick Web Access function

- 1 Press the **WEB** button on the computer.
- 2 Follow the instructions in the initial setup wizard.  
Once you have completed the initial setup, the web browser used with the Quick Web Access function launches just by pressing the **WEB** button from the next time.

## Exiting the Quick Web Access Function

! To launch the Windows operating system, you first need to exit the Quick Web Access function.

To exit the Quick Web Access function, do any of the following:

- Click the  icon located at the lower left corner of the screen.
- Press the **WEB** button.
- Press the power button on the computer.

For detailed information on how to use or restrictions on the Quick Web Access function, click the  icon located at the lower right corner of the screen.

## Notes on Using the Quick Web Access Function

While the Quick Web Access function is activated, you cannot use:

- the **ASSIST** button.
- any function key, except the **F2**, **F3**, and **F4** keys, in combination with the **Fn** key for shortcuts.
- the **Scr Lk** key in combination with the **Fn** key for a shortcut.
- any port and jack except the DC IN port, the LAN port, the USB ports, and the headphones jack.

- ❑ the "Memory Stick Duo" slot and the **SD** memory card slot.
- ❑ the **Intel® Wireless Display** (installed on selected models only).
- ❑ the wireless WAN function (available on selected models only).

## Using the Built-in Camera

Your computer is equipped with a built-in camera.

With the communication software, such as **Windows Live Messenger**, you can make a video call through the Internet. For detailed information on how to use the software, see the help file included with the software.



The built-in camera indicator light illuminates while the built-in camera is in use.

The software installed on your computer varies depending on your computer's configurations.

### To make a video call using Windows Live Messenger

- 1 Click **Start, All Programs, and Windows Live Messenger**.



You need to sign in to **Windows Live Messenger** to make a video call.

### To display images from the built-in camera

- 1 Click **Start, All Programs, ArcSoft Webcam Suite, and WebCam Companion 4**.
- 2 Click **Capture**.



If you cannot capture images properly, for example captured images are not displayed smoothly, click the current resolution of the capturing image at the upper right of the main window and lower the resolution.

## Using the Optical Disc Drive

If a docking station is supplied with your computer, connect the docking station to the computer to use optical disc media.



Some features and options in this section may not be available on your computer.  
See the specifications to find out about the configuration of your computer.

### To insert a disc

- 1 Connect the docking station to your computer ([page 81](#)).
- 2 With the label side facing toward you, slide a disc into the optical disc drive slot.

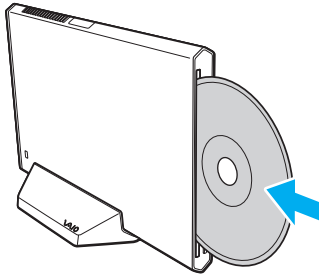

### Supported Discs

Your computer plays and records CDs, DVDs, and Blu-ray Disc™ media, depending on the model you purchased.  
See the reference chart below to find out which type of optical disc drive supports which types of media.

PR: playable and recordable  
P: playable but not recordable  
–: not playable or recordable

	CD-ROM	CD-R/RW	DVD-ROM	DVD-R/ RW	DVD+R/ RW	DVD+R DL (Double Layer)	DVD-R DL (Dual Layer)	DVD- RAM* <sup>1</sup> * <sup>2</sup>	BD-ROM	BD-R/RE* <sup>3</sup> * <sup>4</sup>
DVD SuperMulti Drive	P	PR* <sup>6</sup>	P	PR	PR	PR	PR	PR	–	–
Blu-ray Disc™ Drive with DVD SuperMulti	P	PR* <sup>6</sup>	P	PR	PR	PR	PR	PR	P	PR* <sup>5</sup>
Blu-ray Disc™ ROM Drive with DVD SuperMulti	P	PR* <sup>6</sup>	P	PR	PR	PR	PR	PR	P	P

\*<sup>1</sup> The DVD SuperMulti Drive on your computer does not support the DVD-RAM cartridge. Use non-cartridge discs or discs with a removable cartridge.

\*<sup>2</sup> Writing data to single-sided DVD-RAM discs (2.6 GB) compliant with DVD-RAM Version 1.0 is not supported.  
DVD-RAM Version 2.2/12X-SPEED DVD-RAM Revision 5.0 disc is not supported.

\*<sup>3</sup> The Blu-ray Disc drive on your computer does not support BD-RE Disc media in Version 1.0 format and Blu-ray Disc media with a cartridge.

\*<sup>4</sup> BDXL™ Disc media is not supported.

\*<sup>5</sup> Supports writing data to BD-R Part1 Version 1.1/1.2/1.3 discs (single-layer discs with the capacity of 25 GB, dual-layer discs with the capacity of 50 GB) and BD-RE Part1 Version 2.1 discs (single-layer discs with the capacity of 25 GB, dual-layer discs with the capacity of 50 GB).

\*<sup>6</sup> Writing data to Ultra Speed CD-RW discs is not supported.

! This unit is designed to playback discs that conform to the Compact Disc (CD) standard. DualDiscs and some music discs encoded with copyright protection technologies do not conform to the Compact Disc (CD) standard. Therefore, these discs may not be compatible with this unit.

When you buy pre-recorded or blank discs for use with your VAIO computer, be sure to read the notices on the disc package carefully to check both playback and recording compatibility with your computer's optical disc drives. Sony does NOT guarantee the compatibility of VAIO optical disc drives with discs that are not compliant with the official "CD," "DVD," or "Blu-ray Disc" standard. USING NON-COMPLIANT DISCS CAN CAUSE FATAL DAMAGE TO YOUR VAIO COMPUTER OR CREATE SOFTWARE CONFLICTS AND CAUSE SYSTEM HANGING.

For inquiries about disc formats, contact the individual publisher of the pre-recorded disc or the manufacturer of the recordable disc.



8 cm disc reading/writing and use of an 8 cm disc adapter are not supported.

! To play copyright protected Blu-ray Disc media continually, update the AACS key. The AACS key update requires Internet access.

As with other optical media devices, circumstances may limit compatibility or prevent Blu-ray Disc media playback. VAIO computers may not support movie playback on packaged media recorded in AVC or VC1 formats at high bit rates.

Region settings are required for some contents of DVD and BD-ROM Disc media. If the region setting on the optical disc drive does not match the region coding on the disc, playback is not possible.

Unless your external display is compliant with the High-bandwidth Digital Content Protection (HDCP) standard, you cannot play or view the contents of copyright protected Blu-ray Disc media.

Some content may restrict video output to standard definition or prohibit analog video output. When you output video signals through digital connections, such as an HDMI connection or a DVI connection, it is strongly recommended that a digital HDCP compliant environment be implemented for optimum compatibility and viewing quality.

Exit all memory-resident utility software before playing or writing a disc as it may cause the computer to malfunction.



## Notes on Using the Optical Disc Drive

### Notes on writing data to a disc

- ❑ Only use circular discs. Do not use discs in any other shape (star, heart, card, etc.), as this may damage the optical disc drive.
- ❑ Do not strike or shake the docking station while the optical disc drive is writing data to a disc.
- ❑ Do not plug or unplug the power cord or the AC adapter while the optical disc drive is writing data to a disc.
- ❑ Do not connect or disconnect the docking station to or from your computer while the optical disc drive is writing data to a disc.

### Notes on playing discs

To achieve optimum performance of disc playback, you should follow these recommendations:

- ❑ Some CD players and computer optical disc drives may not be able to play audio CDs created with the CD-R or CD-RW media.
- ❑ Some DVD players and computer optical disc drives may not be able to play DVDs created with the DVD+R DL, DVD-R DL, DVD+R, DVD+RW, DVD-R, DVD-RW, or DVD-RAM media.
- ❑ When your computer is equipped with a Blu-ray Disc drive, Blu-ray Disc playback is available on your computer. However, the drive may not be able to play some Blu-ray Disc content, or the computer may become unstable during Blu-ray Disc playback. To play content normally, download and install the latest updates for Blu-ray Disc playback software using the **VAIO Update**.

For information on how to use the **VAIO Update**, see **Updating Your Computer (page 26)**.

- ❑ Depending on system environment, you may find sound interruptions and/or dropped frames during AVC HD playback.
- ❑ Do not place your computer into either of the power saving modes while your computer is playing a disc.
- ❑ Do not strike or shake the docking station while the optical disc drive is reading data from a disc.

## Notes on region codes

Region code indicators are labeled on the discs or packages to indicate in which region and on what type of player you can play the disc. If the region code indicates "all," you can play this disc in most regions of the world. If the region code for your residence area is different from the label, you cannot play the disc on your computer.

## Playing Discs

To play a disc

- 1 Insert a disc into the optical disc drive.

! Close all running software applications before playing a disc.

- 2 If nothing appears on the desktop, click **Start, All Programs**, and your desired software to play the disc. For instructions on how to use the software, see the help file included with the software.

## Copying Files to Discs

To copy files to a disc

- 1 Insert a recordable disc into the optical disc drive.

! Close all running software applications before copying files to a disc.

- 2 If nothing appears on the desktop, click **Start, All Programs**, and your desired disc burning software to copy files to the disc. For instructions on how to use the software, see the help file included with the software.

## Using "Memory Stick"

"Memory Stick" is a compact, portable, and versatile IC recording media especially designed for exchanging and sharing digital data with compatible products, such as digital cameras, mobile phones, and other devices. Because it is removable, it can be used for external data storage.

### Before You Use "Memory Stick"

The "Memory Stick Duo" slot on your computer can accommodate the following sizes and types of media:

- "Memory Stick Duo"
- "Memory Stick PRO Duo"
- "Memory Stick PRO-HG Duo"



Your computer supports only Duo-size "Memory stick", and does not support standard-size "Memory Stick".

For the latest information about "Memory Stick", visit <http://www.sony.net/memorycard/>.

### Inserting and Removing "Memory Stick"

To insert "Memory Stick"

- 1 Locate the "Memory Stick Duo" slot.
- 2 Hold "Memory Stick" with the arrow pointing toward the slot.
- 3 Carefully slide "Memory Stick" into the slot until it clicks into place.  
Do not force the media into the slot.

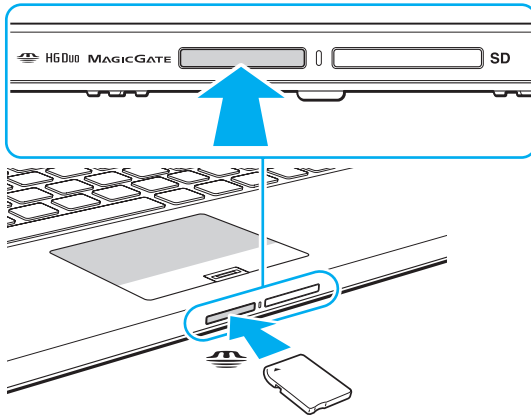

If "Memory Stick" does not go into the slot easily, remove it gently and verify you are inserting it in the proper direction.

When you insert "Memory Stick" into the slot for the first time, you may be prompted to install driver software. If prompted, follow the on-screen instructions to install the software.

"Memory Stick" is automatically detected by your system and the contents of "Memory Stick" are displayed. If nothing appears on the desktop, click **Start, Computer**, and double-click the "Memory Stick" icon.

The "Memory Stick" icon will appear in the **Computer** window after you insert "Memory Stick" into the slot.



Before using "Memory Stick Micro" ("M2"), be sure to insert it into an "M2" Duo adaptor. If you insert the media directly into the "Memory Stick Duo" slot without the adaptor, you may not be able to remove it from the slot.

## To remove "Memory Stick"

! Do not remove "Memory Stick" while the Media Access indicator light is lit. If you do, you may lose data. Large volumes of data may take time to load, so make sure the indicator light is unlit before removing "Memory Stick".

- 1 Locate the "Memory Stick Duo" slot.
- 2 Check that the Media Access indicator light is unlit.
- 3 Push in "Memory Stick" toward the computer and release. "Memory Stick" ejects.
- 4 Pull "Memory Stick" out of the slot.

! Be sure to remove "Memory Stick" gently, or it may pop out unexpectedly.

## Formatting "Memory Stick"

### To format "Memory Stick"

"Memory Stick" is formatted by default and is ready for use.

If you want to reformat the media with your computer, follow these steps.

! Be sure to use the device that is designed to format the media and supports "Memory Stick" when formatting the media.

Formatting "Memory Stick" erases the entire data stored on the media. Before formatting the media, make sure that it does not contain your valuable data.

Do not remove "Memory Stick" from the slot while formatting. This could cause a malfunction.

- 1 Locate the "Memory Stick Duo" slot.
- 2 Carefully slide "Memory Stick" into the slot until it clicks into place.

- 3 Click **Start** and **Computer**.
- 4 Right-click the "Memory Stick" icon and select **Format**.
- 5 Click **Restore device defaults**.

! The size of the allocation unit and file system may change.

Do not select **NTFS** from the **File system** drop-down list as it may cause a malfunction.



The formatting process will be completed more quickly if you select **Quick Format** in **Format options**.

- 6 Click **Start**.
- 7 Follow the on-screen instructions.

! It may take time to format "Memory Stick" depending on the media type.

## Notes on Using "Memory Stick"

- Your computer has been tested and found compatible with Sony branded "Memory Stick" with capacity of up to 32 GB that are available as of January 2011. However, not all "Memory Stick" are guaranteed of compatibility.
- Be sure to hold "Memory Stick" with the arrow pointing in the correct direction as you insert it into the slot. To avoid damaging your computer or the media, do not force "Memory Stick" into the slot if you cannot insert it smoothly.
- Use care when inserting or removing "Memory Stick" from the slot. Do not force it in or out of the slot.
- Inserting "Memory Stick" with multiple conversion adaptors is not guaranteed of compatibility.
- "MagicGate" is the general name of the copyright protection technology developed by Sony. Use "Memory Stick" with the "MagicGate" logo to take advantage of this technology. The "Memory Stick Duo" slot on your computer does not support "MagicGate" technology of "Memory Stick" with capacity of up to 256 MB.

- ❑ Except for your personal use, it is against the copyright law to use any audio and/or image data you recorded without prior consent from the respective copyright holders. Accordingly, "Memory Stick" with such copyrighted data can be used only within the law.
- ❑ Do not insert more than one memory card into the slot. Improper insertion of the media may damage both your computer and the media.

## Using Other Modules / Memory Cards

### Using the SD Memory Card

Your computer is equipped with an **SD** memory card slot. You can use this slot to transfer data among digital cameras, camcorders, music players, and other audio/video devices.

#### Before you use the SD memory card

The **SD** memory card slot on your computer can accommodate the following memory cards:

- ❑ SD memory card
- ❑ SDHC memory card
- ❑ SDXC memory card

For the latest information on compatible memory cards, see **Finding More about Your VAIO Computer (page 4)** to visit the appropriate support web site.

#### To insert an SD memory card

- 1 Locate the **SD** memory card slot.
- 2 Hold the SD memory card with the arrow pointing toward the slot.
- 3 Carefully slide the SD memory card into the slot until it clicks into place.  
Do not force the card into the slot.

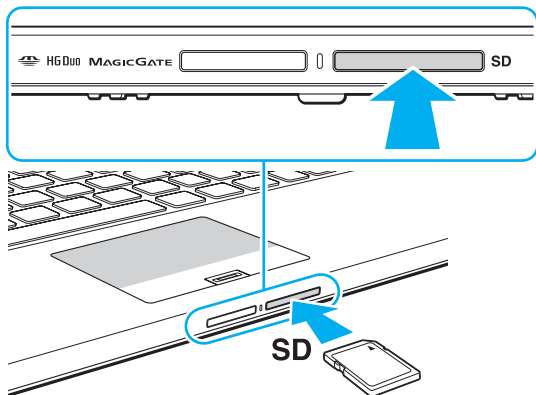

 When you insert the SD memory card into the slot for the first time, you may be prompted to install driver software. If prompted, follow the on-screen instructions to install the software.

The SD memory card icon will appear in the **Computer** window after you insert the card into the slot.

## To remove an SD memory card

- 1 Locate the **SD** memory card slot.
- 2 Check that the Media Access indicator light is unlit.
- 3 Push in the SD memory card toward the computer and release.  
The SD memory card ejects.
- 4 Pull the SD memory card out of the slot.



## Notes on Using Memory Cards

### General notes on using the memory card

- ❑ Be sure to use memory cards that are compliant with the standards supported by your computer.
- ❑ Be sure to hold the memory card with the arrow pointing in the correct direction as you insert it into the slot. To avoid damaging your computer or the media, do not force the memory card into the slot if you cannot insert it smoothly.
- ❑ Use care when inserting or removing the memory card from the slot. Do not force it in or out of the slot.
- ❑ Do not remove the memory card while the media access indicator light is lit. If you do, you may lose data.
- ❑ Do not attempt to insert a memory card or memory card adaptor of a different type into the memory card slot. An incompatible memory card or memory card adaptor may cause difficulty in removing from the slot and can cause damage to your computer.
- ❑ Do not insert more than one memory card into the slot. Improper insertion of the media may damage both your computer and the media.

### Notes on using the SD memory card

- ❑ Your computer has been tested and found compatible only with major memory cards available as of January 2011. However, not all memory cards are guaranteed of compatibility.
- ❑ SD memory cards (up to 2 GB), SDHC memory cards (up to 32 GB), and SDXC memory cards (up to 64 GB) have been tested and found compatible with your computer.
- ❑ Some types of SD memory cards, for example ones with the UHS (Ultra High Speed data transfer feature), may become extremely hot due to continuous access to the memory cards. In such a case, wait for a while before removing the memory card until it cools down.

## Using the Internet

Before using the Internet, you need to sign up with an Internet Service Provider (ISP) and set up devices required for connecting your computer to the Internet.

The following types of Internet connection services may be available from your ISP:

- Fiber to the Home (FTTH)
- Digital Subscriber Line (DSL)
- Cable modem
- Satellite
- Dial-up

For detailed information on devices required for Internet access and how to connect your computer to the Internet, ask your ISP.



To connect your computer to the Internet using the wireless LAN function, you need to set up the wireless LAN network. See **Using the Wireless LAN (page 52)** for more information.



When you connect your computer to the Internet, be sure to take appropriate security measures to protect the computer against online threats.

Depending on the service contract with your ISP, you may need to connect an external modem device, for example a USB telephone modem, a DSL modem, or a cable modem, to your computer to connect to the Internet. For detailed instructions on connection setups and modem configuration, see the manual that came with your modem.

## Using the Network (LAN)

You can connect your computer to 1000BASE-T/100BASE-TX/10BASE-T type networks with a LAN cable. Connect one end of a LAN cable (not supplied) to the LAN port on the computer or the docking station and the other end to your network. For detailed settings and devices required for LAN access, ask your network administrator.

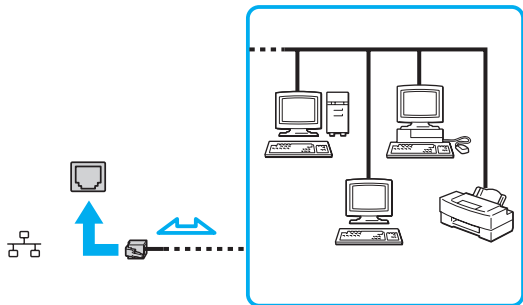

You can connect your computer to any network without changing the default settings.

When the docking station is connected to your computer, you need to select which LAN port to use. Follow the on-screen instructions.



Do not plug a telephone cable into the LAN port on your computer.

If the LAN port is connected to one of the telephone lines mentioned below, high electric current to the port may cause damage, overheating, or fire.

- Home (intercom speakerphone) or business-use telephone lines (multi-line business telephone)
- Public telephone subscriber line
- Private branch exchange (PBX)

## Using the Wireless LAN

The Wireless LAN (WLAN) allows your computer to connect to a network through a wireless connection.



The WLAN uses the following IEEE 802.11a/b/g/n standard, which specifies the type of technology used. See the specifications to find out about the configuration of your computer.

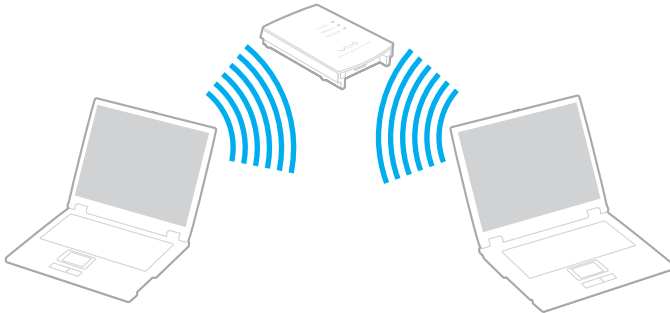

WLAN standard	Frequency band	Remarks
IEEE 802.11a	5 GHz	Available only on models compliant with the IEEE 802.11a/b/g/n standard.
IEEE 802.11b/g	2.4 GHz	The IEEE 802.11g standard provides higher-speed communications than the IEEE 802.11b standard.
IEEE 802.11n	5 GHz/2.4 GHz	On models compliant with the IEEE 802.11b/g/n standard, only the 2.4 GHz band can be used.

## Notes on Using the Wireless LAN Function

### General notes on using the wireless LAN function

- ❑ In some countries or regions, using WLAN products may be restricted by the local regulations (e.g. limited number of channels).
- ❑ The IEEE 802.11a standard and the IEEE 802.11n standard are not available on ad-hoc networks.
- ❑ The 2.4 GHz band, with which wireless LAN devices work, is used by various devices. Although the wireless LAN devices use the technology to minimize radio interference from other devices that use the same band, such radio interference may cause slower communication speeds and narrower communication ranges or communication failures.
- ❑ The communication speed and range may vary depending on the following conditions:
  - ❑ Distance between communication devices
  - ❑ Existence of obstacles between devices
  - ❑ Device configuration
  - ❑ Radio conditions
  - ❑ Ambient environment that includes existence of walls and materials of such walls
  - ❑ Software in use
- ❑ Communications may be cut off depending on radio conditions.
- ❑ Actual communication speed may not be as fast as the one displayed on your computer.
- ❑ Deploying WLAN products compliant with different standards that use the same band on the same wireless network may reduce the communication speed due to radio interference. Taking this into consideration, WLAN products are designed to reduce the communication speed to ensure communications with another WLAN product if it is compliant with a different standard that uses the same band. When the communication speed is not as fast as expected, changing the wireless channel on the access point may increase the communication speed.

## Note on the data encryption

The WLAN standard includes the encryption methods: Wired Equivalent Privacy (WEP), which is a security protocol, Wi-Fi Protected Access 2 (WPA2), and Wi-Fi Protected Access (WPA). Proposed jointly by the IEEE and Wi-Fi Alliance, both WPA2 and WPA are specifications of standards based on interoperable security enhancements that increase the level of data protection and access control for existing Wi-Fi networks. WPA is designed to be forward compatible with the IEEE 802.11i specification. It utilizes the enhanced data encryption Temporal Key Integrity Protocol (TKIP) in addition to user authentication using 802.1X and Extensible Authentication Protocol (EAP). Data encryption protects the vulnerable wireless link between clients and access points. Besides that, there are other typical LAN security mechanisms to ensure privacy, such as: password protection, end-to-end encryption, virtual private networks, and authentication. WPA2, the second generation of WPA, provides stronger data protection and network access control and is also designed to secure all versions of 802.11 devices, including 802.11b, 802.11a, 802.11g, and 802.11n standards, multi-band and multi-mode. In addition, based on the ratified IEEE 802.11i standard, WPA2 provides government grade security by implementing the National Institute of Standards and Technology (NIST) FIPS 140-2 compliant AES encryption algorithm and 802.1X-based authentication. WPA2 is backward compatible with WPA.

## Starting Wireless LAN Communications

You first need to establish wireless LAN communications between your computer and an access point (not supplied). See **Windows Help and Support** for more information. For help on setting up a wireless network, click **Start, All Programs**, and **VAIO Easy Connect**, and then follow the on-screen instructions of the **Easy Internet Connection Setup**.



! For details on how to select the channel that will be used by the access point, see the manual that came with your access point.

### To start wireless LAN communications

- 1 Make sure an access point is set up.  
See the manual that came with your access point for more information.
- 2 Turn on the **WIRELESS** switch.

- 3 Click **Start**, **All Programs**, and **VAIO Smart Network** or click the **VAIO Smart Network** icon  on the taskbar.
- 4 Click the switch next to **Wi-Fi** to toggle it to **On** in the **VAIO Smart Network** window. Make sure the **WIRELESS** indicator light turns on.

! 5 GHz band wireless LAN communications, available on selected models only, are disabled by default. To enable 5 GHz band communication, you need to select the option to use the 5 GHz band or both the 2.4 GHz and 5 GHz bands from the drop-down list for **Wi-Fi Settings** in the **VAIO Smart Network** settings window.

- 5 Click  or  on the taskbar.
- 6 Select the desired access point and click **Connect**.

## Stopping Wireless LAN Communications

To stop wireless LAN communications

Click the switch next to **Wi-Fi** to toggle it to **Off** in the **VAIO Smart Network** window.

! Turning off the wireless LAN function while accessing remote documents, files, or resources may result in data loss.

## Using the Wireless WAN

Using the wireless WAN (WWAN) allows your computer to connect to the Internet through the wireless network wherever there is the mobile phone coverage.

The WWAN may not be available in some countries or regions.



Some features and options in this section may not be available on your computer. See the specifications to find out about the configuration of your computer.

## Inserting a SIM Card

Depending on the carrier you are using, you may need to insert a SIM card into the SIM card slot on your computer to use the wireless WAN function. Your SIM card is contained within a base plate, about the size of a credit card.

To insert a SIM card

- 1 Turn off your computer.
- 2 Insert a thin, straight object (such as a paper clip) into the hole (1) in the SIM card holder (2) so that the holder pops out.

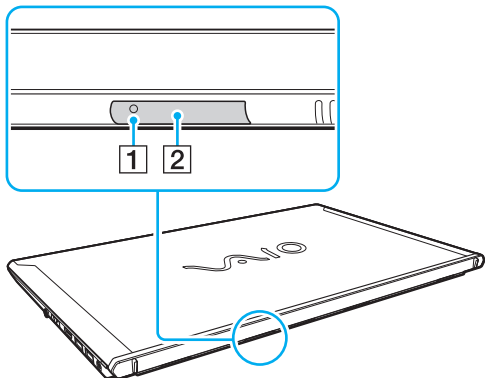

- 3 Gently take hold of the SIM card holder and pull it out of the slot.
- 4 Remove the SIM card (3) by pushing it out from the base plate.



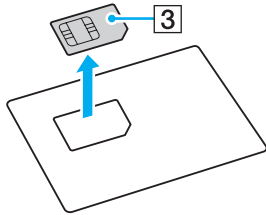

- 5 Put the SIM card on the SIM card holder with its printed circuit side up.

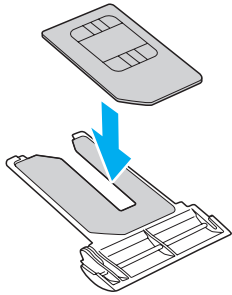

- 6 Insert the SIM card holder into the SIM card slot.

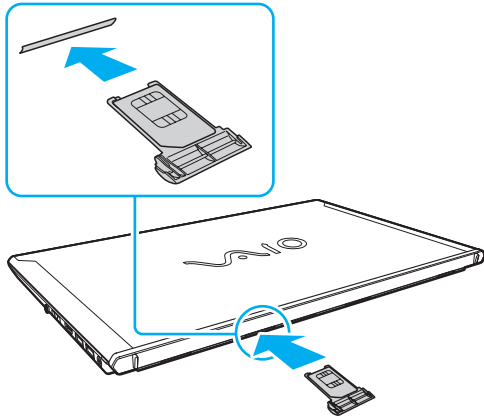

! Do not touch the printed circuit on the SIM card. Be sure to hold your computer firmly before inserting or removing the card.  
Do not damage the SIM card in any way, either by bending or exerting pressure on the card.

## Starting the Wireless WAN Communications

To start the wireless WAN communications

! Make sure that the SIM card holder is properly inserted into the SIM card slot, otherwise the wireless WAN function may not work.

- 1 Turn on the **WIRELESS** switch.
- 2 Click **Start, All Programs**, and **VAIO Smart Network** or click the **VAIO Smart Network** icon  on the taskbar.
- 3 In the **VAIO Smart Network** window, make sure that the switch next to **Wireless WAN** is **On**.

- 4 Click the down arrow button next to the **Wireless WAN** switch and the **Connect** button to launch the **VAIO Mobile Broadband Setup**.
- 5 Follow the on-screen instructions on the **VAIO Mobile Broadband Setup** to sign up with a supported carrier.



A long term contract may not be required. Some carriers may offer prepaid plans, such as one-day usage.

Once you have finished signing up with the supported carrier with the **VAIO Mobile Broadband Setup**, **Wireless WAN** in the **VAIO Smart Network** window will be replaced with the name of the carrier which you have selected and signed up.

- 6 Click **Connect** to launch the carrier's connection manager and make a mobile broadband connection.



For more information on how to use the wireless WAN function, see the help file included with the **VAIO Smart Network** or the carrier's connection manager.

## Using the International Roaming Service

To use the international roaming service, you first need to insert a SIM card into the SIM card slot on your computer. Follow the steps in **Inserting a SIM Card (page 56)**.



Some features and options in this section may not be available on your computer.  
See the specifications to find out about the configuration of your computer.

## Using the BLUETOOTH Function

You can establish wireless communications between your computer and other BLUETOOTH® devices such as another computer or a mobile phone. You can transfer data between these devices without cables at a range of up to 33 feet / 10 meters in an open area.

## BLUETOOTH Security

The BLUETOOTH wireless technology has an authentication function, which allows you to determine with whom you choose to communicate. With the authentication function, you can prevent any anonymous BLUETOOTH devices from accessing your computer.

The first time two BLUETOOTH devices communicate, a common passkey (a password required for authentication) should be determined for both devices to be registered. Once a device is registered, there is no need to re-enter the passkey.



The passkey can be different each time, but must be the same at both ends.

For certain devices, such as a mouse, no passkey can be entered.

## Communicating with Another BLUETOOTH Device

You can connect your computer to a BLUETOOTH device such as another computer, a mobile phone, a PDA, a headset, a mouse, or a digital camera without the use of any cables.

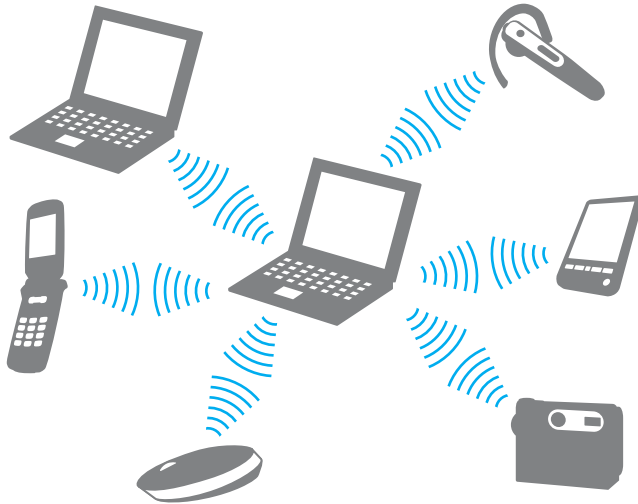

### To communicate with another BLUETOOTH device

To communicate with another BLUETOOTH device, you first need to set up the BLUETOOTH function. For information on setting up and using the BLUETOOTH function, see **Windows Help and Support**.

- 1 Turn on the **WIRELESS** switch.
- 2 Click **Start**, **All Programs**, and **VAIO Smart Network** or click the **VAIO Smart Network** icon  on the taskbar.
- 3 Click the switch next to **BLUETOOTH** to toggle it to **On** in the **VAIO Smart Network** window. Make sure the **WIRELESS** indicator light turns on.

## Stopping BLUETOOTH Communications

To stop BLUETOOTH communications

- 1 Turn off the BLUETOOTH device that is communicating with your computer.
- 2 Click the switch next to **BLUETOOTH** to toggle it to **Off** in the **VAIO Smart Network** window.

## Notes on Using the BLUETOOTH Function

- ❑ The data transfer rate varies, depending on the following conditions:
  - ❑ Obstacles, such as walls, located between devices
  - ❑ Distance between devices
  - ❑ Material used in walls
  - ❑ Proximity to microwaves and cordless telephones
  - ❑ Radio frequency interference and other environmental conditions
  - ❑ Device configuration
  - ❑ Type of software application
  - ❑ Type of operating system
  - ❑ Use of both wireless LAN and BLUETOOTH functions at the same time on your computer
  - ❑ Size of file being exchanged
- ❑ Large files may occasionally be corrupted during continuous transfer due to limitations of the BLUETOOTH standard and electromagnetic interference in the environment.
- ❑ All BLUETOOTH devices must be certified to make sure that the applicable standard requirements are maintained. Even if standards are met, individual device performance, specifications, and operation procedures can vary. Data exchange may not be possible in all situations.

- ❑ Video and audio may not be synchronized if you play videos on your computer with audio output from a connected BLUETOOTH device. This is a frequent occurrence with BLUETOOTH technology and does not indicate a malfunction.
- ❑ The 2.4 GHz band, with which BLUETOOTH devices or wireless LAN devices work, is used by various devices. Although BLUETOOTH devices use the technology to minimize radio interference from other devices that use the same band, such radio interference may cause slower communication speeds and shorter distances or communication failures.
- ❑ The BLUETOOTH function may not work with other devices, depending on the manufacturer or the software version employed by the manufacturer.
- ❑ Connecting multiple BLUETOOTH devices to your computer may cause channel congestion, resulting in poor performance of the devices. This is normal with BLUETOOTH technology and does not indicate a malfunction.
- ❑ High-speed communications between your computer and BLUETOOTH devices are available when they are compliant with BLUETOOTH Core Specification Version 3.0 + HS. For the high-speed communications, enable both the wireless LAN and BLUETOOTH functions on the computer.



See the specifications to find out about the configuration of your computer.

## Using the GPS Function

You can get the location information by using GPS (Global Positioning System) with location software.



Some features and options in this section may not be available on your computer.  
See the specifications to find out about the configuration of your computer.

To use the GPS function

- 1 Turn on the **WIRELESS** switch.
- 2 Click **Start, All Programs**, and **VAIO Smart Network** or click the **VAIO Smart Network** icon  on the taskbar.

- 3 Click the switch next to **GPS** to toggle it to **On** in the **VAIO Smart Network** window.



Driver software will be installed when you first activate the GPS function on the **VAIO Smart Network**.

## Using Fingerprint Authentication

Your computer is equipped with a fingerprint sensor to provide you with additional convenience.

Once you have registered your fingerprint(s), the fingerprint authentication function offers:

- ❑ A substitute for password entry to log onto Windows ([page 66](#))  
If you have registered your fingerprints for your user account, you can substitute fingerprint authentication for password entry when logging onto Windows.
- ❑ **Website Log On** for quick web site access  
Once you have registered your user information (user accounts, passwords, etc.) for web sites in the **Website Log On**, you can substitute fingerprint authentication for entering information required to access the password-protected web sites. For detailed information, see the help file included with the **TrueSuite**.



To see the help file, click **Start, All Programs, TrueSuite**, and **TrueSuite**.



You may not be able to use the **Website Log On** feature depending on the web site you access.

- ❑ **Quick Launch** function for quick application access  
The **Quick Launch** feature is available on your computer for launching your preferred application (executable file) that is assigned to one of your fingers with a registered fingerprint. Once you have assigned an application to your finger, you can launch the assigned application simply by swiping the finger across the fingerprint sensor.

## Registering a Fingerprint

To use the fingerprint authentication function, you must register your fingerprint(s) in your computer.



## To register a fingerprint

- 1 Click **Start, All Programs, TrueSuite**, and **TrueSuite**.
- 2 Click **Get Started**.
- 3 Follow the on-screen instructions.  
If the Windows password setting window appears, set the Windows password.



See the help file included with the **TrueSuite** for more detailed information.

If you have failed to register a fingerprint, follow these steps to try again.

- 1 Place the top joint of your finger flat in the center of the fingerprint sensor (1).

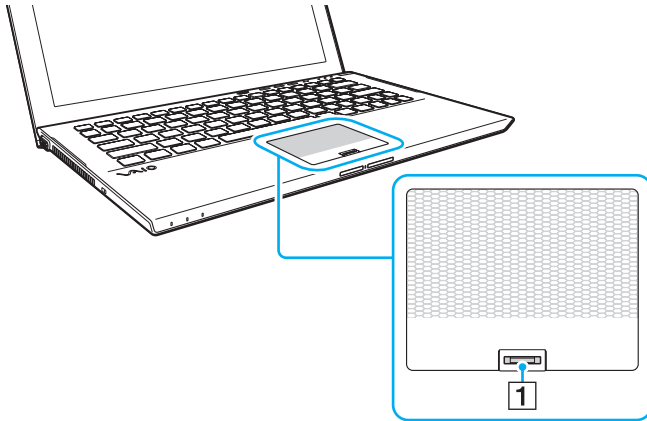

- 2 Swipe your finger perpendicularly across the fingerprint sensor and scan from the top joint of the finger to the fingertip.

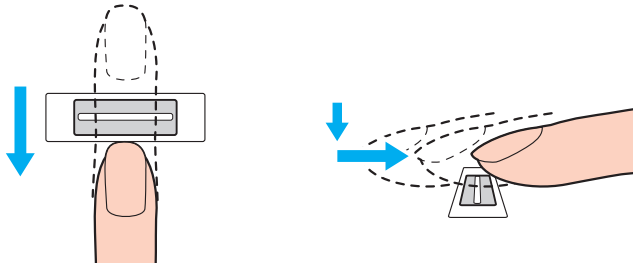

! Keep your finger in contact with the fingerprint sensor while swiping.

Fingerprint registration may fail if you move your finger too quickly or too slowly. Let the fingerprint sensor take about one second to scan your fingerprint.

You may not be able to register and/or have your fingerprint(s) recognized if your finger is too dry or wet, wrinkled, injured, dirty, etc.

Register more than one fingerprint in case that the fingerprint sensor fails to recognize the fingerprint.

Be sure to clean your fingertip(s) and the fingerprint sensor before swiping in order to keep good recognition performance.

## Logging Onto Windows

To use the fingerprint authentication function in place of Windows password entry to log onto your system, you need to set the Windows password and configure your computer for fingerprint authentication. For information on how to set the Windows password, see **Setting the Password (page 96)**.

### To log onto Windows

Swipe the registered finger across the fingerprint sensor when the Windows log-on screen appears. For detailed information, see the help file included with the **TrueSuite**.

## Using the TPM

The Trusted Platform Module (TPM) may be embedded in your computer to provide basic security functions. In combination with the TPM, you can encrypt and decrypt your data to strengthen computer security against inappropriate access.



Some features and options in this section may not be available on your computer.  
See the specifications to find out about the configuration of your computer.

TPMs are defined by Trusted Computing Group (TCG) and also called security chips.

### Important Notice

#### Notes on encrypting the operating system or program files

Encrypting files used by your operating system or any software application, using the Encrypting File System (EFS) with the TPM, will disable you to launch or operate such software.

To avoid such problems, observe the following before using the EFS:

- Be sure to save data you want to encrypt to the following destinations:
  - The **Encrypted Data** folder created with the default settings in the user initialization process
  - A new encrypted folder created in the **My Documents** folder or the **Documents** folder on your account
  - The Personal Secure Drive



The Personal Secure Drive is a virtual drive that is created by using the Personal Secure Drive feature and automatically encrypts data that is saved to it.

- Do not change the following settings on the **View** tab in the **Folder Options** window displayed by clicking **Folder and search options** from **Organize** in the menu of Windows Explorer.
  - Don't show hidden files, folders, or drives**

**Hide protected operating system files (Recommended)**

- Do not change the system attributes of the files, unless necessary.
- Do not encrypt the **Windows** folder, the **Program Files** folder, and all files in each folder.
- Do not encrypt the **Users** folder and all account folders in it.

### Notes on encrypting key files or files on the Personal Secure Drive

Encrypting files created in the following folders when your user account is initialized and the EFS is enabled will disable you to launch your TPM software and decrypt the encrypted data.

With the default settings, the files in the folders below cannot be encrypted because they have system attributes. Do not change the system attributes of the files in the folders below.



The following folders are hidden by default.

- Folders containing key files
  - C:\ProgramData\Infineon
  - C:\Users\All Users\Infineon  
(C:\Users\All Users is a shortcut to C:\ProgramData.)
  - C:\Users\<account>\AppData\Roaming\Infineon
- Files on the Personal Secure Drive
  - C:\Security Platform\Personal Secure Drive\System Data\xxx.FSF

### Notes on encrypting backup files or other files

Encrypting backup archive files or emergency recovery token files will disable you to recover your computer system for emergency, and encrypting password reset token files or secret files will disable you to reset the password.

Do not encrypt the following files or folders:



The default path for files below or displayed by clicking **Browse** is My Documents (or Documents)\Security Platform or Security Platform in removal media.

- Automatic backup archive file  
Default file name: SPSsystemBackup.xml or SPSsystemBackup\_<your computer name>.xml
- Storage folder for automatic backup archive files  
Folder name (Fixed):
  - SPSsystemBackup (The folder is created as the subfolder for the SPSsystemBackup.xml file.)
  - SPSsystemBackup\_<your computer name> (The folder is created as the subfolder for SPSsystemBackup\_<your computer name>.xml file.)
- Emergency recovery token file  
Default file name: SPEmRecToken.xml
- Password reset token file  
Default file name: SPPwResetToken.xml
- Token file for emergency recovery/password reset  
Default file name: SPToken\_<your computer name>.xml
- Password reset secret file  
Default file name: SPPwdResetSecret.xml or SPPwdResetSecret\_<your computer name>\_<user name>.<domain name>.xml
- Key and certificate backup file  
Default file name: SpBackupArchive.xml
- PSD backup file  
Default file name: <Drive name>-Personal Secure Drive.fsb

- ❑ Owner password backup file  
Default file name: SpOwner\_<your computer name>.tpm
- ❑ Protocol file  
Default file name: SpProtocol\_<your computer name>\_<user name>.<domain name>.txt

## Configuring the TPM

To use the embedded TPM, you need to:

- 1 Enable the TPM in the BIOS setup screen.
- 2 Install the **Infineon TPM Professional Package**.
- 3 Initialize and configure the TPM.

To enable the TPM in the BIOS setup screen

- 1 Turn on the computer and press the **F2** key repeatedly until the VAIO logo disappears.  
The BIOS setup screen appears. If the screen does not appear, restart the computer and try again.
- 2 Press the **←** or **→** key to select the **Security** tab, the **↑** or **↓** key to select **Change TPM State**, and then the **Enter** key.
- 3 Press the **↑** or **↓** key to select **Enable** and then the **Enter** key.
- 4 Press the **←** or **→** key to select **Exit**, select **Exit Setup**, and then press the **Enter** key.
- 5 After your system restarts, select **Execute** in the confirmation window and then press the **Enter** key.



You can also disable the TPM and clear the TPM configuration in the BIOS setup screen.

! Before enabling the TPM, be sure to set the power-on password to protect against unauthorized modification of the TPM configuration.

If the TPM is enabled, it will take longer before the VAIO logo appears due to security checks at computer startup.

You will not be able to access any TPM-protected data if you clear the TPM ownership. Before clearing the TPM configuration, be sure to make backup copies of the TPM-protected data.

## To install the Infineon TPM Professional Package

Read the Readme.txt in the **C:\Infineon\Readme** folder. Then, double-click **setup.exe** in the **C:\Infineon** folder to install the package.

To install this package, you must have administrative rights on the computer.

! You need to set a few passwords while installing the **Infineon TPM Professional Package**. Without these passwords, you will not be able to restore any TPM-protected data or backup files. Be sure to write down the passwords and keep them safe and private from other people.

## To initialize and configure the TPM

See the on-screen documentation for detailed information. To open the documentation, click **Start, All Programs, Infineon Security Platform Solution**, and **Help**.

! The maintenance and management of TPM-protected data must be carried out at your own risk. Sony assumes no liability for any defects arising out of your data maintenance and management.

## Using BitLocker Drive Encryption with the TPM

**BitLocker Drive Encryption** is a data encryption feature that is available on models with Windows 7 Ultimate or Windows 7 Enterprise. Enabling **BitLocker Drive Encryption** in conjunction with the TPM encrypts all data on the built-in storage device.

For detailed information on how to use and configure **BitLocker Drive Encryption**, see **Windows Help and Support**.



See the specifications to find out about the configuration of your computer.

## Notes on using BitLocker Drive Encryption

- ❑ Be sure to initialize the TPM with the **Infineon TPM Professional Package** before enabling **BitLocker Drive Encryption**. If you enable it without initializing the TPM, a TPM owner password is not generated, so you will not be able to configure the **Infineon TPM Professional Package**.
- ❑ The **Infineon TPM Professional Package** does not make a backup copy of a file (recovery password) for **BitLocker Drive Encryption**.
- ❑ An additional BitLocker system partition has been pre-configured. This system partition uses 100 MB of your total built-in storage device volume.
- ❑ You must enable the TPM in the BIOS setup screen in order to turn on **BitLocker Drive Encryption**.
- ❑ Do not encrypt data on a storage device (such as a USB flash memory device) on which a recovery key is stored using **BitLocker Drive Encryption**.

### To unlock the encrypted data with a recovery key stored on a USB flash memory device

To unlock the encrypted data with a recovery key stored on a USB flash memory device, your system needs to access the USB flash memory device when you boot the computer. Follow these steps to configure the boot order in the BIOS setup screen:

- 1 Connect a USB flash memory device.
- 2 Turn on the computer and press the **F2** key repeatedly until the VAIO logo disappears.  
The BIOS setup screen appears. If the screen does not appear, restart the computer and try again.
- 3 Press the **←** or **→** key to select the **Security** tab, the **↑** or **↓** key to select **Change TPM State**, and then the **Enter** key.
- 4 Press the **↑** or **↓** key to select **Enable** and then the **Enter** key.



- 5 Press the ← or → key to select **Boot** and then select **Enabled** for **External Device Boot**.
- 6 Press the ↑ or ↓ key to select **Boot Priority** and then the **Enter** key.
- 7 Press the **F5** or **F6** key to change the boot device order so that **Internal Hard Disk** is listed higher than **External Device**.

! You need to move **Internal Optical Drive** to the top of the list to recover the computer system using your Recovery Media.

- 8 Press the ← or → key to select **Exit**, select **Exit Setup**, and then press the **Enter** key.
- 9 After your system restarts, select **Execute** in the confirmation window and then press the **Enter** key.
- 10 Follow the instructions in **Windows Help and Support** to enable **BitLocker Drive Encryption**.
- 11 Save the recovery password to the USB flash memory device in the window for saving the recovery password.
- 12 Follow the on-screen instructions.  
The encryption process will start.

! Updating your BIOS with updating software, such as the **VAIO Update**, changes the BIOS settings back to the default. You need to repeat the steps above again.

It takes several hours to complete the encryption process.

## Using Peripheral Devices

You can add functionality to your VAIO computer by using the various ports on the computer.

- ❑ **Using the Noise Canceling Headphones** ([page 74](#))
- ❑ **Connecting a Docking Station** ([page 79](#))
- ❑ **Connecting External Speakers or Headphones** ([page 87](#))
- ❑ **Connecting an External Display** ([page 88](#))
- ❑ **Selecting Display Modes** ([page 91](#))
- ❑ **Using the Multiple Monitors Function** ([page 92](#))
- ❑ **Connecting a USB Device** ([page 93](#))

## Using the Noise Canceling Headphones

A pair of noise canceling headphones may be supplied with your computer.



Some features and options in this section may not be available on your computer.  
See the specifications to find out about the configuration of your computer.

The noise canceling headphones are equipped with a built-in microphone that picks up ambient noises and outputs an antiphase sound to reduce the noises.

### Before You Use the Noise Canceling Headphones

- ❑ You can enable the noise canceling function only when the supplied noise canceling headphones are connected to the headphones jack that supports this function.
- ❑ The noise canceling function does not work on sound output with the following devices:

- ❑ External speakers
- ❑ Headphones without the noise canceling function
- ❑ Sound output devices connected to your computer via a BLUETOOTH connection
- ❑ The noise canceling function cannot be fully in effect unless you properly wear the headphones. Be sure to fit earpieces of the headphones tightly into your ears.



If you feel that the noise canceling function has little effect, adjust the earbud position in the earpieces of the noise canceling headphones or replace the earbuds with a pair in another size. A pair of medium-size earbuds is attached to the earpieces by default and there should be an extra pair in each small and large sizes supplied with the headphones.

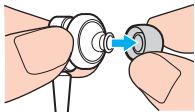

- ❑ The noise canceling function is to reduce low-frequency noise in the ambient environment but not high-frequency noise. Nor is it to implement a 100% noise-free audio environment.
- ❑ When the noise canceling function does not seem to be working, unplug the supplied noise canceling headphones completely and then plug them back again.
- ❑ Keep the built-in microphone (1) of the noise canceling headphones unblocked to ensure that the noise canceling function can be fully in effect.

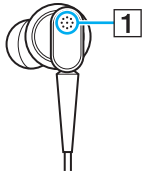

- ❑ You may hear a soft hissing noise while the noise canceling function is enabled. This is just operational noise that the function generates and does not indicate a malfunction.
- ❑ You may feel that the noise canceling function has little effect or ambient noises seem even louder, depending on the type of noise or the degree of quietness in your environment. In such a case, disable the noise canceling function.
- ❑ Use of a mobile phone may cause radio interference with the noise canceling headphones. When using the headphones, keep mobile phones away from the headphones.
- ❑ Plugging or unplugging the noise canceling headphones generates noise. This is normal and does not indicate a malfunction. Be sure to take off the headphones from your ears before plugging or unplugging the headphones.
- ❑ Enabling/disabling the noise canceling function or enabling/disabling sound with the Windows volume controls generates noise. This is caused by switching the noise canceling circuit and does not indicate a malfunction.
- ❑ Be sure to use the supplied noise canceling headphones. You can plug the headphones supplied with a Walkman® to your computer but the noise canceling function of the computer will not work well with such headphones.
- ❑ If you configure your noise canceling headphones to pick up sounds from its built-in microphone and output them through the earpieces, the sounds will be amplified. Be careful about the volume when you change the configuration.

## Connecting the Noise Canceling Headphones

To connect the noise canceling headphones

Plug the headphones cable into the headphones jack .

The  icon appears on the taskbar to indicate that the noise canceling function is enabled and a balloon message pops up from the icon.



When the  icon is on the taskbar, the noise canceling function is disabled. Right-click the icon and select **Enable Noise Canceling Function** from the menu.

If no icon is on the taskbar, see **What to do if the icon and the balloon do not appear** ([page 78](#)) to change the settings.

## Adjusting the Effect of the Noise Canceling Function

The noise canceling headphones supplied with your computer is configured to yield the optimum effect by default.

If you feel that the noise canceling function is not fully in effect, you may be able to adjust the effect with the **Noise Canceling Control** slider on the **Noise Canceling Headphones** window.

To adjust the effect of the noise canceling function

- 1 Right-click the  icon on the taskbar and select **Settings....**



If no icon is on the taskbar, see **What to do if the icon and the balloon do not appear** ([page 78](#)) to change the settings.

- 2 Drag the **Noise Canceling Optimization** slider to select your desired noise canceling level.



The slider should be at the center of the range to yield the optimum level. Dragging the slider all the way to the maximum level does not bring the noise canceling function fully into effect.

- 3 Click **Apply**.
- 4 Confirm that the noise canceling effect is satisfactory and then click **OK**.

## Using the microphone directivity function

Just like an ordinary microphone, the built-in microphone of the noise canceling headphones picks up ambient sounds coming from all directions. The microphone directivity (beamforming) function, however, can reduce ambient noises and pick up mainly your voice and sounds coming from your front and rear.

The microphone directivity function comes in handy when you want your voice to sound clearly while chatting or when you want to use the headphones as a microphone to record your own voice or sounds coming from your front.

### To enable the microphone directivity function

- 1 Right-click the  icon on the taskbar and select **Settings...**





If no icon is on the taskbar, see **What to do if the icon and the balloon do not appear** ([page 78](#)) to change the settings.

- 2 Click the **Microphone directivity** tab and select the **Enable the microphone directivity function** check box.
- 3 Click **OK**.



When ambient noises are extremely loud, the microphone directivity function may not become fully in effect or the volume level of the noises may fluctuate at short intervals.

## What to do if the icon and the balloon do not appear

When the noise canceling function icon (/) is not on the taskbar and the balloon message does not pop up from the icon, change the noise canceling function settings.

To display the balloon message and the icon

- 1 Click **Start** and **Control Panel**.
- 2 Click **Hardware and Sound**.
- 3 Click **Manage audio devices** under **Sound**.
- 4 On the **Playback** tab, double-click the speakers or headphones icon.
- 5 Click the **Enhancements** tab.
- 6 Click to select the **Noise Canceling Function** check box and click **Modify Settings**.  
 If the **Disable all enhancements** check box is selected, click to cancel the check box.
- 7 Click to select the **Display an icon for the noise canceling headphones in the task tray** or **Display a message when noise canceling headphones are connected** check box.
- 8 Click **OK**.

## Connecting a Docking Station

A docking station may be supplied with your computer.

Connecting a docking station enables you to use optical disc media with your computer and connect additional peripherals to the computer, such as a printer and an external display.



Some features and options in this section may not be available on your computer.  
See the specifications to find out about the configuration of your computer.

## Locating Ports on the Docking Station

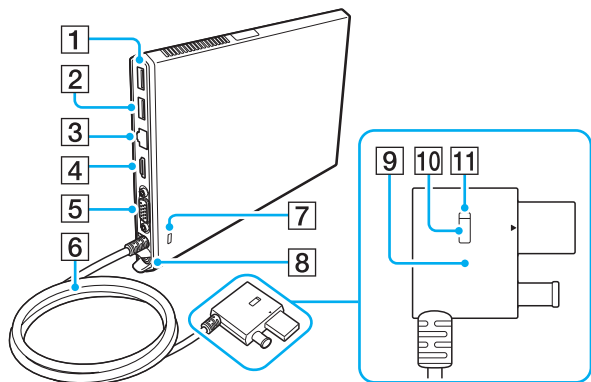

**HDMI**™  
HIGH-DEFINITION MULTIMEDIA INTERFACE

- 1 USB port\*<sup>1</sup> (page 93)
- 2 USB port\*<sup>2</sup> (page 93)
- 3 LAN port (page 51)
- 4 HDMI output port (page 89)
- 5 Monitor port (page 88)
- 6 Connector cable
- 7 Security slot
- 8 DC IN port (page 81)
- 9 Docking station connector (page 81)
- 10 UNDOCK button (page 85)
- 11 IN USE indicator (page 85)

Illuminates while the communication between the docking station and the computer is active.

\*1 Compliant with the USB 2.0 standard.

\*2 Compliant with the USB 2.0/3.0 standards. USB ports that are compliant with the USB 3.0 standard are identifiable by their blue color.



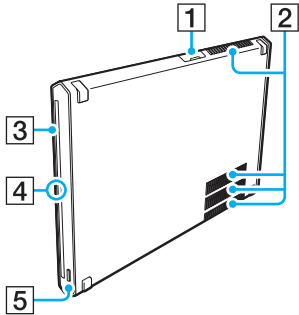

- 1 USB port\* (page 93)
  - 2 Air vents
  - 3 Optical disc drive (page 38)
  - 4 Disc drive indicator  
Illuminates while data access to the optical disc drive is in progress.
  - 5 Drive eject button (page 34), (page 38)
- \* Compliant with the USB 2.0 standard.

**!** The docking station can be powered only through the AC adapter supplied with the docking station. Do not unplug the AC adapter from the docking station or the AC outlet while using the docking station. This may cause data damage or hardware malfunctions.

## Connecting the Docking Station to Your Computer

To connect the docking station to your computer

**!** Be sure to use the AC adapter supplied with the docking station.

- 1 Attach the docking station to the supplied vertical stand.

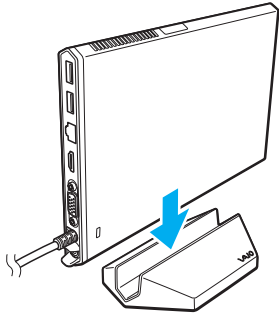

**!** Do not stand the docking station upside down. Be sure to attach it in the direction illustrated above.



If you do not use the supplied vertical stand when using the docking station, you can lay down the docking station as illustrated below.

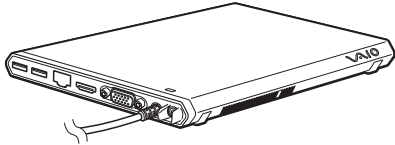

- 2 Plug one end of the power cord (1) into the AC adapter (2) and the other end into an AC outlet.
- 3 Plug the cable connected to the AC adapter (2) into the DC IN port (3) on the docking station (4).

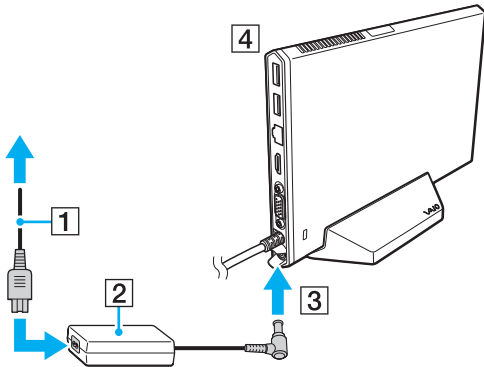

- 4 Plug the docking station connector to both the docking station/USB port and the DC IN port on your computer.

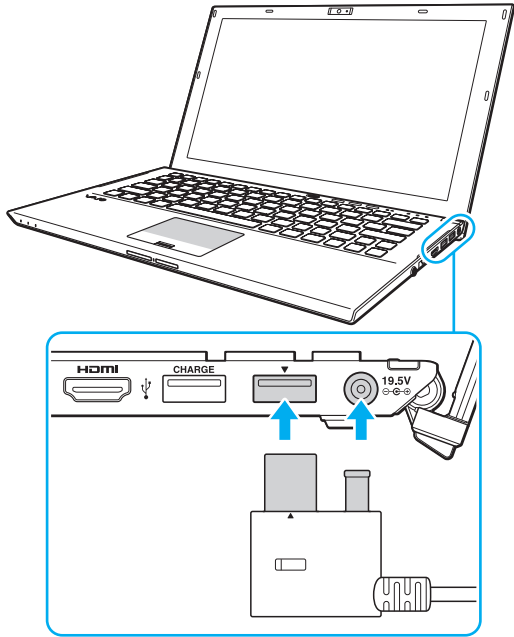

## Disconnecting the Docking Station from Your Computer



Make sure that no devices connected to the docking station are in use before disconnecting it from your computer.

Do not disconnect docking station from your computer while the IN USE indicator light is lit. Disconnecting the docking station while the IN USE indicator light is lit may result in loss of unsaved data or a failure of the computer.

When the battery pack is running out of power, disconnecting the docking station from your computer may result in loss of unsaved data.

### To disconnect the docking station from your computer

- 1 Press the UNDOCK button (1) and wait until the IN USE indicator light (2) turns off.

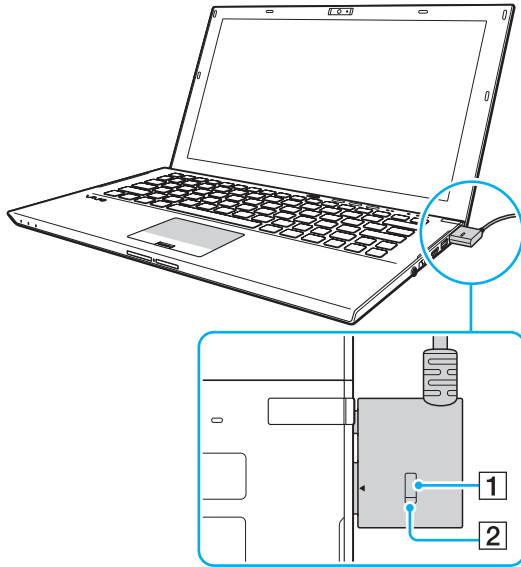

- 2 Hold the docking station connector and unplug it from your computer.



If the IN USE indicator light is unlit, you do not have to press the UNDOCK button.

Alternatively, you can disconnect the docking station from the computer as follows:

- 1 Click **Start**, the arrow next to the **Shut down** button, and **Undock**.
- 2 Make sure that a message balloon appears and the IN USE indicator light turns off. Then unplug the docking station connector from the computer.



To disconnect the docking station completely from AC power, unplug the AC adapter.

## Connecting External Speakers or Headphones

You can connect external sound output devices (not supplied), such as speakers or headphones, to your computer.

To connect external speakers



Make sure your speakers are designed for computer use.



Turn down the volume of the speakers before you turn them on.

The noise canceling function does not work on sound output through external speakers.

Connect external speakers (1) to the headphones jack (2)  with a speaker cable (3) (not supplied).

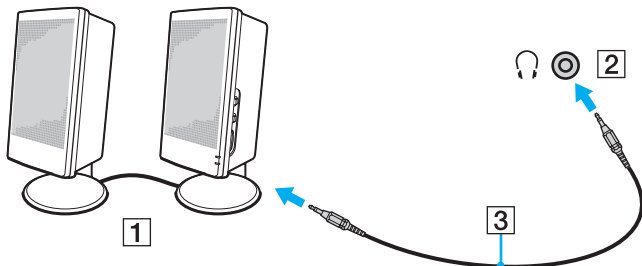

## Connecting an External Display



Some features and options in this section may not be available on your computer.

### Connecting a Computer Display or a Projector

You can connect an external display, such as a computer display or a projector, either directly to your computer or via the docking station.

To connect a computer display or a projector

- 1 Plug the power cord (1) of your external display or the projector into an AC outlet.
- 2 Connect the external display or the projector to the monitor port (2) on the computer or the docking station with a display cable (3).

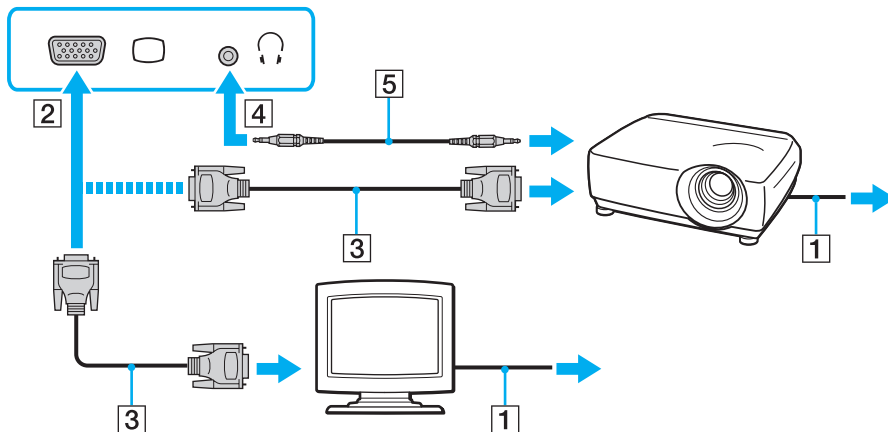





If necessary, connect the headphones jack on the projector and the headphones jack (4)  on the computer with a speaker cable (5).



Your computer is compliant with the HDCP standard and capable of encrypting the transmission channel of digital video signals for the purpose of copyright protection, which enables you to play and view a wide variety of copyright protected and high-quality content. To view the copyright protected content, connect an HDCP-compliant monitor to the **HDMI** output port on your computer or the docking station. If your computer has a non-compliant monitor connected, you will not be able to play or view any copyright protected content.



If the external computer display is equipped with an HDMI input port, plug one end of an HDMI cable into the **HDMI** output port on the computer or the docking station and the other end into the HDMI input port on the computer display.

To connect a TFT/DVI monitor, use an HDMI to DVI-D adapter to connect it to the **HDMI** output port on the computer or the docking station.

DVI-D stands for Digital Visual Interface - Digital. It is a type of DVI port that supports only digital video signals (no analog video signals). It has 24 pins.

A DVI-I (Digital Visual Interface - Integrated) port supports digital video and analog video signals. It has 29 pins.

The HDMI cable carries both video and audio signals.

## Connecting a TV with an HDMI Input Port

You can connect a TV with an HDMI input port to your computer.

To connect a TV to your computer



To hear sound from the device connected to the **HDMI** output port, you need to change the device for sound output. For detailed instructions, see **How do I change the sound output device?** (page 146).

- 1 Plug the power cord of your TV (1) into an AC outlet.

- 2 Plug one end of an HDMI cable (2) to the **HDMI** output port (3) on the computer or the docking station and the other end to the TV.
- 3 Switch the input channel of the TV to external input.
- 4 Set up the TV configuration system.

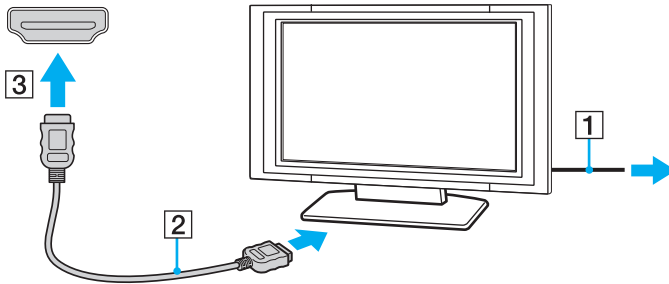

! If a device driver other than the one provided by Sony is used, the image will not be displayed and the audio will not be heard. Always use the device driver provided by Sony for updates.



See the manual that came with your TV for more information on installation and use.

The HDMI cable carries both video and audio signals.

## To connect a high-quality digital sound output device between your computer and a TV

You can connect a high-quality home theater receiver or other surround sound decoder devices between your computer and TV using an HDMI connection.



Before connecting the device to the computer, make sure the HDMI connection has been set up between the TV and the home theater receiver or surround sound decoder device first.

To hear sound from the device connected to the **HDMI** output port, you need to change the device for sound output. For detailed instructions, see **How do I change the sound output device?** ([page 146](#)).

- 1 Turn on the TV and set its input to the HDMI input.
- 2 Turn on the home theater receiver or surround sound decoder device and set its input to the HDMI input.
- 3 Plug one end of an HDMI cable to the HDMI input port on the home theater receiver or surround sound decoder device and the other end to the **HDMI** output port on the computer or the docking station.



You can adjust the screen resolution of the connected TV with your computer. See **Why doesn't my screen display a video?** ([page 139](#)) for more information.

With the HDMI connection, the volume can be adjusted by the connected audio device only. Your computer has no control over the output volume of any connected devices.

## Selecting Display Modes

When an external display is connected, you can select either your computer screen or the connected display to use as the primary monitor.



You may not be able to display the same content on your computer screen and the external display or projector at the same time, depending on the type of your external display or projector.

Turn on the external display before turning on your computer.

To select a display mode with the Fn+F7 keys

You can select a display mode with the **Fn+F7** keys. See **Combinations and Functions with the Fn Key** ([page 30](#)) for more information.

To select a display mode from the display settings

- 1 Right-click on the desktop and select **Screen resolution**.
- 2 Click the drop-down list next to **Multiple Displays**, select your desired setting, and then click **OK**.

## Using the Multiple Monitors Function

The Multiple Monitors function allows you to distribute portions of your desktop across separate displays. For example, if you have an external display connected to your computer, your computer screen and the external display can function as a single desktop.

You can move the cursor from one display to the other. This allows you to drag objects, such as an open application window or a toolbar, from one display to the other.

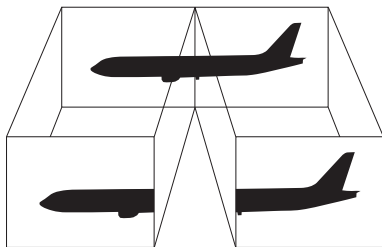

## To use the Multiple Monitors function



Your external display may not support the Multiple Monitors function.

Certain software applications may not be compatible with Multiple Monitors settings.

Make sure that your computer does not enter Sleep or Hibernate mode while you are using the Multiple Monitors function, or the computer may not return to Normal mode.

If you set different colors on each display, do not expand a single window across two displays, or your software may not work properly.

- 1 Right-click on the desktop and select **Screen resolution**.
- 2 Click the drop-down list next to **Multiple Displays**, select **Extend these displays**, and then click **OK**.



You can set the display colors and resolution for each display and customize the Multiple Monitors function.

Set fewer colors or a lower resolution for each display.

## Connecting a USB Device

You can connect a Universal Serial Bus (USB) device, such as a mouse, a floppy disk drive, a speaker, or a printer, to your computer.

### To connect a USB device

- 1 Choose the USB port (1) you prefer to use.
- 2 Plug the USB device cable (2) into the USB port.

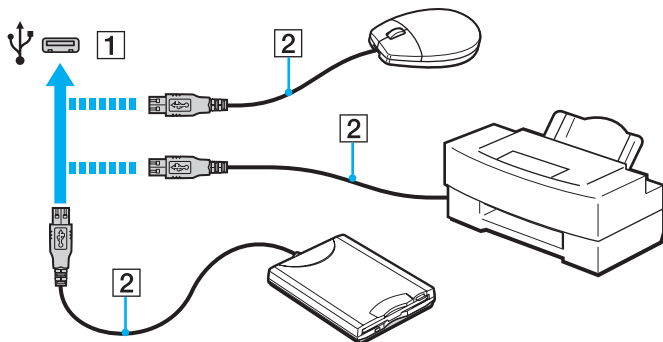

## To charge a USB device

You can charge a USB device by connecting it to the USB port that can supply power while the computer is off, in Hibernate mode, and in Sleep mode as well as in Normal mode.

- 1 Connect your computer to an AC outlet with the AC adapter ([page 18](#)).
- 2 Click **Start**, **All Programs**, and **VAIO Control Center**.
- 3 Click **Power Management** and **USB Charging Settings** and enable the USB charging settings.
- 4 Connect a USB device to the USB port (printed **CHARGE** above it) next to the **HDMI** output port ([page 14](#)).

! When the USB charging settings are enabled, you cannot operate your computer using the remote wake up function with the USB device powered by the USB port on your computer.

If charging does not start when you connect a USB device to the USB port that can supply power, disconnect the device and try connecting it again.

## Notes on connecting a USB device

- ❑ You may need to install the driver software supplied with your USB device before use. See the manual that came with the USB device for more information.
- ❑ Be sure to use a USB printer compatible with your version of Windows to print documents.
- ❑ For information on how to remove a USB device, see the manual that came with the device.
- ❑ To protect your computer and/or USB devices from damage, observe the following:
  - ❑ When moving the computer with USB devices connected, avoid exposing the USB ports to shock or impact.
  - ❑ Do not put the computer into a bag or carrying case when it has USB devices connected.

# Customizing Your VAIO Computer

This section briefly describes how to change the main settings of your VAIO computer. Among other things, you will learn how to use and customize the look of your Sony software and utilities.



- ❑ **Setting the Password** ([page 96](#))
- ❑ **Using the VAIO Control Center** ([page 101](#))
- ❑ **Using the VAIO Power Management** ([page 101](#))

## Setting the Password

Setting the password allows you to protect your computer from unauthorized access by making the user enter the password when the computer is turned on or returns to Normal mode from Sleep mode or Hibernate mode.

**!** Do not forget your password. Write down the password and keep it in a secure place.



Type of Password	Description
Power-on password	<p>You can use BIOS functions to set two types of passwords:</p> <ul style="list-style-type: none"><li>- Machine password: Allows users with administrative rights to change all the setup options in the BIOS setup screen, as well as to start the computer.</li><li>- User password: Allows the standard users to change some of the BIOS setup options, as well as to start the computer. To set the user password, you must first set the machine password.</li></ul> <p> Entry of the power-on password will be prompted after the VAIO logo appears to start your computer.</p> <p> If you forget the machine password, the password needs to be reset and a fee will be charged. To reset the password, contact an authorized Sony service/support center. To find the nearest center or agent, see <b>Finding More about Your VAIO Computer (page 4)</b>. You can reset the user password at the BIOS setup screen by entering the machine password.</p>
Windows password	<p>Allows users to log onto your computer and protect each user account with its own password.</p> <p> Entry of the Windows password will be prompted after you select your user account.</p>

## Setting the Power-on Password

To add the power-on password (machine password)

- 1 Turn on the computer and press the **F2** key repeatedly until the VAIO logo disappears.  
The BIOS setup screen appears. If the screen does not appear, restart the computer and try again.
- 2 Press the **←** or **→** key to select **Security** to display the **Security** tab, select **Set Machine Password**, and then press the **Enter** key.
- 3 On the password entry screen, enter the password twice and press the **Enter** key.  
The password can be up to 32 alphanumeric characters long (including spaces).
- 4 Select **Password when Power On** under **Security** and press the **Enter** key.

- 5 Change the setting from **Disabled** to **Enabled**.
- 6 Press the **←** or **→** key to select **Exit**, select **Exit Setup**, and then press the **Enter** key.  
At the confirmation prompt, press the **Enter** key.

### To add the power-on password (user password)

**!**  
Make sure you set the machine password before setting the user password.

- 1 Turn on the computer and press the **F2** key repeatedly until the VAIO logo disappears.  
The BIOS setup screen appears. If the screen does not appear, restart the computer and try again.
- 2 Enter the machine password and press the **Enter** key.
- 3 Press the **←** or **→** key to select **Security** to display the **Security** tab, select **Set User Password**, and then press the **Enter** key.
- 4 On the password entry screen, enter the password twice and press the **Enter** key.  
The password can be up to 32 alphanumeric characters long (including spaces).
- 5 Press the **←** or **→** key to select **Exit**, select **Exit Setup**, and then press the **Enter** key.  
At the confirmation prompt, press the **Enter** key.

### To change or remove the power-on password (machine password)

- 1 Turn on the computer and press the **F2** key repeatedly until the VAIO logo disappears.  
The BIOS setup screen appears. If the screen does not appear, restart the computer and try again.
- 2 Enter the machine password and press the **Enter** key.
- 3 Press the **←** or **→** key to select **Security** to display the **Security** tab, select **Set Machine Password**, and then press the **Enter** key.

- 4 On the password entry screen, enter the current password once and a new password twice, and then press the **Enter** key. To remove the password, leave the **Enter New Password** and **Confirm New Password** fields blank and press the **Enter** key.
- 5 Press the **←** or **→** key to select **Exit**, select **Exit Setup**, and then press the **Enter** key. At the confirmation prompt, press the **Enter** key.

#### To change or remove the power-on password (user password)

- 1 Turn on the computer and press the **F2** key repeatedly until the VAIO logo disappears. The BIOS setup screen appears. If the screen does not appear, restart the computer and try again.
- 2 Enter the user password and press the **Enter** key.
- 3 Press the **←** or **→** key to select **Security** to display the **Security** tab, select **Set User Password**, and then press the **Enter** key.
- 4 On the password entry screen, enter the current password once and a new password twice, and then press the **Enter** key. To remove the password, leave the **Enter New Password** and **Confirm New Password** fields blank and press the **Enter** key.
- 5 Press the **←** or **→** key to select **Exit**, select **Exit Setup**, and then press the **Enter** key. At the confirmation prompt, press the **Enter** key.

## Setting the Windows Password

#### To add the Windows password

- 1 Click **Start** and **Control Panel**.
- 2 Click **User Accounts and Family Safety** or **User Accounts**.
- 3 Click **User Accounts**.
- 4 Click **Create a password for your account** under **Make changes to your user account**.

- 5 In the **New password** and **Confirm new password** fields, enter the password for your account.
- 6 Click **Create password**.



See **Windows Help and Support** for more information on the Windows password.

To change the Windows password

- 1 Click **Start** and **Control Panel**.
- 2 Click **User Accounts and Family Safety** or **User Accounts**.
- 3 Click **User Accounts**.
- 4 Click **Change your password**.
- 5 In the **Current password** field, enter your current password.
- 6 In the **New password** and **Confirm new password** fields, enter a new password.
- 7 Click **Change password**.

To remove the Windows password

- 1 Click **Start** and **Control Panel**.
- 2 Click **User Accounts and Family Safety** or **User Accounts**.
- 3 Click **User Accounts**.
- 4 Click **Remove your password**.
- 5 In the **Current password** field, enter the current password that you want to remove.
- 6 Click **Remove password**.

## Using the VAIO Control Center

The **VAIO Control Center** utility allows you to access system information and to specify preferences for system behavior.

To use the VAIO Control Center

- 1 Click **Start**, **All Programs**, and **VAIO Control Center**.
- 2 Select your desired control item and change the settings.
- 3 Once finished, click **OK**.  
The setting of the desired item is changed.



For more information about each option, see the help file included with the **VAIO Control Center**.

Some of the control items will not be visible if you open the **VAIO Control Center** as a standard user.

## Using the VAIO Power Management

Power management helps you set up power plans for running on AC or battery power to suit your requirements for power consumption.

The **VAIO Power Management** function is added to the Windows **Power Options**. With this software application, you can enhance the Windows power management functions to ensure better operation of your computer and longer battery life.

### Selecting a Power Plan

When you start the computer, a power status icon appears on the taskbar. This icon indicates what kind of power source you are currently using. Click this icon to display the window that shows your power status.

To select a power plan

- 1 Right-click the power status icon on the taskbar and select **Power Options**.

- 2 Select your desired power plan.

### To change the power plan settings

- 1 Click **Change plan settings** on the right of your desired power plan in the **Power Options** window.  
Change the Sleep mode and display settings as needed.
- 2 If you need to change the advanced settings, click **Change advanced power settings** and go to step 3.  
Otherwise, click **Save changes**.
- 3 Click the **VAIO Power Management** tab.  
Change the settings for each item.
- 4 Click **OK**.

# Precautions

This section describes safety guidelines and precautions to help you protect your VAIO computer from potential damage.



Some features and options in this section may not be available on your computer.

- Safety Information** ([page 103](#))
- Care and Maintenance Information** ([page 105](#))
- Handling Your Computer** ([page 106](#))
- Handling the LCD Screen** ([page 108](#))
- Using the Power Source** ([page 109](#))
- Handling the Built-in Camera** ([page 109](#))
- Handling Discs** ([page 109](#))
- Using the Battery Pack** ([page 110](#))
- Handling "Memory Stick"** ([page 110](#))
- Handling the Built-in Storage Device** ([page 111](#))
- Using Fingerprint Authentication** ([page 112](#))
- Using the TPM** ([page 112](#))

## Safety Information

### Computer

- Use your computer on a solid, stable surface.

- ❑ Do not use your computer directly on your lap. The temperature of the base of the unit will rise during normal operation and over time could result in discomfort or burns.
- ❑ Use only specified peripheral equipment and interface cables.
- ❑ Keep small parts such as "Memory Stick" and "Memory Stick" adaptors out of reach of children. There is a risk of swallowing them.

## Power Source

- ❑ Do not place the AC adapter in contact with your skin. Remove the AC adapter away from your body if it becomes warm and causes discomfort.
- ❑ Do not place heavy objects on the power cord, or this could cause a fire.
- ❑ To disconnect the power cord, pull it out by holding the plug. Never pull the cord itself.
- ❑ Unplug your computer from the AC outlet if you are not planning to use the computer for an extended period of time.
- ❑ When the AC adapter is not used, unplug it from the AC outlet.
- ❑ Make sure that an AC outlet is easily accessible.

## Battery Pack

- ❑ Do not leave battery packs in temperatures above 140°F / 60°C, such as in a car parked in the sun or under direct sunlight.
- ❑ For your safety, Sony recommends using the genuine Sony battery pack and AC adapter provided with this product. If these items need to be replaced during the life of the product, be sure to use a compatible genuine Sony battery pack or AC adapter. Information about compatible models can be found at <http://www.sony.net/>.
- ❑ Sony disclaims and shall assume no responsibility in case of any losses or damages arising from:
  - ❑ The use of non-genuine Sony battery packs or AC adapters with your VAIO computer.
  - ❑ The disassembly, alteration of, or tampering of any Sony battery pack.



- ❑ Keep the battery pack away from all sources of heat.
- ❑ Keep the battery pack dry.
- ❑ Do not open or try to disassemble the battery pack.
- ❑ Do not expose the battery pack to any mechanical shock, such as caused by dropping it on a hard surface.
- ❑ If you are not using your computer for an extended period of time, remove the battery pack from the computer to prevent damage to the battery pack.
- ❑ If you have not used the battery pack for a considerable amount of time, the remaining battery life may become short. This is normal and does not indicate a malfunction. The battery pack will gradually discharge over time even while not in use. Connect the AC adapter to your computer and recharge the battery pack before using the computer again.

## Headphones

- ❑ **Road safety** – Do not use headphones while driving, cycling, or operating any motorized vehicle. It may create a traffic hazard and is illegal in some areas. It can also be potentially dangerous to play loud music while walking, especially at pedestrian crossings.
- ❑ **Preventing hearing damage** – Avoid using headphones at high volume. Hearing experts advise against continuous, loud and extended play. If you experience a ringing in your ears, reduce the volume or discontinue use.

## Care and Maintenance Information

### Computer

- ❑ Clean the cabinet with a soft, dry or lightly moistened cloth with a mild detergent solution. Do not use an abrasive pad, scouring powder, or solvent such as alcohol or benzine, as these may damage the finish of your computer.
- ❑ Make sure you unplug the AC adapter and remove the battery pack before cleaning your computer.

## LCD Screen

- ❑ Use a soft, dry cloth to wipe the surface of the LCD screen. Rubbing the surface could damage the screen.
- ❑ To protect the LCD screen and keyboard from damage, for example in the case of carrying the computer, spread out the cleaning cloth with no wrinkles on the keyboard before closing the LCD screen lid.

## Built-in Camera

Clean the area on and around the built-in camera with a soft, dry cloth. Do not rub the area too hard, as it can be easily scratched.

## Discs

- ❑ Proper care of the disc is essential to its continuous reliability. Do not use solvents (such as benzine, thinner, alcohol, commercially available cleaners, or anti-static spray) which may cause damage to the disc.
- ❑ For normal cleaning, hold the disc by its edges and use a soft cloth to wipe the surface from the center out.
- ❑ If the disc is badly soiled, moisten a soft cloth with water, wring it out well, and use it to wipe the surface of the disc from the center out. Wipe off any remaining moisture with a dry soft cloth.

## Handling Your Computer

- ❑ If you drop a solid object or any liquid onto your computer, shut down the computer, unplug it, and remove the battery pack. You may want to have the computer checked by qualified personnel before operating it again.
- ❑ Do not drop your computer or place any objects on top of the computer.
- ❑ Do not place your computer in a location subject to:
  - ❑ Heat sources, such as radiators or air ducts
  - ❑ Direct sunlight

- Excessive dust
- Moisture or rain
- Mechanical vibration or shock
- Strong magnets or speakers that are not magnetically shielded
- Ambient temperature of more than 95°F / 35°C or less than 41°F / 5°C
- High humidity
- Do not place electronic equipment near your computer. The electromagnetic field of the equipment may cause the computer to malfunction.
- Do not use your computer without installing the battery pack as it may cause the computer to malfunction.
- Your computer uses high-frequency radio signals and may cause interference to radio or TV reception. If this occurs, move the computer a suitable distance away from the radio or TV.
- Do not use cut or damaged connection cables.
- If your computer is brought directly from a cold location to a warm one, moisture may condense inside the computer. In such a case, allow at least one hour before turning on the computer. If any problems occur, unplug the computer and contact an authorized Sony service/support center. To find the nearest center or agent, see **Finding More about Your VAIO Computer (page 4)**.
- To avoid losing data when your computer is damaged, back up your data regularly.
- Do not exert pressure on the LCD screen or its edges when opening the LCD screen lid or lifting your computer. The LCD screen may be sensitive to pressure or added stress, and exerting pressure may damage the screen or cause it to malfunction. To open the computer, hold the base with one hand and gently lift the LCD screen lid with the other. To carry the computer with the lid open, be sure to hold the computer with both hands.

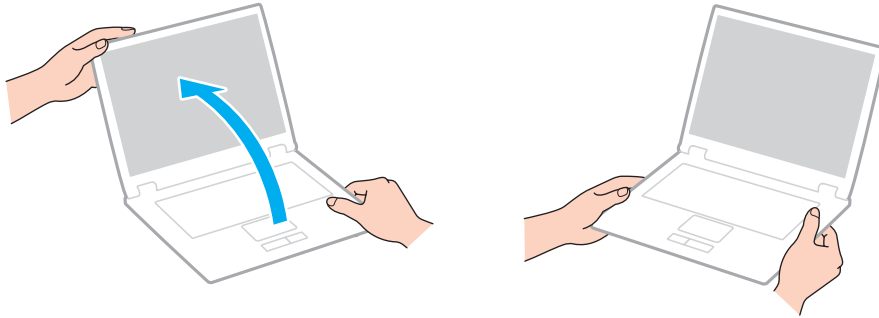

- ❑ Use a carrying case specially designed to carry your computer.

## Handling the LCD Screen

- ❑ Do not leave the LCD screen facing the sun. This could damage the LCD screen. Be sure to block direct sunlight when using your computer near a window.
- ❑ Do not scratch the surface of the LCD screen or exert pressure on it. This could cause a damage.
- ❑ Using your computer in low temperature conditions may produce a residual image on the LCD screen. This does not indicate a malfunction. When the computer returns to normal temperature, the screen returns to normal.
- ❑ A residual image may appear on the LCD screen if the same image is displayed for an extended period of time. The residual image disappears after a while. You can use a screen saver to prevent residual images.
- ❑ The LCD screen becomes warm during operation. This is normal and does not indicate a malfunction.
- ❑ The LCD screen is manufactured using high-precision technology. You may, however, see tiny black points and/or bright points (red, blue, or green) that continuously appear on the LCD screen. This is a normal result of the manufacturing process and does not indicate a malfunction.

- ❑ Do not change the LCD screen orientation setting in the **Tablet PC Settings** window even when there are change options available for selection, as this may make your computer unstable. Sony assumes no liability for any malfunctions arising from changes to the settings.
- ❑ Do not exert pressure on the LCD screen lid with the lid closed as it may scratch the LCD screen or soil it.
- ❑ Closing the LCD screen lid with a LAN cable or a display cable connected to your computer may cause damage to the corresponding port on the computer. Be sure to disconnect each cable from the computer before closing the lid.

## Using the Power Source

- ❑ Do not share an AC outlet with other power-consuming equipment, such as a photocopier or a shredder.
- ❑ You can purchase a power strip with a surge protector. This device helps prevent damage to your computer caused by sudden power surges, in an electrical storm, for example.
- ❑ Use the AC adapter supplied with your computer or genuine Sony products. Do not use any other AC adapter as it may cause a malfunction.

## Handling the Built-in Camera

- ❑ Do not scratch or soil the area on and around the built-in camera, as it may cause poor quality images.
- ❑ Do not let the direct sunlight get into the lens of the built-in camera regardless of your computer's power state, as it may cause the camera to malfunction.

## Handling Discs

- ❑ Fingerprints and dust on the surface of a disc may cause read errors. Be sure to hold the disc by its edges and central hole, as shown below:

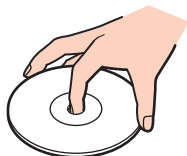

- Never affix an adhesive label to a disc. This will affect the use of the disc and may result in irreparable damage.

## Using the Battery Pack

- Battery life is shorter in a cold environment. This is due to decreased battery efficiency at low temperatures.
- Charge battery packs at temperatures between 50°F / 10°C to 86°F / 30°C. Lower temperatures require longer charging time.
- Do not charge the battery pack in any way other than as described in this user guide or as designated by Sony in writing.
- While the battery pack is in use or being charged, heat builds up in the battery pack. This is normal and is not cause for concern.
- You do not need to discharge the battery pack before recharging.
- If the battery pack quickly runs out of power after being fully charged, it may be reaching the end of its life and should be replaced.

## Handling "Memory Stick"

- Do not touch the "Memory Stick" connector with your finger or metallic objects.
- Use only the adhesive label supplied with "Memory Stick".
- Do not bend, drop, or expose "Memory Stick".
- Do not disassemble or modify "Memory Stick".

- Keep "Memory Stick" dry.
- Do not use or store "Memory Stick" in a location subject to:
  - Static electricity
  - Electrical noise
  - Extremely high temperatures, such as in a car parked in the sun
  - Direct sunlight
  - High humidity
  - Corrosive substances
- Use the storage case supplied with "Memory Stick".
- Be sure to make a backup copy of your valuable data.
- When using "Memory Stick Duo", do not use a fine-tipped pen to write on the label adhered to "Memory Stick Duo". Exerting pressure on the media may damage internal components.

## Handling the Built-in Storage Device

The built-in storage device (hard disk drive or solid state drive) has a high storage density and reads or writes data in a short time. However, it can be easily damaged if improperly used. If the built-in storage device is damaged, the data cannot be restored. To prevent losing data, you should be careful when handling your computer.

### To avoid damaging your built-in storage device

- Do not subject your computer to sudden movements.
- Keep your computer away from magnets.
- Do not place your computer in a location subject to mechanical vibration or in an unstable position.
- Do not turn off the power or restart your computer while reading or writing data to the storage device.

- ❑ Do not use your computer in a place subject to extreme changes in temperature.
- ❑ Do not remove the storage device from your computer.

## Using Fingerprint Authentication

- ❑ The fingerprint authentication technology does not ensure complete user authentication or complete protection of your data and hardware.  
Sony assumes no liability for any problems and damages arising out of your use of or inability to use the fingerprint sensor.
- ❑ The fingerprint recognition rate depends on your operating conditions and varies among individuals as well.
- ❑ In case the built-in storage device has to be initialized, for example after the repair work, the fingerprint templates will be lost. You will have to register them all over again.
- ❑ The maintenance and management of data concerning fingerprint authentication must be carried out at your own risk. Sony assumes no liability for any defects arising out of your data maintenance and management.
- ❑ A fingerprint sensor may malfunction or be damaged if you scratch its surface with:
  - ❑ a solid or sharp-pointed object
  - ❑ fine objects, for example swiping a finger covered with dirt across the fingerprint sensor
- ❑ Discharge static electricity from your finger by touching a metallic object especially during dry seasons (e.g. winter) before scanning your fingerprint. Static electricity may cause the fingerprint sensor to malfunction.

## Using the TPM

- ❑ Although your computer is provided with the TPM security functions, these functions do not ensure complete protection of your data and hardware. Sony assumes no liability for any problems and damages arising out of your use of the functions.



- ❑ After you have installed the **Infineon TPM Professional Package**, you need to set a few TPM passwords on your computer. Without these passwords, you will not be able to restore any TPM-protected data. Be sure to write down the passwords and keep them safe and private from other people.
- ❑ Be sure to make backup copies of the latest emergency recovery archive file, emergency recovery token file, password reset token file, and personal secret file and keep them safe and private from other people before sending your computer for repair. The data stored in the TPM that is embedded on the motherboard may be lost or corrupted during the course of repair.
- ❑ During the course of repair, the TPM will also be replaced if the motherboard needs replacement. In such a case, use the backup copies of the emergency recovery archive file, emergency recovery token file, password reset token file, and personal secret file to restore the TPM configuration.
- ❑ Be sure to make a backup copy of the data stored on the built-in storage device before sending your computer for repair. The built-in storage device may be initialized and returned after the repair work and, in such a case, you will not be able to restore the data on the device using the backup copies of the emergency recovery archive file, emergency recovery token file, password reset token file, and personal secret file.
- ❑ Make sure you set up the automatic backup operations after completing the TPM initialization wizard. If the window containing the **Run automatic backup now** check box is displayed after the setup, select the check box and update the backup files. The restore process using the backup files may fail if you do not set up the automatic backup operations.
- ❑ The maintenance and management of TPM-protected data must be carried out at your own risk. Sony assumes no liability for any defects arising out of your data maintenance and management.

# Troubleshooting

This section describes how to solve common problems you might encounter when using your VAIO computer. Many problems have simple solutions. If these suggestions fail to solve your problems, use the **VAIO Care**. To launch the software, see **Using the VAIO Care (page 28)**.

If the problems still cannot be solved and you need assistance, visit the support web sites listed in **Finding More about Your VAIO Computer (page 4)**.



Some features and options in this section may not be available on your computer.

- Computer Operations (page 115)**
- System Update / Security (page 120)**
- Recovery / Recovery Media (page 120)**
- Partition (page 123)**
- Battery Pack (page 123)**
- Built-in Camera (page 125)**
- Networking (LAN/Wireless LAN) (page 127)**
- Wireless WAN (page 130)**
- BLUETOOTH Technology (page 131)**
- Optical Discs (page 134)**
- GPS (page 137)**
- Display (page 137)**
- Printing (page 140)**

- ❑ **Microphone** ([page 141](#))
- ❑ **Speakers** ([page 142](#))
- ❑ **Touch Pad** ([page 143](#))
- ❑ **Keyboard** ([page 144](#))
- ❑ **Floppy Disks** ([page 144](#))
- ❑ **Audio/Video** ([page 145](#))
- ❑ **"Memory Stick"** ([page 147](#))
- ❑ **Peripherals** ([page 148](#))
- ❑ **Docking Station** ([page 148](#))



## Computer Operations

### What should I do if my computer does not start?

- ❑ Make sure your computer is securely plugged into a power source and turned on and the power indicator light is lit.
- ❑ Make sure the battery pack is installed properly and charged. If an extended battery pack is attached to the computer, make sure both the primary battery pack and the extended battery pack are installed properly and charged.
- ❑ Disconnect all connected USB devices (if any), and then restart your computer.
- ❑ If your computer is plugged into a power strip or an uninterruptible power supply (UPS), make sure the power strip or UPS is plugged into a power source and turned on.
- ❑ If you are using an external display, make sure it is plugged into a power source and turned on. Make sure the brightness and contrast controls are adjusted correctly. See the manual that came with your display for more information.
- ❑ Unplug the AC adapter and remove the battery pack. Wait three to five minutes. Reinstall the battery pack, plug the AC adapter, and then press the power button to turn on your computer.

- ❑ Condensation may cause your computer to malfunction. If this occurs, do not use the computer for at least one hour.
- ❑ Check that you are using the supplied Sony AC adapter. For your safety, use only the genuine Sony rechargeable battery pack and AC adapter, which are supplied by Sony for your VAIO computer.

## What should I do if the green power indicator light turns on but my screen remains blank?

- ❑ Press the **Alt+F4** keys several times to close the application window. An application error may have occurred.
- ❑ If the **Alt+F4** keys do not work, click **Start**, the arrow next to the **Shut down** button, and **Restart** to restart your computer.
- ❑ If your computer does not restart, press the **Ctrl+Alt+Delete** keys and click the arrow  next to the **Shut down**  button and **Restart**.  
If the **Windows Security** window appears, click **Restart**.
- ❑ If this procedure does not work, press and hold the power button for more than four seconds to shut down your computer. Unplug the AC adapter and leave the computer for about five minutes. Then plug the AC adapter and turn on the computer again.

! Turning off your computer with the **Ctrl+Alt+Delete** keys or the power button may cause loss of unsaved data.

## What should I do if my computer or software stops responding?

- ❑ If your computer stops responding while a software application is running, press the **Alt+F4** keys to close the application window.
- ❑ If the **Alt+F4** keys do not work, click **Start** and the **Shut down** button to turn off your computer.
- ❑ If your computer does not turn off, press the **Ctrl+Alt+Delete** keys and click the **Shut down** button.  
If the **Windows Security** window appears, click **Shut Down**.
- ❑ If this procedure does not work, press and hold the power button until the computer turns off.

! Turning off your computer with the **Ctrl+Alt+Delete** keys or the power button may cause loss of unsaved data.

- ❑ Unplug the AC adapter and remove the battery pack. Wait three to five minutes. Reinstall the battery pack, plug the AC adapter, and then press the power button to turn on your computer.
- ❑ Try reinstalling the software.
- ❑ Contact the software publisher or designated provider for technical support.

## Why doesn't my computer enter Sleep or Hibernate mode?

Your computer may become unstable if the operating mode is changed before the computer completely enters Sleep or Hibernate mode.

To restore your computer to Normal mode

- 1 Close all open programs.
- 2 Click **Start**, the arrow next to the **Shut down** button, and **Restart**.
- 3 If your computer does not restart, press the **Ctrl+Alt+Delete** keys and click the arrow next to the **Shut down** button and **Restart**.  
If the **Windows Security** window appears, click **Restart**.
- 4 If this procedure does not work, press and hold the power button until the computer turns off.

! Turning off your computer with the **Ctrl+Alt+Delete** keys or the power button may cause loss of unsaved data.

## What should I do if the charge indicator light is blinking fast and my computer does not start?

- ❑ This problem could be due to the battery pack not being installed properly. To solve this problem, turn off your computer and remove the battery pack. Then reinstall the battery pack to the computer. For details, see **Installing/Removing the Battery Pack (page 19)**.
- ❑ If the problem persists, it means the installed battery pack is not compatible. Remove the battery pack and contact an authorized Sony service/support center. To find the nearest center or agent, see **Finding More about Your VAIO Computer (page 4)**.

## Why does the System Properties window display a slower CPU speed than the maximum?

This is normal. Because your computer's CPU utilizes a type of CPU speed controlling technology for power conservation purposes, System Properties may display the current CPU speed instead of the maximum speed.

## What should I do if my computer does not accept my password and returns a message, Enter Onetime Password?

If you enter a wrong power-on password three times consecutively, the **Enter Onetime Password** message appears and Windows will not start. Press and hold the power button for more than four seconds to check that the power indicator light turns off. Wait for 10 to 15 seconds, then restart your computer and enter the correct password. The password is case sensitive, so be sure to check letters for the current case before you enter the password.

## What should I do if my game software does not work or it keeps crashing?

- ❑ Check the web site of the game if there are any patches or updates to download.
- ❑ Make sure you have installed the latest video driver software.

- ❑ On some VAIO models, the graphics memory is shared with the system. The optimal graphic performance in such a case is not guaranteed.

## Why doesn't my screen turn off after the automatic turn-off time has passed?

Some software applications or screen savers are designed to temporarily disable the feature of your operating system that turns off the computer screen or places the computer into Sleep mode after a certain period of inactivity. To solve this problem, exit the running software application(s) or change the current screen saver.

## How can I change the boot device order?

You can use one of the BIOS functions to change the boot device order. Follow these steps:

- 1 Turn on the computer and press the **F2** key repeatedly until the VAIO logo disappears.  
The BIOS setup screen appears. If the screen does not appear, restart the computer and try again.
- 2 Press the **←** or **→** key to select **Boot**.
- 3 Press the **↑** or **↓** key to select the drive whose boot device order you want to change.
- 4 Press the **F5** or **F6** key to change the boot device order.
- 5 Press the **←** or **→** key to select **Exit**, select **Exit Setup**, and then press the **Enter** key.  
At the confirmation prompt, press the **Enter** key.

## What should I do if I cannot boot my computer from the USB floppy disk drive connected to the computer?

To boot your computer from the USB floppy disk drive, you need to change the boot device.

Turn on your computer and press the **F11** key repeatedly until the VAIO logo disappears.

## System Update / Security

### How can I find important updates for my computer?

You can find and install the latest updates on your computer with the software applications: the **Windows Update** and the **VAIO Update**. See **Updating Your Computer** ([page 26](#)) for more information.

### How do I schedule the installation of Windows updates to my computer?

The Microsoft Windows operating system is preinstalled on your computer. The best way to protect your computer against security threats, such as viruses, is to download and install the latest Windows updates regularly.

You can get important Windows updates by doing the following:

! Your computer must be connected to the Internet to download the updates.

- 1 Click **Start** and **Control Panel**.
- 2 Click **System and Security**.
- 3 Click **Action Center**.
- 4 Follow the on-screen instructions to set up automatic or scheduled updates.

## Recovery / Recovery Media

### How can I create Recovery Media?

You can create Recovery Media using the **VAIO Care**. The media are used to restore your computer system to its factory default settings. To create the media, launch the **VAIO Care** ([page 28](#)) and then click **Recovery & restore**, **Recovery**, and **Create Recovery Media**.



! If a docking station is not supplied with your computer, you need to connect an external optical disc drive (not supplied).

See the **Recovery, Backup and Troubleshooting Guide** for more information.

## How can I restore my computer system to its factory default settings?

There are two ways to recover your computer system: from Recovery Media and from the recovery area. See the **Recovery, Backup and Troubleshooting Guide** for more information.

## How can I reinstall the original software and drivers?

You can restore the preinstalled software and drivers using the **VAIO Care**. To restore them, launch the **VAIO Care** (page 28) and then click **Recovery & restore**, **Recovery**, and **Reinstall Applications and Drivers**.

See the help file included with the **VAIO Care** for more information.

## How do I check the volume of the recovery area?

Your built-in storage device contains the recovery area where the data for the system recovery is stored. To check the volume of the recovery area, follow these steps:

1 Click **Start**, right-click **Computer**, and select **Manage**.

2 Click **Disk Management** under **Storage** in the left pane.

The volume of the recovery area and the total volume of the C drive are displayed in the **Disk 0** row in the center pane.

## How do I reduce the volume of the recovery area?

Your built-in storage device contains the recovery area where the data for system recovery is stored. If your computer includes a solid state drive, you might want to minimize the recovery area by removing such data.

- 1 If you recover your computer from Recovery Media (optical discs) on the model without a docking station, connect an external optical disc drive (not supplied) to the computer and to an AC power source.
- 2 Insert the disc into the optical disc drive or connect the USB flash drive (not supplied) to the USB port while the computer is in Normal mode.



Use Recovery Media you created upon delivery of your computer.

- 3 Turn off the computer and turn it on once again.



If you are using the docking station, the external optical disc drive, or the USB flash drive, press the **F11** key repeatedly until the VAIO logo disappears.

- 4 Press the **↑** or **↓** key to select **VAIO Care Rescue** and press the **Enter** key.
- 5 Click **Tools** and **Start advanced recovery wizard**.



When the **Do you need to rescue data?** message appears, make a backup copy of your data, if needed.

- 6 Follow the on-screen instructions until the **Select recovery type** window appears.
- 7 Select **Custom recovery - Remove recovery contents**.
- 8 Follow the on-screen instructions.



The above procedure involves system recovery. The applications and data you added on the storage device before removing the data for system recovery will all be lost.

Once you have removed the data for system recovery, you need the Recovery Media for later system recovery.

## Partition

### How can I create a hard disk partition?

The Windows feature allows you to create a partition without recovering your computer system.

- 1 Click **Start**, **Control Panel**, **System and Security**, and **Create and format hard disk partitions** under **Administrative Tools**.
- 2 If the **User Account Control** window appears, click **Yes**.  
If you are currently logged onto your computer as a standard user, you may be prompted to enter an administrator name and password.
- 3 Right-click the C drive and select **Shrink Volume**.
- 4 Enter the size of the partition to be created in **Enter the amount of space to shrink in MB** and click **Shrink**.
- 5 Right-click **Unallocated** and select **New Simple Volume**.
- 6 Follow the on-screen instructions.



If you use the **VAIO Care Rescue**, you can create a partition in the recovery process. See **Using the VAIO Care (page 28)** for more information.

## Battery Pack

### How do I find the battery charging status?

You can check the charge indicator for the battery charging status. See **Charging the Battery Pack (page 21)** for more information.

## When is my computer using AC power?

When your computer is connected to an AC outlet with the AC adapter, it uses AC power, even if the battery pack is installed.

## When should I recharge the battery pack?

Recharge the battery pack when:

- The battery pack is running out of power and both the charge and power indicator lights blink.
- You have not used the battery pack for an extended period of time.

## When should I replace the battery pack?

A message prompting you to replace the battery pack appears when the battery pack reaches the end of its life. You can check the battery charge capacity with the **Battery** function on the **VAIO Control Center**.

## Should I be concerned that the installed battery pack is warm?

No, it is normal for the battery pack to be warm while it is powering your computer.

## Can my computer enter Hibernate mode while running on battery power?

Your computer can enter Hibernate mode while running on battery power, but some software programs and peripheral devices prevent the system from entering Hibernate mode. If you are using a program that prevents the system from entering Hibernate mode, save your data frequently to avoid losing data. See **Using Hibernate Mode (page 26)** for information on how you can manually activate Hibernate mode.

## Why can't I fully charge my battery pack?

The battery care function is enabled to extend the life of your battery pack on the **VAIO Control Center**. Check the settings on the **VAIO Control Center**.

## What should I do if a message appears notifying of either incompatibility or the improper installation of the battery pack and my computer then enters Hibernate mode?

- This problem could be due to the battery pack not being installed properly. To solve this problem, turn off your computer and push and hold the battery off button for three seconds with a thin, straight object (such as a paper clip). If this does not solve the problem, remove the battery pack and install it once again.  
If an extended battery pack is attached to the computer, turn off the computer and remove the extended battery pack. If this does not solve the problem, push and hold the battery off button for three seconds. If the problem persists, remove both battery packs and install them once again. For information on how to install and remove the battery pack, see **Installing/Removing the Battery Pack (page 19)**.
- If the problem persists, it means the installed battery pack is not compatible. Remove the battery pack and contact an authorized Sony service/support center. To find the nearest center or agent, see **Finding More about Your VAIO Computer (page 4)**.

## Built-in Camera

### Why does the viewfinder show no images or poor-quality images?

- The built-in camera cannot be shared by more than one software application. Exit the current application before launching another. On models with **Media Gallery**, you cannot use another camera application that uses the built-in camera while using the gesture function of **Media Gallery**.
- The viewfinder may show some noise, for example horizontal streaks, when you are viewing a rapid-moving object. This is normal and does not indicate a malfunction.

- ❑ If the problem persists, restart your computer.

## Why is the video input from the built-in camera suspended for a few seconds?

The video input may be suspended for a few seconds if:

- ❑ a shortcut key with the **Fn** key is used.
- ❑ the CPU load increases.

This is normal and does not indicate a malfunction.

## Why are captured images poor in quality?

- ❑ The images captured under the fluorescent light may show reflections of light.
- ❑ A dark portion in captured images may appear as a noise.
- ❑ The area on and around the built-in camera is dirty. Clean the area. See **Care and Maintenance Information (page 105)**.

## What should I do if captured images contain dropped frames and audio interruptions?

- ❑ The effect settings on your software application may cause dropped frames. See the help file included with your software application for more information.
- ❑ There may be more software applications running than your computer can handle. Exit the applications that you are not currently using.
- ❑ This problem may occur while your computer is running on the power saving plan, which reduces the CPU performance. See **Selecting a Power Plan (page 101)** to check the current power plan.

## What should I do if movie playback shows dropped frames while my computer is running on battery power?

The battery pack is running out of power. Connect your computer to an AC outlet.



## What should I do if captured images flicker?

This problem occurs when you use the camera under fluorescent lights due to a mismatch between the lighting output frequency and the shutter speed.

To reduce flicker noise, change the direction of the camera or the brightness of camera images. In some software applications, you can set an appropriate value to one of the camera properties (e.g. light source, flicker, etc.) to eliminate flicker noise.

## Networking (LAN/Wireless LAN)

### What should I do if the VAIO Smart Network icon is not displayed on the taskbar?

- Click  on the taskbar and check if the **VAIO Smart Network** icon  is displayed.
- If the **VAIO Smart Network** icon  is not on the taskbar, click **Start**, **All Programs**, and **VAIO Smart Network**, and then change the setting to display the icon on the taskbar.

### What should I do if my computer cannot connect to a wireless LAN access point?

- Connection capability is affected by distance and obstructions. You may need to move your computer away from obstructions or closer to any access point you may be using.
- Make sure the **WIRELESS** switch is on and the **WIRELESS** indicator light is lit on your computer.
- Make sure power to the access point is on.

- ❑ If you want to connect your computer to a wireless LAN access point using the 5 GHz band, make sure the option to use the 5 GHz band or both the 2.4 GHz and 5 GHz bands is selected for **Wi-Fi Settings** in the **VAIO Smart Network** settings window. Wireless LAN communication (IEEE 802.11a standard) using only the 5 GHz band, available on selected models only, is disabled by default.
- ❑ Follow these steps to check the settings:
  - 1 Click **Start** and **Control Panel**.
  - 2 Click **View network status and tasks** under **Network and Internet**.
  - 3 Click **Connect to a network** to confirm that your access point is selected.
- ❑ Make sure the encryption key is correct.
- ❑ Make sure **Maximum Performance** is selected for **Wireless Adapter Settings** in the **Power Options** window. Selecting any other option may result in a communication failure. To change the settings, follow these steps:
  - 1 Click **Start** and **Control Panel**.
  - 2 Click **System and Security** and **Power Options**.
  - 3 Click **Change plan settings** for the current power plan.
  - 4 Click **Change advanced power settings**.
  - 5 Double-click **Wireless Adapter Settings** and **Power Saving Mode**.
  - 6 Select **Maximum Performance** from the drop-down list.

## What should I do if I cannot access the Internet?

- ❑ Check the access point settings. See the manual that came with your access point for more information.
- ❑ Make sure your computer and the access point are connected to one another.
- ❑ Move your computer away from obstacles or closer to any access point you may be using.



- ❑ Make sure your computer is properly configured for Internet access.
- ❑ Make sure **Maximum Performance** is selected for **Wireless Adapter Settings** in the **Power Options** window. Selecting any other option may result in a communication failure. Follow the steps in **What should I do if my computer cannot connect to a wireless LAN access point?** (page 127) to change the settings.

## Why is the data transfer speed slow?

- ❑ The wireless LAN data transfer speed is affected by distance and obstructions between devices and access points. Other factors include device configurations, radio conditions, and software compatibility. To maximize the data transfer speed, move your computer away from obstacles or closer to any access point you may be using.
- ❑ If you are using a wireless LAN access point, the device may be temporarily overloaded depending on how many other devices are communicating via the access point.
- ❑ If your access point interferes with other access points, change the access point channel. See the manual that came with your access point for more information.
- ❑ Make sure **Maximum Performance** is selected for **Wireless Adapter Settings** in the **Power Options** window. Selecting any other option may result in a communication failure. Follow the steps in **What should I do if my computer cannot connect to a wireless LAN access point?** (page 127) to change the settings.

## How do I avoid data transfer interruptions?

- ❑ While your computer is connected to an access point, data transfer interruptions may occur if a large file is exchanged or the computer is placed in close proximity to microwaves and cordless telephones.
- ❑ Move your computer closer to the access point.
- ❑ Make sure the access point connection is intact.
- ❑ Change the access point channel. See the manual that came with your access point for more information.

- Make sure **Maximum Performance** is selected for **Wireless Adapter Settings** in the **Power Options** window. Selecting any other option may result in a communication failure. Follow the steps in **What should I do if my computer cannot connect to a wireless LAN access point?** ([page 127](#)) to change the settings.

## What are channels?

- Wireless LAN communication uses divided frequency bands known as channels. Third-party wireless LAN access point channels may be preset to different channels from Sony devices.
- If you are using a wireless LAN access point, see connectivity information contained in the manual that came with your access point.

## Why does the network connection stop when I change the encryption key?

Two computers with the wireless LAN function may lose a peer-to-peer network connection if the encryption key is changed. You can either change the encryption key back to the original profile or re-enter the key on both computers so the key matches.

## Wireless WAN

### What should I do if my computer cannot connect to the wireless WAN?

- Make sure the battery pack is installed properly and charged.
- Activate a mobile broadband service account with a supported carrier.
- Have adequate mobile coverage in your area. Check with your network provider for additional coverage information for your location.
- Make sure the **WIRELESS** switch is on and the **WIRELESS** indicator light is lit on your computer.
- Make sure the switch next to **Wireless WAN** is set to **On** in the **VAIO Smart Network** window.

- ❑ Check that your connection manager software has detected the wireless WAN modem successfully. It may take some time for the software to detect the wireless WAN modem.



For further information on the wireless WAN function, visit the Sony online support web site.

- ❑ Make sure the SIM card holder is properly inserted into the SIM card slot.

## BLUETOOTH Technology

### What should I do if other BLUETOOTH devices cannot find my computer?

- ❑ Make sure both devices have the BLUETOOTH function enabled.
- ❑ Make sure the **WIRELESS** switch is on and the **WIRELESS** indicator light is lit on your computer.
- ❑ You cannot use the BLUETOOTH function while your computer is in a power saving mode. Bring the computer back to Normal mode, then turn on the **WIRELESS** switch.
- ❑ Your computer and the device may be too far apart. Wireless BLUETOOTH technology works best when the devices are within 33 feet / 10 meters of each other.

### What should I do if I cannot find the BLUETOOTH device I want to communicate with?

- ❑ Check that the BLUETOOTH function of the device you want to communicate with is on. See the other device's manual for more information.
- ❑ If the device you want to communicate with is already communicating with another BLUETOOTH device, it may not be found or it may not be able to communicate with your computer.
- ❑ To allow other BLUETOOTH devices to communicate with your computer, follow these steps:
  - 1 Click **Start** and **Devices and Printers**.
  - 2 Right-click the BLUETOOTH device icon and click **Bluetooth settings**.

- 3 Click the **Options** tab and select the **Allow Bluetooth devices to find this computer** check box.

## What should I do if other BLUETOOTH devices cannot connect to my computer?

- Check the suggestions in **What should I do if I cannot find the BLUETOOTH device I want to communicate with? (page 131)**.
- Make sure the other devices are authenticated.
- The data transfer distance can be shorter than 33 feet / 10 meters depending on existing obstacles between the two devices, on radio wave quality, and on the operating system or the software in use. Move your computer and BLUETOOTH devices closer to each other.

## Why is my BLUETOOTH connection slow?

- The data transfer speed depends on the obstructions and/or the distance between the two devices, on the radio wave quality, and on the operating system or the software in use. Move your computer and BLUETOOTH devices closer to each other.
- The 2.4 GHz band, with which BLUETOOTH devices or wireless LAN devices work, is used by various devices. Although BLUETOOTH devices use the technology to minimize radio interference from other devices that use the same band, such radio interference may cause slower communication speeds and shorter distances or communication failures.
- If a version of a BLUETOOTH standard employed on the BLUETOOTH device with which you want to communicate is not the same version as the one employed on your computer, the communication speed becomes slower.
- High-speed communications between your computer and BLUETOOTH devices are available when they are compliant with BLUETOOTH Core Specification Version 3.0 + HS. For the high-speed communications, enable both the wireless LAN and BLUETOOTH functions on the computer.

! Some BLUETOOTH profiles do not support high-speed communications.

## Can I use a device with BLUETOOTH technology on airplanes?

With BLUETOOTH technology, your computer transmits a radio frequency of 2.4 GHz. Sensitive locations, such as hospitals and airplanes, may have restrictions on use of BLUETOOTH devices to avoid radio interference. Check with facility staff to see if use of the BLUETOOTH function on the computer is permitted.

## Why can't I use the BLUETOOTH function when I log onto my computer as a user with a standard user account?

The BLUETOOTH function may not be available to a user with a standard user account on your computer. Log onto the computer as a user with administrative rights.

## Why can't I use the BLUETOOTH devices when I switch users?

If you switch users without logging off your system, the BLUETOOTH devices will not work. Be sure to log off before switching users. To log off your system, click **Start**, the arrow next to the **Shut down** button, and **Log off**.

## Why can't I exchange business card data with a mobile phone?

The business card exchange function is not supported.

## What should I do if the BLUETOOTH icon is not displayed on the taskbar?

- Make sure that the switch next to **BLUETOOTH** is set to **On** in the **VAIO Smart Network** window.
- To display the BLUETOOTH icon on the taskbar, follow these steps:
  - 1 Click **Start** and **Devices and Printers**.
  - 2 Right-click the BLUETOOTH device icon and click **Bluetooth settings**.
  - 3 Click the **Options** tab and select the **Show the Bluetooth icon in the notification area** check box.

## Optical Discs

### Why does my computer freeze when I try to read a disc?

The disc that your computer is trying to read may be dirty or damaged. Follow these steps:

- 1 Press the **Ctrl+Alt+Delete** keys and click the arrow next to the **Shut down** button and **Restart** to restart the computer.

! Turning off your computer with the **Ctrl+Alt+Delete** keys may cause loss of unsaved data.

- 2 Remove the disc from the optical disc drive.
- 3 Check the disc for dirt or damage. If you need to clean the disc, see **Discs (page 106)** for instructions.

### What should I do if the disc does not slide out?

- Make sure the docking station is connected to an AC power source.
- Press the drive eject button on the docking station.
- If the drive eject button does not work, click **Start** and **Computer**, right-click the optical disc drive icon, and select **Eject**.
- Try restarting your computer.

### What should I do if I cannot play a disc properly on my computer?

- Make sure the disc is inserted into the optical disc drive with the label side facing toward you.
- Make sure the necessary program(s) is installed according to the manufacturer's instructions.
- If a disc is dirty or damaged, your computer will stop responding. Follow these steps:
  - 1 Press the **Ctrl+Alt+Delete** keys and click the arrow next to the **Shut down** button and **Restart** to restart the computer.

**!** Turning off your computer with the **Ctrl+Alt+Delete** keys may cause loss of unsaved data.

- 2 Remove the disc from the optical disc drive.
- 3 Check the disc for dirt or damage. If you need to clean the disc, see **Discs (page 106)** for instructions.

- ❑ If you are playing a disc and cannot hear sound, do any of the following:
  - ❑ The volume may have been turned off by the **Fn+F2** keys. Press them once again.
  - ❑ The volume may have been minimized by the **Fn+F3** keys. Keep pressing the **Fn+F4** keys to turn up the volume loud enough to hear sound.
  - ❑ Right-click the volume icon on the taskbar and click **Open Volume Mixer** to check the settings.
  - ❑ Check the volume setting in the audio mixer.
  - ❑ If you are using external speakers, check the volume settings on the speakers and the connections between the speakers and your computer.
  - ❑ Make sure the correct driver software is installed. Follow these steps:
    - 1 Click **Start** and **Control Panel**.
    - 2 Click **System and Security**.
    - 3 Click **System**.
    - 4 Click **Device Manager** in the left pane.

The **Device Manager** window appears with a listing of your computer's hardware devices. If an "X" or an exclamation point appears on the listed device, you may need to enable the device or reinstall the driver software.
    - 5 Double-click the optical disc drive device to open a list of the optical disc drives of your computer.
    - 6 Double-click your desired drive.

You can confirm the driver software by selecting the **Driver** tab, and clicking **Driver Details**.

7 Click **OK** to close the window.

- ❑ Make sure an adhesive label is not affixed to a disc. Adhesive labels can come off while the disc is in the optical disc drive and damage the drive or cause it to malfunction.
- ❑ If a region code warning appears, the disc may be incompatible with the optical disc drive. Check the package to make sure the region code is compatible with the optical disc drive.
- ❑ If you notice condensation on your computer, do not use the computer for at least one hour. Condensation can cause the computer to malfunction.
- ❑ Make sure the docking station is securely connected to your computer and is running on AC power, and then try the disc again.

## What should I do if I cannot write data to CD media?

- ❑ Make sure you neither launch any software application nor allow any to launch automatically, not even a screen saver.
- ❑ If you are using a CD-R/RW disc with an adhesive label affixed, replace it with one with no affixed adhesive label. Using a disc with an affixed adhesive label could cause a write error or other damage.

## What should I do if I cannot write data to DVD media?

- ❑ Make sure you are using the correct DVD recordable media.
- ❑ Check which DVD recordable format is compatible with your optical disc drive. Some brands of DVD recordable media do not work.

## What should I do if my external optical disc drive does not work properly?

Make sure that your external optical disc drive is connected to an AC power source and the USB port. If it is not connected, the external optical disc drive may not work properly.



## GPS

### What should I do if I cannot use the GPS function?

- Make sure the **WIRELESS** switch is on.
- Make sure the switch next to **GPS** is set to **On** in the **VAIO Smart Network** window.

### What should I do if I cannot obtain location information or if the current location obtained is incorrect?

- Make sure the **WIRELESS** switch is on.
- Make sure the switch next to **Location Services** or **Wi-Fi** is set to **On** in the **VAIO Smart Network** window.
- To successfully obtain location information, your current location must be free of obstacles. Move around to find an optimum location for receiving GPS information.

## Display

### Why did my screen go blank?

- Your computer screen may go blank if the computer loses power or enters a power saving mode (Sleep or Hibernate). If the computer is in LCD (Video) Sleep mode, press any key to bring the computer back into Normal mode. See **Using the Power Saving Modes (page 25)** for more information.
- Make sure your computer is securely plugged into a power source and turned on and the power indicator light is lit.
- If your computer is running on battery power, make sure the battery pack is installed properly and is charged. See **Using the Battery Pack (page 19)** for more information.

- ❑ If the display output is directed to the external display, press the **Fn+F7** keys. See **Combinations and Functions with the Fn Key (page 30)** for more information.

## What should I do if I do not see proper images or videos?

- ❑ Be sure to select **True Color (32 bit)** for the display colors before using video/image software or starting DVD playback. Selecting any other option may prevent such software from displaying images successfully. To change the display colors, follow these steps:
  - 1 Right-click on the desktop and select **Screen resolution**.
  - 2 Click **Advanced settings**.
  - 3 Click the **Monitor** tab.
  - 4 Select **True Color (32 bit)** under **Colors**.
- ❑ Do not change the display resolution or colors while using video/image software or playing DVDs, as it may cause unsuccessful playback/display or unstable system operations. Additionally, it is recommended you disable your screen saver before starting DVD playback. If the screen saver is enabled, it may be activated during DVD playback and prevent the playback from running successfully. Some screen savers have been found to even change the display resolution and colors.

## What should I do if some items do not fit on the computer screen?

Check that the text size is set to 100%. If not, some items, for example a software menu, may not be displayed correctly, depending on the software you are using. See **Windows Help and Support** for more information on how to change the text size.

## What should I do if no image is displayed on my TV screen or external display connected to the HDMI output port?

Make sure you are using an HDCP-compliant display. The copyright protected content is not displayed on a non-HDCP compliant display. See **Connecting a TV with an HDMI Input Port (page 89)** or **Connecting a Computer Display or a Projector (page 88)** for more information.

## Why doesn't my screen display a video?

- ❑ If the display output is directed to the external display and the external display is disconnected, you cannot display a video on your computer screen. Stop video playback, change the display output to the computer screen, and then restart video playback. See **Selecting Display Modes (page 91)** for changing the display output. Alternatively, you can press the **Fn+F7** keys to change the display output. See **Combinations and Functions with the Fn Key (page 30)** for more information.
- ❑ The video memory of your computer may be insufficient for displaying high resolution videos. In such a case, lower the resolution of the LCD screen.

To change the screen resolution, follow these steps:

- 1 Right-click on the desktop and select **Screen resolution**.
- 2 Click the drop-down list next to **Resolution**.
- 3 Move the slider up to increase or down to decrease the screen resolution.



You can check the total amount of the graphics and video memory available. Right-click on the desktop, select **Screen resolution**, and click **Advanced Settings** and the **Adapter** tab. The displayed value may be different from the actual amount of memory on your computer.

## What should I do if my screen is dark?

- ❑ Press the **Fn+F6** keys to brighten your computer screen.

- ❑ Blocking the ambient light sensor turns your screen dark. Make sure that the sensor is unblocked.

## What should I do if the external display remains blank?

Press the **Fn+F7** keys to change the display output. See **Combinations and Functions with the Fn Key (page 30)** for more information.

## How do I run Windows Aero?

To run Windows Aero, follow these steps:

- 1 Right-click on the desktop and select **Personalize**.
- 2 Select your desired theme from **Aero Themes**.

For information about the Windows Aero features, such as Windows Flip 3D, see **Windows Help and Support**.

# Printing

## What should I do if I cannot print a document?

- ❑ Make sure your printer is on, and the printer cable is securely connected to the ports on the printer and your computer.
- ❑ Make sure your printer is compatible with the Windows operating system installed on your computer.
- ❑ You may need to install the printer driver software before you use your printer. See the manual that came with your printer for more information.
- ❑ If your printer is not functioning after your computer resumes from a power saving mode (Sleep or Hibernate), then restart the computer.
- ❑ If the bidirectional communication functions are provided with your printer, disabling the functions on your computer may enable printing. Follow these steps:

- 1 Click **Start** and **Devices and Printers**.
- 2 Right-click the printer icon and select **Properties**.
- 3 Click the **Ports** tab.
- 4 Click to cancel the **Enable bidirectional support** check box.
- 5 Click **OK**.

This disables the bidirectional communication functions of the printer, such as data transfer, status monitoring, and remote panel.

When your printer is connected to the docking station, check to see if the docking station is connected to an AC power source.

## Microphone

### What should I do if my microphone does not work?

- Your computer is not equipped with the microphone jack. You cannot use an external microphone.
- Your sound input device may have been incorrectly configured. To configure the sound input device, follow these steps:
  - 1 Close all open programs.
  - 2 Click **Start** and **Control Panel**.
  - 3 Click **Hardware and Sound**.
  - 4 Click **Manage audio devices** under **Sound**.
  - 5 On the **Recording** tab, select your desired device for sound input and click **Set Default**.

### How can I prevent microphone feedback?

Microphone feedback occurs when the microphone receives the sound from a sound output device, such as a speaker.

To prevent this problem:

- Keep the microphone away from a sound output device.
- Turn down the volume of the speakers and the microphone.

## Speakers

### What should I do if I do not hear sound from the built-in speakers?

- If you are using a program that has its own volume control, make sure the volume control is properly set. See the program's help file for more information.
- The volume may have been turned off by the **Fn+F2** keys. Press them once again.
- The volume may have been minimized by the **Fn+F3** keys. Keep pressing the **Fn+F4** keys to turn up the volume loud enough to hear sound.
- Check the Windows volume controls by clicking the volume icon on the taskbar.
- Your sound output device may have been incorrectly configured. To change the sound output device, see **How do I change the sound output device?** ([page 146](#)).

### What should I do if my external speakers do not work?

- Check the suggestions in **What should I do if I do not hear sound from the built-in speakers?** ([page 142](#)).
- If you are using a program that has its own volume control, make sure the volume control is properly set. See the program's help file for more information.
- Make sure your speakers are properly connected and the volume is turned up loud enough to hear sound.
- Make sure your speakers are designed for computer use.
- If your speakers have a muting button, set the button to off.

- ❑ If your speakers require external power, make sure the speakers are connected to a power source. See the manual that came with your speakers for more information.
- ❑ Check the Windows volume controls by clicking the volume icon on the taskbar.
- ❑ Your sound output device may have been incorrectly configured. To change the sound output device, see **How do I change the sound output device?** ([page 146](#)).

## Touch Pad

### What should I do if the touch pad does not work?

- ❑ Slide your finger on the active zone to move the pointer. See **Using the Touch Pad** ([page 32](#)).
- ❑ You may have disabled the touch pad. Press the **Fn+F1** keys to enable it. See **Using the Touch Pad** ([page 32](#)).
- ❑ Make sure that a mouse is not connected to your computer.
- ❑ If the pointer does not move while a software application is running, press the **Alt+F4** keys to close the application window.
- ❑ If the **Alt+F4** keys do not work, press the Windows key once and then the **→** key several times, select **Restart** with the **↑** or **↓** key, and press the **Enter** key to restart your computer.
- ❑ If your computer does not restart, press the **Ctrl+Alt+Delete** keys, select the arrow next to the **Shut down** button with the **↓** and **→** keys, press the **Enter** key, select **Restart** with the **↑** or **↓** key, and press the **Enter** key to restart your computer.
- ❑ If this procedure does not work, press and hold the power button until the computer turns off.

! Turning off your computer with the **Ctrl+Alt+Delete** keys or the power button may cause loss of unsaved data.

## Keyboard

### What should I do if the keyboard configuration is wrong?

The language layout of your computer's keyboard is labeled on the packaging box. If you choose a different regional keyboard when you complete the Windows setup, the key configuration will be mismatched.

To change the keyboard configuration, follow these steps:

- 1 Click **Start** and **Control Panel**.
- 2 Click **Clock, Language, and Region**, and then **Change keyboards or other input methods** under **Region and Language**.
- 3 Click **Change keyboards** on the **Keyboards and Languages** tab.
- 4 Change the settings as desired.

### What should I do if I cannot enter certain characters with the keyboard?

If you cannot enter **U, I, O, P, J, K, L, M**, and so on, the **Num Lk** key may be activated. Check that the Num lock indicator light is unlit. If the Num lock indicator is lit, press the **Fn+Num Lk** keys to turn it off before entering these characters.

## Floppy Disks

### Why doesn't the Safely Remove Hardware and Eject Media icon appear on the taskbar when the drive is connected?

Your computer does not recognize the floppy disk drive. First, make sure the USB cable is properly connected to the USB port. If you need to secure the connection, wait a few moments for the computer to recognize the drive. If the icon still does not appear, follow these steps:



- 1 Close all programs that are accessing the floppy disk drive.
- 2 Wait until the indicator light on the floppy disk drive turns off.
- 3 Push the eject button to remove the disk, and unplug the USB floppy disk drive from your computer.
- 4 Reconnect the floppy disk drive by plugging the USB cable into the USB port.
- 5 Restart the computer by clicking **Start**, the arrow next to the **Shut down** button, and **Restart**.

## What should I do if I cannot write data to a floppy disk?

- Make sure the floppy disk is properly inserted in the drive.
- If the disk is inserted properly and you are still unable to write data to it, the disk may be full or write-protected. You can either use a floppy disk that is not write-protected or disable the write-protect feature.

## Audio/Video

### How do I turn off the Windows startup sound?

To turn off the Windows startup sound, follow these steps:

- 1 Click **Start** and **Control Panel**.
- 2 Click **Hardware and Sound**.
- 3 Click **Manage audio devices** under **Sound**.
- 4 On the **Sounds** tab, click to cancel the **Play Windows Startup sound** check box.
- 5 Click **OK**.

## How do I change the sound output device?

If you do not hear sound from the device connected to a port, such as the USB port, HDMI output port, optical output port, or headphones jack, you need to change the device for sound output.

- 1 Close all open programs.
- 2 Click **Start** and **Control Panel**.
- 3 Click **Hardware and Sound**.
- 4 Click **Manage audio devices** under **Sound**.
- 5 On the **Playback** tab, select your desired device for sound output and click **Set Default**.

## What should I do if I do not hear the sound from the sound output device connected to the HDMI output port, optical output port, or headphones jack?

- You need to change the sound output device if you want to hear sound from the device connected to a port, such as the HDMI output port, optical output port, or headphones jack. For the detailed procedure, see **How do I change the sound output device? (page 146)**.
- If you still hear no sound from the sound output device, follow these steps:
  - 1 Follow steps 1 to 4 in **How do I change the sound output device? (page 146)**.
  - 2 On the **Playback** tab, select the HDMI or S/PDIF icon and click **Properties**.
  - 3 Click the **Advanced** tab.
  - 4 Select the sample rate and bit depth (for example, 48000 Hz, 16 bit) which the device supports.
  - 5 Click **OK**.

## Why do sound interruptions and/or dropped frames occur when I play high-definition videos, such as those recorded with the AVCHD digital video camcorder?

Playing high-definition videos requires substantial hardware resources, such as CPU, GPU, or system memory performance on your computer. During the video playback, some operations and/or functions may become unavailable, and sound interruptions, dropped frames, and playback failure may occur depending on the configuration of your computer.

## "Memory Stick"

### What should I do if I cannot use "Memory Stick" that was formatted on a VAIO computer on other devices?

You may need to reformat your "Memory Stick".

Formatting "Memory Stick" erases all data, including music data previously saved on it. Before you reformat "Memory Stick", back up important data and confirm that "Memory Stick" does not contain files you want to keep.

- 1 Copy the data from "Memory Stick" onto your built-in storage device to save data or images.
- 2 Format "Memory Stick" by following the steps in **Formatting "Memory Stick" (page 45)**.

### Can I copy images from a digital camera using "Memory Stick"?

Yes, and you can view video clips that you have recorded with digital cameras that are compatible with "Memory Stick".

### Why can't I write data to "Memory Stick"?

Some versions of "Memory Stick" are equipped with an erasure prevention switch to protect data from unintentional erasure or overwriting. Make sure the erasure prevention switch is off.

## Peripherals

### What should I do if I cannot connect a USB device?

- ❑ If applicable, check the USB device is turned on and using its own power supply. For example, if you are using a digital camera, check if the battery is charged. If you are using a printer, check if the power cable is connected properly to an AC outlet.
- ❑ Try using another USB port. The driver software could be installed to the specific port you used the first time you connected the device.
- ❑ See the manual that came with your USB device for more information. You may need to install software before you connect the device.
- ❑ Try connecting a simple, low-powered device such as a mouse to test if the port is working at all.
- ❑ USB hubs may prevent a device from working because of a power distribution failure. We recommend you connect the device directly to your computer without a hub.

## Docking Station

### What should I do if an error message appears when I disconnect the docking station from my computer?

- ❑ When any device inserted or connected to the docking station is in use, you cannot disconnect the docking station from your computer. Save unsaved data, exit applications that are using such devices, and then try again.  
If the above does not work, shut down your computer and disconnect the docking station from the computer.
- ❑ When the battery pack is running out of power, you cannot disconnect the docking station from your computer. Charge the battery pack or shut down the computer and then try again.

- ❑ Be sure to return to the originally logged on user before disconnecting the docking station from your computer. Disconnecting it as any other user may cause malfunctions. For switching users, see **Windows Help and Support**.

# Trademarks

© 2011 Sony Electronics Inc. All rights reserved. Reproduction in whole or in part without written permission is prohibited.

Sony and the Sony logo are trademarks or registered trademarks of Sony Corporation.

VAIO, the VAIO logo, VAIO Care, Media Gallery, Share My Connection, and Backstage are trademarks or registered trademarks of Sony Electronics Inc.

"BRAVIA" is a trademark of Sony Corporation.



and "Memory Stick", "Memory Stick Duo", "MagicGate", "OpenMG", "Memory Stick PRO", "Memory Stick PRO Duo", "Memory Stick PRO-HG Duo", "Memory Stick Micro", "M2", and the "Memory Stick" logo are trademarks or registered trademarks of Sony Corporation.

Walkman is a registered trademark of Sony Corporation.

S-FORCE is a trademark or registered trademark of Sony Corporation.

i.LINK is a name to denote IEEE 1394. i.LINK and i.LINK logo "i" are the trademarks of Sony Corporation.

Intel, Intel Inside, Intel Core, Pentium, Intel SpeedStep, and Atom are trademarks or registered trademarks of Intel Corporation in the United States and/or other countries.

Microsoft, MS-DOS, Windows, Windows Vista, BitLocker, Aero, and the Windows logo are trademarks of Microsoft group of companies.

Blu-ray Disc™, Blu-ray™, Blu-ray 3D™, the Blu-ray Disc™ logo, and the Blu-ray 3D logo are trademarks of the Blu-ray Disc Association.

The BLUETOOTH word mark and logos are registered trademarks owned by Bluetooth SIG, Inc. and any use of such marks by Sony Corporation is under license. Other trademarks and trade names are those of their respective owners.

Roxio Easy Media Creator is a trademark of Sonic Solutions.

WinDVD is trademark of Corel Inc.

PowerDVD is trademark of CyberLink.Inc.

NVIDIA and 3D Vision are registered trademarks and/or trademarks of NVIDIA Corporation in the United States and other countries.

ArcSoft and the ArcSoft logo are registered trademarks of ArcSoft, Inc. ArcSoft WebCam Companion is a trademark of ArcSoft, Inc.

AMD, the AMD Arrow logo, ATI, and combinations thereof, Radeon, AMD Phenom, AMD Turion, AMD Athlon, AMD Virtualization, AMD-V are trademarks of Advanced Micro Devices, Inc.

SD Logo is a trademark. 

SDHC Logo is a trademark. 

SDXC Logo is a trademark. 

The ExpressCard word mark and logos are owned by the PCMCIA and any use of such marks by Sony Corporation is under license. Other trademarks and trade names are those of their respective owners.

HDMI, the HDMI logo, and High-Definition Multimedia Interface are trademarks or registered trademarks of HDMI Licensing LLC.

CompactFlash® is a trademark of SanDisk Corporation.

, "XMB," and "xross media bar" are trademarks of Sony Corporation and Sony Computer Entertainment Inc. PlayStation, PS3, and PS family logos are trademarks of Sony Computer Entertainment Inc.

"PlaceEngine" is a registered trademark of Koozyt, Inc.

"PlaceEngine" was developed by Sony Computer Science Laboratories, Inc. and is licensed by Koozyt, Inc.

"TransferJet" and the "TransferJet" logo are trademarks of Sony Corporation.

"AVCHD" is a trademark of Panasonic Corporation and Sony Corporation.

All other names of systems, products, and services are trademarks of their respective owners. In the manual, the ™ or ® marks are not specified.

Features and specifications are subject to change without notice.

All other trademarks are trademarks of their respective owners.

Not all the software listed above may be delivered with your model.



# Notice

© 2011 Sony Corporation. All rights reserved.

This manual and the software described herein, in whole or in part, may not be reproduced, translated, or reduced to any machine-readable form without prior written approval.

Sony Corporation provides no warranty with regard to this manual, the software, or other information contained herein and hereby expressly disclaims any implied warranties or merchantability or fitness for any particular purpose with regard to this manual, the software, or such other information. In no event shall Sony Corporation be liable for any incidental, consequential, or special damages, whether based on tort, contract, or otherwise, arising out of or in connection with this manual, the software, or other information contained herein or the use thereof.

In the manual, the ™ or ® marks are not specified.

Sony Corporation reserves the right to make any modification to this manual or the information contained herein at any time without notice. The software described herein is governed by the terms of a separate user license agreement.

Sony Corporation is not liable and will not compensate for any lost recordings made to your computer, external recording media, or recording devices or any relevant losses, including when recordings are not made due to reasons including your computer failure, or when the contents of a recording are lost or damaged as a result of your computer failure or repair undertaken to your computer. Sony Corporation will not restore, recover, or replicate the recorded contents made to your computer, external recording media, or recording devices under any circumstances.

