

Game

Playing a game

- 1 Select  from the home menu.
- 2 Insert a UMD™ (→ page 32).
The UMD™ icon is displayed.

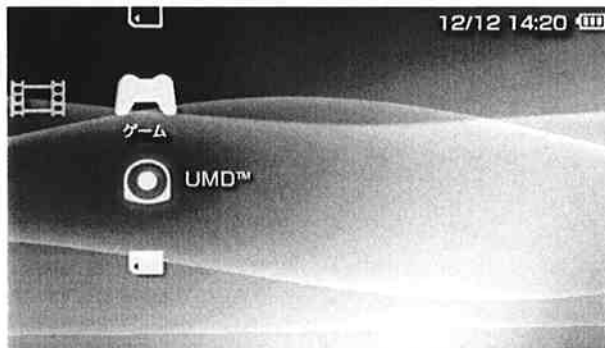





- 3 With the game icon selected, press the  button.
The game starts.





Game

Icons displayed under Game

In addition to playing games, the following features are available under Game.

 Game Sharing	You can play games that support Game Sharing. For details refer to the software manual supplied with the game.
 Saved Data Utility	You can copy, delete or view information about saved data on a Memory Stick Duo™ (→ page 44).
 UMD™	You can play games. If you select the UMD™ icon, the thumbnail for the game is displayed.
 Memory Stick™	You can perform a network update by accessing the update data saved on a Memory Stick Duo™ (→ page 104).

Hints

- Access to a game that is displayed as  (Restricted Content) is restricted by the parental control feature. You must enter the password as described below to access the game. See "Parental control level" (▶▶ page 94) for details.
 - 1 Select , and then press the  button.
 - 2 Enter the password using the directional buttons, and then press the  button.
- If you press the home button during gameplay, you can check the remaining battery power.

Quitting a game

- 1 **Press the home button while playing a game.**
The message "Do you want to quit the game?" is displayed.
- 2 **Select "Yes", and then press the  button.**
The game ends and the home menu is displayed.

Game options menu

You can view game information or copy or delete saved data by displaying the options menu.

- 1 Select an icon, and then press the Δ button.
The options menu is displayed.

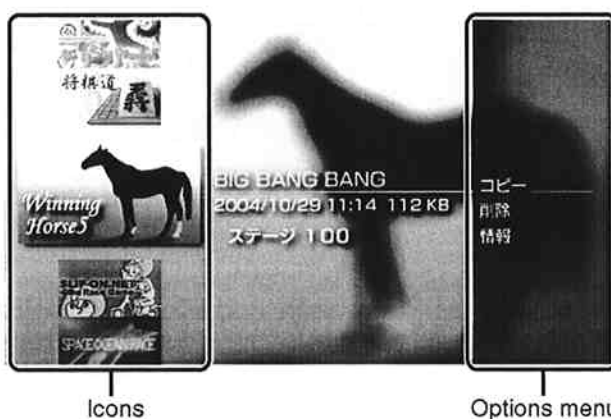

- 2 Select a menu item, and then press the \times button.

Closing the options menu

Press the Δ button or the \bigcirc button.

List of options

The options menu items available vary depending on the icon selected.





Start	Starts a game
Copy	Copies the saved data on a Memory Stick Duo™ to another Memory Stick Duo™ (▶▶ page 44)
Delete	Deletes the saved data on a Memory Stick Duo™ (▶▶ page 44)
Information	Displays information about the selected icon

Copying and deleting saved data

You can copy or delete saved game data that is saved on a Memory Stick Duo™ using the saved data utility.

Copying saved data

You can copy saved data to another Memory Stick Duo™. It is recommended that important data be copied as a backup.

- 1 Select , and then press the  button.
- 2 Select the saved data you want to copy, and then press the  button.
The options menu is displayed.
- 3 Select "Copy", and then press the  button.
- 4 Follow the on-screen instructions.

If there is not enough space available

Delete data in the destination Memory Stick Duo™ or replace it with another Memory Stick Duo™. If you display the options menu (▶▶ page 43), you can delete saved data or check the amount of free space available.

Hint

Depending on the type of Memory Stick Duo™ used, the file size displayed for the same data item may vary.

Deleting saved data

You can delete saved data on a Memory Stick Duo™ by selecting "Delete" in step 3 of "Copying saved data".

Video

Watching a video

You can watch UMD™ Video and videos saved on a Memory Stick Duo™. The file format (for videos saved on a Memory Stick Duo™) that can be played is MPEG-4 (→ page 55).

Notice



Depending on the UMD™ Video, playback conditions may be set in advance by the software developer. In such cases, certain options may not be available, even if you follow the instructions in this manual.



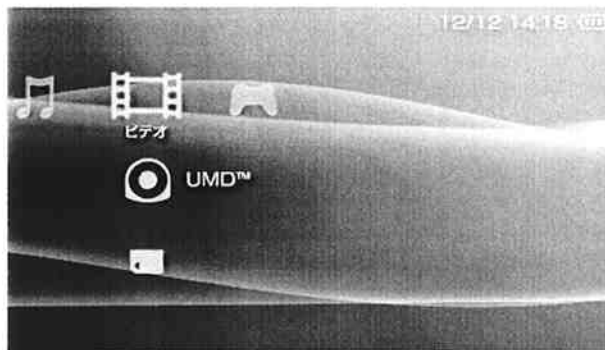

Video

- 1 Select  from the home menu.
- 2 Insert a UMD™ or Memory Stick Duo™ (→ pages 32, 33).
An icon for the inserted media is displayed.







- 3 Select the icon, and then press the  button.
UMD™ Video playback begins. If you select , icons for each video data item will be displayed. Select the video that you want to play, and then press the  button.

Icons displayed under Video

	UMD™	You can play UMD™ Video. If you select the icon, a thumbnail for the video is displayed.
	Memory Stick™	You can play video saved on a Memory Stick Duo™.

Hints

- Access to a video that is displayed as  (Restricted Content) is restricted under the parental control feature. Enter the password as described below to access the video. See "Parental control level" (▶▶ page 94) for details about the parental control feature.
 - 1 Select , and then press the  button.
 - 2 Using the directional buttons, enter the password, and then press the  button.
- If you press the home button or select button during video playback, the home menu will be shown on the screen while the paused image of the video is displayed. If you press the button again, the home menu is cleared.
- You can adjust the tone or mute the sound using the sound button (▶▶ page 35).

Stopping playback

- 1 Press the  button during video playback.

The video will stop.

Hint

In most cases, the next time you play the video, playback will resume from the previous stopping point.

Playing a video from the beginning

If you want to play a UMD™ Video from the beginning, select "Play from Beginning" in the options menu (▶▶ page 54), and then press the  button.

Using the control panel

You can perform the following operations using the on-screen control panel.

1 Press the Δ button during video playback.

The control panel is displayed.



Control panel

Video



2 Select an icon, and then press the \times button.

Clearing the control panel

Press the Δ button or the \odot button.

List of operations

The icons displayed when playing a UMD™ Video are different from those displayed when playing a video saved on a Memory Stick Duo™.

Icon		Description
	Menu	Displays the UMD™ Video menu
	Audio Options	Switches between available audio options for UMD™ Videos recorded with multiple audio tracks
	Angle Options	Switches between available viewing angles for UMD™ Videos recorded with multiple angles

Icon		Description
	Subtitle Options	Switches between available subtitle options for UMD™ Videos that include subtitles
	Go To	Plays video data stored on a Memory Stick Duo™ from a specified time (▶▶▶ page 50)
	UMD™ Video Volume	Boosts the volume of the UMD™ Video (▶▶▶ page 51)
	Screen Mode	Changes the size of the image displayed on the screen (▶▶▶ page 50)
	Display	Displays the playback status and related information (▶▶▶ page 49)
	Help	Displays the functions that can be performed using the PSP™ system buttons
	Previous	Returns to the previous chapter of a UMD™ Video during playback
	Return to Beginning	Returns to the beginning of a video saved on a Memory Stick Duo™ during playback
	Next	Skips to the next chapter*
	Fast Reverse/ Fast Forward	Accelerates playback (reverse or forward) on the screen to help locate a particular scene (▶▶▶ page 51)
	Slow	Plays a scene in slow motion (▶▶▶ page 51)
	Frame Advance	Plays a scene one frame at a time
	Play	Starts playback
	Pause	Pauses playback
	Stop	Stops playback
	Repeat	Plays the video repeatedly (▶▶▶ page 52)

* This operation cannot be performed during playback of a video saved on a Memory Stick Duo™.

Icon	Description
 Clear	Clears the Repeat setting

Viewing playback status and related information

- 1 Select  from the control panel during playback, and then press the  button.

The playback status of the video is displayed.

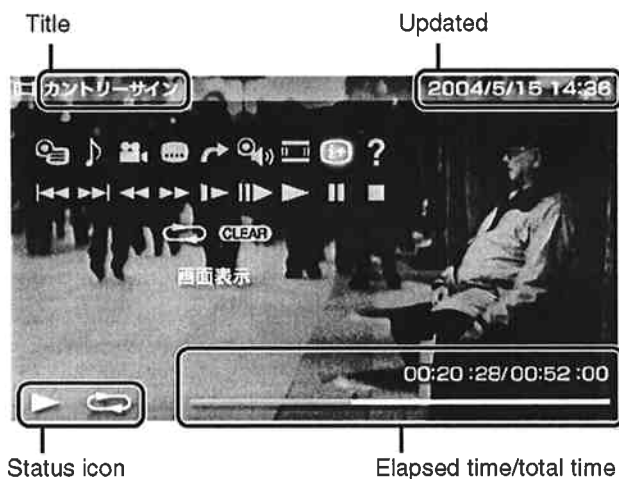

Video

Clearing display

Select  from the control panel, and then press the  button.

Hint

The items displayed when playing a UMD™ Video are different from those displayed when playing a video saved on a Memory Stick Duo™.

Changing the Screen Mode

Changes the size of the viewable image on the screen.

- 1 Select  from the control panel, and then press the  button.

Each time the  button is pressed, the Screen Mode will change as follows:



Normal	The image is adjusted to fit the PSP™ system's screen size.
Zoom	The image is shown at the full screen size without changing proportions, while cutting off the top and bottom or left and right areas.
Full	The image is shown in the full screen size by changing proportions and zooming in horizontally and vertically.
Original	The image is shown in the original size.

Hint

Depending on the video being played, the Screen Mode may remain unchanged.

Playback from a selected scene

You can play video data stored on a Memory Stick Duo™ starting from a specified time.

- 1 Select  from the control panel, and then press the  button.
- 2 Using the directional buttons, specify a time value, and then press the  button.

Adjusting the UMD™ Video volume

The volume can be adjusted if the audio output level of the UMD™ is low.

- 1 Select  from the control panel, and then press the  button.

Each time you press the  button, the volume will change as follows:

+1	Raises the volume
+2	Raises the volume (maximum)
Normal	Usually select this setting.

Video

Hint

The volume setting will be cleared if the UMD™ is ejected. The volume can be permanently set to a higher level under Video Settings (▶▶▶ page 84).



Fast Reverse/Fast Forward

- 1 During playback, select  or  from the control panel, and then press the  button.

Returning to normal playback

Select  from the control panel, and then press the  button.

Hint

While using Fast Reverse or Fast Forward, select  or  from the control panel, and then press the  button to switch between three speed options.





Slow playback

- 1 During playback, select  from the control panel, and then press the  button.

Returning to normal playback

Select  from the control panel, and then press the  button.

Hint

Selecting  or  from the control panel while playback is paused, and then pressing the  button, will also start slow playback. If  (Fast Forward) is held down, slow playback will continue only as long as the  button is held.

Playing repeatedly

You can play the entire disc or a chapter repeatedly.

1 Select from the control panel, and then press the button.

Each time you press the  button, the repeat mode changes as follows:









Disc Repeat	Plays the entire disc repeatedly
Chapter Repeat	Plays the specified chapter repeatedly
Repeat Off	Ends repeat playback

Hints

- You can also stop repeated playback by pressing the  button after selecting **CLEAR** from the control panel.
- The only repeat options for videos saved on a Memory Stick Duo™ are Repeat On and Repeat Off.

Operating with PSP™ system buttons or the remote control

You can operate the PSP™ system without using the control panel by using the system buttons or the remote control.

	System button operation	Remote control operation
Play	Press the  button or start button.	Press the  button.
Pause	Press the start button.	Press the  button.
Displaying the UMD™ menu	Press the  button.*1	–
Stop	Press the  button.	–
Play the previous chapter or return to the beginning of the video	Press the L button.	Press the  button.
Play the next chapter	Press the R button.*1	Press the  button.*1
Fast Reverse	Press the left button.*2	Press and hold the  button.
Fast Forward	Press the right button.*2	Press and hold the  button.
Slow	Press the right button during pause.*2	–

US

Video

*1 This operation cannot be performed during playback of video saved Memory Stick Duo™.

*2 Video plays in Fast Reverse/Fast Forward/Slow as long as this button is held down.

Hint

Some buttons cannot be operated while the control panel is displayed on the screen. In this case, press the  button to clear the control panel.

Video options menu

You can use the Video options menu to play a UMD™ Video or view information or delete videos saved on a Memory Stick Duo™.

- 1 Select the icon, and then press the **△** button.
The options menu is displayed.

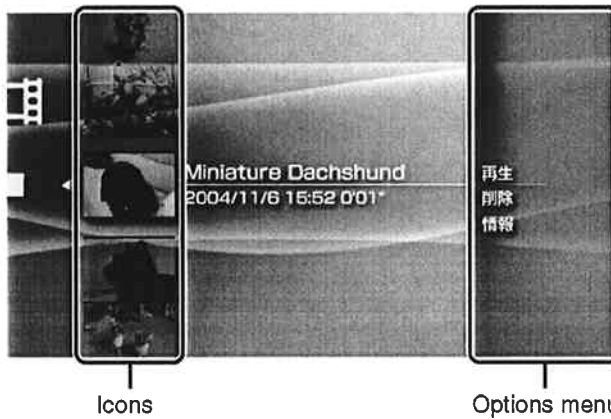

- 2 Select a menu item, and then press the **×** button.

Clearing the options menu

Press the **△** button or the **○** button.

Options list

The options menu items available vary depending on the icon selected.

Play	Plays a UMD™ Video or a video saved on a Memory Stick Duo™
Play from Beginning	Plays a UMD™ Video from the beginning
Delete	Deletes a video saved on a Memory Stick Duo™
Information	Displays information about the selected icon

Saving videos on a Memory Stick Duo™

The following methods can be used to save a video on a Memory Stick Duo™.

Images or video recorded with a device that is compatible with MPEG-4

When using an MPEG-4-compatible device, you can play still or motion video by directly inserting the compatible device's Memory Stick Duo™ into the PSP™ system.

* The only MPEG-4 files that can be played with the PSP™ system are MP4 format files that conform with the Memory Stick™ video format. See "Compatible media" (▶▶ page 110) for more information about compatible formats. Also visit www.memorystick.com/psp for more information about compatible devices.

Hint

A Memory Stick Duo™ Adaptor (model number MSAC-M2: a Sony product sold separately) is required if your MPEG-4-compatible device can handle only a standard-size Memory Stick™.

Video

Transferring a video file from a PC to a Memory Stick Duo™

You can convert still or motion video that was taken or recorded on another device into a format that can be played on the PSP™ system and transfer it to a Memory Stick Duo™ using "Image Converter 2" (a Sony product sold separately). Files can be transferred using any of following methods:

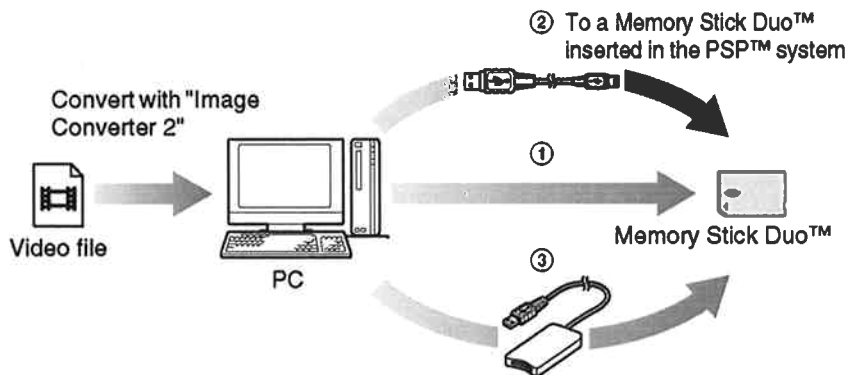

- ① Use a PC with a Memory Stick™ slot.
- ② Use a commercially available USB cable (•▶ page 96).
- ③ Use a commercially available Memory Stick™ USB reader/writer.*

* If the device can handle only the standard-size Memory Stick™, you will need a Memory Stick Duo™ Adaptor (model number MSAC-M2: a Sony product sold separately).

Hints

- See www.memorystick.com/psp for information on the file formats that can be converted and where you can purchase "Image Converter 2", a Sony product sold separately.
- The PSP™ system cannot play video data converted at bit rates higher than 768 kbps.

Music



Listening to music

You can listen to UMD™ Audio and music saved on a Memory Stick Duo™. The file formats (for music saved on Memory Stick Duo™) that can be played are ATRAC3plus™ and MP3 (→page 67).



- 1 Select  from the home menu.
- 2 Insert a UMD™ or a Memory Stick Duo™ (→pages 32, 33).
An icon for the inserted media is displayed.

Music



- 3 Select the icon, and then press the  button.
The group or track list will be displayed. Select a track you want to listen to, and then press the  button.

Icons displayed under Music

 UMD™	You can play UMD™ Audio. If you select the icon a thumbnail for the music is displayed.
 Memory Stick™	You can play music saved on a Memory Stick Duo™.

Hints

- If the start button or the ►|| button on the remote control is pressed in step 3, the first track of the first group will begin playing.
- If the home button or select button is pressed during playback, the screen will return to the home menu. If the button is pressed again, the music playback screen will be displayed.
- You can adjust the tone or mute the sound using the sound button (•►page 35).

What is a Group?

A group is a collection of music data arranged in a certain order, such as by album or by artist. When Group Mode is turned on, the PSP™ system can play tracks in groups that were configured using a PC.

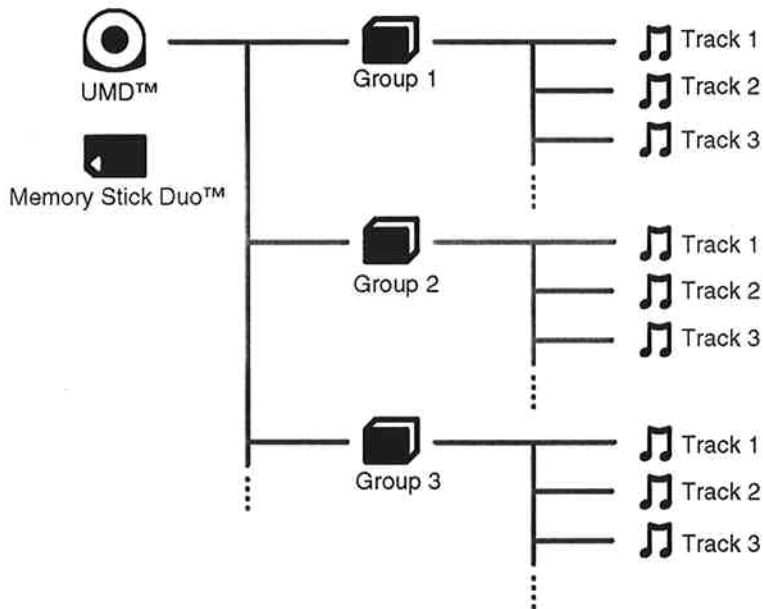

Hints

- The PSP™ system cannot be used to create or edit a group.
- "Track" represents a song.

Stopping playback

- 1 Press the  button during playback.
Playback stops.

How to read the screen

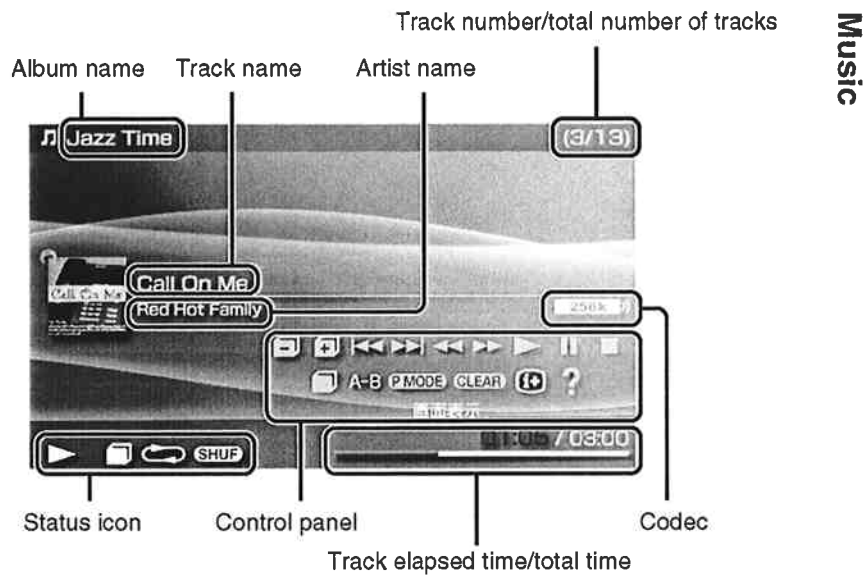

Hints

- "Album name" and "Track number/total number of tracks" are shown on the screen only while  (Display) is turned on.
- The icon or icons displayed in the "Status icon" field will vary depending on the playback mode selected.
- See "Playing with a selected codec" (▶▶ page 66) for details about codecs.

Using the control panel

You can perform the following operations using the on-screen control panel.

1 Press the Δ button during playback.

The control panel is displayed.



2 Select an icon, and then press the \times button.

Clearing the control panel

Press the Δ button or the \odot button.

List of operations

Icon		Description
	Previous Group	Returns to the beginning of the previous group
	Next Group	Skips to the beginning of the next group
	Previous Track	Returns to the beginning of the track currently playing or to the beginning of the previous track
	Next Track	Skips to the beginning of the next track

Icon		Description
	Fast Reverse/ Fast Forward	Plays in fast reverse/fast forward*
	Play	Plays a track
	Pause	Pauses playback
	Stop	Stops playback
	Group Mode	Switches to Group Mode (▶▶ page 61)
A-B	A-B Repeat	Specifies a part of a track, and then plays that part repeatedly (▶▶ page 62)
P MODE	Play Mode	Switches to Play Mode (▶▶ page 62)
CLEAR	Clear	Clears Group Mode, Play Mode and A-B Repeat settings
	Display	Displays album name, track number and total number of tracks
?	Help	Displays the functions that can be performed using the system buttons

Music

* Fast reverses/fast forwards as long as the button is held down.

Using Group Mode

Tracks can be played in groups. Playback stops after all tracks in the group have been played.

- 1 During playback, select from the control panel, and then press the button.
Group Mode is turned on, and then is displayed on the screen.



Clearing Group Mode

While Group Mode is on, select from the control panel, and then press the button.

Using Play Modes (Repeat/Shuffle) **P MODE**

- 1 During playback, select **P MODE** from the control panel, and then press the **(X)** button.

Each time the **(X)** button is pressed, the system switches between the following functions:

Play Mode	Description
 1	Plays a track repeatedly
	Plays all tracks repeatedly
SHUF	Plays all tracks in a random order*
 SHUF	Plays all tracks in a random order repeatedly
No icon	Clears Play Mode and plays through to the last track in normal order

* If there is a group, tracks in the group are played in a random order. The order of the groups will not change.

Hint

Play Modes can also be cleared by selecting **CLEAR** from the control panel, and then pressing the **(X)** button.

Playing part of a track repeatedly (A-B Repeat) A-B

Specify and then play the part that you want to play repeatedly.

- 1 Select **A-B** from the control panel during playback, and then press the **(X)** button at the point where you want the repeated playback to begin.

The starting point (point A) is set.

2 Press the button at the point where you want the repeated playback to end.

The ending point (point B) is set, and repeated playback of the specified section begins.

Clearing A-B Repeat

Select **A-B** or **CLEAR** from the control panel, and then press the  button. The specified part is cleared, and normal playback resumes.









Hints

- The range for A-B Repeat can only be specified within a single track.
- If the ending point (point B) is not set, the end of the track will automatically become the ending point (point B).
- If A-B Repeat is set while in a Play Mode, the Play Mode will be cleared.

Music

Operating with PSP™ system buttons or the remote control

You can operate the PSP™ system without using the control panel by using the system buttons or the remote control.

	System button operation	Remote control operation
Play	Press the  button or start button.	Press the  button.
Pause	Press the start button.	Press the  button.
Stop	Press the  button.	—
Skip to the beginning of the current track or the previous track	Press the L button.	Press the  button. Or, press the  button as many times as the number of tracks you want to go back.
Skip to the beginning of the next track	Press the R button.	Press the  button.
Fast Reverse	Press the left button.*	Press and hold the  button.
Fast Forward	Press the right button.*	Press and hold the  button.

* Fast reverses/fast forwards as long as the button is held down.

Hint

Some buttons cannot be operated while the control panel is displayed on the screen. In this case, press the  button to clear the control panel.

Music options menu

You can use the Music options menu to view information about or delete music data saved on a Memory Stick Duo™.

- 1 Select an icon, and then press the **△** button.
The options menu is displayed.

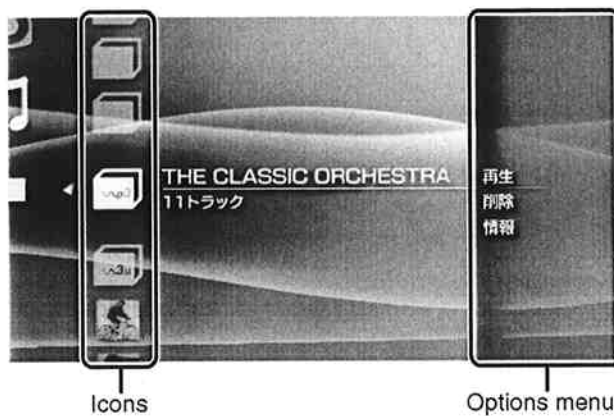

Music

- 2 Select a menu item, and then press the **×** button.

Clearing the options menu

Press the **△** button or the **○** button.





Options list

The options menu items available vary depending on the icon selected.

Play	Plays UMD™ Audio or music data saved on a Memory Stick Duo™
Select Codec	Sets a file format or bit rate for music playback (▶▶ page 66)
Delete	Deletes music data saved on a Memory Stick Duo™.
Information	Displays information about the selected icon

Playing with a selected codec

With a UMD™ Audio that has multiple file formats and bit rates recorded, you can select from among these options for playback.

- 1 Select a group you want to listen to, and then press the  button.**
- 2 Select "Select Codec", and then press the  button.**
The types of file formats and bit rates are displayed. The items displayed in gray cannot be selected because they are of types that cannot be played on the system.
- 3 Select the type of file format and bit rate that you want to listen to, and then press the  button.**
- 4 Press the  button.**
The icons for groups are displayed.
- 5 After selecting a group, select the track you want to listen to, and then press the  button.**
Playback begins.

Hint

Items such as "ATRAC3plus™" represent the type of file format, while items such as "256 kbps" represent the bit rate. As a general rule, the higher the bit rate, the better the sound quality. See "File formats that can be played" (▶▶ page 112) for details about file formats.

Transferring and saving music on a Memory Stick Duo™

You can use the PSP™ system to play music data obtained in the following ways:

- 1) Music imported from a CD.
- 2) Music purchased from a music download Web site.

See below for instructions regarding item 1).

See www.memorystick.com for instructions regarding items 2).

US

Music

Importing tracks from an audio CD in ATRAC3plus™ format

A PC and software, such as SonicStage™ (a Sony product sold separately), that is compatible with ATRAC3plus™ are required to import tracks from an audio CD. ATRAC3plus™ data cannot be played or recorded using a Memory Stick PRO Duo™. Use any MagicGate™-compatible Memory Stick Duo™ other than Memory Stick PRO Duo™ (▶▶ page 110). You can transfer the imported tracks to a Memory Stick Duo™ using either of the following methods:

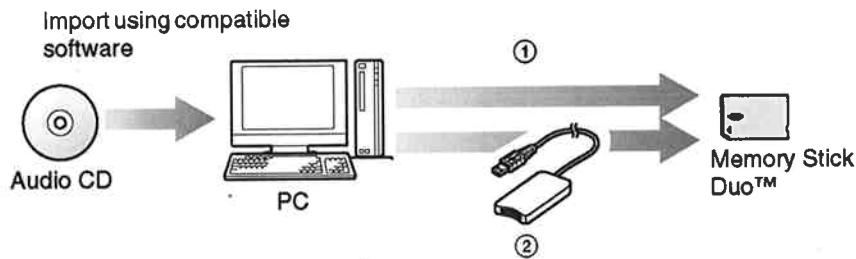

- ① Use a PC with a MagicGate™-compatible Memory Stick™ slot. *1
- ② Use a commercially available Memory Stick™ USB reader/writer. *1*2

*1 If the slot on the device can handle only standard-size Memory Stick™ media, a Memory Stick Duo™ Adaptor (model number MSAC-M2: a Sony product sold separately) is required.

*2 A MagicGate™-compatible device such as model number MSAC-US30 (a Sony product sold separately) is required.

Hints

- SonicStage™ is included with Sony products, such as Memory Stick™ USB reader/writer (model number MSAC-US30; a Sony product sold separately). For detailed information about importing tracks, see www.memorystick.com/psp
- The PSP™ system cannot play tracks that have an expiration date or a limited number of playbacks.

Importing tracks from an audio CD in MP3 format

A PC, and software that is compatible with the MP3 format, are required to import tracks from an audio CD.

You can save imported tracks on a Memory Stick Duo™ using any of the following methods:

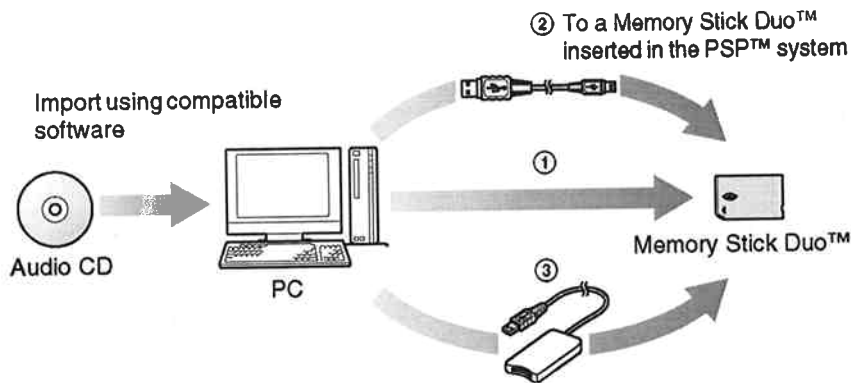

- ① Use a PC with a Memory Stick™ slot.*
- ② Use a commercially available USB cable (→ page 96).
- ③ Use a commercially available Memory Stick™ USB reader/writer.*

* If the slot on the device can handle only standard-size Memory Stick™ media, a Memory Stick Duo™ Adaptor (model number MSAC-M2; a Sony product sold separately) is required.

Hint

The method of importing tracks varies depending on the software. For details, refer to the instructions supplied with the software.



Where to save music data

Create a folder named "PSP" directly on the Memory Stick Duo™, and then create a folder named "MUSIC"* in the "PSP" folder. Save MP3 data in the "MUSIC" folder. The PSP™ system will not recognize data items saved anywhere other than in this folder.

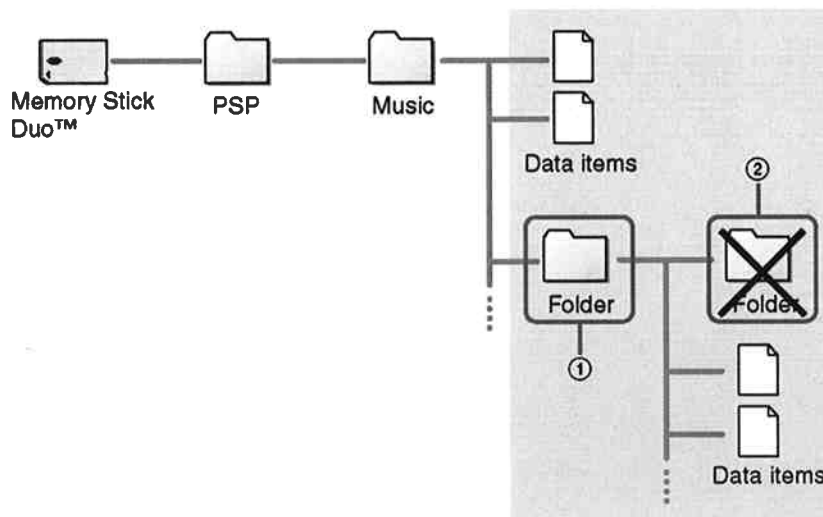
* Filename does not need to be all capital letters.



Hints

- If a folder named "PSP" has already been created on the Memory Stick Duo™, create a "MUSIC" folder within it.
- You can create folders within the "MUSIC" folder (Figure ①). The system will display each created folder as an  (MP3) icon, and treats it as a group.
- Folders created within sub-folders will not be recognized (Figure ②).
- If you want to specify the order of the tracks, create an m3u file specifying the order in the folder. The system will display the file as an  (m3u) icon, and treat it as a group.
- If a file that is not an MP3 file is saved in the "MUSIC" folder, the system will not recognize it.