

SONY®

Felica

Reader/Writer Module

RC-S640/IA

Product Specifications

Note: This document is subject to change without notice.

Introduction

This document describes the major features and specifications of Sony's Reader/Writer module, RC-S640/IA. For the purpose of this document, the terms below denote the products or equipment described to the right.

- Card : A contactless IC card.
- Reader/Writer : A device used to read and write contactless IC cards, tags and devices.
- Controller : An external computer or an equivalent device that is directly connected to a Reader/Writer via a specific cable.

RC-S640/IA satisfies the specifications mentioned with this document only when it connects with the specified antenna.

Please confirm the specified antenna for RC-S640/IA. (Refer to Appendix A)

- FeliCa is a contactless IC card technology developed by Sony Corporation.
- FeliCa is a trademark of Sony Corporation.
- All names of companies and products contained herein are trademarks or registered trademarks of the respective companies.
- No part of this document may be copied, or reproduced in any form, without the prior consent of Sony Corporation.
- Information in this document is subject to change without notice.
- Sony Corporation assumes no liability for damages arising from, or in connection with, the use of this document.

Safety Information and Caution**WARNING**

To reduce the risk of fire or electric shock, do not expose this apparatus to rain or moisture.
To avoid electrical shock, do not open the cabinet. Refer servicing to qualified personnel only.

For the customers in USA

This device complies with Part 15 of the FCC Rules. Operation is subject to the following two conditions: (1) This device may not cause harmful interference, and (2) this device must accept any interference received, including interference that may cause undesired operation.

WARNING

You are cautioned that any changes or modifications not expressly approved in this manual could void your authority to operate this equipment.

Note: This equipment has been tested and found to comply with the limits for a Class B digital device, pursuant to Part 15 of the FCC Rules. These limits are designed to provide reasonable protection against harmful interference in a residential installation. This equipment generates, uses, and can radiate radio frequency energy and, if not installed and used in accordance with the instructions, may cause harmful interference to radio communications. However, there is no guarantee that interference will not occur in a particular installation. If this equipment does cause harmful interference to radio or television reception, which can be determined by turning the equipment off and on, the user is encouraged to try to correct the interference by one or more of the following measures:

- Reorient or relocate the receiving antenna.
- Increase the separation between the equipment and receiver.
- Connect the equipment into an outlet on a circuit different from that to which the receiver is connected.
- Consult the dealer or an experienced radio/TV technician for help.

For the customers in Canada

This Class B digital apparatus complies with Canadian ICES-003.

This device complies with Industry Canada licence-exempt RSS standard(s). Operation is subject to the following two conditions: (1) this device may not cause interference, and (2) this device must accept any interference, including interference that may cause undesired operation of the device.

The term "IC:" before the radio certification number only signifies that Industry Canada technical specifications were met.

Pour les clients au Canada

Cet appareil numérique de la classe B est conforme à la norme NMB-003 du Canada.

Le présent appareil est conforme aux CNR d'Industrie Canada applicables aux appareils radio exempts de licence. L'utilisation doit répondre aux deux conditions suivantes: (1) ce matériel ne doit pas provoquer de brouillage et (2) il doit accepter tout brouillage, même celui qui est susceptible d'affecter son fonctionnement.

La mention « IC: » devant le numéro de certification/ homologation signifie uniquement que les spécifications techniques d'Industrie Canada sont remplies.

For the customers in Europe

Hereby, Sony Corporation, declares that this RC-S640/IA is in compliance with the essential requirements and other relevant provisions of Directive 1999/5/EC.

For details, please access the following URL:

<http://www.compliance.sony.de/>



For use in following areas: residential, commercial and light industrial.

This product has been tested and found compliant with the limits set out in the EMC Directive for using connection cables not longer than 3 meters (9.8 feet).

Emissions from this inductive device could cause interference to nearby receivers of other radio services.

The manufacturer of this product is Sony Corporation,
1-7-1 Konan, Minato-ku, Tokyo, Japan

The Authorized Representative for EMC and product safety is Sony Deutschland GmbH,
Hedelfinger Strasse 61, 70327 Stuttgart, Germany

Contents

1 Key functions and features	8
2 Hardware specifications	9
2.1 Major specifications	9
2.1.1 FeliCa or ISO/IEC 18092 (212 / 424 kbps) communication	9
2.1.2 ISO/IEC 14443 or ISO/IEC 18092 (106 kbps) communication	9
2.1.3 Compatible cards, tags and devices ^{*1,2}	10
2.1.4 RF communication performance	10
2.2 Interface	11
2.2.1 Connector	11
2.2.2 Pin assignment	11
2.3 Electrical specifications	12
2.3.1 Absolute maximum rating	12
2.3.2 Electrical characteristics	12
Others	13
2.4 Reliability specifications	13
2.5 External dimensions	14
2.5.1 Module	14
3 Precautions	15
3.1 Handling precautions	15
3.2 Notes on external appearance	16
Appendix A About specified antenna	17
A.1 RC-S640/IAA	17
Appendix B About installation	19
B.1 Installation requirements for RC-S640/IAA	19
B.2 Reduction of the impact of metal	20

1 Key functions and features

RC-S640/IA (hereinafter called the module) is a Reader/Writer module certified by NFC Forum Certification Program. The module can communicate with any devices that conform to the NFC Forum specification as well as Sony's FeliCa technology and other broadly adopted technologies supporting ISO/IEC 14443 Type A/B contactless smart card standard including the T=CL transmission protocol.

Key functions and features of the module are detailed below. For more information, please contact our distributors or sales representative.

- Higher interoperability provided by the compliance with NFC Forum 1st Wave Certification with NFC Forum 1 through 4 tags and other NFC-Forum-certified devices.
- Compatible with a wide variety of ISO/IEC 14443 Type A/B contactless smart card including the T=CL transmission protocol
- Compatible with Sony's FeliCa contactless smart card such as FeliCa Standard, FeliCa Plug, FeliCa Lite, and mobile phones incorporating a Mobile FeliCa IC chip.
- Based on an inductive read/write system type-certified by the Radio Law of Japan. It is also compliant with the relevant standards in the United States, Canada, and Europe.
- High versatility for installation by a really thin antenna.

NOTE Only at the time of combination with the specified antenna, RC-S640/IA acquires the safety standard of each country. Please keep in mind that the combination of other antenna has a possibility of becoming regulation infringement.

2 Hardware specifications

This chapter focuses on major hardware specifications.

2.1 Major specifications

The following describes the module's major specifications.

2.1.1 FeliCa or ISO/IEC 18092 (212 / 424 kbps) communication

- Carrier frequency (fc) : 13.56 MHz
- Data transfer rate^{*1} : fc / 64 (212 kbps, approximately), fc / 32 (424 kbps, approximately)
- Modulation system : Transmission – ASK, Reception – ASK
- Bit coding : Transmission – Manchester coding, Reception – Manchester coding
- Communication system : Half-duplex communication

^{*1} Available only when the card or the device to be used is also compatible with fc / 32.

2.1.2 ISO/IEC 14443 or ISO/IEC 18092 (106 kbps) communication

- Carrier frequency (fc) : 13.56 MHz
- Data transfer rate^{*2} : fc / 128 (106 kbps, approximately), fc / 64 (212 kbps, approximately),
fc / 32 (424 kbps, approximately)
- Modulation system
 - Type A (fc / 128) : Transmission – ASK, Reception – ASK
 - Type A (fc / 64, fc / 32) : Transmission – ASK, Reception – BPSK
 - Type B : Transmission – ASK, Reception – BPSK
- Bit coding
 - Type A (fc / 128) : Transmission – Modified Miller
Reception – Manchester coding with subcarrier
 - Type A (fc / 64, fc / 32) : Transmission – Modified Miller, Reception – NRZ with subcarrier
 - Type B : Transmission – NRZ, Reception – NRZ with subcarrier
- Communication system : Half-duplex communication

^{*2} Available only when the card or the device to be used is also compatible with fc / 64 or fc / 32.

2.1.3 Compatible cards, tags and devices ^{*1,*2}

- Card based on FeliCa
- NFC Forum Tag
- NFC-Forum-certified device

^{*1} Usable number of cards: One at a time.

^{*2} Operation is not necessarily guaranteed. Please consult us in advance when using a card or a device other than the ones listed above.

2.1.4 RF communication performance

- 25 mm or more (No dead zones of 1 mm or more wide within the above range)

<Measurement conditions>

In a free space (temperature: 25 °C, humidity: 50 %RH) that is potentially unaffected by nearby radio waves and magnetic sources, a single RC-S888 card (operating at its center frequency) is polled by a standard module. The card is placed so that its center aligns with the center of the module's antenna along a vertical axis perpendicular to the antenna surface, with its longitudinal edges maintained in parallel to those of the antenna.

NOTE The communication performance may be different with the kind of the card, direction of the card and data transfer rate, making it necessary to verify its performance.

2.2 Interface

Interfacing between the module and the controller utilizes the connector described below.

2.2.1 Connector

- Model number: IMSA-9681S-15A-GF/Y901 made by IRISO ELECTRONICS CO., LTD.
Low-profile, 0.5mm pitch FFC/FPC connector
(Au plated / Bottom side terminal / SMT / Right angle / ZIF / 15 poles)

NOTE For applicable cable, refer to C.1 “Terminal requirements of FFC/FPC”.

2.2.2 Pin assignment

Table 2-1: Pin assignment

No.	Designation	Function	Remarks
1	MOD_VDD	Power supply	DC 3.3V
2	MOD_GND	Ground	
3	SWP	Single wire protocol line to UICC/SIM	
4	MOD_GND	Ground	
5	IRQ	Interrupt request from module to platform	
6	VDD_SIM	Power rail used to UICC/SIM	
7	I2C_SDA	I2C Data	
8	I2C_SCL	I2C Clock	
9	MOD_GND	Ground	
10	Reset/ Wake UP	Reset pin input from the host to wake up the device from standby and also to reset the device	
11	NC/Float	Floating / Not connected	
12	SWP_PWR	Power supply to UICC/SIM or power supply request to PMIC	
13	MOD_VDD	Power supply	DC 3.3V
14	VDD_IO	Host IO reference voltage	DC 3.3V
15	MOD_GND	Ground	

NOTE Please confirm the position of 1pin in external dimensions.

2.3 Electrical specifications

2.3.1 Absolute maximum rating

Observe the following ranges of operation in order to avoid irreparable damage to the module.

Table 2-2: Absolute maximum rating

Item	Rating	Unit
Power supply voltage	-0.3 ~ +4.0	V
Input voltage	-0.3 ~ VDD+0.3	V

2.3.2 Electrical characteristics

Table 2-3: Electrical characteristics

(Conditions) Temperature: 25 °C, Humidity: 50 %RH

Pin	Item	Min	Max	Unit	Remarks
MOD_VDD VDD IO	Power supply voltage* ¹	3.135	3.465	V	
MOD_VDD	Current consumption(RF On)* ²		150	mA	
	Current consumption(Standby)		120	μA	
I2C_SDA	H-level input voltage	0.75 x VDD	VDD	V	
I2C_SCL	L-level input voltage	0	0.25 x VDD	V	
	L-level output voltage	0	0.25 x VDD	V	I _{OL} =3mA
IRQ	H-level output voltage	0.8 x VDD	VDD	V	I _{OH} =-2mA
	L-level output voltage	0	0.2 x VDD	V	I _{OL} =2mA
Reset / Wake UP	H-level input voltage	1.2	VDD	V	
	L-level input voltage	0	0.3	V	

*¹Fully verify to noise from power supply, other modules and cables, since noise exerts deleterious effects on communication performance.

*²Current consumption changes by power supply voltage, the existence of cards, installation.

Others

- Operating environment (no condensation or frost)
 - Performance assurance temperature/humidity^{*1}

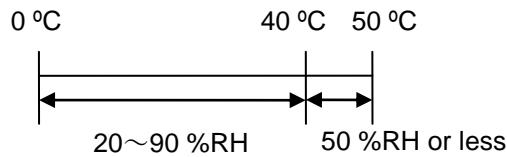

- Function assurance temperature/humidity^{*2}

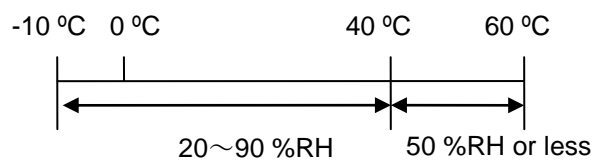

^{*1} Guarantees section 2.1.4 “RF communication performance”.

^{*2} Guarantees normal operation of the RF communication processor, although the communication performance described above cannot be assured in temperature extremes.

NOTE The module temperature inevitably rises if module is continually transmitting card access commands (such as when polling a card). Make sure to design the enclosure so that the internal temperature and humidity can be held within the specified ranges.

- Storage environment (no condensation or frost)

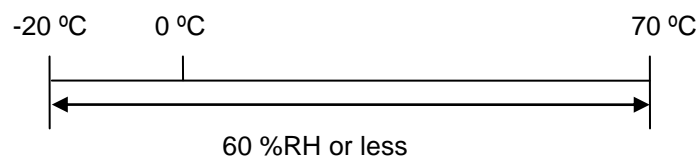

- Mass : T.B.D.

2.4 Reliability specifications

- Shock : IEC60068-2-27 Test Ea
- Vibration : IEC60068-2-64 Test Fh

2.5 External dimensions

The external dimensions are shown in the following figures.

2.5.1 Module

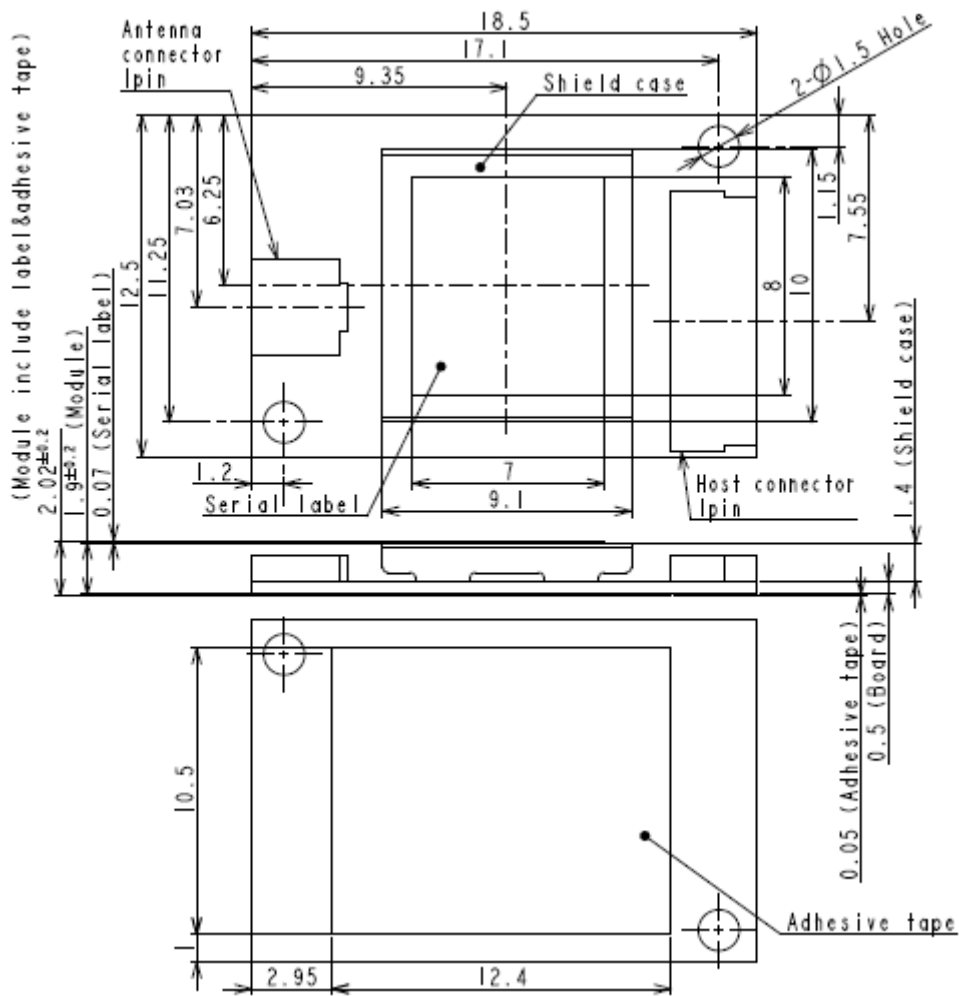

Tolerance: ± 0.2

Unit: mm

NOTE Perforations are not included in board size.

Figure 2-1 External dimensions of module

3 Precautions

3.1 Handling precautions

The module must be handled with special care, keeping the following precautions in mind.

- The module is an inductive-type read/write communication device that is type-certified in compliance with the Radio Law of Japan. The operating frequency is 13.56 MHz. Disassembly or modification of the module, removal of the type number or similar acts are subject to penalties according to applicable laws.
- Be sure to use a stable power supply so that the module can be protected from the effect of noise and excessive voltage peaks, such as lightning, transmitted through the power supply connector.
- Do not cause any chemical or physical damage to the module.
- Do not subject the module surface to contaminated air or materials.
- Tightly ground not only module after installation but all jigs, machines, workbenches and workers' bodies to prevent static electricity from affecting the module.
- For safety's sake, be sure to wear gloves when handling the module, although its surfaces are carefully finished.
- Protect the module from interference from other wireless machines.
- Do not install the module in an environment where a strong electromagnetic field may exert deleterious effects on communication performance. Take special note of the installation location so that interference between the module and other equipment can be adequately controlled.
- Communication performance may be affected by the harmonics of the 13.56 MHz carrier frequency generated on the signal line.
- Check in advance the compatibility between the module and your system. The module cannot handle part of the processing sequences^{*1} provided by mobile phones and other portable devices incorporating mobile FeliCa IC chips.
- The interface cable (FFC / FPC) is not supplied, making it necessary to prepare the one appropriate for your system. When selecting the cable, make sure to connect a cable in the right direction because the connector has a double terminal.
- Be sure to shut the cover of an antenna connector tightly. And the cover opens only to the angle of approximately 90 degrees above when unlocked.
- Measures for static noise and power line noise must be designed and incorporated on your own. Especially, if the module is connected to two or more system ground ports which have a difference in electric potential, it may depreciate communication performance and cause unexpected noise.
- Treat an antenna carefully. Damage of an antenna or change of antenna characteristics may occur by bending, pulling, twisting, press or brandishing it strongly. For the same reason, do not tear off the antenna once stuck on adhesive tape or a cabinet.

^{*1} Among the processing sequences unique to mobile FeliCa compatible portable devices, the module cannot handle the sequence which allows wireless communication from the Reader/Writer after the mobile FeliCa IC chip was activated by the portable device via a wired interface. For more information, refer to the "Mobile FeliCa Technical Information" (Japanese only) that explains Reader/Writer operation in mobile applications.

3.2 Notes on external appearance

Since the module is designed for embedded applications, please realize that flaws on the order described below may occur.

- Scratch or stain on the product surface, which has no effect on performance.
- Change in the board color.

Appendix A About specified antenna

A.1 RC-S640/IAA

The following describes the specified antenna for RC-S640/IA-

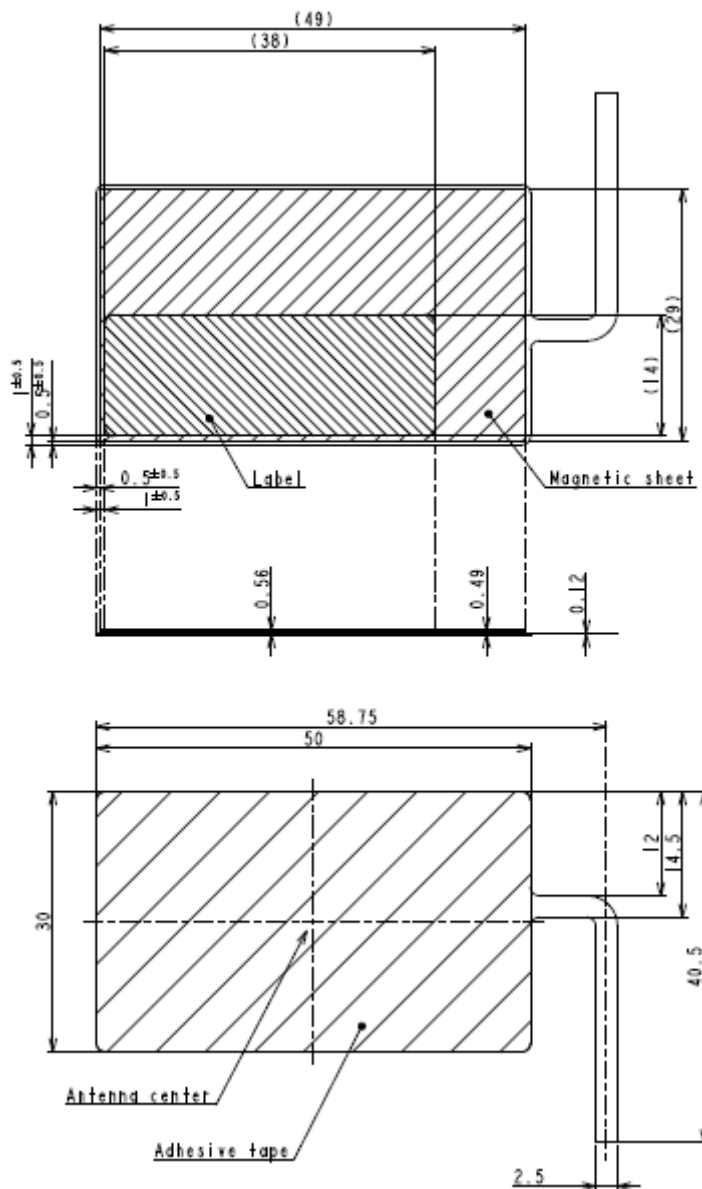

Tolerance: ± 0.3

Unit: mm

Figure A-1 External dimensions of antenna

NOTE1 Only at the time of combination with the specified antenna RC-S640/IAA, RC-S640/IA acquire the safety standard of each country.

NOTE2 Please connect antenna (1pin) to antenna connector (1pin), as shown in below figure. By the placement of a module, a recommended connection direction may change.

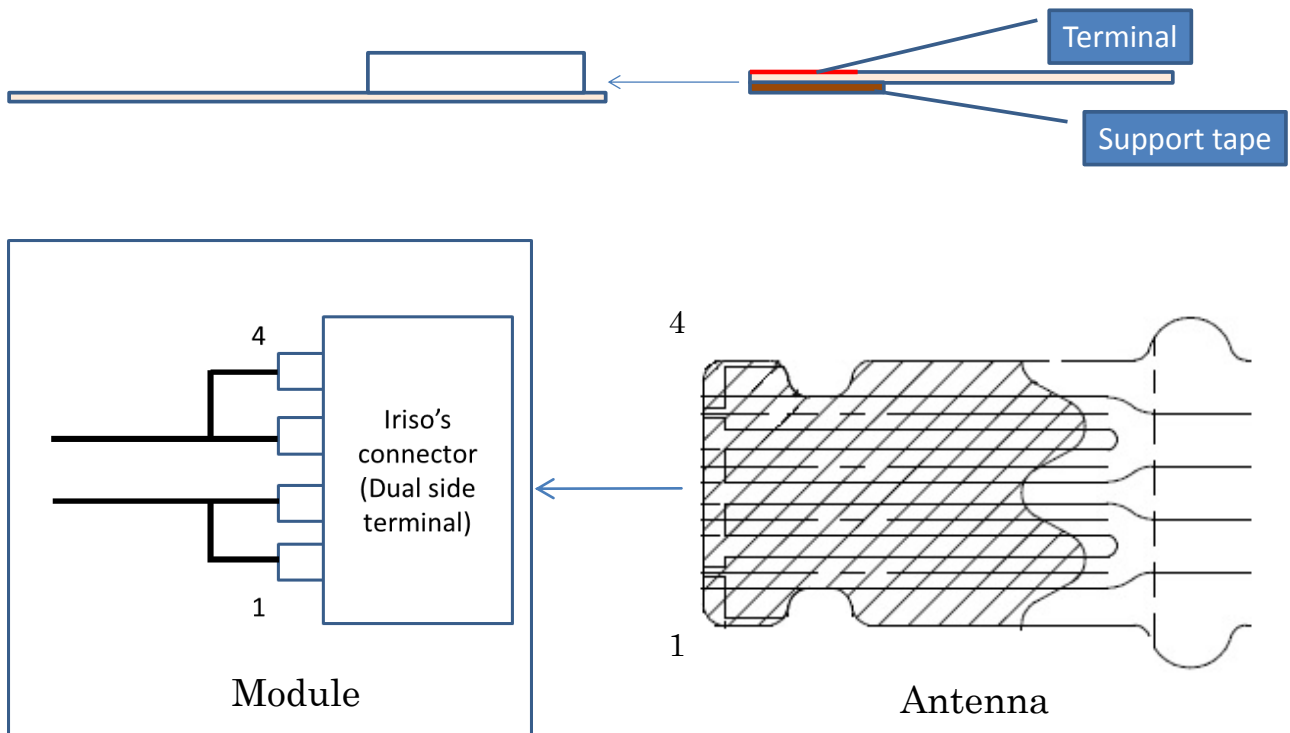

Figure A-2 Connection of a module and an antenna

Appendix B About installation

B.1 Installation requirements for RC-S640/IAA

The following describes the points to remember when installing the antenna.

1. Do not use any metal or carbon compound as the material for the cabinet. The cabinet surface must be at least 1.5 mm apart from the antenna surface.
2. Stick the antenna to a plane (modification of the antenna is subject to penalties according to applicable laws or regulations). Do not place any metal in the forbidden area (dot-meshed area in Figure B-1) secured around the antenna. Particularly, communication performance undoubtedly deteriorates if a plate-like metal is put near the antenna. And to avoid damage to an antenna, do not place projections or movable parts. Moreover, fix the positional relationship between a module and an antenna.
3. In order not to induce eddy current, make a cut in the metal plate surrounding the above forbidden zone.
4. If no performance improvement is achieved through the steps described above, attempt to add magnetic sheet (90 mm x 70 mm or more), as shown in Figure B-2, to the metal surface that faces the card and keep away the antenna from a metal plate at least 3 mm ($d > 3$).

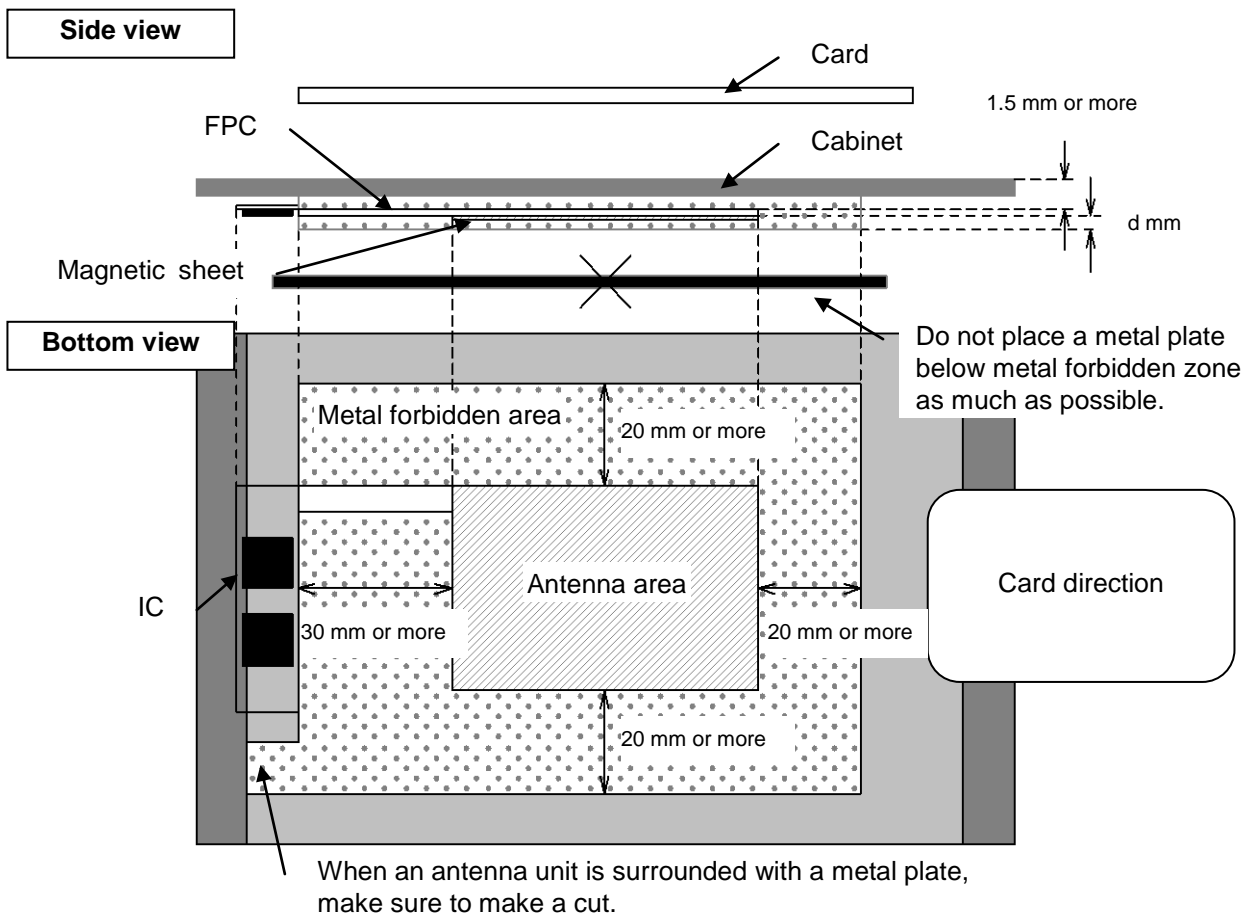

Figure B-1: Installation requirements

B.2 Reduction of the impact of metal

Deviation from the resonance point caused by bringing the card closer to the metal plate may result in a change in the card's original characteristics. The effect of metal plate could be reduced by adding magnetic sheets to the positions illustrated above.

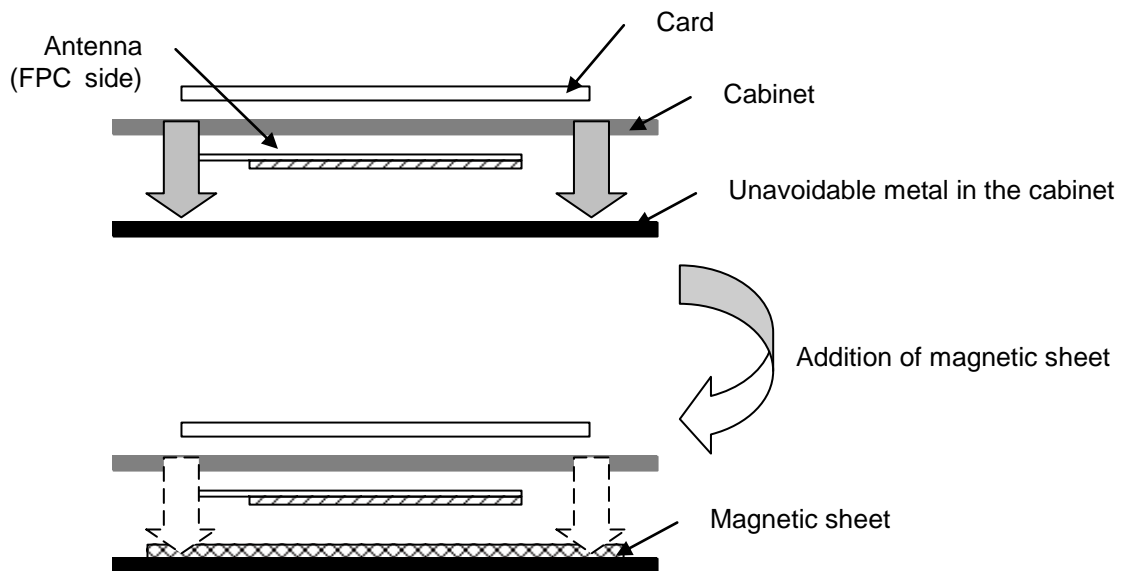

Figure B-2: Reduction of the impact of metal

Reader/Writer Module
RC-S640/IA Product Specifications

Sony Corporation