



Locating a channel by station ID (continued)

3

- CH  Press CH +/- to select the station ID you want.

3	ET
9	MTV
10	WGN
12	ABC
13	HBO
15	CBS
19	TB02
22	TNT
43	TNT
45	ESPN

4

- ENTER  Press ENTER.

Note

- If the TV channel has no station ID, the channel number appears on the TV screen.

Recording TV programs using VCR Plus+

Just enter the program's PlusCode listed in the TV program guide. The date, times and channel number of that program are set automatically. You can preset up to eight programs at a time.

Before you start...

- Check that the VCR clock is set to the correct time.
- Turn on your TV and set it to the video channel. When using a cable box, turn it on.
- Insert a tape with its safety tab in place. Make sure the tape is longer than the total recording time.
- If you insert a tape with the SmartFile function, make sure the total recording time doesn't overlap the protected program. For details about the SmartFile function, see page 100 through 101.

1

- VCR Plus+  Press VCR Plus+.

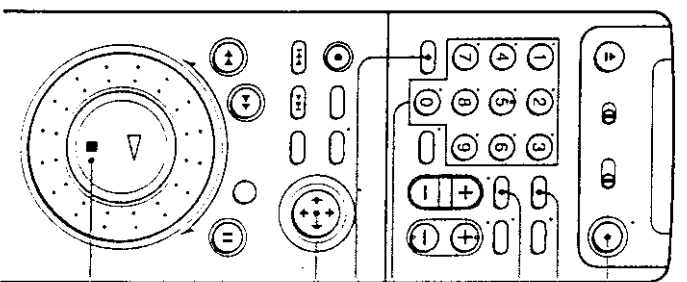

POWER
VCR Plus+
CLEAR
Number buttons
SET
Cursor s
←/→

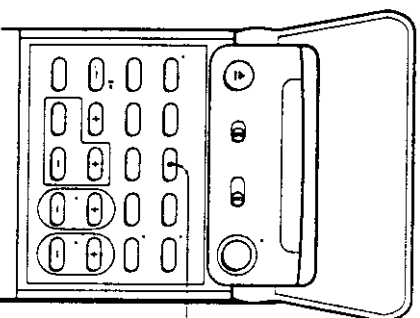

SP/EP

STOP

VCR Plus+

PressCode
SP/EP
Enter program's Plus using 0-9 keys
To change tape speed, press [SP/EP]

contin

Recording TV programs (continued)

Tips

- To select a channel, you can use the number buttons on the remote commander. Enter the channel number, then press ENTER.
- You can select a video source from the LINE-1 IN or LINE-2 IN jacks using INPUT SELECT.
- The display appears on the TV screen indicating information about the tape, but the information won't be recorded on the tape.
- If you don't want to watch TV while recording, you can turn off the TV. When using a cable box, make sure to leave it on.
- You can set the channel with the shuttle ring during stop. However, you cannot set the channel with the shuttle ring on the remote commander when:
 - you set CABLE MOUSE in the CABLE BOX CONTROL menu to ON.
 - you press JOC, so that VCR is in jog mode.

Notes

- The remaining time may not be indicated accurately for short tapes such as T-20 or T-30, or tapes recorded in the LP mode.
- The display does not appear during still (pause) mode or slow-motion playback.
- It may take up to one minute for the VCR to calculate and display the remaining time after you press DISPLAY.



To use the VCR after setting the timer



To use the VCR before a timer recording begins, just press POWER. The indicator turns off and the VCR switches on. Remember to press POWER to reset the VCR in timer recording standby after using the VCR.

You can also do the following tasks while the VCR is recording:

- Reset the counter.
- Display tape information on the TV screen.
- Check the timer settings.
- Watch another TV program.

To lock the VCR after setting the timer (Child Lock)

While the VCR turns on, hold POWER down on the VCR until the  indicator appears in the display window. The VCR turns off and the  indicator remains lit. The VCR will not work except for timer recording.

To unlock the VCR, hold POWER down on the VCR until the  indicator disappears from the display window. The VCR is unlocked and turns on. To stop timer recording while the VCR is locked, press  STOP. The recording stops and the VCR is unlocked.

Tips

- To cancel VCR Plus+ recording, press VCR Plus+ before pressing SET in step 4 on page 62.
- When you are recording a program in the SP mode and the remaining tape becomes shorter than the recording time, the tape speed is automatically changed to the B mode. Note that some noises will appear on the picture when the tape speed is changed. If you want to keep the tape speed, set AUTO TAPE SPEED to OFF in ADVANCED OPTIONS menu (page 83).

Notes

- If the VCR doesn't accept the PlusCode, this means that:
 - the PlusCode is incorrect.
 - ONCE, DAILY, or WEEKLY was selected incorrectly. You cannot select DAILY, WEEKLY for a program that airs more than seven days ahead.
- The VCR will be unlocked when:
 - you stop timer recording by pressing  STOP.
 - you insert a tape.
 - the AC power cord is disconnected or power supply stops.

Recording TV programs (continued)

- 3**  Press INPUT SELECT until a channel number appears in the display window.

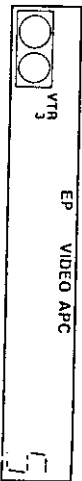

- 4**  Press CH +/- to select the channel you want to record.

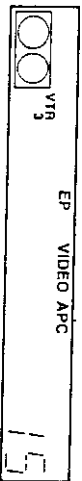

- 5**  Press SP/EP to select the tape speed, SP or EP. EP (Extra Play) provides recording time three times as long as SP (Standard Play), however, SP produces better picture quality.

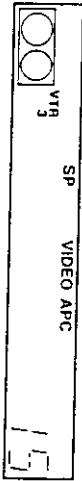

- 6**  Press ● REC to start recording. The recording indicator lights up red in the display window.

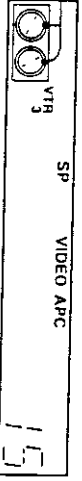

To stop recording
Press ■ STOP!

2



• CURSOR
PUSH OK

- Set the date, start and stop times, channel number and tape speed:
- 1 Push the cursor stick to → to highlight each item in turn.
 - 2 Push the cursor stick to ↓/↑ to set each item.

To correct a setting, push the cursor stick to ← to return to that setting and reset.

When you set the channel number the station ID appears on the TV screen. You can set it while checking the station ID.

To record the same program every day or the same day every week, push the cursor stick to ↓ while the date is highlighting. For details, see "Daily/weekly recording" on the next page.

To record from a source connected to the LINE-1 IN or LINE-2 IN jacks, press INPUT SELECT to display "LINE1" or "LINE2" in the "CH" position.

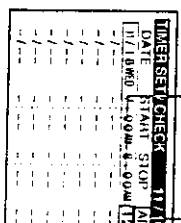
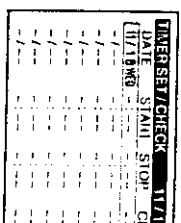

3



• CURSOR
PUSH OK

Push the cursor stick to → to confirm the setting.

The cursor appears at the beginning of the line. To enter another setting, move the cursor to the next line and repeat step 2.

4



• CURSOR
PUSH OK

Press the cursor stick (OK).

5



• POWER

Press POWER to turn off the VCR.

The ⊙ indicator appears in the display window and the VCR stands by for recording.

When using a cable box, leave it on.

continued

Playing a tape (continued)

Additional tasks

To	Press
Stop play	■ STOP
Pause play	PAUSE
Resume play after pause	PAUSE or ▷ PLAY
Fast-forward the tape	▶▶ FF during stop
Rewind the tape	◀◀ REW during stop
Eject the tape	▲ EJECT

To skip playback

You can skip a portion of playback you don't want to watch such as a commercial and restart playback by pressing a single button.

- 1 Press SMART CUE during playback of the scene you want to skip. The VCR starts searching.
- 2 Press SMART CUE again when you find the scene you want to watch. The VCR stops searching, rewinds a few seconds, then resumes normal playback.

If you press and hold SMART CUE while the VCR is skip searching, the VCR will stop searching, and continue rewinding until you release SMART CUE.

Tip

- You can change the length of rewinding time on the ADVANCED OPTIONS menu. See page 83.

To use the time counter

At the point on the tape that you want to find later, press COUNTER RESET. The counter in the display window resets to "0:00:00." Search for the point afterwards by referring to the counter.

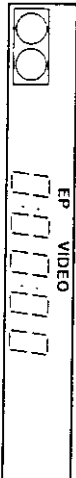

To display the counter on the TV screen, press DISPLAY.

Notes

- Tapes recorded in the LP mode on other VCRs can be played back on this VCR but the picture quality cannot be guaranteed.
- The counter resets to "0:00:00" whenever a tape is reinserted.
- The counter stops counting when it comes to a portion with no recording.

Additional Operations

Playing/searching at various speeds

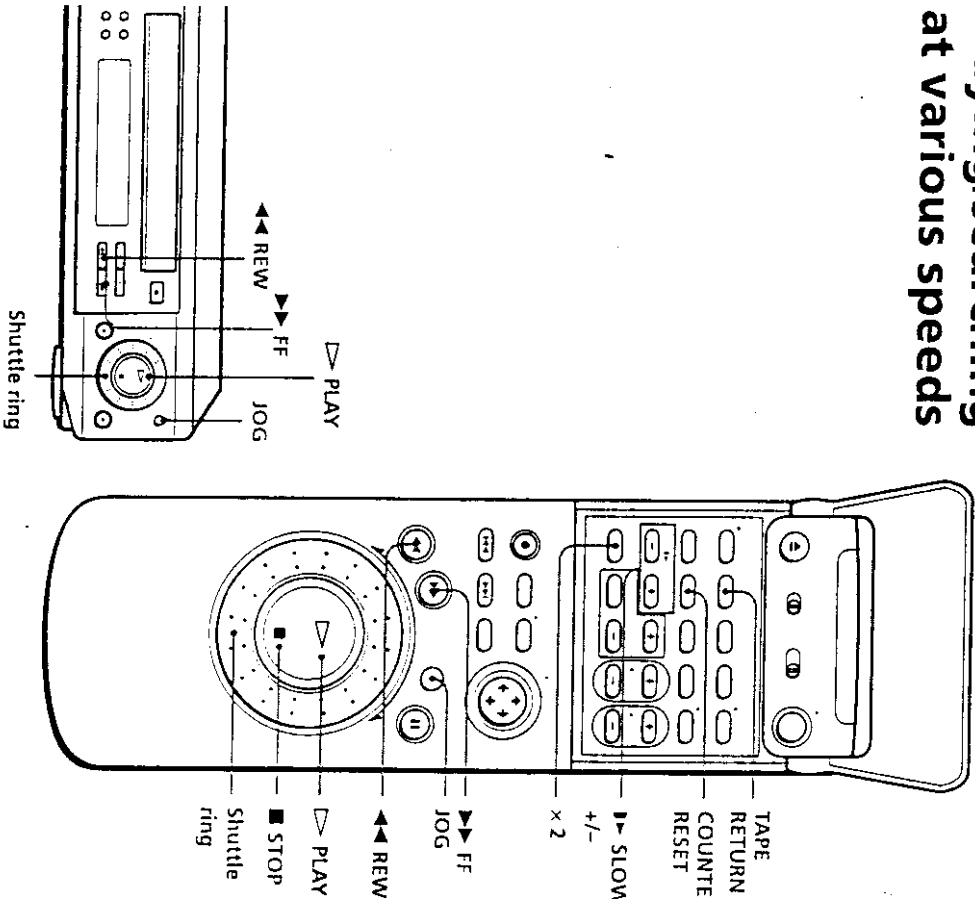

Playback options	Operation
View the picture during fast-forward or rewind	During fast-forward, hold ▶▶ FF down. During rewind, hold ◀◀ REW down.
Search forward	Press ▶▶ FF during playback.
Search backward	Press ◀◀ REW during playback.
Play at twice the normal speed	Press x2 during playback.
Play in slow motion	During playback or pause, press ▶ SLOW +/- . Press the +, - buttons to change the speed.

continuu

Setting up VCR Plus+ (continued)

4

- ①
- ②
- ③
- ④
- ⑤
- ⑥
- ⑦
- ⑧
- ⑨
- ⑩
- ⏏

• If you made Hookup 1, 2, or 3: Enter the actual number on your TV (and VCR) and press ENTER.

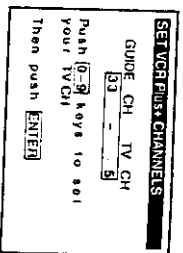

• If you made Hookup 4: Enter the cable output channel (usually 2, 3, or 4) and press ENTER.

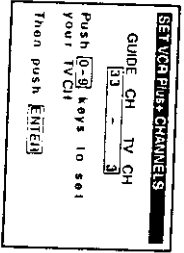

• If you made Hookup 6: Enter the actual number on your TV (and VCR) for an unscrambled channel and press ENTER. For a scrambled channel, enter the cable box output channel (usually 2, 3, or 4) and press ENTER.

5

Repeat steps 3 and 4 for each guide channel number that doesn't match.

6

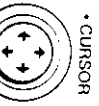

When you have set all channels, press the cursor stick (OK) to confirm your channel settings.

VCR Plus+ CHANNEL LIST			
GUIDE #	TV	GUIDE	TV
2	73	59	47
5	4	61	3
17	55	77	35
28	8	86	120
43	118	90	22

Use [+/-] to change page
Push MENU to quit

7



After all settings are complete, press MENU to exit.

To use the shuttle ring in jog mode

Use this mode for frame-by-frame playback.

Press JOC to enter jog mode. The JOC button lights up. If you change mode during any playback mode, the playback pauses so you can see the picture. Each change in the shuttle ring position shifts the picture one frame. To shift frames in reverse, turn the shuttle ring counterclockwise. To resume normal playback, press JOC again. The JOC indicator goes

To resume normal playback

Press \blacktriangleleft PLAY.

Tip

- Adjust the picture using the TRACKING +/- buttons if:
 - streaks appear while playing in slow motion.
 - bands appear at the top or bottom while pausing.
 - the picture shakes while pausing.

Notes

- The sound is muted during these operations.
- Tapes recorded in the LP mode on other VCRs can be played back on this VCR.
- The picture quality cannot be guaranteed.
- The picture may have snow:
 - when playing at high speed in reverse.
 - when playing in reverse slow motion.
 - when playing in reverse.
- If the playback mode mark doesn't appear on the TV screen, press DISPLAY.
- The picture may flutter a bit when playing in slow motion.

Setting up VCR Plus+ (continued)

4



• **POWER** Press **POWER** to turn off the VCR.

The VCR sets the program guide channels from 0:00 am to 5:00 am while the VCR is turned off. (It takes about 1 hour to complete channel mapping.)

To select the channel map

If the program information signal in your area has several channel map patterns (up to 8), the Choose your Cable CH MAP menu appears:

- the first time you turn on the VCR after completing channel mapping
- after selecting AUTO and pressing the cursor stick (OK) on the SMART CHANNEL MAPPING menu

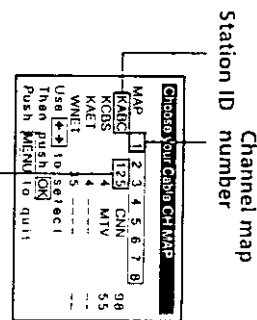

In this case, you have to select the channel map on the Choose your Cable CH MAP menu.

- 1 Find the VCR Plus+ Channel Line-up Chart in your program guide. For details, see page 48.
- 2 Push the cursor stick to **←/→** to select the channel map number you want by checking the channel number in the program guide.
- 3 Press the cursor stick (OK).

Notes

- It takes about 1 hour to complete channel mapping.
- The VCR can receive the program information signal only while the VCR is turned off and no timer recordings are set.
- The VCR cannot set the guide channels correctly unless you enter the ZIP/POSTAL CODE in your area.
- When you move to a different area, you must set up the VCR again and enter your new ZIP/POSTAL CODE in the EASY SET UP procedure.

Notes

- The figure on the bar indication represents the total time length of the inserted as shown below.
The total time length may not be displayed correctly for:
– tapes other than T-60, T-120, or T-160
– tapes recorded in more than one tape speed mode.

Tape type	Total time length		
	SP	LP	EP
T-60 or shorter	60	120	180
from T-80 to T-140	120	240	360
T-160 or longer	160	320	480

- If you move the pointer (+) on the bar indication during search, the VCR search for the new reset point.

Setting up VCR Plus+

How VCR Plus+ works

Whenever you want to record a TV program, all you need to do is look up the program's "PlusCode," a number assigned to each program published in the TV section of most newspapers, cable TV listings, and even *TV GUIDE* magazine. Then, just enter the PlusCode of the program you want and the VCR is automatically programmed to record that show. It's that simple.

How to set up your VCR

Setting up your VCR involves coordinating the TV channel number (the number you turn to on your TV or VCR to watch a program) with the guide channel (the number that's assigned to that channel in your program guide).

The VCR can set the guide channels automatically (see page 49), but you may have to set the guide channels manually depending on your area or the way you hooked up your VCR (see page 51).

To find the guide channel numbers, look at the "Channel Line-up Chart" in the program guide for your area that features VCR PlusCodes. It usually looks like the example to the right.

Example of "PlusCode"

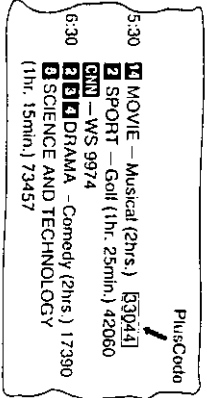

Example of "Channel Line-up Chart"

CABLE CH	CABLE TV	VCR Plus+ GUIDE CH
16	AMC American Movie Classics	35
17	BRV Bravo (program grid only)	54
20	CND Cable News Network	42
21	CSP C-SPAN	28
22	DIS The Disney Channel	53
25	DSG The Discovery Channel	37
34	ESP ESPN	34
35	FAM The Family Channel	47
5	HBD Home Box Office	33
27	LIP Lifetime	46
29	MAX Charge 7	45
30	MTV Music Television	48
31	MTW MTV2	38
36	SPN Sports Channel	59
39	SCA Sports Channel America	70
45	SRD Showtime	41
17	TBS TBS SuperStation	43
44	TMC The Movie Channel	58
49	TNN The Nashville Network	49
50	TNT Turner Network Television	52
51	USA USA Network	44

Creating a favorite channel list with station IDs

You can create your favorite channel list of the TV channels with station IDs. You can store up to 10 channels with station IDs and select the channel from your favorite channel list.

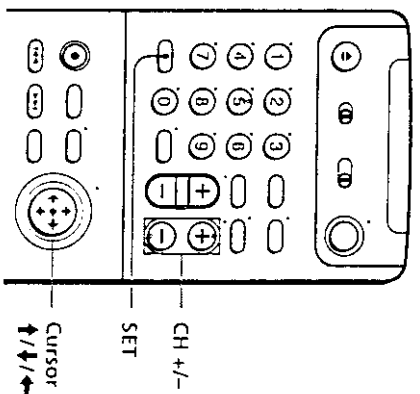

1 Press SET.

The FAVORITE CH screen appears on the TV screen.

2 Press CH +/- to select the station ID you want to replace.

You can also use the cursor stick \uparrow/\downarrow instead.

3 Push the cursor stick to \leftarrow/\rightarrow to select the station ID you want to set.

4 Repeat steps 2 and 3 to set the station IDs as required.

5 Press SET.

Note If the TV channel has no station ID, the channel number appears on the TV screen.

FAVORITE CH	FAVORITE CH
12	12
9	9
13	13
19	19
3	3
45	45
43	43
22	22
10	10

FAVORITE CH	FAVORITE CH
12	12
15	15
27	27
10	10
19	19
3	3
45	45
43	43
22	22
10	10

continues

Presetting channels (continued)

Presetting/disabling channels manually

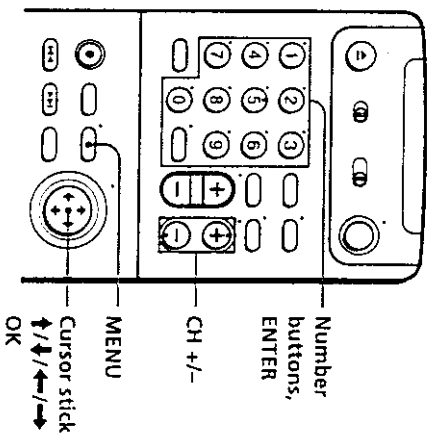

- 1 Press **MENU** and select **TUNER PRESET**, then press the cursor stick (OK).

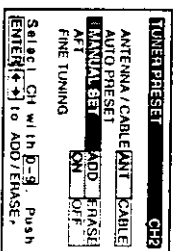

- 2 To preset a channel:
 - 1 Press the number buttons to enter the channel number, then press **ENTER**.
 - 2 Push the cursor stick to **←/→** to set **MANUAL SET** to **ADD**.

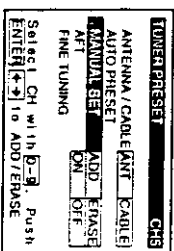
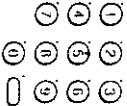

- To disable a channel:
 - 1 Press **CH +/-** to select the channel number.
 - 2 Push the cursor stick to **←/→** to set **MANUAL SET** to **ERASE**.

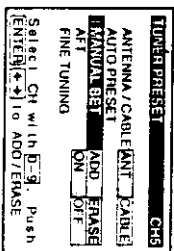

- 3 Repeat step 2 to preset or disable channels as required, then press the cursor stick (OK).

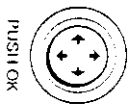

Recording TV programs using the quick timer

After starting recording in the normal way, you can have the VCR stop recording automatically after a specified duration.

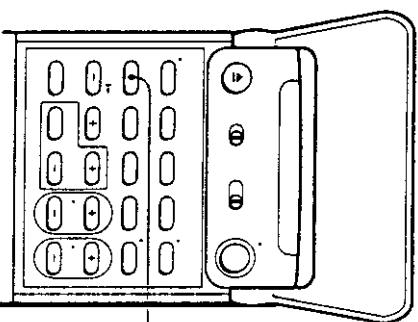

- 1 While recording, press **QUICK TIMER** once. The **⓪** indicator appears in the display window.

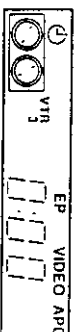

- 2 Press **QUICK TIMER** repeatedly to set the duration. Each press advances the time in increments of 30 minutes.

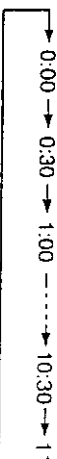

The duration decreases minute by minute to 0:00, then the VCR stops recording and turns off automatically.

- To extend the duration
Press **QUICK TIMER** repeatedly to set to the new duration.
- To stop while recording
Press **■ STOP**.

Using the quick timer during stop mode

- 1 Press **QUICK TIMER**.
- 2 Press **CH +/-** or **INPUT SELECT** to select the channel you want to record.
- 3 Press **QUICK TIMER** repeatedly to set the recording duration. The recording starts.

Presetting channels

(Skip this section if you are using cable box/DSS receiver control feature.)

This VCR is capable of receiving VHF channels 2 to 13, UHF channels 14 to 69 and unscrambled CATV channels 1 to 125. First, we recommend that you preset the receivable channels in your area using automatic presetting. Then, if there are any unwanted channels, disable them manually. If you have decided which channels you wish to preset, set them directly using manual presetting.

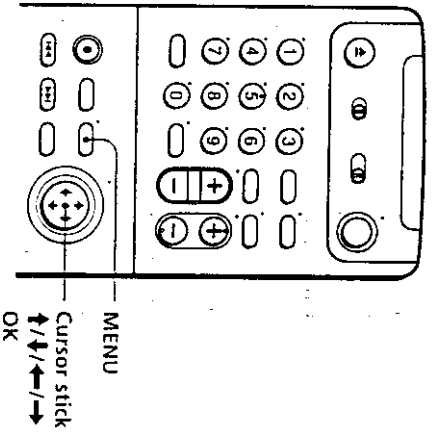

Before you start...

- Turn on the VCR and the TV.
- Set the TV to the VCR channel (channel 3 or 4). If your TV is connected to the VCR using A/V connections, set the TV to video input.
- Press TV/VIDEO to display the VIDEO indicator in the display window.

Presetting all receivable channels automatically

1

- MENU
- cursor

Press MENU, then push the cursor stick to ↑/↓ to move the cursor to TUNER PRSET and press the cursor stick (OK).

When using the EASY SET UP procedure, skip this step.

The screenshot shows a TV screen with the following text:

TUNER PRESET CH12

ANTENNA/CABLE [ENT] [GAIN]

AUTO PRESET [ON] [ERASE]

MANUAL SET [ON] [OFF]

FINE TUNING

Select CH with D-R, Push [ENTER] [↑/↓] to ADD/ERASE

When the timer settings overlap

The program that starts first has priority and the second program starts recording only after the first program has finished. If the programs start the same time, the program listed first in the menu has priority.

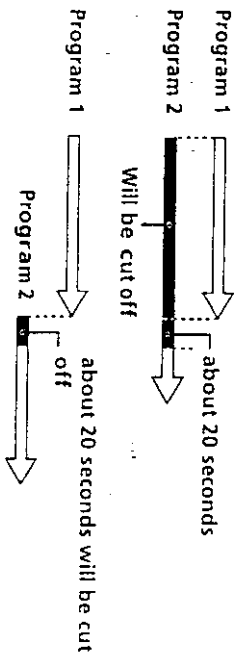

Setting up cable box control (continued)

To ensure correct operation

- Place the Cable Mouse so that it hangs out over the cable box/DSS receiver front.
- Do not place the cable box/DSS receiver on top of the VCR.
- Position the cable box/DSS receiver away from the VCR.
- Point the remote commander at the VCR, not at the cable box/DSS receiver.

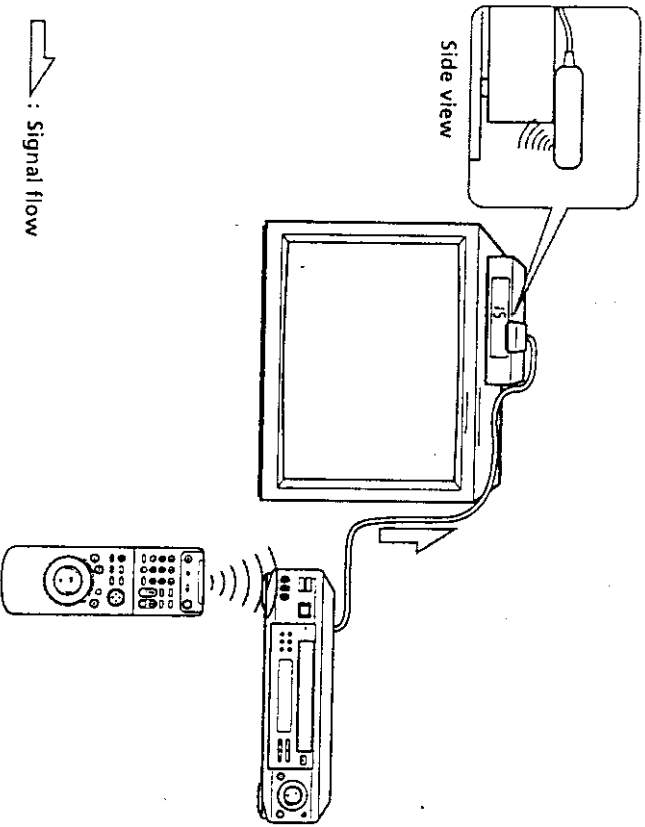

To check the cable box control setting

- 1** Press CH +/- on the remote commander. Does the channel indicator on the cable box/DSS receiver change? (Point the remote commander at the VCR, not at the cable box/DSS receiver.)
- 2** Press all 10 number buttons (0 to 9) on the remote commander. Does the channel indicator on the cable box/DSS receiver change?
If the answer to both 1 and 2 is "yes," you have made the correct setting.

How sound is recorded on a video tape

The VCR records sound onto two separate tracks. Hi-fi audio is recorded onto the main track along with the picture. Monaural sound is recorded onto the normal audio track along the edge of the tape.

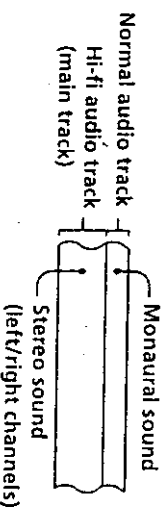

Notes

- To play a tape in stereo, you must use the A/V connections.
- When you play a tape recorded in monaural, the sound is heard in monaural regardless of the AUDIO MONITOR setting.
- If the AUDIO MONITOR button does not function, check that AUDIO MIX in the ADVANCED OPTIONS menu is set to OFF.

3

- ① Press the number buttons to enter the cable box / DSS receiver code number, then push the cursor stick to ↓.
- ② Find your cable box / DSS receiver code number from the chart below.

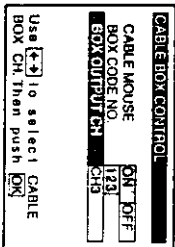
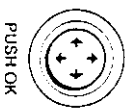

4

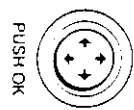

- If you want to control a cable box, push the cursor stick to ← / → to select the output channel for the cable box, then press the cursor stick (OK).
- If you want to control a DSS receiver, select LINE, then press the cursor stick (OK).

Cable box and DSS receiver brand and the corresponding code numbers
 If more than one code number is listed, try entering them one by one, until you come to the correct code for your equipment.

Cable box brand	Code numbers
AIC	018, 022, 024, 028, 217
Amtronix	218
Archer	033, 050, 164, 218, 808
BHT	278
Cable Star	067
Calteenna	033
Cable Time	172, 388, 459
Century	164
Citizen	164, 326, 327
Clyde Cablevision	097
Colour Voice	036, 042
Comband	243, 244
Contronics	051, 071
Deccal	434
Diamond	046
Eagle Contronics	051

Cable box brand	Code numbers
Eastern	013, 285
Electricard	089
Electus	055
Focus	411
Garrard	164
GC Electronics	027, 067, 341
GIE	243, 244
GFC	097
Gemini	026, 068, 081
General Instrument	022, 287, 487
Hamlin	020, 031, 045, 270, 284
Hitech	022
Jasco	164, 326
Jerrold	014, 022, 025, 026, 035, 037, 058, 109, 287, 487
Linsay	451

Adjusting the picture

Adjusting the tracking

Although the VCR automatically adjusts the tracking when playing a tape (the indicator flashes in the display window, then goes off), distortion may occur if the tape was recorded in poor condition. In this case, manually adjust the tracking.

Press the TRACKING +/- buttons to display the tracking meter. The distortion should disappear as you press one of the two buttons (the indicator lights up). To resume automatic tracking adjustment, eject the tape and reinsert it.

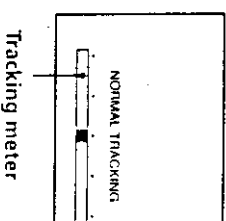

About Adaptive Picture Control (APC)

Adaptive Picture Control (APC) automatically improves recording and playback quality by adjusting the VCR to the condition of the video head and tape. To maintain better picture quality, we recommend that you set APC to ON in the ADVANCED OPTIONS menu (with the APC indicator the display window lit). For details, see page 83.

APC playback

The APC function automatically works on all types of tapes, including tapes and tapes that were not recorded with APC.

APC recording

Whenever you insert a tape and first start recording, the VCR adjusts to the tape using the APC function (the APC indicator flashes rapidly). This adjustment is retained until the tape is ejected.

Notes

- Auto tracking adjustment cannot be guaranteed to work with on tapes recorded the LP mode on other VCRs.
- The APC function does not work if the tape speed is automatically changed from the SP to EP mode during a timer recording, unless the tape has been recorded in the EP mode with the APC function.
- There is a delay of a few seconds before the VCR actually starts recording while VCR analyzes the tape. To avoid the delay, first set the VCR to recording pause (the APC indicator flashes slowly) and press **REC** to have the VCR analyze the tape (the APC indicator flashes rapidly). After the APC indicator stops flashing, press **PAUSE** to start recording immediately.
- If you want to start recording quickly without using the APC function, first set the VCR to recording pause (the APC indicator flashes slowly) and press **PAUSE** to start recording.

Setting the clock (continued)

4

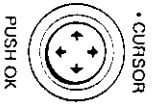

• CURSOR
PUSH OK

Push the cursor stick to **→** to highlight the day and push the cursor stick to **↑/↓** to set the day.

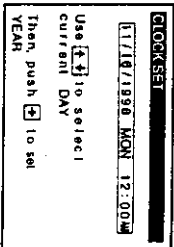

5

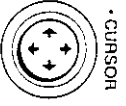

• CURSOR
PUSH OK

Set the year, hour and minutes in the same way as the day. The day of the week is set automatically.

6

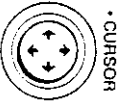

• CURSOR
PUSH OK

Press the cursor stick (OK) to start the clock.

Menu option	Set this option to
APC	ON to switch on the APC (Adaptive Picture Control) function and improve picture quality, OFF to switch off APC.
DIMMER	ON to make the display window dim, OFF to make it brighter.
AUTO TAPE SPEED	ON to change the timer recording tape speed automatically to the 1 mode when the remaining tape becomes shorter than the recording time, OFF to keep the tape speed.
TAPE SELECT	AUTO or 180 (when using a T-140 or T-180) to select the tape length and display the remaining time correctly.
SMART CUE	MEDIUM to set the automatic rewinding time on skip playback to medium length, SHORT to set to short, LONG to set to long.

Note

- If you set the DEFAULT SPEED option to EP, you can still change the recording speed to SP, or vice versa by pressing the SP/EP button only for that program. If time you record a program, the recording tape speed is automatically set to the position you set in the DEFAULT SPEED option.

Setting the clock (continued)

3



CURSOR
PUSH OK

Push the cursor stick to \uparrow/\downarrow to highlight the item you want to set, then push the cursor stick to \leftarrow/\rightarrow to make the setting.

• For CLOCK SET CH

Leave the setting to “_ _ _” to have the VCR automatically search for a channel that carries a time signal.

Press the number buttons to select a channel that carries a time signal.

Use this option if you know of a channel that carries a time signal. Most PBS member stations broadcast a time signal. For the fastest response, select your local PBS station.

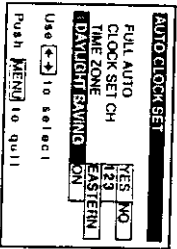

- ① ② ③
- ④ ⑤ ⑥
- ⑦ ⑧ ⑨
- ⑩

• For TIME ZONE

Select the time zone of your area, or select AUTO to have the VCR automatically set your time zone.

The options are: AUTO \rightarrow ATLANTIC \rightarrow EASTERN \rightarrow CENTRAL \rightarrow MOUNTAIN \rightarrow PACIFIC \rightarrow ALASKA \rightarrow HAWAII \rightarrow AUTO

• For DAYLIGHT SAVING

Select ON or OFF (standard time) or AUTO to have the VCR automatically set the daylight saving time.

4



CURSOR
PUSH OK

Press the cursor stick (OK).

5

To activate the Auto Clock Set function, turn off the VCR.

Notes

- If you use both the cable box control feature and the Auto Clock Set feature, the VCR automatically changes channels on the cable box until a channel that carries a time signal is found, whenever you turn off the VCR.
- If you want to stop the search, change the channel on the cable box with the CHANNEL or CH buttons either on the VCR or on the remote commander.
- If you use Hookup 1 or 4, make sure you leave the cable box on.

Operation (when recording on this VCR)

Before you start editing

- Turn on your TV and set it to the video channel.
- Press INPUT SELECT to display “L2” or “L1” in the display window.
- Press SP/EP to select the tape speed, SP or EP.

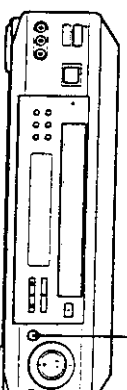

● REC

- 1 Insert a source tape with its safety tab removed into the other (playback) VCR. Search for the point to start playback and set it to playback pause.
- 2 Insert a tape with its safety tab in place into this (recording) VCR. Search for the point to start recording and press **PAUSE**.
- 3 Press **REC** on this VCR and set it to recording pause.
- 4 To start editing, press the **PAUSE** buttons on both VCRs at the same time.

To stop editing

Press the **STOP** buttons on both VCRs.

Tips

- To edit more precisely, press the **PAUSE** buttons on the VCRs to release pause.
- To cut out unwanted scenes while editing, press **PAUSE** on this VCR when a unwanted scene begins. When it ends, press **PAUSE** again to resume recording (Assemble Editing).

Note

- If you start recording following the procedure above, the VCR won't start recording with the APC function. To record a tape with the APC function, press **REC** during recording pause in step 3 so that the VCR analyzes the tape. Then when start recording in step 4, press **PAUSE** immediately after the APC indicator starts flashing. If you press **PAUSE** before the APC indicator stops flashing, the APC function is canceled.

Setting the clock (continued)

3

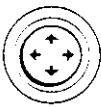

- cursor stick (OK).

PUSH OK

4

To activate the Auto Clock Set function, turn off the VCR.

The VCR automatically sets the clock by searching for a channel that carries a time signal and sets your time zone and Daylight Saving Time (if applicable).

If your clock is set to the wrong time zone or Daylight Saving Time, you can adjust these settings without turning off the Auto Clock Set feature (page 35).

Notes

- The clock cannot be set automatically if you don't receive a channel that carries a time signal in your area. If so, set the clock manually.
- If there are only a few channels in your area that carry time signals, setting the clock automatically may take up to about 30 minutes. If nothing happens even after you wait about 30 minutes, set the clock manually.
- If you use Hookup 1, make sure you leave the cable box on.

Labelling a recorded program and tape (page 95)

You can attach an electronic "label" to the video tape and its programs the SmartFile list. Labelling the recorded programs enables you to find a program easily when you want to play it back. Also, once you label a program which you set to record regularly (i.e. everyday, same day of a week, etc.), the VCR recognizes the label and will automatically label all future recordings of the same program.

Protecting a recorded program (page 100)

You can protect a recorded program from accidental over-recording or erasure.

Erasing the data of an unwanted program (page 100)

By erasing a program from the SmartFile list, the VCR will record over unwanted program.

Storing program data from the DSS receiver (Program Data Download) (page 103)

If you connect a DSS receiver equipped with the Program Data Download function, you can store the program and category name transmitted from DSS on a SmartFile tape. The DSS receiver equipped with the Data Download function will be available in the future.

Selecting a language

You can change the on-screen display language:

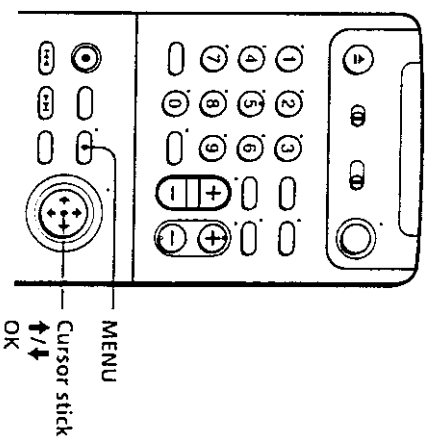

1

- MENU
- cursor

PUSH OK

Press MENU, then push the cursor stick to \uparrow/\downarrow to move the cursor to LANGUAGE and press the cursor stick (OK).
When using the EASY SET UP procedure, skip this step.

The screenshot shows a TV screen with a menu titled "LANGUAGE". The options listed are "ENGLISH", "ESPAÑOL", and "FRANÇAIS". A cursor is positioned over "ENGLISH". Below the screen, a text box says "Use \uparrow/\downarrow to select an item, then push OK".

2

- cursor

PUSH OK

Push the cursor stick to \uparrow/\downarrow to select ENGLISH, ESPAÑOL, or FRANÇAIS, then press the cursor stick (OK).

Recording a program on the SmartFile tape

When recording a program on the SmartFile tape, no matter what method you use to record the program (normal recording, VCR Plus+ recording, etc.), program data (date, channel, recording start time, etc.) is stored in the memory of the SmartFile label. The SmartFile label can contain up to 12 programs' data. When the number of the stored programs goes over 12, the oldest program data is erased from the SmartFile list. However, a program which lasts less than about 15 minutes in EP mode or about 5 minutes in SP mode cannot be stored in the memory.

When you record a program on the SmartFile tape which already contains program data, see "Recording after locating the Blank Time space" on page 91.

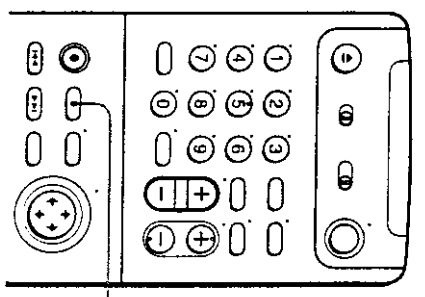

Before you start...

- Turn on your TV and set it to the video channel.

- 1** Insert a SmartFile tape with its safety tab in place.
The VCR turns on, the SMARTFILE indicator lights up, and the SmartFile search list automatically appears on the TV screen.
- 2** Press SMARTFILE.
The Smartfile search list disappears.
- 3** Start recording a program.

Tip

- You can protect a recorded program from accidental over-recording or erasure (see page 100).

Note

- If you press the PAUSE button one or more times during recording, thereby creating short lengths of recorded time between such pauses, program data may be stored in the SmartFile label.

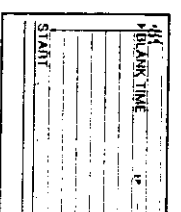

continues

Hookup 6: VCR Plus+ channel setup

- 1 Press MENU and select SET VCR Plus+ CHANNELS.
- 2 Push the cursor stick to ←/→ to select AUTO and press the cursor stick (OK).
- 3 Press POWER to turn off the VCR.

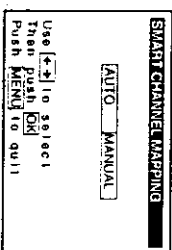
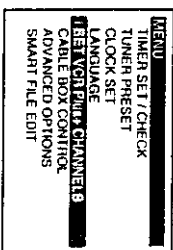

The VCR receives the program information signal from 0:00 am to 5:00 am while the VCR is turned off, and set up the channel for VCR Plus+ recording. After channel setup is finished, you can record TV programs using VCR Plus+. For details, see page 49.

Notes

- To use the Smart Channel Mapping feature, set the A/B switch to A.
- It takes about 1 hour to complete channel setup.
- The VCR can receive the program information signal only while the VCR is turned off and no timer recordings are set.
- If the channels in your area don't carry the program information signals, set the program guide channels manually. For details, see page 51.
- If the Choose your Cable C11 MAP menu appears the first time you turn on the VCR after finishing channel setup, select the MAP number. For details, see page 50.

VCR Plus+ channel setup for scrambled channels

To set the program guide channels for scrambled channels, enter all the scrambled channels you want to record and the cable box output channel (usually 2, 3, or 4) after finishing Smart Channel Mapping. For details, see page 51.

- 1 Find the VCR Plus+ Channel Line-up Chart in your program guide. For details, see page 48.
- 2 Press MENU and select SET VCR Plus+ CHANNELS, then press the cursor stick (OK).

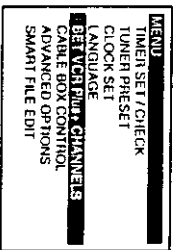

Recording after locating the Blank Time space

The SmartFile function identifies not only the largest amount of available blank space, but also recorded material that doesn't have corresponding program data stored in the SmartFile label. The longest available recording space (including programs that are not stored on the SmartFile label) is referred to as "Blank Time space." You can locate the beginning of the Blank Time space for recording. If there is a recorded program after the Blank Time space, the VCR will over-record on that program unless you stop recording. If there is a program you want to prevent from being recorded over or erased, protect that program before you start recording another program (see pages 100 through 101).

Before you start...

- Turn on your TV and set it to the video channel.

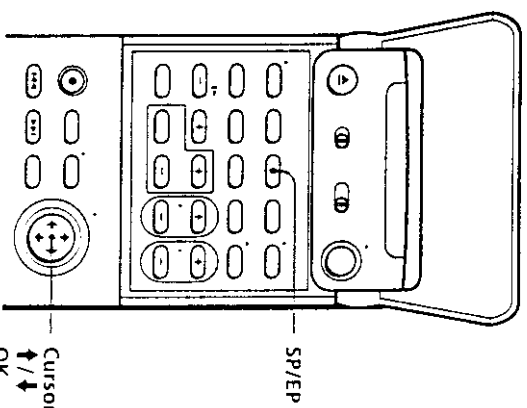

- 1 Insert a SmartFile tape with its safety tab in place.

The VCR turns on, the SMARTFILE indicator lights up, and the SmartFile search list automatically appears on the TV screen. The Blank Time space appears in the "BLANK TIME" row.

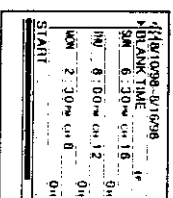

- 2 Push the cursor stick to ↑/↓ to select BLANK TIME.
BLANK TIME is on page 1 of the SmartFile search list.

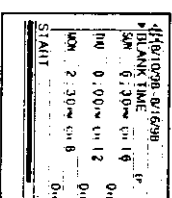

cont'd

Step 3: Hookups (continued)

Hookup 6: VCR setup

- 1 Set the RF UNIT switch to CH 3 or CH 4, whichever channel is not used in your area. If both are used, set the switch to either channel. For details, see page 105.
- 2 If you made A/V connections (from page 9), you can skip this step.
- 3 Set the A/B switch to "A."
- 4 Press EASY SET UP on the VCR.

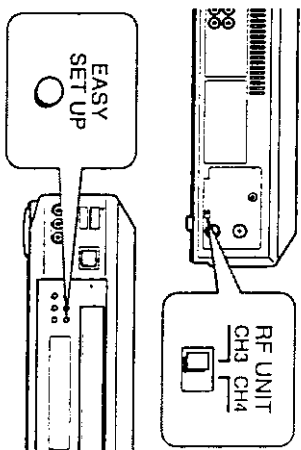

- 1 The LANGUAGE menu appears. Change the on-screen display language to Spanish (ESPAÑOL) or French (FRANCAIS) if desired, and press the cursor stick (OK). For details, see page 32.
- 2 The CLOCK SET menu appears. Select AUTO and press the cursor stick (OK). For details, see page 33.
- 3 The SMART CII MAPPING menu appears. Push the cursor stick to $\uparrow/\downarrow/\leftarrow/\rightarrow$ to enter the ZIP/POSTAL CODE in your area and press the cursor stick (OK). (You can also use the number buttons to enter the ZIP/POSTAL CODE.)
- 4 The CABLE BOX menu appears. Select OFF and press the cursor stick (OK).

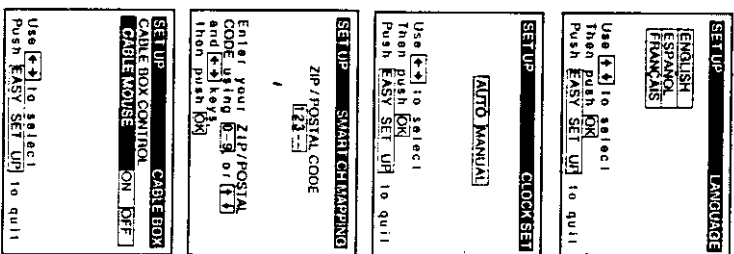

Selecting and playing a program

You can automatically locate and start playback of a program recorded on the SmartFile tape. Select a program in the SmartFile search list. The SmartFile search list can contain up to 12 programs.

Before you start...

- Turn on your TV and set it to the video channel.

- 1 Insert a SmartFile tape. The VCR turns on, the SMARTFILE indicator lights up, and the SmartFile search list automatically appears on the TV screen. If a SmartFile tape is already inserted, press SMARTFILE.
- 2 Push the cursor stick to \uparrow/\downarrow to select a program. Pushing the cursor stick to \uparrow/\downarrow repeatedly will turn the pages.

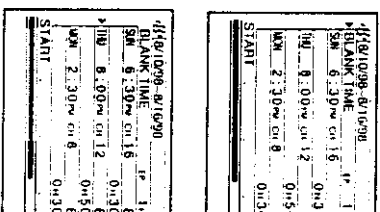

- 3 Press the cursor stick (OK). The VCR starts searching for the beginning of the selected program. Playback starts automatically from that point.

To stop searching

Press \blacksquare STOP.

Note

- You may not be able to locate the beginning of the selected program correctly when:
 - the SmartFile tape contains one or more short length (less than about 15 minutes in EP mode and about 5 minutes in SP mode) recorded programs of which program data are not stored in the SmartFile label.
 - the SmartFile tape is damaged or dirty.

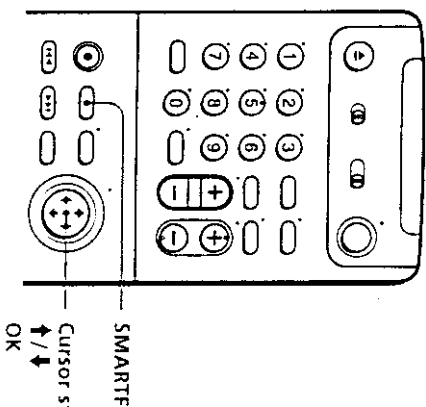

- 8 Enter your DSS receiver code number and push the cursor stick to **↓**. For details, see page 39.

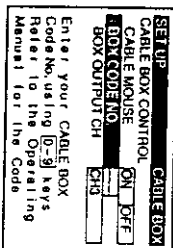

- 9 Set your DSS receiver output channel (BOX OUTPUT CH) to LINE and press the cursor stick (OK).

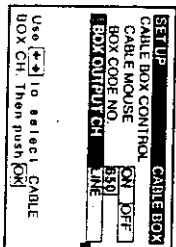

Normal display

Automatic clock setting

Once you've set up the VCR, it automatically sets the clock the first time you turn off the VCR. After that, whenever you turn off the VCR, it checks the time and adjusts the clock, even for Daylight Saving Time. The VCR sets the clock by picking up a time signal provided by some TV channels.

If you want to use the timer to record right away, or if the channels in your area do not carry time signals, set the clock manually. For details, see page 37.

Note

- To successfully record a program from the DSS receiver, proceed as follows:
 - Leave the DSS receiver on all the time.
 - Turn off the display (menu screen, channel number, etc.) of the DSS receiver.
 - To record or receive locked channels, unlock the channel before the VCR starts recording.
 - To set pay-per-view programs in the timer setting, order the pay-per-view program before the VCR starts recording.
 - Some programs are copy protected. You cannot record these programs.

Labelling a recorded program and tape

You can electronically "label" a program and select a category, such as SPECIAL or MOVIE, for a recorded program in the SmartFile list. You can also label a tape. Up to 18 characters can be input for a program and tape label.

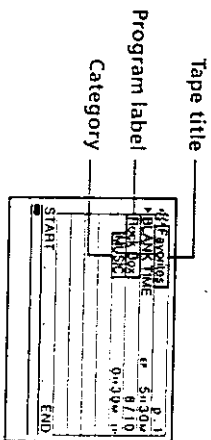

Labelling a recorded program and selecting a category

Before you start...

- Turn on your TV and set it to the video channel.

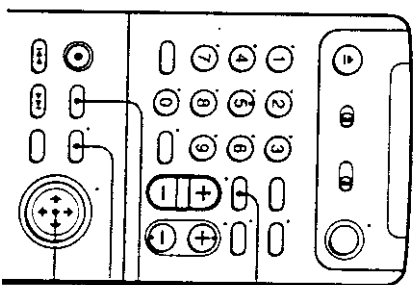

- 1 Insert a SmartFile tape.

The VCR turns on, the SMARTFILE indicator lights up, and the SmartFile search list automatically appears on the TV screen.

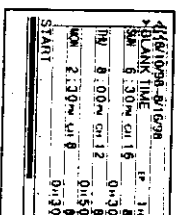

- 2 Press SMARTFILE.

The Smartfile search list disappears.

continuu

DSS (Digital Satellite System) receiver

Recommended use

Use this hookup if you have a DSS receiver. It allows the VCR's cable box control feature to control the channel on the DSS receiver, simplifying the recording process. A list of compatible DSS receivers is on page 41.

DSS (Digital Satellite System) is a satellite broadcast that provides superior digital-quality video and crisp digital-quality audio. A variety of program packages are available through your program providers. It also has program guides that are sorted by program categories.

What you can do with this hookup

- Record any channels using the VCR's cable box control feature to select channels on the DSS receiver.

What you can't do

- Record with the DSS receiver turned off
- Record any channels from cable or an antenna (To record channels from cable or an antenna, turn off the cable box control feature.)
- Use a cable box
- Record programs with VCR Plus+

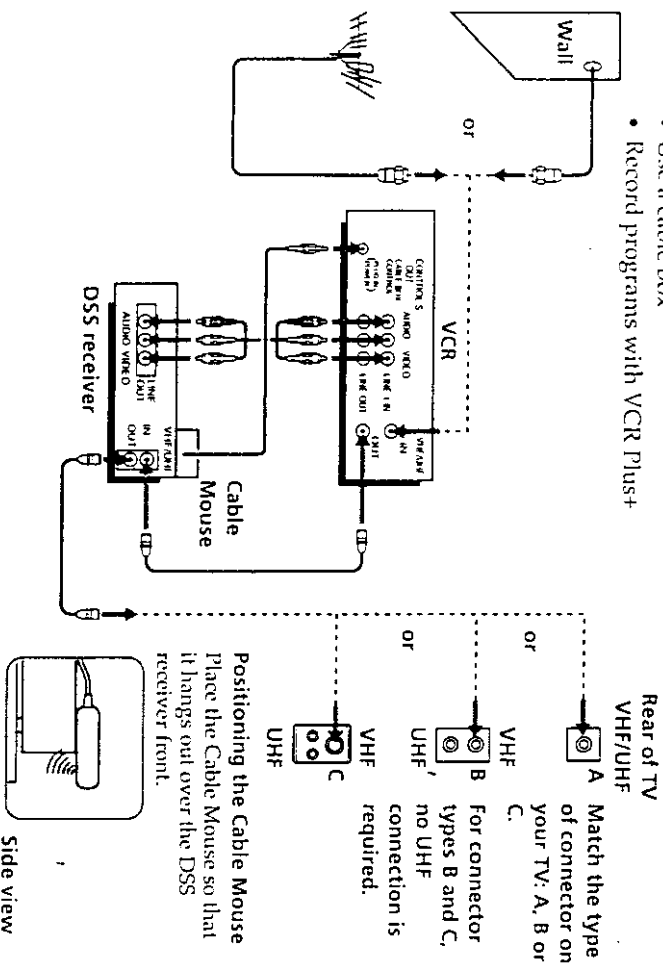

Positioning the Cable Mouse
Place the Cable Mouse so that it hangs out over the DSS receiver front.

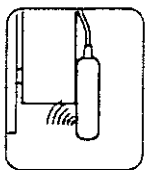

Side view

7 Press the cursor stick (OK).

8 Push the cursor stick to \uparrow/\downarrow to select a category.

Each time you push the cursor stick to \downarrow , the category changes as shown below.

- SPECIAL \rightarrow MOVIE \rightarrow NEWS \rightarrow SHOW \rightarrow
- SPORTS \rightarrow KIDS \rightarrow MUSIC \rightarrow ARTS \rightarrow
- SERIES \rightarrow EDUCATI (education) \rightarrow HOBBY \rightarrow
- SHOPPIN (shopping) \rightarrow VARIETY \rightarrow
- COMEDY \rightarrow DRAMA \rightarrow DAYTIME \rightarrow
- HOW TO \rightarrow OTHERS \rightarrow (blank)

9 Press the cursor stick (OK).

The program label and a selected category are stored.

10 Press MENU.

The menu disappears.

To erase the program label

Press CLEAR after step 4 above. The program label is erased and the recording start time and channel number reappear.

To erase the selected category

Press CLEAR in step 8 above. The selected category is erased and the screen becomes blank.

To label a regularly scheduled timer-recorded program

Once you label a program which is set to record regularly (i.e. everyday, same day of the week, etc.) in VCR Plus+ or timer recording mode, the VCR recognizes the label and will automatically label all future recordings of same program. However, if you change the program label and category several times, the VCR may automatically label only the last program of which the program label and category are changed.

contin

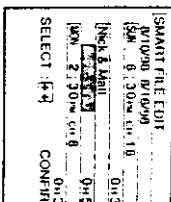
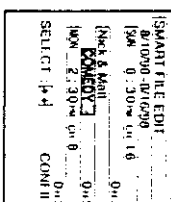

Step 3: Hookups (continued)

- The AUTO PRESET starts.

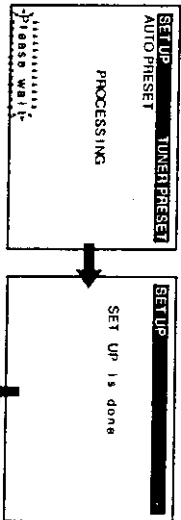

Hookup 4: VCR Plus+ channel setup

- Find the VCR Plus+ Channel Line-up Chart in your program guide. For details, see page 48.
- Enter all the channels you want to record and the cable box output channel (usually 2, 3, or 4). For details, see page 51.

- Press MENU and select SET VCR Plus+ CHANNELS.

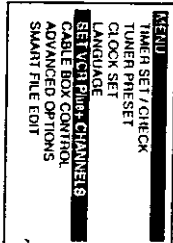

- Push the cursor stick to ←/→ to select MANUAL.

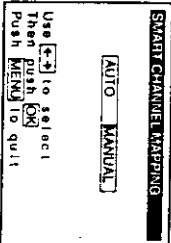

- Enter the program guide channel, then the cable box output channel.

- Press the cursor stick (OK).
- Press MENU.

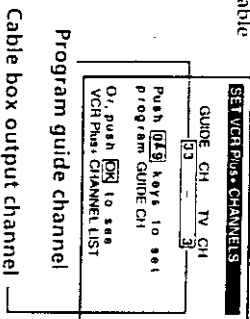

- Label the tape.

- Push the cursor stick to ↑/↓ to select a character.

Each time you push the cursor stick to ↓, the character changes as shown below.

A → B → ... → Z → symbol → 0 →
1 → ... 9 → a → b → ... → z →
(blank space)

If you make a mistake, press CLEAR.

- To set the next character, push the cursor stick to →. The cursor moves to the next position.

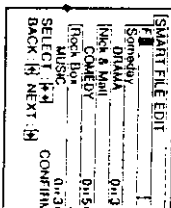
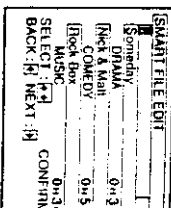

- Repeat steps 1 and 2 to label the tape.
- Press the cursor stick (OK). The tape title is stored.

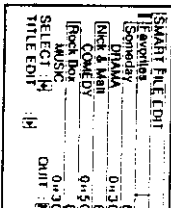

- Press MENU. The menu disappears.

To erase the tape title

Press CLEAR after step 4 above. The tape title is erased and the recording date reappears. When you want to erase the recording date from the tape title column, press CLEAR again.

Hookup 4

Pages 20 to 23

Incompatible cable box with many scrambled channels

Recommended use

Use this hookup if your cable company cannot supply a cable box that is compatible with the VCR's cable box control feature, and your cable system scrambles all or most channels.

What you can do with this hookup

- Record any channel by selecting the channel on the cable box
- What you can't do**
- Record with the cable box turned off
- Record one channel while watching another channel
- Select channels directly on the VCR

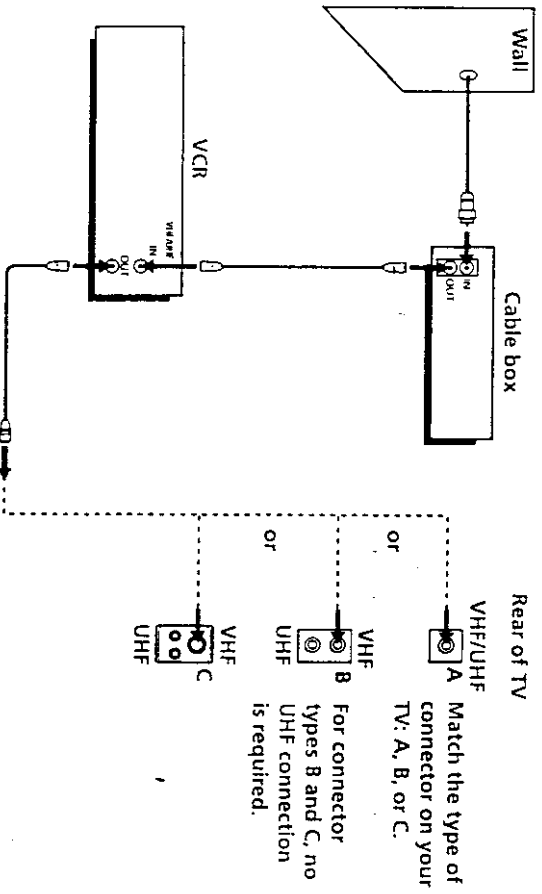

To unlock the protected program
 Push the cursor stick to ← in step 4 above. The **⏻** indicator disappears, you can record over this program.

Tips

- When you start recording from a position prior to the protected program, the recording automatically stops no more than about three minutes in SP mode and about eight minutes in EP mode before the beginning of the protected program
- If you protect a program just after the Blank Time space, BLANK TIME becomes shortened by about three minutes in SP mode and about eight minutes in EP mode
- If you try to record on a SmartFile tape containing a protected program, a message indicating that there is a protected program on this tape appears on the TV screen

Notes

- When you record another program just after a protected program, locate the beginning of the Blank Time space by following the instructions in "Recording and locating the Blank Time space" on page 91. Otherwise, if the recording start position overlaps the protected program, the VCR may over-record the protected program.
- If the VCR Plus+ or timer recording program overlaps the protected program, VCR automatically stops recording before the protected program and ejects the tape.
- If you insert a SmartFile tape which contains a protected program or protect a program for the first time on a new tape, the VCR will analyze the position of protected program for a few seconds. You cannot operate the VCR while the VCR is analyzing the tape.
- If the SmartFile list contains 12 protected programs, the next program you record won't be stored in the SmartFile list.

Step 3: Hookups (continued)

Hookup 3: VCR setup

- 1 Set the RF UNIT switch to CH3 or CH4, whichever channel is not used in your area. If both are used, set the switch to either channel. For details, see page 105. If you made A/V connections (from page 9), you can skip this step.
- 2 Press EASY SET UP on the VCR.

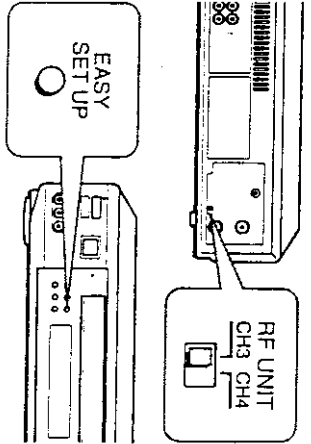

1 The LANGUAGE menu appears. Change the on-screen display language to Spanish (ESPAÑOL) or French (FRANCAIS) if desired, and press the cursor stick (OK). For details, see page 32.

2 The CLOCK SET menu appears. Select AUTO and press the cursor stick (OK). For details, see page 33.

3 The SMART CH MAPPING menu appears. Push the cursor stick to $\uparrow/\downarrow/\leftarrow/\rightarrow$ to enter the ZIP/POSTAL CODE in your area and press the cursor stick (OK). (You can also use the number buttons to enter the ZIP/POSTAL CODE.)

4 The CABLE BOX menu appears. Select OFF and press the cursor stick (OK).

5 The TUNER PRESET menu appears. Set ANTENNA/CABLE to ANT and press the cursor stick (OK). For details, see page 44.

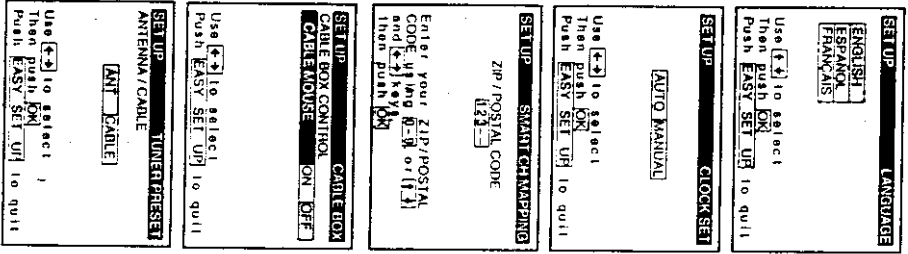

Storing program data from the DSS receiver (Program Data Download)

If you connect a DSS receiver equipped with the Program Data Download function and use the timer recording of the DSS receiver, the program a category name transmitted from the DSS are stored on the Smartfile top. The DSS receiver equipped with the Data Download function will be available in the future.

How to hook up to the DSS receiver

You should connect CPD IN of the VCR and VCR CONTROL of the DSS receiver using the supplied monaural cable.

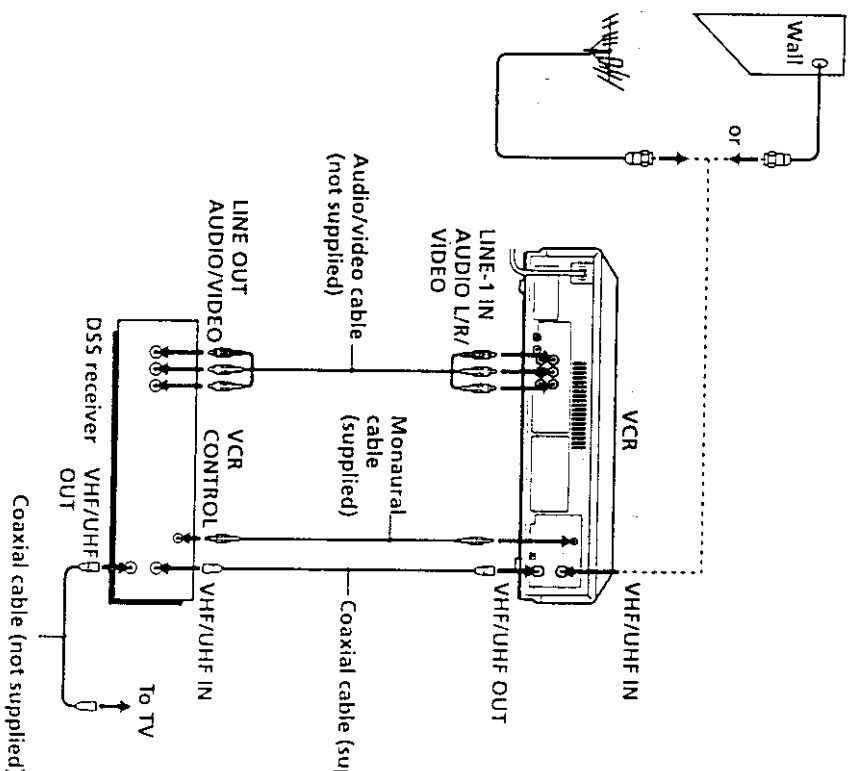

Step 3: Hookups (continued)

- 1 The AUTO PRESET starts.

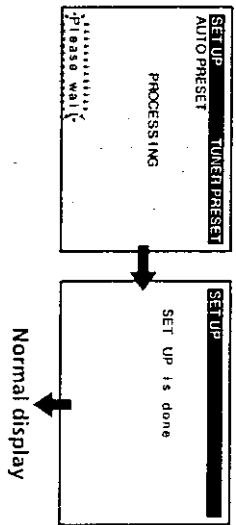

Hookup 2: VCR Plus+ channel setup

- 1 Press MENU and select SET VCR Plus+ CHANNELS.
- 2 Push the cursor stick to ←/→ to select AUTO and press the cursor stick (OK).
- 3 Press POWER to turn off the VCR.

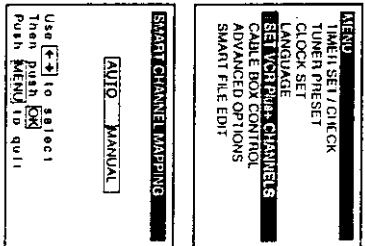

The VCR receives the program information signal from 0:00 am to 5:00 am while the VCR is turned off, and set up the channel for VCR Plus+ recording. After channel setup is finished, you can record TV programs using VCR Plus+. For details, see page 49.

Notes

- It takes about 1 hour to complete channel setup.
- The VCR can receive the program information signal only while the VCR is turned off and no timer recordings are set.
- If the channels in your area don't carry the program information signals, set the program guide channels manually. For details, see page 51.
- If the Choose your Cable CH MAP menu appears the first time you turn on the VCR after finishing channel setup, select the MAP number. For details, see page 50.

Automatic clock setting

Once you've set up the VCR, it automatically sets the clock the first time you turn off the VCR. After that whenever you turn off the VCR, it checks the time and adjusts the clock, even for Daylight Saving Time. The VCR sets the clock by picking up a time signal provided by some TV channels.

If you want to use the timer to record right away, or if the channels in your area do not carry time signals, set the clock manually. For details, see page 37.

Additional Information

General setup information

Setting the RF unit

When connecting the VCR to the TV using only the antenna cable, you must set the RF UNIT switch on the rear of the VCR so that the TV can receive the correct signal from the VCR.

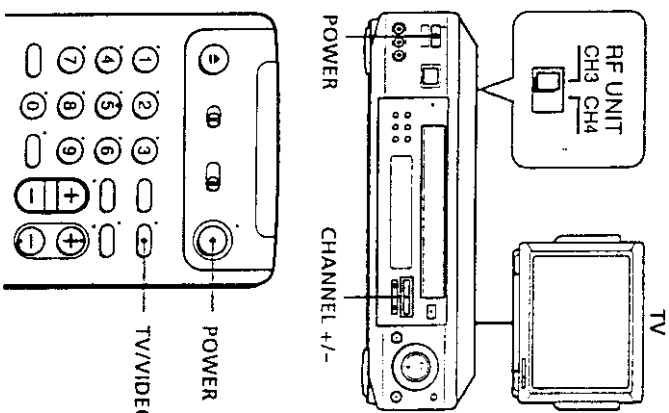

- 1 Set the RF UNIT switch on the rear of the VCR to CH 3 or CH 4, whichever channel is not used in your area. If both are used, set the switch to either channel.
- 2 Press POWER to turn on the VCR.
- 3 Press TV / VIDEO to turn on the VIDEO indicator in the display window.
- 4 Press CHANNEL +/- to display a channel number in the display window. Select an active channel number in your area.
- 5 Turn on your TV and set it to the channel you selected in step 1 (channel 3 or 4).

The selected TV channel broadcast appears on the TV screen. If the channels change when you press CHANNEL +/- on the VCR, you have made the correct setting.

Whenever you use the VCR, set the TV to the channel selected in step

Hookup 2

Pages 14 to 16

No cable box, or incompatible cable box with only a few scrambled channels

Recommended use

Use this hookup if you do not have a cable box. Also use this hookup if your cable company cannot supply a cable box that is compatible with the VCR's channels.

What you can do with this hookup

- Record any unscrambled channel by selecting the channel on the VCR
- What you can't do
- Record scrambled channels that require a cable box

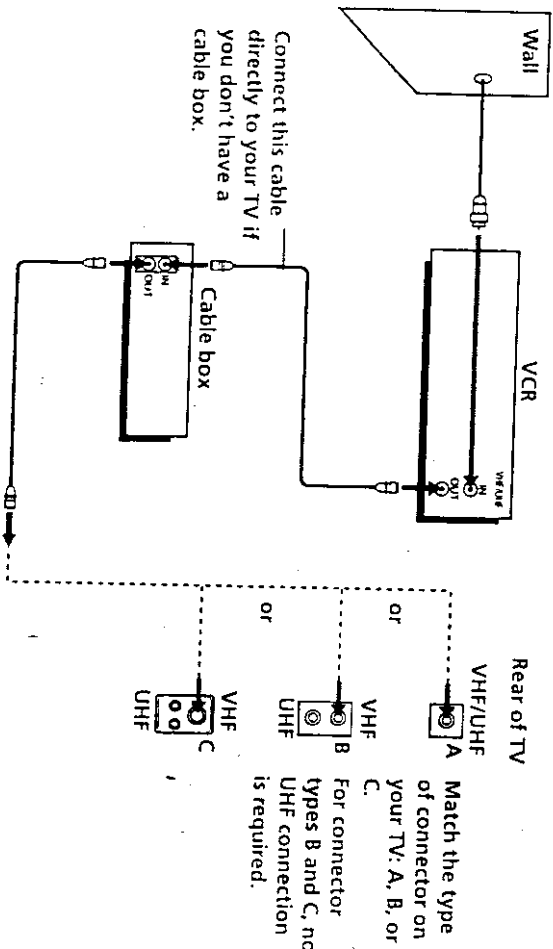

Troubleshooting

If you have any questions or problems not covered below, please consult your nearest Sony dealer.

Symptom	Remedy
The POWER switch does not function.	<ul style="list-style-type: none"> • Connect the AC power cord securely. • Make sure the VCR is not locked. To unlock, hold POWER down on the VCR until the indicator disappears.
The power is turned on but the VCR does not operate.	<ul style="list-style-type: none"> • Moisture condensation occurs: Turn the power off, unplug the AC power cord and leave the VCR to dry for over an hour.
The clock has stopped and "----" lights in the display window.	<ul style="list-style-type: none"> • The clock stops if the VCR is disconnected from the wall outlet for more than one hour. Reset the clock (and timer).
The playback picture does not appear on the TV screen.	<ul style="list-style-type: none"> • Make sure the TV is set to the channel for the VCR you are using a monitor, set it to video input.
The picture is not clear.	<ul style="list-style-type: none"> • Adjust the tracking with the TRACKING +/- buttons. • The video heads are dirty (see below). Clean the video heads using the Sony T-25CLD, T-25CLDR, or T-25CLW video head cleaning cassette. If these clean cassettes are not available in your area, have the heads cleaned at your nearest Sony dealer (a standard service charge will be required). Do not use a commercially available liquid type cleaning cassette other than Sony's, as they may damage the video heads. • The video heads may have to be replaced. Consult your local Sony dealer for more information.
The picture rolls vertically during picture search.	<ul style="list-style-type: none"> • Adjust the vertical hold control on the TV or monitor.
The picture has no sound.	<ul style="list-style-type: none"> • The tape is defective. • If you made A/V connections, check the audio cable connection.

Symptoms caused by contaminated video heads

- Normal picture
- Rough picture
- Unclear picture
- No picture (or black & white screen appears)

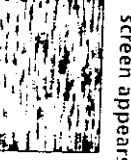

initial contamination → terminal

continue

Step 3: Hookups (continued)

Hookup 1: VCR setup

- 1 Set the RF UNIT switch to CH 3 or CH 4, whichever channel is not used in your area. If both are used, set the switch to either channel. For details, see page 105. If you made A/V connections (from page 9), you can skip this step.
- 2 Turn on your cable box.
- 3 Press EASY SET UP on the VCR.

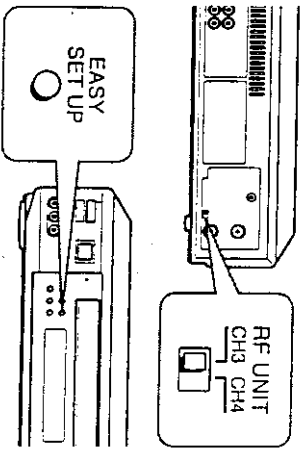

- 1 The LANGUAGE menu appears. Change the on-screen display language to Spanish (ESPAÑOL) or French (FRANÇAIS) if desired, and press the cursor stick (OK). For details, see page 32.

- 2 The CLOCK SET menu appears. Select AUTO and press the cursor stick (OK). For details, see page 33.

- 3 The SMART CH MAPPING menu appears. Push the cursor stick to $\uparrow/\downarrow/\leftarrow/\rightarrow$ to enter the ZIP/POSTAL CODE in your area and press the cursor stick (OK). (You can also use the number buttons to enter the ZIP/POSTAL CODE.)

- 4 The CABLE BOX menu appears. Select ON. For details, see page 39.

- 5 Enter your cable box code number and push the cursor stick to \downarrow . For details, see page 39.

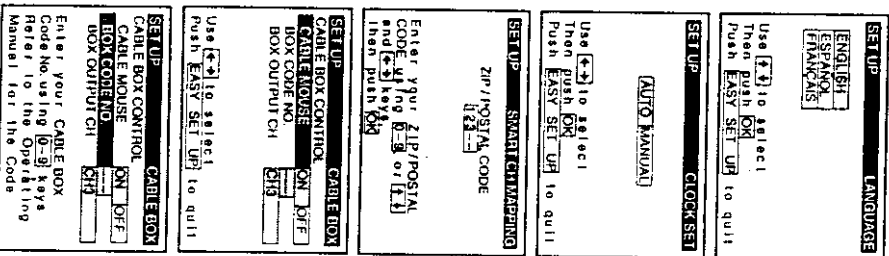

Others

Symptom	Remedy
A tape cannot be inserted.	<ul style="list-style-type: none"> • Check that a tape isn't already in the tape compartment.
The remote commander does not function.	<ul style="list-style-type: none"> • Make sure you are pointing the remote command the remote sensor on the VCR. • Replace all the batteries in the remote commander new ones if they are weak. • If you are not using S-Link™, make sure that both miniplugs are unconnected. • The command mode of the remote commander is different from the one of the VCR.
The channels on the VCR cannot be changed.	<ul style="list-style-type: none"> • Make sure the CABLE BOX CONTROL option is OFF.
The tracking meter does not appear on the screen.	<ul style="list-style-type: none"> • The recording condition of the tape is very poor or tracking cannot be adjusted.
You cannot control other TVs.	<ul style="list-style-type: none"> • Set your TV's code number. The code number reset when you replace the batteries of the remote commander.
The VCR needs to be cleaned.	<ul style="list-style-type: none"> • Clean the cabinet, panel and controls with a dry, soft cloth, or a soft cloth slightly moistened with a mild detergent solution. Do not use any type of solvent such as alcohol or benzene.

Step 3: Hookups (continued)

Use this hookup if your TV has the S-Link™ function

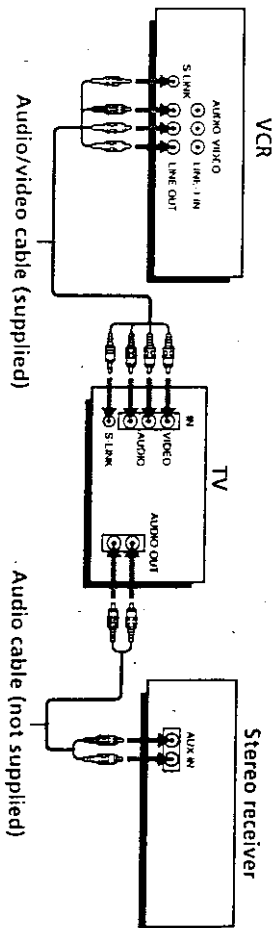

Note
To play a tape in stereo, you must use the A/V connection.

AV hookup: VCR setup

After you've connected your TV and completed antenna or cable hookup, use the following procedure to set up the VCR.

Press MENU and select
ADVANCED OPTIONS.

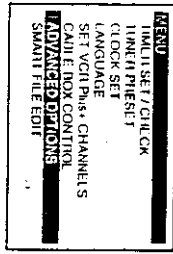

Set AUTO ANT SEL to OFF and
press the cursor stick (OK).

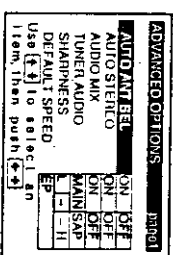

For details, see page 82.

Caution
Connections between the VCR's VHF/UHF connector and the antenna terminals of the TV receiver should be made only as shown in the following instructions. Failure to do so may result in operation that violates the regulations of the Federal Communications Commission regarding the use and operation of RF devices. Never connect the output of the VCR to an antenna or make simultaneous (parallel) antenna and VCR connections at the antenna terminals of your receiver.

Note to CATV system installer (in USA)

This reminder is provided to call the CATV system installer's attention to Article 820-40 of the NEC that provides guidelines for proper grounding and, in particular, specifies that the cable ground shall be connected to the grounding system of the building, as close to the point of cable entry as practical.

Index to parts and controls

Refer to the pages indicated in parentheses () for details.

Front panel

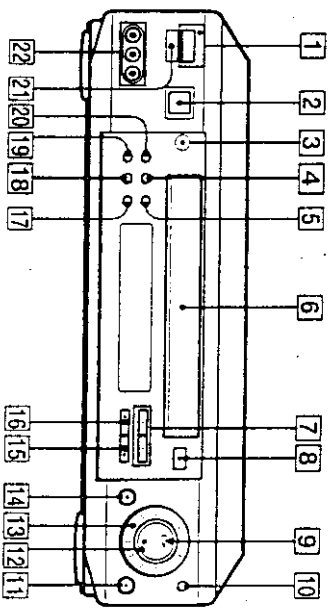

- 1 POWER switch/indicator (62, 105)
- 2 SmartFile sensor (94)
- 3 SMARTFILE indicator (89, 94)
- 4 INPUT SELECT button (56, 58, 85)
- 5 EASY SET UP button (12, 15, 18, 21, 25, 28)
- 6 Tape compartment
- 7 CHANNEL/TRACKING +/- buttons (56, 81, 105)
- 8 ▲ EJECT button (54)
- 9 ▷ PLAY button (53, 67)
- 10 JOC button/indicator (69)
- 11 ● REC (record) button (56, 85)
- 12 ■ STOP button (54, 85)
- 13 Shuttle ring (57, 68)
- 14 || PAUSE button (54, 85)
- 15 ►► FF (fast forward) button (54, 67)
- 16 ◀◀ REW (rewind) button (54, 67)
- 17 COMMAND MODE button (6)
- 18 OK button (32, 92)
- 19 CURSOR ↓ button (94)
- 20 SMARTFILE button (89)
- 21 Remote sensor (5)
- 22 LINE-2 IN VIDEO/AUDIO L/R jacks (84)

continuu

Step 3

Hookups

Selecting the best hookup option

There are many ways in which your VCR can be hooked up. To hook up your VCR so that it works best for you, first scan through the table below. Then use the accompanying diagrams and procedures on the following pages to set up your VCR.

If you have	Use	Refer to
TV that has audio/video inputs	Audio/video (A/V) hookup, then follow one of the hookups below.	Pages 9 and 10
Cable box that is compatible with the VCR's cable box control feature	Hookup 1	Pages 11 to 13
No cable box or incompatible cable box with only a few scrambled channels	Hookup 2	Pages 14 to 16
Antenna only; no cable TV	Hookup 3	Pages 17 to 19
Incompatible cable box with many scrambled channels	Hookup 4	Pages 20 to 23
DSS** receiver	Hookup 5	Pages 24 to 26
Incompatible cable box with only a few scrambled channels, using an A/B switch	Hookup 6	Pages 27 to 31

After you've completed the connections, follow the instructions for setup. During setup, if you need more details on the procedure described, page numbers are provided where you can find complete, step-by-step instructions.

After you've completed the setup, you're ready to use your VCR. Procedures differ depending on the hookup you used. For an overview, refer to "Quick reference to using the VCR" on the back cover.

Before you get started

- Turn off the power to all equipment.
- Do not connect the AC power cords until all of the connections are completed.
- Be sure you make connections firmly. Loose connections may cause picture distortion.
- If your TV doesn't match any of the examples provided, see your nearest Sony dealer or qualified technician.

* DSS** is a registered trademark of DIRECTV, Inc., a unit of Hughes Electronics Corporation.

Rear panel

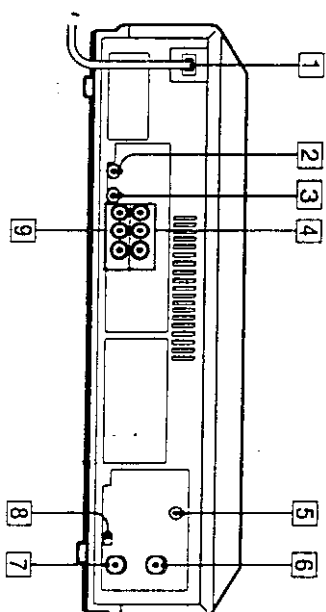

- 1 AC power cord (8)
- 2 S LINK (CONTROL S IN) jack (10, 84)
- 3 CABLE BOX CONTROL (CONTROL S OUT) jack (11, 24)
- 4 LINE-1 IN AUDIO L/R/VIDEO jacks (24, 84, 103)
- 5 CPD (Control and Program Data) IN jack (103)
- 6 VHF/UHF IN connector (11, 14, 20, 24, 27)
- 7 VHF/UHF OUT connector (11, 17, 20, 24, 27)
- 8 RF (Radio Frequency) UNIT switch (105)
- 9 LINE OUT AUDIO L/R/VIDEO jacks (9)

continuu

Step 2: Setting up the remote commander (continued)

Setting the COMMAND MODE switch

To remotely control the VCR with the remote commander, set **COMMAND MODE** on the remote commander to the same position as that on the VCR. Usually set to VTR 3. Change the position as shown below to control other Sony VCRs:

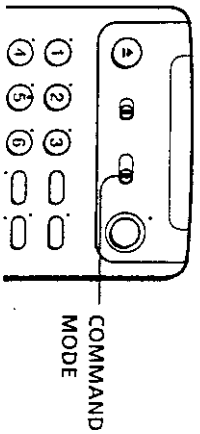

VTR 1: For Sony Betamax format VCRs

VTR 2: For Sony 8mm format VCRs

VTR 3: For Sony VHS format VCRs

To change the command mode position of the VCR, press and hold **COMMAND MODE** on the VCR for about two seconds and repeat until the desired position appears in the display window.

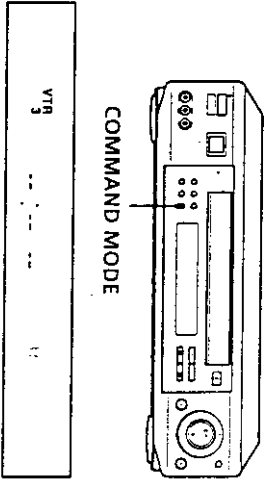

Controlling other TVs with the remote commander

The remote commander is preprogrammed to control non-Sony TVs. If your TV is listed in the table below, set the appropriate manufacturer's code number:

- 1 Set **[TV]/[VIDEO]** at the top of the remote commander to **[TV]**.
- 2 Hold **POWER** down, and enter your TV's code number(s) using the number buttons. Then release **POWER**.

Now you can use the **POWER**, **VOL +/-**, **CH +/-**, and **TV/VIDEO** buttons to control your TV. You can also use the buttons marked with a dot (•) to control a Sony TV. To control the VCR, reset **[TV]/[VIDEO]** to **[VIDEO]**.

Tip

- If you set your TV's code number correctly while the TV is turned on, the TV turns off automatically.

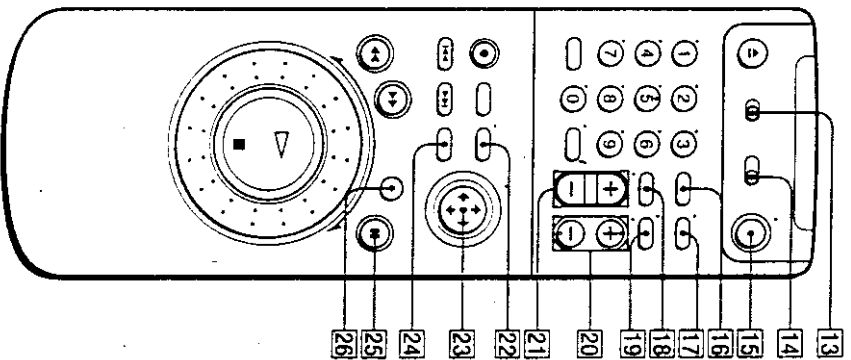

- 13 **[TV]/[VIDEO]** switch (5)
- 14 **COMMAND MODE** switch (6)
- 15 **POWER** switch (6, 62, 65, 105)
- 16 **VCR Plus+** button (61)
- 17 **TV/VIDEO** button (57, 105)
- 18 **CLEAR** button (62, 76)
- 19 **DISPLAY** button (54, 70)
- 20 **CH** (channel) **+/-** buttons (56)
- 21 **VOL** (volume) **+/-** buttons (6)
- 22 **MENU** button (32)
- 23 **Cursor stick** (32, 91)
↑/↓/←/→
OK
- 24 **SMART CUE** button (54)
- 25 **PAUSE** button (54)
- 26 **JOG** button/indicator (69)

continues

Step 1

Unpacking

Check that you have received the following items with the VCR:

- Remote commander

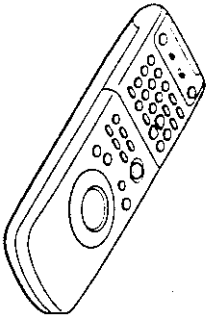

- Cable Mouse (cable box controller)

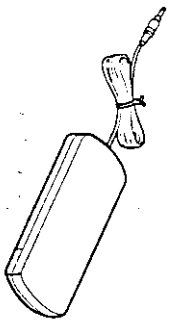

- Size AA (R6) batteries



- 75-ohm coaxial cable with F-type connectors

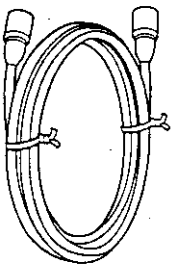

- Audio/video cable (3-phonos, 1-mini to 3-phonos, 1-mini)

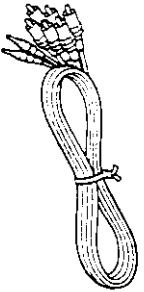

- Jack cover



- Monaural cable (1-mini to 1-mini)

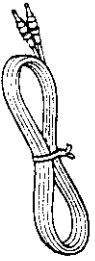

- Smartfile labels

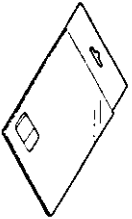

Index

A, B

- Accessories supplied 4
- Adjusting
 - picture 81
 - tracking 81
- AFT (Auto Fine Tuning) 47
- Antenna hookup 17
- APC (Adaptive Picture Control) 81
- Audio track 79
- Audio/video (A/V) hookup 9
- Auto Clock Set feature 33
- Auto Tape Speed 83

C

- Cable Box Control
 - cable box code number chart 40
 - setting 39
- Cable hookup 11
- Cable Mouse 39
- Canceling timer settings 76
- Changing timer settings 76
- Channel Line-up Chart 48
- Checking timer settings 76
- Child Lock 63
- Cleaning the video heads 107
- Clock setting 33
- Connecting
 - cable TV 11
 - external antenna connector 106
 - UHF/VHF band mixer 106
- Counter 54

D

- Disabling channels 46
- DSS (Digital Satellite System) 24
- Dubbing. See Editing.

E, F, G

- Easy Set Up 12, 15, 18, 21, 25, 28
- Editing 84
- EP mode 56

H

- Hi-Fi audio track 79

I, J, K

- Index searching 80

L

- Language selecting 32
- Locking the VCR 63
- L1 mode 58, 69

M

- Monitoring audio during playback 78

N, O

- Normal audio track 79

P

- Picture adjustment. See Adjusting.
- Playback 53
 - at various speeds 67
 - frame-by-frame 69
 - skip 54
 - slow motion 67, 68
- Presetting channels 44

Q

- Quick timer 75

R

- Recording 55
 - bilingual programs 78
 - SAP broadcasts 78
 - saving 57
 - stereo broadcasts 78
 - using VCR Plus+ 61
 - while watching another program 57

S

- Safety tab 57
- SAP (Second Audio Program) 78
- Searching
 - at various speeds 67
 - for a selected point skip-search 72
- S-Link™ 10, 84
- Smartfile 86
 - checking the content a tape 94
 - erasing the data of an unwanted program
 - labeling a recorded program and tape 5
 - protecting a recorded program 100
 - recording 89
 - selecting 93
- Smartfile label 4, 88
- storing program data from the DSS receiver 103
- SP mode 56

T, U

- Timer recording 64
 - canceling timer settings 76
 - changing timer settings 76
 - checking timer settings 76
 - daily/weekly recording 66
 - overlapping timer recordings 77
 - using VCR Plus+ 61
- Tracking adjustment. See Adjusting.

V, W, X, Y, Z

- VCR Plus+
 - channel setup 48
 - recording 61

WARNING

To prevent fire or shock hazard, do not expose the unit to rain or moisture.

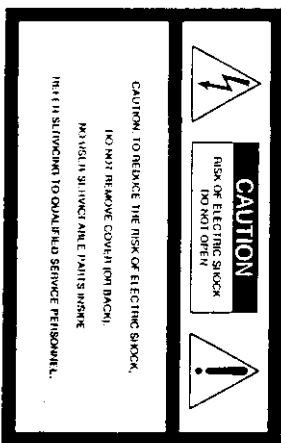

This symbol is intended to alert the user to the presence of uninsulated "dangerous voltage" within the product's enclosure that may be of sufficient magnitude to constitute a risk of electric shock to persons.

This symbol is intended to alert the user to the presence of important operating and maintenance (servicing) instructions in the literature accompanying the appliance.

CAUTION

To prevent electric shock, do not use this polarized AC plug with an extension cord, receptacle or other outlet unless the blades can be fully inserted to prevent blade exposure.

WARNING

The AC power cord must be changed at qualified service shop.

Precautions

Safety

- Operate the unit only on 120 V AC, 60 Hz.
- If anything falls into the cabinet, unplug the unit and have it checked by qualified personnel before operating it any further.
- This unit is not disconnected from the AC power source (mains) as long as it is connected to the wall outlet, even if the unit itself has been turned off.
- One blade of the plug is wider than the other for the purpose of safety and will fit into the power outlet only one way. If you are unable to insert the plug fully into the outlet, contact your Sony dealer.
- Unplug the unit from the wall outlet if you do not intend to use it for an extended period of time. To disconnect the cord, pull it out by the plug, never by the cord.

Installing

- Allow adequate air circulation to prevent internal heat buildup.
- Do not place the unit on surfaces (rugs, blankets, etc.) or near materials (curtains, draperies) that may block the ventilation slots.

- Do not install the unit near heat sources such as radiators or air ducts, or in a place subject to direct sunlight, excessive dust, mechanical vibration or shock.
- Do not install the unit in an inclined position. It is designed to be operated in a horizontal position only.

- Keep the unit and cassettes away from equipment with strong magnets, such as microwave ovens or large loudspeakers.
- Do not place heavy objects on the unit.
- If the unit is brought directly from a cold to a warm location, moisture may condense inside the VCR and cause damage to the video head and tape. When you first install the unit, or when you move it from a cold to a warm location, wait for about one hour before operating the unit.

Information

For customers in the USA

You are cautioned that any changes or modifications not expressly approved in this manual could void your authority to operate this equipment.

This equipment has been tested and found to comply with the limits for a Class B digital device, pursuant to Part 15 of the FCC Rules. These limits are designed to provide reasonable protection against harmful interference in a residential installation. This equipment generates, uses, and can radiate radio frequency energy and, if not installed and used in accordance with the instructions, may cause harmful interference to radio communications. However, there is no guarantee that interference will not occur in a particular installation. If this equipment does cause harmful interference to radio or television reception, which can be determined by turning the equipment off and on, the user is encouraged to try to correct the interference by one or more of the following measures:

- Reorient or relocate the receiving antenna.
- Increase the separation between the equipment and receiver.
- Connect the equipment into an outlet on a circuit different from that to which the receiver is connected.
- Consult the dealer or an experienced radio/TV technician for help.

For customers in Canada

Operation is subject to the following two conditions: (1) this VCR may not cause interference, and (2) this VCR must accept any interference, including interference that may cause undesired operation of the VCR.

Caution

Television programs, films, video tapes and other materials may be copyrighted. Unauthorized recording of such material may be contrary to the provisions of the copyright laws. Also, use of this recorder with cable television transmission may require authorization from the cable television transmission and/or program owner.

Quick reference to using the VCR

SONY

3-861-57

Hookup 1

To play a tape

- 1 Set the TV to channel 3 or 4 (or to video input, if you made A/V connections.)
- 2 Insert a tape and press **▶ PLAY**.

To record a program

- 1 Turn on the cable box.
- 2 Press **VCR Plus+** on the remote commander.
- 3 Enter the program's PlusCode number.
- 4 Select **ONCE, DAILY, or WEEKLY**, then press **SET**.
- 5 Insert a tape.
- 6 Press **POWER** to turn off the VCR.
- 7 Leave the cable box on.

To watch TV

- 1 Turn off your VCR, or press the VCR's TV/VIDEO button until the VIDEO indicator in the display window goes off.
- 2 Turn on your cable box.
- 3 Set the TV to the cable box output channel (usually 2, 3, or 4).
- 4 Set the cable box to the channel you want to watch.

Hookup 2

To play a tape

- 1 If you made A/V connections, set the TV to video input.
- If you didn't use A/V hookup:
- Turn on the cable box.
 - Set the cable box to channel 3 or 4.
 - Set the TV to the output channel of the cable box (usually 2, 3, or 4).
- 2 Insert a tape and press **▶ PLAY**.

Hookup 3

To record a program

- 1 Press **VCR Plus+** on the remote commander.
- 2 Enter the program's PlusCode number.
- 3 Select **ONCE, DAILY, or WEEKLY**, then press **SET**.
- 4 Insert a tape.
- 5 Press **POWER** to turn off the VCR.

To watch TV

- 1 Turn off your VCR, or press the VCR's TV/VIDEO button until the VIDEO indicator in the display window goes off.
- 2 Select the channel with your cable box (if you have one) or with your TV.

To play a tape

- 1 Set the TV to channel 3 or 4 (or to video input, if you made A/V connections.)
- 2 Insert a tape and press **▶ PLAY**. If there's no picture on your TV, press the VCR's TV/VIDEO button until the VIDEO indicator comes on in the display window.

To record a program

- 1 Press **VCR Plus+** on the remote commander.
- 2 Enter the program's PlusCode number.
- 3 Select **ONCE, DAILY, or WEEKLY**, then press **SET**.
- 4 Insert a tape.
- 5 Press **POWER** to turn off the VCR.

To watch TV

- 1 Turn off your VCR, or press the VCR's TV/VIDEO button until the VIDEO indicator in the display window goes off.
- 2 Set the TV to the channel you want to watch.

Hookup 4

To play a tape

- 1 Set the TV to channel 3 or 4 (or to video input, if you made A/V connections.)
- 2 Insert a tape and press **▶ PLAY**.

To record a program

- 1 Turn on the cable box.
- 2 Set the cable box to the channel you want to record.
- 3 Press **VCR Plus+** on the remote commander.
- 4 Enter the program's PlusCode number.
- 5 Select **ONCE, DAILY, or WEEKLY**, then press **SET**.
- 6 Insert a tape.
- 7 Press **POWER** to turn off the VCR.
- 8 Leave the cable box on.

To watch TV

- 1 Turn off your VCR, or press the VCR's TV/VIDEO button until the VIDEO indicator in the display window goes off.
- 2 Turn on your cable box.
- 3 Set the TV to the cable box output channel (usually 2, 3, or 4).
- 4 Set the cable box to the channel you want to watch.

To order additional SmartFile Labels

Please call 1-888-293-9885. Cost is \$9.95 for a package of 5 labels.

If you have any questions about this product, you may call:

Sony Customer Information Center 1-800-222-SONY (7669) or write to: **Sony Customer Information Center** Sony Drive, Mail Drop #T1-11, Park Ridge, NJ 07656

Sony Corporation Printed in Malaysia

Video Cassette Recorder

Operating Instructions

Owner's record

The model and serial numbers are located at the rear of the unit. Record these numbers in the spaces provided below. Refer to them whenever you call upon your Sony dealer regarding this product.

Model No. _____

Serial No. _____



SLV-M10HF

©1998 by Sony Corporation

Table of contents

Getting Started

- 4 Step 1: Unpacking
- 5 Step 2: Setting up the remote commander
- 8 Step 3: Hookups
- 32 Selecting a language
- 33 Setting the clock
- 39 Setting up cable box control
- 44 Presetting channels
- 48 Setting up VCR Plus+*

Basic Operations

- 53 Playing a tape
- 55 Recording TV programs
- 59 Locating a channel by station ID
- 61 Recording TV programs using VCR Plus+
- 64 Setting the timer manually

Additional Operations

- 67 Playing/searching at various speeds
- 70 Searching for a selected point on the tape
- 72 Skip-searching automatically
- 73 Creating a favorite channel list with station IDs
- 75 Recording TV programs using the quick timer
- 76 Checking/changing/canceling timer settings
- 78 Recording stereo and bilingual programs
- 80 Searching using the index function
- 81 Adjusting the picture
- 82 Changing menu options
- 84 Editing with another VCR

SmartFile function

- 86 About the SmartFile function
- 88 Recording using the SmartFile function
- 93 Selecting and playing a program
- 94 Checking the contents of a tape
- 95 Labelling a recorded program and tape
- 100 Protecting a recorded program
- 102 Erasing the data of an unwanted program
- 103 Storing program data from the DSS receiver (Program Data Download)

Additional Information

- 105 General setup information
- 107 Troubleshooting
- 110 Specifications
- 111 Index to parts and controls
- 117 Index
- back cover
- Quick reference to using the VCR

* VCR Plus+ and PlusCode are trademarks of Genstar Development Corporation. VCR Plus+ system is manufactured under license from Genstar Development Corporation.

Remote commander, with top cover opened

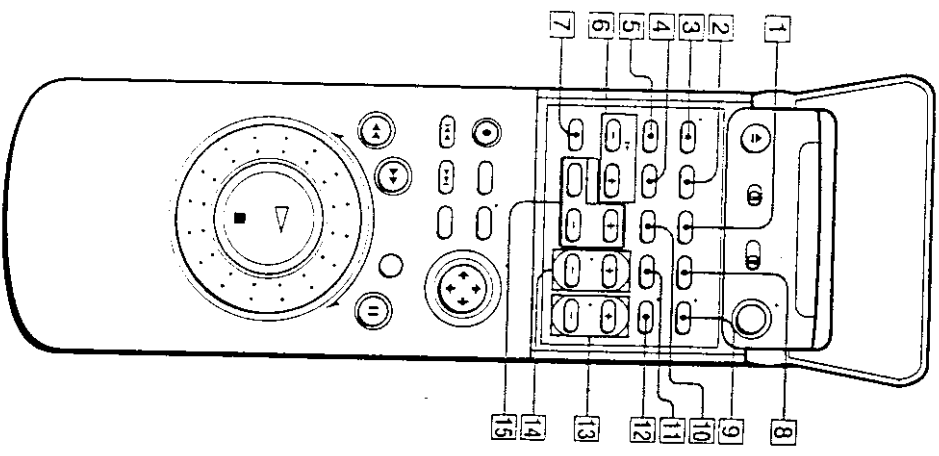

- 1 SP (Standard Play)/EP (Extra Play) button (56)
- 2 TAPE RETURN button (68)
- 3 AUDIO MONITOR button (78)
- 4 COUNTER RESET button (54)
- 5 QUICK TIMER button (75)
- 6 SLOW +/- buttons (67)
- 7 x2 button (67)
- 8 INPUT SELECT button (56, 58, 85)
- 9 TV/VIDEO button (57, 105)
- 10 COUNTER/REMAIN button (57)
- 11 CLEAR button (62, 76)
- 12 DISPLAY button (54, 70)
- 13 CH (channel) +/- buttons (56)
- 14 VOL (volume) +/- buttons (6)
- 15 Receiver operation buttons RECEIVER VOL (volume) +/- buttons (5) and MUTING button (5)

Step 2

Setting up the remote commander

Inserting the batteries

Insert two size AA (R6) batteries by matching the + and - on the batteries to the diagram inside the battery compartment.

Insert the negative (-) end first, then push in and down until the positive (+) end clicks into position.

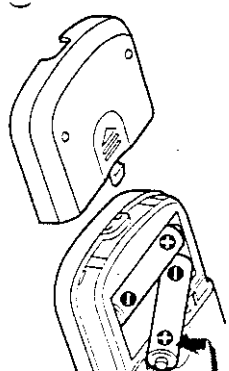

Using the remote commander

You can use this remote commander to operate this VCR and a Sony TV or AV receiver.

Buttons on the remote commander marked with a dot (•) can be used to operate your Sony TV.

The RECEIVER VOL +/- and MUTING buttons can be used to operate your Sony AV receiver.

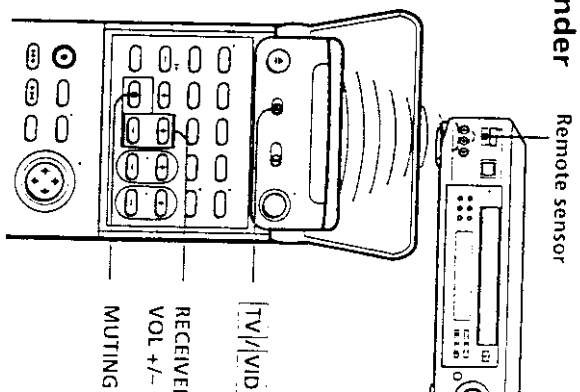

To operate	Set [TV]/[VIDEO] to
the VCR	[VIDEO] and point at the remote sensor on the VCR
a Sony TV	[TV] and point at the remote sensor on the TV

Notes

- With normal use, the batteries should last about three to six months.
- If you do not use the remote commander for an extended period of time, remove the batteries to avoid possible damage from battery leakage.
- Do not use a new battery with an old one.
- Do not use different types of batteries.
- Some Sony AV receivers may not be operated with the remote commander.

continue

Index to parts and controls (continued)

Remote commander

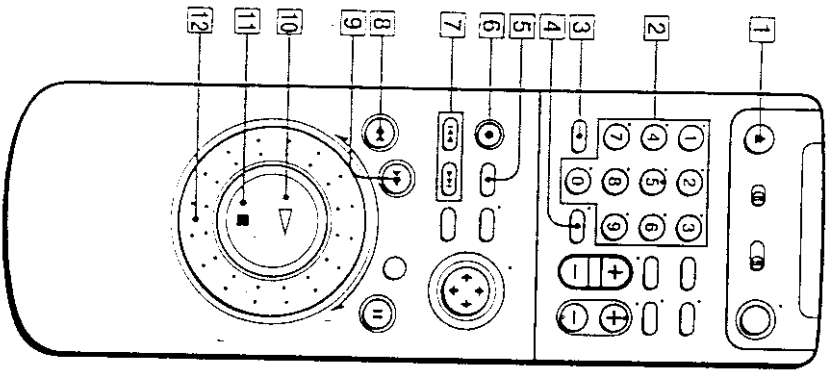

- 1 ▲ EJECT button (54)
- 2 Number buttons (46, 51)
- 3 SET button (62, 73)
- 4 ENTER button (46, 51)
- 5 SMARTFILE button (89, 100)
- 6 ● REC (record) button (56)
- 7 ◀▶▶ / ▶▶▶ INDEX SEARCH buttons (80)
- 8 ◀◀◀ REW (rewind) button (54, 67)
- 9 ▶▶▶ FF (fast forward) button (54, 67)
- 10 ▷ PLAY button (53)
- 11 ■ STOP button (54)
- 12 Shuttle ring (57, 68)

Code numbers of controllable TVs

If more than one code number is listed, try entering them one at a time until you find the one that works with your TV.

Manufacturer	Code number	Manufacturer	Code number	Manufacturer	Code number
Sony	01	JVC	09	RCA	04, 10
Akai	04	KMC	03	Sampo	12
AOC	04	Magnavox	03, 08, 12	Sanyo	11
Centurion	12	Marantz	04, 13	Scott	12
Coronado	03	MCA/Mitsubishi	04, 12, 13, 17	Sears	07, 10
Curtis-Mathes	12	NEC	04, 12	Sharp	03, 05
Daytron	12	Panasonic	06, 19	Sylvania	08, 12
Emerson	03, 04, 14	Philco	03, 04	Teknika	03, 08
Fisher	11	Philips	08	Toshiba	07
General Electric	06, 10	Pioneer	16	Wards	03, 04
Gold Star	03, 04, 17	Portland	03	Yorx	12
Hitachi	02, 03	Quasar	06, 18	Zenith	15
J.C.Penny	04, 12	Radio Shack	05, 14		

Notes

- If the TV uses a different remote control system from the one programmed to work with the VCR, you cannot control your TV with the remote commander.
- If you enter a new code number, the code number previously entered will be erased.
- When you replace the batteries of the remote commander, the code number may automatically reset to 01 (Sony). If your TV is not a Sony, it is recommended to manually set the appropriate code number every time you replace the batteries.

Display window

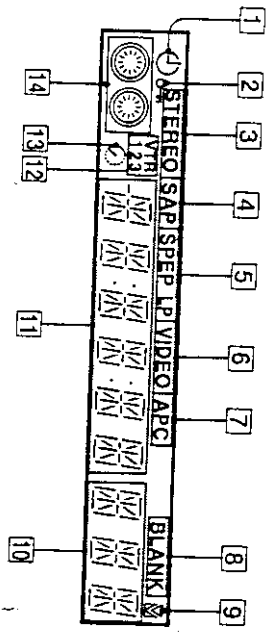

- 1 Timer indicator (62)
- 2 Child Lock indicator (63)
- 3 STEREO indicator (78)
- 4 SAP (Second Audio Program) indicator (78)
- 5 Tape speed indicator (56)
- 6 VIDEO indicator (57, 105)
- 7 APC (Adaptive Picture Control) indicator (81)
- 8 BLANK indicator (91)
- 9 Tracking indicator (81)
- 10 Line/channel indicator (56, 85)
- 11 Time counter/clock (54)
- 12 Command mode indicator (6)
- 13 Remaining time indicator (57)
- 14 Tape/recording indicator (56)

Audio/video (A/V) hookup

If your TV has audio/video (A/V) input jacks, you will get a better picture and sound if you hook up your VCR using these connections. In addition to a true "home theater" experience, you should connect the audio outputs of your VCR or TV to your stereo system. If your TV doesn't have A/V inputs, see the following pages for antenna or cable hookups.

If your TV has the S-Link™ (A/V bus control) function, hook up your VCR using the connection shown on page 10. Your TV will automatically switch to the A/V inputs for your VCR when you play back or operate menu on VCR.

If you're not planning to use your VCR to record programs, you're finished setting up the VCR after you've made the connections shown on pages 9 and 10. If you want to record off-air or off your cable TV system, complete the connections first, and then go to the following pages for antenna or cable hookups.

* S-Link™ is a trademark of Sony Corporation.

A Use this hookup if your TV has stereo jacks

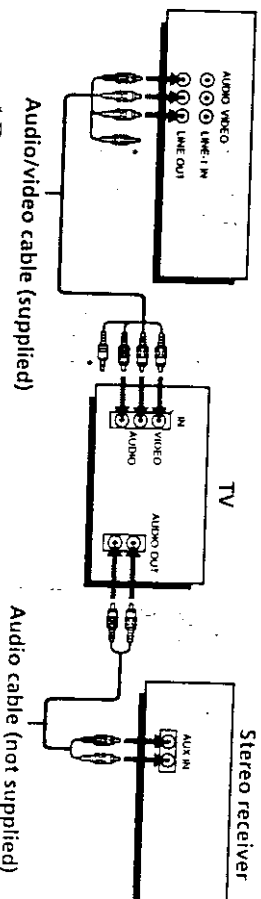

* Do not connect the miniplugs for this hookup.

B Use this hookup if your TV doesn't have stereo jacks

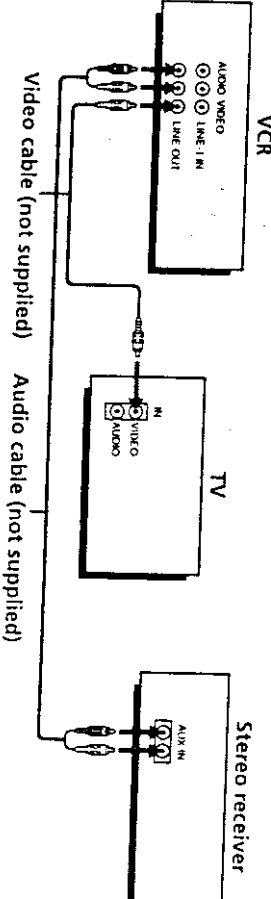

Specifications

System

- Format: VHS NTSC standard
- Video recording system: Rotary head helical scanning, FM system
- Video heads: Double azimuth four heads
- Video signal: NTSC color, EIA standards
- Tape speed: SFI: 33.35 mm/s (1 1/8 inches/s)
- EP: 11.11 mm/s (7/16 inches/s)
- LP: 16.67 mm/s (1 1/8 inches/s), playback only

- Maximum recording/playback time: 8 hrs. in EP mode (with T-160 tape)
- Fast-forward and rewind time: Approx. 3 min. (with T-120 tape)

Tuner section

- Channel coverage: VHF 2 to 13, UHF 14 to 69
- CAV: A-8 to A-1, A to W, W+1 to W+84
- Antenna: 75-ohm antenna terminal for VHF/UHF

Inputs and outputs

- LINE IN and 2-LINE VIDEO IN, phono jack (1 each)
- Input signal: 1 Vp-p, 75 ohms, unbalanced, sync negative
- AUDIO IN, phono jack (2 each)
- Input level: 327 mVrms
- Input impedance: more than 47 kilohms
- LINE OUT: VIDEO OUT, phono jack (1)
- Output signal: 1 Vp-p, 75 ohms, unbalanced, sync negative
- AUDIO OUT, phono jack (2)
- Standard output: 327 mVrms
- Load impedance: 47 kilohms
- Output impedance: less than 10 kilohms
- S-LINK (CONTROL, S-IN) Mini jack (1)
- CABLE BOX CONTROL (CONTROL, S-OUT) Stereo mini jack (plug in power) (1)
- CPD IN Mini jack (1)

Timer section

- Clock: Quartz locked
- Timer indication: 12-hour cycle
- Timer setting: 8 programs per month (max.)
- Power back-up: Built-in self-charging capacitor
- Back-up duration: up to 1 hour at a time

General

- Power requirements: 120 V AC, 60 Hz
- Power consumption: 24 W
- Operating temperature: 5 °C to 40 °C (41 °F to 104 °F)
- Storage temperature: -20 °C to 60 °C (-4 °F to 140 °F)
- Dimensions: Approx. 430 x 107 x 287 mm (w/h/d)
- Approx. (17 x 4 1/4 x 11 1/8 inches) including protruding parts and controls
- Mass: Approx. 4.5 kg (9 lb 15 oz)

Supplied accessories

- Remote commander (1)
 - Size AA (R6) batteries (2)
 - 75-ohm coaxial cable with F-type connectors (1)
 - Audio/video cable (3-phonos, 1-mini to 3-phonos, 1-mini) (1)
 - Monaural cable (1-mini to 1-mini) (1)
 - Cable Mouse (cable box controller) (1)
 - Jack cover (1)
 - SmartFile labels (5)
- Design and specifications are subject to change without notice.

Hookup 1

Using cable box control

Recommended use
You should use this hookup if you have a cable box, especially if your cable system scrambles all or most channels. This hookup allows the VCR's cable box control feature to control the channel on the cable box, simplifying the recording process. A list of compatible cable boxes is on pages 40 and 41.

What you can do with this hookup

- Record any channel using the VCR's cable box control feature to select channels on the cable box
- What you can't do
 - Record with the cable box turned off
 - Record one channel while watching another channel

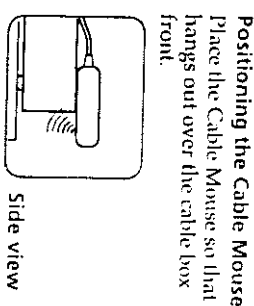
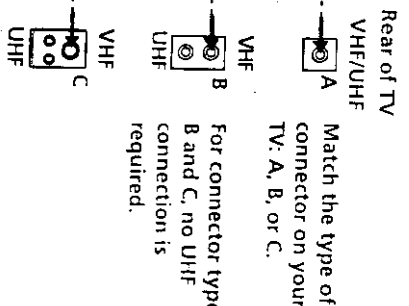
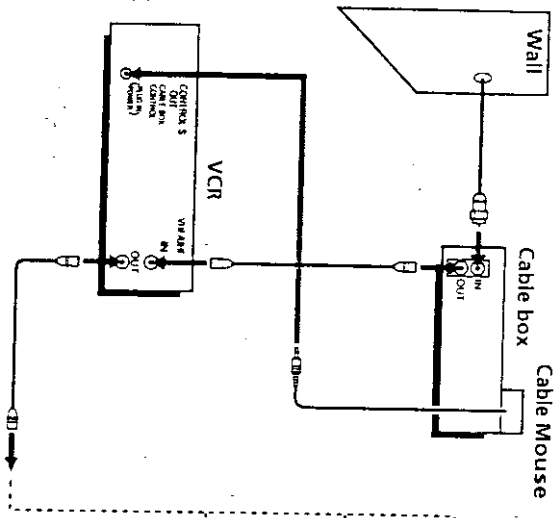

Side view

continue

Troubleshooting (continued)

Symptom	Remedy
A TV program does not appear on the TV screen.	<ul style="list-style-type: none"> Make sure the TV is set to the channel for the VCR. If you are using a monitor, set it to video input.
TV reception is poor.	<ul style="list-style-type: none"> Adjust the TV antenna.
The tape starts playing as soon as it is inserted.	<ul style="list-style-type: none"> The safety tab has been removed. To record on this tape, cover the tab hole.
The tape is ejected when you press ● REC.	<ul style="list-style-type: none"> Check that the safety tab has not been removed.
Nothing happens when you press ● R/C.	<ul style="list-style-type: none"> Make sure the tape is not at its end. Select the correct source with the INPUT SELECT button. Select a channel number when recording TV programs; select "L1" or "L2" when recording from other equipment. The current position of the tape is record protected. Search for the recording available space.
Recording stops halfway.	<ul style="list-style-type: none"> If the tape contains a protected program, recording automatically stops before the protected program. Use another tape which has enough recording space.
The timer does not operate.	<ul style="list-style-type: none"> Check that the clock is set. Make sure a tape has been inserted. Check that the safety tab has not been removed. Make sure the tape is not at its end. The recording start point overlaps the protected program. Make sure a program has been set for timer recording. Make sure your timer settings have not already passed the current time. Check that the cable box is turned on. The clock stops if the VCR is disconnected from the wall outlet for more than one hour. Reset the clock and timer. When you use cable box control, make sure the CABLE BOX CONTROL option is set to ON.

Timer recording

Recording

Hookup 1: VCR Plus+ channel setup

- Press MENU and select SET VCR Plus+ CHANNELS.
- Push the cursor stick to \leftarrow / \rightarrow to select AUTO and press the cursor stick (OK).
- Press POWER to turn off the VCR.

③ Select your cable box output channel and press the cursor stick (OK).

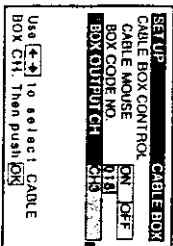

Normal display

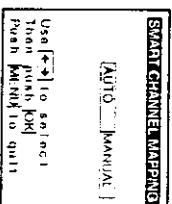
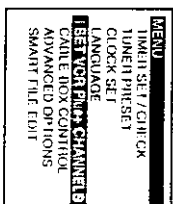

The VCR receives the program information signal from 6:00 am to 5:00 am while the VCR is turned off, and set up the channel for VCR Plus+ recording. After channel setup is finished, you can record TV programs using VCR Plus+. For details, see page 49.

Notes

- To use auto VCR Plus+ channel setup feature, leave the cable box on.
- It takes about 1 hour to complete channel setup.
- The VCR can receive the program information signal only while the VCR is turned off and no timer recordings are set.
- If the channels in your area don't carry the program information signals, set the program guide channels manually. For details, see page 51.
- If the Choose your Cable CH MAP menu appears the first time you turn on the VCR after finishing channel setup, select the MAP number. For details, see page 37.

Automatic clock setting

Once you've set up the VCR, it automatically sets the clock the first time you turn off the VCR. After that, whenever you turn off the VCR, it checks the time and adjusts the clock, even for Daylight Saving Time. The VCR sets the clock by picking up a time signal provided by some TV channels.

If you want to use the timer to record right away, or if the channels in your area do not carry time signals, set the clock manually. For details, see page 37.

Note

- To use the Auto Clock Set feature, leave the cable box on.

Attaching the external antenna connector

When using a 300-ohm twin lead cable for VHF/UHF antenna, use the EAC-32 antenna connector (not supplied) to connect the antenna to the VCR.

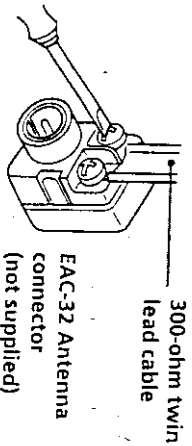

- 1 Loosen the screws on the antenna connector.
- 2 Wind the twin leads around the screws on the antenna connector.
- 3 Retighten the screws.

Attaching a UHF/VHF band mixer

When using both 75-ohm coaxial cable and 300-ohm twin lead cable for VHF/UHF antenna, use the EAC-66 UHF/VHF band separator/mixer (not supplied) to connect the antenna to the VCR.

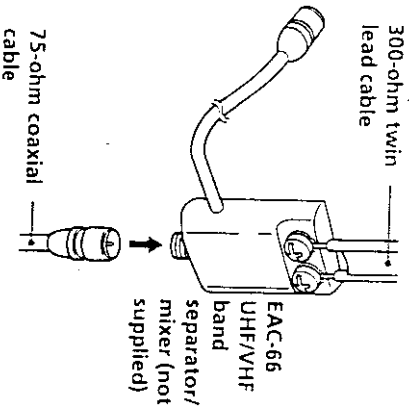

- 1 Loosen the screws on the mixer.
- 2 Wind the twin leads around the screws on the mixer.
- 3 Retighten the screws.
- 4 Connect the 75-ohm coaxial cable to the mixer.

Hookup 2: VCR setup

- 1 Set the RF UNIT switch to CH 3 or CH 4, whichever channel is not used in your area. If both are used, set the switch to either channel. For details, see page 105. If you made A/V connections (from page 9), you can skip this step.
- 2 Press EASY SET UP on the VCR.

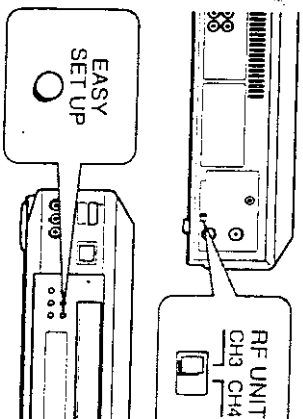

- 3 The LANGUAGE menu appears. Change the on-screen display language to Spanish (ESPAÑOL) or French (FRANÇAIS) if desired, and press the cursor stick (OK). For details, see page 32.

- 4 The CLOCK SET menu appears. Select AUTO and press the cursor stick (OK). For details, see page 33.

- 5 The SMART CH MAPPING menu appears. Push the cursor stick to $\uparrow/\downarrow/\leftarrow/\rightarrow$ to enter the ZIP/POSTAL CODE in your area and press the cursor stick (OK). (You can also use the number buttons to enter the ZIP/POSTAL CODE.)

- 6 The CABLE BOX menu appears. Select OFF and press the cursor stick (OK).

- 7 The TUNER PRESET menu appears. Set ANTENNA/CABLE to CABLE and press the cursor stick (OK). For details, see page 44.

SET UP LANGUAGE
 ENGLISH
 ESPAÑOL
 FRANÇAIS

Use \leftarrow/\rightarrow to select. Then push OK. Push EASY SET UP to quit.

SET UP CLOCK SET
 [AUTO/MANUAL]

Use \leftarrow/\rightarrow to select. Then push OK. Push EASY SET UP to quit.

SET UP SMART CH MAPPING
 ZIP/POSTAL CODE
 [1-9]

Enter your ZIP/POSTAL CODE, using 0-9 or \leftarrow/\rightarrow and \leftarrow/\rightarrow keys. Then push OK.

SET UP CABLE BOX CONTROL
 CABLE MODE [ON/OFF]

Use \leftarrow/\rightarrow to select. Push EASY SET UP to quit.

SET UP TUNER PRESET
 ANTENNA/CABLE
 [ANT/ENGL]

Use \leftarrow/\rightarrow to select. Then push OK. Push EASY SET UP to quit.

continued

Setting up the DSS receiver

You have to set the VCR brand number on the DSS receiver. For example, select "99" in the VCR CONTROL menu to use a Sony VCR with the SmartFile function. For details, refer to the instruction manual of your DSS receiver.

Storing program data on the SmartFile tape

When you record a DSS program using the DSS receiver's timer, the program and category name are automatically stored on the SmartFile tape.

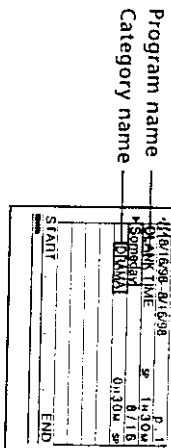

Notes

- Do not operate the VCR, the DSS receiver and any other equipment connected to these units for at least two minutes after timer recording starts. If you operate these equipment immediately after timer recording starts, the correct program data may not be sent from the DSS receiver.
- When you use the VCR's timer for recording, program data from the DSS receiver is not stored on the SmartFile tape.

Antenna hookup

Make the following connections if you're using an antenna (if you don't have cable TV).

A Use this hookup if you're using:

- VHF/UHF antenna (you get channels 2-13 and channels 14 and higher)
- UHF-only antenna (you get channels 14 and higher)
- Separate VHF and UHF antennas

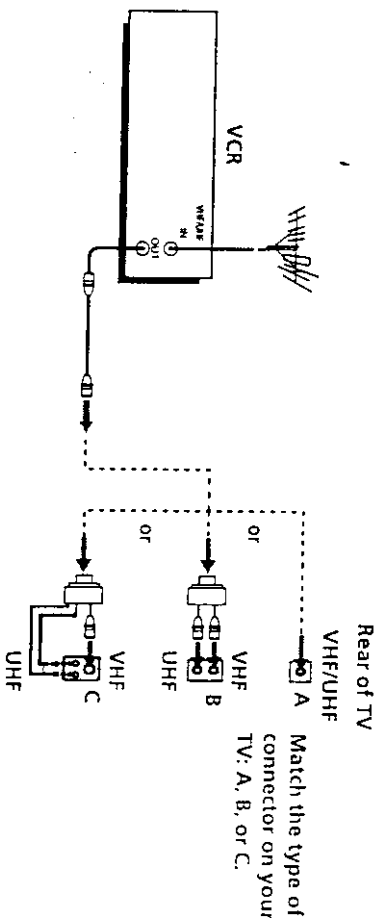

B Use this hookup if you're using a VHF-only antenna (you get channels 2-13 only)

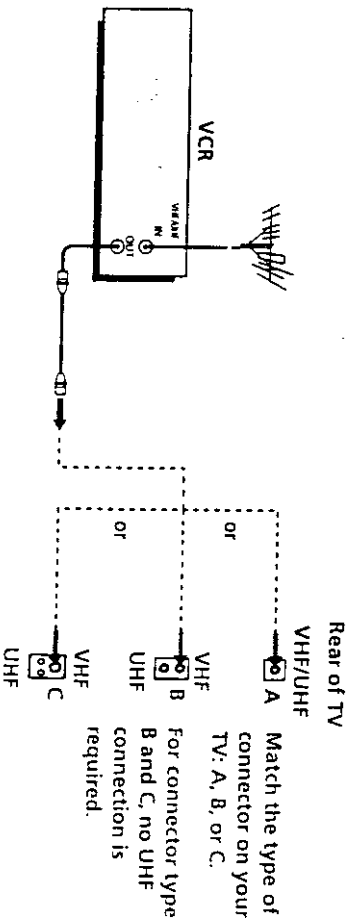

If you cannot connect your antenna cable to the VCR directly

If your antenna cable is a flat cable (300-ohm twin lead cable), attach an external antenna connector (not supplied) so you can connect the cable to the VHF/UHF IN connector. If you have separate cables for VHF and UHF antennas, you should use a U/V band mixer (not supplied). For details, see page 106.

continued

Erasing the data of an unwanted program

You can erase an unwanted program from the SmartFile list. When you erase a program from the list, that portion of tape is subject to Blank Time space priority.

Before you start...

- Turn on your TV and set it to the video channel.

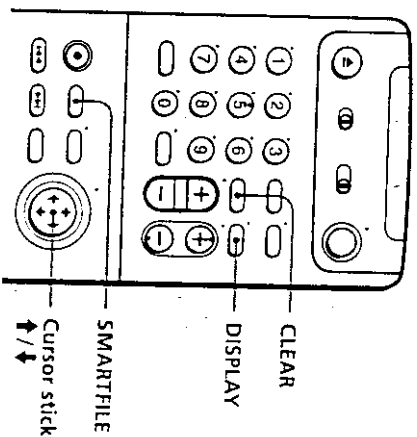

- 1 Insert a SmartFile tape.

The VCR turns on, the SMARTFILE indicator lights up, and the Smartfile search list automatically appears on the TV screen.

If the SmartFile tape is already inserted in the VCR, press SMARTFILE.

- 2 Push the cursor stick to \uparrow/\downarrow to select a program you want to erase from the list.

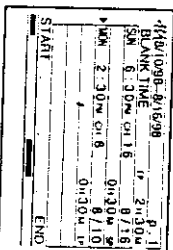
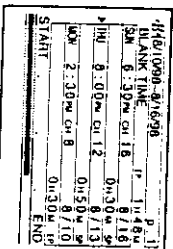
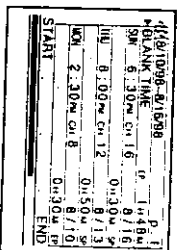

- 3 Press CLEAR.

The selected program is erased from the Smartfile list.

If you erase a program by mistake, press DISPLAY to make the program reappear.

- 4 Press SMARTFILE.

The SmartFile search list disappears.

Notes

- You cannot erase a protected program from the SmartFile list. You have to first unlock the protected program by following the instructions in "To unlock the protected program" on page 101, then erase that program from the list.
- If a program is left about 15 minutes or less in EP mode, or about 5 minutes or less in SP mode, you cannot make the program reappear by using the DISPLAY button.

- The AUTO PRESET starts.

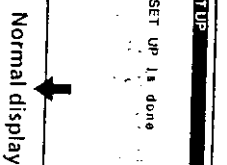
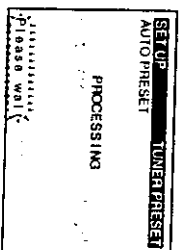

Hookup 3: VCR Plus+ channel setup

- 1 Press MENU and select SET VCR Plus+ CHANNELS.

- 2 Push the cursor stick to \leftarrow/\rightarrow to select AUTO and press the cursor stick (OK).

- 3 Press POWER to turn off the VCR.

The VCR receives the program information signal from 0:00 am to 5:00 am while the VCR is turned off, and set up the channel for VCR Plus+ recording. After channel setup is finished, you can record TV programs using VCR Plus+. For details, see page 49.

Notes

- It takes about 1 hour to complete channel setup.
- The VCR can receive the program information signal only while the VCR is turned off and no timer recordings are set.
- If the channels in your area don't carry the program information signals, set the program guide channels manually. For details, see page 51.
- If the Choose your Cable CH MAP menu appears the first time you turn on the VCR after finishing channel setup, select the MAP number. For details, see page 37.

Automatic clock setting

Once you've set up the VCR, it automatically sets the clock the first time you turn off the VCR. After that, whenever you turn off the VCR, it checks the time and adjusts the clock, even for Daylight Saving Time. The VCR sets the clock by picking up a time signal provided by some TV channels.

If you want to use the timer to record right away, or if the channels in your area do not carry time signals, set the clock manually. For details, see page 37.

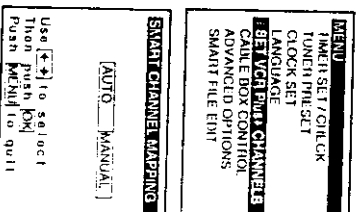

Use \leftarrow/\rightarrow to select. Then push [OK]. Push [MENU] to quit.

continue

Protecting a recorded program

You can protect a recorded program using the SmartFile function from accidental over-recording or erasure. When you start recording from a position prior to the protected program, the recording stops automatically before the protected program.

Before you start...

- Turn on your TV and set it to the video channel.

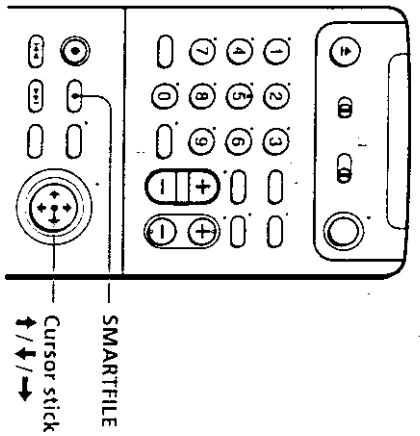

1 Insert a SmartFile tape.

The VCR turns on, the SMARTFILE indicator lights up, and the SmartFile search list automatically appears on the TV screen.

If the SmartFile tape is already in the VCR, press SMARTFILE.

2 Push the cursor stick to \uparrow/\downarrow to select the program you want to protect.

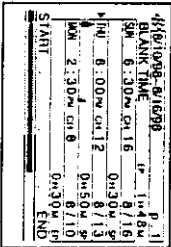
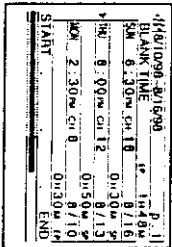
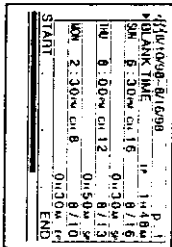

4 Press SMARTFILE.

The SmartFile search list disappears.

Hookup 4: VCR setup

- 1 Set the RF UNIT switch to CH 3 or CH 4, whichever channel is not used in your area. If both are used, set the switch to either channel. For details, see page 105.

If you made A/V connections (from page 9), you can skip this step.

- 2 Turn on your cable box.

- 3 Press EASY SET UP on the VCR.

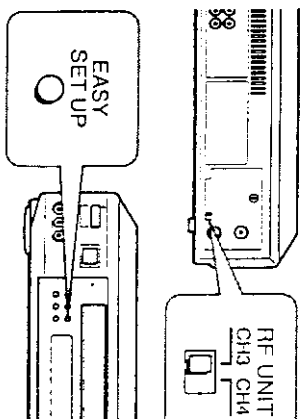

- 1 The LANGUAGE menu appears. Change the on-screen display language to Spanish (ESPAÑOL) or French (FRANCAIS) if desired, and press the cursor stick (OK). For details, see page 32.

- 2 The CLOCK SET menu appears. Select MANUAL, press the cursor stick (OK), and set the clock manually. For details, see page 37.

- 3 The SMART CH MAPPING menu appears. Push the cursor stick to $\uparrow/\downarrow/\leftarrow/\rightarrow$ to enter the ZIP/POSTAL CODE in your area and press the cursor stick (OK). (You can also use the number buttons to enter the ZIP/POSTAL CODE.)

- 4 The CABLE BOX menu appears. Select OFF and press the cursor stick (OK).

- 5 The TUNER PRESET menu appears. Set ANTENNA/CABLE to ANT and press the cursor stick (OK). For details, see page 44.

SETUP LANGUAGE

ENGLISH
ESPAÑOL
FRANCAIS

Use \leftarrow/\rightarrow to select. Then push OK . Push EASY SET UP to quit.

SETUP CLOCK

(AUTO MANUAL)

Use \leftarrow/\rightarrow to select. Then push OK . Push EASY SET UP to quit.

SETUP SMART CH MAPPING

ZIP/POSTAL CODE

12345

Enter your ZIP/POSTAL CODE using 0-9 or \leftarrow/\rightarrow and \leftarrow/\rightarrow keys, then push OK .

SETUP CABLE

CABLE BOX CONTROLLER ON

CABLE SOURCE ON

Use \leftarrow/\rightarrow to select. Then push OK . Push EASY SET UP to quit.

SETUP TUNER PRESET

ANTENNA/CABLE

ANT

CABLE

Use \leftarrow/\rightarrow to select. Then push OK . Push EASY SET UP to quit.

continuu

Labelling a recorded program and tape (continued)

Labelling a tape

Before you start...

- Turn on your TV and set it to the video channel.

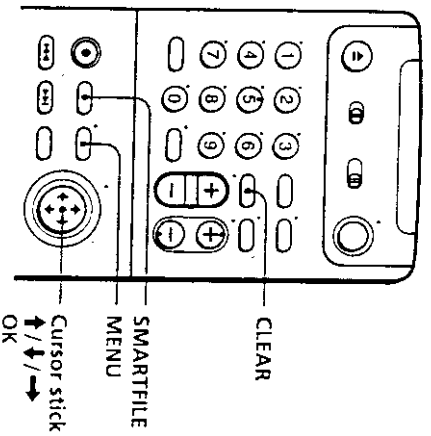

- 1 Insert a SmartFile tape.

The VCR turns on, the SMARTFILE indicator lights up, and the SmartFile search list automatically appears on the TV screen.

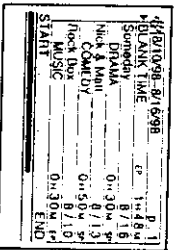

- 2 Press SMARTFILE.

The SmartFile search list disappears.

- 3 Press MENU and select SMART FILE EDIT.

The SMART FILE EDIT menu appears.

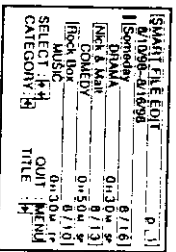

- 4 Push the cursor stick to \uparrow to select the tape title.

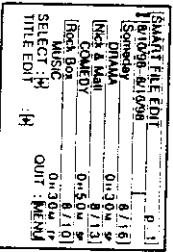

- 5 Push the cursor stick to \rightarrow .

The cursor moves to the tape title input position.

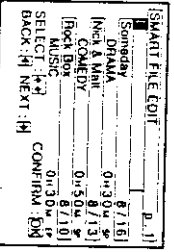

Automatic clock setting

To use the Auto Clock Set feature with this hookup, you need to manually select a channel that carries a time signal:

- 1 Tune the cable box to a channel that carries a time signal.
- 2 Select AUTO in the CLOCK SET menu to turn on the Auto Clock Set feature.

- 3 Turn off the VCR. It automatically sets the clock and adjusts for Daylight Saving Time by picking up the time signal.

If you want to use the timer to record right away, or if the channels in your area do not carry time signals, set the clock manually. For details, see page 37.

Note

- To use the Auto Clock Set feature, leave the cable box on.

continues

Labelling a recorded program and tape (continued)

- Press MENU and select SMART FILE EDIT. The SMART FILE EDIT menu appears.
- Push the cursor stick to \uparrow/\downarrow to select a program.
- Push the cursor stick to \leftarrow/\rightarrow to select a character.
- Repeat steps 1 and 2 to label the program.

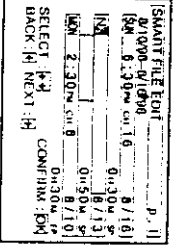
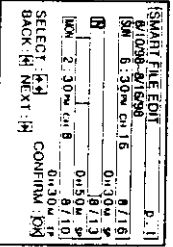
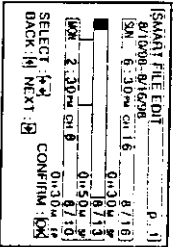
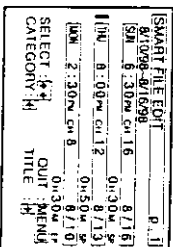
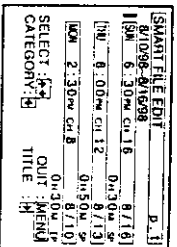

Hookup 5: VCR setup

- Set the RF UNIT switch to CH 3 or CH 4, whichever channel is not used in your area. If both are used, set the switch to either channel. For details, see page 105.
- If you made A/V connections (from page 9), you can skip this step.
- Turn on your DSS receiver. Press EASY SET UP on the VCR.

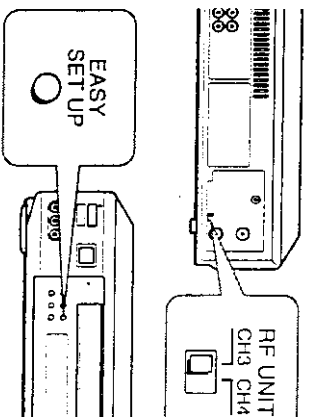

- The LANGUAGE menu appears. Change the on-screen display language to Spanish (ESPAÑOL) or French (FRANÇAIS) if desired, and press the cursor stick (OK). For details, see page 32.

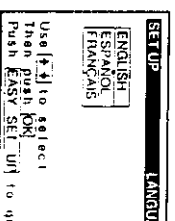

- The CLOCK SET menu appears. Select AUTO and press the cursor stick (OK). For details, see page 33.

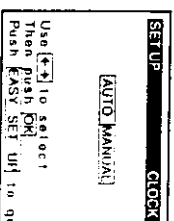

- The SMART CH MAPPING menu appears. Push the cursor stick to $\uparrow/\downarrow/\leftarrow/\rightarrow$ to enter the ZIP/POSTAL CODE in your area and press the cursor stick (OK). (You can also use the number buttons to enter the ZIP/POSTAL CODE.)

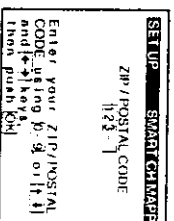

- The CABLE BOX menu appears. Select ON. For details, see page 39.

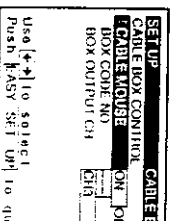

continue

Checking the contents of a tape

You can display the program data list of a Smartfile tape on the TV screen. It is not necessary to insert the tape into the VCR. This feature allows you to quickly find a specific program or to find a tape with enough recording space. The Smartfile check list can contain up to 12 programs.

Before you start...

- Turn on your TV and set it to the video channel.

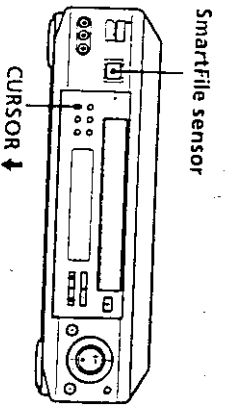

- 1 Hold the label side of the Smartfile tape close to the Smartfile sensor.

Slowly bring the center of the label within 3 cm of the Smartfile sensor.

There is a short beep, the SMARTFILE indicator lights up, and the Smartfile check list appears.

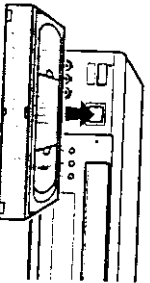

- 2 Press CURSOR ↓ repeatedly to turn the pages.

differential 2:30PM		P. 11	
PLANET	TIME	CH	16
MON	8:30PM	CH 16	8/4/98
TUE	8:30PM	CH 16	8/7/98
WED	8:30PM	CH 16	8/10/98
THU	8:30PM	CH 16	8/13/98
FRI	8:30PM	CH 16	8/16/98
SAT	8:30PM	CH 16	8/19/98
SUN	8:30PM	CH 16	8/22/98
MON	5:45PM	CH 12	8/25/98
TUE	5:45PM	CH 12	8/28/98
WED	5:45PM	CH 12	8/31/98
THU	5:45PM	CH 12	9/3/98
FRI	5:45PM	CH 12	9/6/98
SAT	5:45PM	CH 12	9/9/98
SUN	5:45PM	CH 12	9/12/98
MON	4:30PM	CH 8	9/15/98
TUE	4:30PM	CH 8	9/18/98
WED	4:30PM	CH 8	9/21/98
THU	4:30PM	CH 8	9/24/98
FRI	4:30PM	CH 8	9/27/98
SAT	4:30PM	CH 8	9/30/98
SUN	4:30PM	CH 8	10/3/98

NEXT: [6:3] QUIT: [OK]

differential 2:30PM		P. 21	
PLANET	TIME	CH	16
MON	8:30PM	CH 16	8/4/98
TUE	8:30PM	CH 16	8/7/98
WED	8:30PM	CH 16	8/10/98
THU	8:30PM	CH 16	8/13/98
FRI	8:30PM	CH 16	8/16/98
SAT	8:30PM	CH 16	8/19/98
SUN	8:30PM	CH 16	8/22/98
MON	5:45PM	CH 12	8/25/98
TUE	5:45PM	CH 12	8/28/98
WED	5:45PM	CH 12	8/31/98
THU	5:45PM	CH 12	9/3/98
FRI	5:45PM	CH 12	9/6/98
SAT	5:45PM	CH 12	9/9/98
SUN	5:45PM	CH 12	9/12/98
MON	2:30PM	CH 8	9/15/98
TUE	2:30PM	CH 8	9/18/98
WED	2:30PM	CH 8	9/21/98
THU	2:30PM	CH 8	9/24/98
FRI	2:30PM	CH 8	9/27/98
SAT	2:30PM	CH 8	9/30/98
SUN	2:30PM	CH 8	10/3/98

BACK: [6:3] QUIT: [OK]

- Tips**
- The Smartfile check list automatically disappears after about three minutes of nonuse.
 - If you press a button other than SP/EP or the cursor stick (OK), the Smartfile check list disappears.
 - You can turn the pages by pushing the cursor stick to ↑/↓ on the remote commander.

Notes

- You cannot display the Smartfile check list while:
 - you display the Smartfile list of a different Smartfile tape inserted into the VCR.
 - you display any other menu.
- If the Smartfile check list doesn't appear on the TV screen, try again by drawing the Smartfile tape away from the Smartfile sensor at least 5 cm, then bring it back to within 3 cm of the sensor.

Hookup 6

Incompatible cable box with only a few scrambled channels, using an A/B switch

Recommended use

By using an A/B switch (not supplied), this hookup allows you to record both scrambled and unscrambled channels conveniently.

What you can do with this hookup

- Record any unscrambled channel by selecting the channel directly on the VCR (the A/B switch is set to A)
- Record any scrambled channel by selecting the channel on the cable box (the A/B switch is set to B)

What you can't do

- Record one scrambled channel while watching another channel (the A/B switch is set to B)

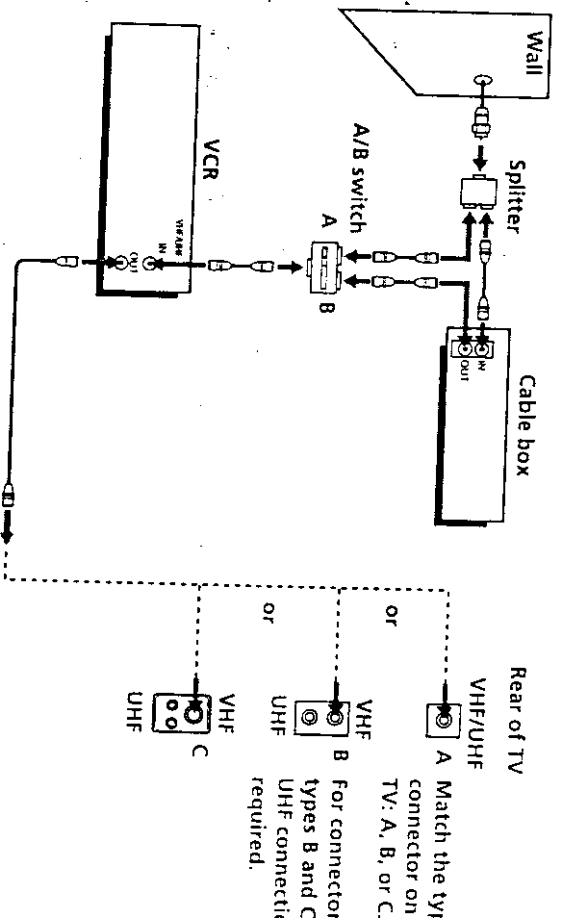

continued

Recording using the SmartFile function (continued)

3 Press SP/EP to select the tape speed, SP or EP.

The BLANK TIME changes according to the selected tape speed. Select a tape speed that matches the length of the program you want to record.

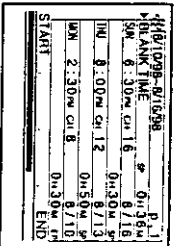

4 Press the cursor stick (OK).

The VCR goes to the beginning of the Blank Time space and stops.

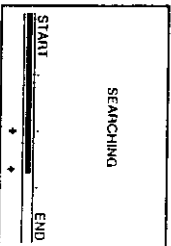

5 Start recording.

Notes

- If a newly recorded program overlaps a stored program, the stored program information is erased from the SmartFile list when:
 - the stored program is over-recorded for more than about 15 minutes in EP mode and about 5 minutes in SP mode;
 - the remaining length of the stored program becomes less than about 15 minutes in EP mode and about 5 minutes in SP mode.
- You may not be able to locate the beginning of the Blank Time space correctly in the above step 4 when:
 - the SmartFile tape contains one or more short length (less than about 15 minutes in EP mode and about 5 minutes in SP mode) recorded programs of which program data are not stored in the SmartFile label;
 - the SmartFile tape is damaged or dirty.

3 The TUNER PRESET menu appears. Set ANTENNA/CABLE to CABLE and press the cursor stick (OK). For details, see page 44.

4 The AUTO PRESET starts.

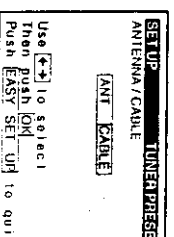
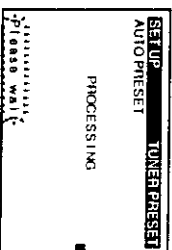

Normal display

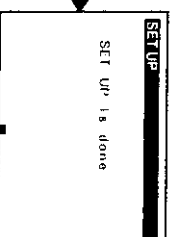

4 Preset the cable box output channel (usually 2, 3, or 4). For details, see page 46.

5 Press MENU and select TUNER PRESET.

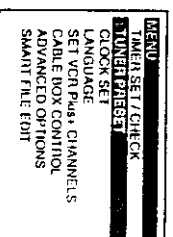

6 Enter the cable box output channel. Set MANUAL SET to ADD and press the cursor stick (OK).

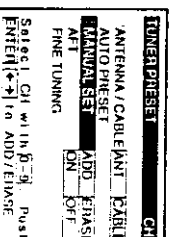

continued

Recording using the SmartFile function (continued)

To check the information of a recorded program

Press SMARTFILE. The SmartFile search list appears. The recording day of the week, start time, channel, date, station ID, recording time, and tape speed appear on the list. The longest space which doesn't have any program data (Blank Time space) appears as "BLANK TIME."

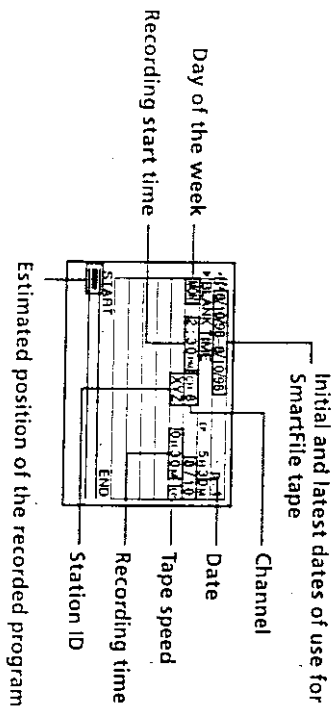

- Tip**
- You can manually name a recorded program and select the category. You can also name the SmartFile tape. See pages 95 through 99.

Notes

- If you don't set the clock or the clock isn't set to the correct time, the recording time won't be stored correctly on the SmartFile list.
- When you record a program using the normal recording mode while the CABLE MOUSE option is set to ON in the CABLE BOX CONTROL menu, the channel number is stored as "CH1--."
- When you set the AUTO TAPE SPEED option to ON in the ADVANCED OPTIONS menu, and the tape speed automatically changes from SP to EP during recording, the VCR displays the entire recording time converted in SP mode to the SmartFile list.
- The recording time length in the SmartFile list is an estimation and may be slightly different from the actual recorded time length.

- Push the cursor stick to \leftarrow / \rightarrow to select MANUAL.

- Enter the program guide channel, then the cable box output channel.

- Press the cursor stick (OK).

- Press MENU.

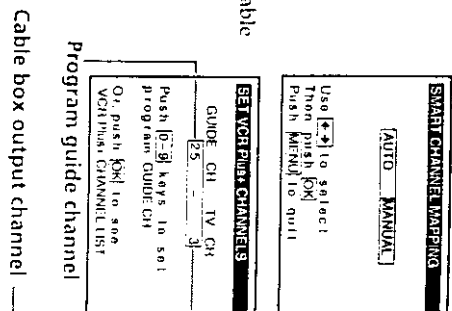

Automatic clock setting

Once you've set up the VCR, it automatically sets the clock the first time you turn off the VCR. After that, whenever you turn off the VCR, it checks the time and adjusts the clock, even for Daylight Saving Time. The VCR sets the clock by picking up a time signal provided by some TV channels.

If you want to use the timer to record right away, or if the channels in your area do not carry time signals, set the clock manually. For details, see page 37.

Note

- To use the Auto Clock Set feature, set the A/B switch to A.

Recording using the SmartFile function

To use the SmartFile function, attach the SmartFile label to the spine of the cassette tape. If you record a program on a tape with a SmartFile label, program data, such as the date and channel, is automatically stored in the memory of the SmartFile label.

Attaching the SmartFile label to the cassette tape

To use the SmartFile function, attach the supplied SmartFile label to the cassette tape. Remove any stains or dirt from the surface of the spine of the tape. Then, holding both edges of the SmartFile label so that it doesn't bend, attach it along the guide line to the spine of the cassette tape. This tape is henceforth referred to as a SmartFile tape.

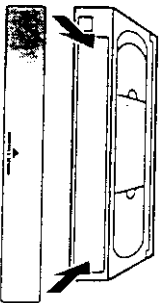

Note on the purchase of SmartFile labels

- For the customers in the USA
To order additional SmartFile labels, see the back page.
- For the customers in Canada
Additional SmartFile labels can be purchased at Sony of Canada Ltd. Authorized VHS Dealers.

Notes

- The SmartFile label is equipped with a memory chip. The memory chip may be damaged and cannot be used when you:
 - twist or fold the SmartFile label.
 - remove the SmartFile label and re-attach it to a tape.
 - attach more than one SmartFile label to a tape.
 - attach some metal, or sticker which has metal, to the SmartFile label.
 - write too strongly on the SmartFile label using a ballpoint pen or similar sharp instrument.
 - disassemble or remodel a label.
- Do not leave the SmartFile label in a place subject to excessive dust or dirt, direct sunlight, humidity, mildew, strong magnetism, or near heat sources.
- If you attach the SmartFile label to a short length tape, such as T-30 or shorter, you cannot use the SmartFile function.

Setting the clock

Using the Auto Clock Set feature

Some TV and cable channels transmit time signals with their broadcasts. Your VCR can pick up this time signal to automatically set the clock.

The Auto Clock Set feature works only if a channel in your area is broadcasting a time signal. If broadcasters in your area are not yet sending time signals, set the time manually (page 37).

Before you start...

- Turn on the VCR and the TV.
- Set the TV to the VCR channel (channel 3 or 4). If your TV is connected to the VCR using A/V connections, set the TV to video input.
- Press TV/VIDEO to display the VIDEO indicator in the display window.
- Press INPUT SELECT so that a channel number appears in the display window.

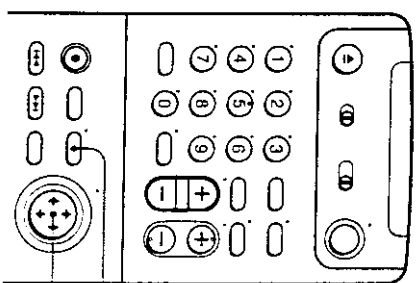

MENU
Cursor stick
↑/↓/←/→
OK

1



• MENU

Press MENU, then push the cursor stick to ↑/↓ to move the cursor to CLOCK SET and press the cursor stick (OK).

When using the EASY SET UP procedure, skip this step.



• CURSOR

PUSH OK

2



• CURSOR
PUSH OK

Push the cursor stick to ←/→ to select AUTO, then press the cursor stick (OK).

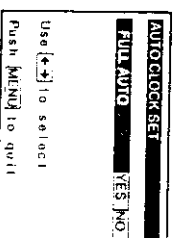

continued

About the SmartFile function

SmartFile* allows you to view the contents of your video tape (recording date, channel, etc.) on the TV screen. It is no longer necessary to rewind, fast-forward, or play back a tape to find out what is recorded. You can also locate and start playback of a specific program, or find the position from which you want to start recording by using this list. Program data is stored in the memory of the SmartFile label attached to the tape.

The following functions are possible using SmartFile:

Recording using the SmartFile function (page 88)

To use the SmartFile function, attach the SmartFile label to the tape. If you record a program on a tape with a SmartFile label, the contents will appear on the SmartFile search list. With the SmartFile list, you can also easily find the beginning of the available recording space.

Smartfile search list

4/4/09-8/16/98	1	1
DLANK TIME	8/16	
SM 6:30M CH 16	8/16	
TM 8:00M CH 12	01:30M	P
MM 2:30M CH 8	01:30M	P
START	01:30M	P
END		

Selecting and playing a program (page 93)

To play back a recorded program, select the program you want to watch using the SmartFile search list. The VCR locates the program and playback starts automatically.

Checking the contents of a tape (page 94)

When you bring the SmartFile label close to the SMARTFILE sensor on the VCR, a summary of the recorded programs appears in the SmartFile check list. It is not necessary to insert the tape into the VCR and press \blacktriangle PLAY to find out what is recorded on it. This feature allows you to easily find the program you want to watch, or to quickly find a tape with enough recording space.

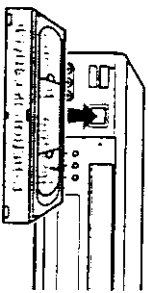

Smartfile check list

4/4/09-8/09/98	0	1
DLANK TIME	11:48M	
SM 9:00M CH 16	8/20	
TM 6:30M CH 4	8/29	
MM 9:00M CH 12	8/27	
MM 5:45M CH 7	8/27	
MM 1:30M CH 12	8/26	
MM 4:30M CH 8	8/24	
NEXT		
QUIT	END	

* SmartFile is a trademark of Sony Corporation.

If the clock is not activated

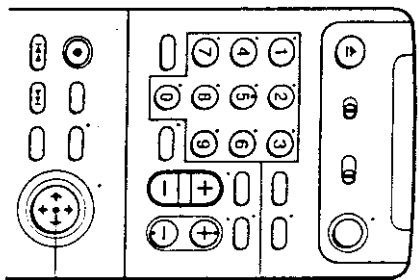

Number buttons

Cursor stick
 $\uparrow/\downarrow/\leftarrow/\rightarrow$
 OK

1

Follow steps 1 and 2 in "Using the Auto Clock Set feature."
 The AUTO CLOCK SET menu is displayed.

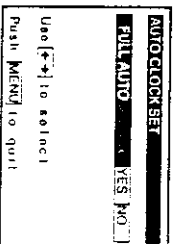

2

Push the cursor stick to \leftarrow / \rightarrow to select NO for FULL AUTO.

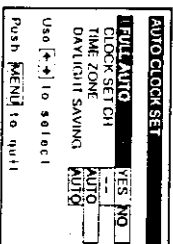

continued

Editing with another VCR

How to hook up to record on this VCR

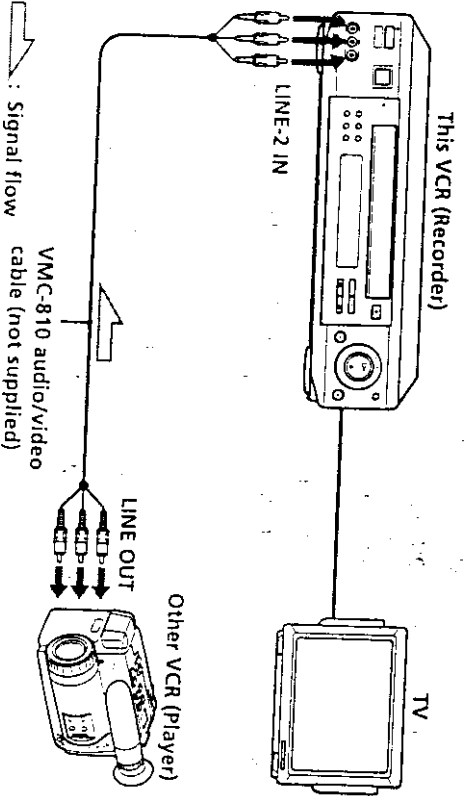

How to hook up to a stereo system

Connect **LINE-2 IN AUDIO** on this VCR to the audio output jacks on the stereo system, using the **RK-C510KS** audio cable (not supplied).

If the other VCR has a **CONTROL S OUT** jack for synchronized editing hook up to record on the other VCR, then connect the VCRs via the **CONTROL S** jacks. The **CONTROL S** connection lets you control (pause and release/pause) both VCRs from the recording VCR.

Notes

- Make sure you connect the plugs to jacks of the same color.
- If the other VCR is a monaural type and connected to this VCR's **LINE-2 IN** jacks, right and left channels. When connecting to the **AUDIO R** (red) jack, the sound is recorded only on the right channel.
- If you connected this VCR to both the **LINE IN** and **LINE OUT** jacks of the other VCR, select the input correctly to prevent a humming noise.
- You can also use the **LINE-1 IN** jacks instead. If the other VCR is a monaural type, the sound is recorded only on the channel whose jack is connected to the **audio AUDIO R/L** jacks using a **VMC-910MS** audio/video cable (not supplied).
- If the **CONTROL S IN** jack is used for **S-Link™** (A/V bus control) with a TV, the **CONTROL S** connection cannot be used for editing.

Using Manual Clock Set

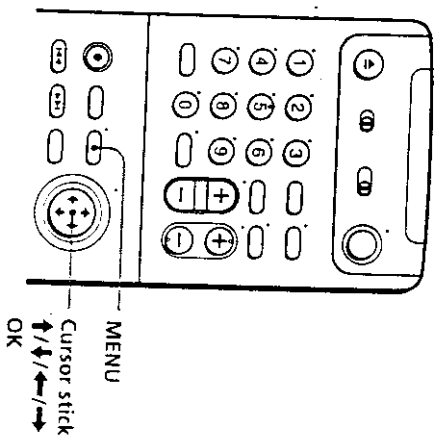

1



• MENU



• CURSOR

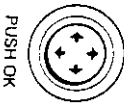

PUSH OK

Press **MENU**, then push the cursor stick to **↑/↓** to move the cursor to **CLOCK SET** and press the cursor stick (**OK**).
When using the **EASY SET UP** procedure, skip this step.

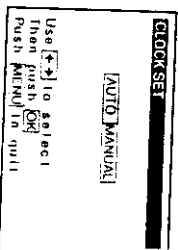

Use **↑/↓** to select then push **OK** then push **↑/↓** to quit

2



• cursor

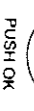

PUSH OK

Push the cursor stick to **←/→** to select **MANUAL**, then press the cursor stick (**OK**).

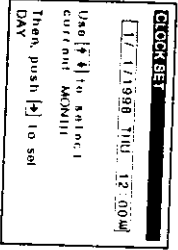

Use **↑/↓** to select current MONTH then push **↑/↓** to set DAY

3



• cursor

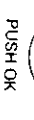

PUSH OK

Push the cursor stick to **↑/↓** to set the month.

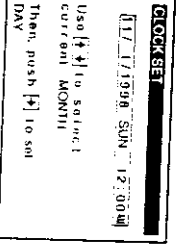

Use **↑/↓** to select current MONTH then push **↑/↓** to set DAY

continued

Changing menu options

- 1 Press MENU and select **ADVANCED OPTIONS**.
- 2 Push the cursor stick to **↑/↓** to select the option to change, then push the cursor stick to **←/→** to change the setting. The **ADVANCED OPTIONS** menu has 2 pages. To select page 2, push the cursor stick to **↑** repeatedly until page 2 appears. To select page 1, push the cursor stick to **↓** repeatedly until page 1 appears.
- 3 Press the cursor stick (**OK**) to return to the original screen.

Menu choices
Initial settings are indicated in bold print.

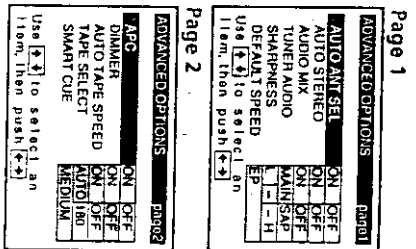

Menu option Set this option to

AUTO ANT SEL.

ON if your TV is connected only to VHF/UHF OUT on the VCR. To play a tape, set the TV to the VCR channel (channel 3 or 4). **OFF** if your TV is connected to both VHF/UHF OUT and LINE OUT on the VCR. To play a tape, set the TV to the VCR input.

AUTO STEREO

ON to receive stereo programs. **OFF** to reduce noise. The sound changes to monaural.

AUDIO MIX

ON to listen to the sound recorded on hi-fi and normal audio tracks at the same time. The **AUDIO MONITOR** button will not function. **OFF** to listen to hi-fi and normal audio tracks separately. Select the sound using the **AUDIO MONITOR** button.

TUNER AUDIO

MAIN to record the main sound on both hi-fi and normal audio tracks. **SAP** to record the SAP (Second Audio Program) sound on both hi-fi and normal audio tracks.

SHARPNESS

L (Low) through **H** (High) to adjust the sharpness of the picture. **L** to turn off the sharpness control.

DEFAULT SPEED

EP to set the recording tape speed automatically back to **EP** after recording.
SP to set the recording tape speed automatically back to **SP** after recording.
FL0AT to set the recording tape speed to the last position selected from the **SP/EP** button.

Setting up cable box control

(Skip this section if you are using Hookup 2, 3, 4, or 6.)

Your VCR includes a cable box control feature that allows the VCR to control most brands of cable boxes/DSS receivers via the Cable Mouse. With cable box control, the VCR controls channels on the cable box/DSS receiver for timer recording. You can also use the VCR's remote commander to change channels on the cable box/DSS receiver whenever the cable box/DSS receiver is turned on even if the VCR is turned off. To use cable box control, you need to connect the Cable Mouse (pages 11 and 24) and set the code number and output channel.

This VCR is programmed with codes necessary to control channel selection on most brands of cable boxes at the time this VCR was manufactured. It is possible that new cable boxes may be introduced that cannot be controlled with this VCR's Cable Mouse. If you have a cable box that is incompatible with this VCR, contact your cable operator — they may be able to provide you with a compatible cable box.

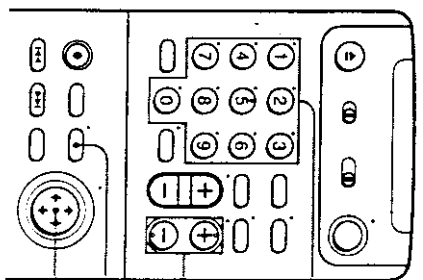

1



- MENU
- cursor

PUSH OK

Press **MENU**, then push the cursor stick to **↑/↓** to move the cursor to **CABLE BOX CONTROL** and press the cursor stick (**OK**).
When using the **EASY SET UP** procedure, skip this step.

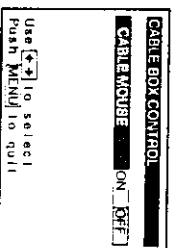

Use [←] to select. Push [MENU] to quit.

2



- cursor

PUSH OK

Push the cursor stick to **←/→** to select **ON**, then push the cursor stick to **↓**.

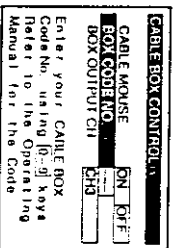

Enter your CABLE BOX Code No. using [0-9] keys. Refer to the Operating Manual for the Code.

continued

Searching using the index function

The VCR marks the tape with an index signal at the point where each recording begins. Use these signals as references to find a specific recording. The VCR can search up to 99 index signals ahead of or behind the current position.

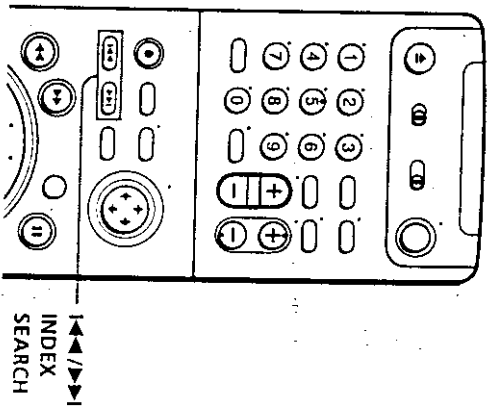

1 Insert an indexed tape into the VCR.

2 Press **INDEX SEARCH** repeatedly to specify how many index signals ahead or behind you want to search:

- To search ahead, press **INDEX SEARCH**.
- To search backwards, press **INDEX SEARCH**.

The VCR starts searching and the index number on the TV screen counts down to zero. Playback starts automatically from that point.

To stop searching

Press **STOP**.

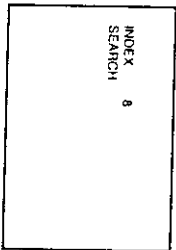

Cable bdx brand	Code numbers
Macom	044
Magnavox	038, 043, 080
Memorex	011
Movie Time	089, 167, 214
Northcoast	325
Novaplex	629
NSC	074, 081, 167, 214
Oak	018, 030, 259
Panasonic	032, 118
Paragon	011
Philips	036, 038, 039, 040, 041, 042, 071, 301
Pioneer	034, 155, 271, 544, 695
Popular Mechanics	411
Pulsar	011
Radio shack	808
RCA	032
Realistic	218
Recoton	411
Regal	031, 270, 284, 290
Regency	013
Kembrandt	081
Samsung	051, 155
Scientific Atlanta	017, 019, 028, 288
Seam	521
Sharp	324
Signal	051
Signature	022
SL Marx	051
Spectravision	069
Sprinter	032, 318
Standard Components	107, 166
Starcom	014, 026, 058, 109
Stargate	026, 051

Cable box brand	Code numbers
STS	167
Sylvania	012
T-Cable Teletext	116
Tandy	269
Tatung	108
Teknica	157
TeleCaption	232
Teleservice	292
Texscan	012, 107
Tri-C	321
Timeless	429
Toocom	023, 024
Toshiba	011
Tudi	297
TV86	074
TV COM	018, 030, 259
Unden	236
Unika	033, 164, 218
United Artists	018
United Cable	014
Universal	033, 050, 067, 088, 089, 164, 202, 218, 333
Videoway	261
Vidtech	255
Viewstar	038, 071, 074, 122, 222, 269, 300
Zenith	011, 065, 536
Zenick	411
Wave Master	576

DSS receiver brand	Code numbers
RCA	577
Sony	650

continued

Recording stereo and bilingual programs

Recording stereo programs

This VCR automatically receives and records stereo programs. When a stereo program is received, the STEREO indicator lights up. If there is noise in the stereo program, set AUTO STEREO in the ADVANCED OPTIONS menu to OFF. The sound will be recorded in monaural (on both hi-fi and normal audio tracks) but with less noise. For details, see page 82.

Recording bilingual programs

Normally, this VCR records only the main sound. When a SAP (Second Audio Program) is received, the SAP indicator lights up. To record only SAP sound, set TUNER AUDIO in the ADVANCED OPTIONS menu to SAP. For details, see page 82.

Selecting the sound during playback

Press AUDIO MONITOR to select the sound you want. (The sound being recorded will not change.)

To listen to	On-screen display	Display window
Stereo/main (left and right channels)	STEREO	STEREO
Left channel only	LEFT CH	STEREO
Right channel only	RIGHT CH	STEREO
Monaural	No indicator	No indicator

If you cannot get your VCR to control the cable box/DSS receiver

- Check that the Cable Mouse is connected to the CABLE BOX CONTROL jack on the VCR.
- Check the position of the Cable Mouse.
- Place the cable box /DSS receiver and VCR away from each other. Do not place the cable box /DSS receiver on top of the VCR.
- Try the setup again making sure to use the correct control code. If the cable box still does not respond, try the other codes that are listed.

If your cable box still does not operate with the Cable Mouse, contact your cable company to see if they can provide you with a compatible cable box.

Note

- Make sure you turn off the VCR when you plug in or unplug the Cable Mouse. If you unplug the Cable Mouse and plug it in again, turn on the VCR before you use the cable box /DSS receiver control feature.

Checking/ changing/ canceling timer settings

Before you start...

- Turn on your TV and set it to the video channel.

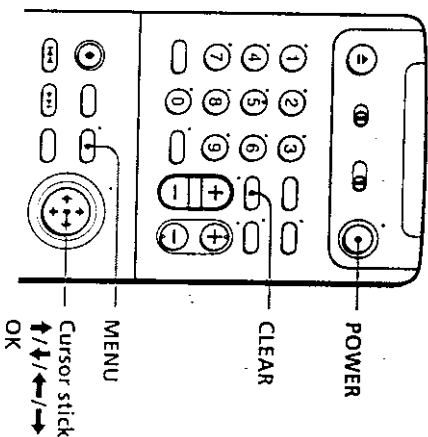

- 1 Press POWER to turn on the VCR.
 - 2 Press MENU and select TIMER SET/CHECK:
- If you want to change a setting, go on to the next step.
 - If you do not need to change the settings, press the cursor stick (OK), then turn off the VCR to return to recording standby.

TIMER SET/CHECK		11/18/93
DATE	START	STOP
11/18/93	7:30W	8:00W
11/22/93	6:30W	11:15W
MON - SAT	1:00W	3:00W
SUN	12:55W	1:30W
11/18/93	7:30W	8:00W
11/22/93	6:30W	11:15W
MON - SAT	1:00W	3:00W
SUN	12:55W	1:30W

- 3 Push the cursor stick to \uparrow/\downarrow to select the setting you want to change:
 - To change the setting, push the cursor stick to \leftarrow/\rightarrow to highlight the item you want to change, and push the cursor stick to \uparrow/\downarrow to reset it. Then, push the cursor stick to \rightarrow repeatedly until the cursor appears at the beginning of the line.
 - To cancel the setting, press CLEAR.
- 4 Press the cursor stick (OK).

If any timer settings remain, turn off the VCR to return to recording standby.

- 2 CURSOR

• To preset cable TV channels:
Push the cursor stick to \leftarrow/\rightarrow to set ANTENNA/CABLE to CABLE.



• To preset VHF and UHF channels:

Push the cursor stick to \leftarrow/\rightarrow to set ANTENNA/CABLE to ANT.



- 3 CURSOR

Push the cursor stick to \uparrow/\downarrow to select AUTO PRESET, then press the cursor stick (OK).



All receivable channels are preset in numerical sequence. When no more receivable channels can be found, presetting stops and the picture from the lowest numbered channel is displayed on the TV screen.

TIMER PRESET		CH2
ANTENNA/CABLE	ANT	CABLE
AUTO PRESET	ADD	FINISH
MANUAL SET	ON	OFF
AFT		
FINE TUNING		

Use \leftarrow/\rightarrow to select an item, then push \leftarrow/\rightarrow

TIMER PRESET		CH3
ANTENNA/CABLE	ANT	CABLE
AUTO PRESET	ADD	FINISH
MANUAL SET	ON	OFF
AFT		
FINE TUNING		

Use \leftarrow/\rightarrow to select an item, then push \leftarrow/\rightarrow

TIMER PRESET		CH3
ANTENNA/CABLE	ANT	CABLE
AUTO PRESET	ADD	FINISH
MANUAL SET	ON	OFF
AFT		
FINE TUNING		

To start AUTO PRESET, push [OK]

Tip

- When receiving a VHF, UHF, or CATV channel, the display changes as follows each time you press DISPLAY.

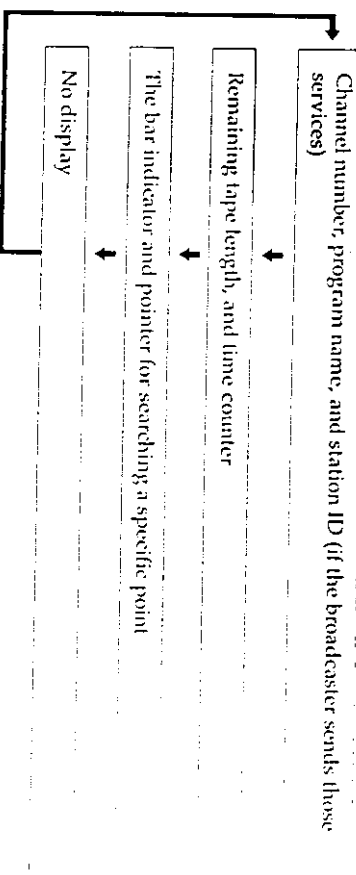

continued

Creating a favorite channel list with station IDs (continued)

Selecting a channel from your favorite channel list

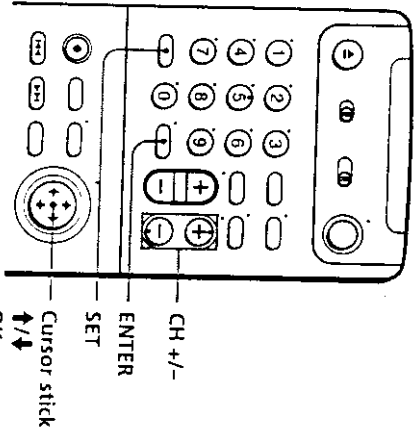

- 1 Turn on your TV and set it to the video channel. To choose a channel from a cable box, turn the cable box on.
- 2 Press SFT.

Your FAVORITE CH screen appears on the TV screen.

The selected station ID

FAVORITE CH	12	15	27	33	35	36	37	38	39	40	41	42	43	44	45	46	47	48	49	50	
	ABC	DIS	TOP	HBO	HBO2	ESPN	ESPN	TNT	WGN												

- 3 Press CH +/- to select the station ID you want to select. You can also use the cursor stick \uparrow/\downarrow instead.
- 4 Press ENTER.

Note

If the TV channel has no station ID, the channel number appears on the TV screen.

If the picture is not clear
Normally, the Auto Fine Tuning (AFT) function automatically tunes in channels clearly. If, however, the picture of a channel is not clear, you can also use the manual tuning function.

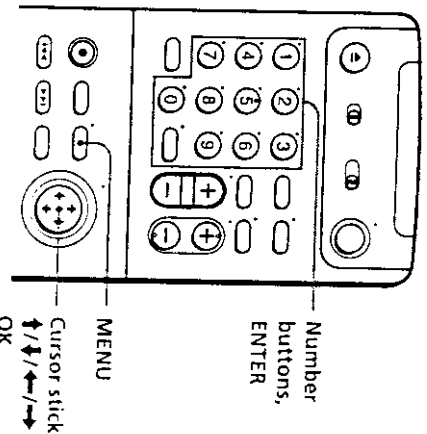

- 1 Press MENU and select TUNER PRESET, then press the cursor stick (OK).

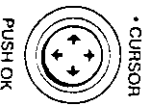

TUNER PRESET	CH3
ANTENNA/CABLE	[ENT] [CABLE]
AUTO PRESET	[ADD] [FINEST]
MANUAL SET	[ON] [OFF]
AFT	
FINE TUNING	
Select CH with 0-9. Push	
ENTER [ENTER] to ADD/TUNSE	

- 2 Press the number buttons to select the channel you want to fine-tune, then press ENTER.

TUNER PRESET	CH3
ANTENNA/CABLE	[ENT] [CABLE]
AUTO PRESET	[ADD] [FINEST]
MANUAL SET	[ON] [OFF]
AFT	
FINE TUNING	
Select CH with 0-9. Push	
ENTER [ENTER] to ADD/TUNSE	

- 3 Press the cursor stick to \uparrow/\downarrow to select FINE TUNING. The fine tuning meter appears.



TUNER PRESET	CH3
ANTENNA/CABLE	[ENT] [CABLE]
AUTO PRESET	[ADD] [FINEST]
MANUAL SET	[ON] [OFF]
AFT	
FINE TUNING	
Push [ENTER]	

- 4 Press the cursor stick to \leftarrow/\rightarrow to adjust to a clearer picture. Note that the AFT setting switches to OFF.



TUNER PRESET	CH3
ANTENNA/CABLE	[ENT] [CABLE]
AUTO PRESET	[ADD] [FINEST]
MANUAL SET	[ON] [OFF]
AFT	
FINE TUNING	
Push [ENTER]	

Skip-searching automatically

You can spot check a whole tape quickly. At intervals, the VCR skips playback while searching forward or backward.

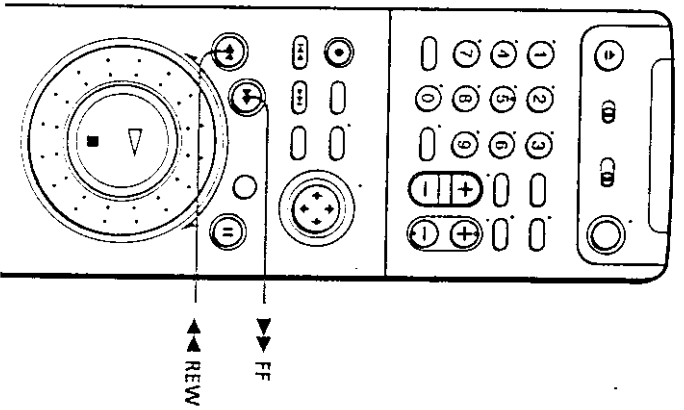

Press **▶▶ FF** (or **◀◀ REW**) for more than two seconds during stop. "SKIP" appears on the TV screen.

The VCR searches forward (or backward) for about two minutes on the counter, then fast-forwards (or rewinds) for about ten minutes on the counter. The VCR repeats this operation until it stops at the end (or beginning) of the tape.

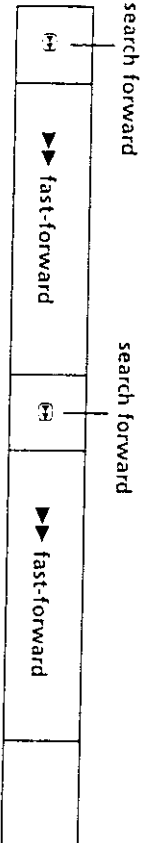

To cancel skip-search
Press **▶ PLAY** or **■ STOP**.

Note

- The VCR automatically fast-forwards (or rewinds) any portion with no recordings.

Setting up VCR Plus+ automatically (Smart Channel Mapping)

The VCR can automatically set the guide channels in your area from ZIP/POSTAL CODE you entered in EASY SET UP. The VCR receives the program information signal and renews the data everyday after you complete the following procedure.

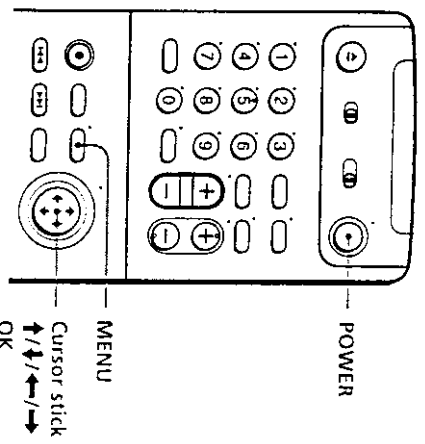

1 Set up the VCR using the EASY SET UP function.

2 Press **MENU**, then push the cursor stick to **↑/↓** to move the cursor to SET VCR Plus+ CHANNELS and press the cursor stick (OK).

• **MENU**

• **CURSOR**

SMART CHANNEL MAPPING

[Auto] MANUAL

Use **[↔]** to select. Then push **[OK]** to push **[MENU]** to quit.

The SMART CHANNEL MAPPING menu appears.

3 Push the cursor stick to **←/→** to select AUTO and press the cursor stick (OK).

• **CURSOR**

VCR will look for channel mapping signal after you turn it off!

The instruction shown on the right appears on the TV screen for few seconds, then the screen returns to the normal display.

If the program information signal in your area has several channel map patterns, the Choose your Cable CH MAP menu appears, and you must select the channel map. See "To select the channel map" on the next page.

CHOOSE YOUR CABLE CH MAP

MAP	[2]	[3]	[4]	[5]	[6]	[7]	[8]
RADC	125	CNN	55	9H			
KCBS	4	MTV					
KAET	14						
WNET	35						

Use **[↔]** to select. Then push **[OK]** to push **[MENU]** to quit.

continued

Searching for a selected point on the tape

You can easily find a specific point by moving the pointer on the TV screen. The VCR fast-forwards or rewinds to the point you indicate and starts playback automatically.

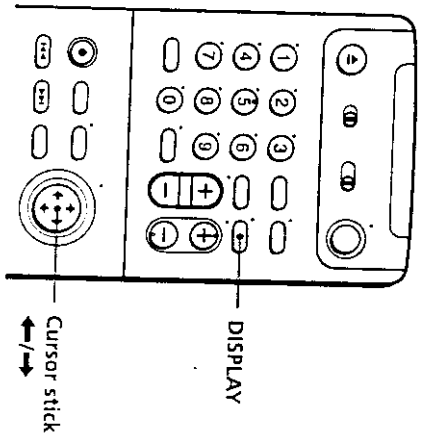

1 Press DISPLAY repeatedly until the bar indication appears on the TV screen.

A cursor (■) indicating the current position of the tape appears on the bar indication. If the cursor does not appear, play the tape a few moments (by pressing ▷ PLAY, ▶▶ FFF or ◀◀ REW) until the cursor appears.

2 Push the cursor stick to ←/→ to move the pointer (+) to the point where you want to start playback.

The VCR starts searching and the cursor (■) moves toward the pointer. When the VCR locates the marked point, playback starts.

To cancel searching

Press ▷ PLAY or ■ STOP.

To turn off the bar indication

Press DISPLAY again.

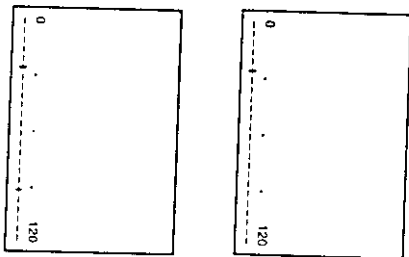

Setting up VCR Plus+ manually

To set the guide channels manually, use the Channel Line-up Chart to check that the guide channel numbers match the TV channel your VCR receives. For example, if HBO is listed in the Channel Line-up Chart on channel 33, and your VCR receives HBO on channel 5, you need to coordinate these numbers using the following procedure. If the guide and TV channel numbers are the same, you can skip this procedure.

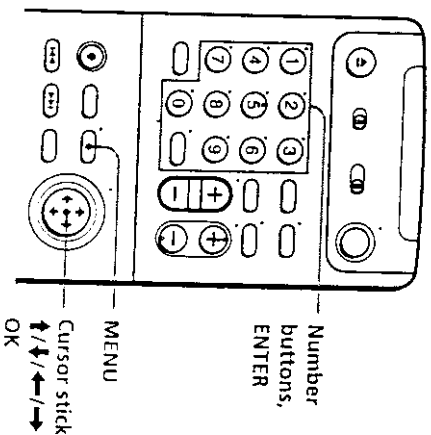

1 Press MENU, then push the cursor stick to ←/→ to move the cursor to SET VCR Plus+ CHANNELS and press the cursor stick (OK).

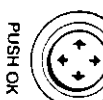
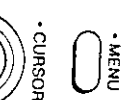

2 Push the cursor stick to ←/→ to select MANUAL and press the cursor stick (OK).



3 Enter the guide channel number assigned in the program guide and press ENTER.

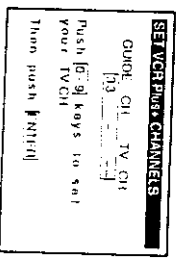
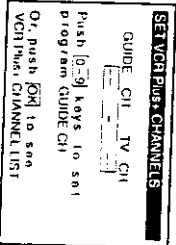
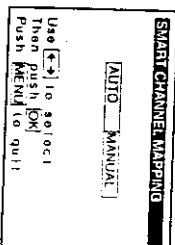
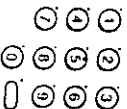

continued

Playing a tape

You can play back both VHS and S-VHS tapes on this VCR. However, you cannot obtain the original resolution quality of S-VHS (simplified playback).

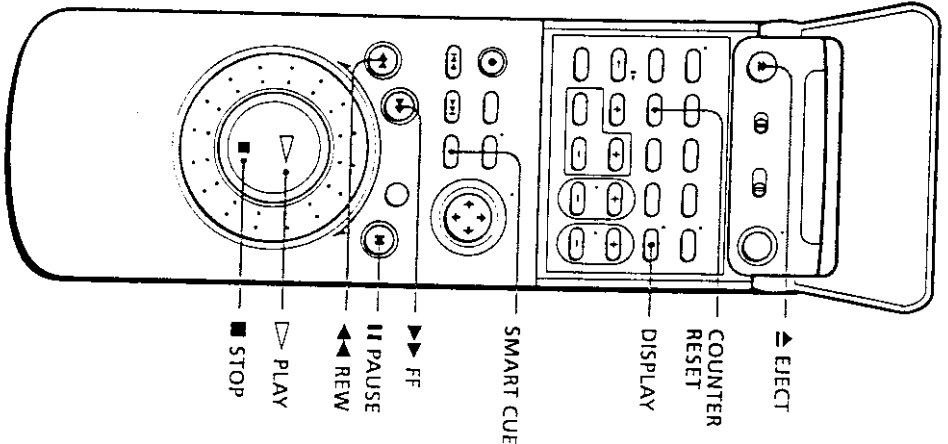

- 1 Turn on your TV and set it to the video channel.
- 2 Insert a tape.
The VCR turns on and starts playing automatically if you insert a tape with its safety tab removed.
- 3 Press **PLAY**.
When the tape reaches the end, it will rewind automatically.



Playing/searching at various speeds (continued)

Playback options	Operation
Replay a scene	During playback, first press COUNTER RESET when you come to a scene you want to replay later. When you are ready to replay the scene, press STOP. Then press TAPE RETURN and PLAY in quick succession.
Rewind and start play	During stop, hold REW on the VCR, and press PLAY on the VCR.

Using the shuttle ring

With the shuttle ring, you can operate a variety of playback options. There are two ways for using the shuttle ring, normal mode and jog mode.

To use the shuttle ring in normal mode

During playback or pause, turn the shuttle ring clockwise or counterclockwise. Each change in the shuttle ring position changes the playback mode, and the corresponding mark appears on the TV screen for a few seconds in the following way if the on-screen display function is on:

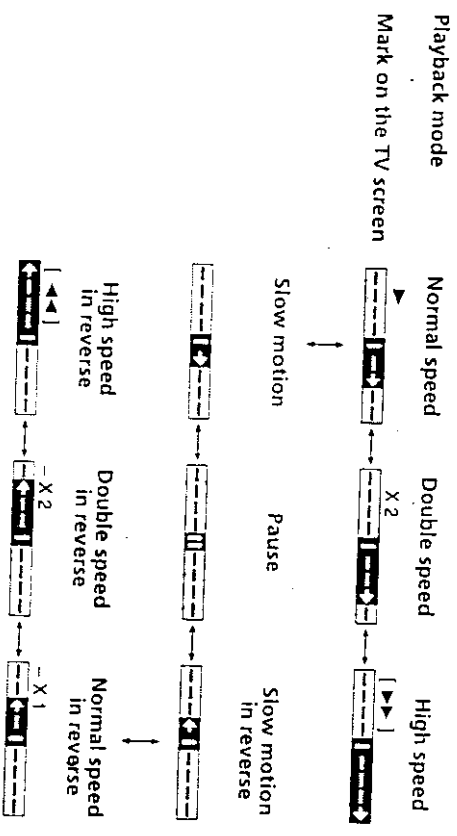

Setting the timer manually (continued)

Daily/weekly recording

In step 2 above, push the cursor stick to **↓** to select the recording pattern. Each time you push the cursor stick to **↓**, the indication changes as shown below. Push the cursor stick to **↑** to change the indication in reverse order:

the current date → **SUN-SAT** → **MON-SAT** → **MON-FRI** → **EVERY SAT**
 → **EVERY MON** → **EVERY SUN** → **1 month later** → (date counts down) →
 the current date

Tips

- To set the channel, you can also use the CH +/– or number buttons.
- You can set the channel with the shuttle ring during stop. However, you cannot set the channel with the shuttle ring on the remote commander when:
 - you set **CABLE MOUSE** in the **CABLE BOX CONTROL** menu to ON.
 - you press **JOG** so that VCR is in jog mode.
- To set the tape speed, you can also use the **SP/EP** button.
- When you are recording a program in **SP** mode and the remaining tape becomes shorter than the recording time, the tape speed is automatically changed to **EP** mode. Note that some noises will appear on the picture when the tape speed is changed. If you want to keep the tape speed, set **AUTO TAPE SPEED** to **OFF** in the **ADVANCED OPTIONS** menu (page 83).
- To lock the VCR after setting the timer, see page 63.

Notes

- If you are using cable box control, you cannot select "LINE1" or "LINE2."
- The station ID appears on the TV screen only when you complete Smart Channel Mapping and the VCR receives the program information signal (see page 49).

Recording TV programs

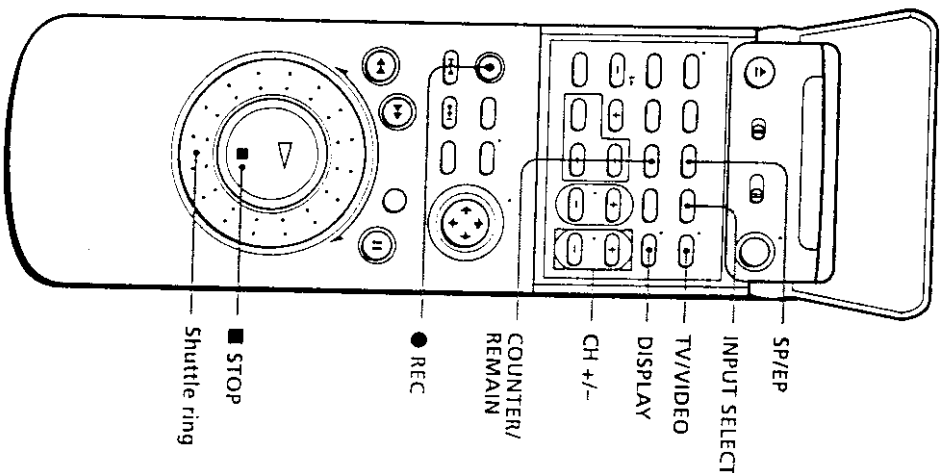

1 Turn on your TV and set it to the video channel.

To record from a cable box, turn it on.

2 Insert a tape with its safety tab in place.

continued

Setting the timer manually

If VCR Plus+ is not available in your area, follow the instructions below to set the timer to record programs.

Before you start...

- Check that the VCR clock is set to the correct time.
- Turn on your TV and set it to the video channel. When using a cable box, turn it on.
- Insert a tape with its safety tab in place. Make sure the tape is longer than the total recording time.
- If you insert a tape with the SmartFile function, make sure the total recording time doesn't overlap the protected program. For details about the SmartFile function, see page 100 through 101.

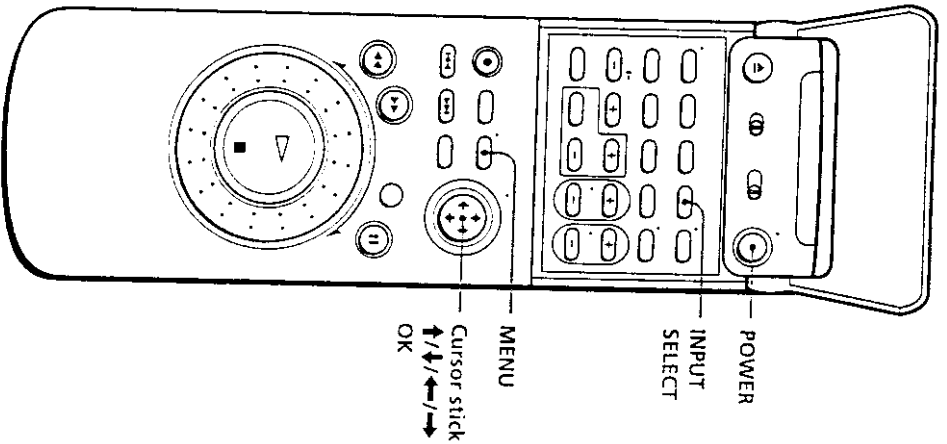

- 1 **MENU** Press **MENU** and select **TIMER SET/ CHECK**.

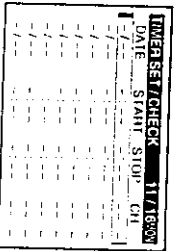

To check the remaining tape length

Press **DISPLAY**. The white bar indicates the approximate length of tape remaining. With the display on, press **COUNTER/REMAIN** to check the remaining time. Each time you press **COUNTER/REMAIN**, the time counter and the remaining time appear alternately. The remaining time with the **Q** indicator also appears in the display window.

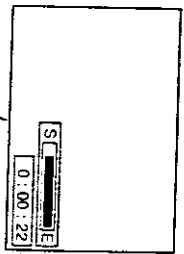

Remaining tape length
Time counter

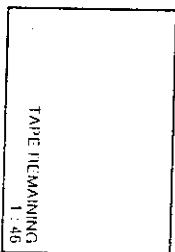

To check the remaining time of a T-140 or T-180 tape, set **TAPE SELECT** in the **ADVANCED OPTIONS** menu to "180." (For details, see page 83.)

To watch another TV program while recording

- 1 Press **TV/VIDEO** to turn off the **VIDEO** indicator in the display window.
- 2 If the TV is connected to the VCR's **LINE OUT** jacks, set the TV to TV input; if not, skip this step.
- 3 Select another channel on the TV.

To select the channel using the shuttle ring

To select a channel in step 4 above, you can also use the shuttle ring. During stop, turn the shuttle ring clockwise for higher channels or counterclockwise for lower channels. The VCR switches the channel in the preset order.

To save a recording

To prevent accidental erasure, break off the safety tab as illustrated. To record on a tape again, cover the tab hole with adhesive tape.

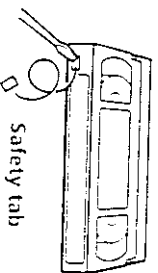

Safety tab

continued

Recording TV programs using VCR Plus+ (continued)

- 2
- 1 2 3
 - 4 5 6
 - 7 8 9
 - 0
- Press the number buttons to enter the program's PlusCode.
- If you make a mistake, press CLEAR and re-enter the correct number.

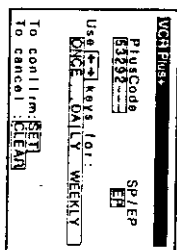

- 3
- SP/EP
EP
- Press SP/EP to select the tape speed, SP or EP.

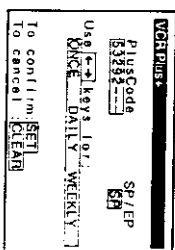

- 4
- CURSOR
PUSH OK
SET
CLEAR
- Push the cursor stick to ←/→ to select ONCE, DAILY, or WEEKLY, then press SET:
- | To record | Select |
|---------------------------|--------|
| Only once | ONCE |
| Everyday Monday to Friday | DAILY |
| Once a week | WEEKLY |
- The date, start and stop times, channel number and tape speed appear on the TV screen. If the information is not correct, press CLEAR to cancel the setting.

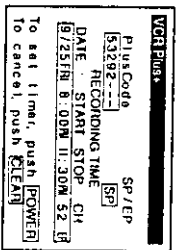

- 5
- To enter another setting, repeat steps 1 to 4.

- 6
- POWER
- Press POWER to turn off the VCR.
- The @ indicator appears in the display window and the VCR stands by for recording. When using a cable box, leave it on.

To stop recording
To stop the VCR while recording, press ■ STOP.

Locating a channel by station ID

You can select the TV program from the station ID.

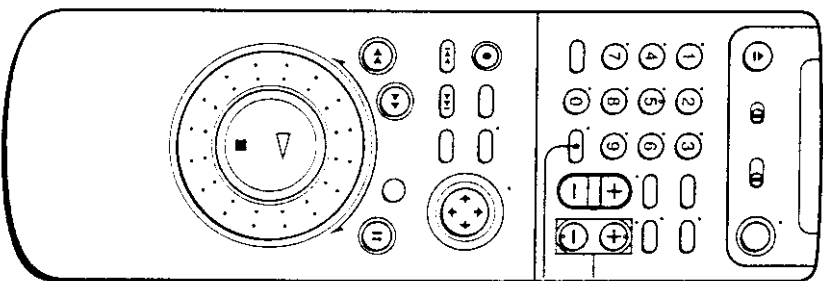

- 1
- Turn on your TV and set it to the video channel.
To record from a cable box, turn it on.

- 2
- ENTER
- Press ENTER.
The station ID appears on the TV screen.

The selected station ID

CH	STATION
3	MTV
0	WENN
10	AUC
12	JURO
11	CHS
15	CHS
19	HIRO2
22	INI
43	ESPR
45	ESPR

continued