



SONY.

3-862-974-11 (1)

Video Cassette Recorder

Hookup/Setup



VHS

Hi-Fi



SLV-M20HF

©1998 by Sony Corporation



Precautions

Safety

- Operate the unit only on 120 V AC, 60 Hz.
- If anything falls into the cabinet, unplug the unit and have it checked by qualified personnel before operating it any further.
- This unit is not disconnected from the AC power source (mains) as long as it is connected to the wall outlet, even if the unit itself has been turned off.
- One blade of the plug is wider than the other for the purpose of safety and will fit into the power outlet only one way. If you are unable to insert the plug fully into the outlet, contact your Sony dealer.
- Unplug the unit from the wall outlet if you do not intend to use it for an extended period of time. To disconnect the cord, pull it out by the plug, never by the cord.

Installing

- Allow adequate air circulation to prevent internal heat buildup.
- Do not place the unit on surfaces (rugs, blankets, etc.) or near materials (curtains, draperies) that may block the ventilation slots.
- Do not install the unit near heat sources such as radiators or air ducts, or in a place subject to direct sunlight, excessive dust, mechanical vibration or shock.
- Do not install the unit in an inclined position. It is designed to be operated in a horizontal position only.
- Keep the unit and cassettes away from equipment with strong magnets, such as microwave ovens or large loudspeakers.
- Do not place heavy objects on the unit.
- If the unit is brought directly from a cold to a warm location, moisture may condense inside the VCR and cause damage to the video head and tape. When you first install the unit, or when you move it from a cold to a warm location, wait for about one hour before operating the unit.

Table of contents

- 4 Step 1: Unpacking
- 5 Step 2: Setting up the remote commander
- 8 Step 3: Hookups
 - 9 Audio/video (A/V) hookup
 - 11 Hookup 1: Using cable box control
 - 14 Hookup 2: No cable box, or incompatible cable box with only a few scrambled channels
 - 17 Hookup 3: Antenna hookup
 - 20 Hookup 4: Incompatible cable box with many scrambled channels
 - 23 Hookup 5: DSS (Digital Satellite System) receiver
 - 26 Hookup 6: Incompatible cable box with only a few scrambled channels, using an A/B switch
- 29 Selecting a language
- 30 Setting the clock
- 34 Setting up cable box control
- 39 Presetting channels
- 43 General setup information
- 45 Index to parts and controls
- back cover
- Index

Step 1

Unpacking

Check that you have received the following items with the VCR:

- Remote commander

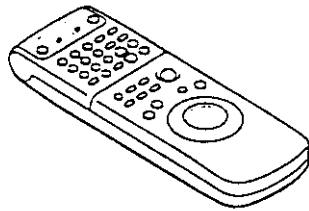

- Cable Mouse (cable box controller)

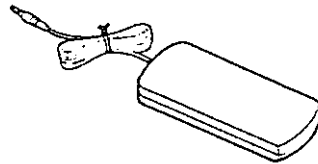

- Size AA (R6) batteries

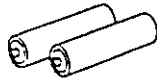

- 75-ohm coaxial cable with F-type connectors

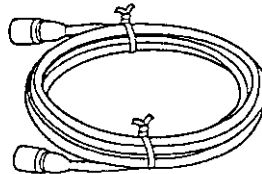

- Audio/video cable (3-phono, 1-mini to 3-phono, 1-mini)

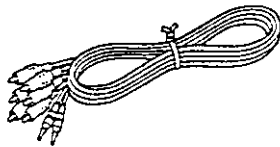

- Jack cover



- Monaural cable (1-mini to 1-mini)

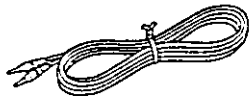

- SmartFile labels

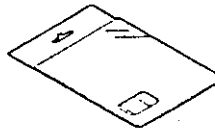

Step 2

Setting up the remote commander

Inserting the batteries

Insert two size AA (R6) batteries by matching the + and - on the batteries to the diagram inside the battery compartment.

Insert the negative (-) end first, then push in and down until the positive (+) end clicks into position.

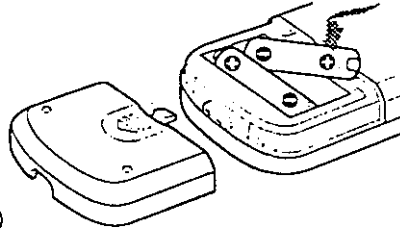

Using the remote commander

You can use this remote commander to operate this VCR and a Sony TV or AV receiver.

Buttons on the remote commander marked with a dot (•) can be used to operate your Sony TV.

The RECEIVER VOL +/- and MUTING buttons can be used to operate your Sony AV receiver.

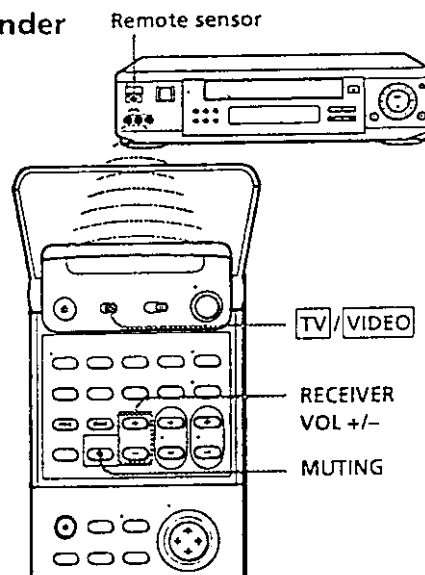

To operate the VCR	Set TV / VIDEO to VIDEO and point at the remote sensor on the VCR
a Sony TV	TV and point at the remote sensor on the TV

Notes

- With normal use, the batteries should last about three to six months.
- If you do not use the remote commander for an extended period of time, remove the batteries to avoid possible damage from battery leakage.
- Do not use a new battery with an old one.
- Do not use different types of batteries.
- Some Sony AV receivers may not be operated with the remote commander.

continued

Step 2: Setting up the remote commander (continued)

Setting the COMMAND MODE switch

To remotely control the VCR with the remote commander, set COMMAND MODE on the remote commander to the same position as that on the VCR. Usually set to VTR 3. Change the position as shown below to control other Sony VCRs:

VTR 1: For Sony Betamax format VCRs

VTR 2: For Sony 8mm format VCRs

VTR 3: For Sony VHS format VCRs

To change the command mode position of the VCR, press and hold COMMAND MODE on the VCR for about two seconds and repeat until the desired position appears in the display window.

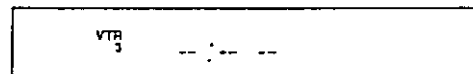
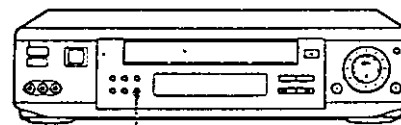
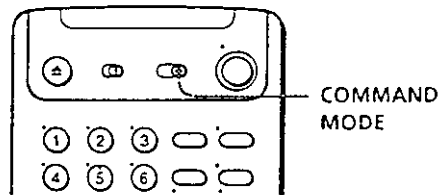

Controlling other TVs with the remote commander

The remote commander is preprogrammed to control non-Sony TVs. If your TV is listed in the table below, set the appropriate manufacturer's code number.

- 1 Set **TV**/**VIDEO** at the top of the remote commander to **TV**.
- 2 Hold **POWER** down, and enter your TV's code number(s) using the number buttons. Then release **POWER**.

Now you can use the **POWER**, **VOL +/-**, **CH +/-**, and **TV/VIDEO** buttons to control your TV. You can also use the buttons marked with a dot (•) to control a Sony TV. To control the VCR, reset **TV**/**VIDEO** to **VIDEO**.

Tip

- If you set your TV's code number correctly while the TV is turned on, the TV turns off automatically.

Code numbers of controllable TVs

If more than one code number is listed, try entering them one at a time until you find the one that works with your TV.

Manufacturer	Code number	Manufacturer	Code number	Manufacturer	Code number
Sony	01	JVC	09	RCA	04, 10
Akai	04	KMC	03	Sampo	12
AOC	04	Magnavox	03, 08, 12	Sanyo	11
Centurion	12	Marantz	04, 13	Scott	12
Coronado	03	MGA/Mitsubishi	04, 12, 13, 17	Sears	07, 10, 11
Curis-Mathes	12	NEC	04, 12	Sharp	03, 05, 18
Daytron	12	Panasonic	06, 19	Sylvania	08, 12
Emerson	03, 04, 14	Philco	03, 04	Teknika	03, 08, 14
Fisher	11	Philips	08	Toshiba	07
General Electric	06, 10	Pioneer	16	Wards	03, 04, 12
Gold Star	03, 04, 17	Portland	03	Yorx	12
Hitachi	02, 03	Quasar	06, 18	Zenith	15
J.C.Penny	04, 12	Radio Shack	05, 14		

Notes

- If the TV uses a different remote control system from the one programmed to work with the VCR, you cannot control your TV with the remote commander.
- If you enter a new code number, the code number previously entered will be erased.
- When you replace the batteries of the remote commander, the code number may automatically reset. Set the appropriate code number every time you replace the batteries.

Step 3

Hookups

Selecting the best hookup option

There are many ways in which your VCR can be hooked up. To hook up your VCR so that it works best for you, first scan through the table below. Then use the accompanying diagrams and procedures on the following pages to set up your VCR.

If you have	Use	Refer to
TV that has audio/video inputs	Audio/video (A/V) hookup, then follow one of the hookups below.	Pages 9 and 10
Cable box that is compatible with the VCR's cable box control feature	Hookup 1	Pages 11 to 13
No cable box or incompatible cable box with only a few scrambled channels	Hookup 2	Pages 14 to 16
Antenna only, no cable TV	Hookup 3	Pages 17 to 19
Incompatible cable box with many scrambled channels	Hookup 4	Pages 20 to 22
DSS* receiver	Hookup 5	Pages 23 to 25
Incompatible cable box with only a few scrambled channels, using an A/B switch	Hookup 6	Pages 26 to 28

After you've completed the connections, follow the instructions for setup. During setup, if you need more details on the procedure described, page numbers are provided where you can find complete, step-by-step instructions.

After you've completed the setup, you're ready to use your VCR. Procedures differ depending on the hookup you used. For an overview, refer to "Quick reference to using the VCR" on the back cover of the supplied operating instructions.

Before you get started

- Turn off the power to all equipment.
- Do not connect the AC power cords until all of the connections are completed.
- Be sure you make connections firmly. Loose connections may cause picture distortion.
- If your TV doesn't match any of the examples provided, see your nearest Sony dealer or qualified technician.

* DSS* is a registered trademark of DIRECTV, Inc., a unit of Hughes Electronics Corporation.

Audio/video (A/V) hookup

Pages 9 and 10

If your TV has audio/video (A/V) input jacks, you will get a better picture and sound if you hook up your VCR using these connections. In addition, for a true "home theater" experience, you should connect the audio outputs of your VCR or TV to your stereo system. If your TV doesn't have A/V inputs, see the following pages for antenna or cable hookups.

If your TV has the S-Link™* (A/V bus control) function, hook up your VCR using the connection shown on page 10. Your TV will automatically switch to the A/V inputs for your VCR when you play back or operate menu on the VCR.

If you're not planning to use your VCR to record programs, you're finished setting up the VCR after you've made the connections shown on pages 9 and 10. If you want to record off-air or off your cable TV system, complete these connections first, and then go to the following pages for antenna or cable hookups.

* S-Link™ is a trademark of Sony Corporation.

A Use this hookup if your TV has stereo jacks

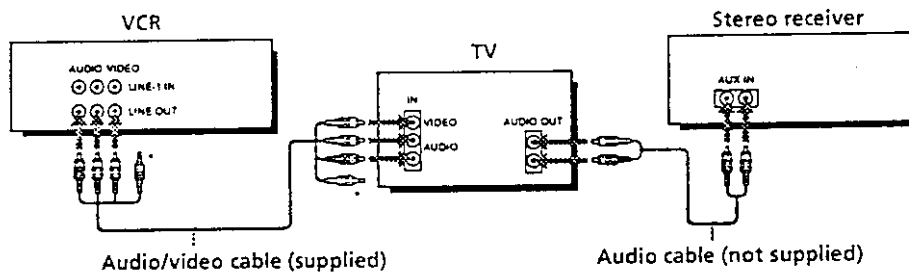

* Do not connect the miniplugs for this hookup.

B Use this hookup if your TV doesn't have stereo jacks

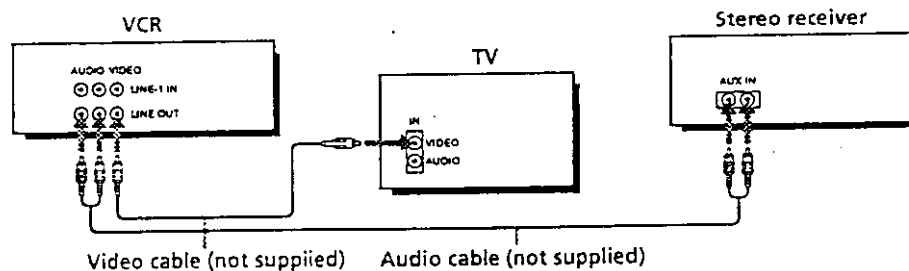

continued

Step 3: Hookups (continued)

C Use this hookup if your TV has the S-Link™ function

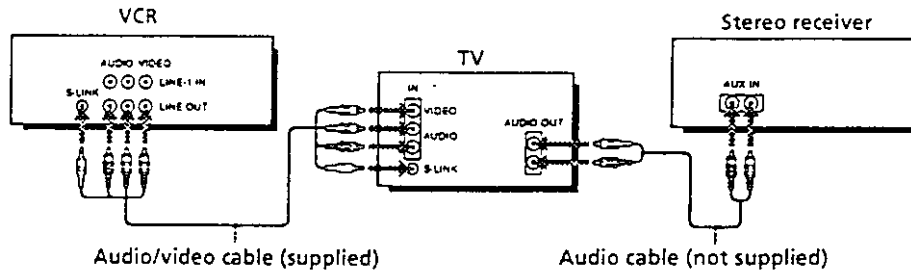

Note

- To play a tape in stereo, you must use the A/V connection.

AV hookup: VCR setup

After you've connected your TV and completed antenna or cable hookup, use the following procedure to set up the VCR.

Press MENU and select **ADVANCED OPTIONS**.

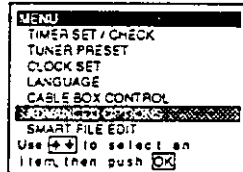

Set **AUTO ANT SEL** to OFF and press the cursor stick (OK).

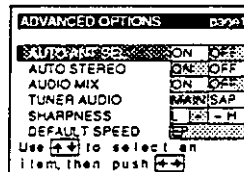

For details, refer to page 34 of the supplied operating instructions.

Caution

Connections between the VCR's VHF/UHF connector and the antenna terminals of the TV receiver should be made only as shown in the following instructions. Failure to do so may result in operation that violates the regulations of the Federal Communications Commission regarding the use and operation of RF devices. Never connect the output of the VCR to an antenna or make simultaneous (parallel) antenna and VCR connections at the antenna terminals of your receiver.

Note to CATV system installer (in USA)

This reminder is provided to call the CATV system installer's attention to Article 820-40 of the NEC that provides guidelines for proper grounding and, in particular, specifies that the cable ground shall be connected to the grounding system of the building, as close to the point of cable entry as practical.

Hookup 1

Pages 11 to 13

Using cable box control

Recommended use

You should use this hookup if you have a cable box, especially if your cable system scrambles all or most channels. This hookup allows the VCR's cable box control feature to control the channel on the cable box, simplifying the recording process. A list of compatible cable boxes is on pages 35 and 36.

What you can do with this hookup

- Record any channel using the VCR's cable box control feature to select channels on the cable box

What you can't do

- Record with the cable box turned off
- Record one channel while watching another channel

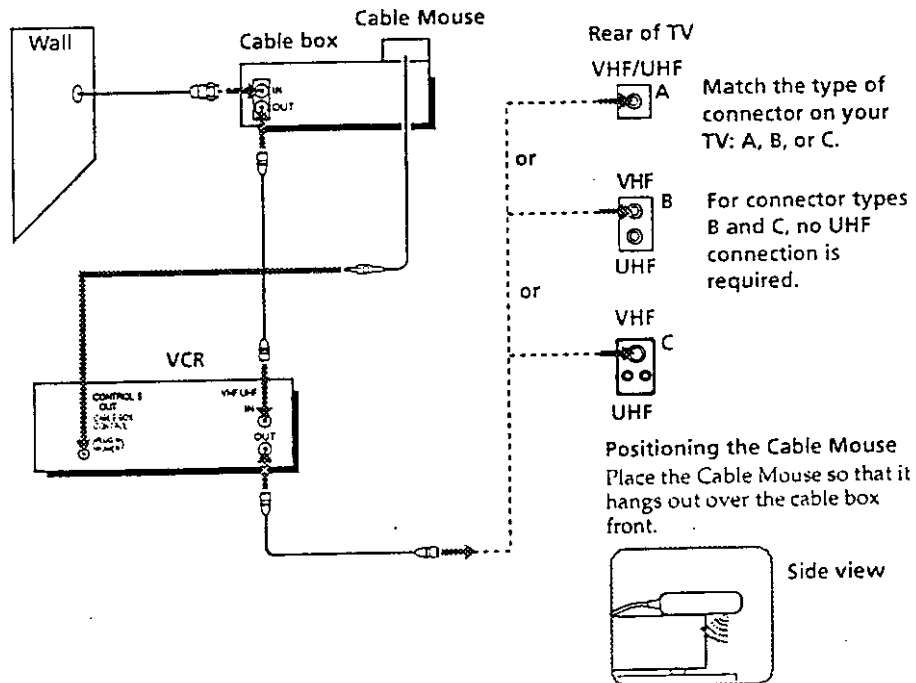

continued

Step 3: Hookups (continued)

Hookup 1: VCR setup

- 1 Set the RF UNIT switch to CH 3 or CH 4, whichever channel is not used in your area. If both are used, set the switch to either channel. For details, see page 43. If you made A/V connections (from page 9), you can skip this step.

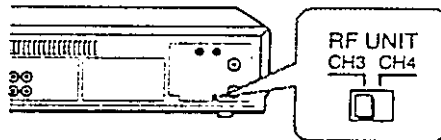

- 2 Turn on your cable box.
- 3 Press EASY SET UP on the VCR.

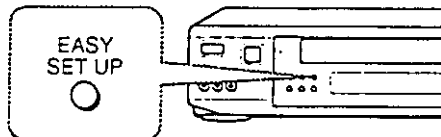

- 1 The LANGUAGE menu appears. Change the on-screen display language to Spanish (ESPAÑOL) or French (FRANÇAIS) if desired, and press the cursor stick (OK). For details, see page 29.

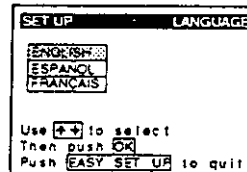

- 2 The CLOCK SET menu appears. Select AUTO and press the cursor stick (OK). For details, see page 30.

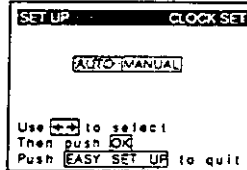

- 3 The ZIP POSTAL CODE menu appears. Push the cursor stick to \uparrow / \downarrow / \leftarrow / \rightarrow to enter the ZIP/POSTAL CODE in your area and press the cursor stick (OK). (You can also use the number buttons to enter the ZIP/POSTAL CODE.)

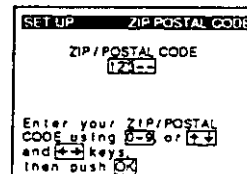

- 4 The CABLE BOX menu appears. Select ON. For details, see page 34.

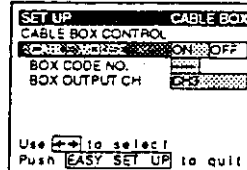

- 5 Enter your cable box code number and push the cursor stick to \downarrow . For details, see page 35.

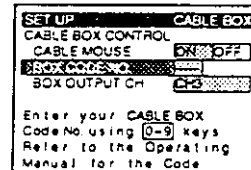

- 6 Select your cable box output channel and press the cursor stick (OK).

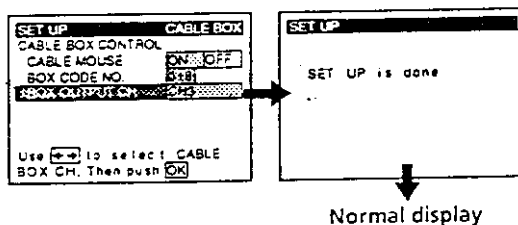

Automatic clock setting

Once you've set up the VCR, it automatically sets the clock the first time you turn off the VCR. After that, whenever you turn off the VCR, it checks the time and adjusts the clock, even for Daylight Saving Time. The VCR sets the clock by picking up a time signal provided by some TV channels.

If you want to use the timer to record right away, or if the channels in your area do not carry time signals, set the clock manually. For details, see page 32.

Note

- To use the Auto Clock Set feature, leave the cable box on.

continued

Step 3: Hookups (continued)

Hookup 2

Pages 14 to 16

No cable box, or incompatible cable box with only a few scrambled channels

Recommended use

Use this hookup if you do not have a cable box. Also use this hookup if your cable company cannot supply a cable box that is compatible with the VCR's cable box control feature, and your cable system scrambles only a few channels.

What you can do with this hookup

- Record any unscrambled channel by selecting the channel on the VCR

What you can't do

- Record scrambled channels that require a cable box

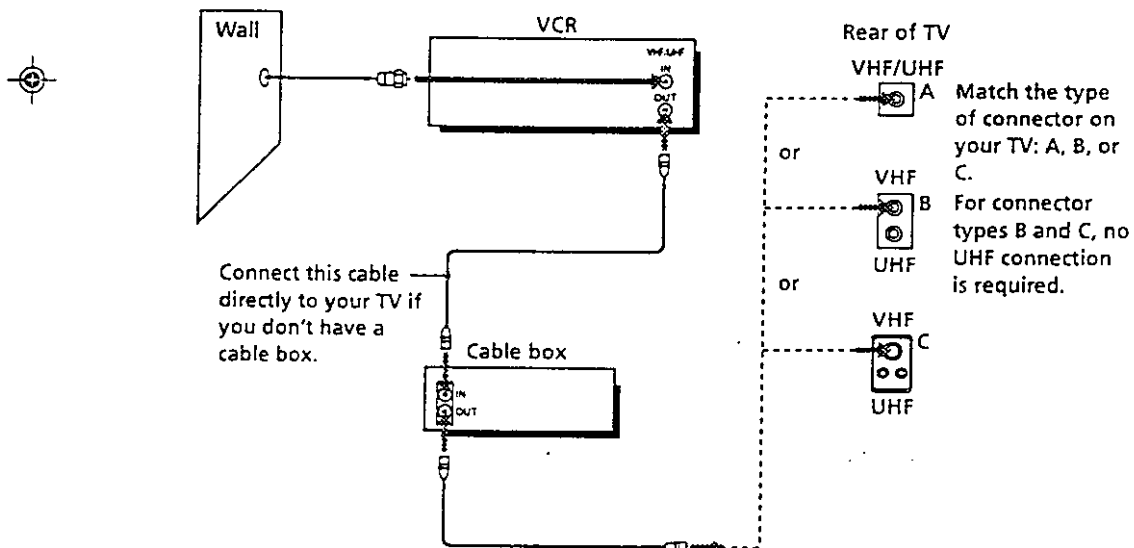

Hookup 2: VCR setup

- 1 Set the RF UNIT switch to CH 3 or CH 4, whichever channel is not used in your area. If both are used, set the switch to either channel. For details, see page 43. If you made A/V connections (from page 9), you can skip this step.

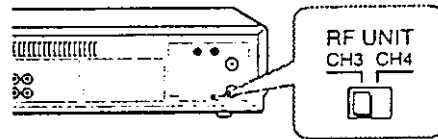

- 2 Press EASY SET UP on the VCR.

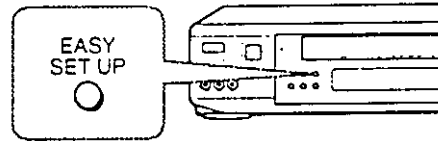

- 1 The LANGUAGE menu appears. Change the on-screen display language to Spanish (ESPAÑOL) or French (FRANÇAIS) if desired, and press the cursor stick (OK). For details, see page 29.

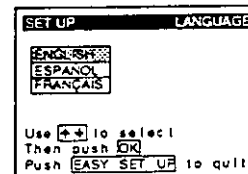

- 2 The CLOCK SET menu appears. Select AUTO and press the cursor stick (OK). For details, see page 30.

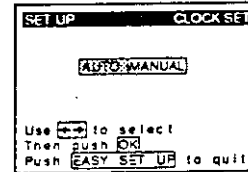

- 3 The ZIP POSTAL CODE menu appears. Push the cursor stick to ↑/↓/←/→ to enter the ZIP/POSTAL CODE in your area and press the cursor stick (OK). (You can also use the number buttons to enter the ZIP/POSTAL CODE.)

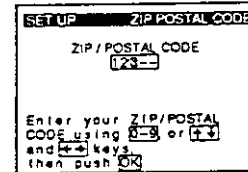

- 4 The CABLE BOX menu appears. Select OFF and press the cursor stick (OK).

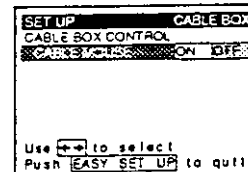

- 5 The TUNER PRESET menu appears. Set ANTENNA/CABLE to CABLE and press the cursor stick (OK). For details, see page 40.

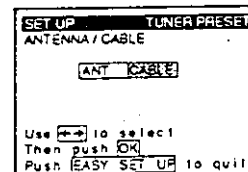

continued

Step 3: Hookups (continued)

③ The AUTO PRESET starts.

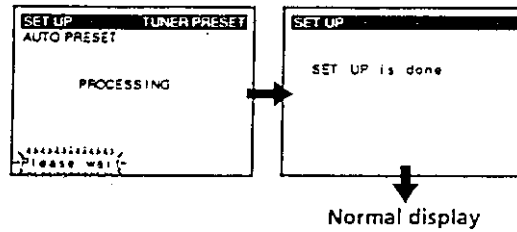

Automatic clock setting

Once you've set up the VCR, it automatically sets the clock the first time you turn off the VCR. After that, whenever you turn off the VCR, it checks the time and adjusts the clock, even for Daylight Saving Time. The VCR sets the clock by picking up a time signal provided by some TV channels.

If you want to use the timer to record right away, or if the channels in your area do not carry time signals, set the clock manually. For details, see page 32.

Hookup 3

Pages 17 to 19

Antenna hookup

Make the following connections if you're using an antenna (if you don't have cable TV).

A Use this hookup if you're using:

- VHF/UHF antenna (you get channels 2-13 and channels 14 and higher)
- UHF-only antenna (you get channels 14 and higher)
- Separate VHF and UHF antennas

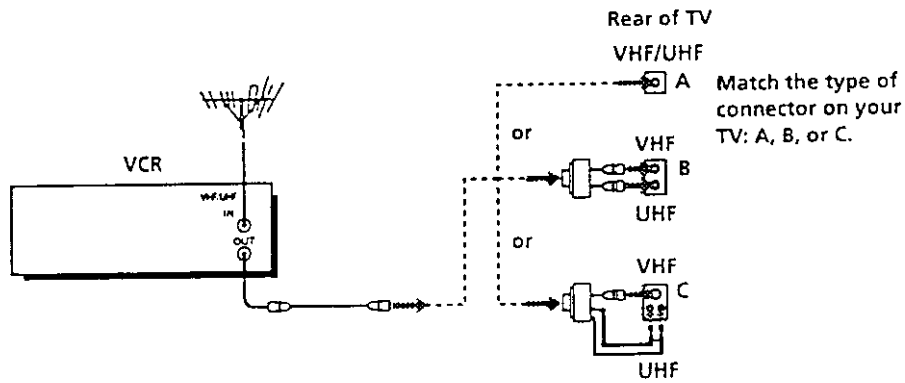

B Use this hookup if you're using a VHF-only antenna (you get channels 2-13 only)

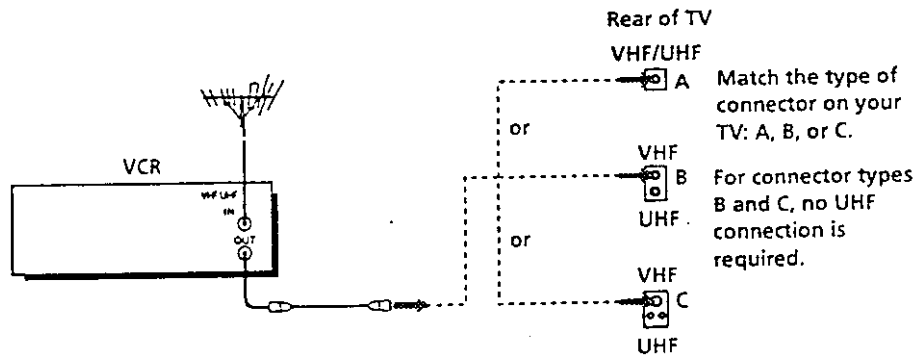

If you cannot connect your antenna cable to the VCR directly

If your antenna cable is a flat cable (300-ohm twin lead cable), attach an external antenna connector (not supplied) so you can connect the cable to the VHF/UHF IN connector. If you have separate cables for VHF and UHF antennas, you should use a U/V band mixer (not supplied). For details, see page 44.

continued

Step 3: Hookups (continued)

Hookup 3: VCR setup

- 1 Set the RF UNIT switch to CH 3 or CH 4, whichever channel is not used in your area. If both are used, set the switch to either channel. For details, see page 43. If you made A/V connections (from page 9), you can skip this step.

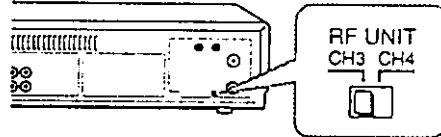

- 2 Press EASY SET UP on the VCR.

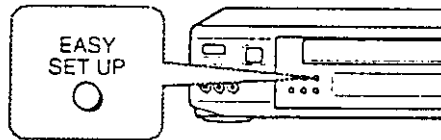

- 1 The LANGUAGE menu appears. Change the on-screen display language to Spanish (ESPAÑOL) or French (FRANÇAIS) if desired, and press the cursor stick (OK). For details, see page 29.

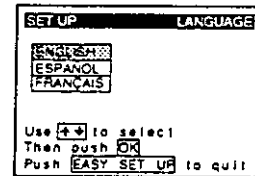

- 2 The CLOCK SET menu appears. Select AUTO and press the cursor stick (OK). For details, see page 30.

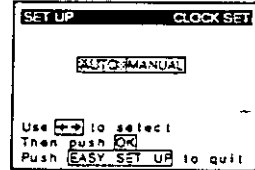

- 3 The ZIP POSTAL CODE menu appears. Push the cursor stick to up/down/left/right to enter the ZIP/POSTAL CODE in your area and press the cursor stick (OK). (You can also use the number buttons to enter the ZIP/POSTAL CODE.)

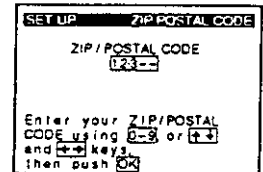

- 4 The CABLE BOX menu appears. Select OFF and press the cursor stick (OK).

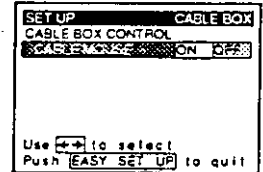

- 5 The TUNER PRESET menu appears. Set ANTENNA/CABLE to ANT and press the cursor stick (OK). For details, see page 40.

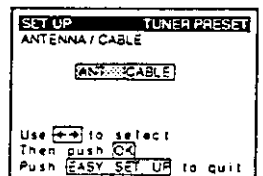

6 The AUTO PRESET starts.

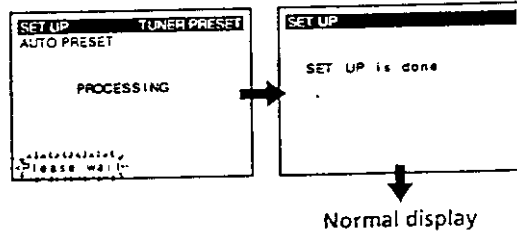

Automatic clock setting

Once you've set up the VCR, it automatically sets the clock the first time you turn off the VCR. After that, whenever you turn off the VCR, it checks the time and adjusts the clock, even for Daylight Saving Time. The VCR sets the clock by picking up a time signal provided by some TV channels.

If you want to use the timer to record right away, or if the channels in your area do not carry time signals, set the clock manually. For details, see page 32.

continued

Step 3: Hookups (continued)

Hookup 4

Pages 20 to 22

Incompatible cable box with many scrambled channels

Recommended use

Use this hookup if your cable company cannot supply a cable box that is compatible with the VCR's cable box control feature, and your cable system scrambles all or most channels.

What you can do with this hookup

- Record any channel by selecting the channel on the cable box

What you can't do

- Record with the cable box turned off
- Record one channel while watching another channel
- Select channels directly on the VCR
- Record programs with VCR Plus+
- Use the TV GUIDE Plus+ system

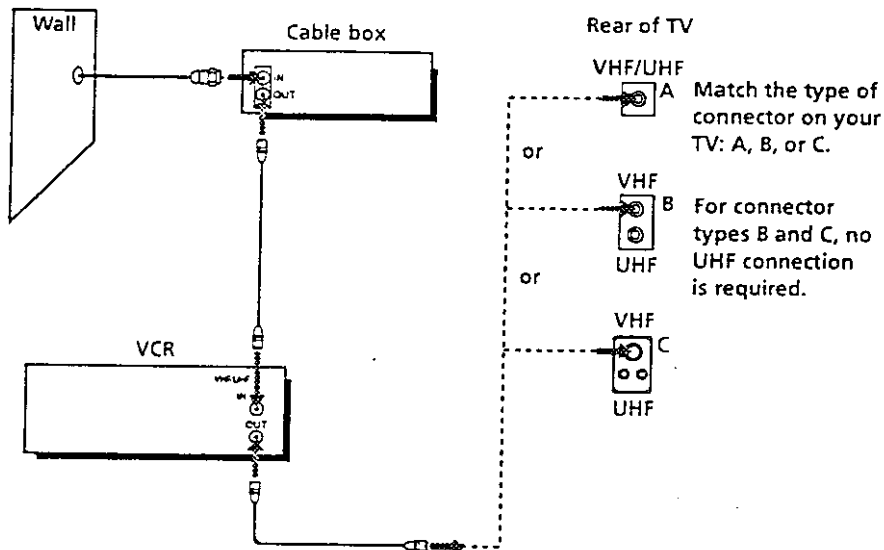

Hookup 4: VCR setup

- 1 Set the RF UNIT switch to CH 3 or CH 4, whichever channel is not used in your area. If both are used, set the switch to either channel. For details, see page 43. If you made A/V connections (from page 9), you can skip this step.

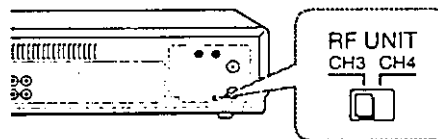

- 2 Turn on your cable box.
- 3 Press EASY SET UP on the VCR.

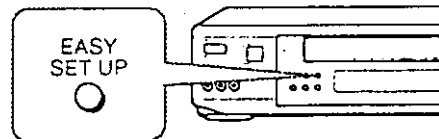

- 1 The LANGUAGE menu appears. Change the on-screen display language to Spanish (ESPAÑOL) or French (FRANÇAIS) if desired, and press the cursor stick (OK). For details, see page 29.

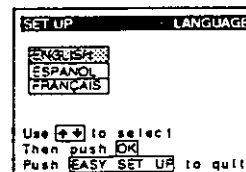

- 2 The CLOCK SET menu appears. Select MANUAL, press the cursor stick (OK) and set the clock manually. For details, see page 32.

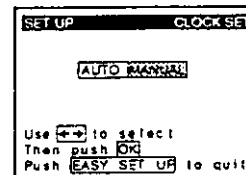

- 3 The ZIP POSTAL CODE menu appears. Push the cursor stick to ↑/↓/←/→ to enter the ZIP/POSTAL CODE in your area and press the cursor stick (OK). (You can also use the number buttons to enter the ZIP/POSTAL CODE.)

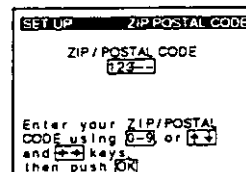

- 4 The CABLE BOX menu appears. Select OFF and press the cursor stick (OK).

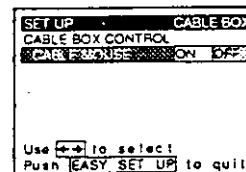

- 5 The TUNER PRESET menu appears. Set ANTENNA/CABLE to ANT and press the cursor stick (OK). For details, see page 40.

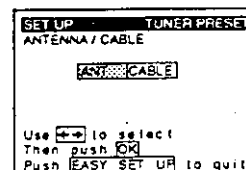

continued

Step 3: Hookups (continued)

- ⑥ The AUTO PRESET starts.

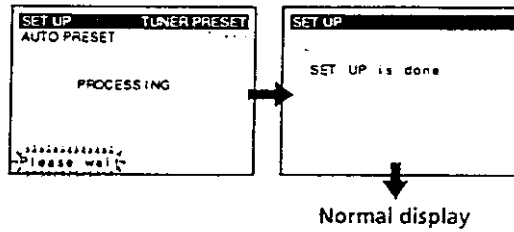

Automatic clock setting

To use the Auto Clock Set feature with this hookup, you need to manually select a channel that carries a time signal:

- 1 Tune the cable box to a channel that carries a time signal.
- 2 Select AUTO in the CLOCK SET menu to turn on the Auto Clock Set feature.
- 3 Turn off the VCR. It automatically sets the clock and adjusts for Daylight Saving Time by picking up the time signal.

If you want to use the timer to record right away, or if the channels in your area do not carry time signals, set the clock manually. For details, see page 32.

Note

- To use the Auto Clock Set feature, leave the cable box on.

DSS (Digital Satellite System) receiver

Recommended use

Use this hookup if you have a DSS receiver. It allows the VCR's cable box control feature to control the channel on the DSS receiver, simplifying the recording process. A list of compatible DSS receivers is on page 36.

DSS (Digital Satellite System) is a satellite broadcast that provides superior digital-quality video and crisp digital-quality audio. A variety of program packages are available through your program providers. It also has program guides that are sorted by program categories.

What you can do with this hookup

- Record any channels using the VCR's cable box control feature to select channels on the DSS receiver

What you can't do

- Record with the DSS receiver turned off
- Record any channels from cable or an antenna
(To record channels from cable or an antenna, turn off the cable box control feature.)
- Use a cable box
- Record programs with VCR Plus+
- Use the TV GUIDE Plus+ system
- Use the Auto Clock Set feature

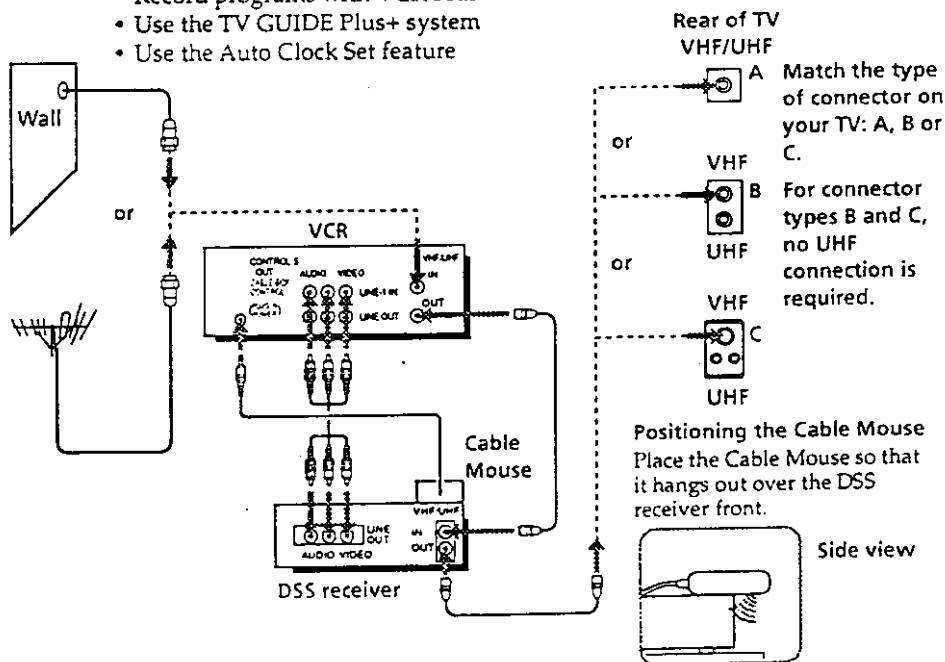

continued

Step 3: Hookups (continued)

Hookup 5: VCR setup

- 1 Set the RF UNIT switch to CH 3 or CH 4, whichever channel is not used in your area. If both are used, set the switch to either channel. For details, see page 43. If you made A/V connections (from page 9), you can skip this step.
- 2 Turn on your DSS receiver.
- 3 Press EASY SET UP on the VCR.
 - 1 The LANGUAGE menu appears. Change the on-screen display language to Spanish (ESPAÑOL) or French (FRANÇAIS) if desired, and press the cursor stick (OK). For details, see page 29.
 - 2 The CLOCK SET menu appears. Select MANUAL, press the cursor stick (OK) and set the clock manually. For details, see page 32.
 - 3 The ZIP POSTAL CODE menu appears. Push the cursor stick to $\uparrow/\downarrow/\leftarrow/\rightarrow$ to enter the ZIP/POSTAL CODE in your area and press the cursor stick (OK). (You can also use the number buttons to enter the ZIP/POSTAL CODE.)
 - 4 The CABLE BOX menu appears. Select ON. For details, see page 34.

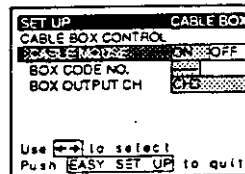
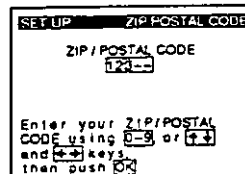
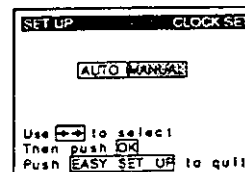
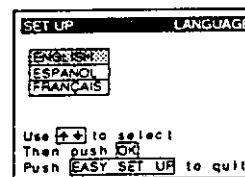
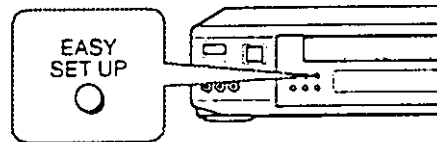
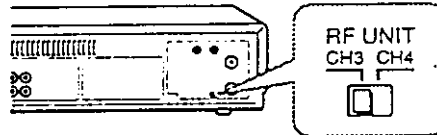

- 5 Enter your DSS receiver code number and push the cursor stick to ↓. For details, see page 35.

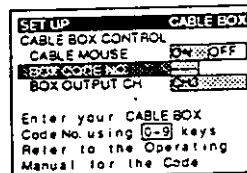

- 6 Set your DSS receiver output channel (BOX OUTPUT CH) to LINE and press the cursor stick (OK).

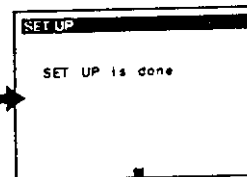
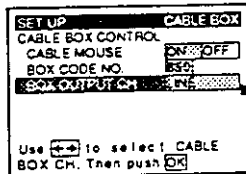

Normal display

Note

- To successfully record a program from the DSS receiver, proceed as follows:
 - Leave the DSS receiver on all the time.
 - Turn off the display (menu screen, channel number, etc.) of the DSS receiver.
 - To record or receive locked channels, unlock the channel before the VCR starts recording.
 - To set pay-per-view programs in the timer setting, order the pay-per-view program before the VCR starts recording.
 - Some programs are copy protected. You cannot record these programs.

continued

Step 3: Hookups (continued)

Hookup 6

Pages 26 to 28

Incompatible cable box with only a few scrambled channels, using an A/B switch

Recommended use

By using an A/B switch (not supplied), this hookup allows you to record both scrambled and unscrambled channels conveniently.

What you can do with this hookup

- Record any unscrambled channel by selecting the channel directly on the VCR (the A/B switch is set to A)
- Record any scrambled channel by selecting the channel on the cable box (the A/B switch is set to B)

What you can't do

- Record one scrambled channel while watching another channel (the A/B switch is set to B)

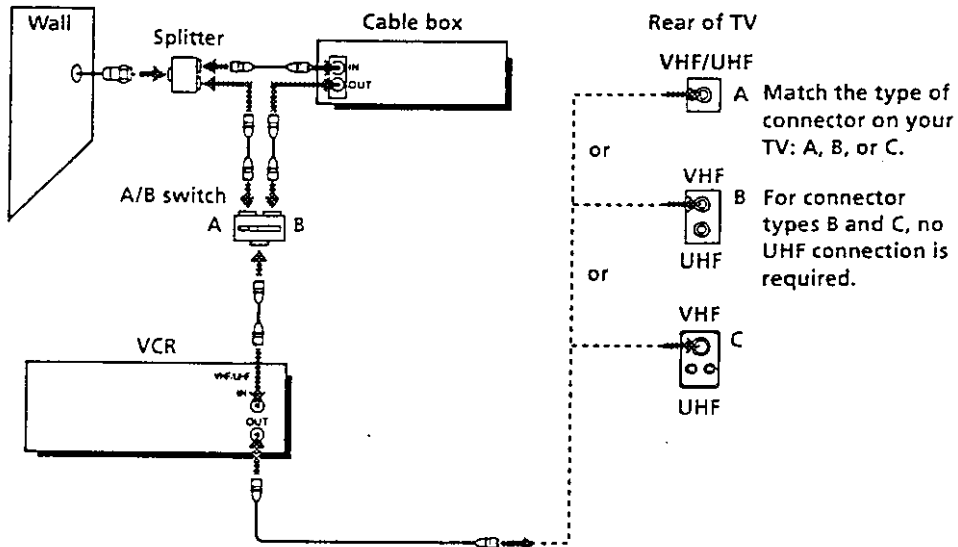

Hookup 6: VCR setup

- 1 Set the RF UNIT switch to CH 3 or CH 4, whichever channel is not used in your area. If both are used, set the switch to either channel. For details, see page 43. If you made A/V connections (from page 9), you can skip this step.
- 2 Set the A/B switch to "A."
- 3 Press EASY SET UP on the VCR.

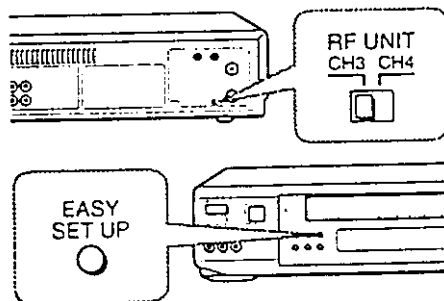

- 1 The LANGUAGE menu appears. Change the on-screen display language to Spanish (ESPAÑOL) or French (FRANÇAIS) if desired, and press the cursor stick (OK). For details, see page 29.

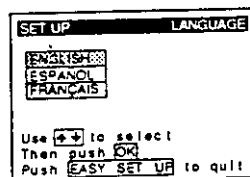

- 2 The CLOCK SET menu appears. Select AUTO and press the cursor stick (OK). For details, see page 30.

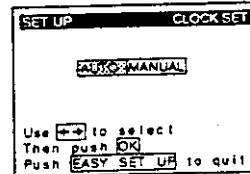

- 3 The ZIP POSTAL CODE menu appears. Push the cursor stick to ↑/↓/←/→ to enter the ZIP/POSTAL CODE in your area and press the cursor stick (OK). (You can also use the number buttons to enter the ZIP/POSTAL CODE.)

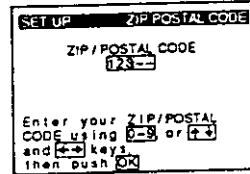

- 4 The CABLE BOX menu appears. Select OFF and press the cursor stick (OK).

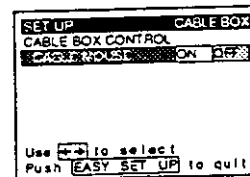

continued

Step 3: Hookups (continued)

- ⑤ The TUNER PRESET menu appears. Set ANTENNA/CABLE to CABLE and press the cursor stick (OK). For details, see page 40.

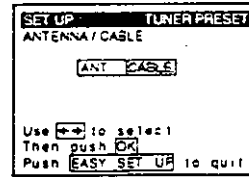

- ⑥ The AUTO PRESET starts.

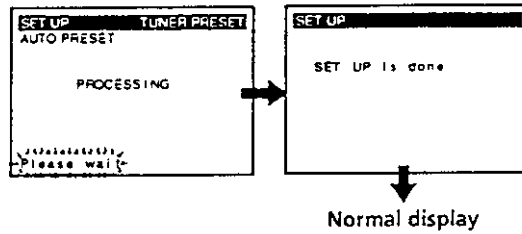

- 4 Preset the cable box output channel (usually 2, 3, or 4). For details, see page 41.

- ① Press MENU and select TUNER PRESET.

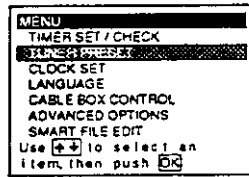

- ② Enter the cable box output channel. Set MANUAL SET to ADD and press the cursor stick (OK).

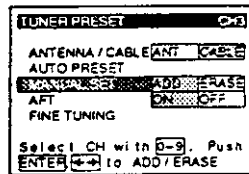

Automatic clock setting

Once you've set up the VCR, it automatically sets the clock the first time you turn off the VCR. After that, whenever you turn off the VCR, it checks the time and adjusts the clock, even for Daylight Saving Time. The VCR sets the clock by picking up a time signal provided by some TV channels.

If you want to use the timer to record right away, or if the channels in your area do not carry time signals, set the clock manually. For details, see page 32.

Note

- To use the Auto Clock Set feature, set the A/B switch to A.

Selecting a language

You can change the on-screen display language.

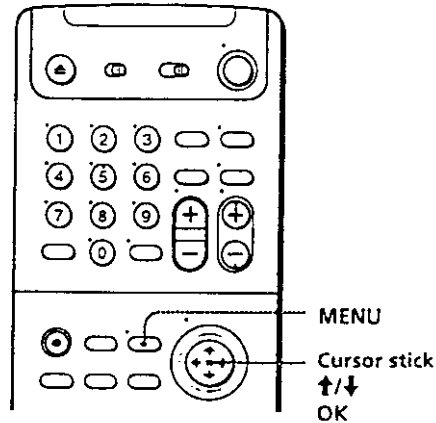

1

• MENU



• CURSOR



PUSH OK

Press MENU, then push the cursor stick to ↑/↓ to move the cursor to LANGUAGE and press the cursor stick (OK).

When using the EASY SET UP procedure, skip this step.

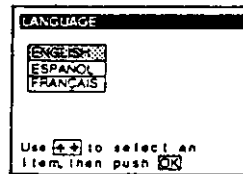

2

• CURSOR



PUSH OK

Push the cursor stick to ↑/↓ to select ENGLISH, ESPAÑOL, or FRANÇAIS, then press the cursor stick (OK).

Setting the clock

Using the Auto Clock Set feature

Some TV and cable channels transmit time signals with their broadcasts. Your VCR can pick up this time signal to automatically set the clock.

The Auto Clock Set feature works only if a channel in your area is broadcasting a time signal. If broadcasters in your area are not yet sending time signals, set the time manually (page 32).

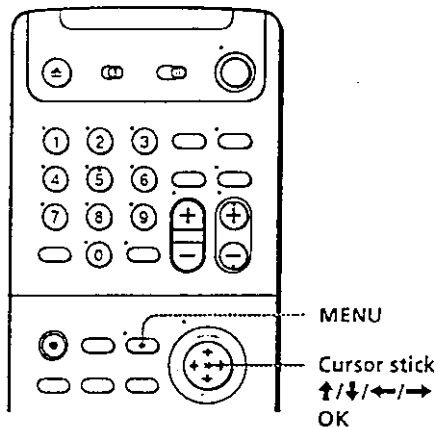

Before you start...

- Turn on the VCR and the TV.
- Set the TV to the VCR channel (channel 3 or 4). If your TV is connected to the VCR using A/V connections, set the TV to video input.
- Press TV/VIDEO to display the VIDEO indicator in the display window.
- Press INPUT SELECT so that a channel number appears in the display window.

- 1** • MENU Press MENU, then push the cursor stick to ↑/↓ to move the cursor to CLOCK SET and press the cursor stick (OK).



• CURSOR



PUSH OK

When using the EASY SET UP procedure, skip this step.

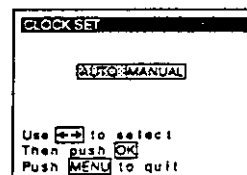

- 2** • CURSOR Push the cursor stick to ←/→ to select AUTO, then press the cursor stick (OK).



PUSH OK

3

To activate the Auto Clock Set function, turn off the VCR.

The VCR automatically sets the clock by searching for a channel that carries a time signal and sets your time zone and Daylight Saving Time (if applicable).

Notes

- The clock cannot be set automatically if you don't receive a channel that carries a time signal in your area. If so, set the clock manually.
- If there are only a few channels in your area that carry time signals, setting the clock automatically may take up to about 30 minutes.
- If you use Hookup 1 or 4, make sure you leave the cable box on.

continued

Setting the clock (continued)

Using Manual Clock Set

The TV GUIDE Plus+ system operates according to the time signals transmitted from certain TV stations. However, when you set CLOCK SET to MANUAL, the manual timer operates according to the VCR's own clock, and the TV GUIDE Plus+ timer operates according to the time signals transmitted from certain TV stations.

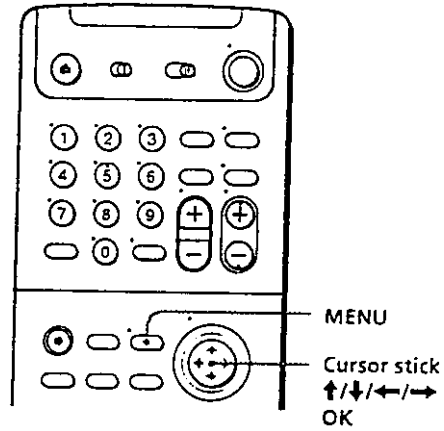

- 1** • MENU
• CURSOR
- Press MENU, then push the cursor stick to ↑/↓ to move the cursor to CLOCK SET and press the cursor stick (OK).
When using the EASY SET UP procedure, skip this step.

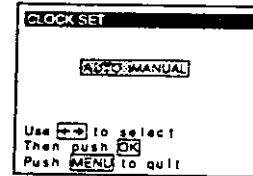

- 2** • CURSOR
- Push the cursor stick to ←/→ to select MANUAL, then press the cursor stick (OK).

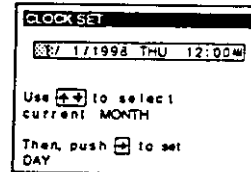

- 3** • CURSOR
- Push the cursor stick to ↑/↓ to set the month.

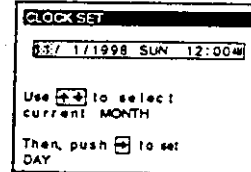



4

• CURSOR

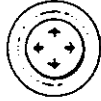

PUSH OK

Push the cursor stick to → to highlight the day and push the cursor stick to ↑/↓ to set the day.

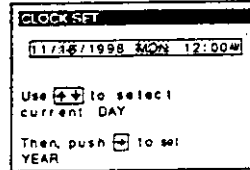

5

• CURSOR



PUSH OK

Set the year, hour and minutes in the same way as the day. The day of the week is set automatically.

6

• CURSOR



PUSH OK

Press the cursor stick (OK) to start the clock.

Setting up cable box control

(Skip this section if you are using Hookup 2, 3, 4, or 6.)

Your VCR includes a cable box control feature that allows the VCR to control most brands of cable boxes/DSS receivers via the Cable Mouse. With cable box control, the VCR controls channels on the cable box/DSS receiver for timer recording. You can also use the VCR's remote commander to change channels on the cable box/DSS receiver whenever the cable box/DSS receiver is turned on even if the VCR is turned off. To use cable box control, you need to connect the Cable Mouse (pages 11 and 23) and set the code number and output channel.

This VCR is programmed with codes necessary to control channel selection on most brands of cable boxes at the time this VCR was manufactured. It is possible that new cable boxes may be introduced that cannot be controlled with this VCR's Cable Mouse. If you have a cable box that is incompatible with this VCR, contact your cable operator — they may be able to provide you with a compatible cable box.

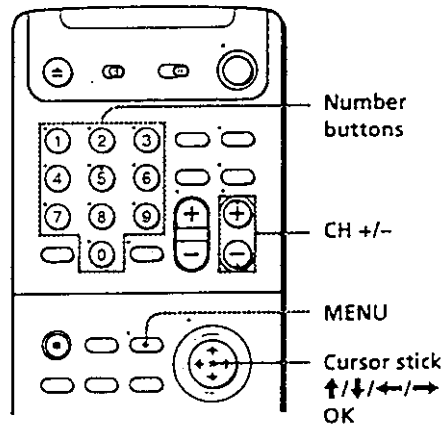

- 1**  Press MENU, then push the cursor stick to \uparrow/\downarrow to move the cursor to CABLE BOX CONTROL and press the cursor stick (OK).



When using the EASY SET UP procedure, skip this step.

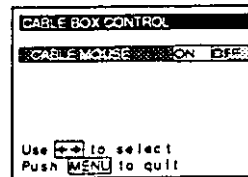

- 2**  Push the cursor stick to \leftarrow/\rightarrow to select ON, then push the cursor stick to \downarrow .

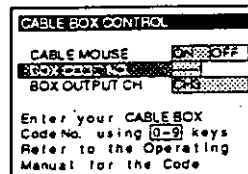

- 3**
- ① ② ③
 - ④ ⑤ ⑥
 - ⑦ ⑧ ⑨
 - ⑩
- Press the number buttons to enter the cable box/DSS receiver code number, then push the cursor stick to ↓.
- Find your cable box/DSS receiver code number from the chart below.

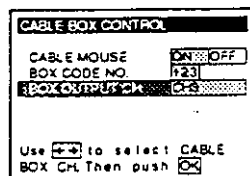

- 4**
- CURSOR
- If you want to control a cable box, push the cursor stick to ←/→ to select the output channel for the cable box, then press the cursor stick (OK).
- If you want to control a DSS receiver, select LINE, then press the cursor stick (OK).



Cable box and DSS receiver brand and the corresponding code numbers
 If more than one code number is listed, try entering them one by one, until you come to the correct code for your equipment.

Cable box brand	Code numbers
ABC	018, 022, 024, 028, 217
Antronix	218
Archer	033, 050, 164, 218, 808
BBT	278
Cable Star	067
Cabletenna	033
Cable time	172, 388, 459
Century	164
Citizen	164, 326, 327
Clyde Cablevision	097
Colour Voice	036, 042
Comband	243, 244
Comtronics	051, 071
Decsat	434
Diamond	046
Eagle Comtronics	051

Cable box brand	Code numbers
Eastern	013, 285
Electricord	089
Electus	055
Focus	411
Garrard	164
GC Electronics	027, 067, 341
GE	243, 244
GEC	097
Gemini	026, 068, 081
General Instrument	022, 287, 487
Hamlin	020, 031, 045, 270, 284
Hitachi	022
Jasco	164, 326
Jerrold	014, 022, 025, 026, 035, 037, 058, 109, 287, 487
Linsay	451

continued

Setting up cable box control (continued)

Cable box brand	Code numbers
Macom	044
Magnavox	038, 043, 080
Memorex	011
Movie Time	089, 167, 214
Northcoast	325
Novaplex	629
NSC	074, 081, 167, 214
Oak	018, 030, 259
Panasonic	032, 118
Paragon	011
Philips	036, 038, 039, 040, 041, 042, 071, 301
Pioneer	034, 155, 271, 544, 695
Popular Mechanics	411
Pulsar	011
Radio shack	808
RCA	032
Realistic	218
Recoton	411
Regal	031, 270, 284, 290
Regency	013
Rembrandt	081
Samsung	051, 155
Scientific Atlanta	017, 019, 028, 288
Seam	521
Sharp	324
Signal	051
Signature	022
SL Marx	051
Spectravision	069
Sprucer	032, 318
Standard Components	107, 166
Starcom	014, 026, 058, 109
Stargate	026, 051

Cable box brand	Code numbers
STS	167
Sylvania	012
T-Cable Teletext	116
Tandy	269
Tatung	108
Teknica	157
TeleCaption	232
Teleservice	292
Texscan	012, 107
TFC	321
Timeless	429
Tocom	023, 024
Toshiba	011
Tudi	297
TV86	074
TV COM	018, 030, 259
Uniden	236
Unika	033, 164, 218
United Artists	018
United Cable	014
Universal	033, 050, 067, 088, 089, 164, 202, 218, 333
Videoway	261
Vidtech	255
Viewstar	038, 071, 074, 122, 222, 269, 300
Zenith	011, 065, 536
Zentek	411
Wave Master	576

DSS receiver brand	Code numbers
RCA	577
Sony	650

To ensure correct operation

- Place the Cable Mouse so that it hangs out over the cable box/DSS receiver front.
- Do not place the cable box/DSS receiver on top of the VCR.
- Position the cable box/DSS receiver away from the VCR.
- Point the remote commander at the VCR, not at the cable box/DSS receiver.

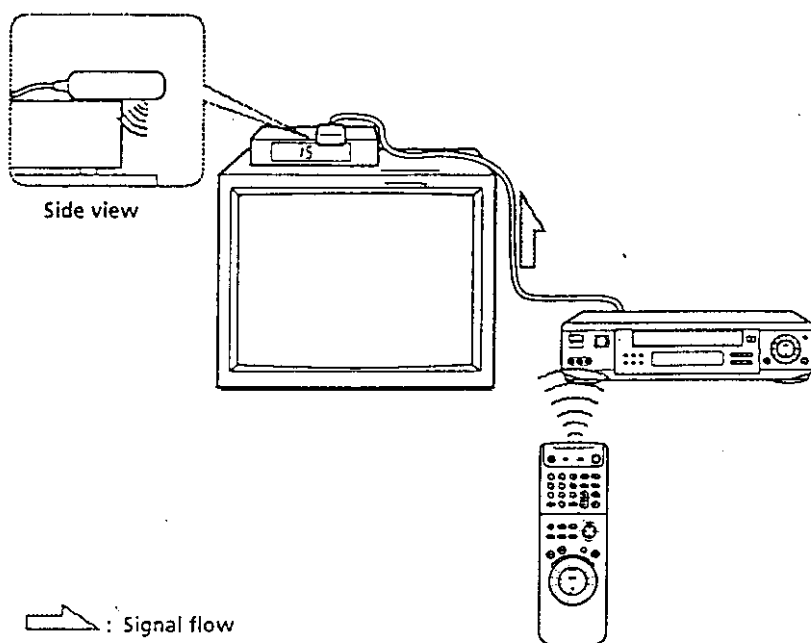

To check the cable box control setting

- 1 Press CH +/- on the remote commander. Does the channel indicator on the cable box/DSS receiver change? (Point the remote commander at the VCR, not at the cable box/DSS receiver.)
- 2 Press all 10 number buttons (0 to 9) on the remote commander. Does the channel indicator on the cable box/DSS receiver change?

If the answer to both 1 and 2 is "yes," you have made the correct setting.

continued

Setting up cable box control (continued)

If you cannot get your VCR to control the cable box/DSS receiver

- Check that the Cable Mouse is connected to the CABLE BOX CONTROL jack on the VCR.
- Check the position of the Cable Mouse.
- Place the cable box/DSS receiver and VCR away from each other. Do not place the cable box/DSS receiver on top of the VCR.
- Try the setup again making sure to use the correct control code. If the cable box still does not respond, try the other codes that are listed.

If your cable box still does not operate with the Cable Mouse, contact your cable company to see if they can provide you with a compatible cable box.

Note

- Make sure you turn off the VCR when you plug in or unplug the Cable Mouse. If you unplug the Cable Mouse and plug it in again, turn on the VCR before you use the cable box/DSS receiver control feature.

Presetting channels

(Skip this section if you are using cable box/DSS receiver control feature.)

This VCR is capable of receiving VHF channels 2 to 13, UHF channels 14 to 69 and unscrambled CATV channels 1 to 125. First, we recommend that you preset the receivable channels in your area using automatic presetting. Then, if there are any unwanted channels, disable them manually. If you have decided which channels you wish to preset, set them directly using manual presetting.

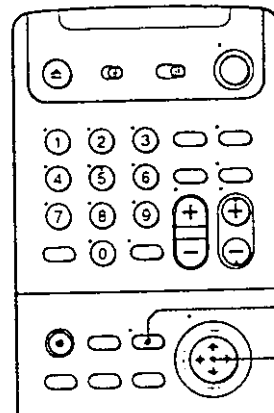

MENU

Cursor stick
↑/↓/←/→
OK

Before you start...

- Turn on the VCR and the TV.
- Set the TV to the VCR channel (channel 3 or 4). If your TV is connected to the VCR using A/V connections, set the TV to video input.
- Press TV/VIDEO to display the VIDEO indicator in the display window.

Presetting all receivable channels automatically

1

• MENU



Press MENU, then push the cursor stick to ↑/↓ to move the cursor to TUNER PRESET and press the cursor stick (OK).

• CURSOR



PUSH OK

When using the EASY SET UP procedure, skip this step.

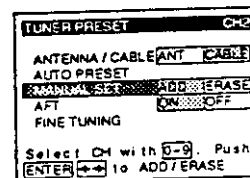

continued

Presetting channels (continued)

2 • CURSOR

 PUSH OK

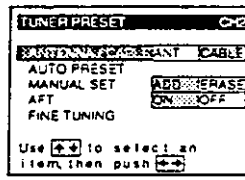
- To preset cable TV channels:
 Push the cursor stick to ←/→ to set ANTENNA/CABLE to CABLE.

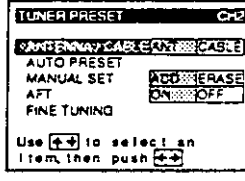

• To preset VHF and UHF channels:
 Push the cursor stick to ←/→ to set ANTENNA/CABLE to ANT.



3 • CURSOR

 PUSH OK

Push the cursor stick to ↑/↓ to select AUTO PRESET then press the cursor stick (OK).

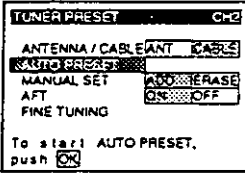
All receivable channels are preset in numerical sequence. When no more receivable channels can be found, presetting stops and the picture from the lowest numbered channel is displayed on the TV screen.



Tip

- When receiving a VHF, UHF, or CATV channel, the display changes as follows each time you press DISPLAY.

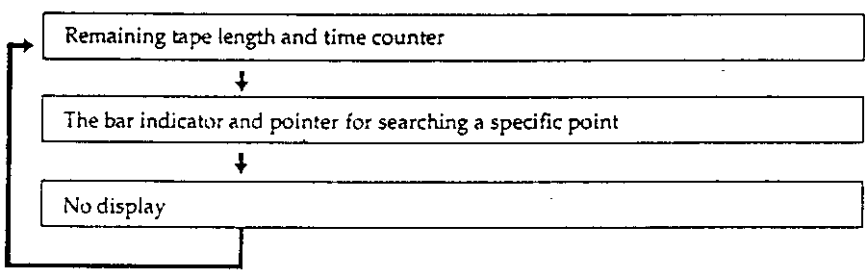

Presetting/disabling channels manually

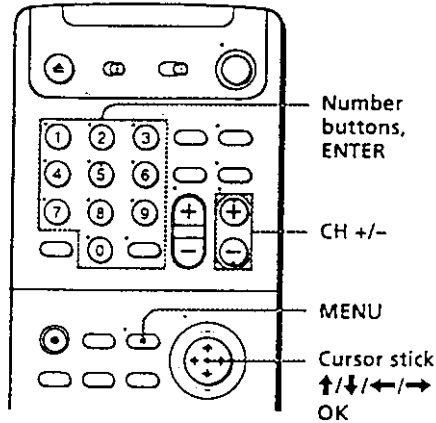

1



Press MENU and select TUNER PRESET, then press the cursor stick (OK).

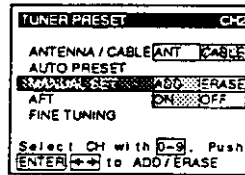

2



To preset a channel:
 1 Press the number buttons to enter the channel number, then press ENTER.
 2 Push the cursor stick to ←/→ to set MANUAL SET to ADD.

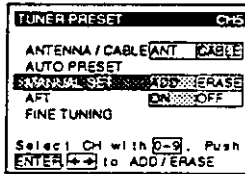

To disable a channel:
 1 Press CH +/- to select the channel number.
 2 Push the cursor stick to ←/→ to set MANUAL SET to ERASE.

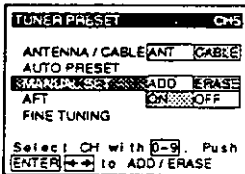

3



Repeat step 2 to preset or disable channels as required, then press the cursor stick (OK).

continued

Presetting channels (continued)

If the picture is not clear

Normally, the Auto Fine Tuning (AFT) function automatically tunes in channels clearly. If, however, the picture of a channel is not clear, you can also use the manual tuning function.

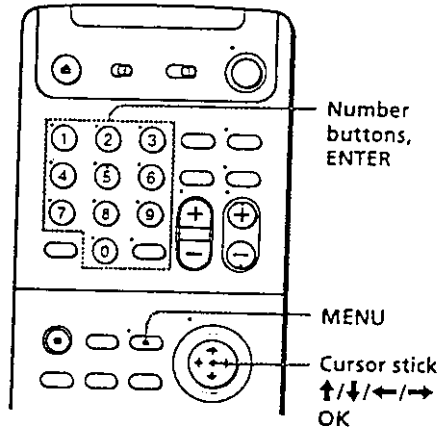

1



Press MENU and select TUNER PRESET, then press the cursor stick (OK).

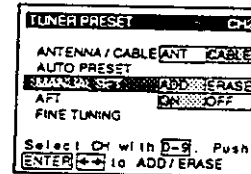

2

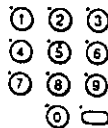

Press the number buttons to select the channel you want to fine-tune, then press ENTER.

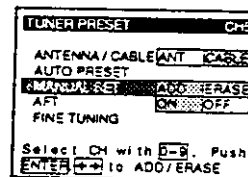

3



Push the cursor stick to ↑/↓ to select FINE TUNING.

The fine tuning meter appears.

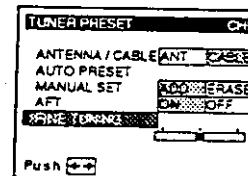

4



Push the cursor stick to ←/→ to adjust to a clearer picture.

Note that the AFT setting switches to OFF.

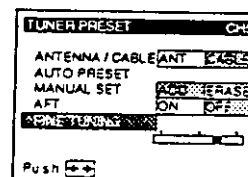

General setup information

Setting the RF unit

When connecting the VCR to the TV using only the antenna cable, you must set the RF UNIT switch on the rear of the VCR so that the TV can receive the correct signal from the VCR.

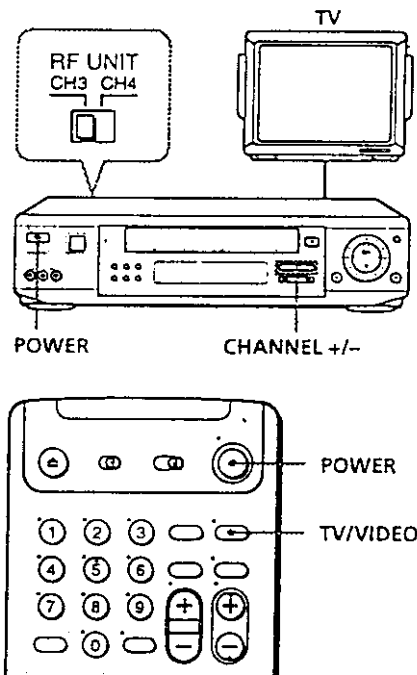

- 1 Set the RF UNIT switch on the rear of the VCR to CH 3 or CH 4, whichever channel is not used in your area. If both are used, set the switch to either channel.
- 2 Press POWER to turn on the VCR.
- 3 Press TV/VIDEO to turn on the VIDEO indicator in the display window.
- 4 Press CHANNEL +/- to display a channel number in the display window. Select an active channel number in your area.
- 5 Turn on your TV and set it to the channel you selected in step 1 (channel 3 or 4).

The selected TV channel broadcast appears on the TV screen. If the channels change when you press CHANNEL +/- on the VCR, you have made the correct setting.

Whenever you use the VCR, set the TV to the channel selected in step 1.

continued

General setup information (continued)

Attaching the external antenna connector

When using a 300-ohm twin lead cable for VHF/UHF antenna, use the EAC-32 antenna connector (not supplied) to connect the antenna to the VCR.

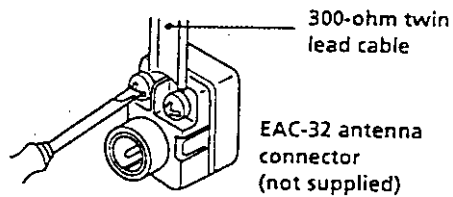

- 1 Loosen the screws on the antenna connector.
- 2 Wind the twin leads around the screws on the antenna connector.
- 3 Retighten the screws.

Attaching a UHF/VHF band mixer

When using both 75-ohm coaxial cable and 300-ohm twin lead cable for VHF/UHF antenna, use the EAC-66 UHF/VHF band separator/mixer (not supplied) to connect the antenna to the VCR.

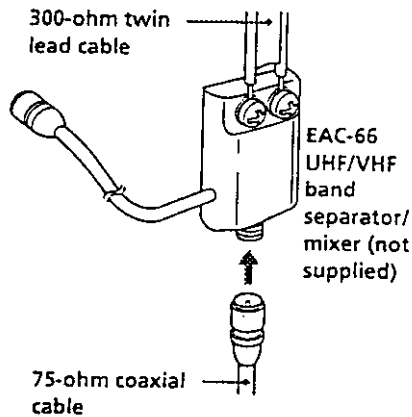

- 1 Loosen the screws on the mixer.
- 2 Wind the twin leads around the screws on the mixer.
- 3 Retighten the screws.
- 4 Connect the 75-ohm coaxial cable to the mixer.

Index to parts and controls

Refer to the pages indicated in parentheses () for details.

Front panel

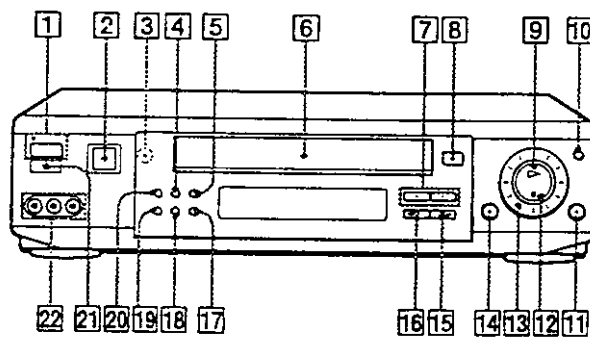

- | | |
|---|------------------------------------|
| 1 POWER switch/indicator (6, 43) | 12 ■ STOP button |
| 2 SmartFile sensor | 13 Shuttle ring |
| 3 SMARTFILE indicator | 14 PAUSE button |
| 4 INPUT SELECT button (30) | 15 ►► FF (fast forward) button |
| 5 EASY SET UP button (12, 15, 18, 21, 24, 27) | 16 ◀◀ REW (rewind) button |
| 6 Tape compartment | 17 COMMAND MODE button (6) |
| 7 CHANNEL/TRACKING +/- buttons (43) | 18 OK button (29) |
| 8 ▲ EJECT button | 19 CURSOR ↓ button |
| 9 ▷ PLAY button | 20 SMARTFILE button |
| 10 JOG button/indicator | 21 Remote sensor (5) |
| 11 ● REC (record) button | 22 LINE-2 IN VIDEO/AUDIO L/R jacks |

continued

Index to parts and controls (continued)

Display window.

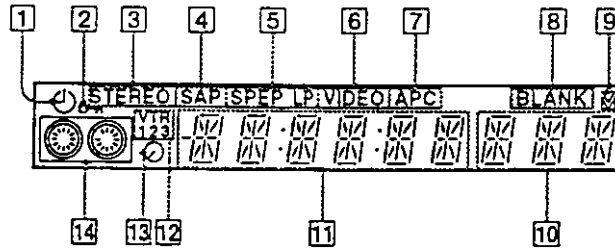

- | | |
|--|--------------------------------|
| 1 Timer indicator | 8 BLANK indicator |
| 2 Child Lock indicator | 9 Tracking indicator |
| 3 STEREO indicator | 10 Line/channel indicator (30) |
| 4 SAP (Second Audio Program) indicator | 11 Time counter/clock |
| 5 Tape speed indicator | 12 Command mode indicator (6) |
| 6 VIDEO indicator (30, 43) | 13 Remaining time indicator |
| 7 APC (Adaptive Picture Control) indicator | 14 Tape/recording indicator |

Rear panel

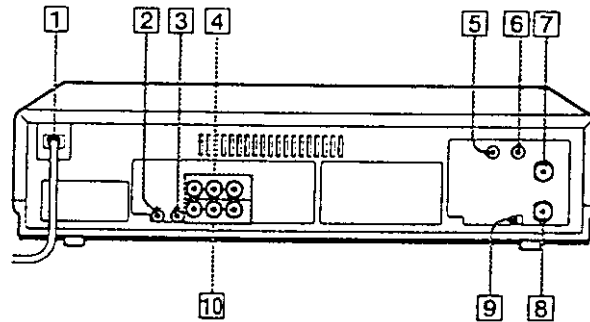

- | | |
|---|--|
| 1 AC power cord (8) | 7 VHF/UHF IN connector (11, 14, 17, 20, 23, 26) |
| 2 S LINK (CONTROL S IN) jack (10) | 8 VHF/UHF OUT connector (11, 14, 17, 20, 23, 26) |
| 3 CABLE BOX CONTROL (CONTROL S OUT) jack (11, 23) | 9 RF (Radio Frequency) UNIT switch (43) |
| 4 LINE-1 IN AUDIO L/R/VIDEO jacks (23) | 10 LINE OUT AUDIO L/R/VIDEO jacks (9) |
| 5 CPD (Control and Program Data) IN jack | |
| 6 G-Link jack* | |

continued

* This jack is provided for future expected functions.

Index to parts and controls (continued)

Remote commander

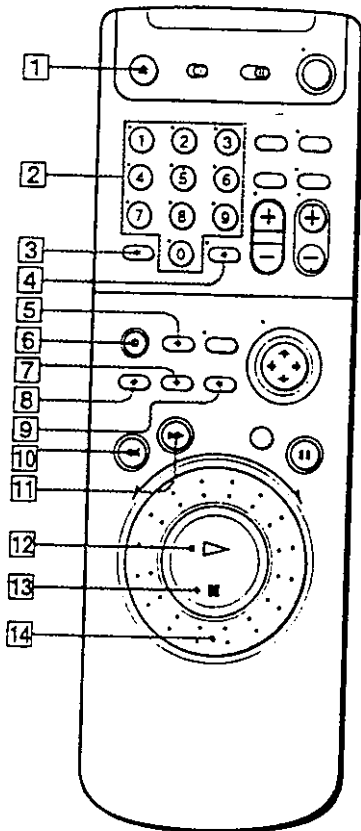

- 1 ▲ EJECT button
- 2 Number buttons (6, 35, 41)
- 3 SET button
- 4 ENTER button (41)
- 5 SMARTFILE button
- 6 ● REC (record) button
- 7 Blue button
- 8 GUIDE button
- 9 Green button
- 10 ◀ REW (rewind) button
- 11 ▶▶ FF (fast forward) button
- 12 ▷ PLAY button
- 13 ■ STOP button
- 14 Shuttle ring

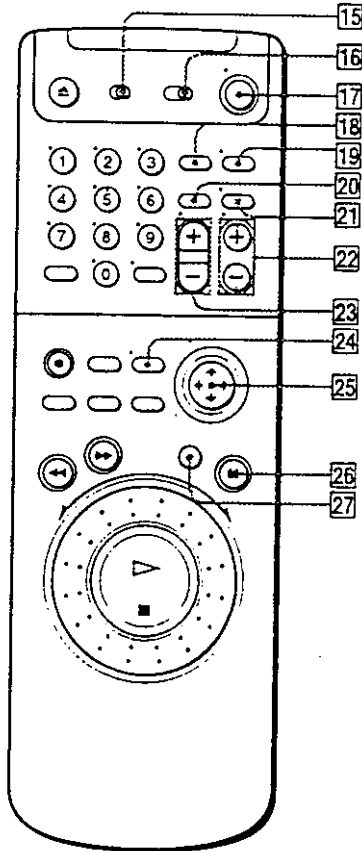

- 15 TV/VIDEO switch (5, 6)
- 16 COMMAND MODE switch (6)
- 17 POWER switch (6, 43)
- 18 VCR Plus+ button
- 19 TV/VIDEO button (6, 30, 43)
- 20 CLEAR button
- 21 DISPLAY button (40)
- 22 CH (channel) +/- buttons (6, 37, 41)
- 23 VOL (volume) +/- buttons (6)
- 24 MENU button (29)
- 25 Cursor stick (29)
↑/↓/←/→
OK
- 26 || PAUSE button
- 27 JOG button/indicator

continued

Index to parts and controls (continued)

Remote commander, with top cover opened

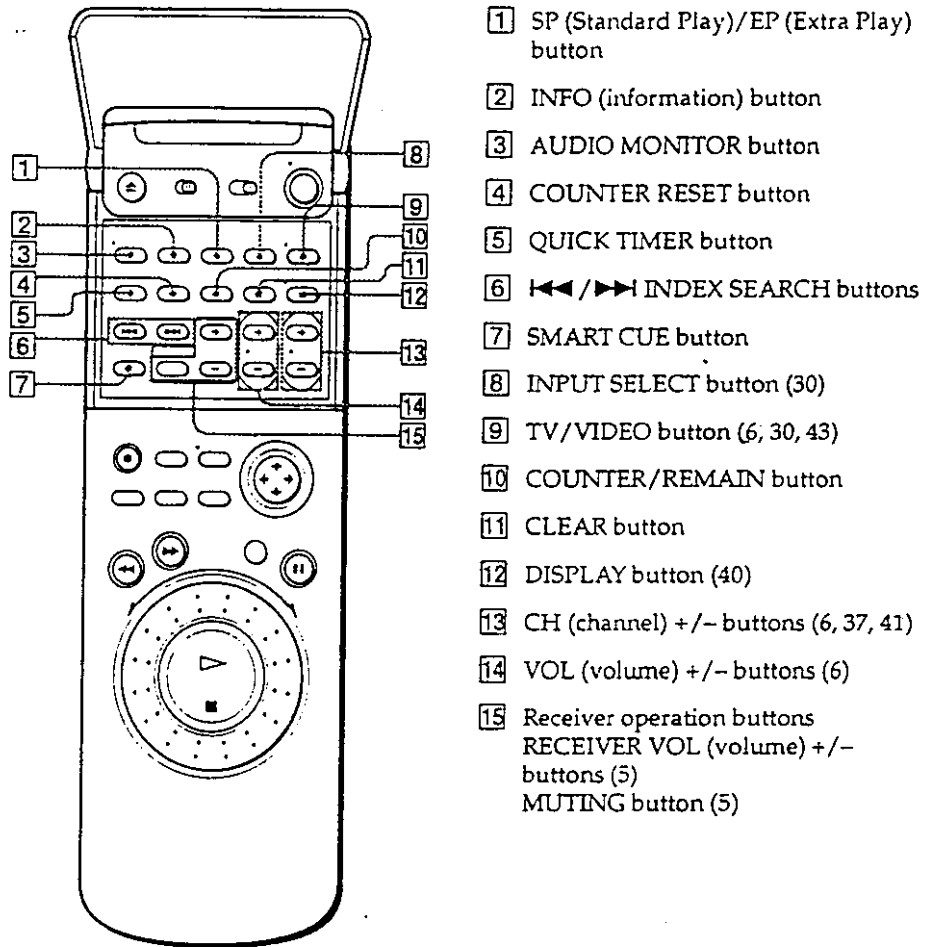



Index

A, B

Accessories supplied 4
AFT (Auto Fine Tuning) 42
Antenna hookup 17
Audio/video (A/V)
hookup 9
Auto Clock Set feature 30

C

Cable Box Control
cable box code number
chart 35
setting 34
Cable hookup 11
Cable Mouse 34
Clock setting 30
Connecting
cable TV 11
external antenna
connector 44
UHF/VHF band
mixer 44

D

Disabling channels 41
DSS (Digital Satellite System)
23

E, F, G, H, I, J, K

Easy Set Up 12, 15, 18, 21,
24, 27

L, M, N, O

Language selecting 29

P, Q, R

Presetting channels 39

S, T, U, V, W, X, Y, Z

S-Link™ 10