

Video Cassette Recorder

Hookup/Setup

VHS

Hi-Fi

VCR^{plus}
GOLD

SLV-M91HF

Precautions

Safety

- Operate the unit only on 120 V AC, 60 Hz.
- If anything falls into the cabinet, unplug the unit and have it checked by qualified personnel before operating it any further.
- This unit is not disconnected from the AC power source (mains) as long as it is connected to the wall outlet, even if the unit itself has been turned off.
- Unplug the unit from the wall outlet if you do not intend to use it for an extended period of time. To disconnect the cord, pull it out by the plug, never by the cord.
- One blade of the plug is wider than the other for the purpose of safety and will fit into the power outlet only one way. If you are unable to insert the plug fully into the outlet, contact your Sony dealer.

Installing

- Allow adequate air circulation to prevent internal heat buildup.
- Do not place the unit on surfaces (rugs, blankets, etc.) or near materials (curtains, draperies) that may block the ventilation slots.
- Do not install the unit near heat sources such as radiators or air ducts, or in a place subject to direct sunlight, excessive dust, mechanical vibration or shock.
- Do not install the unit in an inclined position. It is designed to be operated in a horizontal position only.
- Keep the unit and cassettes away from equipment with strong magnets, such as microwave ovens or large loudspeakers.
- Do not place heavy objects on the unit.
- If the unit is brought directly from a cold to a warm location, moisture may condense inside the VCR and cause damage to the video head and tape. When you first install the unit, or when you move it from a cold to a warm location, wait for about three hours before operating the unit.

Table of contents

4	Step 1: Unpacking
5	Step 2: Setting up the remote commander
8	Step 3: Hookups
9	Audio/video (A/V) hookup
11	Hookup 1: Using cable box control
15	Hookup 2: No cable box, or incompatible cable box with only a few scrambled channels
19	Hookup 3: Antenna hookup
23	Hookup 4: Incompatible cable box with many scrambled channels
27	Hookup 5: DIRECTV digital satellite receiver
30	Hookup 6: Incompatible cable box with only a few scrambled channels, using an A/B switch
35	Selecting a language
36	Setting the clock
42	Setting up the cable box control
47	Presetting channels
53	Setting up the VCR Plus+* GOLD system
58	General setup information
60	Index to parts and controls
	back cover
	Index

* VCR Plus+, C³, ALLSET and PlusCode are trademarks of Gemstar Development Corporation. The VCR Plus+ system is manufactured under license from Gemstar Development Corporation.

Step 1

Unpacking

Check that you have received the following items with the VCR:

- Remote commander

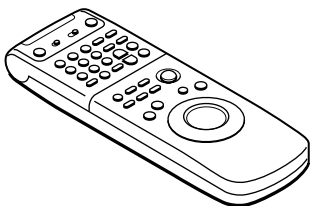

- Cable Mouse (cable box controller)

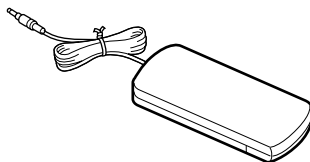

- Size AA (R6) batteries

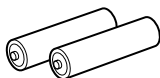

- 75-ohm coaxial cable with F-type connectors

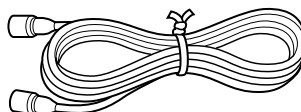

- Audio/video cable (3-phono, 1-mini to 3-phono, 1-mini)

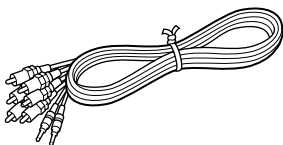

- SmartFile labels

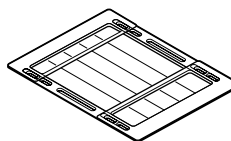

- Monaural cable (1-mini to 1-mini)

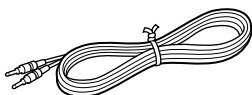

Step 2

Setting up the remote commander

Inserting the batteries

Insert two size AA (R6) batteries by matching the + and - on the batteries to the diagram inside the battery compartment.

Insert the negative (-) end first, then push in and down until the positive (+) end clicks into position.

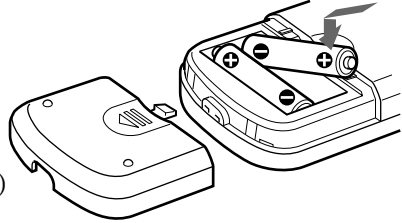

Using the remote commander

You can use this remote commander to operate this VCR and a Sony TV or AV receiver.

Buttons on the remote commander marked with a dot (•) can be used to operate your Sony TV.

The RECEIVER VOL +/- and MUTING buttons can be used to operate your Sony AV receiver.

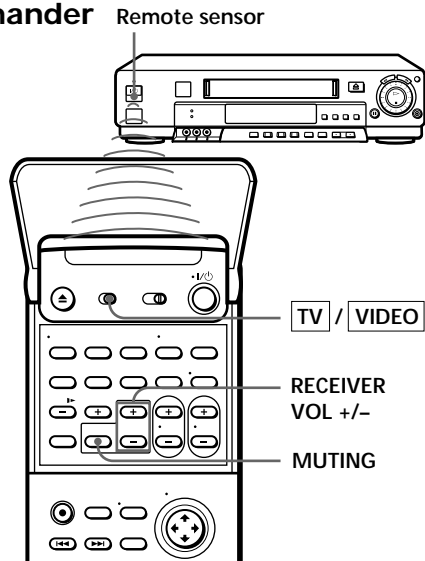

To operate	Set TV / VIDEO to
the VCR	VIDEO and point at the remote sensor on the VCR
a Sony TV	TV and point at the remote sensor on the TV

continued

Step 2: Setting up the remote commander (continued)

Notes

- With normal use, the batteries should last about three to six months.
- If you do not use the remote commander for an extended period of time, remove the batteries to avoid possible damage from battery leakage.
- Do not use a new battery with an old one.
- Do not use different types of batteries.
- Some Sony AV receivers may not be operated with the remote commander.

Setting the COMMAND MODE switch

To remotely control the VCR with the remote commander, set COMMAND MODE on the remote commander to the same position as that on the VCR. Usually set to VTR 3. Change the position as shown below to control other Sony VCRs:

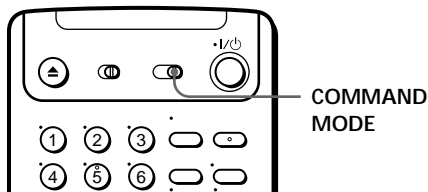

VTR 1: For Sony Betamax format VCRs

VTR 2: For Sony 8mm format VCRs

VTR 3: For Sony VHS format VCRs

To change the command mode position of the VCR, press and hold COMMAND MODE on the VCR for two seconds and repeat until the desired position appears in the display window.

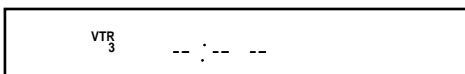
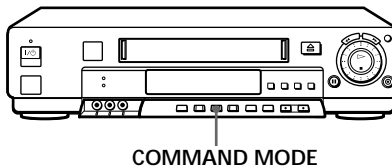

Controlling other TVs with the remote commander

The remote commander is preprogrammed to control non-Sony TVs. If your TV is listed in the table below, set the appropriate manufacturer's code number.

- 1 Set **TV**/**VIDEO** at the top of the remote commander to **TV**.
- 2 Hold down **I/⏻**, and enter your TV's code number(s) using the number buttons. Then release **I/⏻**.

Now you can use the **I/⏻**, **VOL +/-**, **CH +/-**, and **TV/VIDEO** buttons to control your TV. You can also use the buttons marked with a dot (●) to control a Sony TV. To control the VCR, reset **TV**/**VIDEO** to **VIDEO**.

Code numbers of controllable TVs

If more than one code number is listed, try entering them one at a time until you find the one that works with your TV.

Manufacturer	Code number	Manufacturer	Code number	Manufacturer	Code number
Sony	01	JVC	09	RCA	04, 10
Akai	04	KMC	03	Sampo	12
AOC	04	Magnavox	03, 08, 12	Sanyo	11
Centurion	12	Marantz	04, 13	Scott	12
Coronado	03	MGA/Mitsubishi	04, 12, 13, 17	Sears	07, 10, 11
Curis-Mathes	12	NEC	04, 12	Sharp	03, 05, 18
Daytron	12	Panasonic	06, 19	Sylvania	08, 12
Emerson	03, 04, 14	Philco	03, 04	Teknika	03, 08, 14
Fisher	11	Philips	08	Toshiba	07
General Electric	06, 10	Pioneer	16	Wards	03, 04, 12
Gold Star	03, 04, 17	Portland	03	Yorx	12
Hitachi	02, 03	Quasar	06, 18	Zenith	15
J.C.Penny	04, 12	Radio Shack	05, 14		

Notes

- If the TV uses a different remote control system from the one programmed to work with the VCR, you cannot control your TV with the remote commander.
- If you enter a new code number, the code number previously entered will be erased.
- When you replace the batteries of the remote commander, the code number may change. Set the appropriate code number every time you replace the batteries.

Step 3

Hookups

Selecting the best hookup option

There are many ways in which your VCR can be hooked up. To hook up your VCR so that it works best for you, first scan through the table below. Then use the accompanying diagrams and procedures on the following pages to set up your VCR.

If you have	Use	Refer to
TV that has audio/video inputs	Audio/video (A/V) hookup , then follow one of the hookups below.	Pages 9 and 10
Cable box that is compatible with the VCR's cable box control feature	Hookup 1	Pages 11 to 14
No cable box or incompatible cable box with only a few scrambled channels	Hookup 2	Pages 15 to 18
Antenna only, no cable TV	Hookup 3	Pages 19 to 22
Incompatible cable box with many scrambled channels	Hookup 4	Pages 23 to 26
DIRECTV* digital satellite receiver	Hookup 5	Pages 27 to 29
Incompatible cable box with only a few scrambled channels, using an A/B switch	Hookup 6	Pages 30 to 34

After you've completed the connections, follow the instructions for setup. During setup, if you need more details on the procedure described, page numbers are provided where you can find complete, step-by-step instructions.

After you've completed the setup, you're ready to use your VCR. Procedures differ depending on the hookup you used. For an overview, refer to "Quick reference to using the VCR" on the back cover of the supplied operating instructions.

Before you get started

- Turn off the power to all equipment.
- Do not connect the AC power cords until all of the connections are completed.
- Be sure you make connections firmly. Loose connections may cause picture distortion.
- If your TV doesn't match any of the examples provided, see your nearest Sony dealer or qualified technician.

* DIRECTV is a trademark of DIRECTV, Inc., a unit of Hughes Electronics Corporation.

If your TV has audio/video (A/V) input jacks, you will get a better picture and sound if you hook up your VCR using these connections. In addition, for a true “home theater” experience, you should connect the audio outputs of your VCR or TV to your stereo system. If your TV doesn’t have A/V inputs, see the following pages for antenna or cable hookups.

If your TV has the S-Link™* (A/V bus control) function, hook up your VCR using the connection shown on page 10. Your TV will automatically switch to the A/V inputs for your VCR when you play back or operate menu on the VCR.

If you’re not planning to use your VCR to record programs, you’re finished setting up the VCR after you’ve made the connections shown on pages 9 and 10. If you want to record off-air or off your cable TV system, complete these connections first, and then go to the following pages for antenna or cable hookups.

* S-Link™ is a trademark of Sony Corporation.

A Use this hookup if your TV has stereo jacks

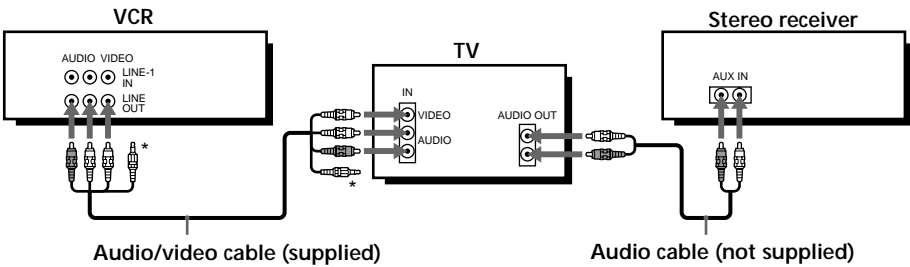

* Do not connect the miniplugs for this hookup.

B Use this hookup if your TV doesn't have stereo jacks

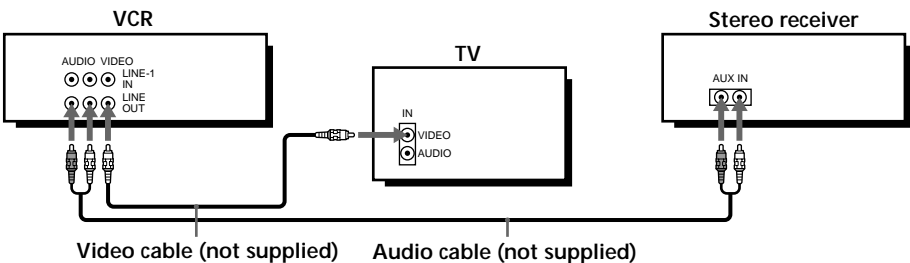

continued

Step 3: Hookups (continued)

C Use this hookup if your TV has the S-Link™ function

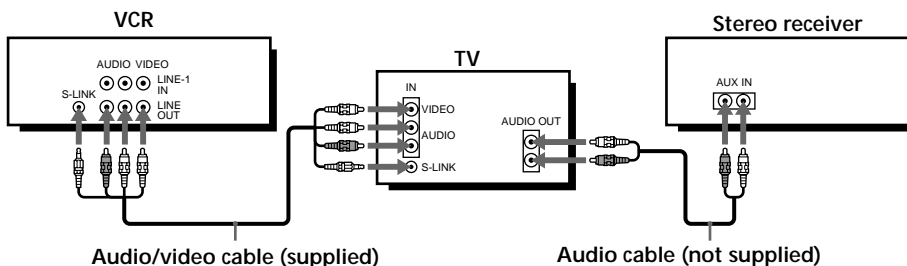

Note

- To play a tape in stereo, you must use the A/V connection.

A/V hookup: VCR setup

After you've connected your TV and completed antenna or cable hookup, use the following procedure to set up the VCR.

Press **MENU** and select **ADVANCED OPTIONS**.

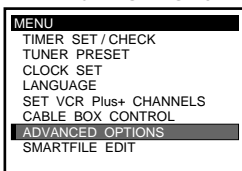

Set **AUTO ANT SEL** to **OFF** and push the cursor stick (**OK**).

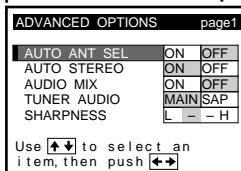

For details, see page 32 of the supplied operating instructions.

Caution

Connections between the VCR's VHF/UHF connector and the antenna terminals of the TV receiver should be made only as shown in the following instructions. Failure to do so may result in operation that violates the regulations of the Federal Communications Commission regarding the use and operation of RF devices. Never connect the output of the VCR to an antenna or make simultaneous (parallel) antenna and VCR connections at the antenna terminals of your receiver.

Note to CATV system installer (in USA)

This reminder is provided to call the CATV system installer's attention to Article 820-40 of the NEC that provides guidelines for proper grounding and, in particular, specifies that the cable ground shall be connected to the grounding system of the building, as close to the point of cable entry as practical.

Using cable box control

Recommended use

You should use this hookup if you have a cable box, especially if your cable system scrambles all or most channels. This hookup allows the VCR's cable box control feature to control the channel on the cable box, simplifying the recording process. A list of compatible cable boxes is on pages 43 to 45.

What you can do with this hookup

- Record any channel using the VCR's cable box control feature to select channels on the cable box

What you can't do

- Record with the cable box turned off
- Record one channel while watching another channel

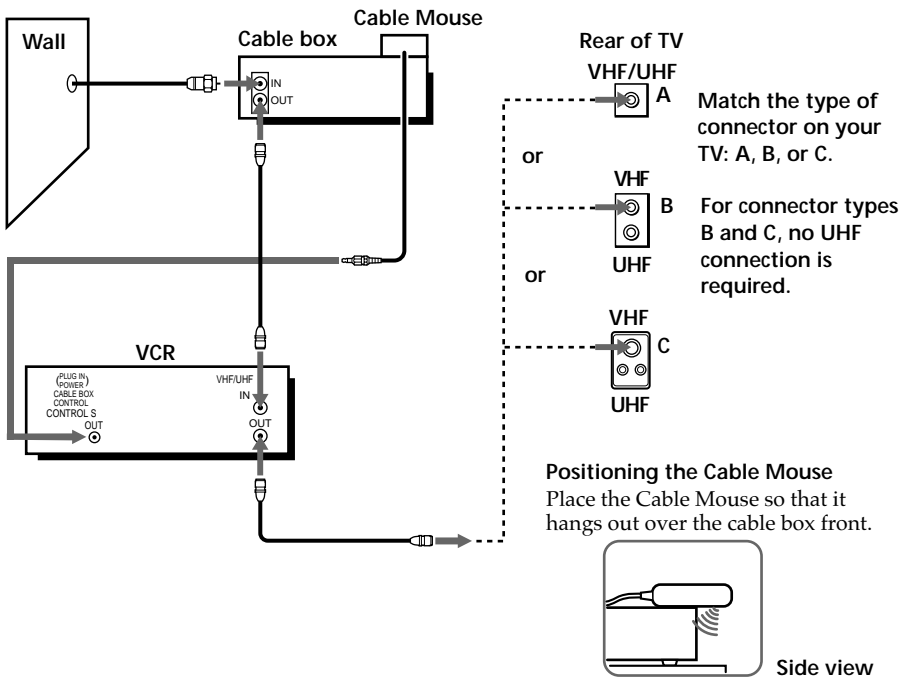

continued

Step 3: Hookups (continued)

Hookup 1: VCR setup

- 1 Set the RF UNIT switch to CH3 or CH4, whichever channel is not used in your area. If both are used, set the switch to either channel. For details, see page 58. If you made A/V connections (from page 9), you can skip this step.
- 2 Turn on your cable box.
- 3 Press EASY SET UP on the VCR.

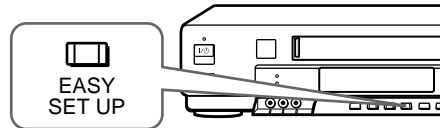
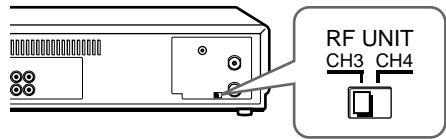

- 1 The LANGUAGE menu appears. Change the on-screen display language to Spanish (ESPAÑOL) or French (FRANÇAIS) if desired, and push the cursor stick (OK). For details, see page 35.
- 2 The CLOCK SET menu appears. Select AUTO and push the cursor stick (OK). For details, see page 37.
- 3 The SMART CH MAPPING menu appears. Move the cursor stick $\uparrow/\downarrow/\leftarrow/\rightarrow$ to enter the ZIP/POSTAL CODE in your area and push the cursor stick (OK). (You can also use the number buttons to enter the ZIP/POSTAL CODE.)
- 4 The CABLE BOX menu appears. Select ON. For details, see page 43.

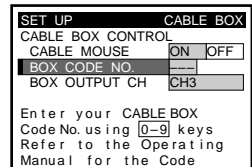
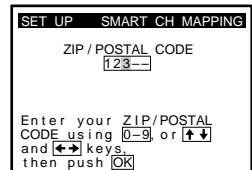
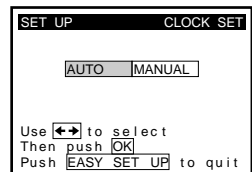
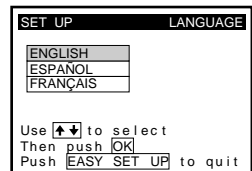

- 5 Enter your cable box code number and move the cursor stick ↓. For details, see page 43.

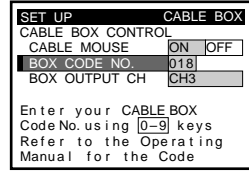

- 6 Select your cable box output channel and push the cursor stick (OK).

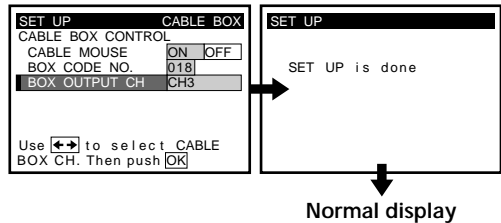

Hookup 1: The VCR Plus+ GOLD system channel setup

- 1 Press MENU, then select SET VCR Plus+ CHANNELS and push the cursor stick (OK).
- 2 Select AUTO and push the cursor stick (OK).
- 3 Press I/⏻ to turn off the VCR.

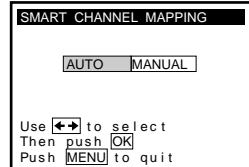
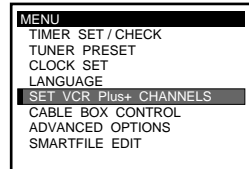

The VCR receives the program information signal from 0:00 am to 5:00 am while the VCR is turned off, and set up the channel for the VCR Plus+ GOLD system recording. After channel setup is finished, you can record TV programs using the VCR Plus+ GOLD system. For details, see page 54.

continued

Step 3: Hookups (continued)

Notes

- To use the Smart Channel Mapping feature, leave the cable box on.
- It takes about 1 hour to complete channel setup.
- The VCR can receive the program information signal only while the VCR is turned off and no timer recordings are set.
- If the channels in your area don't carry the program information signals, set the program guide channels manually. For details, see page 56.
- If the Choose your Cable CH MAP menu appears the first time you turn on the VCR after finishing channel setup, select the MAP number. For details, see page 55.

Automatic clock setting

Once you've set up the VCR, it automatically sets the clock the first time you turn off the VCR. After that, whenever you turn off the VCR, it checks the time and adjusts the clock, even for Daylight Saving Time. The VCR sets the clock by picking up a time signal provided by some TV channels.

If you want to use the timer to record right away, or if the channels in your area do not carry time signals, set the clock manually. For details, see page 40.

Note

- To use the Auto Clock Set feature, leave the cable box on.

No cable box, or incompatible cable box with only a few scrambled channels

Recommended use

Use this hookup if you do not have a cable box. Also use this hookup if your cable company cannot supply a cable box that is compatible with the VCR's cable box control feature, and your cable system scrambles only a few channels.

What you can do with this hookup

- Record any unscrambled channel by selecting the channel on the VCR

What you can't do

- Record scrambled channels that require a cable box

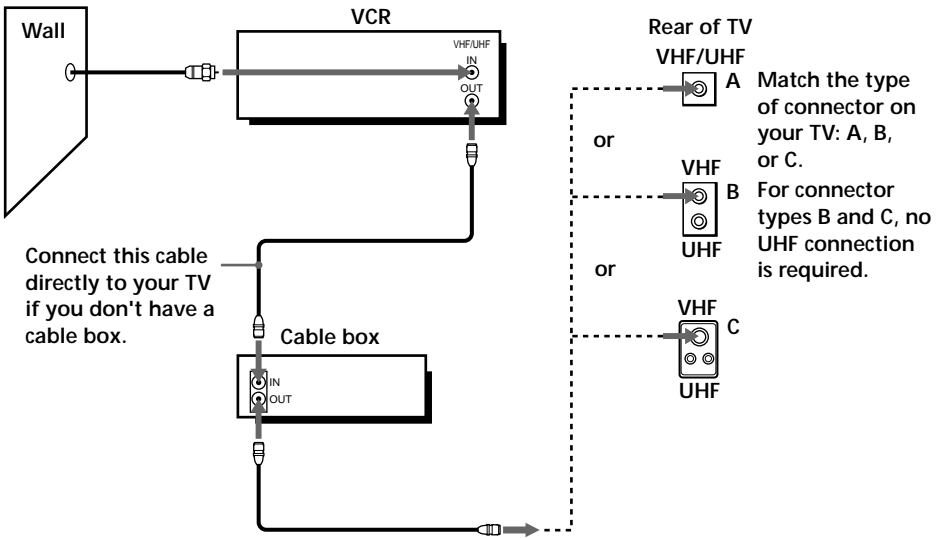

continued

Step 3: Hookups (continued)

Hookup 2: VCR setup

- 1 Set the RF UNIT switch to CH3 or CH4, whichever channel is not used in your area. If both are used, set the switch to either channel. For details, see page 58. If you made A/V connections (from page 9), you can skip this step.
- 2 Press EASY SET UP on the VCR.

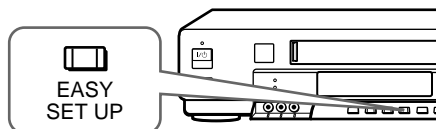
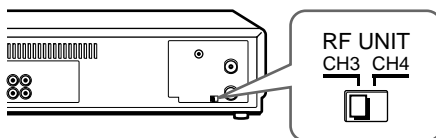

- 1 The LANGUAGE menu appears. Change the on-screen display language to Spanish (ESPAÑOL) or French (FRANÇAIS) if desired, and push the cursor stick (OK). For details, see page 35.
- 2 The CLOCK SET menu appears. Select AUTO and push the cursor stick (OK). For details, see page 37.
- 3 The SMART CH MAPPING menu appears. Move the cursor stick $\uparrow/\downarrow/\leftarrow/\rightarrow$ to enter the ZIP/POSTAL CODE in your area and push the cursor stick (OK). (You can also use the number buttons to enter the ZIP/POSTAL CODE.)
- 4 The CABLE BOX menu appears. Select OFF and push the cursor stick (OK).

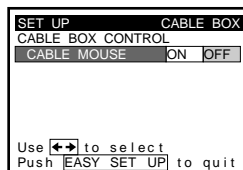
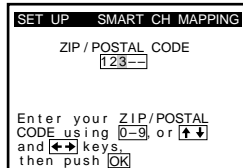
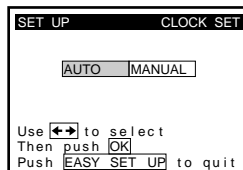
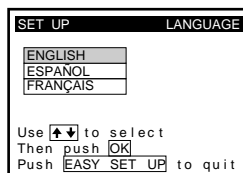

- The TUNER PRESET menu appears. Set ANTENNA/CABLE to CABLE and push the cursor stick (OK). For details, see page 48.

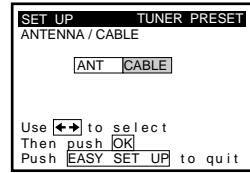

- The AUTO PRESET starts.

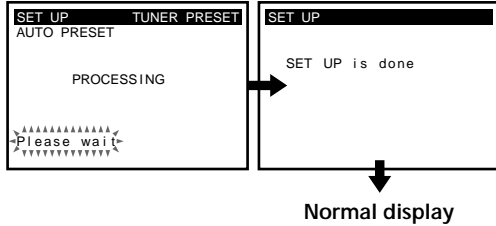

Hookup 2: The VCR Plus+ GOLD system channel setup

- Press MENU, then select SET VCR Plus+ CHANNELS and push the cursor stick (OK).
- Select AUTO and push the cursor stick (OK).
- Press I/⏻ to turn off the VCR.

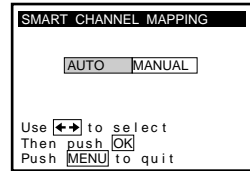
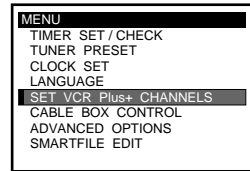

The VCR receives the program information signal from 0:00 am to 5:00 am while the VCR is turned off, and set up the channel for the VCR Plus+ GOLD system recording. After channel setup is finished, you can record TV programs using the VCR Plus+ GOLD system. For details, see page 54.

continued

Step 3: Hookups (continued)

Notes

- It takes about 1 hour to complete channel setup.
- The VCR can receive the program information signal only while the VCR is turned off and no timer recordings are set.
- If the channels in your area don't carry the program information signals, set the program guide channels manually. For details, see page 56.
- If the Choose your Cable CH MAP menu appears the first time you turn on the VCR after finishing channel setup, select the MAP number. For details, see page 55.

Automatic clock setting

Once you've set up the VCR, it automatically sets the clock the first time you turn off the VCR. After that, whenever you turn off the VCR, it checks the time and adjusts the clock, even for Daylight Saving Time. The VCR sets the clock by picking up a time signal provided by some TV channels.

If you want to use the timer to record right away, or if the channels in your area do not carry time signals, set the clock manually. For details, see page 40.

Antenna hookup

Make the following connections if you're using an antenna (if you don't have cable TV).

A Use this hookup if you're using:

- VHF/UHF antenna (you get channels 2–13 and channels 14 and higher)
- UHF-only antenna (you get channels 14 and higher)
- Separate VHF and UHF antennas

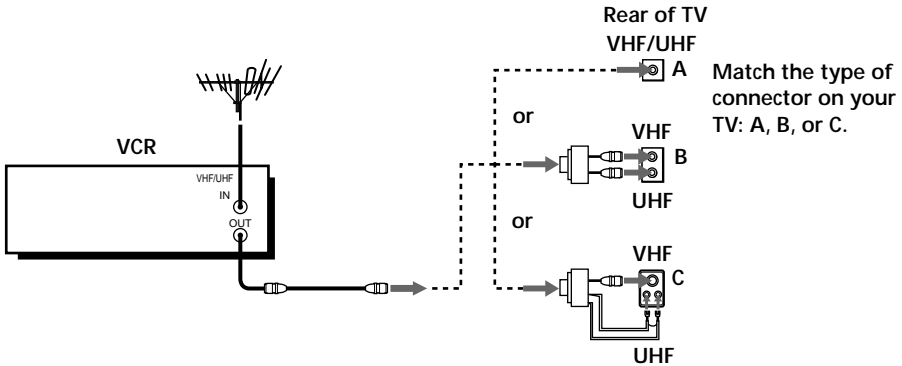

B Use this hookup if you're using a VHF-only antenna (you get channels 2–13 only)

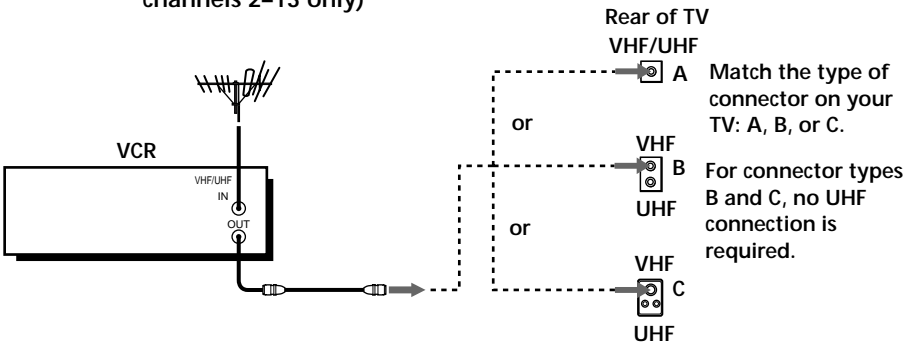

If you cannot connect your antenna cable to the VCR directly

If your antenna cable is a flat cable (300-ohm twin lead cable), attach an external antenna connector (not supplied) so you can connect the cable to the VHF/UHF IN connector. If you have separate cables for VHF and UHF antennas, you should use a U/V band mixer (not supplied). For details, see page 59.

continued

Step 3: Hookups (continued)

Hookup 3: VCR setup

- 1 Set the RF UNIT switch to CH3 or CH4, whichever channel is not used in your area. If both are used, set the switch to either channel. For details, see page 58. If you made A/V connections (from page 9), you can skip this step.
- 2 Press EASY SET UP on the VCR.

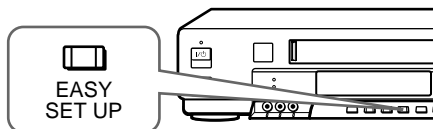
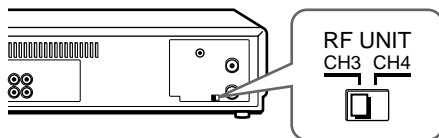

- 1 The LANGUAGE menu appears. Change the on-screen display language to Spanish (ESPAÑOL) or French (FRANÇAIS) if desired, and push the cursor stick (OK). For details, see page 35.
- 2 The CLOCK SET menu appears. Select AUTO and push the cursor stick (OK). For details, see page 37.
- 3 The SMART CH MAPPING menu appears. Move the cursor stick $\uparrow/\downarrow/\leftarrow/\rightarrow$ to enter the ZIP/POSTAL CODE in your area and push the cursor stick (OK). (You can also use the number buttons to enter the ZIP/POSTAL CODE.)
- 4 The CABLE BOX menu appears. Select OFF and push the cursor stick (OK).

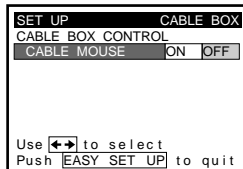
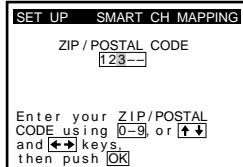
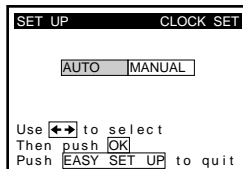
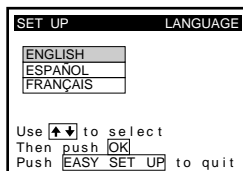

- The TUNER PRESET menu appears. Set ANTENNA/CABLE to ANT and push the cursor stick (OK). For details, see page 48.

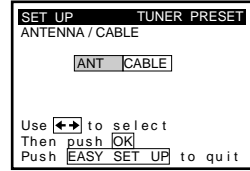

- The AUTO PRESET starts.

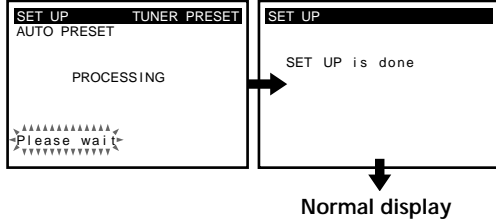

Hookup 3: The VCR Plus+ GOLD system channel setup

- Press MENU, then select SET VCR Plus+ CHANNELS and push the cursor stick (OK).
- Select AUTO and push the cursor stick (OK).
- Press I/O to turn off the VCR.

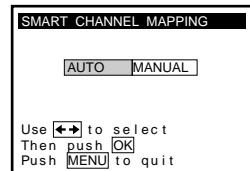
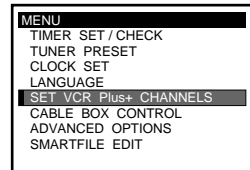

The VCR receives the program information signal from 0:00 am to 5:00 am while the VCR is turned off, and set up the channel for the VCR Plus+ GOLD system recording. After channel setup is finished, you can record TV programs using the VCR Plus+ GOLD system. For details, see page 54.

continued

Step 3: Hookups (continued)

Notes

- It takes about 1 hour to complete channel setup.
- The VCR can receive the program information signal only while the VCR is turned off and no timer recordings are set.
- If the channels in your area don't carry the program information signals, set the program guide channels manually. For details, see page 56.
- If the Choose your Cable CH MAP menu appears the first time you turn on the VCR after finishing channel setup, select the MAP number. For details, see page 55.

Automatic clock setting

Once you've set up the VCR, it automatically sets the clock the first time you turn off the VCR. After that, whenever you turn off the VCR, it checks the time and adjusts the clock, even for Daylight Saving Time. The VCR sets the clock by picking up a time signal provided by some TV channels.

If you want to use the timer to record right away, or if the channels in your area do not carry time signals, set the clock manually. For details, see page 40.

Incompatible cable box with many scrambled channels

Recommended use

Use this hookup if your cable company cannot supply a cable box that is compatible with the VCR's cable box control feature, and your cable system scrambles all or most channels.

What you can do with this hookup

- Record any channel by selecting the channel on the cable box

What you can't do

- Record with the cable box turned off
- Record one channel while watching another channel

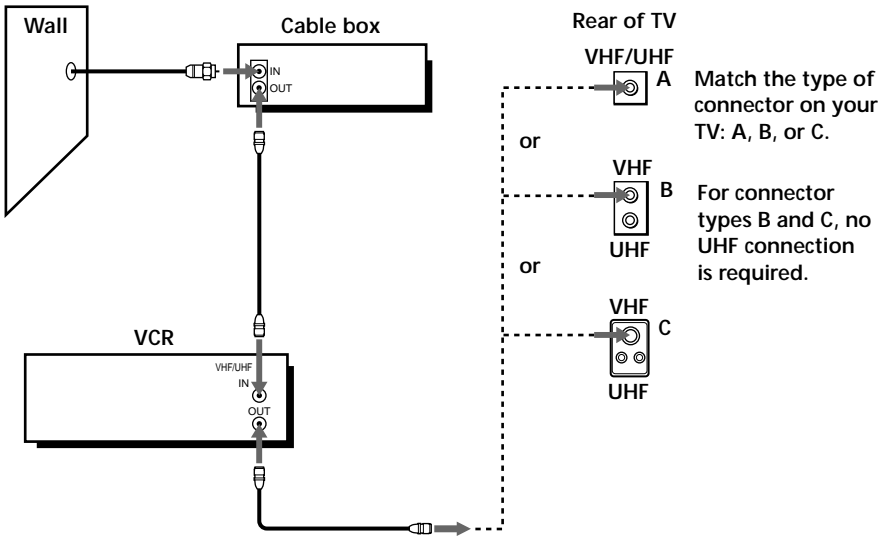

continued

Step 3: Hookups (continued)

Hookup 4: VCR setup

- 1 Set the RF UNIT switch to CH3 or CH4, whichever channel is not used in your area. If both are used, set the switch to either channel. For details, see page 58. If you made A/V connections (from page 9), you can skip this step.
- 2 Turn on your cable box.
- 3 Press EASY SET UP on the VCR.

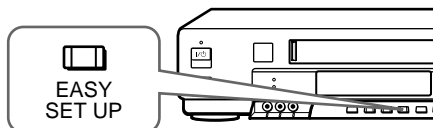
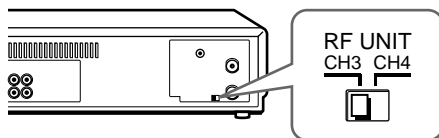

- 1 The LANGUAGE menu appears. Change the on-screen display language to Spanish (ESPAÑOL) or French (FRANÇAIS) if desired, and push the cursor stick (OK). For details, see page 35.
- 2 The CLOCK SET menu appears. Select MANUAL and push the cursor stick (OK). Then set the clock manually and push the cursor stick (OK). For details, see page 41.
- 3 The SMART CH MAPPING menu appears. Move the cursor stick $\uparrow/\downarrow/\leftarrow/\rightarrow$ to enter the ZIP/POSTAL CODE in your area and push the cursor stick (OK). (You can also use the number buttons to enter the ZIP/POSTAL CODE.)
- 4 The CABLE BOX menu appears. Select OFF and push the cursor stick (OK).

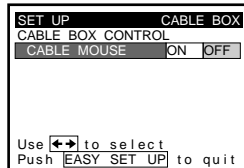
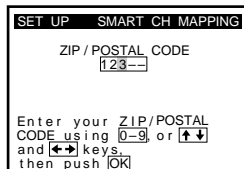
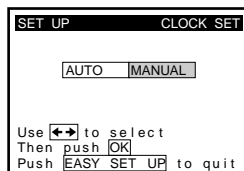
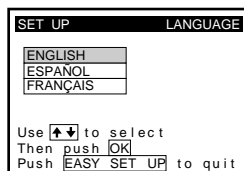

- The TUNER PRESET menu appears. Set ANTENNA/CABLE to ANT and push the cursor stick (OK). For details, see page 48.

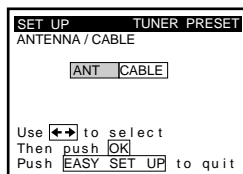

- The AUTO PRESET starts.

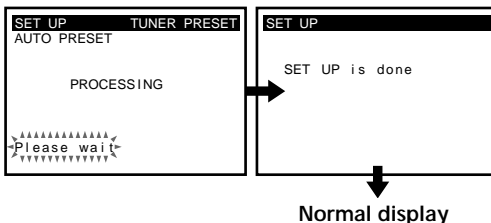

Hookup 4: The VCR Plus+ GOLD system channel setup

- Find the VCR Plus+ GOLD system Channel Line-up Chart in your program guide. For details, see page 53.
- Enter all the channels you want to record and the cable box output channel (usually 2, 3, or 4). For details, see page 56.

- Press MENU, then select SET VCR Plus+ CHANNELS and push the cursor stick (OK).

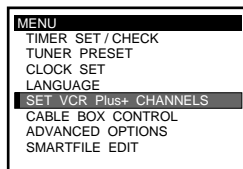

- Select MANUAL and push the cursor stick (OK).

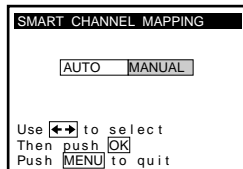

- Enter the program guide channel, then the cable box output channel.

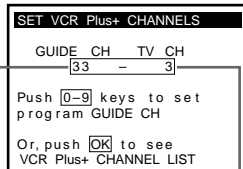

- Push the cursor stick (OK).

Program guide channel

- Press MENU to exit the menu.

Cable box output channel

continued

Step 3: Hookups (continued)

Automatic clock setting

To use the Auto Clock Set feature with this hookup, you need to manually select a channel that carries a time signal:

- 1** Tune the cable box to a channel that carries a time signal.
- 2** Select AUTO in the CLOCK SET menu to turn on the Auto Clock Set feature.
- 3** Turn off the VCR. It automatically sets the clock and adjusts for Daylight Saving Time by picking up the time signal.

If you want to use the timer to record right away, or if the channels in your area do not carry time signals, set the clock manually. For details, see page40.

Note

- To use the Auto Clock Set feature, leave the cable box on.

DIRECTV digital satellite receiver

Recommended use

Use this hookup if you have a DIRECTV digital satellite receiver. It allows the VCR's cable box control feature to control the channel on the DIRECTV digital satellite receiver, simplifying the recording process. A list of compatible DIRECTV digital satellite receivers is on page 45.

The DIRECTV System is a satellite broadcast that provides superior digital-quality video and crisp digital-quality audio. A variety of program packages are available through your program providers. It also has program guides that are sorted by program categories.

What you can do with this hookup

- Record any channels using the VCR's cable box control feature to select channels on the DIRECTV digital satellite receiver

What you can't do

- Record with the DIRECTV digital satellite receiver turned off
- Record any channels from cable or an antenna
(To record channels from cable or an antenna, turn off the cable box control feature.)
- Use a cable box
- Record programs with the VCR Plus+ GOLD system

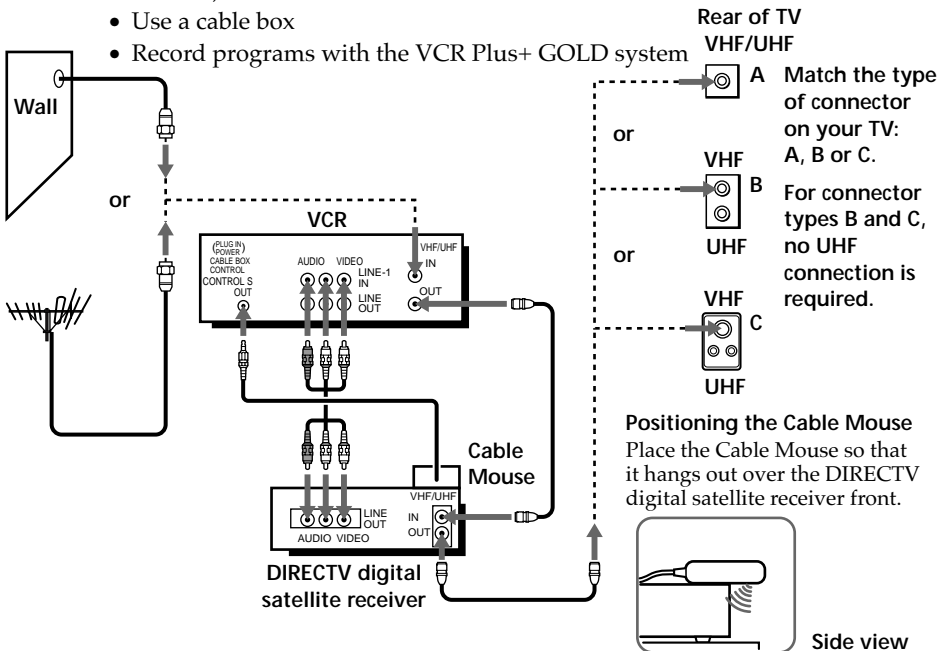

continued

Step 3: Hookups (continued)

Hookup 5: VCR setup

- 1 Set the RF UNIT switch to CH3 or CH4, whichever channel is not used in your area. If both are used, set the switch to either channel. For details, see page 58. If you made A/V connections (from page 9), you can skip this step.
- 2 Turn on your DIRECTV digital satellite receiver.
- 3 Press EASY SET UP on the VCR.

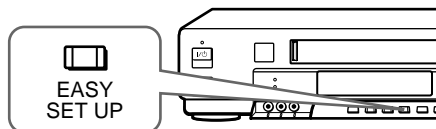
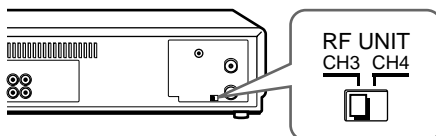

- 1 The LANGUAGE menu appears. Change the on-screen display language to Spanish (ESPAÑOL) or French (FRANÇAIS) if desired, and push the cursor stick (OK). For details, see page 35.
- 2 The CLOCK SET menu appears. Select AUTO and push the cursor stick (OK). For details, see page 37.
- 3 The SMART CH MAPPING menu appears. Move the cursor stick $\uparrow/\downarrow/\leftarrow/\rightarrow$ to enter the ZIP/POSTAL CODE in your area and push the cursor stick (OK). (You can also use the number buttons to enter the ZIP/POSTAL CODE.)
- 4 The CABLE BOX menu appears. Select ON. For details, see page 43.

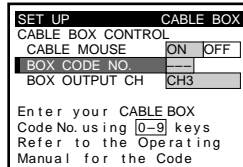
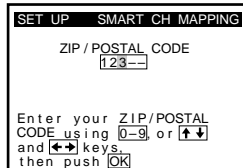
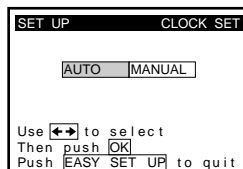
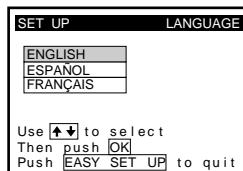

- 5 Enter your DIRECTV digital satellite receiver code number and move the cursor stick ↓. For details, see page 43.

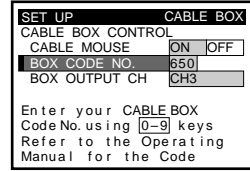

- 6 Set your DIRECTV digital satellite receiver output channel (BOX OUTPUT CH) to LINE and push the cursor stick (OK).

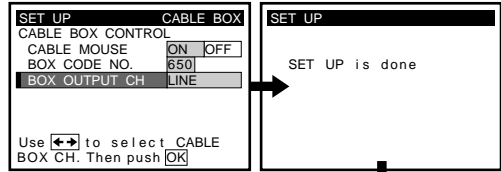

Normal display

Automatic clock setting

Once you've set up the VCR, it automatically sets the clock the first time you turn off the VCR. After that, whenever you turn off the VCR, it checks the time and adjusts the clock, even for Daylight Saving Time. The VCR sets the clock by picking up a time signal provided by some TV channels.

If you want to use the timer to record right away, or if the channels in your area do not carry time signals, set the clock manually. For details, see page 40.

Note

- To successfully record a program from the DIRECTV digital satellite receiver, proceed as follows:
 - Leave the DIRECTV digital satellite receiver on all the time.
 - Turn off the display (menu screen, channel number, etc.) of the DIRECTV digital satellite receiver.
 - To record or receive locked channels, unlock the channel before the VCR starts recording.
 - To set pay-per-view programs in the timer setting, order the pay-per-view program before the VCR starts recording.
 - Some programs are copy protected. You cannot record these programs.

continued

Incompatible cable box with only a few scrambled channels, using an A/B switch

Recommended use

By using an A/B switch (not supplied), this hookup allows you to record both scrambled and unscrambled channels conveniently.

What you can do with this hookup

- Record any unscrambled channel by selecting the channel directly on the VCR (the A/B switch is set to A)
- Record any scrambled channel by selecting the channel on the cable box (the A/B switch is set to B)

What you can't do

- Record one scrambled channel while watching another channel (the A/B switch is set to B)

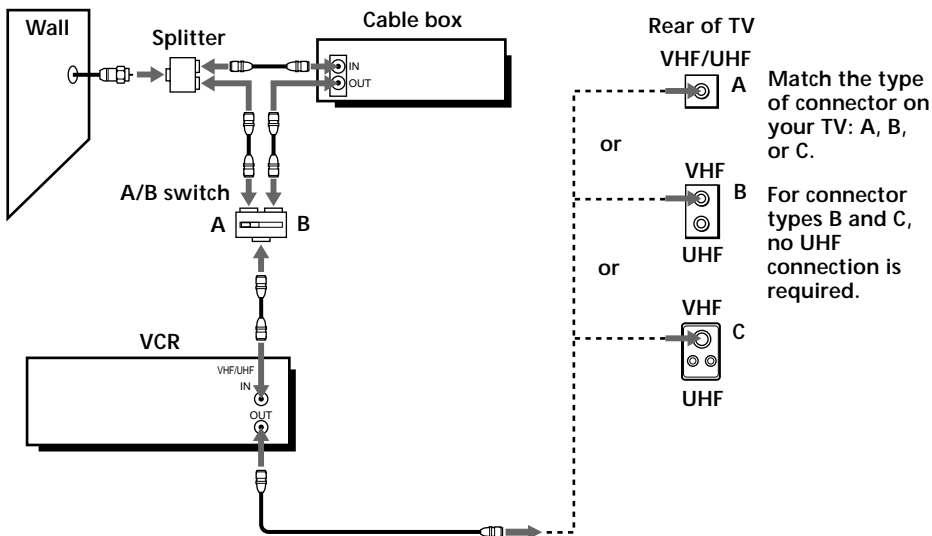

Hookup 6: VCR setup

- 1 Set the RF UNIT switch to CH3 or CH4, whichever channel is not used in your area. If both are used, set the switch to either channel. For details, see page 58. If you made A/V connections (from page 9), you can skip this step.

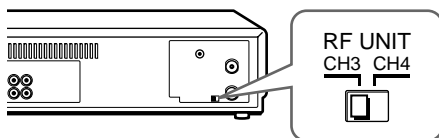

- 2 Set the A/B switch to "A".

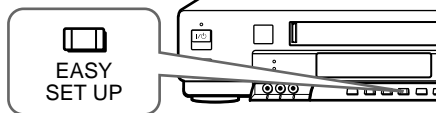

- 3 Press EASY SET UP on the VCR.

- 1 The LANGUAGE menu appears. Change the on-screen display language to Spanish (ESPAÑOL) or French (FRANÇAIS) if desired, and push the cursor stick (OK). For details, see page 35.

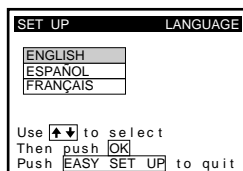

- 2 The CLOCK SET menu appears. Select AUTO and push the cursor stick (OK). For details, see page 37.

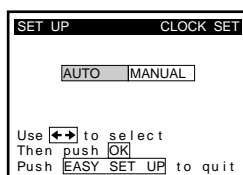

- 3 The SMART CH MAPPING menu appears. Move the cursor stick $\uparrow/\downarrow/\leftarrow/\rightarrow$ to enter the ZIP/POSTAL CODE in your area and push the cursor stick (OK). (You can also use the number buttons to enter the ZIP/POSTAL CODE.)

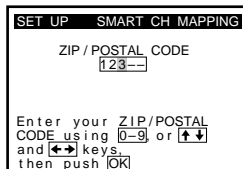

- 4 The CABLE BOX menu appears. Select OFF and push the cursor stick (OK).

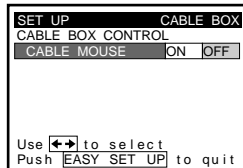

continued

Step 3: Hookups (continued)

- 5 The TUNER PRESET menu appears. Set ANTENNA / CABLE to CABLE and push the cursor stick (OK). For details, see page 48.

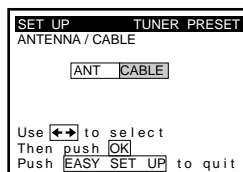

- 6 The AUTO PRESET starts.

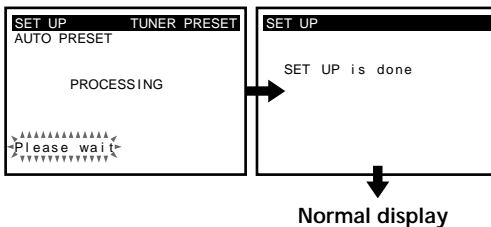

- 4 Preset the cable box output channel (usually 2, 3, or 4). For details, see page 49.

- 1 Press MENU, then select TUNER PRESET and push the cursor stick (OK).

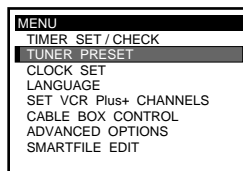

- 2 Enter the cable box output channel.

Cable box output channel

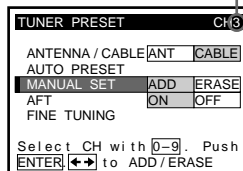

- 3 Set MANUAL SET to ADD and push the cursor stick (OK).

Hookup 6: The VCR Plus+ GOLD system channel setup

- 1 Press MENU, then select SET VCR Plus+ CHANNELS and push the cursor stick (OK).

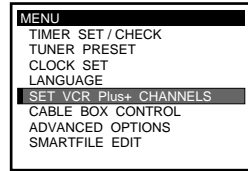

- 2 Select AUTO and push the cursor stick (OK).

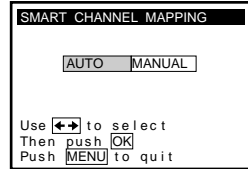

- 3 Press I/⏻ to turn off the VCR.

The VCR receives the program information signal from 0:00 am to 5:00 am while the VCR is turned off, and set up the channel for the VCR Plus+ GOLD system recording. After channel setup is finished, you can record TV programs using the VCR Plus+ GOLD system. For details, see page 54.

Notes

- To use the Smart Channel Mapping feature, set the A/B switch to "A".
- It takes about 1 hour to complete channel setup.
- The VCR can receive the program information signal only while the VCR is turned off and no timer recordings are set.
- If the channels in your area don't carry the program information signals, set the program guide channels manually. For details, see page 56.
- If the Choose your Cable CH MAP menu appears the first time you turn on the VCR after finishing channel setup, select the MAP number. For details, see page 55.

The VCR Plus+ GOLD system channel setup for scrambled channels

To set the program guide channels for scrambled channels, enter all the scrambled channels you want to record and the cable box output channel (usually 2, 3, or 4) after finishing smart channel mapping. For details, see page 56.

- 1 Find the VCR Plus+ GOLD system Channel Line-up Chart in your program guide. For details, see page 53.

continued

Step 3: Hookups (continued)

- 2 Press MENU, then select SET VCR Plus+ CHANNELS and push the cursor stick (OK).

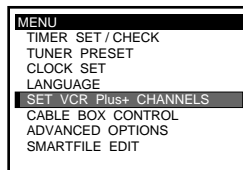

- 3 Select MANUAL and push the cursor stick (OK).

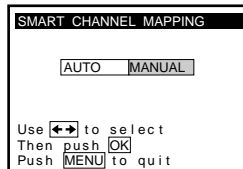

- 4 Enter the program guide channel, then the cable box output channel.

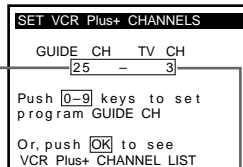

Program guide channel

Cable box output channel

- 5 Push the cursor stick (OK).
- 6 Press MENU to exit the menu.

Automatic clock setting

Once you've set up the VCR, it automatically sets the clock the first time you turn off the VCR. After that, whenever you turn off the VCR, it checks the time and adjusts the clock, even for Daylight Saving Time. The VCR sets the clock by picking up a time signal provided by some TV channels.

If you want to use the timer to record right away, or if the channels in your area do not carry time signals, set the clock manually. For details, see page 40.

Note

- To use the Auto Clock Set feature, set the A/B switch to "A".

Selecting a language

You can change the on-screen display language.

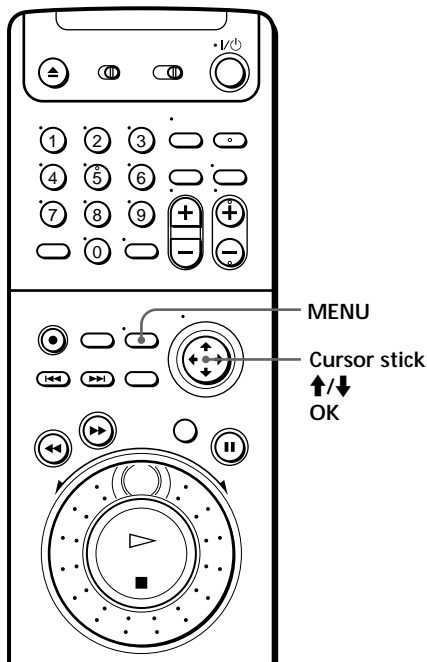

1



• CURSOR



PUSH OK

Press MENU, then move the cursor stick ↑/↓ to select LANGUAGE and push the cursor stick (OK).

When using the EASY SET UP procedure, skip this step.

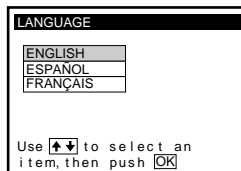

2

• CURSOR



PUSH OK

Move the cursor stick ↑/↓ to select ENGLISH, ESPAÑOL, or FRANÇAIS, then push the cursor stick (OK).

Setting the clock

Using the Auto Clock Set feature

Some TV and cable channels transmit time signals with their broadcasts. Your VCR can pick up this time signal to automatically set the clock.

The Auto Clock Set feature works only if a channel in your area is broadcasting a time signal. If broadcasters in your area are not yet sending time signals, set the time manually (page 40).

Before you start...

- Turn on the VCR and the TV.
- Set the TV to the VCR channel (channel 3 or 4). If your TV is connected to the VCR using A/V connections, set the TV to video input.
- Press TV/VIDEO to display the VIDEO indicator in the VCR's display window.
- Press INPUT SELECT so that a channel number appears in the VCR's display window.

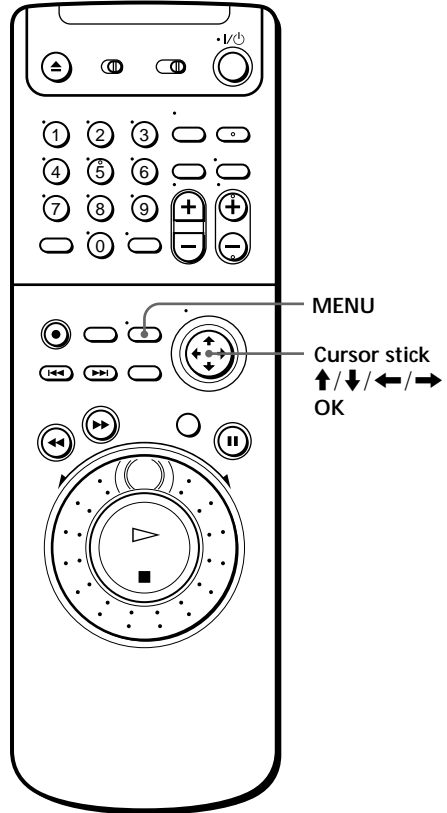

1

• MENU



• CURSOR



PUSH OK

Press MENU, then move the cursor stick **↑/↓** to select CLOCK SET and push the cursor stick (OK).

When using the EASY SET UP procedure, skip this step.

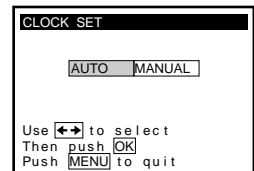

2

• CURSOR



PUSH OK

Move the cursor stick ←/→ to select AUTO, then push the cursor stick (OK).

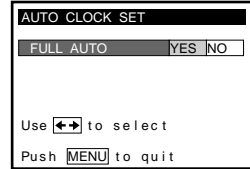

3

• CURSOR



PUSH OK

Move the cursor stick ←/→ to select YES, then push the cursor stick (OK).

4

To activate the Auto Clock Set feature, turn off the VCR.

The VCR automatically sets the clock by searching for a channel that carries a time signal and sets your time zone and Daylight Saving Time (if applicable).

If your clock is set to the wrong time zone or Daylight Saving Time, you can adjust these settings without turning off the Auto Clock Set feature (page 38).

Notes

- The clock cannot be set automatically if you don't receive a channel that carries a time signal in your area. If so, set the clock manually.
- If there are only a few channels in your area that carry time signals, setting the clock automatically may take up to about 30 minutes. If nothing happens even after you wait about 30 minutes, set the clock manually.
- If you use Hookup 1 or 4, make sure you leave the cable box on.

continued

Setting the clock (continued)

If the clock is not activated

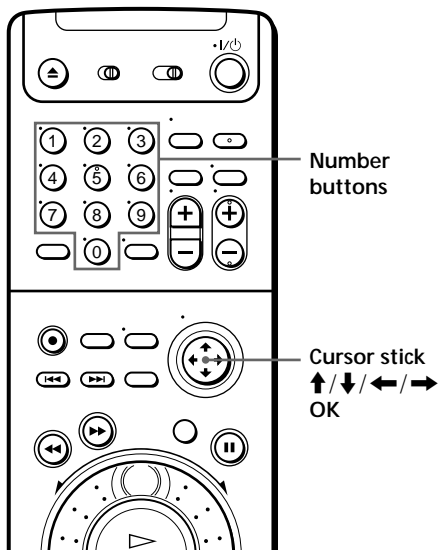

1

Follow steps 1 and 2 in “Using the Auto Clock Set feature”.
The AUTO CLOCK SET menu appears.

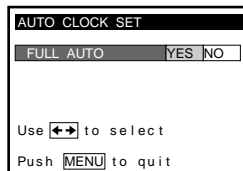

2

• CURSOR



Move the cursor stick ←/→ to select NO
for FULL AUTO.

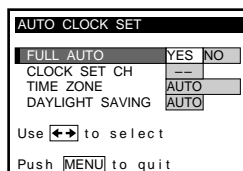

3

• CURSOR



PUSH OK

Move the cursor stick \uparrow/\downarrow to select the item you want to set, then move the cursor stick \leftarrow/\rightarrow to make the setting.

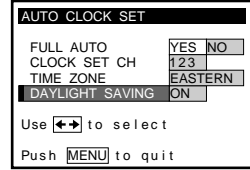

- For CLOCK SET CH
Leave the setting to “- -” to have the VCR automatically search for a channel that carries a time signal.

Press the number buttons to select a channel that carries a time signal.

Use this option if you know of a channel that carries a time signal. Most PBS member stations broadcast a time signal. For the fastest response, select your local PBS station.

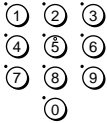

- For TIME ZONE

Select the time zone of your area, or select AUTO to have the VCR automatically set your time zone.

The options are: AUTO \rightarrow ATLANTIC \rightarrow EASTERN \rightarrow CENTRAL \rightarrow MOUNTAIN \rightarrow PACIFIC \rightarrow ALASKA \rightarrow HAWAII \rightarrow AUTO

- For DAYLIGHT SAVING

Select ON or OFF (standard time), or AUTO to have the VCR automatically set the daylight saving time.

4

• CURSOR



PUSH OK

Push the cursor stick (OK).

5

To activate the Auto Clock Set feature, turn off the VCR.

Notes

- If you use both the cable box control feature and the Auto Clock Set feature, the VCR automatically changes channels on the cable box until a channel that carries a time signal is found, whenever you turn off the VCR.
If you want to stop the search, change the channel on the cable box with the channel buttons either on the VCR or on the remote commander.
- If you use Hookup 1 or 4, make sure you leave the cable box on.

continued

Setting the clock (continued)

Using Manual Clock Set

Before you start...

- Turn on the VCR and the TV.
- Set the TV to the VCR channel (channel 3 or 4). If your TV is connected to the VCR using A/V connections, set the TV to video input.
- Press TV/VIDEO to display the VIDEO indicator in the VCR's display window.

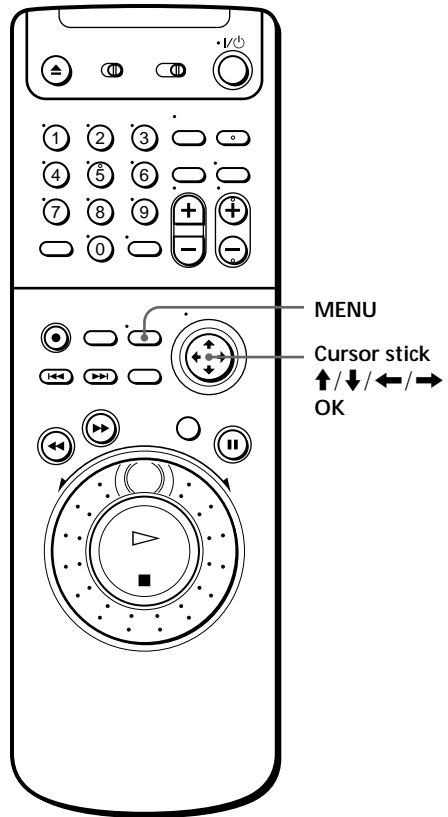

1

- MENU
- CURSOR



PUSH OK

Press MENU, then move the cursor stick ↑/↓ to select CLOCK SET and push the cursor stick (OK).

When using the EASY SET UP procedure, skip this step.

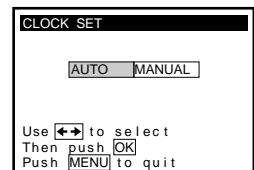

2

•CURSOR



PUSH OK

Move the cursor stick ←/→ to select **MANUAL**, then push the cursor stick (OK).

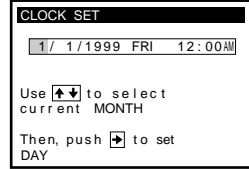

3

•CURSOR

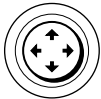

PUSH OK

Move the cursor stick ↑/↓ to set the month.

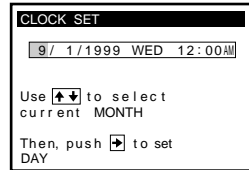

4

•CURSOR

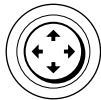

PUSH OK

Move the cursor stick → to highlight the day and move the cursor stick ↑/↓ to set the day.

The day of the week is set automatically.

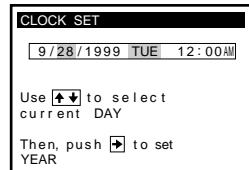

5

Set the year, hour and minutes in the same way as the day.

6

•CURSOR

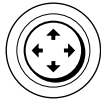

PUSH OK

Push the cursor stick (OK) to start the clock.

Setting up the cable box control

(Skip this section if you are using Hookup 2, 3, 4, or 6.)

Your VCR includes a cable box control feature that allows the VCR to control most brands of cable boxes/DIRECTV digital satellite receivers via the Cable Mouse. With the cable box control, the VCR controls channels on the cable box/DIRECTV digital satellite receiver for timer recording. You can also use the VCR's remote commander to change channels on the cable box/DIRECTV digital satellite receiver whenever the cable box/DIRECTV digital satellite receiver is turned on even if the VCR is turned off. To use cable box control, you need to connect the Cable Mouse (pages 11 and 27) and set the code number and output channel.

This VCR is programmed with codes necessary to control channel selection on most brands of cable boxes at the time this VCR was manufactured. It is possible that new cable boxes may be introduced that cannot be controlled with this VCR's Cable Mouse. If you have a cable box that is incompatible with this VCR, contact your cable operator — they may be able to provide you with a compatible cable box.

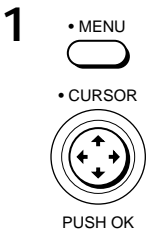
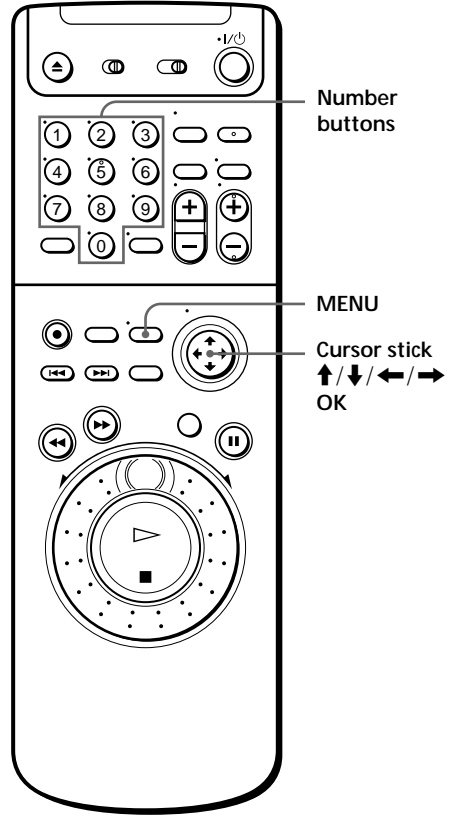

Press MENU, then move the cursor stick ↑/↓ to select CABLE BOX CONTROL and push the cursor stick (OK).

When using the EASY SET UP procedure, skip this step.

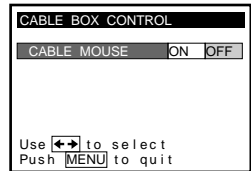

2

• CURSOR



PUSH OK

Move the cursor stick ←/→ to select ON.

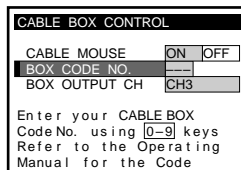
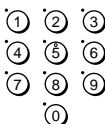
**3**

• CURSOR



PUSH OK

Press the number buttons to enter the cable box/DIRECTV digital satellite receiver code number, then move the cursor stick ↓.

Find your cable box/DIRECTV digital satellite receiver code number from the chart below.

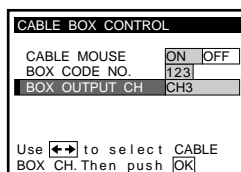
**4**

• CURSOR



PUSH OK

If you want to control a cable box, move the cursor stick ←/→ to select the cable box output channel, then push the cursor stick (OK).

If you want to control a DIRECTV digital satellite receiver, select LINE, then push the cursor stick (OK).

Cable box and DIRECTV digital satellite receiver brand and the corresponding code numbers

If more than one code number is listed, try entering them one by one, until you come to the correct code for your equipment.

Cable box brand	Code numbers
ABC	018, 022, 024, 028, 217
Antronix	218
Archer	033, 050, 164, 218, 808
BBT	278
Cable Star	067
Cabletenna	033
Cable time	172, 388, 459
Century	164
Citizen	164, 326, 327

Cable box brand	Code numbers
Clyde Cablevision	097
Colour Voice	036, 042
Combant	243, 244
Comtronics	051, 071
Decsat	434
Diamond	046
Eagle Comtronics	051
Eastern	013, 285
Electricord	089

continued

Setting up the cable box control (continued)

Cable box brand	Code numbers
Electus	055
Focus	411
Garrard	164
GC Electronics	027, 067, 341
GE	243, 244
GEC	097
Gemini	026, 068, 081
General Instrument	022, 287, 487
Hamlin	020, 031, 045, 270, 284
Hitachi	022
Jasco	164, 326
Jerrold	014, 022, 025, 026, 035, 037, 058, 109, 287, 487
Linsay	451
Macom	044
Magnavox	038, 043, 080
Memorex	011
Movie Time	089, 167, 214
Northcoast	325
Novaplex	629
NSC	074, 081, 167, 214
Oak	018, 030, 259
Panasonic	032, 118
Paragon	011
Philips	036, 038, 039, 040, 041, 042, 071, 301
Pioneer	034, 155, 271, 544, 695
Popular Mechanics	411
Pulsar	011
Radio shack	808
RCA	032
Realistic	218
Recoton	411
Regal	031, 270, 284, 290
Regency	013
Rembrandt	081

Cable box brand	Code numbers
Samsung	051, 155
Scientific Atlanta	017, 019, 028, 288
Seam	521
Sharp	324
Signal	051
Signature	022
SL Marx	051
Spectravision	069
Sprucer	032, 318
Standard Components	107, 166
Starcom	014, 026, 058, 109
Stargate	026, 051
STS	167
Sylvania	012
T-Cable Teletext	116
Tandy	269
Tatung	108
Teknica	157
TeleCaption	232
Teleservice	292
Texscan	012, 107
TFC	321
Timeless	429
Tocom	023, 024
Toshiba	011
Tudi	297
TV86	074
TV COM	018, 030, 259
Uniden	236
Unika	033, 164, 218
United Artists	018
United Cable	014
Universal	033, 050, 067, 088, 089, 164, 202, 218, 333
Videoway	261
Vidtech	255

Cable box brand	Code numbers
Viewstar	038, 071, 074, 122, 222, 269, 300
Zenith	011, 065, 536
Zentek	411
Wave Master	576

DIRECTV digital satellite receiver brand	Code numbers
Hitachi	830
RCA	577
Sony	650
Toshiba	801

To ensure correct operation

- Place the Cable Mouse so that it hangs out over the cable box/DIRECTV digital satellite receiver front.
- Do not place the cable box/DIRECTV digital satellite receiver on top of the VCR.
- Position the cable box/DIRECTV digital satellite receiver away from the VCR.
- Point the remote commander at the VCR, not at the cable box/DIRECTV digital satellite receiver.

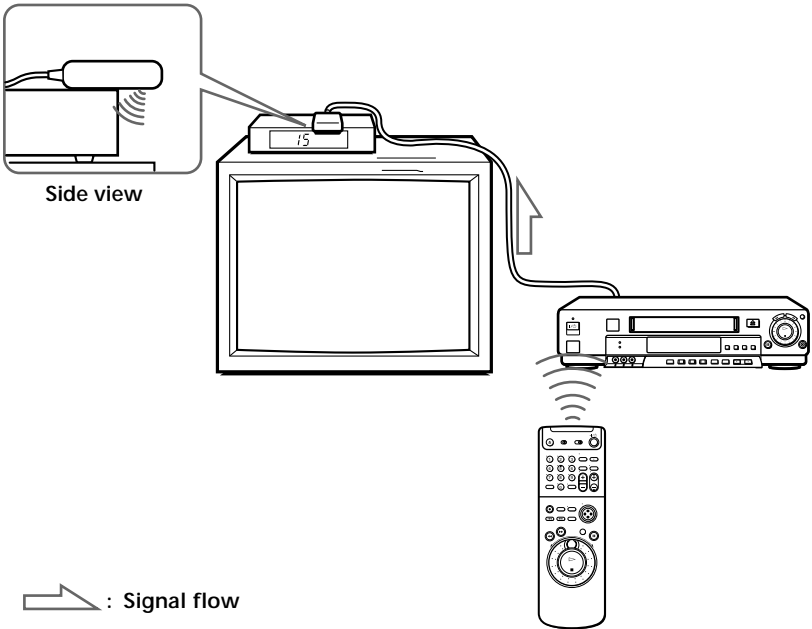

continued

Setting up the cable box control (continued)

To check the cable box control setting

- 1** Press CH +/- on the remote commander. Does the channel indicator on the cable box/DIRECTV digital satellite receiver change? (Point the remote commander at the VCR, not at the cable box/DIRECTV digital satellite receiver.)
- 2** Press all 10 number buttons (0 to 9) on the remote commander. Does the channel indicator on the cable box/DIRECTV digital satellite receiver change?

If the answer to both 1 and 2 is “yes,” you have made the correct setting.

If you cannot get your VCR to control the cable box/DIRECTV digital satellite receiver

- Check that the Cable Mouse is connected to the CABLE BOX CONTROL jack on the VCR.
- Check the position of the Cable Mouse.
- Place the cable box/DIRECTV digital satellite receiver and VCR away from each other. Do not place the cable box/DIRECTV digital satellite receiver on top of the VCR.
- Try the setup again making sure to use the correct control code. If the cable box still does not respond, try the other codes that are listed.

If your cable box still does not operate with the Cable Mouse, contact your cable company to see if they can provide you with a compatible cable box.

Note

- Make sure you turn off the VCR when you plug in or unplug the Cable Mouse. If you unplug the Cable Mouse and plug it in again, turn on the VCR before you use the cable box/DIRECTV digital satellite receiver control feature.

Presetting channels

(Skip this section if you are using cable box/DIRECTV digital satellite receiver control.)

This VCR is capable of receiving VHF channels 2 to 13, UHF channels 14 to 69 and unscrambled CATV channels 1 to 125. First, we recommend that you preset the receivable channels in your area using automatic presetting. Then, if there are any unwanted channels, disable them manually. If you have decided which channels you wish to preset, set them directly using manual presetting.

Before you start...

- Turn on the VCR and the TV.
- Set the TV to the VCR channel (channel 3 or 4). If your TV is connected to the VCR using A/V connections, set the TV to video input.
- Press TV/VIDEO to display the VIDEO indicator in the VCR's display window.

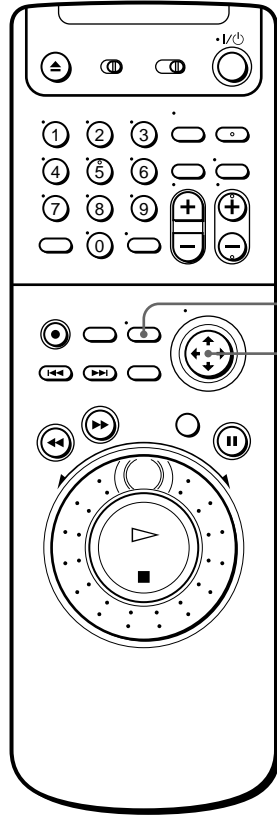

MENU

Cursor stick
 ↑/↓/←/→
 OK

Presetting all receivable channels automatically

1

• MENU



• CURSOR



PUSH OK

Press MENU, then move the cursor stick ↑/↓ to select TUNER PRESET and push the cursor stick (OK).

When using the EASY SET UP procedure, skip this step.

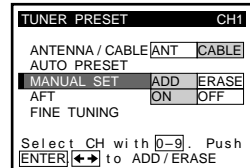

continued

Presetting channels (continued)

2

• CURSOR



PUSH OK

• To preset cable TV channels:

Move the cursor stick ←/→ to set ANTENNA/CABLE to CABLE.

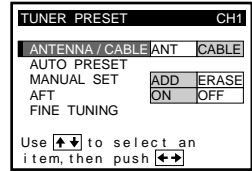

• CURSOR



PUSH OK

• To preset VHF and UHF channels:

Move the cursor stick ←/→ to set ANTENNA/CABLE to ANT.

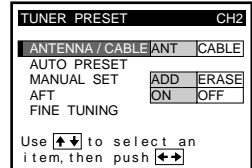

3

• CURSOR



PUSH OK

Move the cursor stick ↑/↓ to select AUTO PRESET, then push the cursor stick (OK).

All receivable channels are preset in numerical sequence. When no more receivable channels can be found, presetting stops and the picture from the lowest numbered channel is displayed on the TV screen.

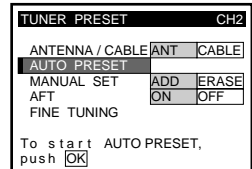

Tip

- When receiving a VHF, UHF, or CATV channel, the display changes as follows each time you press DISPLAY.

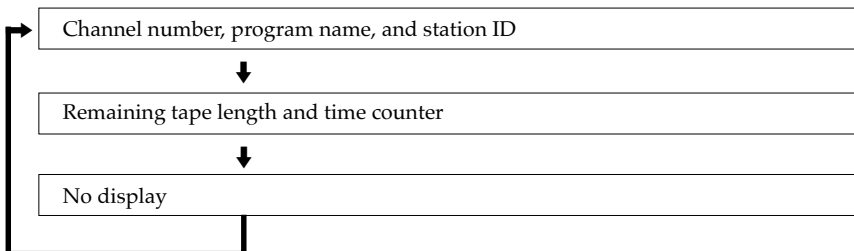

Presetting/disabling channels manually

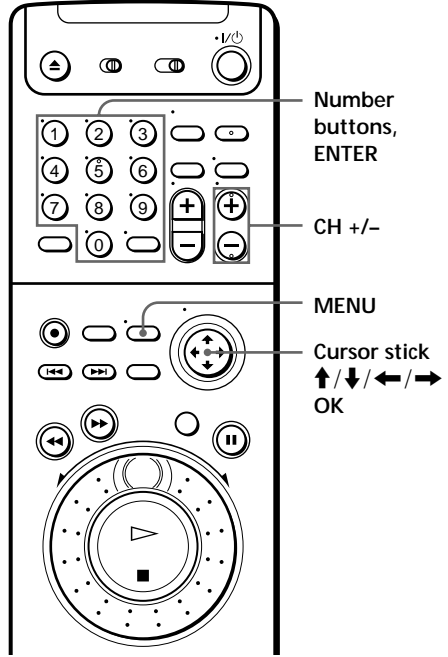

1

• MENU



• CURSOR



PUSH OK

Press MENU, then move the cursor stick ↑/↓ to select TUNER PRESET and push the cursor stick (OK).

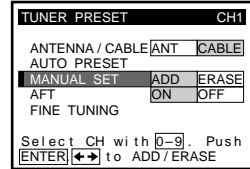

continued

Presetting channels (continued)

2

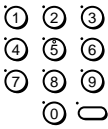

• CURSOR



PUSH OK

• CH



• CURSOR



PUSH OK

• To preset a channel:

- 1 Press the number buttons to enter the channel number, then press ENTER.
- 2 Move the cursor stick ←/→ to set MANUAL SET to ADD.

Channel to be preset

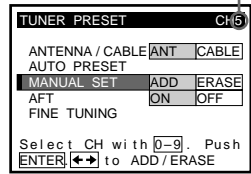

• To disable a channel:

- 1 Press CH +/- to select the channel number.
- 2 Move the cursor stick ←/→ to set MANUAL SET to ERASE.

Channel to be disabled

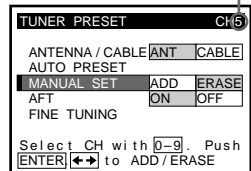

3

• CURSOR



PUSH OK

Repeat step 2 to preset or disable channels as required, then push the cursor stick (OK).

If the picture is not clear

Normally, the Auto Fine Tuning (AFT) function automatically tunes in channels clearly. If, however, the picture of a channel is not clear, you can also use the manual tuning function.

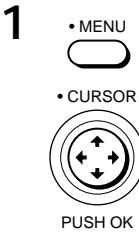
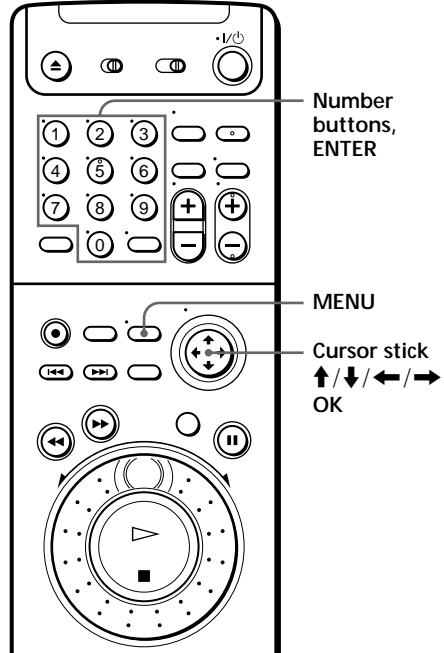

Press MENU, then move the cursor stick ↑/↓ to select TUNER PRESET and push the cursor stick (OK).

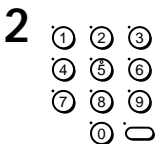
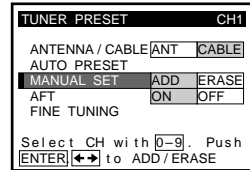

Press the number buttons to select the channel you want to fine-tune, then press ENTER.

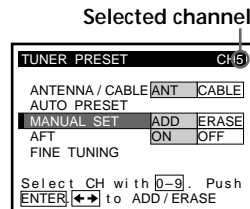

continued

Presetting channels (continued)

3

• CURSOR



PUSH OK

Move the cursor stick **↑/↓** to select FINE TUNING.

The fine tuning meter appears.

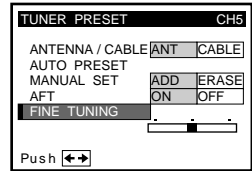

4

• CURSOR



PUSH OK

Move the cursor stick **←/→** to adjust to a clearer picture.

Note that the AFT setting switches to OFF.

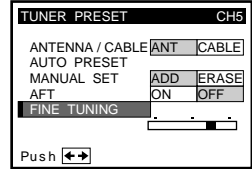

Note

- When adjusting FINE TUNING, the menu may become difficult to read due to interference from the picture being received.

Setting up the VCR Plus+ GOLD system

How the VCR Plus+ GOLD system works

Whenever you want to record a TV program, all you need to do is look up the “PlusCode” number, a number assigned to each program published in the TV section of most newspapers, cable TV listings, and even *TV GUIDE* magazine. Then, just enter the PlusCode number of the program you want and the VCR is automatically programmed to record that show. It’s that simple.

Example of “PlusCode”

			PlusCode
5:30	14	MOVIE — Musical (2hrs.)	33044
	2	SPORT — Golf (1hr. 25min.)	42060
	CNN	— WS 9974	
6:30	2 3 4	DRAMA — Comedy (2hrs.)	17390
	5	SCIENCE AND TECHNOLOGY (1hr. 15min.)	73457

How to set up your VCR

Setting up your VCR involves coordinating the TV channel number (the number you turn to on your TV or VCR to watch a program) with the guide channel (the number that’s assigned to that channel in your program guide).

The VCR can set the guide channels automatically (see page 54), but you may have to set the guide channels manually depending on your area or the way you hooked up your VCR (see page 56).

To find the guide channel numbers, look at the “Channel Line-up Chart” in the program guide for your area that features VCR PlusCodes. It usually looks like the example to the right.

Example of “Channel Line-up Chart”

CABLE CH	CABLE TV	VCR Plus+ GUIDE CH
16	AMC American Movie Classics	35
17	BRV Bravo (program grid only)	54
20	CNN Cable News Network	42
21	CSP C-SPAN	28
22	DIS The Disney Channel	53
25	DSC The Discovery Channel	37
34	ESN ESPN	34
35	FAM The Family Channel	47
5	HBO Home Box Office	33
27	LIF Lifetime	46
29	MAX Cinemax	45
30	MTV Music Television	48
31	NIK Nickelodeon	38
38	SC Sports Channel	59
39	SCA Sports Channel America	70
45	SHO Showtime	41
17	TBS TBS SuperStation	43
44	TMC The Movie Channel	58
49	TNN The Nashville Network	49
50	TNT Turner Network Television	52
51	USA USA Network	44

continued

Setting up the VCR Plus+ GOLD system (continued)

Setting up the VCR Plus+ GOLD system automatically (Smart Channel Mapping)

The VCR can automatically set the guide channels in your area from ZIP / POSTAL CODE you entered in EASY SET UP. The VCR receives the program information signal and renews the data everyday after you complete the following procedure.

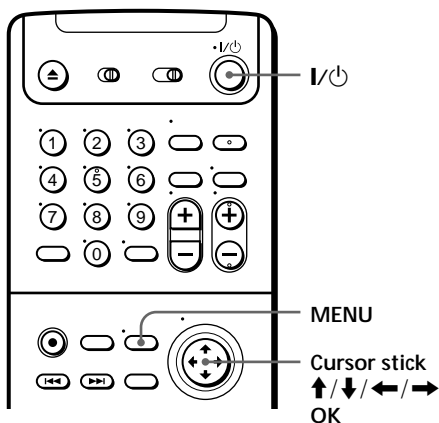

1 Set up the VCR using the EASY SET UP procedure.

2 Press **MENU**, then move the cursor stick **↑/↓** to select **SET VCR Plus+ CHANNELS** and push the cursor stick (OK).
The **SMART CHANNEL MAPPING** menu appears.

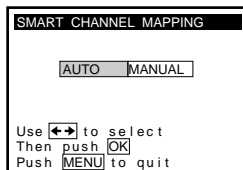

3 Move the cursor stick **←/→** to select **AUTO**, then push the cursor stick (OK).



The instruction shown on the right appears on the TV screen for few seconds, then the screen returns to the normal display.

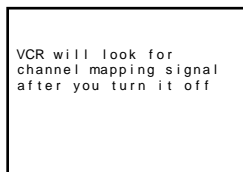

If the program information signal in your area has several channel map patterns, the **Choose your Cable CH MAP** menu appears, and you must select the channel map. See "To select the channel map" below.

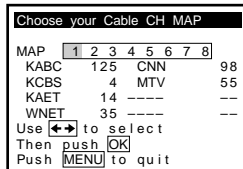

4



Press **I/O** to turn off the VCR.

The VCR sets the program guide channels from 0:00 am to 5:00 am while the VCR is turned off. (It takes about 1 hour to complete channel mapping.)

To select the channel map

If the program information signal in your area has several channel map patterns (up to 8), the Choose your Cable CH MAP menu appears:

- the first time you turn on the VCR after completing channel mapping
- after selecting AUTO and pushing the cursor stick (OK) on the SMART CHANNEL MAPPING menu

In this case, you have to select the channel map on the Choose your Cable CH MAP menu.

- 1 Find the VCR Plus+ GOLD system Channel Line-up Chart in your program guide. For details, see page 53.
- 2 Move the cursor stick **←/→** to select the channel map number you want by checking the channel number in the program guide.
- 3 Push the cursor stick (OK).

Channel map

Station ID number

Choose your Cable CH MAP								
MAP	1	2	3	4	5	6	7	8
KABC	125			CNN				98
KCBS	4			MTV				55
KAET	4			----				--
WNET	35			----				--

Channel number

Notes

- When using a cable box, make sure to leave it on.
- It takes about 1 hour to complete channel mapping.
- The VCR can receive the program information signal only while the VCR is turned off and no timer recordings are set.
- The VCR cannot set the guide channels correctly unless you enter the ZIP/POSTAL CODE in your area.
- When you move to a different area, you must set up the VCR again and enter your new ZIP/POSTAL CODE in the EASY SET UP procedure.

continued

Setting up the VCR Plus+ GOLD system (continued)

Setting up the VCR Plus+ GOLD system manually

To set the guide channels manually, use the Channel Line-up Chart to check that the guide channel numbers match the TV channel your VCR receives. For example, if HBO is listed in the Channel Line-up Chart on channel 33, and your VCR receives HBO on channel 5, you need to coordinate these numbers using the following procedure. If the guide and TV channel numbers are the same, you can skip this procedure.

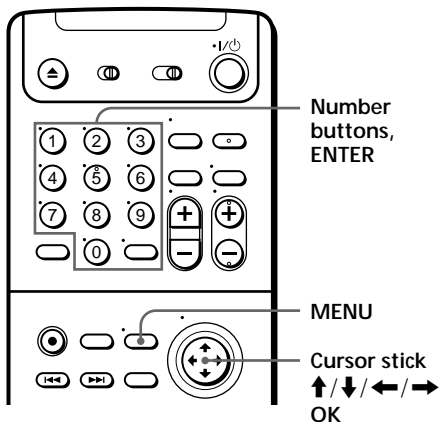

- 1** • **MENU**
• **CURSOR**
- Press **MENU**, then move the cursor stick **↑/↓** to select **SET VCR Plus+ CHANNELS** and push the cursor stick (OK).

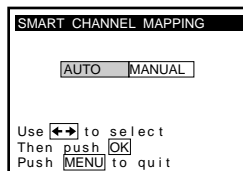

- 2** • **CURSOR**
- Move the cursor stick **←/→** to select **MANUAL**, then push the cursor stick (OK).

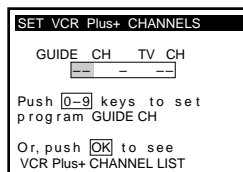

- 3**
- Enter the guide channel number assigned in the program guide and press **ENTER**.

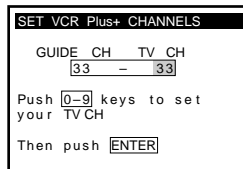
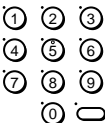

4

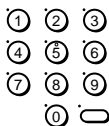

- If you made Hookup 1, 2, or 3: Enter the actual number on your TV (and VCR) and press ENTER.

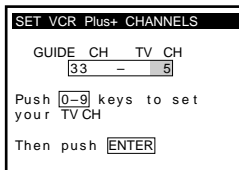

- If you made Hookup 4: Enter the cable output channel (usually 2, 3, or 4) and press ENTER.
- If you made Hookup 6: Enter the actual number on your TV (and VCR) for an unscrambled channel and press ENTER. For a scrambled channel, enter the cable box output channel (usually 2, 3, or 4) and press ENTER.

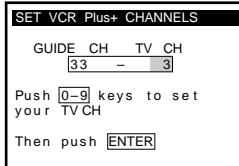

5

Repeat steps 3 and 4 for each guide channel number that doesn't match.

6

• CURSOR



When you have set all channels, push the cursor stick (OK) to confirm your channel settings.

To return to the previous page, move the cursor stick ←.

To go to the next page, move the cursor stick →.

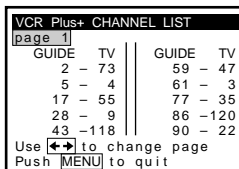

7

• MENU



After all settings are complete, press MENU to exit the menu.

General setup information

Setting the RF unit

When connecting the VCR to the TV using only the antenna cable, you must set the RF UNIT switch on the rear of the VCR so that the TV can receive the correct signal from the VCR.

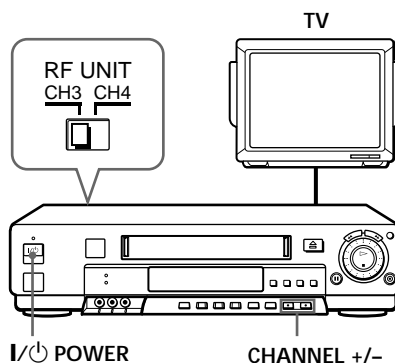

- 1 Set the RF UNIT switch on the rear of the VCR to CH3 or CH4, whichever channel is not used in your area. If both are used, set the switch to either channel.
- 2 Press I/POWER to turn on the VCR.
- 3 Press TV/VIDEO to turn on the VIDEO indicator in the VCR's display window.
- 4 Press CHANNEL +/- to display a channel number in the display window. Select an active channel number in your area.
- 5 Turn on your TV and set it to the channel you selected in step 1 (channel 3 or 4).

The channel you selected in step 4 appears on the TV screen. If the channels change when you press CHANNEL +/-, you have made the correct setting.

Whenever you use the VCR, set the TV to the channel selected in step 1.

Attaching the external antenna connector

When using a 300-ohm twin lead cable for VHF/UHF antenna, use the EAC-32 antenna connector (not supplied) to connect the antenna to the VCR.

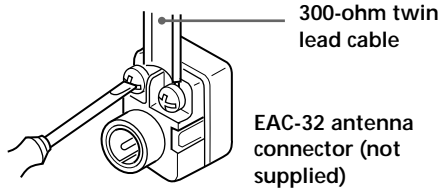

- 1 Loosen the screws on the antenna connector.
- 2 Wind the twin leads around the screws on the antenna connector.
- 3 Retighten the screws.

Attaching a UHF/VHF band mixer

When using both 75-ohm coaxial cable and 300-ohm twin lead cable for VHF / UHF antenna, use the EAC-66 UHF / VHF band separator / mixer (not supplied) to connect the antenna to the VCR.

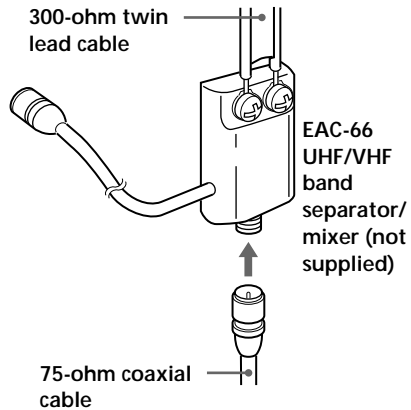

- 1 Loosen the screws on the mixer.
- 2 Wind the twin leads around the screws on the mixer.
- 3 Retighten the screws.
- 4 Connect the 75-ohm coaxial cable to the mixer.

Index to parts and controls

Refer to the pages indicated in parentheses () for details.

Front panel

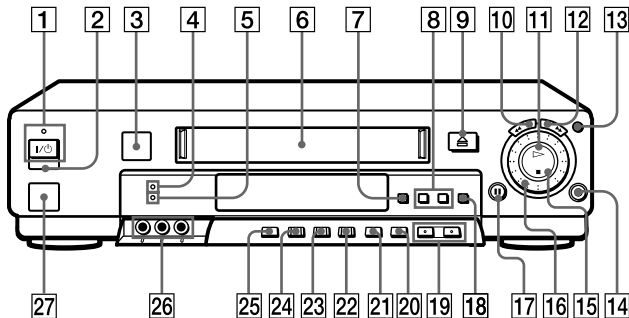

- | | |
|--|---|
| 1 I/⏻ POWER switch/indicator (58) | 16 Shuttle ring |
| 2 Remote sensor (5) | 17 PAUSE button |
| 3 SmartFile sensor | 18 OK button (35) |
| 4 SMARTFILE indicator | 19 CHANNEL/TRACKING +/- buttons (58) |
| 5 REALITY REGENERATOR indicator | 20 EDIT button |
| 6 Tape compartment | 21 REALITY REGENERATOR button |
| 7 SMARTFILE button | 22 EASY SET UP button (12, 16, 20, 24, 28, 31) |
| 8 CURSOR ↓/↑ buttons | 23 COMMAND MODE button (6) |
| 9 ≡ EJECT button | 24 SMARTFILE GENERATOR button |
| 10 ◀◀ REW (rewind) button | 25 INPUT SELECT button (36) |
| 11 ▷ PLAY button | 26 LINE-2 IN VIDEO/AUDIO L/R jacks |
| 12 ▶▶ FF (fast-forward) button | 27 LASER LINK IR receiver |
| 13 JOG button | |
| 14 ● REC (record) button | |
| 15 ■ STOP button | |

Display window

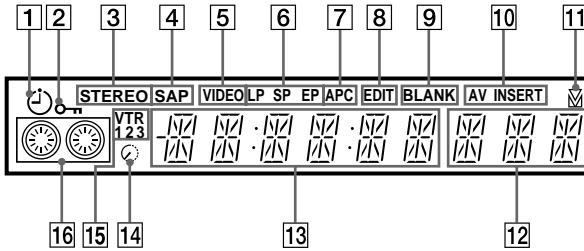

- | | |
|---|--|
| 1 Timer indicator | 9 BLANK indicator |
| 2 Child Lock indicator | 10 AV INSERT indicator |
| 3 STEREO indicator | 11 Tracking indicator |
| 4 SAP (Second Audio Program) indicator | 12 Line/channel indicator (36) |
| 5 VIDEO indicator (36, 58) | 13 Time counter/clock indicator |
| 6 Tape speed indicator | 14 Remaining time indicator |
| 7 APC (Adaptive Picture Control) indicator | 15 COMMAND MODE indicator (6) |
| 8 EDIT indicator | 16 Tape/recording indicator |

continued

Index to parts and controls (continued)

Rear panel

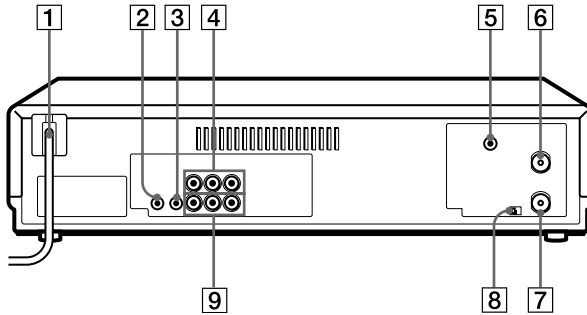

- | | |
|--|---|
| 1 AC power cord (8) | 6 VHF/UHF IN connector (11, 15, 19, 23, 27, 30) |
| 2 S-LINK (CONTROL S IN) jack (10) | 7 VHF/UHF OUT connector (11, 15, 19, 23, 27, 30) |
| 3 CABLE BOX CONTROL (CONTROL S OUT) jack (11, 27) | 8 RF (Radio Frequency) UNIT switch (58) |
| 4 LINE-1 IN AUDIO R/L/VIDEO jacks (27) | 9 LINE OUT AUDIO R/L/VIDEO jacks (9) |
| 5 CPD (Control and Program Data) IN jack | |

Remote commander

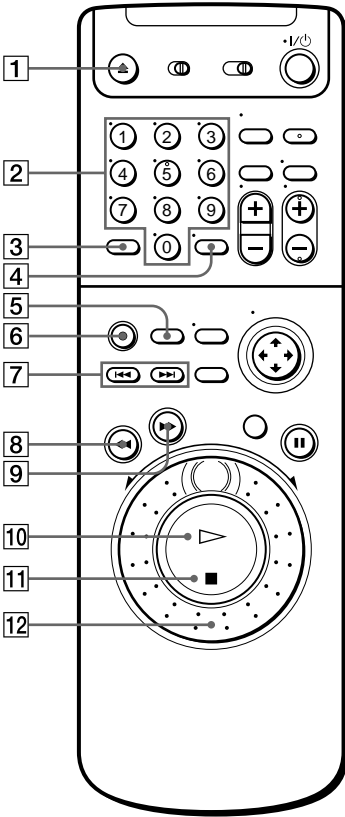

- 1 ▲ EJECT button
- 2 Number buttons (43)
- 3 VCR Plus+ button
- 4 ENTER button (50)
- 5 SMARTFILE button
- 6 ● REC (record) button
- 7 ◀◀ / ▶▶ INDEX SEARCH buttons
- 8 ◀◀ REW (rewind) button
- 9 ▶▶ FF (fast-forward) button
- 10 ▷ PLAY button
- 11 ■ STOP button
- 12 Shuttle ring

continued

Index to parts and controls (continued)

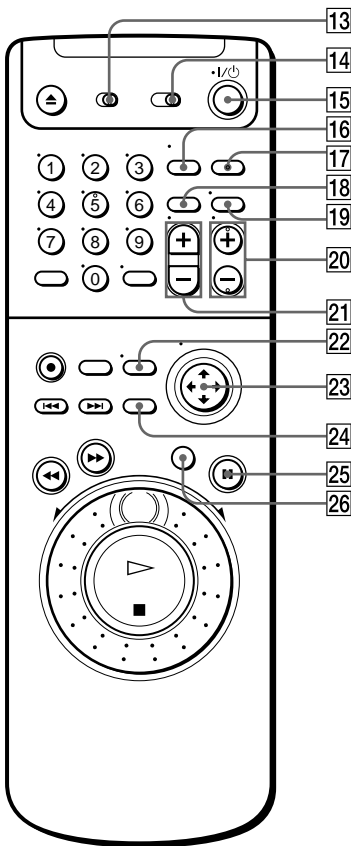

- 13** TV / VIDEO switch (5)
- 14** COMMAND MODE switch (6)
- 15** I/O (power) switch (7, 55)
- 16** TV/VIDEO button (7, 36, 58)
- 17** INPUT SELECT button (36)
- 18** CLEAR button
- 19** DISPLAY button (48)
- 20** CH (channel) +/- buttons (7, 50, 58)
- 21** VOL (volume) +/- buttons (7)
- 22** MENU button (35)
- 23** Cursor stick (35)
 ↑/↓/←/→
 OK
- 24** SMART CUE button
- 25** || PAUSE button
- 26** JOG button

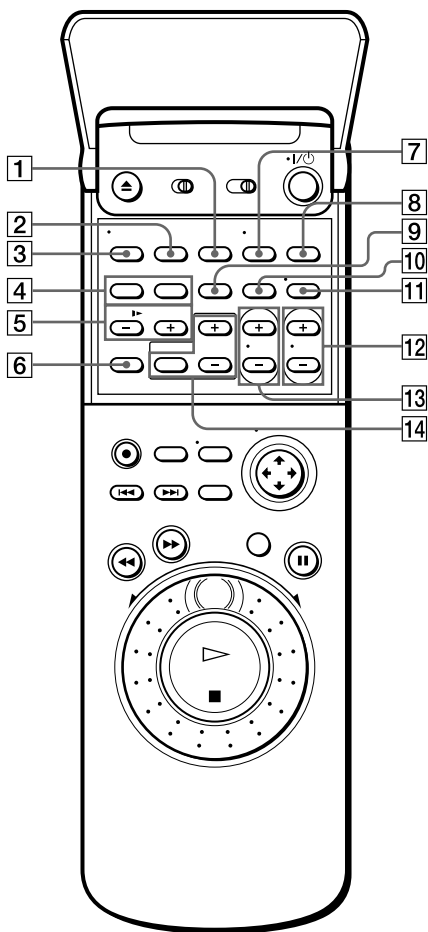

- 1** COUNTER/REMAIN button
- 2** SP (Standard Play)/EP (Extended Play) button
- 3** AUDIO MONITOR button
- 4** AUDIO/VIDEO INSERT buttons
- 5** ► SLOW +/- buttons
- 6** ×2 button
- 7** TV/VIDEO button (7, 36, 58)
- 8** INPUT SELECT button (36)
- 9** TAPE RETURN button
- 10** CLEAR button
- 11** DISPLAY button (48)
- 12** CH (channel) +/- buttons (7, 50, 58)
- 13** VOL (volume) +/- buttons (7)
- 14** Receiver operation buttons
RECEIVER VOL (volume) +/- buttons (5)
MUTING button (5)

Index

A, B

- AFT (Auto Fine Tuning) 51
- Antenna hookup 19
- Audio/video (A/V) hookup 9
- Auto Clock Set 36

C

- Cable box control
 - cable box code number chart 43
 - setting 42
- Cable hookup 8
- Cable Mouse 11, 27
- Channel line-up chart 53
- Clock setting 36
- Connecting
 - cable TV 8
 - external antenna connector 59
 - UHF/VHF band mixer 59

D

- DIRECTV System 27
- Disabling channels 49

E, F, G, H, I, J, K

- Easy Set Up 12, 16, 20, 24, 28, 31

L, M, N, O

- Language selecting 35

P, Q

- Presetting channels 47

R

- RF channel 58

S

- S-Link™ 9
- Smart channel mapping 54

T, U

- Tuner presetting 47

V, W, X, Y, Z

- VCR Plus+ GOLD channel setup 53