

[▶ Troubleshooting](#)

How to Use

[Parts Description](#)

[Setup](#)

[Network / Internet](#)

[Connections](#)

[Settings](#)

[Playback](#)

[Backup / Recovery](#)

[Security](#)

[Other Operations](#)

[Notifications](#)

Read This First

Congratulations on your purchase of this VAIO(R) computer.

About your VAIO computer's configuration

To find out about the configuration of your VAIO computer, visit the Sony online support website. [\[Details\]](#)
Some features, options, and supplied items may not be available on your VAIO computer.

Features

Available features vary depending on the model or options you selected. Not all features described in this manual are available depending on your model.

Illustrations

Illustrations, photos, or screenshots in this manual may look slightly different depending on the model or options you selected.

Apps

The preinstalled apps may vary depending on the model or options you selected. The apps described in this manual may not be preinstalled on your VAIO computer.

Supplied manuals

The following manuals are supplied with your VAIO computer.

On-screen documentation

- User Guide - Introduction Version [\[Details\]](#)
A preinstalled manual with limited information of your VAIO computer, focused on support and Internet connection. The User Guide - Introduction Version is replaced with a complete version of the User Guide (this manual), after update.
- User Guide (this manual)
General information and operation instructions about your VAIO computer including support and troubleshooting information

Printed documentation

- Quick Start Guide
An overview of how to set up and get started with your VAIO computer
- Recovery, Backup and Troubleshooting Guide
Information on how to recover and back up your VAIO computer, as well as troubleshooting information
- Safety Regulations
Read carefully before activating the wireless functions such as the wireless LAN and BLUETOOTH technology.

Other references

- Windows Help and Support [\[Details\]](#)
A comprehensive resource for practical advice, tutorials, and demonstrations to help you learn to use your VAIO computer.
- App help files

App help files may be included with the preinstalled apps on your VAIO computer. You may be able to access the help files from the help menu.

Notice

- Copyright 2012 Sony Corporation. All rights reserved.
- This manual and the software described herein, in whole or in part, may not be reproduced, translated, or reduced to any machine-readable form without prior written approval.
- Sony Corporation provides no warranty with regard to this manual, the software, or other information contained herein and hereby expressly disclaims any implied warranties or merchantability or fitness for any particular purpose with regard to this manual, the software, or such other information. In no event shall Sony Corporation be liable for any incidental, consequential, or special damages, whether based on tort, contract, or otherwise, arising out of or in connection with this manual, the software, or other information contained herein or the use thereof.
- In the manual, the (TM) or (R) marks are not specified.
- Sony Corporation reserves the right to make any modification to this manual or the information contained herein at any time without notice.
- The software described herein is governed by the terms of a separate user license agreement.
- Sony Corporation is not liable and will not compensate for any lost recordings made to your VAIO computer, external recording media, or recording devices or any relevant losses, including when recordings are not made due to reasons including the computer failure, or when the contents of a recording are lost or damaged as a result of the computer failure or repair undertaken to the computer. Sony Corporation will not restore, recover, or replicate the recorded contents made to the computer, external recording media, or recording devices under any circumstances.
- Features and specifications are subject to change without notice.

Related Topic

[About Online Support Website](#)

[▶ Troubleshooting](#)

How to Use

[Parts Description](#)

[Setup](#)

[Network / Internet](#)

[Connections](#)

[Settings](#)

[Playback](#)

[Backup / Recovery](#)

[Security](#)

[Other Operations](#)

[Notifications](#)

Welcome

Congratulations on the purchase of this VAIO(R) computer.

This User Guide - Introduction Version provides you with limited information about your VAIO computer. To update this file to the complete version of the User Guide, see [Updating the User Guide to the Latest Version \[Details\]](#) for more information. Your VAIO computer does not support touch screen operations depending on the model you purchased. In such a case, use a mouse for computer operations.

Read this first

- [Updating the User Guide to the Latest Version](#)
- [Connecting to the Internet](#)
- [Updating Your VAIO Computer](#)
- [Solving Problems on Your VAIO Computer Using VAIO Care](#)
- [Finding Support Information](#)

Windows 8 basic operations

- [Overview](#)
- [Opening the Charms Bar](#)
- [Searching/Starting Apps or Files](#)
- [Showing the Start Screen](#)
- [Showing the Running Apps List](#)
- [Showing App commands or All Apps](#)
- [Activating Sleep Mode or Shutting Down or Restarting Your VAIO Computer](#)

[Trademarks](#)

[^ Go to top](#)

Read This First

Updating the User Guide to the Latest Version

By updating this User Guide - Introduction Version through the Internet, you can get the complete version of the User Guide with detailed information on your VAIO computer. Once the User Guide is updated to the complete version, you can access it anytime even if you are offline.

With the complete version of the User Guide, you can view information about:

- Parts description
- Feature and operating instructions
- Precautions
- Troubleshooting information
- Windows 8 basic operations

Below is an example of a screenshot in English.



* Design and content of the screen are subject to change.

To get the complete version of the User Guide

1. Connect your VAIO computer to the Internet. [\[Details\]](#)
2. Exit this User Guide - Introduction Version.
3. Open the Charms bar [\[Details\]](#), then select  (Search).
4. Select Apps.
5. Enter "VAIO Manual" in the Search box.
6. Select VAIO Manual from the list.
7. After a window prompting you to update the manual appears, follow the on-screen instructions to complete the updates.

This file will automatically update to the complete version of the User Guide.

If the window prompting you to update the User Guide does not appear, make sure your VAIO computer is connected to the Internet and repeat the above steps.

If the update window still does not appear, launch VAIO Update so you can find and download the User Guide manually. See [Updating Your VAIO Computer \[Details\]](#) for more information on VAIO Update.

Hint

- It may take some time to complete the update.

To view help files for Windows OS and app operations

When you have trouble operating your VAIO computer, try referring to Windows Help and Support or help files included with your apps.

To access Windows Help and Support, open the Charms bar, then enter "Help and Support" in the Search box. [\[Details\]](#)

[^ Go to top](#)

Connecting to the Internet

You will need to connect your VAIO computer to the Internet before updating to the complete version of the User Guide.

Before connecting to the Internet

Before using the Internet, you will need to sign up with an Internet Service Provider (ISP) and set up devices required for connecting your VAIO computer to the Internet.

The following types of Internet connection services may be available from your ISP:

- Fiber to the Home (FTTH)
- Digital Subscriber Line (DSL)
- Cable modem
- Satellite
- Dial-up

For more information on devices required for Internet access and how to connect your VAIO computer to the Internet, ask your ISP.

The following is one of the Internet connection methods as an example.

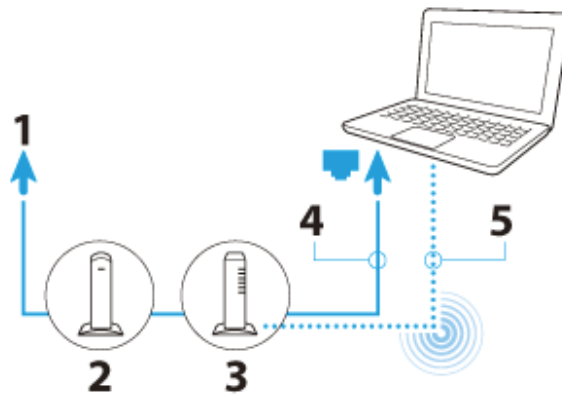

1. Internet
2. Modem
3. Router/access point
4. LAN cable (not supplied)
5. Wireless LAN



To use the network (LAN)

You can connect your VAIO computer to networks with a LAN cable. Connect one end of a LAN cable to the LAN port on the computer and the other end to your network. For detailed settings and devices required for LAN access, ask your network administrator.

Note

- The connection, setting method, or required devices may vary depending on your network environment.

To use the wireless LAN network (Wi-Fi)

1. Open the Charms bar [\[Details\]](#), then select  (Settings).
2. Select  (Network).
3. Select your desired network from the list and @@Connect@@.

Note

- For detailed information on network settings and devices, refer to the information from your Internet Service Provider (ISP) or the manuals that came with your network devices.

[^ Go to top](#)

Updating Your VAIO Computer

Be sure to update your VAIO computer with the following apps to enhance the computer's efficiency, security, and functionality.

Note

- Your VAIO computer must be connected to the Internet to download the updates.

To use Windows Update

Windows Update enables you to make your VAIO computer more stable.

1. Open the Charms bar [\[Details\]](#), then select  (Search).
2. Select Settings.
3. Enter "Windows Update" in the Search box.
4. Select Windows Update from the list.

5. Follow the on-screen instructions to complete the updates.

To use VAIO Update

VAIO Update automatically notifies you of new updates available on the Internet then downloads and installs them on your VAIO computer.

1. Press the ASSIST button while your VAIO computer is on. VAIO Care starts.
2. Select @@Maintenance@@ and VAIO Update.
3. Follow the on-screen instructions to complete the updates.

To update the antivirus app

Help protect your VAIO computer against security threats by keeping Internet security programs current with the latest updates. You can download and install the updates from the website of the manufacturer.

1. Open the Charms bar [Details], then select  (Search).
2. Select Apps.
3. Enter the antivirus app name in the Search box.
4. Select the antivirus app from the list.
5. Follow the on-screen instructions to complete the updates.

[^ Go to top](#)

Solving Problems on Your VAIO Computer Using VAIO Care

With VAIO Care, you can regularly conduct performance checks and system tune-ups on your VAIO computer to keep it running at optimum level. Launch VAIO Care whenever a problem arises. VAIO Care will provide appropriate measures and support information to solve the problem.

To launch VAIO Care

Press the ASSIST button while your VAIO computer is on. Below is an example of a screenshot in English.



* Design and content of the screen are subject to change.

Hint

- Alternatively, search VAIO Care on the Charms bar to launch VAIO Care.
- Refer to the help file included with VAIO Care for more information.
- Pressing the ASSIST button while your VAIO computer is off displays the VAIO Care Rescue Mode screen. You can recover the computer by selecting @@Recover or maintain your system@@ in case of emergency, for example, when Windows does not start.

[^ Go to top](#)

Finding Support Information

The Sony online support website provides instant access to information on commonly encountered problems. You can find support information such as the support website URL in Contact & Support on VAIO Care or the supplied Quick Start Guide.

[^ Go to top](#)

Windows 8 Basic Operations

Overview

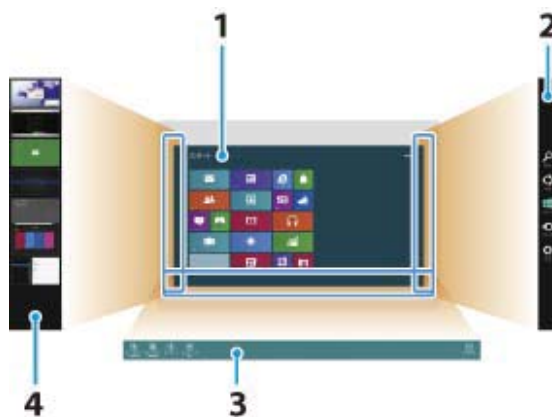

1. Start screen
Main app tiles and the shortcut to the desktop
2. Charms bar
@@Search@@, @@Share@@, @@Start@@, @@Devices@@, @@Settings@@
3. @@App bar@@
@@Save@@, @@Edit@@, @@All apps@@, other operations (Alternatively, the app bar appears at the top of the screen.)
4. Running apps list

[^ Go to top](#)

Opening the Charms Bar

Touch screen operation

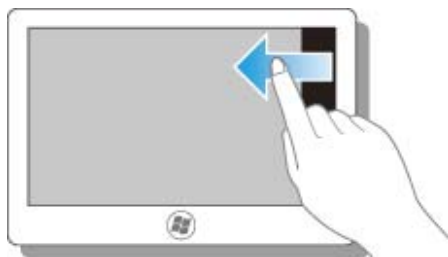

Swipe your finger from the right edge of the screen to the center.

Mouse operation

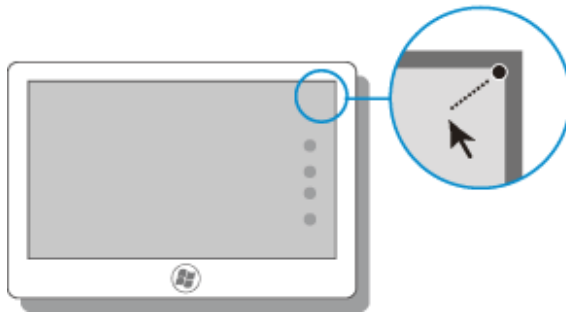

Place the pointer at the top right corner of the screen, then move the pointer down when the Charms appear.

Keyboard operation



Press the C key while holding down the  (Windows) key.

[^ Go to top](#)

Searching/Starting Apps or Files



1. Open the Charms bar [\[Details\]](#), then select  (Search).
2. Select Apps or @@File@@.
3. Enter keywords in the Search box.
4. Select your desired app or file.

[^ Go to top](#)

Showing the Start Screen

Touch screen operation

Open the Charms bar [\[Details\]](#), then tap  (Start).

Mouse operation

Open the Charms bar [\[Details\]](#), then click  (Start).

Keyboard operation



Press the  (Windows) key.

[^ Go to top](#)

Showing the Running Apps List

Touch screen operation

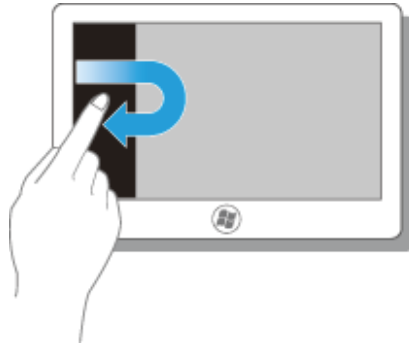

Slide your finger from the left edge of the screen to show an app icon(s), then slide the finger back to the edge.

Mouse operation

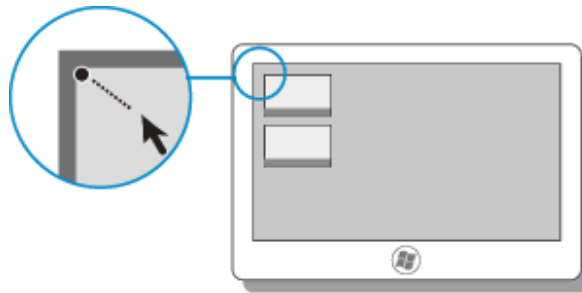

Place the pointer at the top left corner of the screen to show an app icon(s), then move the pointer down.

Keyboard operation



Press the Tab key while holding down the  (Windows) key.

[^ Go to top](#)

Showing App commands or All Apps

Touch screen operation

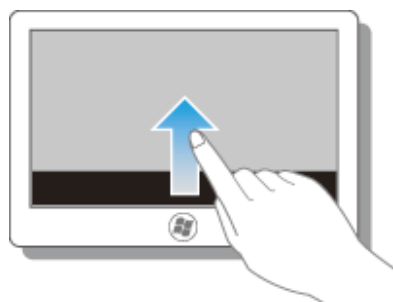

Swipe your finger from the bottom or top edge of the screen to the center.

Mouse operation

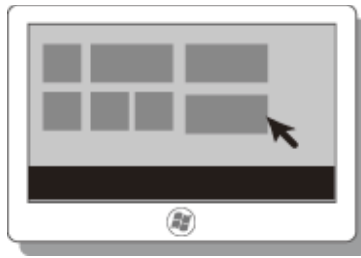

- To show @@App commands@@:
Right-click. (When the Start screen is displayed, select an app and right-click.)
- To show @@All apps@@:
Right-click on the Start screen.

Keyboard operation





Press the Z key while holding down the  (Windows) key.

[^ Go to top](#)

Activating Sleep Mode or Shutting Down or Restarting Your VAIO Computer



1. Open the Charms bar [Details], then select  (Settings).
2. Select  (Power) and Sleep, Shut down, or Restart.

[^ Go to top](#)

Trademarks

- SONY and the SONY logo are registered trademarks of Sony Corporation.
- VAIO, the VAIO logo, and other Sony product or service names are trademarks or registered trademarks of Sony Corporation or any of its affiliates.
- Windows and the Windows logo are either registered trademarks or trademarks of Microsoft Corporation in the United States and/or other countries.
- All other names of system, products, and services are trademarks of their respective owners.
- In the manual, the TM or (R) marks are not specified.

[^ Go to top](#)

[▶ Troubleshooting](#)

How to Use

[Parts Description](#)

[Setup](#)

[Network / Internet](#)

[Connections](#)

[Settings](#)

[Playback](#)

[Backup / Recovery](#)

[Security](#)

[Other Operations](#)

[Notifications](#)

Checking Supplied Items

Check all items packed with the product before use.

Wireless keyboard*

USB keyboard*

Wireless mouse*

USB mouse*

Remote commander*

AA batteries

- Alkaline batteries for the keyboard and mouse (2)*
- Manganese batteries for the remote commander (2)*

* Not supplied with all models. Availability depends on your computer's specifications.

AC adapter

Power cord

Hint

- No Recovery Media is included because your VAIO computer can be recovered using data stored in the hard disk drive or SSD. See Recovering from the Recovery Area for more information.[\[Details\]](#)
-

[▶ Troubleshooting](#)

How to Use

- [Parts Description](#)
- [Setup](#)
- [Network / Internet](#)
- [Connections](#)
- [Settings](#)
- [Playback](#)
- [Backup / Recovery](#)
- [Security](#)
- [Other Operations](#)
- [Notifications](#)

Parts and Controls on the Front

Describes the features on the front of the VAIO computer, such as buttons and indicator lights.

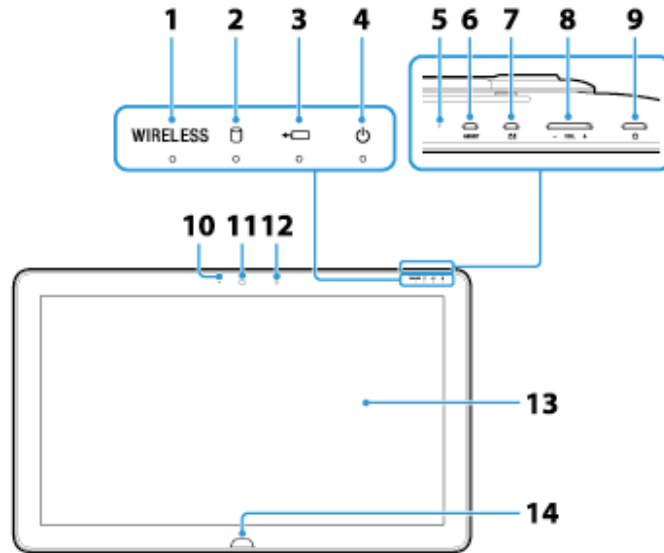

1. WIRELESS indicator [\[Details\]](#)
2. Disc drive indicator
3. Charge indicator [\[Details\]](#)
4. Power indicator [\[Details\]](#)
5. Built-in microphone (monaural)
6. ASSIST button [\[Details\]](#)
7. Rotation lock button
8. VOL (Volume) buttons
9. Power button [\[Details\]](#)
10. Built-in camera indicator [\[Details\]](#)
11. Built-in camera [\[Details\]](#)
12. Ambient light sensor [\[Details\]](#)
13. Touch screen [\[Details\]](#)
14. Windows button

Notes on the LCD screen

The LCD screen is manufactured using high-precision technology. You may, however, see tiny black points and/or bright points (red, blue, or green) that continuously appear on the LCD screen. The ratio of defective pixels to all available pixels of the LCD screen is less than 0.0006 %. Also, depending on the viewing angle, uneven stripes of changes in color and luminance may appear. These are normal results of the LCD screen construction and do not indicate a malfunction. Take note that returns and replacements are not accepted.

Related Topic

- [Parts and Controls on the Sides](#)
- [Parts and Controls on the Back](#)

[▶ Troubleshooting](#)

How to Use

- [Parts Description](#)
- [Setup](#)
- [Network / Internet](#)
- [Connections](#)
- [Settings](#)
- [Playback](#)
- [Backup / Recovery](#)
- [Security](#)
- [Other Operations](#)
- [Notifications](#)

Parts and Controls on the Sides

Describes the features on the sides of the VAIO computer, such as connection ports.

Right side

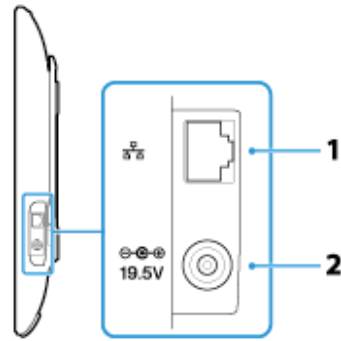

1. LAN port [\[Details\]](#)
2. DC IN port [\[Details\]](#)

Left side

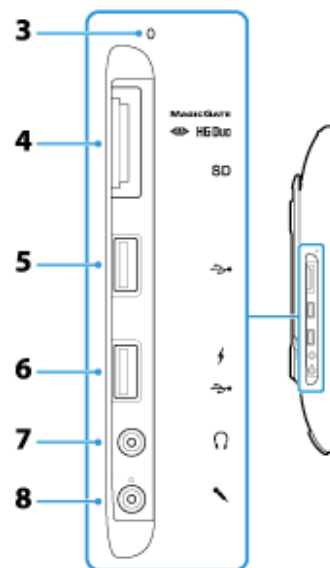

3. Media access indicator ("Memory Stick Duo" [\[Details\]](#), SD memory card [\[Details\]](#))
4. "Memory Stick Duo" / SD memory card combined slot ("Memory Stick Duo" [\[Details\]](#), SD memory card [\[Details\]](#))
"Memory Stick Duo" and an SD memory card cannot be inserted into the slot simultaneously.
5. USB port [\[Details\]](#)
6. USB port [\[Details\]](#)
7. Headphones jack [\[Details\]](#)
8. Microphone jack [\[Details\]](#)

[▶ Troubleshooting](#)

How to Use

- [Parts Description](#)

- [Setup](#)

- [Network / Internet](#)

- [Connections](#)

- [Settings](#)

- [Playback](#)

- [Backup / Recovery](#)

- [Security](#)

- [Other Operations](#)

- [Notifications](#)

Parts and Controls on the Back

Describes the features on the back of the VAIO computer, such as connection ports.

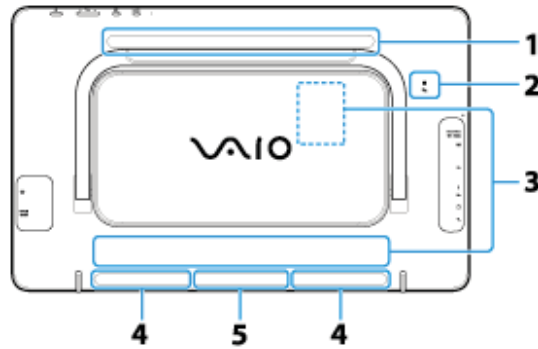

1. Air exhaust vent
2. NFC port
3. Rating plate
There is a rating plate on the back or in the back panel of the computer.
4. Built-in speakers (stereo)
5. Air intake vent

Note

- The air exhaust vent may get hot during use. Take care when touching it.

Related Topic

- [Parts and Controls on the Front](#)
- [Parts and Controls on the Sides](#)

▶ Troubleshooting

How to Use



- [Parts Description](#)
- [Setup](#)
- [Network / Internet](#)
- [Connections](#)
- [Settings](#)
- [Playback](#)
- [Backup / Recovery](#)
- [Security](#)
- [Other Operations](#)
- [Notifications](#)

Parts and Controls of the Keyboard

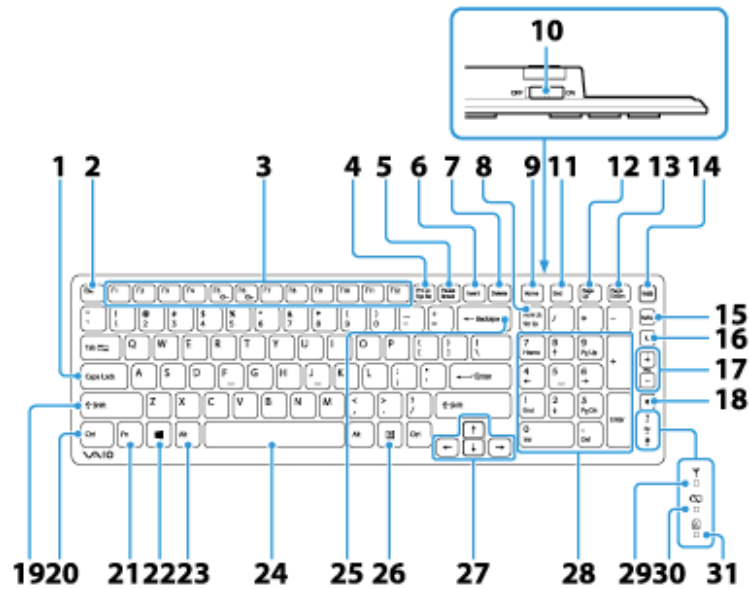
Describes the features of the keyboard, such as keys, buttons and indicator lights.



1. Caps Lock key [\[Details\]](#)
2. Esc key
3. Function keys [\[Details\]](#)
4. Prt Sc key
5. Pause / Break key
6. Insert key
7. Delete key
8. Num Lk / Scr Lk key [\[Details\]](#)
9. Home key
10. Power switch of the keyboard
11. End key
12. Page Up key
13. Page Down key
14. WEB button
15. MAIL button
16. Sleep button [\[Details\]](#)
17. Volume control buttons [\[Details\]](#)
18. Muting button [\[Details\]](#)
19. Shift key
20. Ctrl key
21. Fn key [\[Details\]](#)
22. (Windows) key
23. Alt key
24. Space bar
25. Backspace key

- 26. Applications key
- 27. Directional arrow keys
- 28. Numeric keypad
- 29.  Connect indicator [\[Details\]](#)
- 30.  Battery indicator [\[Details\]](#)
- 31.  Caps lock indicator [\[Details\]](#)

Hint

- There is a raised dot on the F, J and 5 keys.
- After 10 minutes of idle time, the keyboard enters the power saving mode and all indicator lights turn off.

Related Topic

[Replacing the AA Battery of the Keyboard](#)

[Checking the Remaining Battery Power of the Keyboard](#)

[About the Usage Environment for the Keyboard](#)

[Connecting the Wireless Keyboard](#)

[▶ Troubleshooting](#)

How to Use

[Parts Description](#)[Setup](#)[Network / Internet](#)[Connections](#)[Settings](#)[Playback](#)[Backup / Recovery](#)[Security](#)[Other Operations](#)[Notifications](#)

Parts and Controls of the Mouse

Describes the features of the mouse, such as buttons.

Top

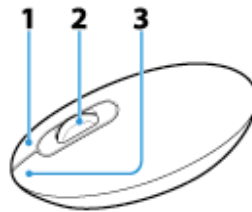

1. Right button
2. Central wheel
3. Left button

Bottom

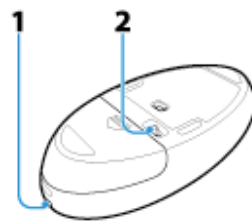

1. Status light [\[Details\]](#)
2. Power switch of the mouse

Related Topic

[Replacing the AA Battery of the Mouse](#)[Checking the Remaining Battery Power of the Mouse](#)[About the Usage Environment for the Mouse](#)[Connecting the Wireless Mouse](#)

[▶ Troubleshooting](#)**How to Use**[Parts Description](#)[Setup](#)[Network / Internet](#)[Connections](#)[Settings](#)[Playback](#)[Backup / Recovery](#)[Security](#)[Other Operations](#)[Notifications](#)**Setting the Stand**

This section describes how to set the stand.

1. Place your VAIO computer gently face down on a soft cloth, etc.
2. Pull up the stand, holding the bottom of your VAIO computer, as in the illustration below.

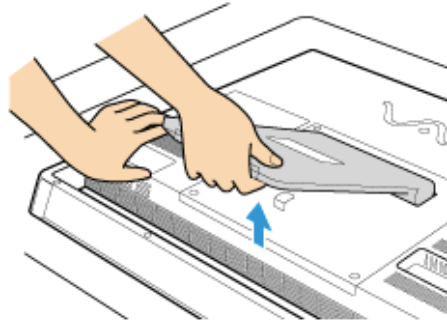
**Note**

- Pull up the stand with slight force until it clicks.

Related Topic[Adjusting the Angle of the Screen](#)

[▶ Troubleshooting](#)**How to Use**[Parts Description](#)[Setup](#)[Network / Internet](#)[Connections](#)[Settings](#)[Playback](#)[Backup / Recovery](#)[Security](#)[Other Operations](#)[Notifications](#)

Adjusting the Angle of the Screen

You can adjust the screen angle of your choice.
Adjust the angle, holding the upper part of the screen.

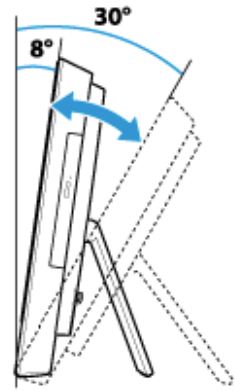
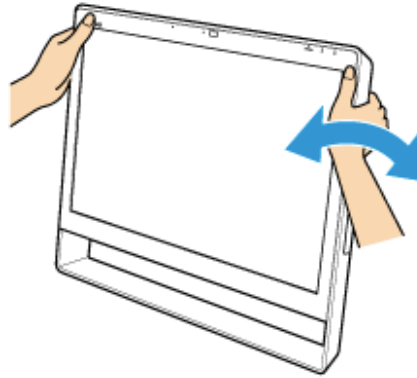

The angle of your VAIO computer can be adjusted from approximately 8 to 30 degrees.

Note

- Do not exert excessive pressure on your VAIO computer while adjusting the angle of the screen, as damage may result.

Related Topic

[Setting the Stand](#)

[▶ Troubleshooting](#)**How to Use**[Parts Description](#)[Setup](#)[Network / Internet](#)[Connections](#)[Settings](#)[Playback](#)[Backup / Recovery](#)[Security](#)[Other Operations](#)[Notifications](#)

Replacing the AA Battery of the Keyboard

Change the AA battery in the keyboard when the battery power becomes low.

1. Set the power switch of the keyboard to OFF.

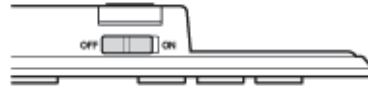

2. Turn over the keyboard, and then push the center of the cover in the direction shown in the illustration below.

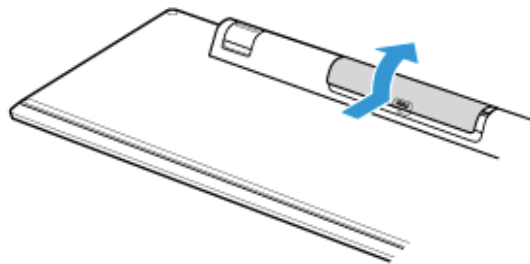

3. Remove the old battery and insert a new AA alkaline battery (minus (-) end first), then close the cover.

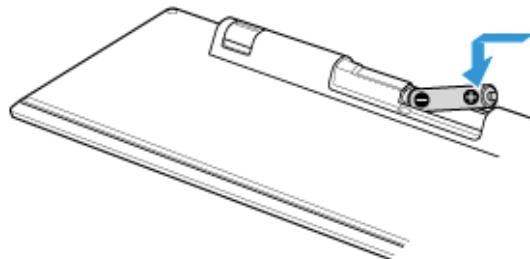

4. Set the power switch of the keyboard to ON.

**Note**

- Use a new AA alkaline replacement battery.
- If you do not intend to use the keyboard for a while, set the power switch of the keyboard to OFF. If you do not intend to use the keyboard for an extended period of time, remove its AA battery.
- When the battery power becomes low, replace with a new AA battery promptly. Keeping a depleted battery in the keyboard may cause battery leakage.
- Since the keyboard cannot be used with a commercially available rechargeable battery, use a non-rechargeable AA battery. If you use a rechargeable battery, battery leakage may occur, resulting in a malfunction.
- Do not recharge a dry cell AA battery.
- Refer to the supplied safety information manual.

Related Topic[Parts and Controls of the Keyboard](#)[Checking the Remaining Battery Power of the Keyboard](#)

[▶ Troubleshooting](#)

How to Use

[Parts Description](#)[Setup](#)[Network / Internet](#)[Connections](#)[Settings](#)[Playback](#)[Backup / Recovery](#)[Security](#)[Other Operations](#)[Notifications](#)

Checking the Remaining Battery Power of the Keyboard

The remaining battery power of the keyboard can be checked by the  battery indicator.

1. Check the  battery indicator of the keyboard.



It blinks when the battery is running out of power.

The indicator is only a guide and may not show the remaining battery power accurately, depending on the AA battery.

Hint

- If you intend not to use the keyboard for a long time, slide the power switch to OFF to extend battery life.

Related Topic

[Parts and Controls of the Keyboard](#)[Replacing the AA Battery of the Keyboard](#)

[▶ Troubleshooting](#)

How to Use

[Parts Description](#)[Setup](#)[Network / Internet](#)[Connections](#)[Settings](#)[Playback](#)[Backup / Recovery](#)[Security](#)[Other Operations](#)[Notifications](#)

About the Usage Environment for the Keyboard

This section explains how to use the wireless keyboard.

You can use the wireless keyboard up to 33 ft. / 10 m away from your VAIO computer.

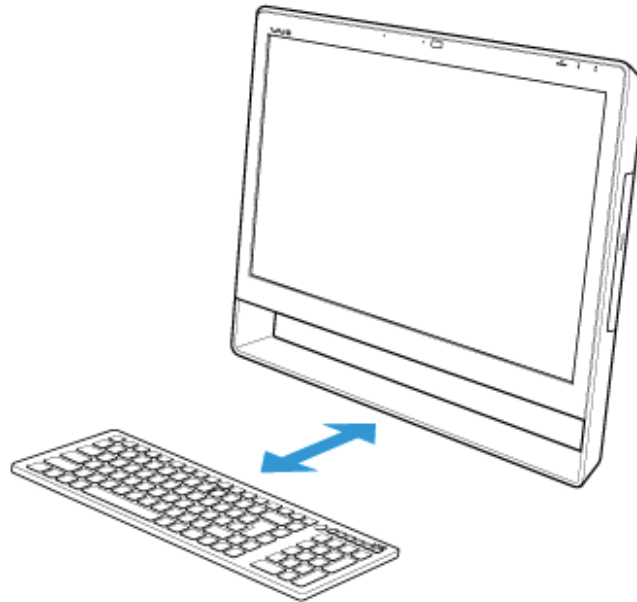

Note

- Do not allow water to enter the wireless keyboard as malfunction may result.
- Depending on the usage environment, the communication range between the wireless keyboard and your VAIO computer may be less than 33 ft. / 10 m.
- If you use the wireless keyboard too close to your VAIO computer (within 4 inches / 10 cm), wireless communication may be affected and keyboard input may become unstable. We recommend that you use the wireless keyboard at least 6 inches / 15 cm away from metal objects and your VAIO computer.

Related Topic

[Connecting the Wireless Keyboard](#)



[▶ Troubleshooting](#)

How to Use

[Parts Description](#)[Setup](#)[Network / Internet](#)[Connections](#)[Settings](#)[Playback](#)[Backup / Recovery](#)[Security](#)[Other Operations](#)[Notifications](#)

Connecting the Wireless Keyboard

If you cannot use the wireless keyboard supplied with the computer, it is likely that wireless connection setup is required between the wireless keyboard and your VAIO computer. Use the mouse to perform wireless setup. You can also use a USB keyboard (not supplied), etc.

1. Check that an AA battery is inserted in the wireless keyboard you want to connect, and then set the power switch of the keyboard to OFF.
2. Press the  (Power) button on your VAIO computer to turn it on.
3. If there are multiple Windows user accounts, select the administrator account. When you have set the Windows password, click  in the lower left corner of the screen. Click the Use the computer without a keyboard (On-Screen Keyboard) check box. Click OK. Enter the password using the on-screen keyboard by mouse operation, then click .

Hint

- If you cannot enter the password using the on-screen keyboard, click the password entry field by the mouse. The cursor starts to blink, and you can use the on-screen keyboard again.
4. When Windows starts, click , and My Computer.
 5. Double-click Local Disk C:, WConnectTool, and WConnect. If the User Account Control window appears, click Yes.
 6. After the connection utility window appears, set the power switch of the keyboard to ON. It may take a few moments to display the connection utility window.
 7. Close the screen after the connection utility window changes, and you can use the wireless keyboard.

Note

- The connection procedure is not usually required to use the wireless keyboard with your VAIO computer.
- Do not perform the connection procedure if you can use the wireless keyboard normally. Doing so may cause computer malfunction.

Hint

- You can start your VAIO computer using the on-screen keyboard if you set the Windows password. However, to set your password by BIOS setup, you need a USB keyboard (not supplied), as starting your VAIO computer by mouse operation alone is not possible.

Related Topic

[About the Usage Environment for the Keyboard](#)

[▶ Troubleshooting](#)

How to Use

[Parts Description](#)

[Setup](#)

[Network / Internet](#)

[Connections](#)

[Settings](#)

[Playback](#)

[Backup / Recovery](#)

[Security](#)

[Other Operations](#)

[Notifications](#)

Checking the Caps Lock / Num Lock / Scroll Lock States

You can check if the keyboard is in the Caps Lock/Num Lock/Scroll Lock states by the indicator light of the keyboard and the icons in the notification area.



To check if the keyboard is in the Caps Lock state

1. Check if the  Caps lock indicator light is on.

To check if the keyboard is in the Num Lock/Scroll Lock state

1. Check if the  Num lock icon or  Scroll lock icon in the notification area is green.

Hint

- To make the  Num lock icon and  Scroll lock icon always visible in the notification area of the desktop, click  in the notification area, click [Customize...](#), and then change the behavior of the icons to Show icon and notifications.

Related Topic

[Parts and Controls of the Keyboard](#)

[▶ Troubleshooting](#)**How to Use**[Parts Description](#)[Setup](#)[Network / Internet](#)[Connections](#)[Settings](#)[Playback](#)[Backup / Recovery](#)[Security](#)[Other Operations](#)[Notifications](#)

Replacing the AA Battery of the Mouse

Change the AA battery in the mouse when the battery power becomes low.

1. Set the power switch of the mouse to OFF.

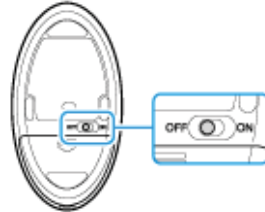

2. Turn the mouse upside down. Hold the center of the cover and slide the battery cover in the direction of the arrow.



3. Remove the old battery and insert a new AA alkaline battery (minus (-) end first), then close the cover.

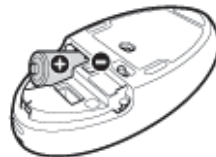

4. Set the power switch of the mouse to ON.

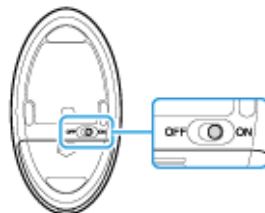
**Note**

- Use a new AA alkaline replacement battery.
- If you do not intend to use the mouse for a while, set the power switch of the mouse to OFF. If you do not intend to use the mouse for an extended period of time, remove its AA battery.
- When the battery power becomes low, replace with the battery promptly. Keeping a depleted battery in the mouse may cause battery leakage.
- Since the mouse cannot be used with a commercially available rechargeable battery, use a non-rechargeable AA battery. If you use a rechargeable battery, battery leakage may occur, resulting in a malfunction.
- Do not recharge a dry cell AA battery.
- Refer to the supplied safety information manual.

Related Topic

[Parts and Controls of the Mouse](#)

[▶ Troubleshooting](#)**How to Use**[Parts Description](#)[Setup](#)[Network / Internet](#)[Connections](#)[Settings](#)[Playback](#)[Backup / Recovery](#)[Security](#)[Other Operations](#)[Notifications](#)

Checking the Remaining Battery Power of the Mouse

The remaining battery power of the mouse can be checked by the status light.

1. Check the status light of the mouse.

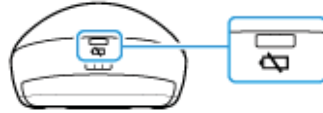

The status light flashes orange when the remaining power of the AA battery is low. The status light is only a guide and may not show the remaining battery power accurately, depending on the AA battery.

Hint

- If you do not intend to use the mouse for a long time, set the power switch to OFF to extend battery life.

Related Topic[Parts and Controls of the Mouse](#)[Replacing the AA Battery of the Mouse](#)

[▶ Troubleshooting](#)

How to Use

[Parts Description](#)[Setup](#)[Network / Internet](#)[Connections](#)[Settings](#)[Playback](#)[Backup / Recovery](#)[Security](#)[Other Operations](#)[Notifications](#)

About the Usage Environment for the Mouse

This section explains how to use the wireless mouse.

You can use the wireless mouse up to 33 ft. / 10 m away from your VAIO computer.

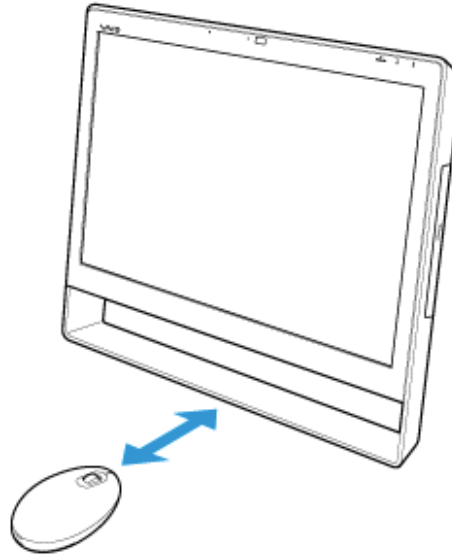

Note

- The wireless mouse supplied with your VAIO computer uses a laser sensor. Mouse operation may become unstable depending on the usage environment.
- Depending on the usage environment, the communication range between the wireless mouse and your VAIO computer may be less than 33 ft. / 10 m.
- If you use the wireless mouse too close to your VAIO computer (within 4 inches / 10 cm), wireless communication may be affected and mouse operation may become unstable. We recommend that you use the wireless mouse at least 6 inches / 15 cm away from metal objects and your VAIO computer.

Related Topic

[Connecting the Wireless Mouse](#)





[▶ Troubleshooting](#)

How to Use

[Parts Description](#)[Setup](#)[Network / Internet](#)[Connections](#)[Settings](#)[Playback](#)[Backup / Recovery](#)[Security](#)[Other Operations](#)[Notifications](#)

Connecting the Wireless Mouse

If you cannot use the wireless mouse supplied with your VAIO computer, it is likely that wireless connection setup is required between the wireless mouse and the computer. Use a keyboard to perform wireless setup. You can also use a USB mouse (not supplied), etc.

1. Check that an AA battery is inserted in the wireless mouse you want to connect, then set the power switch of the mouse to OFF.
2. Press the  (Power) button on your VAIO computer to turn it on.
3. If there are multiple Windows user accounts, press the  or  key to select the administrator account, then press the Enter key.
4. After Windows starts, press the Windows key on the keyboard.
The start menu window appears.
5. Enter wconnect, then press the Enter key.
If the User Account Control window appears, press the  or  key to select Yes, then press the Enter key.
6. After the connection utility window appears, set the power switch of the wireless mouse to ON.
It may take a few moments to display the connection utility window.
7. After the connection utility window changes, close the window. You can now use the wireless mouse.

Note

- The connection procedure is not usually required to use the wireless mouse with your VAIO computer.
- Do not perform the connection procedure if you can use the wireless mouse normally. Doing so may cause computer malfunction.

Related Topic

[About the Usage Environment for the Mouse](#)

[▶ Troubleshooting](#)**How to Use**[Parts Description](#)[Setup](#)[Network / Internet](#)[Connections](#)[Settings](#)[Playback](#)[Backup / Recovery](#)[Security](#)[Other Operations](#)[Notifications](#)

Adding and Removing Memory Modules

If you want to increase your computer's speed or improve performance when running programs simultaneously, increase the amount of memory by installing optional memory modules.

Before you upgrade your computer's memory, see [Notes on Adding and Removing Memory Modules](#).[\[Details\]](#)

If you install memory modules into two or more slots, the dual-channel mode is enabled to help improve performance.

The type of module and the amount of memory installed on your computer may differ depending on the model.

1. Turn off your VAIO computer and peripheral devices, and disconnect the power cord and all connection cables.
2. Wait for a while until your VAIO computer cools down.
The inner parts of your VAIO computer may be hot just after turning off. Be careful to avoid burns while handling your VAIO computer in this state.
3. Lay a clean cloth on a level, flat surface, place your VAIO computer on it as illustrated below. Remove the screws with a cross slot screwdriver to open the memory module compartment cover.
The screw locations are indicated by the arrows in the illustration below.
On some models, captive screws are used on the memory module compartment cover and cannot be detached from the cover.

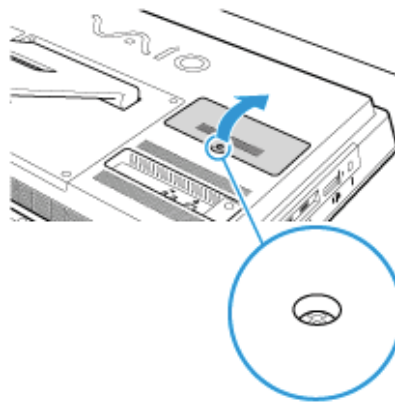

4. Touch an external metal object to discharge static electricity.
Do not touch any metal parts inside your VAIO computer.
5. If there is no free slot, remove the currently installed memory module. Pull the latches in the direction of the arrows to pop up the module at an angle (1), then pull the module out in the direction of the arrow (2).

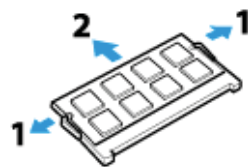

6. Remove the new memory module from its antistatic bag.
7. Hold the memory module by its edge and slide it into the memory module slot with its end terminal facing downward while aligning the notch on the module with the small projection in the slot.



8. Hold the memory module by its edge and push in until it clicks into place as shown in the illustration.

The latches on both sides of the slot snap into place to secure the module. Do not touch any ICs (black components) on the memory module.



9. Replace the memory module compartment cover and secure it with the screws you removed in step 3.
10. Connect all connection cables and peripherals that you removed in Step 1, and turn on the computer.
11. Check that the amount of system memory has correctly changed. [\[Details\]](#)
If the amount of indicated system memory is correct, memory module installation was successful.

Related Topic

[Notes on Adding and Removing Memory Modules](#)

[▶ Troubleshooting](#)

How to Use

[Parts Description](#)

[Setup](#)

[Network / Internet](#)

[Connections](#)

[Settings](#)

[Playback](#)

[Backup / Recovery](#)

[Security](#)

[Other Operations](#)

[Notifications](#)

Notes on Adding and Removing Memory Modules

Before adding or removing memory modules, read the following precautions thoroughly.

- Your VAIO computer and memory modules use high precision components and electronic connector technology. To avoid invalidation of the warranty during your product warranty period, we recommend that:
 - You should contact your dealer to install a new memory module.
 - You should not install a memory module by yourself, if you are not familiar with upgrading memory on a computer.
 - You should not touch the connectors or open the memory module compartment cover.
- For assistance, contact an authorized Sony service/support center. To find the nearest center or agent, refer to online support website. [\[Details\]](#)
- If you add or remove memory modules by yourself, your VAIO computer may result in malfunction or accident caused by breakage of slot and module, or connection mistake. In this case, repair fee will be charged.
- Be careful not to injure your hands or fingers with sharp edges of the memory module, inner components, or circuit boards of your VAIO computer.
- Be careful not to catch your fingers on any inner cables of your VAIO computer, as the cable may become loose or disconnected.
- If your VAIO computer is turned on while liquid such as water or other foreign object remains inside, it may cause a fire. Be sure to remove any foreign objects and attach the memory module compartment cover before turning on your VAIO computer.
- Sony does not guarantee that third party memory modules will work in your VAIO computer. For information on third party memory modules, consult the respective sales dealers.
- Be sure to turn off your VAIO computer and peripherals and disconnect all attachments and connection cables before adding or removing memory modules. Failure to do so may cause damage to the memory module, your VAIO computer, or peripheral devices.
- To prevent damage from electrostatic discharge to memory modules, follow the instructions below:
 - Do not work at a place that produces static electricity easily, such as on a carpet.
 - Before adding or removing memory modules, touch an external metal object from your VAIO computer to eliminate static electricity. Do not touch any metal parts inside the computer.
 - Do not open the memory module package before you are ready to install the module. The package protects the module from ESD (electrostatic discharge). To store the module, cover it with an antistatic bag or a sheet of aluminum foil.
- When holding a memory module, do not touch the chips or electrical terminal of the module.
- Do not insert a memory module into the slot facing in wrong direction. It may cause damage to the module or slot, or cause the circuit board to catch fire.
- Use a screwdriver that matches the size of the screw (such as a miniature screwdriver).
- Do not remove or loosen screws that are not specified to be removed.

Related Topic

[Adding and Removing Memory Modules](#)[Viewing the System Information](#)

[▶ Troubleshooting](#)

How to Use

[Parts Description](#)

[Setup](#)

[Network / Internet](#)

[Connections](#)

[Settings](#)

[Playback](#)

[Backup / Recovery](#)

[Security](#)

[Other Operations](#)

[Notifications](#)

Installing/Removing the Battery Pack

Install the battery pack into the battery compartment on the bottom of your VAIO computer.

Note

- You will lose all unsaved data if you remove the battery pack while your VAIO computer is on or in Sleep mode and not connected to the AC adapter.
Be sure to turn off the computer before removing the battery pack.

Related Topic[Charging the Battery Pack](#)[Notes on Using the Battery Pack](#)[Shutting Down Your VAIO Computer](#)

[▶ Troubleshooting](#)

How to Use



[Parts Description](#)[Setup](#)[Network / Internet](#)[Connections](#)[Settings](#)[Playback](#)[Backup / Recovery](#)[Security](#)[Other Operations](#)[Notifications](#)

Charging the Battery Pack

The battery pack can be charged even while you are using your VAIO computer when the computer is connected to a power source. The charging time may vary depending on operating conditions.

1. Install the battery pack into your VAIO computer. [\[Details\]](#)
2. Plug your VAIO computer into an AC outlet. [\[Details\]](#)

Hint

- The charging time varies depending on ambient temperature. Note that at a low ambient temperature, it takes longer time to charge the battery pack.
- To check the battery status of your VAIO computer, click the battery icon, such as  (on battery) or  (plugged in), in the desktop notification area.

Related Topic

[Charge Indicator Status List](#)[Checking the Battery Charge Capacity](#)[Extending the Battery Life](#)

[▶ Troubleshooting](#)

How to Use

[Parts Description](#)

[Setup](#)

[Network / Internet](#)

[Connections](#)

[Settings](#)

[Playback](#)

[Backup / Recovery](#)

[Security](#)

[Other Operations](#)

[Notifications](#)

Extending the Battery Life

When your VAIO computer is running on battery power, you can extend the battery life using the following methods.

- Use Sleep mode. [\[Details\]](#)

When you do not need to use your VAIO computer temporarily, you can use Sleep mode. To extend the battery life, use Sleep mode frequently. If you do not intend to use the computer for an extended period of time, turn off the computer.

Resuming the computer from Sleep mode is faster than from booting up the computer.

- Decrease the LCD brightness of the computer screen. [\[Details\]](#)
- Turn down the volume of the speakers and headphones. [\[Details\]](#)
- Disconnect peripheral devices that are not in use.

Related Topic

[Checking the Battery Charge Capacity](#)[Charging the Battery Pack](#)[Notes on Using the Battery Pack](#)[Using Sleep Mode](#)

[▶ Troubleshooting](#)

How to Use

[Parts Description](#)

[Setup](#)

[Network / Internet](#)

[Connections](#)

[Settings](#)

[Playback](#)

[Backup / Recovery](#)

[Security](#)

[Other Operations](#)

[Notifications](#)

Notes on Using the Battery Pack

Before using the battery pack, read the following precautions for correct use.

About the battery pack

- The supplied battery pack is designed specifically for your VAIO computer.
- For your safety, only use the supplied battery pack or an optional battery pack that is specified by Sony.
- For safety reasons, battery charging may be suspended at higher or lower temperatures.
- While your VAIO computer is connected to an AC outlet with the AC adapter, it runs on AC power, even if the battery pack is installed.
- The battery pack is not fully charged at the time of delivery.
- While the battery pack is in use or being charged, heat builds up in the battery pack. This is normal and is not cause for concern.
- Do not use your VAIO computer without installing the battery pack as it may cause the computer to malfunction.

About battery discharge

After battery charge, the battery pack will gradually discharge over time even while not in use. If it is left unused for an extended period of time, the battery power may be depleted. It is recommended that you recharge the battery pack before use.

About battery life

Battery life varies depending on usage and settings.

About battery deterioration and replacement

- The battery pack is consumable. The capacity gradually declines through repeated cycles of recharging and discharging. As a result, the battery life becomes short even if it is fully charged and eventually the battery pack reaches the end of its life.
- If the battery pack quickly runs out of power after being fully charged or it has reached the end of its life, replace it with a new one.

When the battery pack is running out of power

If the battery pack runs out during your absence, power will be cut off and any data you are working on will be lost.

While your VAIO computer is running on battery power, save data frequently.

Related Topic

[Notes on Using the Power Source](#)

[▶ Troubleshooting](#)**How to Use**[Parts Description](#)[Setup](#)[Network / Internet](#)[Connections](#)[Settings](#)[Playback](#)[Backup / Recovery](#)[Security](#)[Other Operations](#)[Notifications](#)

Connecting a Power Source

Connect your VAIO computer to an AC power source. Carefully read the precautions in Notes on Using the Power Source before connection. [\[Details\]](#)

1. Plug one end of the power cord (1) into the AC adapter (3).
2. Plug the other end of the power cord into an AC outlet (2).
3. Plug the cable from the AC adapter (3) into the DC IN port (4) on your VAIO computer.

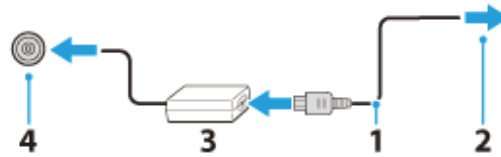
**Note**

- Do not plug more than one device into the same AC outlet.
- The shape of the AC adapter varies depending on the model you purchased.
- Make sure that the power plug is firmly plugged into your VAIO computer.

Hint

- You can purchase a power strip with a surge protector to help prevent damage to your VAIO computer caused by sudden power surges (in an electrical storm, for example).

Related Topic[Installing/Removing the Battery Pack](#)[Charging the Battery Pack](#)[Notes on Using the Battery Pack](#)[Turning on Your VAIO Computer](#)[Shutting Down Your VAIO Computer](#)[Notes on Using the Power Source](#)

[▶ Troubleshooting](#)

How to Use



[Parts Description](#)[Setup](#)[Network / Internet](#)[Connections](#)[Settings](#)[Playback](#)[Backup / Recovery](#)[Security](#)[Other Operations](#)[Notifications](#)

Turning on Your VAIO Computer

Turn on your VAIO computer to start Windows. Carefully read the precautions in Notes on Using the Power Source before turning on. [\[Details\]](#)

1. Install the battery pack on your VAIO computer [\[Details\]](#), and then connect to an AC outlet. [\[Details\]](#)
2. Lift the LCD screen lid.
3. Press and hold down the  (Power) button until the power indicator light turns on in green.
Your VAIO computer is turned on, and Windows starts after a while.

Note

- If you press and hold down the  (Power) button for more than four seconds, your VAIO computer will not turn on.
Press the  (Power) button lightly, and release it immediately when the power indicator light turns on.
- Do not use your VAIO computer without installing the battery pack as it may cause the computer to malfunction.
- When opening the LCD screen lid, do not hold the built-in camera as it may cause your VAIO computer to malfunction. (Built-in camera equipped models)
- If you press the  (Power) button with the LCD screen lid closed, your VAIO computer will not turn on.

Hint

- By default, your VAIO computer automatically enters Sleep mode after a certain period of inactivity while the computer is connected to an AC outlet. [\[Details\]](#)

Related Topic

[Installing/Removing the Battery Pack](#)[Charging the Battery Pack](#)[Notes on Using the Battery Pack](#)[Connecting a Power Source](#)[Shutting Down Your VAIO Computer](#)[Restarting Your VAIO Computer](#)[Notes on Using the Power Source](#)



[▶ Troubleshooting](#)

How to Use

[Parts Description](#)[Setup](#)[Network / Internet](#)[Connections](#)[Settings](#)[Playback](#)[Backup / Recovery](#)[Security](#)[Other Operations](#)[Notifications](#)

Shutting Down Your VAIO Computer

Shut down your VAIO computer properly to avoid losing unsaved data.

1. Turn off any peripherals connected to your VAIO computer.
2. Save your data and close all running apps.
3. Open the Charms bar [\[Details\]](#) and select  (Settings).
4. Select  (Power) and Shut down.

After a short time, your VAIO computer automatically turns off and the green power indicator light turns off.

Before closing the LCD screen lid, make sure the power indicator is off.

Note

- An improper shutdown may cause loss of unsaved data or your VAIO computer to malfunction.
- To disconnect your VAIO computer completely from an AC power source, turn off the computer and unplug the power cord from the AC outlet.

Related Topic

[Turning on Your VAIO Computer](#)[Restarting Your VAIO Computer](#)[Using Sleep Mode](#)[Notes on Using the Power Source](#)

[▶ Troubleshooting](#)

How to Use

[Parts Description](#)

[Setup](#)

[Network / Internet](#)

[Connections](#)

[Settings](#)

[Playback](#)

[Backup / Recovery](#)



[Security](#)

[Other Operations](#)

[Notifications](#)

Restarting Your VAIO Computer

After changing the settings or installing an app on your VAIO computer, you may be required to restart the computer.

1. Save your data and close all running apps.
2. Open the Charms bar [\[Details\]](#) and select  (Settings).
3. Select  (Power) and Restart.
Your VAIO computer will restart.

Related Topic

[Turning on Your VAIO Computer](#)[Shutting Down Your VAIO Computer](#)

[▶ Troubleshooting](#)

How to Use

[Parts Description](#)

[Setup](#)

[Network / Internet](#)

[Connections](#)

[Settings](#)

[Playback](#)

[Backup / Recovery](#)

[Security](#)

[Other Operations](#)

[Notifications](#)

Charge Indicator Status List

The charge indicator light  turns on or blinks differently according to conditions.

Lit in orange

The battery pack is charging. (Turns off when charging is completed.)

Blinks in orange along with the green power indicator 

The battery pack is running out of power. (Normal mode)

Blinks fast in orange

A battery error has occurred due to a failed battery pack or an unlocked battery pack.

Related Topic

[Charging the Battery Pack](#)[Checking the Battery Charge Capacity](#)[Extending the Battery Life](#)

[▶ Troubleshooting](#)

How to Use



[Parts Description](#)[Setup](#)[Network / Internet](#)[Connections](#)[Settings](#)[Playback](#)[Backup / Recovery](#)[Security](#)[Other Operations](#)[Notifications](#)

Using Sleep Mode



In Sleep mode, all unnecessary devices of your VAIO computer are turned off, though some devices stay on to retain the computer's state including data you are working on. Sleep mode is useful when you take a short rest, for example.

With the default Sleep mode settings, Rapid Wake is enabled and the computer's state is saved to the built-in storage device.

To activate Sleep mode

1. Open the Charms bar [\[Details\]](#) and select  (Settings).
2. Select  (Power) and Sleep.
The power indicator light turns off when your VAIO computer enters Sleep mode.

Hint

- By default, your VAIO computer enters Sleep mode automatically after about 30 minutes of inactivity while running on AC power.
- The operations below also place your VAIO computer into Sleep mode.
 - Press the  (Power) button (with the default setting).
Note that if you press and hold down the  (Power) button for more than four seconds, your VAIO computer will turn off automatically. Doing this will erase all unsaved data.
 - Close the LCD screen lid and leave the computer unused for a few seconds.

To return to Normal mode

1. Press the  (Power) button.

Note

- By default, your VAIO computer automatically enters Hibernate mode when the battery pack becomes weak. However, depending on the operating conditions, the computer may fail to enter Hibernate mode.

If this occurs and the battery pack is running out of power, the computer will be turned off, resulting in loss of unsaved data.

While the computer is running on battery power, save data frequently.

- Before moving your VAIO computer, make sure that the power indicator light is off to avoid impact or vibration to the running hard disk drive.

Hint

- If you press and hold down the  (Power) button for more than four seconds, your VAIO computer will turn off automatically. Doing this will erase all unsaved data.
- You can restore your VAIO computer from Sleep mode to Normal mode by opening the LCD screen lid.
To change the action when you open the lid, start VAIO Control Center [\[Details\]](#) and change the settings in @@@Power Management@@@.

Related Topic

[Notes on Using the Power Source](#)[Notes on Sleep Mode](#)[Extending the Battery Life](#)[Changing the Rapid Wake \(Sleep Mode\) Settings](#)

[▶ Troubleshooting](#)

How to Use

[Parts Description](#)

[Setup](#)

[Network / Internet](#)

[Connections](#)

[Settings](#)

[Playback](#)

[Backup / Recovery](#)

[Security](#)

[Other Operations](#)

[Notifications](#)

Selecting a Power Plan

Power management helps you set up power plans to suit your requirements for power consumption.

1. Open Control Panel. [\[Details\]](#)
2. Select Hardware and Sound and Power Options.
3. Select your desired power plan.
4. If you want to change the power plan settings, select Change plan settings on the right of your desired power plan in the Power Options window.
By selecting Change advanced power settings, you can change the advanced settings.
Refer to Windows Help and Support for more information on the power plan settings. [\[Details\]](#)

Hint

- The power status icon indicates what kind of power source your VAIO computer is currently using, and you can see the computer's power status by selecting this icon.
-

[▶ Troubleshooting](#)

How to Use

[Parts Description](#)

[Setup](#)

[Network / Internet](#)

[Connections](#)

[Settings](#)

[Playback](#)

[Backup / Recovery](#)

[Security](#)

[Other Operations](#)

[Notifications](#)

Notes on Using the Power Source

Read the following precautions before plugging your VAIO computer into an AC power source.

- If you remove the battery pack while your VAIO computer is turned on or in Sleep mode but it is disconnected from an AC power source, you may lose all unsaved data.
- If you leave your VAIO computer without connecting it to an AC power source for an extended period of time, turn off the computer.

Notes on the AC adapter

- Use the AC adapter supplied with your VAIO computer or genuine Sony products. Do not use any other AC adapter as it may cause a malfunction.
- Do not connect the AC adapter to a power conversion device such as a travel power converter. It may cause overheating or a malfunction.
- If the AC adapter cable becomes damaged or broken, do not use it.

Notes on turning on your VAIO computer

- Because your VAIO computer contains magnetic components, keep magnetic storage media, such as floppy disks, away from the computer, as it may cause data corruption.
- Your VAIO computer will automatically enter Sleep mode (with the default settings) when you move magnetic devices closer to the computer. Keep magnetic devices away from the computer.

Related Topic

[Connecting a Power Source](#)[Turning on Your VAIO Computer](#)[Shutting Down Your VAIO Computer](#)[Restarting Your VAIO Computer](#)

[▶ Troubleshooting](#)

How to Use

[Parts Description](#)

[Setup](#)

[Network / Internet](#)

[Connections](#)

[Settings](#)

[Playback](#)

[Backup / Recovery](#)

[Security](#)

[Other Operations](#)

[Notifications](#)

Notes on Sleep Mode

Read the following precautions before using Sleep mode.

- Some apps may not support Sleep mode. When running such apps, exit them before placing your VAIO computer into Sleep mode.
- Some USB devices may not support Sleep mode. When your VAIO computer resumes from Sleep mode, the computer may not recognize such USB devices, depending on the type and number of connected USB devices.
If you cannot place the computer into Sleep mode, disconnect all USB devices before placing the computer into Sleep mode.
- If your VAIO computer enters Sleep mode when Windows or the computer is unstable, it may not resume from Sleep mode. The following operations are recommended:
 - Before placing your VAIO computer into Sleep mode, save your files and exit all running apps.
 - Shut down your VAIO computer periodically.
- Depending on the condition of Windows, your VAIO computer cannot enter Sleep mode.
- If your VAIO computer enters Sleep mode while running a task, such as DVD writing, the task may be suspended.

Related Topic

[Using Sleep Mode](#)[Notes on Using the Power Source](#)[Notes on Using the Battery Pack](#)

[▶ Troubleshooting](#)

How to Use

[Parts Description](#)

[Setup](#)

[Network / Internet](#)

[Connections](#)

[Settings](#)

[Playback](#)

[Backup / Recovery](#)

[Security](#)

[Other Operations](#)

[Notifications](#)

About the Touch Screen <Touch screen equipped models>

The touch screen enables direct interaction with your VAIO computer using your finger(s). You can perform various gestures on the touch screen instead of mouse operations, such as selecting items and scrolling. Your VAIO computer supports multi-touch input.

Note

- Your VAIO computer is equipped with a capacitive touch screen. When using it, note the following characteristics of the capacitive touch screen.
 - The touch screen will not work if you touch it with fingernails, or if you wear gloves.
 - If tapping triggers an unintentional operation, make sure that no other parts of your body, including your clothes, are in contact with the touch screen.
 - The surface of the touch screen may get hot. This is normal and does not indicate a malfunction.
 - Even though the surface of the touch screen is tempered glass, it could still become damaged. Treat it with adequate care. If it breaks, small granular shards may scatter and cause injury.
Do not drop the touch screen or subject it to a strong impact. Do not scratch the surface. A surface flaw may cause the glass to break.
 - A protection sheet may be attached to the LCD screen frame at the factory. Remove the sheet before use; otherwise the touch screen may not work correctly.
 - Some apps do not accept touch screen operations.

Related Topic

[<ERROR>](#)

[▶ Troubleshooting](#)

How to Use

[Parts Description](#)

[Setup](#)

[Network / Internet](#)

[Connections](#)

[Settings](#)

[Playback](#)

[Backup / Recovery](#)

[Security](#)

[Other Operations](#)

[Notifications](#)

How to Use the Touch Screen <Touch screen equipped models>

You can tap the touch screen or make a simple motion with your fingers to operate your VAIO computer.

Basic operations

To click (tap)

Tap on the touch screen once with a finger. You can select a button, such as OK and Cancel, or an item in a menu by tapping it.

To double-click (double-tap)

Tap on the touch screen twice in quick succession with a finger. You can start an app, such as a word processor or a spreadsheet program, or open a file by double-tapping its icon.

To right-click (touch and hold)

Touch and hold the desired point on the touch screen for a few seconds and lift your finger off the screen. Depending on the point you touch, you can display various shortcut menus.

To drag

Put a finger on the touch screen and slide it while keeping the finger in contact with the screen. You can move a file or change the window size.

To drag and drop

Touch the desired file icon, slide to another folder, window or software icon, and then lift your finger off the screen. You can move or copy a file.

Advanced operations

You can make a simple motion (gesture) with your fingers on the touch screen to operate your VAIO computer.

The response to a gesture varies depending on the apps.

This section describes the operations for Internet Explorer and @@Photo@@.

To scroll

Touch and slide a scrollable area of a window, such as an Internet Explorer window. You can also drag the slider on the vertical scroll bar of the selected window to scroll it.

To zoom in or out on an image such as a photo (zoom)

Pinch on the touch screen with two fingers for zooming on an image, such as a photo on @@Photo@@. Pinch open to zoom in or pinch close to zoom out.

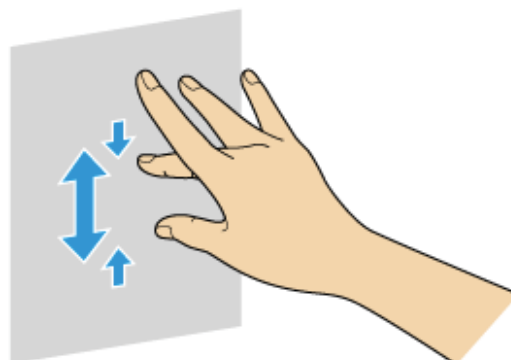

To rotate an image such as a photo (rotate)

Put two fingers on the touch screen and slide them in circles to rotate an image, such as a photo.

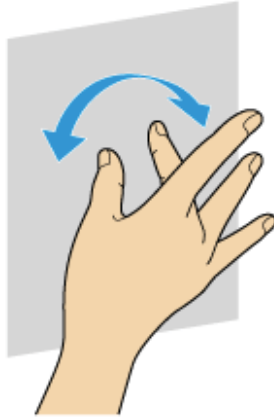

To flick

Put a finger on the touch screen and slide it quickly in a straight line. The response by your VAIO computer is determined by the direction of the flick. There are four default responses: flick left moves forward, flick right moves backward, flick up scrolls up, and flick down scrolls down.

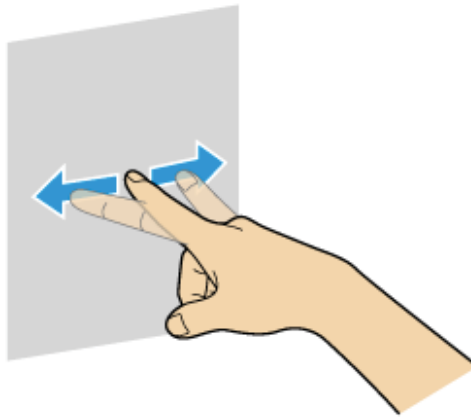

Related Topic

<ERROR>

[▶ Troubleshooting](#)

How to Use

[Parts Description](#)

[Setup](#)

[Network / Internet](#)

[Connections](#)

[Settings](#)

[Playback](#)

[Backup / Recovery](#)

[Security](#)

[Other Operations](#)

[Notifications](#)

Enable/Disable the Touch Screen <Touch screen equipped models>

By default, the touch screen of your VAIO computer is enabled. To disable/enable the touch screen, follow these steps:

1. Open Control Panel [\[Details\]](#) and select Hardware and Sound and Pen and Touch.
2. Select the Touch tab.
3. Select or clear the Use your finger as an input device check box.
Select the check box to enable the touch screen or clear it to disable the touch screen.
4. Select OK.

Related Topic

[How to Use the Touch Screen<Touch screen equipped models>](#)

[▶ Troubleshooting](#)

How to Use

[Parts Description](#)

[Setup](#)

[Network / Internet](#)

[Connections](#)

[Settings](#)

[Playback](#)

[Backup / Recovery](#)

[Security](#)

[Other Operations](#)

[Notifications](#)

Enlarging the Text Size (DPI) <Touch screen equipped models>

You can change the DPI to enlarge the font size, making it easier to touch specific text.

1. Open Control Panel [\[Details\]](#) and select Customize Desktop and Make text and other items larger or smaller.
2. Select the desired settings from the options on the screen and Apply.
3. If a message prompts you to log off, select Log off now.
4. Log on again.
The text font size for Windows changes.

Hint

- You can select Set custom text size (DPI) on the left of the Display window to set the text size more easily.
-

[▶ Troubleshooting](#)

How to Use

[Parts Description](#)

[Setup](#)

[Network / Internet](#)

[Connections](#)

[Settings](#)

[Playback](#)

[Backup / Recovery](#)

[Security](#)

[Other Operations](#)

[Notifications](#)

Notes on Using the Touch Screen <Touch screen equipped models>

Before using the touch screen, read the following precautions for correct use.

- Do not push the touch screen roughly.
Gentle touches always work. The degree of pressing force does not count for operations as your VAIO computer is equipped with a capacitive touch screen.
 - Do not use an object other than your finger to use the touch screen.
The touch screen may be damaged or a malfunction may occur. Be sure to touch only with your finger.
 - Keep the touch screen clean for good touch sensitivity. Dirt may cause damage or a malfunction.
-

[▶ Troubleshooting](#)

How to Use

[Parts Description](#)

[Setup](#)

[Network / Internet](#)

[Connections](#)

[Settings](#)

[Playback](#)

[Backup / Recovery](#)

[Security](#)

[Other Operations](#)

[Notifications](#)

Changing the Resolution (Size) of the Screen Image

You can change the screen resolution to adjust the size of the characters and images on the computer screen.

Refer to Windows Help and Support [\[Details\]](#) for more information.

1. Right-click on the desktop [\[Details\]](#) and select Screen resolution.
2. Select the current screen resolution next to Resolution and move the slider to change the screen resolution.

Note

- You may not be able to play high-resolution videos depending on the amount of video memory on your VAIO computer. In such a case, lower the screen resolution.
- Do not change the display resolution while using video/image apps or playing DVDs, as it may cause unsuccessful playback/display or unstable system operations.

Related Topic

[Notes on the LCD screen](#)

[▶ Troubleshooting](#)

How to Use

[Parts Description](#)

[Setup](#)

[Network / Internet](#)

[Connections](#)

[Settings](#)

[Playback](#)

[Backup / Recovery](#)

[Security](#)

[Other Operations](#)

[Notifications](#)

Notes on the LCD screen

Read the following precautions for correct use of the LCD screen.

- The LCD screen is manufactured using high-precision technology. You may, however, see tiny black points and/or bright points (red, blue, or green) that continuously appear on the LCD screen. This is a normal result of the manufacturing process and does not indicate a malfunction.
- Do not scratch the surface of the LCD screen or exert pressure on it. This could cause damage.
- Do not exert pressure on the LCD screen lid with the lid closed as it may scratch the LCD screen or soil it.
- The LCD screen may become warm during operation. This is normal and does not indicate a malfunction.
- Due to the mechanical design of your VAIO computer's LCD screen/touch screen, the screen surface may become warm while you are using the computer for an extended period of time. This is normal and does not indicate a malfunction. (Touch screen equipped models)
- The LCD screen/touch screen is made of reinforced glass to implement high durability, however, treat the screen with care as it is not 100% unbreakable. In case the screen breaks into small pieces, be careful not to cut yourself on the pieces of broken glass. (Touch screen equipped models)
- Do not leave the LCD screen facing the sun. This could damage the LCD screen. Be sure to block direct sunlight when using your VAIO computer near a window.
- Do not exert pressure on the LCD screen or its edges when opening the LCD screen lid or lifting your VAIO computer. The LCD screen may be sensitive to pressure or added stress, and exerting pressure may damage the screen or cause it to malfunction. When opening the computer, hold the base with one hand and gently lift the LCD screen lid with the other. To carry the computer with the lid open, be sure to hold the computer with both hands.
- Using your VAIO computer in low temperature conditions may produce a residual image on the LCD screen. This does not indicate a malfunction. When the computer returns to normal temperature, the screen returns to normal.
- A residual image may appear on the LCD screen if the same image is displayed for an extended period of time. The residual image disappears after a while. You can use a screen saver to prevent residual images.

[▶ Troubleshooting](#)

How to Use

[Parts Description](#)

[Setup](#)

[Network / Internet](#)

[Connections](#)

[Settings](#)

[Playback](#)

[Backup / Recovery](#)

[Security](#)

[Other Operations](#)

[Notifications](#)

Adjusting the Speakers Volume

You can change the volume level of the speakers and headphones.

To reduce the volume using the Fn key

1. Press the F3 key while holding down the Fn key.
The volume is turned down.

To increase the volume using the Fn key

1. Press the F4 key while holding down the Fn key.
The volume is turned up.

Hint

- You can press the Fn+F2 keys to turn off the speakers and headphones. Press the Fn+F2 keys once more to turn on the volume.
- You can also press the Fn+F4 keys to turn on the volume.

Related Topic

[Adjusting the Volume in Windows](#)[Adjusting the Microphone Volume](#)[Connecting External Speakers or Headphones](#)

[▶ Troubleshooting](#)**How to Use**[Parts Description](#)[Setup](#)[Network / Internet](#)[Connections](#)[Settings](#)[Playback](#)[Backup / Recovery](#)[Security](#)[Other Operations](#)[Notifications](#)

Connecting External Speakers or Headphones

You can connect external sound output devices (such as speakers or headphones) to your VAIO computer.

1. Connect external speakers to the headphones jack  [\[Details\]](#) with a speaker cable (not supplied).

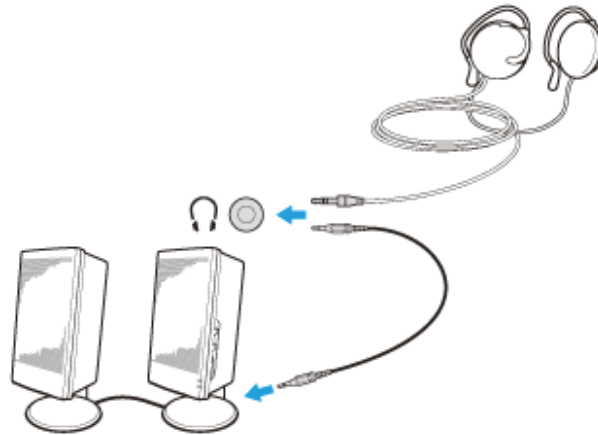
**Note**

- Turn down the volume of the speakers before turning them on.

Hint

- Refer to the manual that came with your speakers or headphones.

Related Topic[Adjusting the Speakers Volume](#)[Connecting an External Microphone](#)[Changing the Sound Output Device](#)[Adjusting the Volume in Windows](#)

[▶ Troubleshooting](#)

How to Use

[Parts Description](#)[Setup](#)[Network / Internet](#)[Connections](#)[Settings](#)[Playback](#)[Backup / Recovery](#)[Security](#)[Other Operations](#)[Notifications](#)

Connecting an External Microphone

You can connect an external microphone to your VAIO computer and enjoy voice chat, etc.

1. Plug the microphone cable into the microphone jack [\[Details\]](#).



Note

- If you connect or disconnect the microphone to/from your VAIO computer while running a voice recording app, voice recording may fail or the app may exit. Connect the microphone and select it as the sound recording device for Windows before starting the app.

Hint

- Use a plug-in-power microphone.
- Refer to the manual that came with your microphone.
- If microphone feedback occurs, move the microphone away from your speakers.

Related Topic

[Adjusting the Microphone Volume](#)[Connecting External Speakers or Headphones](#)

[▶ Troubleshooting](#)

How to Use

[Parts Description](#)

[Setup](#)

[Network / Internet](#)

[Connections](#)

[Settings](#)

[Playback](#)

[Backup / Recovery](#)

[Security](#)

[Other Operations](#)

[Notifications](#)

Changing the Sound Output Device

If there is no sound from the device connected to your VAIO computer, you need to change the device for sound output.

1. Open Control Panel. [\[Details\]](#)
 2. Select Hardware and Sound.
 3. Select Sound.
 4. Select the Playback tab.
 5. Ensure there is a check mark next to the icon of the device you intend to output computer sound from.
If there is no check mark next to the icon, select it and Set Default.
 6. Select OK.
-

[▶ Troubleshooting](#)

How to Use

[Parts Description](#)

[Setup](#)

[Network / Internet](#)

[Connections](#)

[Settings](#)

[Playback](#)

[Backup / Recovery](#)



[Security](#)

[Other Operations](#)

[Notifications](#)

Adjusting the Volume in Windows

You can adjust the volume on each app from Control Panel.

1. Open Control Panel. [\[Details\]](#)
2. Select Hardware and Sound.
3. Select Adjust system volume under Sound.
4. Move a slider in Device up and down to your desired volume level.
When the volume is turned off () , select  (Deactivate muting) to turn on the volume (). When the volume has been minimized, turn the volume up with the slider.

To turn off the Windows startup sound

1. Open Control Panel. [\[Details\]](#)
2. Select Hardware and Sound.
3. Select Sound.
4. Select the Sounds tab.
5. Clear the Play Windows Startup sound check box.
6. Select OK.

Related Topic

[Adjusting the Speakers Volume](#)[Adjusting the Microphone Volume](#)[Connecting External Speakers or Headphones](#)

[▶ Troubleshooting](#)

How to Use

[Parts Description](#)

[Setup](#)

[Network / Internet](#)

[Connections](#)

[Settings](#)

[Playback](#)

[Backup / Recovery](#)

[Security](#)

[Other Operations](#)

[Notifications](#)

Adjusting the Microphone Volume

You can adjust the volume level of the microphone.

1. Open Control Panel [\[Details\]](#).
2. Select Hardware and Sound.
3. Select Sound.
4. Select the Recording tab.
5. Double-click the microphone icon.
6. Select the Levels tab in the Microphone Properties window.
7. Move a slider in Microphone right and left to your desired volume level.
If the microphone volume is still not loud enough even at the maximum volume level, move a slider in Microphone Boost right and left to adjust the volume level.
8. Select OK.

Related Topic

[Connecting an External Microphone](#)[Adjusting the Speakers Volume](#)[Adjusting the Volume in Windows](#)

[▶ Troubleshooting](#)

How to Use

[Parts Description](#)

[Setup](#)

[Network / Internet](#)

[Connections](#)

[Settings](#)

[Playback](#)

[Backup / Recovery](#)

[Security](#)

[Other Operations](#)

[Notifications](#)

Playing Surround Sound Using S-FORCE Front Surround 3D

S-FORCE Front Surround 3D is a virtual surround technology which allows you to enjoy powerful and realistic surround sound using the built-in speakers. Its effect is especially noticeable when you are watching movies.

1. Start VAIO Control Center. [\[Details\]](#)
2. Select Sound.
3. Select Use S-FORCE Front Surround 3D in Sound Effect Settings.

Note

- S-FORCE Front Surround 3D works only on sound output from the built-in speakers.
- Simultaneous use of S-FORCE Front Surround 3D and Dolby Home Theater v4 is not possible.
- Simultaneous use of S-FORCE Front Surround 3D and Dolby Home Theater v4 or ClearAudio+ is not possible.

Hint

- To achieve maximum effect of S-FORCE Front Surround 3D, place your VAIO computer directly across from your listening position and stay within the optimum distance: approximately 3.3 feet (1 m) from the computer.

Related Topic

[Adjusting the Speakers Volume](#)[Adjusting the Volume in Windows](#)

[▶ Troubleshooting](#)

How to Use

[Parts Description](#)[Setup](#)[Network / Internet](#)[Connections](#)[Settings](#)[Playback](#)[Backup / Recovery](#)[Security](#)[Other Operations](#)[Notifications](#)

Connecting an External Drive

Connect an external disc drive or hard disk drive to a USB port on your VAIO computer.

1. Plug the power cord of your external drive into an AC outlet (1).
2. Plug one end of a USB cable (3) (not supplied) into the USB port (2), and the other end to the external drive. [\[Details\]](#)

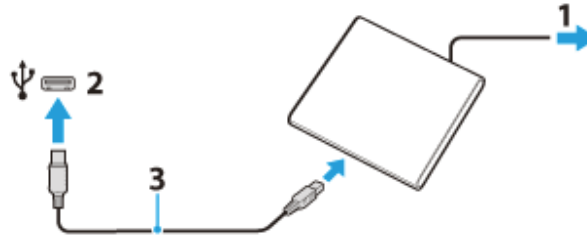

Note

- Be sure to connect an external drive to a power source with an AC adapter (if supplied).

Hint

- You may need to install a driver depending on the external drive you use. In addition, procedures to connect and use an external drive vary depending on the drive you use. Refer to the manual that came with your external drive for more information.

Related Topic

[Connecting a USB Device](#)

[▶ Troubleshooting](#)**How to Use**[Parts Description](#)[Setup](#)[Network / Internet](#)[Connections](#)[Settings](#)[Playback](#)[Backup / Recovery](#)[Security](#)[Other Operations](#)[Notifications](#)

Inserting/Removing a Disc <Optical disc drive equipped models>

Insert/remove a disc to/from your VAIO computer that is turned on.

To insert a disc

1. Insert a disc into the optical disc drive slot.

When the optical disc drive has a vertical slot, insert a disc with the label side facing toward you.



When the optical disc drive has a horizontal slot, insert a disc with the label side facing upward.



Note

- Slide the disc straight into the slot without applying excessive pressure to the disc.
- Make sure there is no disc inserted in the optical disc drive before inserting a disc into the slot.

To remove a disc

1. Press the drive eject button.

The disc slides out.

Note

- Do not forcibly pull out the disc from the optical disc drive before it completely slides out.

Related Topic

[Supported Discs<Optical disc drive equipped models>](#)[About Region Codes<Optical disc drive equipped models>](#)

[▶ Troubleshooting](#)

How to Use

[Parts Description](#)

[Setup](#)

[Network / Internet](#)

[Connections](#)

[Settings](#)

[Playback](#)

[Backup / Recovery](#)

[Security](#)

[Other Operations](#)

[Notifications](#)

Supported Discs <Optical disc drive equipped models>

This topic explains media types that are playable/recordable on your VAIO computer. The installed optical disc drive varies depending on the model you purchased. Check the specifications before use.

For DVD SuperMulti Drive equipped models

The optical disc drive supports playback and/or recording of the following media.

Playback and recording

- CD-R/RW *1
- DVD-R/RW
- DVD+R/RW
- DVD+R DL (Double Layer)
- DVD-R DL (Dual Layer)
- DVD-RAM *2*3

Playback only

- CD-ROM
- DVD-ROM

For Blu-ray Disc(TM) Drive with DVD SuperMulti equipped models

The optical disc drive supports playback and/or recording of the following media.

Playback and recording

- CD-R/RW *1
- DVD-R/RW
- DVD+R/RW
- DVD+R DL (Double Layer)
- DVD-R DL (Dual Layer)
- DVD-RAM *2*3
- BD-R/RE *4*5*6

Playback only

- CD-ROM
- DVD-ROM
- BD-ROM

For Blu-ray Disc(TM) ROM Drive with DVD SuperMulti equipped models

The optical disc drive supports playback and/or recording of the following media.

Playback and recording

- CD-R/RW *1
- DVD-R/RW
- DVD+R/RW
- DVD+R DL (Double Layer)
- DVD-R DL (Dual Layer)
- DVD-RAM *2*3

Playback only

- CD-ROM
- DVD-ROM
- BD-ROM

*1 Writing data to Ultra Speed CD-RW media is not supported.

*2 The optical disc drive does not support the DVD-RAM cartridge. Use non-cartridge discs or discs with a removable cartridge.

*3 Writing data to single-sided DVD-RAM media (2.6 GB) compliant with DVD-RAM Version 1.0 is not supported.

DVD-RAM Version 2.2/12X-SPEED DVD-RAM Revision 5.0 media are not supported.

*4 BD-RE Disc media in Version 1.0 format and Blu-ray Disc media with a cartridge are not supported.

*5 Writing data to BD-R Part1 Version 1.1/1.2/1.3 media (single-layer media with the capacity of 25 GB, dual-layer media with the capacity of 50 GB) and BD-RE Part1 Version 2.1 media (single-layer media with the capacity of 25 GB, dual-layer media with the capacity of 50 GB) is supported.

*6 BDXL(TM) media are not supported.

Note

- Your optical disc drive may not support writing or playback of some types of media.
- Your optical disc drive does not support 8 cm disc reading/writing and an 8 cm disc adapter.
- Your optical disc drive supports only circular discs. Do not use discs in any other shape (star, heart, card, etc.) or damaged discs, as it may cause your VAIO computer to malfunction.
- DVD-Video format data can be written to DVD+R (single layer or dual layer), DVD+RW/DVD-R (single layer or dual layer), and DVD-RW media. DVD-Video Recording format data can be written to DVD-R (single layer or dual layer), DVD-RW, and DVD-RAM media. Writable media differ depending on the disc burning app you use. Refer to the help file included with the app for more information.
- It is recommended that you use Sony branded media: DVD+R, DVD+RW, DVD-R, DVD-RW, CD-R, CD-RW, BD-R, or BD-RE.
- You cannot write data to DVD-RW media (6x writing) unless your optical disc drive supports at least 6x writing for DVD-RW media.
- You cannot write data to DVD+RW media (8x writing) unless your optical disc drive supports at least 8x writing for DVD+RW media.
- Your VAIO computer is designed to playback discs that conform to the Compact Disc (CD) standard. DualDiscs and some music discs encoded with copyright protection technologies do not conform to the CD standard. Therefore, these discs may not be compatible with the computer.
- When you buy pre-recorded or blank discs for use with your VAIO computer, be sure to read the notices on the disc package carefully to check both playback and recording compatibility with your computer's optical disc drives. Sony does NOT guarantee the compatibility of VAIO optical disc drives with discs that are not compliant with the official "CD," "DVD," or "Blu-ray Disc" standard. **USING NON-COMPLIANT DISCS CAN CAUSE FATAL DAMAGE TO YOUR VAIO COMPUTER OR CREATE SOFTWARE CONFLICTS AND CAUSE SYSTEM HANGING.**
For inquiries about disc formats, contact the individual publisher of the pre-recorded disc or the manufacturer of the recordable disc.
- Your VAIO computer needs to be connected to the Internet to play DVD-RW, DVD-RAM, and DVD-R (single layer or dual layer) media that are compliant with the Content Protection for Recordable Media (CPRM) standard.
- To record, edit, or play copyright protected content, Blu-ray Disc media employs the Advanced Access Content System (AACS) technology. To use Blu-ray Disc media continually, you need to update the AACS key.
- You can update the AACS key through the Internet. Follow a message displayed on a recording, editing, or playback app you are using. Without updating the AACS key, you may become unable to record, edit, or play copyright protected content.
To record, edit, or play content without copyright protection, you do not need to update the AACS key. You can update the AACS key for the Blu-ray Disc recording or playback app installed on your VAIO computer for five years after purchase. After that, we will

inform you about the update on the support website.

- Region settings are required for some contents of DVD and BD-ROM Disc media. If the region setting on the optical disc drive does not match the region code on the disc, playback is not possible.
- Unless your external display is compliant with the High-bandwidth Digital Content Protection (HDCP) standard, you cannot play or view the contents of copyright protected Blu-ray Disc media through an HDMI connection.
- Some Blu-ray Disc content may restrict video output to standard definition or prohibit analog video output.

Related Topic

[About Region Codes<Optical disc drive equipped models>](#)

[▶ Troubleshooting](#)

How to Use

[Parts Description](#)

[Setup](#)

[Network / Internet](#)

[Connections](#)

[Settings](#)

[Playback](#)

[Backup / Recovery](#)

[Security](#)

[Other Operations](#)

[Notifications](#)

About Region Codes <Optical disc drive equipped models>

The following is a list of DVD region codes indicating playable regions of DVD media. You can check the region codes of DVD media sold in the following countries or regions.

1. USA, Canada
2. Europe, Middle East, South Africa, Japan
3. Southeast Asia, Taiwan, South Korea, Hong Kong
4. Central America, South America, Mexico, Australia, New Zealand
5. North Africa, Asia, Russia, Ukraine, Belarus, India
6. China
7. Reserved for future use
8. International aircraft, international cruise ship, international conference hall, etc.

Region code indicators are labeled on the discs or packages to indicate in which region and on what type of player you can play the disc. If the region code indicates "all," you can play this disc in most regions of the world. If the region code for your residence area is different from the label, you cannot play the disc on your VAIO computer.

Related Topic

[Supported Discs<Optical disc drive equipped models>](#)

[▶ Troubleshooting](#)**How to Use**[Parts Description](#)[Setup](#)[Network / Internet](#)[Connections](#)[Settings](#)[Playback](#)[Backup / Recovery](#)[Security](#)[Other Operations](#)[Notifications](#)

Handling Discs

<Optical disc drive equipped models>

Read the following to protect data stored on discs and take proper care of discs.

- Be sure to hold the disc by its edges and central hole without touching the recording surface (playing surface), as shown below. Fingerprints and dust on the surface of a disc may cause a read or write error. Be sure to keep the disc clean.



- Sony assumes no liability for any problems and damages to discs arising out of adhesive labels affixed to discs. Refer to the manual carefully that came with the label app or label paper, and use the labels under your responsibility.



To take proper care of discs

- For normal cleaning, hold the disc by its edges and use a soft cloth to wipe the surface from the center out, as shown below.



- If the disc is badly soiled, moisten a soft cloth with water, wring it out well, and use it to wipe the surface of the disc. Wipe off any remaining moisture with a dry soft cloth.
- Do not use solvents such as benzine, thinner, commercially available cleaners, or anti-static spray which may cause damage to the disc.

[▶ Troubleshooting](#)

How to Use

[Parts Description](#)

[Setup](#)

[Network / Internet](#)

[Connections](#)

[Settings](#)

[Playback](#)

[Backup / Recovery](#)

[Security](#)

[Other Operations](#)

[Notifications](#)

Notes on Using Discs <Optical disc drive equipped models>

Observe the following notes when using discs on your VAIO computer.

Notes on playing discs

- Depending on system environment, you may find sound interruptions and/or dropped frames during DVD/BD/AVCHD playback. In addition, some discs may not be able to play on your VAIO computer.
- When you are playing discs:
 - The CPU load increases. Close all running apps other than the playback app you are currently using to enjoy smoother playback.
 - Do not switch the display output between the computer screen and an external display.

Notes on playing recorded discs on other players

- Some CD players may not be able to play audio CDs created with CD-R or CD-RW media.
- Some DVD players may not be able to play DVDs created with DVD+R DL, DVD-R DL, DVD+R, DVD+RW, DVD-R, DVD-RW, or DVD-RAM media.
- Blu-ray Disc recorders that support only BD-RE Ver.1.0 cannot play BD-R or BD-RE media created with your VAIO computer. (Blu-ray Disc Drive with DVD SuperMulti equipped models)

Tips for successful writing

- Do not plug or unplug cables, such as the AC adapter or the power cord while the optical disc drive is writing data to a disc.
- The writing process may take longer to complete than theoretically predicted because some apps write and verify data simultaneously.
- Sony assumes no liability for any loss or damage of any kind arising out of writing failure.

[▶ Troubleshooting](#)**How to Use**[Parts Description](#)[Setup](#)[Network / Internet](#)[Connections](#)[Settings](#)[Playback](#)[Backup / Recovery](#)[Security](#)[Other Operations](#)[Notifications](#)

Using the Built-in Camera <Built-in camera equipped models>

If your VAIO computer is equipped with a built-in camera, you can make a video call through the Internet using communication software, such as Windows Live Messenger. For detailed information on how to use the software, refer to the help file included with the software.

The built-in camera indicator light is on while the built-in camera is in use.

Hint

- The software installed on your VAIO computer varies depending on the computer's configurations.

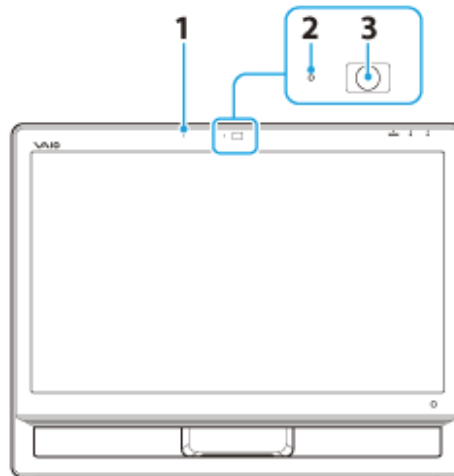

1. Built-in microphone (monaural)
2. Built-in camera indicator
3. Built-in camera

To make a video call using Windows Live Messenger

1. Click (Start), All Programs, and Windows Live Messenger. You need to sign in to Windows Live Messenger to make a video call.

To display images from the built-in camera

1. Click (Start), All Programs, ArcSoft Webcam Suite, and WebCam Companion 4.
2. Click Capture.

Hint

- If you cannot capture images properly, for example captured images are not displayed smoothly, click the current resolution of the capturing image in the upper right of the main window and lower the resolution.

Related Topic[Notes on the Built-in Camera<Built-in camera equipped models>](#)

[▶ Troubleshooting](#)

How to Use

[Parts Description](#)

[Setup](#)

[Network / Internet](#)

[Connections](#)

[Settings](#)

[Playback](#)

[Backup / Recovery](#)

[Security](#)

[Other Operations](#)

[Notifications](#)

Notes on the Built-in Camera <Built-in camera equipped models>

- Do not scratch or soil the area on and around the built-in camera, as it may cause poor-quality images.
- Do not let direct sunlight enter the lens of the built-in camera regardless of your VAIO computer's power state, as it may cause the camera to malfunction.

Care and cleaning of the built-in camera

If the area on and around the built-in camera is soiled, gently wipe it with a soft cloth, such as a lens cleaning cloth. Do not rub the area too hard, as it can be easily scratched.

Related Topic

[Using the Built-in Camera<Built-in camera equipped models>](#)

[▶ Troubleshooting](#)

How to Use

[Parts Description](#)

[Setup](#)

[Network / Internet](#)

[Connections](#)

[Settings](#)

[Playback](#)

[Backup / Recovery](#)

[Security](#)

[Other Operations](#)

[Notifications](#)

About the Network (LAN)

The network (LAN) enables you to connect your VAIO computer to the Internet and transfer data between the computer and other devices.

You can connect your VAIO computer to 1000BASE-T/100BASE-TX/10BASE-T type networks with a LAN cable (not supplied). Connect one end of a LAN cable to the LAN port on the computer and the other end to your network.

For information on peripheral devices required for LAN access, ask your Internet Service Provider (ISP) or refer to the manual that came with your modem.

For information on how to connect your VAIO computer to the network, refer to your ISP's instructions or the manual that came with the modem and other peripheral devices. If you require information on the network settings at your workplace, ask the network administrator.

Related Topic

[About the Internet Connection Services](#)[Starting Wi-Fi \(Wireless LAN\) Communications](#)

[▶ Troubleshooting](#)

How to Use

[Parts Description](#)

[Setup](#)

[Network / Internet](#)

[Connections](#)

[Settings](#)

[Playback](#)

[Backup / Recovery](#)

[Security](#)

[Other Operations](#)

[Notifications](#)

About the Internet Connection Services

The following types of Internet connection services are available.

You can select from among the services according to your preference, for example, communication speed or a usage fee. For detailed information on a variety of connection services, contact Internet Service Providers (ISPs).

- Fiber to the Home (FTTH)
- Cable modem
- Digital Subscriber Line (DSL)
- Satellite
- Dial-up

Related Topic

[Connecting to the Internet with a Wired Connection](#)
[Starting Wi-Fi \(Wireless LAN\) Communications](#)

[▶ Troubleshooting](#)

How to Use

[Parts Description](#)[Setup](#)[Network / Internet](#)[Connections](#)[Settings](#)[Playback](#)[Backup / Recovery](#)[Security](#)[Other Operations](#)[Notifications](#)

Connecting to the Internet with a Wired Connection

Before using the Internet, you need to sign up with an Internet Service Provider (ISP) and set up devices required for connecting your VAIO computer to the Internet. Connect one end of a LAN cable (not supplied) to the LAN port on your VAIO computer and the other end to your network.

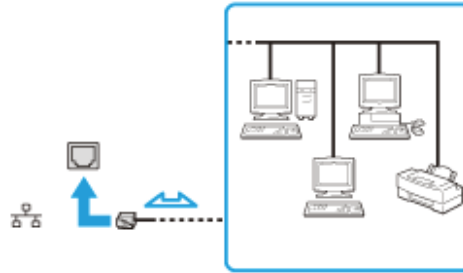

Note

- For detailed information on devices required for Internet access and how to connect your VAIO computer to the Internet, ask your ISP.
- When connecting your VAIO computer to the Internet, be sure to use a cable with network or Ethernet printed on it.
- Do not plug a telephone cable into the LAN port on your VAIO computer. If the computer is connected to the one of the networks or the LAN port is connected to the telephone lines mentioned below, high electric current to the port may cause damage, overheating, or fire.
 - Any network, except 1000BASE-T/100BASE-TX/10BASE-T type networks
 - Public telephone subscriber line
 - Private branch exchange (PBX)
 - Home (intercom speakerphone) or business-use telephone lines (multi-line business telephone)

Hint

- To connect your VAIO computer to the Internet using the wireless LAN function, you need to set up the wireless LAN network. [\[Details\]](#)

Related Topic

[About the Internet Connection Services](#)[About the Network \(LAN\)](#)[Starting Wi-Fi \(Wireless LAN\) Communications](#)

[▶ Troubleshooting](#)

How to Use

[Parts Description](#)

[Setup](#)

[Network / Internet](#)

[Connections](#)

[Settings](#)

[Playback](#)

[Backup / Recovery](#)

[Security](#)

[Other Operations](#)

[Notifications](#)

Launching the Web Browser (WEB Button) <WEB Button equipped models>

By pressing the WEB button, you can launch the default web browser.
Even when your VAIO computer is off, pressing the WEB button starts Windows, and launches the web browser.

[▶ Troubleshooting](#)

How to Use

[Parts Description](#)

[Setup](#)

[Network / Internet](#)

[Connections](#)

[Settings](#)

[Playback](#)

[Backup / Recovery](#)

[Security](#)

[Other Operations](#)

[Notifications](#)

About the Wi-Fi (Wireless LAN) Standards

The Wireless Local Area Network (WLAN) allows your VAIO computer to connect to a network through a wireless connection.

The WLAN uses the following IEEE 802.11a/b/g/n standard, which specifies the type of technology used.

Refer to the specifications to find out about the configuration of the computer.

IEEE 802.11a (Frequency band:5 GHz)

Exclusive to models compliant with the IEEE 802.11a/b/g/n standard.

IEEE 802.11b/g (Frequency band:2.4 GHz)

The IEEE 802.11g standard provides higher-speed communications than the IEEE 802.11b.

IEEE 802.11n (Frequency band:2.4 GHz/5 GHz)

For models compliant with the IEEE 802.11b/g/n standard, only 2.4 GHz band can be used.

Related Topic

[Starting Wi-Fi \(Wireless LAN\) Communications](#)

[Stopping Wi-Fi \(Wireless LAN\) Communications](#)

[Notes on Using the Wi-Fi \(Wireless LAN\) Function](#)

[Troubleshooting](#)**How to Use**[Parts Description](#)[Setup](#)[Network / Internet](#)[Connections](#)[Settings](#)[Playback](#)[Backup / Recovery](#)[Security](#)[Other Operations](#)[Notifications](#)



Starting Wi-Fi (Wireless LAN) Communications

You can establish Wi-Fi (wireless LAN) communications between your VAIO computer and an access point (not supplied).

Before using Wi-Fi (wireless LAN), make sure an access point (not supplied) is on and operating.

1. Connect an access point to your VAIO computer.
Refer to Windows Help and Support [\[Details\]](#) and the manual that came with the access point for more information.
2. Open the Charms bar [\[Details\]](#) and select  (Settings).
3. Select Change PC settings at the lower right corner of the bar.
4. Select Wireless in the left pane of the PC settings screen.
5. Make sure Airplane mode is Off and the Wi-Fi setting under Wireless devices is On.

Hint

- Refer to Windows Help and Support for more information on Airplane mode. [\[Details\]](#)
6. Open the Charms bar [\[Details\]](#) and select  (Settings).
 7. Select  (the Network icon).
 8. Select the desired access point and Connect.
After the connection is established, Connected appears in the selected wireless access point field.
If a security key [\[Details\]](#) entry window appears, enter the security key as required and select OK.
Note that security keys are case-sensitive.

Note

- On IEEE 802.11a/b/g/n equipped models, when only the 2.4 GHz Wi-Fi (wireless LAN) function is enabled, your VAIO computer cannot connect to a 5 GHz Wi-Fi (wireless LAN) access point. Also, when only the 5 GHz Wi-Fi (wireless LAN) function is enabled, the computer cannot connect to a 2.4 GHz Wi-Fi (wireless LAN) access point.
On IEEE 802.11b/g/n equipped models, when the 2.4 GHz Wi-Fi (wireless LAN) function is disabled, the computer cannot connect to an access point. Also, the computer cannot connect to a 5 GHz Wi-Fi (wireless LAN) access point.
- It may take some time to find and connect to a Wi-Fi (wireless LAN) access point before starting communications via Wi-Fi (wireless LAN).

Hint

- Once you connect your VAIO computer to the access point by entering the security key, the access point will be registered in the computer. You do not have to enter the security key for subsequent connections.

To check Wi-Fi (wireless LAN) connection status

Show the desktop [\[Details\]](#) and move the mouse pointer over  (the Network icon) in the desktop notification area to check the Wi-Fi (wireless LAN) connection status, such as the access point currently connected to your VAIO computer.

Related Topic

[About the Wi-Fi \(Wireless LAN\) Standards](#)

Stopping Wi-Fi (Wireless LAN) Communications
Notes on Using the Wi-Fi (Wireless LAN) Function
About a Security Key for Wi-Fi (Wireless LAN)

[▶ Troubleshooting](#)

How to Use

[Parts Description](#)

[Setup](#)

[Network / Internet](#)

[Connections](#)

[Settings](#)

[Playback](#)

[Backup / Recovery](#)



[Security](#)

[Other Operations](#)

[Notifications](#)

Stopping Wi-Fi (Wireless LAN) Communications

You can stop Wi-Fi (wireless LAN) communications by following these steps.

1. Open the Charms bar [\[Details\]](#) and select  (Settings).
2. Select  (the Network icon).
3. Select the desired access point and [@@@Disconnect@@@](#).

Note

- Do not disable the Wi-Fi (wireless LAN) function while accessing remote documents, files, or resources, as it may result in data loss.

Related Topic

[About the Wi-Fi \(Wireless LAN\) Standards](#)[Starting Wi-Fi \(Wireless LAN\) Communications](#)[Notes on Using the Wi-Fi \(Wireless LAN\) Function](#)[Disabling the Wi-Fi \(Wireless LAN\) Function](#)

[▶ Troubleshooting](#)

How to Use

[Parts Description](#)

[Setup](#)

[Network / Internet](#)

[Connections](#)

[Settings](#)

[Playback](#)

[Backup / Recovery](#)

[Security](#)

[Other Operations](#)

[Notifications](#)

Disabling the Wi-Fi (Wireless LAN) Function

You can disable the Wi-Fi (Wireless LAN) function by following these steps.

1. Open the Charms bar [\[Details\]](#) and select  (Settings).
2. Select Change PC settings at the lower right corner of the bar.
3. Select Wireless in the left pane of the PC settings screen.
4. Change the Wi-Fi setting under Wireless devices to Off.

Hint

- To enable the Wi-Fi (wireless LAN) function, turn off Airplane mode and change the Bluetooth setting under Wireless devices to On.
- You can disable all wireless functions by turning on Airplane mode.
- The wireless function(s) whose setting is on will be enabled when you turn off Airplane mode. When any wireless function is enabled, the WIRELESS indicator light turns on.
- Refer to Windows Help and Support for more information on Airplane mode. [\[Details\]](#)

Related Topic

[About the Wi-Fi \(Wireless LAN\) Standards](#)[Starting Wi-Fi \(Wireless LAN\) Communications](#)[Notes on Using the Wi-Fi \(Wireless LAN\) Function](#)

[▶ Troubleshooting](#)

How to Use

[Parts Description](#)[Setup](#)[Network / Internet](#)[Connections](#)[Settings](#)[Playback](#)[Backup / Recovery](#)[Security](#)[Other Operations](#)[Notifications](#)



About a Security Key for Wi-Fi (Wireless LAN)

A security key is a security protocol for Wi-Fi (wireless LAN) that encrypts data transmitted on Wi-Fi (wireless LAN). It is also referred to as an encryption key or a WEP (Wired Equivalent Privacy) key.

The security key allows wireless devices that have the same key, such as a Wi-Fi (wireless LAN) access point and a computer, to communicate with each other on Wi-Fi (wireless LAN).

The security key is assigned to each access point by default. (Make sure the default security key has been changed to protect data from unauthorized use.) If you cannot find the default security key, refer to the manual that came with your access point.

If you enter a wrong security key, follow these steps to re-enter the security key.

1. Open the Charms bar [\[Details\]](#) and select  (Settings).
2. Select  (the Network icon).
3. Right-click the desired network and select [@@@Display connection property@@@](#).
4. Select the Security tab.
5. Enter a security key in the Network security key field and select OK.

Related Topic

[About the Wi-Fi \(Wireless LAN\) Standards](#)[Starting Wi-Fi \(Wireless LAN\) Communications](#)[Notes on Using the Wi-Fi \(Wireless LAN\) Function](#)

[▶ Troubleshooting](#)

How to Use

[Parts Description](#)[Setup](#)[Network / Internet](#)[Connections](#)[Settings](#)[Playback](#)[Backup / Recovery](#)[Security](#)[Other Operations](#)[Notifications](#)

Notes on Using the Wi-Fi (Wireless LAN) Function

Before using the Wi-Fi (wireless LAN) function, read the following precautions for correct use.

- In some countries or regions, using the Wi-Fi (wireless LAN) products may be restricted by the local regulations.
- Wireless devices work on the 2.4 GHz band, which is used by a variety of devices. Wireless devices use the technology to minimize radio interference from other devices that use the same band; however, radio interference may still slow communication speeds, reduce communication range, or cause communication failure.
- If both the BLUETOOTH function and the 2.4 GHz Wi-Fi (wireless LAN) function of your VAIO computer are enabled, interference may occur and cause slower communication speeds or other problems.
- To communicate via Wi-Fi (wireless LAN) while you are on the road, you may need to contract with a Wi-Fi (wireless LAN) connection service provider.
- If your VAIO computer is equipped with the IEEE 802.11a/b/g/n standard, outdoor use of the 5 GHz Wi-Fi (wireless LAN) function is prohibited by law.
- The communication speed and range may vary depending on the following conditions:
 - Distance between devices
 - Existence of obstacles between devices
 - Device configuration
 - Radio conditions
 - Ambient environment (including wall material, etc.)
 - Apps in use
 Communications may be cut off depending on radio conditions.
- The data transfer rate specified in the specification is the theoretical maximum, and may not reflect actual data transfer rate.
- Actual communication speed may not be as fast as the one displayed on your VAIO computer.
- The 2.4 GHz and 5 GHz Wi-Fi (wireless LAN) frequency bands are not communicable with one another.
- The data transfer rate of IEEE 802.11g and IEEE 802.11n (2.4 GHz) may be affected by interference when used with an IEEE 802.11b product. Also, IEEE 802.11g and IEEE 802.11n automatically lower the transfer rate to maintain compatibility with an IEEE 802.11b product. The transfer rate may be regained by changing the channel settings of your access point.
- The IEEE 802.11a standard and the IEEE 802.11n standard are not available on ad-hoc networks.
- To stop the Wi-Fi (wireless LAN) function abruptly, turn off your VAIO computer.
- The WLAN standard includes the encryption methods: Wired Equivalent Privacy (WEP), which is a security protocol, Wi-Fi Protected Access 2 (WPA2), and Wi-Fi Protected Access (WPA). Proposed jointly by the IEEE and Wi-Fi Alliance, both WPA2 and WPA are specifications of standards based on interoperable security enhancements that increase the level of data protection and access control for existing Wi-Fi networks. WPA is designed to be forward compatible with the IEEE 802.11i specification. It utilizes the enhanced data encryption Temporal Key Integrity Protocol (TKIP) in addition to user authentication using 802.1X and Extensible Authentication Protocol (EAP). Data encryption protects the vulnerable wireless link between clients and access points. Besides that, there are other typical LAN security mechanisms to ensure privacy, such as: password protection, end-to-end encryption, virtual private networks, and authentication. WPA2, the second generation of WPA, provides stronger data protection and network access control and is also designed to secure all versions of 802.11 devices, including 802.11b, 802.11a, 802.11g, and 802.11n standards, multi-band and multi-mode. In addition, based on the ratified IEEE 802.11i standard, WPA2 provides

government grade security by implementing the National Institute of Standards and Technology (NIST) FIPS 140-2 compliant AES encryption algorithm and 802.1X-based authentication. WPA2 is backward compatible with WPA.

Related Topic

[About the Wi-Fi \(Wireless LAN\) Standards](#)

[Starting Wi-Fi \(Wireless LAN\) Communications](#)

[Stopping Wi-Fi \(Wireless LAN\) Communications](#)

[Notes on Using the BLUETOOTH\(R\) Function](#)

[▶ Troubleshooting](#)**How to Use**[Parts Description](#)[Setup](#)[Network / Internet](#)[Connections](#)[Settings](#)[Playback](#)[Backup / Recovery](#)[Security](#)[Other Operations](#)[Notifications](#)

About the BLUETOOTH(R) Function

You can establish wireless communications between your VAIO computer and other BLUETOOTH devices, such as another computer, a smartphone, a mobile phone, a headset, or a mouse.

You can transfer data between these devices without cables at a range of up to 33 feet / 10 meters in an open area.



One BLUETOOTH device can connect with up to seven devices via wireless network to exchange data.

When a device requires connection to another device, it sends out an inquiry to neighboring BLUETOOTH devices. If any device responds to the inquiry, the two devices can connect with each other.

Related Topic

[Communicating with Another BLUETOOTH\(R\) Device such as a Mouse](#)[Stopping BLUETOOTH\(R\) Communications](#)[Notes on Using the BLUETOOTH\(R\) Function](#)[About BLUETOOTH\(R\) Security](#)

[Troubleshooting](#)**How to Use**[Parts Description](#)[Setup](#)[Network / Internet](#)[Connections](#)[Settings](#)[Playback](#)[Backup / Recovery](#)[Security](#)[Other Operations](#)[Notifications](#)

Communicating with Another BLUETOOTH(R) Device such as a Mouse

You can connect BLUETOOTH devices to your VAIO computer.

For details on BLUETOOTH communication, see [About the BLUETOOTH Function](#).

[\[Details\]](#)

1. Open the Charms bar [\[Details\]](#) and select  (Settings).
2. Select Change PC settings at the lower right corner of the bar.
3. Select Wireless in the left pane of the PC settings screen.
4. Make sure that Airplane mode is Off and the Bluetooth setting is On.

Hint

- If your VAIO computer is compliant with BLUETOOTH high speed technology and you intend to use it for high-speed communications, change the Wi-Fi setting under Wireless devices to On, too.
 - Make sure that the WIRELESS indicator light on your VAIO computer is on.
5. Select Devices in the left pane of the PC settings screen.
 6. When connecting a BLUETOOTH mouse, turn it on and press the button to connect the mouse.
Hint
 - Refer to the manual that came with your BLUETOOTH device for the procedure to have the device ready for connection.
 7. Select (wi1070).
Your VAIO computer searches for devices and displays a device list. Follow the on-screen instructions to register your device.

Note

- Depending on the BLUETOOTH device, it may take some time for your VAIO computer to find the device. If your device does not appear in the list, repeat the procedure to have the device ready for connection (for example, pressing the button for connection).
- Depending on the BLUETOOTH device, the procedure to establish connection may vary. Refer to the manual that came with the device for the procedure.

Hint

- For details on the operations, open Windows Help and Support [\[Details\]](#), and enter "BLUETOOTH" in the search box.
- A window appears for passcode input if a BLUETOOTH device is requesting authentication to establish connection. Follow the on-screen instructions to share the passcode between the BLUETOOTH device and your VAIO computer. If you do not wish to connect, select the (wi1080) button in the window.
 - A passcode is a secret number that is entered by a user to use for the authentication process to allow two BLUETOOTH devices to communicate with each other. Enter the same alphanumeric string (case-sensitive) for both devices to allow them to communicate with each other. You can change the passcode every time you perform authentication, providing you enter the same passcode for both devices during the authentication process. For details on the passcode of a BLUETOOTH device, refer to the manual that came with the device. If no BLUETOOTH passcode is entered for a certain time, the connection process will be terminated for security. In this case, try again.

Related Topic

[About the BLUETOOTH\(R\) Function](#)

Stopping BLUETOOTH(R) Communications
Notes on Using the BLUETOOTH(R) Function
About BLUETOOTH(R) Security

[▶ Troubleshooting](#)

How to Use

[Parts Description](#)

[Setup](#)

[Network / Internet](#)

[Connections](#)

[Settings](#)

[Playback](#)

[Backup / Recovery](#)

[Security](#)

[Other Operations](#)

[Notifications](#)

Stopping BLUETOOTH(R) Communications

You can stop BLUETOOTH communications by following these steps.

1. Open the Charms bar [\[Details\]](#) and select  (Settings).
2. Select Change PC settings at the lower right corner of the bar.
3. Select Wireless in the left pane of the PC settings screen.
4. Change the Bluetooth setting under Wireless devices to Off.

Hint

- When Airplane mode is Off, the WIRELESS indicator light on your VAIO computer stays on.

Related Topic

[About the BLUETOOTH\(R\) Function](#)[Communicating with Another BLUETOOTH\(R\) Device such as a Mouse](#)[Notes on Using the BLUETOOTH\(R\) Function](#)

[▶ Troubleshooting](#)

How to Use

[Parts Description](#)

[Setup](#)

[Network / Internet](#)

[Connections](#)

[Settings](#)

[Playback](#)

[Backup / Recovery](#)

[Security](#)

[Other Operations](#)

[Notifications](#)

About BLUETOOTH(R) Security

The BLUETOOTH wireless technology has an authentication function, which allows you to control communication with other devices.

The authentication function helps you prevent unwanted anonymous BLUETOOTH devices from accessing your VAIO computer. The first time two BLUETOOTH devices communicate, a common passcode (a password required for authentication) should be identified to register both devices. Once a device is registered, there is no need to re-enter the passcode.

For details, open Windows Help and Support [\[Details\]](#), and enter "BLUETOOTH" in the search box.

Related Topic

[About the BLUETOOTH\(R\) Function](#)[Communicating with Another BLUETOOTH\(R\) Device such as a Mouse](#)[Stopping BLUETOOTH\(R\) Communications](#)[Notes on Using the BLUETOOTH\(R\) Function](#)

[▶ Troubleshooting](#)**How to Use**[Parts Description](#)[Setup](#)[Network / Internet](#)[Connections](#)[Settings](#)[Playback](#)[Backup / Recovery](#)[Security](#)[Other Operations](#)[Notifications](#)**Notes on Using the BLUETOOTH(R) Function**

Before using the BLUETOOTH function, read the following precautions for correct use.

- In some countries or regions, using the BLUETOOTH function may be restricted by the local regulations.
- The BLUETOOTH function may not work with some devices, depending on the manufacturer or the app version employed by the manufacturer. Check the system requirements of the BLUETOOTH device before purchasing.
For information on BLUETOOTH devices, visit the VAIO Support website.
Some BLUETOOTH devices require authentication (pairing) before establishing connection with another device. Perform the authentication process before connecting to such devices.
- BLUETOOTH devices work on the 2.4 GHz band, which is used by a variety of devices. BLUETOOTH devices use the technology to minimize radio interference from other devices that use the same band; however, radio interference may still cause slower communication speeds, reduce communication range, or in some cases, cause communication failure.
- Communication speed and range may vary depending on the following conditions:
 - Distance between communication devices
 - Existence of obstacles between devices
 - Ambient environment that includes existence of walls and materials of such walls
 - Device configuration
 - Apps in use
 - Radio conditions
 Communications may be cut off depending on radio conditions.
- If your VAIO computer is compliant with BLUETOOTH high speed technology and you intend to use it for high-speed communications, enable both the wireless LAN and BLUETOOTH functions on the computer.
- Large files may occasionally be corrupted during continuous transfer due to limitations of the BLUETOOTH standard and electromagnetic interference in the environment.
- Connecting multiple BLUETOOTH devices to your VAIO computer may cause channel congestion, resulting in poor device performance. This is normal with BLUETOOTH technology and does not indicate a malfunction.
- Video and audio may not be synchronized if you play videos on your VAIO computer with audio output from a connected BLUETOOTH device. This is a frequent occurrence with BLUETOOTH technology and does not indicate a malfunction.
- All BLUETOOTH devices must be certified through the procedure stipulated by Bluetooth SIG to ensure that they are compliant with the BLUETOOTH standard. Even if the BLUETOOTH devices are compliant with the BLUETOOTH standard, individual device performance, specifications, and operation procedures may vary. Data exchange may not be possible in all situations.
- Not all BLUETOOTH devices are guaranteed of compatibility with your VAIO computer.
- If you urgently need to disable the BLUETOOTH function, turn off your VAIO computer.

Related Topic[About the BLUETOOTH\(R\) Function](#)[Communicating with Another BLUETOOTH\(R\) Device such as a Mouse](#)[Stopping BLUETOOTH\(R\) Communications](#)[About BLUETOOTH\(R\) Security](#)[Notes on Using the Wi-Fi \(Wireless LAN\) Function](#)

[▶ Troubleshooting](#)

How to Use

[Parts Description](#)

[Setup](#)

[Network / Internet](#)

[Connections](#)

[Settings](#)

[Playback](#)

[Backup / Recovery](#)

[Security](#)

[Other Operations](#)

[Notifications](#)

About Built-In Sensors

A built-in accelerometer and digital compass (magnetometer) enable you to use the following functions.

Screen rotation using the built-in accelerometer

When you rotate your VAIO computer by 90 degrees or 270 degrees with the slide-out keyboard closed, the built-in accelerometer automatically detects the movement and rotates the computer screen to portrait or landscape orientation depending on the computer orientation.

Navigation assistance using the built-in digital compass

The built-in digital compass provides navigation assistance on compatible software by detecting the direction your VAIO computer is facing.

Hint

- You need to calibrate the built-in digital compass when the software does not show the current location or direction correctly.
Click [Location Info/GPS](#) and [Adjust Digital Compass](#) on VAIO Control Center and follow the on-screen instructions to calibrate the built-in digital compass.

[▶ Troubleshooting](#)

How to Use

[Parts Description](#)

[Setup](#)

[Network / Internet](#)

[Connections](#)

[Settings](#)

[Playback](#)

[Backup / Recovery](#)

[Security](#)

[Other Operations](#)

[Notifications](#)

Notes on Built-In Sensors

Before using built-in sensors, read the following precautions for correct use.

Notes on using the built-in accelerometer

- If you change the computer screen orientation without exiting the running software, such as video playback software, all unsaved data may be lost.
- You cannot change the computer screen orientation while your VAIO computer is connected to an external display. If you connect the computer to an external display while using the computer in portrait orientation, the computer screen automatically changes to landscape (horizontal) orientation.
- The computer screen may become distorted if you change the computer screen orientation while the screen saver is activated.
- Some software does not support portrait orientation and not work correctly. In this case, use your VAIO computer in landscape orientation.

Notes on using the built-in digital compass

- The built-in digital compass works by detecting a magnetic direction. Do not rely solely on the location information the built-in digital compass provides. Especially at the following locations, the accuracy of the digital compass can be easily affected by magnetic interference and it may not work correctly.
 - Inside an elevator or a room built with ferrous materials, such as iron frames or reinforced concrete
 - Near a reinforced concrete structure, such as a footbridge or an airport or a train station concourse
 - Near or inside a train or a car
 - Near a transformer on the ground or high-voltage power lines
 - Near a metallic product, such as a metal frame desk or metallic furniture
 - Near a material that has a high level of magnetic interference, such as a magnet, a magnetic holder, or speakers
- Adjusting the angle of the LCD screen may reduce the accuracy of the built-in digital compass; however, this is normal and does not indicate a malfunction. If this occurs, you need to calibrate the digital compass on VAIO Control Center.

Note on handling your VAIO computer

Do not hold the bottom of your VAIO computer for an extended period of time. Use of the computer for an extended period of time will heat up the bottom of the computer, resulting in low-temperature burns.

[▶ Troubleshooting](#)

How to Use

[Parts Description](#)[Setup](#)[Network / Internet](#)[Connections](#)[Settings](#)[Playback](#)[Backup / Recovery](#)[Security](#)[Other Operations](#)[Notifications](#)



Combinations and Functions with the Fn Key

Press and hold down the Fn key and another key simultaneously to perform a keyboard shortcut action.

For example, to adjust the LCD brightness: Fn+F5 → Press and hold down the Fn key, then press the F5 key.

Some keyboard functions can only be used while Windows is running.

Wireless keyboard supplied models

Fn +  /  (F5/F6)

Press the button repeatedly to adjust the LCD brightness of your computer screen. [\[Details\]](#)



To decrease lighting intensity, press the Fn+F5 keys.

To increase lighting intensity, press the Fn+F6 keys.

Fn + Scr Lk (Scroll Lock)

Works differently depending on the software you use. Refer to the help file included with the software for more information.

USB keyboard supplied models

Fn +  /  (F5/F6)

Press the button repeatedly to adjust the LCD brightness of your computer screen. [\[Details\]](#)

To decrease lighting intensity, press the Fn+F5 keys.

To increase lighting intensity, press the Fn+F6 keys.

Fn + Scr Lk (Scroll Lock)

Works differently depending on the software you use. Refer to the help file included with the software for more information.

Fn + Pause (Pause)

Works differently depending on the software you use. Refer to the help file included with the software for more information.

Fn + Break (Break)

Works differently depending on the software you use. Refer to the help file included with the software for more information.

Fn + Pg Up (Page Up)

Goes to the previous page.

Fn + End (End)

Moves the cursor to the end of a line or page.

Fn + Pg Dn (Page Down)

Goes to the next page.

Fn + Home (Home)

Moves the cursor to the top of a line or page.

Fn +  (E)

Ejects a disc from the optical disc drive.

[▶ Troubleshooting](#)

How to Use

[Parts Description](#)

[Setup](#)

[Network / Internet](#)

[Connections](#)

[Settings](#)

[Playback](#)

[Backup / Recovery](#)

[Security](#)

[Other Operations](#)

[Notifications](#)

Changing the LCD Brightness

You can adjust the LCD brightness.

1. Press the Fn+F5 key or Fn+F6 keys.

To decrease lighting intensity, keep pressing the Fn+F5 keys. To increase lighting intensity, keep pressing the Fn+F6 keys.

When you press the keys, the brightness indicator is displayed for a few seconds.

Hint

- The LCD brightness setting is retained even after your VAIO computer is turned off and restarted.

Related Topic

[Combinations and Functions with the Fn Key](#)

[▶ Troubleshooting](#)

How to Use

[Parts Description](#)

[Setup](#)

[Network / Internet](#)

[Connections](#)

[Settings](#)

[Playback](#)

[Backup / Recovery](#)

[Security](#)

[Other Operations](#)

[Notifications](#)

About the ASSIST Button

Press the ASSIST button to perform regular maintenance of your VAIO computer or to solve problems you might encounter when using the computer.

While the computer is on, the ASSIST button starts VAIO Care.

While the computer is off, the ASSIST button starts VAIO Care Rescue Mode.

VAIO Care Rescue Mode can be used to recover the computer in case of emergency, for example, when Windows does not start.

Note

- Once the VAIO Care Rescue Mode screen is displayed and about five minutes have passed without any operation, your VAIO computer automatically turns off.

Related Topic

[Keeping Your VAIO Computer in Optimum Condition \(VAIO Care\)](#)[Recovering from the Recovery Area](#)[Backing Up Your Data when You cannot Start Windows](#)[Restoring Your Data with VAIO Data Restore Tool](#)

[▶ Troubleshooting](#)

How to Use

[Parts Description](#)

[Setup](#)

[Network / Internet](#)

[Connections](#)

[Settings](#)

[Playback](#)

[Backup / Recovery](#)

[Security](#)

[Other Operations](#)

[Notifications](#)

Customizing Your VAIO Computer

(VAIO Control Center) allows you to access system information and to change settings of various kinds of functions such as display and sounds.

1. Click  (Start), All Programs, and (VAIO Control Center).
2. Select your desired item and change the settings.

Hint

- Refer to the help file included with (VAIO Control Center) for more information on each option.
 - Some of the items will not be visible if you log on as a user without administrative rights.
-

[▶ Troubleshooting](#)

How to Use

[Parts Description](#)

[Setup](#)

[Network / Internet](#)

[Connections](#)

[Settings](#)

[Playback](#)

[Backup / Recovery](#)

[Security](#)

[Other Operations](#)

[Notifications](#)

Changing the Resolution (Size) of the Screen Image on an HDMI-Connected Device

You can change the screen resolution or size of your VAIO computer's screen image displayed on an external display, such as a TV, connected to the computer with an HDMI cable (not supplied).

1. Connect your VAIO computer to an HDMI equipped TV with an HDMI cable.
<ERROR>
2. Turn on the TV.
3. Double-click  (HDMI Resolution Settings) in the desktop notification area. The settings window appears.
4. Click the Select Resolution tab to select the desired resolution, and then click Apply. After a few seconds, the selected resolution is applied.
5. If the computer image does not fit the displayable region of the TV, click the Adjust Resolution tab to adjust the display size.

Note

- Some resolution options may not be available, depending on the model or the HDMI-connected device.
- The function to adjust the screen resolution may be disabled depending on the selected resolution.

Related Topic

[<ERROR>](#)[<ERROR>](#)

[▶ Troubleshooting](#)

How to Use

[Parts Description](#)

[Setup](#)

[Network / Internet](#)

[Connections](#)

[Settings](#)

[Playback](#)

[Backup / Recovery](#)

[Security](#)

[Other Operations](#)

[Notifications](#)

Viewing the System Information

You can view the system information of your VAIO computer.

For example, after installing a memory module, you can view the information to confirm system memory changes.

1. Click  (Start), All Programs, and (100000).
2. Click (100020) and (100021).

The system information of your VAIO computer is displayed.

Related Topic

[Notes on Adding and Removing Memory Modules](#)

[Adding and Removing Memory Modules](#)

[▶ Troubleshooting](#)

How to Use

[Parts Description](#)

[Setup](#)

[Network / Internet](#)

[Connections](#)

[Settings](#)

[Playback](#)

[Backup / Recovery](#)

[Security](#)

[Other Operations](#)

[Notifications](#)

Checking the Battery Charge Capacity

The battery pack is consumable. The capacity gradually declines through repeated cycles of recharging and discharging. As a result, the battery life becomes short even if it is fully charged and eventually the battery pack reaches the end of its life.

If the battery life has become short, replace the battery pack with a new one specified by Sony. Refer to the help file for more information on battery charge status and capacity decrease.

1. Click  (Start), All Programs, and (100000).
2. Click (100040) and (100041).

Detailed battery pack information, such as charging capacity, is displayed.

Hint

- Enable the battery care function to maximize the battery lifespan. With this function, you can reduce battery degradation by limiting the maximum charging capacity.

Related Topic

[Extending the Battery Life](#)[Notes on Using the Battery Pack](#)[Charging the Battery Pack](#)

[▶ Troubleshooting](#)

How to Use

[Parts Description](#)

[Setup](#)

[Network / Internet](#)

[Connections](#)

[Settings](#)

[Playback](#)

[Backup / Recovery](#)

[Security](#)



[Other Operations](#)

[Notifications](#)

Charging a USB Device

You can charge a USB device even while your VAIO computer is off, in Hibernate mode, or Sleep mode by enabling the USB charging settings.

The USB charging settings are disabled by default.

1. Click  (Start), All Programs, and VAIO Control Center.
2. Click Power Management and USB Charging Settings to enable the settings.
3. Connect a USB device to the USB port with the  mark printed around it.

If charging does not start even when you connect a USB device to the USB port that supports USB charging, disconnect and connect the device.

Note

- With the USB charging settings enabled, power consumption when your VAIO computer is off or in Hibernate mode or Sleep mode increases because the computer supplies power to the USB port even when a USB device is not connected to the port.
- When the USB charging settings are enabled, you cannot use the remote wake-up function on the USB device connected to the USB port that supports USB charging.

[▶ Troubleshooting](#)

How to Use

[Parts Description](#)[Setup](#)[Network / Internet](#)[Connections](#)[Settings](#)[Playback](#)[Backup / Recovery](#)[Security](#)[Other Operations](#)[Notifications](#)

Changing the Rapid Wake (Sleep Mode) Settings

You can change the Rapid Wake settings on VAIO Control Center.

Rapid Wake is enabled by default. With this function, you can keep your VAIO computer in Sleep mode without risk of data loss because the computer enters Sleep mode after your working data is saved on the built-in storage device.

For models that support Rapid Wake + Eco, you can conserve more battery power by reducing power consumption when the computer is in Sleep mode.

1. Click  (Start), All Programs, and VAIO Control Center.
2. Click Power Management and Rapid Wake.
Click to select or clear the check box for Rapid Wake.
Select the check box to enable Rapid Wake or clear it to disable the function.

Note

- With Rapid Wake disabled, your working data is not saved on the built-in storage device when the computer enters Sleep mode. Therefore, if the computer is turned off during Sleep mode because, for example, the battery pack runs out of power or the computer is disconnected from an AC power source, the working data will be lost and cannot be restored. To avoid data loss, be sure to save the data before the computer enters Sleep mode. With Rapid Wake disabled, the power indicator light blinks slowly in orange during Sleep mode, and the charge and power indicator lights blink simultaneously when the battery pack runs out of power during Sleep mode.
When you use the Hibernate mode, you need to disable Rapid Wake.

Related Topic

[Using Sleep Mode](#)[Notes on Sleep Mode](#)

[▶ Troubleshooting](#)**How to Use**[Parts Description](#)[Setup](#)[Network / Internet](#)[Connections](#)[Settings](#)[Playback](#)[Backup / Recovery](#)[Security](#)[Other Operations](#)[Notifications](#)

Connecting a USB Device

You can connect a Universal Serial Bus (USB) device such as a mouse, floppy disk drive, speaker or printer to your VAIO computer.

Installation of the device driver software supplied with the USB device may be required when connecting.

Refer to the manual that came with the device for more information.

1. Choose the USB port (1) you prefer to use.
2. Plug the USB device cable (2) (not supplied) into the USB port.

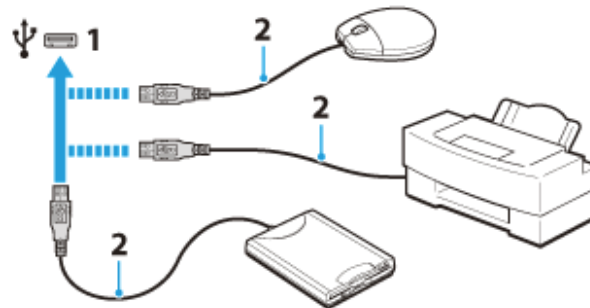
**Note**

- You may need to install the driver software supplied with your USB device before use. Refer to the manual that came with the USB device for more information.
- In order to print documents, be sure the USB printer is compatible with your version of Windows.
- Before disconnecting USB speakers from your VAIO computer, stop DVD or music playback or turn off the computer. If you disconnect the USB speakers during playback, it may cause a malfunction.
For information on how to remove a USB device, refer to the manual that came with the device.
- To protect your VAIO computer and/or USB devices from damage, observe the following:
 - When moving your VAIO computer with USB devices connected, avoid exposing the USB ports to shock or impact.
 - Do not put your VAIO computer in a bag or carrying case with USB devices connected.

Hint

- The USB ports on your VAIO computer are compliant with the USB 2.0 standard and USB 3.0 standard. USB ports that are compliant with the USB 3.0 standard are identifiable by their blue color.
- In addition to the USB 2.0 standard transfer modes, the USB 3.0 standard specifies the following transfer mode:
 - SuperSpeed: Transfer rate of 5 Gbps.

Related Topic[Connecting an External Drive](#)

[▶ Troubleshooting](#)

How to Use

[Parts Description](#)

[Setup](#)

[Network / Internet](#)

[Connections](#)

[Settings](#)

[Playback](#)

[Backup / Recovery](#)

[Security](#)

[Other Operations](#)

[Notifications](#)

About "Memory Stick"

"Memory Stick" is a compact, portable, and versatile IC recording media especially designed for exchanging and sharing digital data with compatible products, such as digital cameras and other devices. Because it is removable, it can be used for external data storage.

For the latest information about "Memory Stick", visit <http://www.sony.net/memorycard/>.

Related Topic

[Compatible "Memory Stick"](#)[Inserting/Removing "Memory Stick"](#)[Formatting "Memory Stick"](#)[Notes on Using "Memory Stick"](#)

[▶ Troubleshooting](#)

How to Use

[Parts Description](#)

[Setup](#)

[Network / Internet](#)

[Connections](#)

[Settings](#)

[Playback](#)

[Backup / Recovery](#)

[Security](#)

[Other Operations](#)

[Notifications](#)

Compatible "Memory Stick"

The "Memory Stick" slot on your VAIO computer can accommodate the following sizes and types of media:

- "Memory Stick Duo"
- "Memory Stick PRO Duo"
- "Memory Stick PRO-HG Duo"
- "Memory Stick Micro"

About "MagicGate"

"MagicGate" refers to copyright protection technology developed by Sony. An authentication process is performed between the "MagicGate" compatible device and "Memory Stick" to check whether they can correctly store and play back data, and the data will be encrypted. The authentication is also performed before the data is played back, and only when they are properly authenticated, the data is decrypted and played back. The copyright protected data can be played back by authenticated devices only.

Note

- Your VAIO computer supports only Duo-size "Memory stick", and does not support standard-size "Memory Stick".
- Before using "Memory Stick Micro" ("M2"), be sure to insert it into an "M2" Duo adaptor. If you insert the media directly into the "Memory Stick Duo" slot without the adaptor, you may not be able to remove it from the slot.
- Your VAIO computer has been tested and found compatible with any Sony branded "Memory Stick" of up to 32 GB, available as of June 2011. However, "Memory Stick" compatibility is not guaranteed in all cases.
- Except for personal use, it is against copyright law to use any audio and/or image data you record without prior consent from the respective copyright holder(s). Accordingly, "Memory Stick" with such copyrighted data can be used only within the law.
- Use "Memory Stick" with the "MagicGate" logo to take advantage of this technology.
- If you use "Memory Stick" in a place subject to static electricity or electrical noise, stored data may be lost.
- The maximum possible size for a file on "Memory Stick PRO Duo" or "Memory Stick PRO-HG Duo" is less than 4 GB, as defined in the file system specification.

Related Topic

[About "Memory Stick"](#)[Inserting/Removing "Memory Stick"](#)[Formatting "Memory Stick"](#)[Notes on Using "Memory Stick"](#)

[Troubleshooting](#)

How to Use

[Parts Description](#)[Setup](#)[Network / Internet](#)[Connections](#)[Settings](#)[Playback](#)[Backup / Recovery](#)[Security](#)[Other Operations](#)[Notifications](#)

Inserting/Removing "Memory Stick"

You can use "Memory Stick" to save data or transfer images between a digital camera and your VAIO computer. To insert/remove "Memory Stick", follow these steps.

To Insert "Memory Stick"

1. Locate the "Memory Stick" slot.

Hint

- The "Memory Stick" slot on your computer also works as an SD memory card slot.

2. Hold "Memory Stick" [\[Details\]](#) with the arrow pointing toward the slot, and carefully slide it into the slot until it clicks into place.



"Memory Stick" is automatically detected by your system and the contents of "Memory Stick" are displayed*. If nothing appears on the desktop, click  (Start) and Computer, and double-click the "Memory Stick" icon*.

* The drive letter for the "Memory Stick" slot, such as "E:", may vary depending on the system configuration of your VAIO computer.

Note

- The "Memory Stick" icon will appear in the Computer window after you insert "Memory Stick" into the slot.
- If "Memory Stick" cannot be inserted easily, remove it gently, and verify you are inserting it in the proper direction. Be sure to hold "Memory Stick" with the arrow pointing in the correct direction as you insert it into the slot. To avoid damaging your VAIO computer or the media, do not force "Memory Stick" into the slot if you cannot insert it smoothly.

Hint

- When you insert "Memory Stick" into the slot for the first time, you may be prompted to install driver software. If prompted, follow the on-screen instructions to install the software.

To remove "Memory Stick"

1. Locate the "Memory Stick" slot.

Hint

- The "Memory Stick" slot on your computer also works as an SD memory card slot.

2. Check that the Media Access indicator light is off.
3. Push in "Memory Stick" toward your VAIO computer and release.
4. Pull "Memory Stick" out of the slot.

Note

- Do not remove "Memory Stick" while the Media Access indicator light is on. If you do, you may lose data. Large volumes of data may take time to load, so make sure the indicator light is off before removing "Memory Stick".
- Be sure to remove "Memory Stick" gently, or it may pop out unexpectedly.

[About "Memory Stick"](#)
[Compatible "Memory Stick"](#)
[Formatting "Memory Stick"](#)
[Notes on Using "Memory Stick"](#)

[▶ Troubleshooting](#)**How to Use**[Parts Description](#)[Setup](#)[Network / Internet](#)[Connections](#)[Settings](#)[Playback](#)[Backup / Recovery](#)[Security](#)[Other Operations](#)[Notifications](#)

Formatting “Memory Stick”

“Memory Stick” is formatted in the specific FAT format by default and is ready for use. Be sure to use the device that is designed to format the media and supports “Memory Stick” when formatting the media.

If you want to reformat the media with your VAIO computer, follow these steps.

Note

- Formatting “Memory Stick” erases the entire data stored on the media. Be sure to make a backup copy of important data to avoid erasing it.
- Do not remove “Memory Stick” from the slot while formatting. This could cause a malfunction.

1. Locate the “Memory Stick” slot.

Hint

- The “Memory Stick” slot on your computer also works as an SD memory card slot.

2. Carefully slide “Memory Stick” into the slot until it clicks into place. [\[Details\]](#)

3. Click  (Start) and Computer.

4. Right-click the “Memory Stick” icon and select Format.
The Format Memory Stick window appears.

5. Click Restore device defaults.

The size of the allocation unit and file system will change to default settings.

Note

- Do not select NTFS from the File system drop-down list as it may cause a malfunction.

Hint

- The formatting process will be completed more quickly if you select Quick Format in Format options.

6. Click Start.

Follow the on-screen instructions.

Note

- It may take time to format “Memory Stick” depending on the media type.

Related Topic[About “Memory Stick”](#)[Compatible “Memory Stick”](#)[Inserting/Removing “Memory Stick”](#)[Notes on Using “Memory Stick”](#)

[▶ Troubleshooting](#)**How to Use**[Parts Description](#)[Setup](#)[Network / Internet](#)[Connections](#)[Settings](#)[Playback](#)[Backup / Recovery](#)[Security](#)[Other Operations](#)[Notifications](#)**Notes on Using "Memory Stick"**

Before using "Memory Stick", read the following precautions for correct use.

- Keep "Memory Stick" out of reach of children. There is a risk of swallowing it.
- Do not touch the "Memory Stick" connector with your finger or metal objects.



- "Memory Stick" contains delicate electronic components. Do not impact, bend or drop it.
- Do not disassemble or modify "Memory Stick".
- Do not wet "Memory Stick".
- Do not use or store in a location subject to:
 - Extremely high temperature, such as in a car parked in the sun
 - Direct sunlight
 - High humidity or corrosive substances
 - Excessive dust
- Be sure to use "Memory Stick" and adaptors that are compliant with the standards supported by your VAIO computer. Incompatible cards and adaptors may get stuck in the slot, causing damage to the computer.
- You cannot write data to "Memory Stick" that is write-protected.
- It is recommended that you make a backup copy of important data.
- Stored data may be lost or corrupted if:
 - You remove "Memory Stick" or turn off your VAIO computer while the media access indicator light is on.
 - You use "Memory Stick" at a place where static electricity or electrical noise may disturb the card.
- When carrying "Memory Stick", be sure to put it in its case to avoid static electricity.
- Before using "Memory Stick" with a device other than a computer, such as a digital camera or a portable audio, format (initialize) "Memory Stick" using the device. Some devices may not support the file format for computers and show you a message that recommends you to format "Memory Stick". In this case, copy data from "Memory Stick" to your VAIO computer and format "Memory Stick" using the device. All data in "Memory Stick" will be deleted when you format it. Refer to the manual that came with the device for more information.
- Do not insert foreign objects into the "Memory Stick" slot.
- The "Memory Stick" slot can be used for reading/writing supported "Memory Stick" only, and cannot be used for other purposes.

Notes on Using "Memory Stick Duo"

When using "Memory Stick Duo", do not use a fine-tipped pen to write on the label adhered to "Memory Stick Duo". Exerting pressure on the media may damage internal components.

Notes on Using "Memory Stick Micro"

- Before using "Memory Stick Micro" ("M2"), be sure to insert it into an "M2" Duo adaptor. If you insert the media directly into the "Memory Stick Duo" slot without the adaptor, you may not be able to remove it from the slot.
- Keep "Memory Stick Micro" and "M2" Duo adaptors away from children. They are harmful if swallowed.

Related Topic

[About "Memory Stick"](#)

[Compatible "Memory Stick"](#)

[Inserting/Removing "Memory Stick"](#)

[Formatting "Memory Stick"](#)

[▶ Troubleshooting](#)

How to Use

[Parts Description](#)[Setup](#)[Network / Internet](#)[Connections](#)[Settings](#)[Playback](#)[Backup / Recovery](#)[Security](#)[Other Operations](#)[Notifications](#)

Inserting/Removing SD Memory Cards

Your VAIO computer is equipped with an SD memory card slot. You can use this slot to transfer data among digital cameras, camcorders, music players, and other audio/video devices.

The SD memory card slot on the computer can accommodate the following memory cards:

- SD memory card
- SDHC memory card
- SDXC memory card

To insert an SD memory card

1. Locate the SD memory card slot.

Hint

- The SD slot on your computer also works as a “Memory Stick” slot.
2. Hold the SD memory card with the arrow pointing toward the slot, and carefully slide it into the slot until it clicks into place.

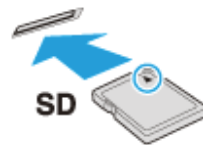

The SD memory card icon will appear in the Computer window after you insert the card into the slot.

Note

- Be careful not to insert an SD memory card with wrong orientation. If you force it into the slot upside down, the slot may be damaged. Refer to the manual that came with the SD memory card for more information.
- The SD memory card icon will not appear in the Computer window until you insert the card into the slot.

Hint

- When you insert the SD memory card into the slot for the first time, you may be prompted to install driver software. If prompted, follow the on-screen instructions to install the software.
- While data is being read from or written to the SD memory card, the media access indicator light is on.

To remove an SD memory card

1. Locate the SD memory card slot.

Hint

- The SD slot on your computer also works as a “Memory Stick” slot.
2. Check that the media access indicator light is off.
 3. Push in the SD memory card toward your VAIO computer and release.
 4. Pull the SD memory card out of the slot.

Related Topic

[Notes on Using SD Memory Cards](#)

[▶ Troubleshooting](#)

How to Use

[Parts Description](#)[Setup](#)[Network / Internet](#)[Connections](#)[Settings](#)[Playback](#)[Backup / Recovery](#)[Security](#)[Other Operations](#)[Notifications](#)

Notes on Using SD Memory Cards

Before using SD memory cards, read the following precautions for correct use.

- Keep an SD memory card out of reach of children. There is a risk of swallowing it.
- Do not touch the SD memory card connector with your finger or metal objects.
- An SD memory card contains delicate electronic components. Do not impact, bend or drop it.
- Do not disassemble or modify an SD memory card.
- Do not wet an SD memory card.
- Do not use or store in a location subject to:
 - Extremely high temperature, such as in a car parked in the sun
 - Direct sunlight
 - High humidity or corrosive substances
 - Excessive dust
- Be sure to use SD memory cards and adaptors that are compliant with the standards supported by your VAIO computer. Incompatible cards and adaptors may get stuck in the slot, causing damage to the computer.
- You cannot write data to an SD memory card that is write-protected.
- It is recommended that you make a backup copy of important data.
- Stored data may be lost or corrupted if:
 - You remove an SD memory card or turn off your VAIO computer while the media access indicator light is on.
 - You use an SD memory card at a place where static electricity or electrical noise may disturb the card.
- When carrying an SD memory card, be sure to put it in its case to avoid static electricity.
- Before using an SD memory card with a device other than a computer, such as a digital camera or a portable audio, format (initialize) the SD memory card using the device. Some devices may not support the file format for computers and show you a message that recommends you to format the SD memory card. In this case, copy data from the card to your VAIO computer and format the card using the device. All data in the SD memory card will be deleted when you format it. Refer to the manual that came with the device for more information.
- Do not insert foreign objects into the SD memory card slot.
- The SD memory card slot can be used for reading/writing supported memory cards only, and cannot be used for other purposes.
- SD memory cards (up to 2 GB), SDHC memory cards (up to 32 GB) and SDXC memory cards (up to 64 GB) available as of June 2011 have been tested and found compatible with your VAIO computer. However, it is not guaranteed that all SD memory cards, SDHC memory cards or SDXC memory cards will be compatible with the computer.
- Do not attempt to insert a memory card or memory card adaptor of a different type into the memory card slot. An incompatible memory card or memory card adaptor may get stuck in the slot, causing damage to your VAIO computer.
- Some types of SD memory cards, for example ones with the UHS (Ultra High Speed data transfer feature), may become extremely hot due to continuous access to the memory cards. In such a case, wait for a while before removing the memory card until it cools down.

Related Topic

[Inserting/Removing SD Memory Cards](#)

[▶ Troubleshooting](#)**How to Use**

[Parts Description](#)

[Setup](#)

[Network / Internet](#)

[Connections](#)

[Settings](#)

[Playback](#)

[Backup / Recovery](#)

[Security](#)

[Other Operations](#)

[Notifications](#)

Creating/Changing/Removing Your Windows Password

Setting the Windows password allows you to protect your VAIO computer from unauthorized access by making the user enter the password when the computer is turned on or returns from power saving mode to Normal mode.

Refer to Windows Help and Support for more information on the Windows password.

[\[Details\]](#)

1. Open the Charms bar [\[Details\]](#) and select  (Settings).
2. Select Change PC settings at the lower right corner of the bar.
3. Select Users in the left pane of the PC settings screen.
4. Select Create a password or Change your password.
5. Follow the on-screen instructions to enter your password.

Note

- Do not forget your password. Write down the password and keep it in a secure place.

Hint

- You can enter a hint in order to recall your password if you forget it. You can also create a password reset disc that can be used to create a new password. Refer to Windows Help and Support for more information on the Windows password. [\[Details\]](#)

Related Topic

[Setting/Changing the Power-on Password](#)

[▶ Troubleshooting](#)

How to Use

[Parts Description](#)[Setup](#)[Network / Internet](#)[Connections](#)[Settings](#)[Playback](#)[Backup / Recovery](#)[Security](#)[Other Operations](#)[Notifications](#)

Using the Antivirus App for Your VAIO Computer

Protect your VAIO computer against computer viruses by using the antivirus app. You can keep the antivirus app current with the latest updates by downloading and installing the updates from the website of the app publisher. To update the antivirus app, find the antivirus app installed on your VAIO computer from the following and follow these steps.

Trend Micro:

1. Make sure your VAIO computer is connected to the Internet.
2. Start Trend Micro Titanium Maximum Security. [\[Details\]](#)
3. Follow the on-screen instructions.

McAfee:

1. Make sure your VAIO computer is connected to the Internet.
2. Start McAfee Internet Security or McAfee Total Protection. [\[Details\]](#)
3. Follow the on-screen instructions.

Kaspersky Internet Security:

1. Make sure your VAIO computer is connected to the Internet.
2. Start Kaspersky Internet Security. [\[Details\]](#)
3. Follow the on-screen instructions.

Note

- The actual procedure may be different from the above depending on the version of the app installed on your VAIO computer. In such a case, follow the on-screen instructions.

Hint

- Refer to the help file included with your app for more information.

[▶ Troubleshooting](#)

How to Use

[Parts Description](#)

[Setup](#)

[Network / Internet](#)

[Connections](#)

[Settings](#)

[Playback](#)

[Backup / Recovery](#)

[Security](#)

[Other Operations](#)

[Notifications](#)

Encrypting Your Data with the TPM (BitLocker) <TPM security chip equipped models> <BitLocker supported models>

You can use BitLocker included with Windows 8 Pro to encrypt the data on the built-in storage device.

Refer to Windows Help and Support for more information on the BitLocker settings and operations. [\[Details\]](#)

To unlock the BitLocker-protected drive with a USB flash drive, follow these steps:

1. Press the ASSIST button while your VAIO computer is off.
The VAIO Care Rescue Mode screen appears.
2. Select Start BIOS setup.
Enter a password if it has already been set.
The BIOS setup screen appears.
3. Press the **←** or **→** key to select the Security tab and change the Change TPM State setting to Enable.
4. Press the **←** or **→** key to select Boot and change the External Device Boot setting to Enabled.
5. Change the boot device order to put Internal Hard Disk Drive in Boot Priority before External Device.
6. Press the **←** or **→** key to select Exit, select Exit Setup, and then press the Enter key.
7. When the confirmation prompt appears after your VAIO computer restarts, select Execute.
8. Refer to Windows Help and Support to enable BitLocker.
9. Save a password on the USB flash drive in the recovery password save window.
Then, follow the on-screen instructions to restart your VAIO computer. After the computer restarts, the BitLocker encryption starts.

Note

- After you update the BIOS settings using VAIO Update, the BIOS settings are restored to the default. In this case, you need to repeat the above steps.
- It takes several hours to complete the BitLocker encryption.
- Do not encrypt an external device containing the recovery password, such as a USB flash drive, using Windows BitLocker Drive Encryption.

[▶ Troubleshooting](#)

How to Use

[Parts Description](#)

[Setup](#)

[Network / Internet](#)

[Connections](#)

[Settings](#)

[Playback](#)

[Backup / Recovery](#)

[Security](#)

[Other Operations](#)

[Notifications](#)

Notes on Using the TPM <TPM security chip equipped models>

Before using the Trusted Platform Module (TPM), read the following precautions for correct use.

Notes on the BIOS settings

- Resetting the TPM settings in the BIOS setup screen makes your TPM-encrypted data inaccessible. If you have the TPM-encrypted data, make a backup copy before resetting the settings, if needed.
- Before enabling the TPM in the BIOS setup screen, set the BIOS password [\[Details\]](#) to prevent unauthorized users from changing the TPM settings.

Notes on data management with the TPM

- The TPM security feature on your VAIO computer does not ensure complete security of your data and hardware.
- Sony assumes no liability for any problems and damage arising out of your use of or inability to use the TPM.
- Back up your data on the TPM or the built-in storage device before sending your VAIO computer for repair, and keep your backup data private from other users. Sony assumes no liability for any data loss arising out of repairs.
- The TPM will also be replaced if your computer motherboard needs replacement during the course of repair.
- Perform the operation and maintenance of the TPM-related data at your own risk. Sony assumes no liability for any problems arising out of your operation and maintenance.

[▶ Troubleshooting](#)

How to Use

[Parts Description](#)

[Setup](#)

[Network / Internet](#)

[Connections](#)

[Settings](#)

[Playback](#)

[Backup / Recovery](#)

[Security](#)

[Other Operations](#)

[Notifications](#)

Booting Your VAIO Computer from External Devices

You can boot your VAIO computer from external devices, such as an optical disc drive, a USB floppy disk drive, or a USB flash drive by using the BIOS function.

1. Connect an external device to your VAIO computer.
2. Press the ASSIST button while your VAIO computer is off.
The VAIO Care Rescue Mode screen appears.
3. Select Start from media (USB device/optical disc).
The booting process from the external device starts.

Note

- Disconnect all devices from your VAIO computer except for the external device from which you intend to boot up. Some devices cannot be used to boot the computer, or cannot be used with the computer.
 - If an AC adapter is supplied with the external device, be sure to connect it to an AC power source in advance.
-

[▶ Troubleshooting](#)**How to Use**[Parts Description](#)[Setup](#)[Network / Internet](#)[Connections](#)[Settings](#)[Playback](#)[Backup / Recovery](#)[Security](#)[Other Operations](#)[Notifications](#)

Setting/Changing the Power-on Password

You can set a password (power-on password) for booting up your VAIO computer, using the BIOS function. Entry of the power-on password will be prompted after the VAIO logo appears to start the computer.

There are two types of passwords. Set the machine password first.

- **Machine password (for administrators):**
Allows users with administrative rights to change all the setup options in the BIOS setup screen, as well as to start your VAIO computer.
- **User password (for users without administrative rights):**
Allows standard users to change some of the BIOS setup options, as well as to start your VAIO computer. To set the user password, you must first set the machine password.

1. Press the ASSIST button while your VAIO computer is off.
The VAIO Care Rescue Mode screen appears.
2. Select Start BIOS setup.
Enter a password if it has already been set.
The BIOS setup screen appears.
3. Press the **←** or **→** key to select the Security tab, select Set Machine Password or Set User Password, and then press the Enter key.
The password entry screen appears.
4. Enter the password and press the Enter key.
To change the password, enter the current password and a new password. The password can be set up to 32 alphanumeric characters long (including spaces) and it is case-sensitive.
5. Press the **↑** or **↓** key to select Password when Power On, press the Enter key, and select Enabled.
6. Press the **←** or **→** key to select the Exit tab, select Exit Setup, and then press the Enter key.
7. At the confirmation prompt, press the Enter key.

Note

- Be sure to write down the password to avoid forgetting it.
- If you forget the password, you cannot boot up your VAIO computer.
- You can reset the user password at the BIOS setup screen by entering the machine password.
- If you forget the machine password, the password must be reset by authorized Sony service/support center. (The reset fee will be charged.)

Related Topic[Removing the Power-on Password](#)[Creating/Changing/Removing Your Windows Password](#)[What should I do if I forget the power-on password to start my VAIO computer?](#)

[▶ Troubleshooting](#)

How to Use

[Parts Description](#)

[Setup](#)

[Network / Internet](#)

[Connections](#)

[Settings](#)

[Playback](#)

[Backup / Recovery](#)

[Security](#)

[Other Operations](#)

[Notifications](#)

Removing the Power-on Password

If power-on password input for booting up your VAIO computer is no longer necessary, follow these steps to remove the machine password and user password.

1. Press the ASSIST button while your VAIO computer is off.
The VAIO Care Rescue Mode screen appears.
2. Select Start BIOS setup.
Enter a password if it has already been set.
The BIOS setup screen appears.
3. Press the **←** or **→** key to select the Security tab, select Set Machine Password or Set User Password, and then press the Enter key.
The password entry screen appears.
4. Leave the Enter New Password and Confirm New Password fields blank and press the Enter key.
5. Press the **←** or **→** key to select the Exit tab, select Exit Setup, and then press the Enter key.
At the confirmation prompt, press the Enter key.

Related Topic

[Setting/Changing the Power-on Password](#)[What should I do if I forget the power-on password to start my VAIO computer?](#)

[▶ Troubleshooting](#)

How to Use

[Parts Description](#)

[Setup](#)

[Network / Internet](#)

[Connections](#)

[Settings](#)

[Playback](#)

[Backup / Recovery](#)

[Security](#)

[Other Operations](#)

[Notifications](#)

Using Intel(R) Anti-Theft Technology <Intel(R) Anti-Theft Technology supported models>

You can change the Intel(R) Anti-Theft Technology settings in the BIOS setup screen. When using Intel(R) Anti-Theft Technology, follow these steps to enable the setting.

1. Press the ASSIST button while your VAIO computer is off.
The VAIO Care Rescue Mode screen appears.
 2. Select Start BIOS setup.
Enter a password if it has already been set.
The BIOS setup screen appears.
 3. Press the **←** or **→** key to select the Advanced tab.
 4. Select Intel(R) AT Support System and press the Enter key.
 5. Press the **↑** or **↓** key to select Enabled and press the Enter key.
 6. Press the **←** or **→** key to select the Exit tab, select Exit Setup, and then press the Enter key.
At the confirmation prompt, press the Enter key.
-

[▶ Troubleshooting](#)

How to Use

[Parts Description](#)

[Setup](#)

[Network / Internet](#)

[Connections](#)

[Settings](#)

[Playback](#)

[Backup / Recovery](#)

[Security](#)

[Other Operations](#)

[Notifications](#)

Creating Other Drives (Modifying Partitions)

Partitions are divided areas on your built-in storage device. Dividing the built-in storage device into more than one partition may have various advantages, such as separating the system files from your data files.

Your VAIO computer has only one partition (C: drive) as the factory default setting.*

If you want to store data in another partition, such as D: drive, change the partition size and create a new partition.

For more information on how to create partitions, see [Creating Partitions](#). **<ERROR>**

* Some models may have D: drive as the factory default setting.

Related Topic

[Creating Partitions](#)[Removing Recovery Contents to Free up Disk Space](#)

[▶ Troubleshooting](#)

How to Use

[Parts Description](#)

[Setup](#)

[Network / Internet](#)

[Connections](#)

[Settings](#)

[Playback](#)

[Backup / Recovery](#)

[Security](#)

[Other Operations](#)

[Notifications](#)

Creating Partitions

This topic describes how to create partitions.

1. Open Control Panel [\[Details\]](#) and select System and Security, and Create and format hard disk partitions under Administrative Tools.
If the User Account Control window appears, select YES.
Hint
 - If you are currently signed into your VAIO computer as a standard user, you may be prompted to enter an administrator name and password.
2. Right-click the C: drive and select Shrink Volume.
3. Enter the size of the partition to be created in Enter the amount of space to shrink in MB and select Shrink.
4. Right-click Unallocated and select New Simple Volume.
5. Follow the on-screen instructions.

Related Topic

[Creating Other Drives \(Modifying Partitions\)](#)[Removing Recovery Contents to Free up Disk Space](#)

[▶ Troubleshooting](#)

How to Use

[Parts Description](#)

[Setup](#)

[Network / Internet](#)

[Connections](#)

[Settings](#)

[Playback](#)

[Backup / Recovery](#)

[Security](#)

[Other Operations](#)

[Notifications](#)

Removing Recovery Contents to Free up Disk Space

Your built-in storage device contains the recovery area where the data for system recovery is stored. If your VAIO computer includes a solid state drive (SSD), you might want to minimize the recovery area by removing such data.

Once you have removed the data for system recovery, you need the Recovery Media for later system recovery.

1. Create Recovery Media if you have not yet created it. [\[Details\]](#)
2. If you recover your VAIO computer from the Recovery Media (optical discs) on the model without a built-in optical disc drive, connect an external optical disc drive (not supplied) to the computer. [\[Details\]](#)
If an AC adapter is supplied with the external optical disc drive, plug the AC adapter into a power source.
3. Insert the disc into the optical disc drive or connect the USB flash drive (not supplied) to the USB port while your VAIO computer is in Normal mode.
4. Turn off your VAIO computer and turn it on once again.
If you are using an external optical disc drive or the USB flash drive, turn off the computer, press the ASSIST button to display the VAIO Care Rescue Mode screen, and select Start from media (USB device/optical disc).
Follow the on-screen instructions until the Choose an option screen appears.
5. Select Troubleshoot and Recovery and maintenance.
Follow the on-screen instructions until the VAIO Care (Rescue Mode) : Recovery and maintenance screen appears.
6. Select Tools and @@@Remove recovery partition@@@.
7. Follow the on-screen instructions.

Related Topic

[Creating Other Drives \(Modifying Partitions\)](#)
[Creating Partitions](#)

[▶ Troubleshooting](#)

How to Use

[Parts Description](#)

[Setup](#)

[Network / Internet](#)

[Connections](#)

[Settings](#)

[Playback](#)

[Backup / Recovery](#)

[Security](#)

[Other Operations](#)

[Notifications](#)

About Backup

The backup process creates a backup copy of your data stored on the built-in storage device and saves it to another location.

Due to unexpected events or computer viruses, you might lose various data stored on your built-in storage device. To restore the lost data, its backup copy is needed.

It is strongly recommended that you back up your data regularly.

If you can start Windows, back up and restore your data with the Windows feature.

To use the feature, click  (Start), Control Panel, System and Security, and Backup and Restore.

Related Topic

[About Types of Backup](#)[Backing Up Your Data when You cannot Start Windows](#)[Restoring Your Data with VAIO Data Restore Tool](#)[Creating a Restore Point](#)[Restoring System Files Using the Restore Point when You cannot Start Windows](#)

[▶ Troubleshooting](#)

How to Use

[Parts Description](#)

[Setup](#)

[Network / Internet](#)

[Connections](#)

[Settings](#)

[Playback](#)

[Backup / Recovery](#)

[Security](#)

[Other Operations](#)

[Notifications](#)

About Types of Backup

You can use the Windows Backup and Restore feature to back up your valuable data. There are several types of backup to meet your needs, as described below.

Backing up files

You can select and back up folders and files stored on your VAIO computer to a DVD or an external hard disk drive. For details on how to back up data, refer to Windows Help and Support.

Backing up system images

You can create a backup copy of the whole system of your VAIO computer. If the built-in storage device or the computer ever stops working, you can use the system image to restore the computer as it was when backed up.

To create a system image, you need an optional hard disk drive formatted in NTFS format. You can also back up a system image to optical discs such as Blu-ray Disc or DVD disc. For details on how to create a system image, refer to Windows Help and Support.

[\[Details\]](#)

Note

- We will not restore or compensate for any lost or damaged data under any circumstances including failure of your VAIO computer.
- Create Recovery Media soon after purchasing your VAIO computer. In the event that you cannot make a backup copy of your data with the Windows feature due to computer malfunctions, you can use the backup tool included in Recovery Media to back up your data.

For information on how to create Recovery Media, see [Creating Recovery Media](#).

[\[Details\]](#)

Hint

- If your VAIO computer is equipped with no disc drive, you need to connect an external device, such as an external hard disk drive or DVD drive, to the computer before backup, or you need to resize the partition of your C: drive and create another partition before backup. [\[Details\]](#)

Related Topic

[About Backup](#)

[Backing Up Your Data when You cannot Start Windows](#)

[Restoring Your Data with VAIO Data Restore Tool](#)

[Restoring System Files Using the Restore Point when You cannot Start Windows](#)

[▶ Troubleshooting](#)

How to Use

[Parts Description](#)

[Setup](#)

[Network / Internet](#)

[Connections](#)

[Settings](#)

[Playback](#)

[Backup / Recovery](#)

[Security](#)

[Other Operations](#)

[Notifications](#)

Creating a Restore Point

A restore point enables you to restore your computer system files to a previous state, depending on when the restore point was created.

Typically, restore points are created automatically, for example when you install a software driver. However, we recommend that you create a new restore point manually before installing any software or software drivers on your VAIO computer.

Refer to Windows Help and Support for information on creating a restore point.

[\[Details\]](#)

Related Topic

[Restoring Your Data with VAIO Data Restore Tool](#)

[Restoring System Files Using the Restore Point when You cannot Start Windows](#)

[▶ Troubleshooting](#)

How to Use

[Parts Description](#)

[Setup](#)

[Network / Internet](#)

[Connections](#)

[Settings](#)

[Playback](#)

[Backup / Recovery](#)

[Security](#)

[Other Operations](#)

[Notifications](#)

Backing Up Your Data when You cannot Start Windows

If you cannot start Windows, back up your data with VAIO Care Rescue.

To rescue your data

1. Press the ASSIST button while your VAIO computer is off to start VAIO Care Rescue.
Hint
 - If the display language selection window appears, select your desired language and click OK.
2. Click Tools and Rescue Data.
3. Follow the on-screen instructions.

Note

- If your VAIO computer is equipped with the USB port that is compliant with the USB 2.0 standard when you use a USB device to back up your data, connect the USB device to the port.

Hint

- Alternatively, you can start VAIO Care Rescue with Recovery Media. [\[Details\]](#)
- It is recommended that you select an external hard disk drive as a location to save rescued files if you select Custom rescue.

Notes on using Rescue Data

- Handle rescued files with care to protect from unauthorized access.
- Disable the Windows hard disk drive encryption feature before using Rescue Data to back up and restore your data.
However, rescued files which are not encrypted on the built-in storage device can be easily accessed by unauthorized users using Recovery Media and this software. Therefore, after using the software, be sure to set the power-on or hard disk password, enable the Windows hard disk drive encryption feature, and keep the Recovery Media in a secure place to protect rescued files from unauthorized access.
- To restore copyright protected data, such as music files organized by digital media playback software, use a backup tool specified by the software you used to import such data. Sony does not guarantee the playback compatibility of data which is not restored with the specified backup tool.
- Using Rescue Data does not guarantee to back up all the data on your built-in storage device.
Sony assumes no liabilities for any loss of your data arising out of the backup process.
- Use the power cord or the AC adapter to power your VAIO computer while using this software.
- Rescued files may be divided into two or more files and saved in a specified location or renamed, depending on the location you select. Use VAIO Data Restore Tool to restore the rescued files. [\[Details\]](#)
- If an external hard disk drive or optical disc drive does not support the USB connection, you need to install a software driver.

Related Topic

[About Backup](#)[About Types of Backup](#)

Restoring Your Data with VAIO Data Restore Tool

Creating a Restore Point

Restoring System Files Using the Restore Point when You cannot Start Windows

[▶ Troubleshooting](#)

How to Use

[Parts Description](#)

[Setup](#)

[Network / Internet](#)

[Connections](#)

[Settings](#)

[Playback](#)

[Backup / Recovery](#)



[Security](#)

[Other Operations](#)

[Notifications](#)

Restoring System Files Using the Restore Point when You cannot Start Windows

When you cannot start Windows, follow these steps to restore computer system files. If you recover your VAIO computer from Recovery Media (optical discs) on the model without a built-in optical disc drive, connect an external optical disc drive (not supplied) to the computer. If an AC adapter is supplied with the external optical disc drive, plug the AC adapter into a power source.

1. Insert the disc into the optical disc drive or connect a USB flash drive to the USB port on your VAIO computer while the computer is in Normal mode.
2. Turn off your VAIO computer and turn it on once again.
If you are using an external optical disc drive or a USB flash drive, press the F11 key repeatedly until the VAIO logo screen disappears.
The Windows Boot Manager screen is displayed.
3. Press the  or  key to select Repair Windows 7 and press the Enter key.
4. Select a keyboard layout and click Next.
If the appropriate keyboard layout is not selected, you may not be able to enter the password correctly.
5. Select your operating system and click Next.
The system restore tool selection screen appears.
6. Click System Restore.
The System Restore window appears.
7. Click Next.
8. Select a restore point and click Next.
The confirmation window of the selected restore point appears.
9. Click Finish to confirm the restore point.
Restart your VAIO computer if the window prompts you to restart the computer.

Related Topic

[About Backup](#)[About Types of Backup](#)[Backing Up Your Data when You cannot Start Windows](#)[Restoring Your Data with VAIO Data Restore Tool](#)[Creating a Restore Point](#)

[▶ Troubleshooting](#)

How to Use

[Parts Description](#)

[Setup](#)

[Network / Internet](#)

[Connections](#)

[Settings](#)

[Playback](#)

[Backup / Recovery](#)

[Security](#)

[Other Operations](#)

[Notifications](#)

Restoring Your Data with VAIO Data Restore Tool

If you backed up files previously using VAIO Care Rescue, use VAIO Data Restore Tool to restore these files.

For instructions on how to use the software, refer to the help file included with the software.

1. Click  (Start), All Programs, and VAIO Data Restore Tool.
The VAIO Data Restore Tool window appears.

2. Click Next.

If the User Account Control window appears, click Yes.

Hint

- If you are currently logged onto your VAIO computer as a standard user, you may be prompted to enter an administrator name and password.
3. Follow the on-screen instructions.

Note

- To restore copyright protected data, such as music files organized by digital media playback software, use a backup tool specified by the software you used to import such data. Sony does not guarantee the playback compatibility of data which is not restored with the specified backup tool.

Hint

- If necessary, move the restored files to an original location.

Related Topic

[About Backup](#)[About Types of Backup](#)[Backing Up Your Data when You cannot Start Windows](#)[Creating a Restore Point](#)[Restoring System Files Using the Restore Point when You cannot Start Windows](#)

[▶ Troubleshooting](#)

How to Use

[Parts Description](#)

[Setup](#)

[Network / Internet](#)

[Connections](#)

[Settings](#)

[Playback](#)

[Backup / Recovery](#)

[Security](#)

[Other Operations](#)

[Notifications](#)

About Recovery

Recovery is the process of restoring your VAIO computer back to its original factory condition.

There are two ways to recover the computer:

- From Recovery Media
- From the recovery area

When do I have to perform recovery?

- If your VAIO computer has become unstable
- If your VAIO computer has been infected with a computer virus
- If your VAIO computer is experiencing problems which cannot be solved through troubleshooting
- If you have formatted the C: drive by mistake

Which software should I use to maintain and recover my VAIO computer?

Use the following software.

VAIO Care

- Creating Recovery Media
- Checking your computer hardware

VAIO Care Rescue

- Rescuing (backing up) your data
- Recovering your VAIO computer
- Erasing all the data on your built-in storage device

Hint

- Refer to the help file included with VAIO Care and VAIO Care Rescue for more information.

What is a recovery area?

The recovery area on the built-in storage device contains data for system and application recovery. Typically, you cannot modify or delete data in this area, however, there is commercially available software designed for this purpose.

Why do I have to create Recovery Media?

Recovery Media are used to restore your VAIO computer back to its original factory condition. If Windows does not start and you have deleted the recovery area, you will need the Recovery Media to perform recovery.

Create the Recovery Media immediately after the computer is ready for use.

Related Topic

- [Creating Recovery Media](#)
 - [Recovering from the Recovery Area](#)
 - [Recovering from Recovery Media](#)
 - [Notes on Recovery](#)
-

[▶ Troubleshooting](#)

How to Use

[Parts Description](#)[Setup](#)[Network / Internet](#)[Connections](#)[Settings](#)[Playback](#)[Backup / Recovery](#)[Security](#)[Other Operations](#)[Notifications](#)

Creating Recovery Media

Follow the instructions below to create Recovery Media.

To create Recovery Media

Hint

- You can use optical discs and a USB flash drive as Recovery Media. However, it is recommended that you use DVD-R or BD-R media, since you may accidentally delete the data on the USB flash drive.
The types of media your VAIO computer supports differ depending on the model you purchased.
 - The types of media you can use for Recovery Media are DVD-R/BD-R/DVD+R/DVD+R DL/DVD-R DL/DVD+RW/DVD-RW/BD-RE/BD-R DL/BD-RE DL.
The types of media your VAIO computer supports, the number of necessary discs, and the capacity of the USB flash drive you need will be displayed during the Recovery Media creation process.
1. Connect your VAIO computer to the Internet, download and install the latest updates using VAIO Update.
 2. If you create Recovery Media (optical discs) on the model without a built-in optical disc drive, connect an external optical disc drive (not supplied) to your VAIO computer.
[\[Details\]](#)
If an AC adapter is supplied with the external optical disc drive, plug the AC adapter into a power source.
 3. Click  (Start), All Programs, and VAIO Care.
If the User Account Control window appears, click Yes.

Hint

 - If you are currently logged onto your VAIO computer as a standard user, you may be prompted to enter an administrator name and a password.
 4. Click Advanced Tools, Restore and recovery, and Create Recovery Media.
 5. Read the on-screen instructions carefully, and then click Next.
 6. Follow the on-screen instructions.

Note

- It may take some time to display the current status of the procedure.
- Do not eject or disconnect the media while creating Recovery Media, as doing so may result in a failure of the process.
- Keep the Recovery Media in a secure place.

Notes on creating Recovery Media

- Recovery Media is specific to your VAIO computer on which it was created.
- Create Recovery Media immediately after your VAIO computer is ready for use. In the following cases, you may not be able to recover the computer from the recovery area and Recovery Media will be necessary:
 - You have modified the recovery area with software designed for data modification.
 - You have installed an operating system different from the preinstalled operating system on the computer.
 - You have formatted your built-in storage device without using VAIO Care Rescue.
- Do not touch or soil the surface of the discs. Fingerprints or dust on the surface may cause read/write errors.

Depending on the model you purchased, you may not be able to create Recovery Media using optical discs except DVD-R due to disk space shortage.

- Refer to the help file included with VAIO Care beforehand when you use a USB flash drive as Recovery Media.

Related Topic

[About Recovery](#)

[Recovering from the Recovery Area](#)

[Recovering from Recovery Media](#)

[Notes on Recovery](#)

[▶ Troubleshooting](#)

How to Use

[Parts Description](#)

[Setup](#)

[Network / Internet](#)

[Connections](#)

[Settings](#)

[Playback](#)

[Backup / Recovery](#)

[Security](#)

[Other Operations](#)

[Notifications](#)

Recovering from the Recovery Area

Recovery from the recovery area on the built-in storage device is faster than recovery using Recovery Media.

See Notes on Recovery [\[Details\]](#) before recovery.

1. Press the ASSIST button while your VAIO computer is off to start VAIO Care Rescue.

If the Edit Boot Options window is displayed, press the Enter key.

VAIO Care Rescue starts.

Hint

- If the display language selection window appears, select your desired language and click OK.
2. Click Start recovery wizard.
 3. Follow the on-screen instructions.

Hint

- To perform the custom recovery, select Tools and click Start advanced recovery wizard.

Related Topic

[About Recovery](#)

[Creating Recovery Media](#)

[Recovering from Recovery Media](#)

[Notes on Recovery](#)

[▶ Troubleshooting](#)

How to Use

[Parts Description](#)[Setup](#)[Network / Internet](#)[Connections](#)[Settings](#)[Playback](#)[Backup / Recovery](#)[Security](#)[Other Operations](#)[Notifications](#)

Recovering from Recovery Media

If the recovery area data has been corrupted or erased, you can use Recovery Media to recover your VAIO computer. However, it takes longer time to recover using Recovery Media than using the recovery area.

1. If you recover your VAIO computer from Recovery Media (optical discs) on the model without a built-in optical disc drive, connect an external optical disc drive (not supplied) to the computer. [\[Details\]](#)

If an AC adapter is supplied with the external optical disc drive, plug the AC adapter into a power source.

Note

- If your VAIO computer is equipped with the USB port that is compliant with the USB 2.0 standard, connect a USB device to the port.
2. Insert the disc into the optical disc drive or connect a USB flash drive to the USB port on your VAIO computer while the computer is in Normal mode.
Note
 - If your VAIO computer is equipped with the USB port that is compliant with the USB 2.0 standard, connect a USB device to the port.
 3. Turn off your VAIO computer and turn it on once again.
If you are using the external optical disc drive or the USB flash drive, press the F11 key repeatedly until the VAIO logo screen disappears.
The Windows Boot Manager screen is displayed.
If the screen does not appear, restart the computer and try again.

4. Press the **↑** or **↓** key to select Start VAIO Care Rescue and press the Enter key.
Hint

- If the display language selection window appears, select your desired language and click OK.

5. Select Start recovery wizard.
6. Follow the on-screen instructions.

Hint

- To perform the custom recovery, select Tools and click Start advanced recovery wizard.
- If you cannot recover your VAIO computer using the USB flash drive, connect the drive to another USB port on the computer and try recovering the computer again.

Related Topic[About Recovery](#)[Creating Recovery Media](#)[Recovering from the Recovery Area](#)[Notes on Recovery](#)

[▶ Troubleshooting](#)

How to Use

[Parts Description](#)

[Setup](#)

[Network / Internet](#)

[Connections](#)

[Settings](#)

[Playback](#)

[Backup / Recovery](#)

[Security](#)

[Other Operations](#)

[Notifications](#)

Notes on Recovery

Read the following notes thoroughly before recovering your VAIO computer.

Important notes on recovery

- Recovering your VAIO computer will delete all the data on the built-in storage device and restore all the settings to the original factory settings. Make sure you have a backup copy of your valuable data.
- Disconnect all peripherals from your VAIO computer except the power cord, the AC adapter, or devices required for recovery before recovering the computer.
- Do not stop the recovery process until the process is complete.
- If you have forgotten the password and cannot start the recovery process, contact an authorized Sony service/support center to reset it. A reset fee will be charged.

Notes on software

- Recovering your VAIO computer can restore only the preinstalled software. The software that has been installed on your own or the data you have created since purchase cannot be restored. In addition, you cannot restore only Windows.
- Certain preinstalled software includes options that allow the applications to uninstall or install themselves. However, the software may not work properly on your VAIO computer if such options are used.
- Installing software to modify partition sizes may disable recovery or Recovery Media creation.

Related Topic

[About Recovery](#)[Creating Recovery Media](#)[Recovering from the Recovery Area](#)[Recovering from Recovery Media](#)

[▶ Troubleshooting](#)

How to Use

[Parts Description](#)

[Setup](#)

[Network / Internet](#)

[Connections](#)

[Settings](#)

[Playback](#)

[Backup / Recovery](#)

[Security](#)

[Other Operations](#)

[Notifications](#)

Checking the Volume of the Recovery Area

Your built-in storage device contains the recovery area where the data for the system recovery is stored. To check the volume of the recovery area, follow these steps:

1. Click  (Start), right-click Computer, and select Manage.
 2. Click Disk Management under Storage in the left pane.
The volume of the recovery area and the total volume of the C: drive are displayed in the Disk 0 row in the center pane.
-

[▶ Troubleshooting](#)**How to Use**

[Parts Description](#)

[Setup](#)

[Network / Internet](#)

[Connections](#)

[Settings](#)

[Playback](#)

[Backup / Recovery](#)

[Security](#)

[Other Operations](#)

[Notifications](#)

About the Start Screen and New Menus

[▶ Troubleshooting](#)**How to Use**

[Parts Description](#)

[Setup](#)

[Network / Internet](#)

[Connections](#)

[Settings](#)

[Playback](#)

[Backup / Recovery](#)

[Security](#)

[Other Operations](#)

[Notifications](#)

Opening the Charms Bar

[▶ Troubleshooting](#)**How to Use**

[Parts Description](#)

[Setup](#)

[Network / Internet](#)

[Connections](#)

[Settings](#)

[Playback](#)

[Backup / Recovery](#)

[Security](#)

[Other Operations](#)

[Notifications](#)

Starting Apps and Opening Files

[▶ Troubleshooting](#)

How to Use

Parts Description

Setup

Network / Internet

Connections

Settings

Playback

Backup / Recovery

Security

Other Operations

Notifications

Exiting Apps

[▶ Troubleshooting](#)**How to Use**

[Parts Description](#)

[Setup](#)

[Network / Internet](#)

[Connections](#)

[Settings](#)

[Playback](#)

[Backup / Recovery](#)

[Security](#)

[Other Operations](#)

[Notifications](#)

Showing the Start Screen

[▶ Troubleshooting](#)**How to Use**

[Parts Description](#)

[Setup](#)

[Network / Internet](#)

[Connections](#)

[Settings](#)

[Playback](#)

[Backup / Recovery](#)

[Security](#)

[Other Operations](#)

[Notifications](#)

Showing the Desktop

[▶ Troubleshooting](#)

How to Use

Parts Description

Setup

Network / Internet

Connections

Settings

Playback

Backup / Recovery

Security

Other Operations

Notifications

Opening Control Panel

[▶ Troubleshooting](#)

How to Use

Parts Description

Setup

Network / Internet

Connections

Settings

Playback

Backup / Recovery

Security

Other Operations

Notifications

Opening Windows Help and Support

[▶ Troubleshooting](#)

How to Use

[Parts Description](#)

[Setup](#)

[Network / Internet](#)

[Connections](#)

[Settings](#)

[Playback](#)

[Backup / Recovery](#)

[Security](#)

[Other Operations](#)

[Notifications](#)

Using VAIO Update

VAIO Update provides a service that informs you of available update information, such as important notices or update programs, to keep your VAIO computer up to date.

Through the Internet, VAIO Update automatically detects the update programs that are necessary for enhancing your computer's performance or new software that is available, and let you download and install with simple steps.

1. Click  (Start), All Programs, and VAIO Care.
2. After VAIO Care starts, click VAIO Software and VAIO Update.
Follow the on-screen instructions.

Related Topic

[Keeping Your VAIO Computer in Optimum Condition \(VAIO Care\)](#)

[▶ Troubleshooting](#)

How to Use

[Parts Description](#)

[Setup](#)

[Network / Internet](#)

[Connections](#)

[Settings](#)

[Playback](#)

[Backup / Recovery](#)

[Security](#)

[Other Operations](#)

[Notifications](#)

Keeping Your VAIO Computer in Optimum Condition (VAIO Care)

With VAIO Care, you can perform the following operations to keep your VAIO computer running at an optimum level.

- Conduct regular performance checks and tune-ups.
- Find support information (the support website URL, the contact information phone number, etc.).
- Start VAIO Care just by pressing the ASSIST button and search for appropriate measures if you have any problem.

1. Press the ASSIST button while your VAIO computer is on.
VAIO Care starts.

Refer to the help file included with VAIO Care for more information.

Hint

- Pressing the ASSIST button while your VAIO computer is off starts VAIO Care Rescue Mode. VAIO Care Rescue Mode can be used to recover the computer in case of emergency, for example, if Windows does not start.
- Alternatively, open the Charms bar [\[Details\]](#), select  (Search) and Apps, and enter "VAIO Care" in the Search box to start VAIO Care.

Related Topic

[Recovering from the Recovery Area](#)[Backing Up Your Data when You cannot Start Windows](#)[Restoring Your Data with VAIO Data Restore Tool](#)

[▶ Troubleshooting](#)

How to Use

[Parts Description](#)

[Setup](#)

[Network / Internet](#)

[Connections](#)

[Settings](#)

[Playback](#)

[Backup / Recovery](#)

[Security](#)

[Other Operations](#)

[Notifications](#)

Updating Your VAIO Computer

Be sure to update your VAIO computer with the following software applications to enhance the computer's efficiency, security, and functionality.

Note

- Your VAIO computer must be connected to the Internet to download the updates.

Windows Update

Windows Update enables you to make your VAIO computer more stable.

1. Click  (Start), All Programs, and Windows Update.
2. Follow the on-screen instructions.

VAIO Update

VAIO Update automatically notifies you of new updates available on the Internet, and downloads and installs them on your VAIO computer.

1. Click  (Start), All Programs, and VAIO Care.
2. After VAIO Care starts, click VAIO Software and VAIO Update.
Follow the on-screen instructions.

Related Topic

[Using VAIO Update](#)

▶ Troubleshooting

How to Use

Parts Description

Setup

Network / Internet

Connections

Settings

Playback

Backup / Recovery

Security

Other Operations

Notifications

About Online Support Website

The online support website provides information about frequently asked questions about your VAIO computer.

Sony online support website

- USA
<http://esupport.sony.com/EN/VAIO/>
- Canada
<http://www.sony.ca/support/> (English)
<http://fr.sony.ca/support/> (French)
- Spanish-speaking Latin American countries or areas
<http://esupport.sony.com/ES/VAIO/LA/>
- Brazil
<http://esupport.sony.com/PT/VAIO/BR/>

Hint

- If you experience any problem and have a technical question about your VAIO computer, launch VAIO Care first, which offers you various options to help you solve the problem. [\[Details\]](#)
- When you contact VAIO support, you may be asked for the serial number and the model number of your VAIO computer. The serial number is a 15-digit number that can be found:
 - in the VAIO Care window;
 - on the bottom, the back panel of the computer, inside the back panel or inside the battery compartment;
 - on the original VAIO box.

The model number is located at the lower right corner of the display on the VAIO computer.

Other websites

You can find other useful information from the following URL.

Sony products

<http://www.sony.net/>

<http://www.sony.net/electronics/>

Operating system online support website

For Microsoft Windows operating system support, visit the Microsoft customer support site.

<http://support.microsoft.com/>

In Store Service & Support (available in USA only)

Make an appointment with a Sony certified technician at a U.S. Sony Store and get personalized service and support for your VAIO computer. Sony Technicians can assist with the setup of your new VAIO computer, system optimization, data rescue, and any repair service you might need.

<http://www.sony.com/store/>

Hint

- You can find a link to register your computer online in VAIO Care. Click  (Start), All Programs, and VAIO Care.

Related Topic

Read This First
Keeping Your VAIO Computer in Optimum Condition (VAIO Care)

[▶ Troubleshooting](#)

How to Use

[Parts Description](#)

[Setup](#)

[Network / Internet](#)

[Connections](#)

[Settings](#)

[Playback](#)

[Backup / Recovery](#)

[Security](#)

[Other Operations](#)

[Notifications](#)

About the Software License

This product contains software owned by Sony and licensed by third parties. Use of such software is subject to the terms and conditions of license agreements enclosed with this product.

Related Topic

[Read This First](#)

[▶ Troubleshooting](#)

How to Use

[Parts Description](#)

[Setup](#)

[Network / Internet](#)

[Connections](#)

[Settings](#)

[Playback](#)

[Backup / Recovery](#)

[Security](#)

[Other Operations](#)

[Notifications](#)

Cleaning Your VAIO computer/LCD screen

Before cleaning your VAIO computer, read the following precautions for the correct cleaning procedure.

When cleaning your VAIO computer

- Turn off your VAIO computer, unplug the AC adapter, and remove the battery pack before cleaning the computer.
- Use a soft, dry cloth to wipe debris and dust off your VAIO computer.
- Be sure to use a soft, dry cloth when cleaning your VAIO computer. If the computer is badly soiled, fog the surface of the computer with your breath and wipe off the dirt, or clean off with a lightly wet cloth and then wipe remaining moisture away with a dry cloth.
- Do not use solvents such as benzine, acetone, alcohol, thinner, or commercially available cleaners, as these may cause damage to the surface or coating of your VAIO computer.
- Use a blower for precision equipment to blow off debris and dust underneath the keys (keycaps). Do not remove any keycap from the keyboard.
Do not use a vacuum cleaner, as it may cause a malfunction.

When cleaning your LCD screen

- Be sure to use a soft, dry cloth when cleaning your VAIO computer. If the LCD screen is badly soiled, fog the surface of the LCD screen with your breath and wipe off the dirt, or clean off with a lightly wet cloth and then wipe remaining moisture away with a dry cloth.
 - Do not use solvents such as benzine, acetone, alcohol, thinner, or commercially available cleaners, as these may cause damage to the LCD screen.
-

[▶ Troubleshooting](#)

How to Use

[Parts Description](#)[Setup](#)[Network / Internet](#)[Connections](#)[Settings](#)[Playback](#)[Backup / Recovery](#)[Security](#)[Other Operations](#)[Notifications](#)

Setting Up an Appropriate Work Environment

This topic describes where to or not to place your VAIO computer and ergonomic instructions.

Where to place your VAIO computer

When placing your VAIO computer, ensure that:

- You have easy access to a power source and necessary ports.
- You leave enough space around the computer.
- The computer is placed on a flat surface that is wide enough and you can face the computer screen as you operate it.
- You can place the computer in front of you where you can sit upright and keep your forearms parallel to the floor.

Where not to place your VAIO computer

Placing your VAIO computer in an inappropriate location may cause damage or a malfunction. Do not place the computer in a location subject to:

- Direct sunlight
- Magnetic items or sources
- Heat sources, such as residential heating equipment
- Excessive dust
- High humidity
- Poor ventilation

Note

- The area around the air exhaust vent may become extremely hot while your VAIO computer is on. Be careful before touching the area.
- Do not place any object near the air exhaust vent that may block the vent.

Hint

- Your VAIO computer uses high-frequency radio signals and may cause interference to radio or TV reception. If this occurs, move the computer a suitable distance away from the radio or TV.

Ergonomic considerations

Whenever possible, you should attempt to take account of the following ergonomic considerations.

Furniture and posture

Sit in a chair with good back support. Adjust the level of the chair so your feet are flat on the floor. A footrest may make you more comfortable.

Sit in a relaxed, upright posture and avoid slouching forward or leaning far backwards.

Viewing angle of the computer screen

Use the screen tilting feature to find the best position. Make sure the computer screen is at or slightly below eye level when you are sitting in front of your VAIO computer. Adjust the brightness level of the display as well.

You can reduce eye strain and muscle fatigue by adjusting the tilt and brightness level of the computer screen to the proper position.

Lighting

Choose a location where windows and lights do not cause glare and reflection on the

computer screen. Use indirect lighting to avoid bright spots on the computer screen. Proper lighting adds to your comfort and work efficiency.

Note

- While adjusting the viewing angle, do not exert excessive pressure on your VAIO computer to eliminate a risk of mechanical damage.

Hint

- The same considerations apply when you use an external display.

Notes on handling your VAIO computer

Observe the following to avoid malfunctions and damage to your VAIO computer.

- Place your VAIO computer gently on a flat surface to avoid a mechanical shock.



- Be sure to turn off your VAIO computer before moving the computer. Moving the computer that is turned on may cause a hard disk malfunction. Be sure to disconnect all cables connected to the computer before moving it.
- Do not drop or hit your VAIO computer. Even a slight shock or vibration may cause a hard disk malfunction.
- Do not place your VAIO computer in an unstable position.

[▶ Troubleshooting](#)

How to Use

[Parts Description](#)

[Setup](#)

[Network / Internet](#)

[Connections](#)

[Settings](#)

[Playback](#)

[Backup / Recovery](#)

[Security](#)

[Other Operations](#)

[Notifications](#)

Safety Information

Refer to the supplied safety manual for detailed safety information.

Computer

- If you drop a solid object or any liquid onto your VAIO computer, shut down the computer, unplug it, and remove the battery pack if it is removable. You may want to have the computer checked by qualified personnel before operating it again.
- Use only specified peripheral equipment and interface cables.
- Keep small parts such as "Memory Stick" and "Memory Stick" adaptors out of reach of children. There is a risk of swallowing them.
- The temperature of the surface and the bottom of your VAIO computer, the AC adapter, and the battery may rise due to the CPU load or an electric current generated while the battery is being charged. This is normal and does not indicate a malfunction. The amount of heat generation varies depending on external devices or apps in use.
- If your VAIO computer or the AC adapter becomes extraordinarily hot, turn off the computer, unplug the AC adapter, remove the battery pack if it is removable, and then contact an authorized Sony service/support center.

Power source

- Do not place heavy objects on the power cord, or this could cause a fire.
- To disconnect the power cord, pull it out by holding the plug. Never pull the cord itself.
- Do not use cut or damaged connection cables.
- Unplug your VAIO computer from the AC outlet if you are not planning to use the computer for an extended period of time.
- If you are not using your VAIO computer for an extended period of time, remove the battery pack from the computer to prevent damage to the battery pack.

Headphones

- Do not use headphones while driving, cycling, or operating any motorized vehicle. It may create a traffic hazard and is illegal in some areas. It can also be potentially dangerous to play loud music while walking, especially at pedestrian crossings.
- Avoid using headphones at high volume. Hearing experts advise against continuous, loud and extended play. If you experience a ringing in your ears, reduce the volume or discontinue use.

[▶ Troubleshooting](#)

How to Use

[Parts Description](#)

[Setup](#)

[Network / Internet](#)

[Connections](#)

[Settings](#)

[Playback](#)

[Backup / Recovery](#)

[Security](#)

[Other Operations](#)

[Notifications](#)

Handling the Built-in Storage Device



The built-in storage device (hard disk drive or solid state drive) has a high storage density and reads or writes data in a short time. However, it can be easily damaged if improperly used.

If the built-in storage device is damaged, the data cannot be restored. To prevent losing data, you should be careful when handling your VAIO computer.

To avoid damaging your built-in storage device

- Do not subject your VAIO computer to sudden movements.
 - Keep your VAIO computer away from magnets.
 - Do not place your VAIO computer in a location subject to mechanical vibration or in an unstable position.
 - Do not turn off the power or restart your VAIO computer while reading or writing data to the storage device.
 - Do not use your VAIO computer in a place subject to extreme changes in temperature.
 - Do not remove the storage device from your VAIO computer.
-

[▶ Troubleshooting](#)**How to Use**[Parts Description](#)[Setup](#)[Network / Internet](#)[Connections](#)[Settings](#)[Playback](#)[Backup / Recovery](#)[Security](#)[Other Operations](#)[Notifications](#)**Trademarks**

- © 2012 Sony Electronics Inc. All rights reserved. Reproduction in whole or in part without written permission is prohibited.
- Sony and the Sony logo are trademarks or registered trademarks of Sony Corporation.
- VAIO, the VAIO logo and other Sony product or service names are trademarks or registered trademarks of Sony Corporation or any of its affiliates.
- i.LINK is a name to denote IEEE 1394.
- Intel, Intel Inside, Intel Core, Pentium, Intel SpeedStep, and Atom are trademarks or registered trademarks of Intel Corporation in the United States and/or other countries.
- Microsoft, Windows, Windows Vista, BitLocker, Aero, and the Windows logo are either registered trademarks or trademarks of Microsoft Corporation in the United States and/or other countries.
- Blu-ray Disc™, Blu-ray™, Blu-ray 3D™, the Blu-ray Disc logo, and the Blu-ray 3D logo are trademarks of the Blu-ray Disc Association.
- The BLUETOOTH word mark and logos are registered trademarks owned by Bluetooth SIG, Inc. and any use of such marks by Sony Corporation is under license. Other trademarks and trade names are those of their respective owners.
- Roxio Easy Media Creator is a trademark of Sonic Solutions.
- PowerDVD is trademark of CyberLink.Inc.
- NVIDIA and 3D Vision are registered trademarks and/or trademarks of NVIDIA Corporation in the United States and other countries.
- ArcSoft and the ArcSoft logo are registered trademarks of ArcSoft, Inc. ArcSoft WebCam Companion is a trademark of ArcSoft, Inc.
- AMD, the AMD Arrow logo, ATI, and combinations thereof, Radeon, AMD Phenom, AMD Turion, AMD Athlon, AMD Virtualization, AMD-V are trademarks of Advanced Micro Devices, Inc.
- SD Logo is a trademark. 
- SDHC Logo is a trademark. 
- SDXC Logo is a trademark. 
- The ExpressCard word mark and logos are owned by the PCMCIA and any use of such marks by Sony Corporation is under license. Other trademarks and trade names are those of their respective owners.
- HDMI, the HDMI logo and High-Definition Multimedia Interface are trademarks or registered trademarks of HDMI Licensing LLC.
- CompactFlash® is a trademark of SanDisk Corporation.
- "PlaceEngine" is a registered trademark of Koozyt, Inc. "PlaceEngine" was developed by Sony Computer Science Laboratories, Inc. and is licensed by Koozyt, Inc.
- "AVCHD" is a trademark of Panasonic Corporation and Sony Corporation.
- Manufactured under license from Dolby Laboratories. Dolby and the double-D symbol are trademarks of Dolby Laboratories.
- ENERGY STAR and the ENERGY STAR mark are registered U.S. marks.

All other names of systems, products, and services are trademarks of their respective owners. In the manual, the ™ or ® marks are not specified.

Features and specifications are subject to change without notice.

All other trademarks are trademarks of their respective owners.

Not all the software listed above may be delivered with your model.

[▶ Troubleshooting](#)

How to Use

[Parts Description](#)

[Setup](#)

[Network / Internet](#)

[Connections](#)

[Settings](#)

[Playback](#)

[Backup / Recovery](#)

[Security](#)

[Other Operations](#)

[Notifications](#)

Solving Common Problems with Your VAIO Computer

If you have any problem operating your VAIO computer, try these suggestions before contacting an authorized Sony service/support center or your local Sony dealer directly.

1. See other sections in this on-screen manual.
2. Start VAIO Care and perform necessary operations.
3. Visit the VAIO online support website and find necessary information.

Related Topic

[Keeping Your VAIO Computer in Optimum Condition \(VAIO Care\)](#)[Read This First](#)[About Online Support Website](#)

[▶ Troubleshooting](#)

How to Use

[Parts Description](#)

[Setup](#)

[Network / Internet](#)

[Connections](#)

[Settings](#)

[Playback](#)

[Backup / Recovery](#)

[Security](#)

[Other Operations](#)

[Notifications](#)

About the International ENERGY STAR(R) Program



The following information is applicable to ENERGY STAR qualified products only.

As an ENERGY STAR Partner, Sony confirmed that this product meets the ENERGY STAR standards for energy efficiency.

The International ENERGY STAR Office Equipment Program is an international program that promotes energy saving through the use of computers and office equipment. The program backs the development and dissemination of products with functions that effectively reduce energy consumption.

For detailed information on the ENERGY STAR Program, visit the following websites:

- <http://www.energystar.gov> (USA)
- <http://www.eu-energystar.org> (Europe)

This computer is designed in compliance with the ENERGY STAR standards and delivered with the following power saving settings that apply to the computer running on AC power:

- The LCD backlight is turned off automatically after no more than 15 minutes of inactivity.
- The computer enters Sleep mode automatically after no more than 30 minutes of inactivity.

Press the  (Power) button to bring the computer back into Normal mode.

[▶ How to Use](#)

Troubleshooting

[Hardware](#)

[Software](#)

[Network / Internet](#)

[Backup / Recovery](#)

[Security](#)

[Peripheral Devices](#)

What should I do if a message appears indicating that the battery pack is incompatible or has been incorrectly installed, after which my VAIO computer enters Hibernate mode?

- This problem could be due to the battery pack not being installed properly. To solve this problem, turn off your VAIO computer, remove the battery pack, and then reinstall it. [\[Details\]](#)
 - If the problem persists, it is likely that the installed battery pack is not compatible with your VAIO computer or has failed. Turn off the computer, remove the battery pack, and then replace it with a new one specified by Sony.
-

[▶ How to Use](#)**Troubleshooting**

[Hardware](#)

[Software](#)

[Network / Internet](#)

[Backup / Recovery](#)

[Security](#)

[Peripheral Devices](#)

Why can't I fully charge my battery pack?

- The battery care function is enabled on the (100000) to extend the life of your battery pack. Check the settings on the (100000).
 - If ambient temperature is outside the specified range or the power consumption of your VAIO computer is high when you charge the battery pack, the charge current may be reduced.
-

[▶ How to Use](#)

Troubleshooting

[Hardware](#)

[Software](#)

[Network / Internet](#)

[Backup / Recovery](#)

[Security](#)

[Peripheral Devices](#)

Why doesn't my computer screen turn off after the automatic turn-off time has passed?

- Some apps or screen savers are designed to temporarily disable the feature of Windows that turns off the computer screen or places your VAIO computer into Sleep mode after a certain period of inactivity. To solve this problem, exit all running apps or change the current screen saver.
-

[▶ How to Use](#)**Troubleshooting**

[Hardware](#)

[Software](#)

[Network / Internet](#)

[Backup / Recovery](#)

[Security](#)



[Peripheral Devices](#)

Why is my VAIO computer running slowly and the CPU clock frequency low while the computer is running on battery power?

- While your VAIO computer is running on battery power, the CPU clock frequency is reduced for power conserving purposes, which causes the computer to run slowly. This is normal and does not indicate a malfunction.
-

[▶ How to Use](#)[Troubleshooting](#)[Hardware](#)[Software](#)[Network / Internet](#)[Backup / Recovery](#)[Security](#)[Peripheral Devices](#)

What should I do if my VAIO computer does not turn on (the power indicator light does not turn on in green)?

- Make sure all cables are securely connected to devices, such as between your VAIO computer and the AC adapter; the AC adapter and the power cord; and the power cord and an AC outlet. [\[Details\]](#)
- If you plug the power cord of your VAIO computer into a power strip with a switch, make sure the switch is turned on and the power cord of the power strip is securely plugged into an AC outlet.
- If you do not turn off your VAIO computer through the normal procedure, the power controller may be suspended due to a program error. Disconnect all cables and peripheral devices, such as the power cord and the USB device, remove the battery pack, and wait about five minutes. Then, put them back in place and turn on the computer again.
- Before using your VAIO computer for the first time, you need to connect the computer to a power source with the AC adapter.
- Check that you are using the supplied Sony AC adapter. For your safety, use only the genuine Sony rechargeable battery pack and AC adapter, which are supplied by Sony for your VAIO computer.
- Make sure the battery pack is installed properly.
- The battery pack may have run out of power.
- Make sure your VAIO computer is not in Hibernate mode by pressing the  (Power) button on the computer. Note that if you press and hold down the  (Power) button for more than four seconds, the computer will turn off.
- If you bring your VAIO computer directly from a cold location to a warm one, or use it in a high humidity location, moisture may condense inside the computer. In such a case, allow at least one hour before turning on the computer. Do not use the computer in a high humidity location (a relative humidity of more than 80 %), as it may cause the computer to malfunction.

[▶ How to Use](#)**Troubleshooting**

[Hardware](#)

[Software](#)

[Network / Internet](#)

[Backup / Recovery](#)

[Security](#)



[Peripheral Devices](#)

What should I do if my VAIO computer does not turn on or the power button does not work (the power indicator light blinks fast)?

- The battery pack may not be installed properly.
Remove the battery pack and reinstall it properly. [\[Details\]](#)
 - If the problem persists, it means the installed battery is not compatible with your VAIO computer.
Remove the battery pack.
-



[How to Use](#)[Troubleshooting](#)[Hardware](#)[Software](#)[Network / Internet](#)[Backup / Recovery](#)[Security](#)[Peripheral Devices](#)

What should I do if the power indicator light turns on in green when I press the power button but the screen remains blank?

- Make sure the brightness and contrast controls are adjusted correctly.
- An external display may be selected as the display output. Press the Fn+F7 keys several times to select your desired display output, and then press the Enter key.
- If you are using an external display, make sure it is plugged into an AC outlet and is on. Make sure the brightness and contrast controls are adjusted correctly. Refer to the manual that came with your display for information on how to change the settings.
- Press the Alt+F4 keys several times to close the app window. An app error may have occurred.
- If you wait for a while and the computer screen remains blank, restart your VAIO computer by following the procedures below in order. Note that following these procedures may cause working data to become corrupted.
 - Disconnect all peripheral devices, such as a printer or a USB device, and your VAIO computer from the network, if any.
 - Press and hold down the  (Power) button for more than four seconds and make sure the power indicator light is off. Then, turn on your VAIO computer again.
 - If the problem persists, press and hold down the  (Power) button for more than four seconds and make sure the power indicator light is off. Disconnect all cables connected to your VAIO computer, such as the AC adapter, remove the battery pack, and wait about five minutes. Then, put all cables, peripheral devices, and the battery pack back in place and turn on the computer again.
- If an extra memory module is not installed properly, your VAIO computer may not turn on. Use of memory modules not specified by Sony or improper installation of memory modules may cause the computer to fail to boot or to become unstable. In such a case, reinstall the memory module. If you use a memory module other than the Sony branded memory module, contact the sales dealer or the manufacturer of the memory module.
- If you bring your VAIO computer directly from a cold location to a warm one, or use it in a high humidity location, moisture may condense inside the computer. In such a case, allow at least one hour before turning on the computer. Do not use the computer in a high humidity location (a relative humidity of more than 80 %), as it may cause the computer to malfunction.

[How to Use](#)**Troubleshooting**[Hardware](#)[Software](#)[Network / Internet](#)[Backup / Recovery](#)[Security](#)[Peripheral Devices](#)

What should I do if I cannot turn off my VAIO computer?

- Follow any of these procedures to exit all running apps and then turn off your VAIO computer again.
 - Drag the app from the top center of the screen to the bottom center. [\[Details\]](#)
 - Press the Alt+F4 keys.
If there is unsaved data, save it at the confirmation prompt.
Press the Alt+F4 keys until the Shut Down Windows window appears and select Shut down from the drop-down list and OK.
- If you have installed a new app on your VAIO computer, check if the app is working properly, its data is normal, and you have operated it correctly.
- Contact the app publisher or designated provider for technical support.
- If you connect peripheral devices, such as a printer or a USB device, to your VAIO computer or connect the computer to your network, disconnect all peripheral devices or the computer's network connection and then turn off the computer.
While the computer is communicating with a peripheral device or the network, Windows does not allow you to turn off the computer. In addition, some peripheral device drivers for the peripheral devices do not support the feature to force the computer to shut down.
- If the computer screen freezes, press the Ctrl+Alt+Delete keys, select  (Shut down) in the lower right corner of the computer screen, and then select Shut down.
- If your VAIO computer freezes with a message indicating the settings are being saved or the computer is shutting down displayed, follow these procedures in order.
 - Press the Enter key.
Wait for a while.
 - If the problem persists, press the Ctrl+Alt+Delete keys.
Wait for a while.
- If you still cannot turn off your VAIO computer even after you follow all the above procedures in this topic, perform the following operations.
Note that performing these operations may cause working data to become corrupted. Be sure to disconnect the computer from the network before performing the following operations.
 - Press the Ctrl+Alt+Delete keys, select  (Shut down) in the lower right corner of the computer screen, and then select Shut down.
 - Press and hold down the  (Power) button for more than four seconds.
 - Unplug the AC adapter and remove the battery pack from your VAIO computer.

[▶ How to Use](#)

Troubleshooting

[Hardware](#)

[Software](#)

[Network / Internet](#)

[Backup / Recovery](#)

[Security](#)

[Peripheral Devices](#)

Why does my VAIO computer automatically turn off?

- When the battery pack is running out of power, your VAIO computer automatically enters Hibernate mode and eventually turns off.
Connect the AC adapter to the computer or charge the battery pack.
-

[▶ How to Use](#)

Troubleshooting

[Hardware](#)

[Software](#)

[Network / Internet](#)

[Backup / Recovery](#)

[Security](#)

[Peripheral Devices](#)

What should I do if my VAIO computer does not enter Hibernate mode?

- To place your VAIO computer into Hibernate mode, disable Rapid Wake in the Rapid Wake window on VAIO Control Center. [\[Details\]](#)
If you still cannot select Hibernate mode, select Change advanced power settings in the Power Options window and check if Allow hybrid sleep under Sleep is set to Off. If it is set to On, change it to Off. [\[Details\]](#)
-

[▶ How to Use](#)**Troubleshooting**

[Hardware](#)

[Software](#)

[Network / Internet](#)

[Backup / Recovery](#)

[Security](#)

[Peripheral Devices](#)

Why doesn't my VAIO computer enter Hibernate mode when the battery pack is running out of power?

- This problem occurs when Windows does not allow a task to be suspended, depending on the running apps or the connected external devices.
-

[▶ How to Use](#)

Troubleshooting

[Hardware](#)

[Software](#)

[Network / Internet](#)

[Backup / Recovery](#)

[Security](#)

[Peripheral Devices](#)

What should I do if my VAIO computer does not enter Sleep mode?

- If the utility program, such as a printer utility program, is running, exit the program or temporarily disable it.
 - Depending on the type of your screen saver, your VAIO computer may not enter Sleep mode while the screen saver is activated.
 - Your VAIO computer may not enter Sleep mode if you execute a task on the computer before completely entering Sleep mode.
-

[▶ How to Use](#)

Troubleshooting

[Hardware](#)

[Software](#)

[Network / Internet](#)

[Backup / Recovery](#)

[Security](#)

[Peripheral Devices](#)

Why does a message appear and Windows fail to start when I turn on my VAIO computer?

- The BIOS boot options may have been incorrectly configured. Press the ASSIST button while your VAIO computer is off to display the VAIO Care Rescue Mode screen, select Start BIOS setup, and change the Boot Mode setting and restart the computer.
- If a message, such as "Secure Boot Fail," appears, check the following:
 - Your VAIO computer may be booting from an external device that the computer does not support. When an external drive or a USB device is connected to the computer, disconnect it and restart the computer.
 - The BIOS boot options may have been changed from the factory default settings. Press the ASSIST button while your VAIO computer is off to display the VAIO Care Rescue Mode screen, and select Start BIOS setup. Press the ◀ or ▶ key to select the Security tab, select Factory Default, and then press the Enter key. When the confirmation prompt appears, press the Enter key and restart the computer.
 - If a message appears even after you restart your VAIO computer by following the above procedures, recover the computer using the recovery data on the built-in hard disk drive or SSD or using the Recovery Media you have created. [\[Details\]](#)
 - The BIOS boot options may have been incorrectly configured. If the operating system on your VAIO computer is other than the preinstalled system, press the ASSIST button while the computer is off to display the VAIO Care Rescue Mode screen, and select Start BIOS setup. Press the ◀ or ▶ key to select the Security tab, change the Secure Boot setting to Disabled, and then restart the computer.

▶ Troubleshooting

How to Use

Parts Description

Setup

Network / Internet

Connections

Settings





Playback

Backup / Recovery

Security

Other Operations

Notifications

- When the pointer does not move because your finger reached an edge of the touch pad, lift the finger off the touch pad and put it back on the center of the touch pad.
 - The pointer may not temporarily move against your intention depending on the operating condition of your VAIO computer.
In such a case, wait for a while before moving the pointer again.
If the pointer still does not move, press the Ctrl+Alt+Delete keys, select  (Shut down) in the lower right corner of the computer screen, and then select Shut down.
If the problem persists, press and hold down the  (Power) button or slide the  (Power) switch to the right for more than four seconds.
Turning off the computer with the Ctrl+Alt+Delete keys, the  (Power) button, or the  (Power) switch may cause loss of unsaved data.
-

[▶ Troubleshooting](#)

How to Use

[Parts Description](#)

[Setup](#)

[Network / Internet](#)

[Connections](#)

[Settings](#)



[Playback](#)

[Backup / Recovery](#)

[Security](#)

[Other Operations](#)

[Notifications](#)

- Restart your VAIO computer.
Press the Ctrl+Alt+Delete keys, select  (Shut down) in the lower right corner of the computer screen, and then select Restart.
If the problem persists, press and hold down the  (Power) button for more than four seconds, or slide the  (Power) switch to the right for more than four seconds.
-

[▶ How to Use](#)**Troubleshooting**

[Hardware](#)

[Software](#)

[Network / Internet](#)

[Backup / Recovery](#)

[Security](#)

[Peripheral Devices](#)

What should I do if I cannot enter certain characters with my keyboard?

- If you cannot enter numbers by the numeric keypad, check if the Num lock icon in the desktop notification area is green or gray. (Wireless keyboard equipped model)
When the icon is grayed out, the numeric keypad works as the directional arrow keys and the Home, Page Up, Page Down and End keys. Press the Num Lk key to change the Num lock icon to green before entering numbers. [\[Details\]](#)
- Check if the Caps Lock indicator light is on or off.
When the indicator light is on, characters typed will appear in uppercase (or lowercase if you also hold down the Shift key).
When the indicator light is off, characters typed will appear in lowercase (or uppercase if you also hold down the Shift key).
Press the Shift+Caps Lock keys to turn the Caps Lock indicator light on or off. [\[Details\]](#)
- Check if the Num lock indicator light is on or off.
When the indicator light is on, you can enter the numbers printed on the keys.
When the indicator light is off, you can enter the letters and symbols printed on the keys.
Press the Num Lk key to turn the Num Lock indicator light on or off. [\[Details\]](#)
- Check if the Caps Lock indicator light is on or off.
When the indicator light is on, characters typed will appear in uppercase (or lowercase if you also hold down the Shift key).
When the indicator light is off, characters typed will appear in lowercase (or uppercase if you also hold down the Shift key).
Press the Shift+Caps Lock keys to turn the Caps Lock indicator light on or off. [\[Details\]](#)

[▶ How to Use](#)

Troubleshooting

[Hardware](#)

[Software](#)

[Network / Internet](#)

[Backup / Recovery](#)

[Security](#)

[Peripheral Devices](#)

What should I do if my keyboard configuration is wrong?

- The language layout of your keyboard is labeled on the packaging box. If you choose a different regional keyboard when you complete the Windows setup, the key configuration will be mismatched. To change the keyboard configuration, refer to Windows Help and Support.
-

[▶ How to Use](#)

Troubleshooting

[Hardware](#)

[Software](#)



[Network / Internet](#)

[Backup / Recovery](#)

[Security](#)

[Peripheral Devices](#)

What should I do if my computer screen goes blank?

- Make sure your VAIO computer is on and not in a power saving mode. [\[Details\]](#)
- Make sure your VAIO computer is securely plugged into an AC outlet [\[Details\]](#) and the power indicator light is on.
- The computer screen may be off.
Press any key on the keyboard.
- If your VAIO computer is running on battery power, make sure the battery pack is installed properly and is charged. [\[Details\]](#)
- If you wait for a while and the computer screen remains blank, follow the procedures below:
 - Press and hold down the  (Power) button for more than four seconds, check if the power indicator light is off, and then turn on your VAIO computer.
 - If the problem persists, press and hold down the  (Power) button for more than four seconds and check if the power indicator light is off. Disconnect all cables and peripheral devices, such as the power cord and the USB device, remove the battery pack, and wait about five minutes. Then, put them back in place and turn on your VAIO computer again.

[▶ How to Use](#)

Troubleshooting

[Hardware](#)

[Software](#)

[Network / Internet](#)

[Backup / Recovery](#)

[Security](#)

[Peripheral Devices](#)

What should I do if I cannot see proper images on the computer screen?

- Make sure the screen color setting is set to True Color (32 bit). Refer to Windows Help and Support for more information on how to change the setting.
-

[▶ How to Use](#)

Troubleshooting

[Hardware](#)

[Software](#)

[Network / Internet](#)

[Backup / Recovery](#)

[Security](#)

[Peripheral Devices](#)

What should I do if videos are not displayed on the computer screen?

- The video memory of your VAIO computer may be insufficient for displaying high resolution videos. In such a case, lower the resolution of the LCD screen. [\[Details\]](#)
-

[▶ How to Use](#)

Troubleshooting

[Hardware](#)

[Software](#)

[Network / Internet](#)

[Backup / Recovery](#)

[Security](#)

[Peripheral Devices](#)

What should I do if videos are not displayed smoothly?

- It is recommended you disable your screen saver.
If the screen saver is enabled, it may be activated during DVD playback and prevent the playback from running successfully. Some screen savers have been found to even change the display resolution and colors.
 - If you have enabled Aero Themes for your desktop theme, change the current desktop theme.
Refer to Windows Help and Support for information on how to change the theme.
 - Some videos may not be displayed smoothly depending on the type or bit rate of videos. Lowering the screen resolution may improve video playback performance. [\[Details\]](#)
 - If data access to a memory card is in progress (the media access indicator light is on), wait until the data access ends and then start playback again.
 - If you are playing a video stored on the memory card, copy it to the built-in storage device and then play the copied video.
-

[▶ How to Use](#)**Troubleshooting**

[Hardware](#)

[Software](#)

[Network / Internet](#)

[Backup / Recovery](#)

[Security](#)

[Peripheral Devices](#)

How do I change the LCD brightness?

- Press the Fn+F5 or Fn+F6 keys to adjust the LCD brightness of your VAIO computer.
[\[Details\]](#)
-

[▶ How to Use](#)

Troubleshooting

[Hardware](#)

[Software](#)

[Network / Internet](#)

[Backup / Recovery](#)

[Security](#)

[Peripheral Devices](#)

What should I do if some items do not fit on the computer screen?

- Check that the text size is set to 100%. If not, some items, for example a software menu, may not be displayed correctly, depending on the software you are using. Refer to Windows Help and Support for more information on how to change the text size.
-

[▶ How to Use](#)**Troubleshooting**

[Hardware](#)

[Software](#)

[Network / Internet](#)

[Backup / Recovery](#)

[Security](#)

[Peripheral Devices](#)

Why do sound interruptions and/or dropped frames occur when I play high-definition videos, such as those recorded with the AVCHD digital video camcorder?

- Playing high-definition videos requires substantial hardware resources, such as CPU, GPU, or system memory performance on your VAIO computer. During the video playback, some operations and/or functions may become unavailable, and sound interruptions, dropped frames, and playback failure may occur depending on the configuration of the computer.
-

[▶ How to Use](#)

Troubleshooting

[Hardware](#)

[Software](#)

[Network / Internet](#)

[Backup / Recovery](#)

[Security](#)

[Peripheral Devices](#)

What should I do if sound interruptions occur during video or audio playback?

- Sound interruptions may occur when the CPU load is high. In this case, reduce the CPU load by exiting all running apps other than a playback app, or by disabling unnecessary audio effects applied to playback.
-

[▶ How to Use](#)

Troubleshooting

[Hardware](#)

[Software](#)

[Network / Internet](#)

[Backup / Recovery](#)

[Security](#)

[Peripheral Devices](#)

What should I do if my microphone does not work?

- Check if your microphone is selected as a recording device. Open Control Panel [\[Details\]](#) and select Hardware and Sound. Select Sound and check if there is a check mark on your desired microphone icon on the Recording tab. If not, select the icon and Set Default. If the icon is not displayed, make sure the microphone is properly connected to your VAIO computer.
 - If you are using an external microphone, use a plug-in power microphone.
-

[▶ How to Use](#)

Troubleshooting

[Hardware](#)

[Software](#)

[Network / Internet](#)

[Backup / Recovery](#)

[Security](#)

[Peripheral Devices](#)

What should I do if I hear microphone feedback from speakers when using my microphone?

- Microphone feedback may occur when your microphone receives the sound from a sound output device, such as speakers.
 - Keep the microphone away from a sound output device.
 - Turn down the volume of the speakers and the microphone.
-

[▶ How to Use](#)

Troubleshooting

[Hardware](#)

[Software](#)



[Network / Internet](#)

[Backup / Recovery](#)

[Security](#)

[Peripheral Devices](#)

What should I do if I do not hear sound from speakers or headphones?

- Check if the volume from speakers or headphones is not minimized.
 - Keep pressing the Fn+F4 keys to turn up the volume loud enough to hear sound. [\[Details\]](#)
- Check if the volume in Windows is not turned off or minimized. [\[Details\]](#)
When the volume is turned off () , select  (Deactivate muting) to turn on the volume (). When the volume is minimized, turn up the volume.
- When connecting external speakers or headphones, check the following:
 - Make sure external speakers or headphones are properly connected to your VAIO computer. [\[Details\]](#)
 - If external speakers require external power, make sure the speakers are securely connected to an AC outlet.
 - Make sure external speakers are turned on.
 - Make sure the volume from external speakers is not minimized.
- Make sure the sound output device is correctly selected. [\[Details\]](#)
- Check the volume on the playback app you are using.

[▶ How to Use](#)

Troubleshooting

[Hardware](#)

[Software](#)

[Network / Internet](#)

[Backup / Recovery](#)

[Security](#)

[Peripheral Devices](#)

What should I do if I cannot remove the disc from the optical disc drive?

- The drive eject button may not work depending on your VAIO computer status. Exit all running apps and press the drive eject button. If the problem persists, restart the computer and press the drive eject button again.
-

[▶ How to Use](#)

Troubleshooting

[Hardware](#)

[Software](#)

[Network / Internet](#)

[Backup / Recovery](#)

[Security](#)

[Peripheral Devices](#)

Why does it take time to write data to DVD writable media?

- In disc-at-once mode, it may take about 20 to 40 minutes to complete the writing process after the progress bar reaches 100%. This is normal and does not indicate a malfunction, so wait until the process is complete.

Because disc-at-once mode writes all the data to a disc at one time, the optical disc drive writes 1 GB of dummy data to a disc even when the actual data size is less than 1 GB to ensure playback compatibility.

Some players can play only discs that are created in disc-at-once mode. When you play the created disc on a player other than your VAIO computer, make sure if the player supports disc writing mode you selected.

[▶ How to Use](#)**Troubleshooting**

[Hardware](#)

[Software](#)

[Network / Internet](#)

[Backup / Recovery](#)

[Security](#)

[Peripheral Devices](#)

What should I do if I cannot play a disc, or dropped frames and/or sound interruptions occur during playback?

- Exit all running apps other than the playback app.
 - Try using other playback apps, such as a DVD playback app.
 - To play DVD media with Content Protection for Recordable Media (CPRM), you need to install a CPRM pack for the playback app on your VAIO computer.
 - To play copyright protected Blu-ray Disc media continually, you need to update the AACS key.
Follow a message displayed on the computer screen to update the AACS key. You can update it through the Internet.
 - Uninstall the playback or writing app installed on your VAIO computer after purchase. For instructions on how to uninstall the app, refer to the help file included with the app or Windows Help and Support. [\[Details\]](#)
-

[▶ How to Use](#)

Troubleshooting

[Hardware](#)

[Software](#)

[Network / Internet](#)

[Backup / Recovery](#)

[Security](#)

[Peripheral Devices](#)

Why can't I write data to a disc?

- DVD+R DL, DVD+R, DVD-R DL, or DVD-R media are not rewritable. You can write data to such media only once and cannot delete data on the media.
 - See Supported Discs for more information. [\[Details\]](#)
-

[▶ How to Use](#)

Troubleshooting

[Hardware](#)

[Software](#)

[Network / Internet](#)

[Backup / Recovery](#)

[Security](#)

[Peripheral Devices](#)

Why does the viewfinder show no images or poor-quality images?

- The built-in camera cannot be shared by more than one software application. Exit the current application before starting another.
 - On models with VAIO Gesture Control or Media Gallery, you cannot use another camera application that uses the built-in camera while using the gesture function of the software.
 - The viewfinder may show some noise, for example horizontal streaks, when you are viewing a rapid-moving object. This is normal and does not indicate a malfunction.
 - If the problem persists, restart your VAIO computer.
-

[▶ How to Use](#)

Troubleshooting

[Hardware](#)

[Software](#)

[Network / Internet](#)

[Backup / Recovery](#)

[Security](#)

[Peripheral Devices](#)

Why is the video input from the built-in camera suspended momentarily?

- The video input may be suspended momentarily if:
 - A shortcut key with the Fn key is used.
 - The CPU load increases.
-

[▶ How to Use](#)

Troubleshooting

[Hardware](#)

[Software](#)

[Network / Internet](#)

[Backup / Recovery](#)

[Security](#)

[Peripheral Devices](#)

Why are captured images poor in quality?

- Images captured under fluorescent light may contain light reflections.
 - A dark portion in captured images may contain noise.
 - The area on and around the built-in camera is soiled. Clean the area. [\[Details\]](#)
-

[▶ How to Use](#)

Troubleshooting

[Hardware](#)

[Software](#)

[Network / Internet](#)

[Backup / Recovery](#)

[Security](#)

[Peripheral Devices](#)

What should I do if captured images contain dropped frames and audio interruptions?

- The effect settings on your software application may cause dropped frames. Refer to the help file included with your software application for more information.
 - There may be more software applications running than your VAIO computer can handle. Exit the applications that you are not currently using.
 - This problem may occur while your VAIO computer is running on the power saving plan, which reduces the CPU performance. Check the current power plan. [\[Details\]](#)
-

[▶ How to Use](#)

Troubleshooting

[Hardware](#)

[Software](#)

[Network / Internet](#)

[Backup / Recovery](#)

[Security](#)

[Peripheral Devices](#)

What should I do if captured images flicker?

- This problem occurs when you use the built-in camera under fluorescent lights due to a mismatch between the lighting output frequency and the shutter speed.
To reduce flicker noise, change the direction of your VAIO computer so that you can adjust the direction of the built-in camera. Some software applications offer adjustable parameters, such as brightness, to eliminate flicker noise.
-

[▶ How to Use](#)

Troubleshooting

[Hardware](#)

[Software](#)

[Network / Internet](#)

[Backup / Recovery](#)

[Security](#)

[Peripheral Devices](#)

What should I do if the website is not displayed?

- Depending on your Internet Service Provider (ISP), you may need to change the web browser settings.
Refer to the manual provided from your ISP to check the web browser settings.
 - Make sure the URL in the address bar is correct.
-

[▶ How to Use](#)

Troubleshooting

[Hardware](#)

[Software](#)

[Network / Internet](#)

[Backup / Recovery](#)

[Security](#)

[Peripheral Devices](#)

What should I do if the text size on the website is small or large?

- Change the text size on your web browser.
If you use Internet Explorer, select Page and Text Size, and then select your desired text size.
-

[▶ How to Use](#)

Troubleshooting

[Hardware](#)

[Software](#)

[Network / Internet](#)

[Backup / Recovery](#)

[Security](#)

[Peripheral Devices](#)

What should I do if I cannot use the Wi-Fi (wireless LAN) function?

- Enable the Wi-Fi (wireless LAN) function.
Open the Charms bar [\[Details\]](#) and select  (Settings).
Select Change PC settings at the lower right corner of the bar, and select Wireless in the left pane.
Turn off Airplane mode and change the Wi-Fi setting under Wireless devices to On.
 - To use the Wi-Fi (wireless LAN) function on your VAIO computer, you need to set up the function.
Check the Wi-Fi (wireless LAN) settings of the computer. [\[Details\]](#)
 - If a connection utility app supplied with a third-party Wi-Fi (wireless LAN) product is installed, uninstall it.
If a connection utility app is installed, Windows may fail to configure the Wi-Fi (wireless LAN) settings. Be sure to take a note of your settings, (such as security keys) before uninstalling.
-

[▶ How to Use](#)

Troubleshooting

[Hardware](#)

[Software](#)

[Network / Internet](#)

[Backup / Recovery](#)

[Security](#)

[Peripheral Devices](#)

What should I do if I do not know the SSID or security key for the access point?

- You can find the key in the setting screen of your access point.
Refer to the manual that came with your access point for more information.
-

[How to Use](#)**Troubleshooting**

[Hardware](#)

[Software](#)



[Network / Internet](#)

[Backup / Recovery](#)

[Security](#)

[Peripheral Devices](#)

What should I do if I cannot connect my VAIO computer to an access point (or the Internet)?

- See [What should I do if I cannot use the Wi-Fi \(wireless LAN\) function?](#).
[\[Details\]](#)
- Make sure the access point is on.
- Check the access point settings.
In the following settings, your VAIO computer may fail to connect to an access point, or the connection may be unstable.
 - When the access point is set to refuse communication with a device whose SSID is set to "ANY," and the SSID of your VAIO computer or the access point is set to "ANY."
 - When the access point is in stealth mode.
For more information, refer to the manual that came with your access point, or consult your Wi-Fi (wireless LAN) service provider.
- Make sure your VAIO computer and access point are connected to one another. [\[Details\]](#)
- Connection capability is affected by distance, obstructions, device configuration, radio wave strength/interference, wall materials, running apps, etc.
Move your VAIO computer away from obstructions or closer to any access point you may be using.
- Open the Charms bar [\[Details\]](#) and select  (Settings) and  (the Network icon).
Check that your access point is displayed.

[▶ How to Use](#)**Troubleshooting**

[Hardware](#)

[Software](#)

[Network / Internet](#)

[Backup / Recovery](#)

[Security](#)

[Peripheral Devices](#)

What should I do if I cannot play back movies or audio tracks received via Wi-Fi (wireless LAN), or their playback is interrupted? Why is the data transfer speed slow?

- Move your VAIO computer away from obstructions, or closer to any access point you may be using.
Connection capability is affected by distance, obstructions, device configuration, radio wave strength/interference, wall materials, running apps, etc.
- If you are using an access point, the device may be temporarily overloaded depending on how many other devices are communicating via the access point.
Wait for a while and try again.
- Change the channel setting of your access point. By changing the channel, interference on your wireless network may be reduced and data transfer speed may improve.
If access point channel interference occurs, data transfer speed may be reduced.
- If your access point interferes with other access points, change the access point channel.
Refer to the manual that came with your access point for more information.
- Make sure that a microwave oven is not operating near your Wi-Fi (wireless LAN) devices.
The 2.4 GHz frequency band, on which Wi-Fi (wireless LAN) operates, is used by various devices and apparatus. If you use a microwave oven while communicating via Wi-Fi (wireless LAN), data transfer rate may slow down, communication range may narrow, or communication may be interrupted.
- Make sure Maximum Performance is selected for Wireless Adapter Settings in the Power Options window. [\[Details\]](#)

[▶ How to Use](#)[Troubleshooting](#)[Hardware](#)[Software](#)[Network / Internet](#)[Backup / Recovery](#)[Security](#)[Peripheral Devices](#)

How can I find the physical address (MAC address) of the built-in wireless network interface of my VAIO computer?

- If MAC address filtering of your access point is enabled, register the MAC address of your VAIO computer in the setup screen of the access point. Otherwise, the computer cannot connect to the access point.
Open Command Prompt [\[Details\]](#), enter "ipconfig /all", and then press the Enter key. You can find the physical address (MAC address) in the Physical Address field under Wireless LAN adapter Wireless Network Connection.

[▶ How to Use](#)

Troubleshooting

[Hardware](#)

[Software](#)

[Network / Internet](#)

[Backup / Recovery](#)

[Security](#)

[Peripheral Devices](#)

What should I do if I cannot use the BLUETOOTH(R) function?

- Make sure the WIRELESS indicator light on your VAIO computer is on.
When the WIRELESS indicator light is off, you cannot use the BLUETOOTH function.
 - Make sure the BLUETOOTH function is enabled.
Open the Charms bar [\[Details\]](#) and select  (Settings).
Select Change PC settings at the lower right corner of the bar, and select Wireless in the left pane.
Turn off Airplane mode and change the Bluetooth setting under Wireless devices to On.
-

[▶ How to Use](#)

Troubleshooting

[Hardware](#)

[Software](#)



[Network / Internet](#)

[Backup / Recovery](#)

[Security](#)

[Peripheral Devices](#)

What should I do if other BLUETOOTH(R) devices cannot connect to my VAIO computer?

- See [What should I do if I cannot find the BLUETOOTH device I want to communicate with?](#). [\[Details\]](#)
- Make sure that the authentication (pairing) between the device and your VAIO computer has been properly performed.
Some BLUETOOTH devices require authentication (pairing) before establishing connection with another device. Perform the authentication process before connecting to such devices.
- Make sure that your VAIO computer allows BLUETOOTH devices to find the computer. Select  (arrow) in the desktop notification area [\[Details\]](#), right-click  (the BLUETOOTH icon), and select (wi1090) to open the settings window. Select the (wi1100) tab and make sure that the (wi1110) check box is selected.

[▶ How to Use](#)

Troubleshooting

[Hardware](#)

[Software](#)

[Network / Internet](#)

[Backup / Recovery](#)

[Security](#)

[Peripheral Devices](#)

What should I do if the BLUETOOTH(R) icon is not displayed in the desktop notification area?

- Make sure the BLUETOOTH function is enabled.
Open the Charms bar [\[Details\]](#) and select  (Settings).
Select Change PC settings at the lower right corner of the bar, and select Wireless in the left pane.
Turn off Airplane mode and change the Bluetooth setting under Wireless devices to On.
 - Check the BLUETOOTH settings.
Open Control Panel [\[Details\]](#) and select Hardware and Sound and (wi1120).
Right-click the computer icon and select (wi1130) and the (wi1140) check box.
-

[▶ How to Use](#)[Troubleshooting](#)[Hardware](#)[Software](#)[Network / Internet](#)[Backup / Recovery](#)[Security](#)[Peripheral Devices](#)

What should I do if I cannot find the BLUETOOTH(R) device I want to communicate with?

- Shorten the distance between your VAIO computer and the BLUETOOTH device within 33 feet/10 meters.
If the computer is more than 33 feet/10 meters away from the BLUETOOTH device, communication will not be possible.
The computer may not be able to communicate with the BLUETOOTH device even within 33 feet/10 meters due to obstacles between the devices, radio wave quality, ambient environment that includes existence of walls and materials of such walls, or apps in use. In such a case, move the computer away from obstructions or closer to the device.
- Check that the BLUETOOTH function of the device you want to communicate with is on, and the device is not in the power saving mode.
- Check that the BLUETOOTH function of the device you want to communicate with is enabled.
Refer to the manual that came with the device for more information.
- If the device you want to communicate with is already communicating with another BLUETOOTH device, it may not be found or it may not be able to communicate with your VAIO computer.

[▶ How to Use](#)

Troubleshooting

[Hardware](#)

[Software](#)

[Network / Internet](#)

[Backup / Recovery](#)

[Security](#)

[Peripheral Devices](#)

Why is my BLUETOOTH(R) connection slow?

- Data transfer speed depends on obstructions and/or the distance between the two devices, radio wave quality, and the device configuration or apps in use. Move your VAIO computer and BLUETOOTH device closer to each other.
 - If a version of a BLUETOOTH standard employed on the BLUETOOTH device with which you want to communicate is not the same version as the one employed on your VAIO computer, the communication speed may become slower.
 - If your VAIO computer is compliant with BLUETOOTH high speed technology and the following two conditions are met, high-speed communications are available. However, some BLUETOOTH profiles do not support high-speed communications.
 - The BLUETOOTH device with which you want to communicate supports BLUETOOTH high speed technology.
 - Both the wireless LAN and BLUETOOTH functions on the computer are enabled.
-

[▶ How to Use](#)**Troubleshooting**

[Hardware](#)

[Software](#)

[Network / Internet](#)

[Backup / Recovery](#)

[Security](#)

[Peripheral Devices](#)

Why can't I use the BLUETOOTH(R) function when I log onto my VAIO computer as a user with a standard user account?

- The BLUETOOTH function may not be available to a user with a standard user account on your VAIO computer.
Log onto the computer as a user with administrative rights.
-

[▶ How to Use](#)

Troubleshooting

[Hardware](#)

[Software](#)

[Network / Internet](#)

[Backup / Recovery](#)

[Security](#)

[Peripheral Devices](#)

Why can't I use BLUETOOTH(R) devices when I switch users?

- If you switch users without signing out from your system, BLUETOOTH devices will not work.
Be sure to sign out before switching users.
-

[▶ How to Use](#)

Troubleshooting

[Hardware](#)

[Software](#)

[Network / Internet](#)

[Backup / Recovery](#)

[Security](#)

[Peripheral Devices](#)

Why can't I exchange business card data with a smartphone or a mobile phone?

- Your VAIO computer does not support the data transfer function (vCard Exchange), which exchanges business card data between BLUETOOTH devices (a smartphone, a mobile phone, etc.).
-

[▶ How to Use](#)

Troubleshooting

[Hardware](#)

[Software](#)

[Network / Internet](#)

[Backup / Recovery](#)

[Security](#)

[Peripheral Devices](#)

Why doesn't the built-in digital compass show the correct direction?

- The built-in digital compass works by detecting a magnetic direction. Do not rely solely on the location information the built-in digital compass provides. Especially at the following locations, the accuracy of the digital compass can be easily affected by magnetic interference and it may not work correctly.
 - Inside an elevator or a room built with ferrous materials, such as iron frames or reinforced concrete
 - Near a reinforced concrete structure, such as a footbridge or an airport or a train station concourse
 - Near or inside a train or a car
 - Near a transformer on the ground or high-voltage power lines
 - Near a metallic product, such as a metal frame desk or metallic furniture
 - Near a material that has a high level of magnetic interference, such as a magnet, a magnetic holder, or speakers
- Calibrating the built-in digital compass may correct the direction. Click [Location Info/GPS](#) and [Adjust Digital Compass](#) on VAIO Control Center and follow the on-screen instructions to calibrate the built-in digital compass.

[▶ How to Use](#)

Troubleshooting

[Hardware](#)

[Software](#)

[Network / Internet](#)

[Backup / Recovery](#)

[Security](#)

[Peripheral Devices](#)

Why doesn't the computer screen rotate?

- The screen rotation is disabled when the slide-out keyboard is open.
 - The screen rotation is disabled while your VAIO computer is connected to an external display.
If you connect the computer to an external display while using the computer in portrait orientation, the computer screen automatically changes to landscape (horizontal) orientation.
-

[▶ How to Use](#)**Troubleshooting**

[Hardware](#)

[Software](#)

[Network / Internet](#)

[Backup / Recovery](#)

[Security](#)

[Peripheral Devices](#)

What should I do if I cannot charge the device connected to the USB port that supports USB charging?

- Make sure that USB Charging Settings is enabled. [\[Details\]](#)
-

[▶ How to Use](#)**Troubleshooting**

[Hardware](#)

[Software](#)

[Network / Internet](#)

[Backup / Recovery](#)

[Security](#)

[Peripheral Devices](#)

What should I do if I cannot print a document?

- Make sure the printer settings are correctly configured.
For information on the printer settings, refer to the manual that came with your printer.
- Make sure your printer is on.
Refer to the manual that came with your printer for more information.
- Make sure the connections between the printer's power cord and AC adapter and between the AC adapter and an AC outlet are securely made.
- Make sure the appropriate printer driver is installed.
When you connect a new printer, you first need to set up the printer driver. For information on how to set up the printer driver, refer to the manual that came with your printer, or visit the website of the manufacturer.
- Make sure the status of your printer is displayed as online or ready. Then, make sure the printer settings are correctly configured as instructed in the manual that came with the printer.
- Make sure your printer is set to Set as Default Printer. Refer to Windows Help and Support for more information.
- Make sure your printer is compatible with Windows installed on your VAIO computer.
- Make sure your printer is connected to your network (LAN).
If the printer is directly connected to the network (LAN), make sure a router or a hub is on.
If the printer is connected to a printer server, make sure an error message is not displayed on the printer server.
- Make sure your software is working properly.
The software may not support your document format. In such a case, your document will not be printed properly. Contact the software publisher or the manufacturer of your printer.
- Make sure the correct printer port for your printer is selected.
For more information on the printer port settings, refer to the manual that came with the printer, or contact the manufacturer.

[▶ How to Use](#)

Troubleshooting

[Hardware](#)

[Software](#)

[Network / Internet](#)

[Backup / Recovery](#)

[Security](#)

[Peripheral Devices](#)

What should I do if I cannot boot my VAIO computer from the floppy disk drive?

- Press the ASSIST button while your VAIO computer is off to display the VAIO Care Rescue Mode screen, and select Start from media (USB device/optical disc).
-

[▶ How to Use](#)**Troubleshooting**

[Hardware](#)

[Software](#)

[Network / Internet](#)

[Backup / Recovery](#)

[Security](#)

[Peripheral Devices](#)

What should I do if I cannot remove my floppy disk?

- Close open file(s), make sure the indicator light on the USB floppy disk drive is off, and then remove your floppy disk from the drive.
-

[▶ How to Use](#)

Troubleshooting

[Hardware](#)

[Software](#)

[Network / Internet](#)

[Backup / Recovery](#)

[Security](#)

[Peripheral Devices](#)

What should I do if my VAIO computer does not recognize the floppy disk?

- Make sure the floppy disk is properly inserted in the USB floppy disk drive connected to your VAIO computer.
Make sure the floppy disk is right-side up before inserting it into the drive.
 - Make sure the USB floppy disk drive is securely connected to your VAIO computer.
 - Remove the floppy disk from the USB floppy disk drive and then insert it again.
-

[▶ How to Use](#)

Troubleshooting

[Hardware](#)

[Software](#)

[Network / Internet](#)

[Backup / Recovery](#)

[Security](#)

[Peripheral Devices](#)

What should I do if I cannot save data on my floppy disk?

- Make sure your floppy disk is properly inserted in the USB floppy disk drive connected to your VAIO computer.
Make sure the floppy disk is right-side up before inserting it into the drive.
 - If a message indicating that your floppy disk is full appears, your floppy disk does not have enough free space.
Change the floppy disk to another with enough free space and then save data again.
 - If a message indicating that your floppy disk is write-protected appears, slide a write-protect tab on the floppy disk to disable the write-protect feature.
Sliding the write-protect tab to the open position enables the write-protect feature.
-

[▶ How to Use](#)

Troubleshooting

[Hardware](#)

[Software](#)

[Network / Internet](#)

[Backup / Recovery](#)

[Security](#)

[Peripheral Devices](#)

What should I do if my VAIO computer does not recognize the USB device?

- Check if the USB device is on and using its own power supply.
 - If you are using a digital camera, check if the battery is charged.
 - If you are using a printer, check if the power cable is connected properly to an AC outlet.
 - You may need to install a USB driver for the USB device before connecting the device. Refer to the manual that came with the USB device for more information.
 - Try using another USB port on your VAIO computer. The USB driver could be installed to the specific port you used the first time you connected the device.
 - USB hubs may prevent the USB device from working because of a power distribution failure. We recommend you connect the device directly to your VAIO computer without a hub.
-

[▶ How to Use](#)

Troubleshooting

[Hardware](#)

[Software](#)

[Network / Internet](#)

[Backup / Recovery](#)

[Security](#)

[Peripheral Devices](#)

Why doesn't the "Memory Stick" icon appear in the Computer window?

- The icon does not appear when no "Memory Stick" is inserted into the slot.
-

[▶ How to Use](#)**Troubleshooting**

[Hardware](#)

[Software](#)

[Network / Internet](#)

[Backup / Recovery](#)

[Security](#)

[Peripheral Devices](#)

Why can't I write data to a memory card?

- Some types of memory cards are equipped with an erasure prevention switch to protect data from unintentional erasure or overwriting. Make sure the erasure prevention switch is off.
-

[▶ How to Use](#)**Troubleshooting**

[Hardware](#)

[Software](#)

[Network / Internet](#)

[Backup / Recovery](#)

[Security](#)

[Peripheral Devices](#)

Why doesn't the memory card icon appear in the Computer window?

- The icon will not appear if no memory card is inserted in the slot.
-

[▶ How to Use](#)

Troubleshooting

[Hardware](#)

[Software](#)

[Network / Internet](#)

[Backup / Recovery](#)

[Security](#)

[Peripheral Devices](#)

What should I do if I forget the Windows password?

- The Windows password is case-sensitive. Check your password and enter again.
 - Log on using a user account that has system administrator privileges to reset your password.
 - If you forget all passwords for system administrator accounts, you cannot reset any Windows passwords. You need to perform system recovery. [\[Details\]](#)
-

[▶ How to Use](#)**Troubleshooting**

[Hardware](#)

[Software](#)

[Network / Internet](#)

[Backup / Recovery](#)

[Security](#)

[Peripheral Devices](#)

What should I do if the Enter Onetime Password message appears and Windows does not start after I enter a wrong power-on password three times consecutively?

- Press and hold down the  (Power) button for more than four seconds and check if the power indicator light is off. Then, restart your VAIO computer and enter the correct password.
The password is case-sensitive, so be sure to check letters for the current case before you enter the password.
 - If you forget the power-on password, you cannot start your VAIO computer. [\[Details\]](#)
-

[▶ How to Use](#)

Troubleshooting

[Hardware](#)

[Software](#)

[Network / Internet](#)

[Backup / Recovery](#)

[Security](#)

[Peripheral Devices](#)

What should I do if I forget the power-on password to start my VAIO computer?

- If you forget the password [\[Details\]](#), you cannot start your VAIO computer.
 - When you forget your user password:
Enter the machine password to reset the user password at the BIOS setup screen.
 - When you forget your machine password:
The password needs to be reset and a fee will be charged. To reset the password, contact an authorized Sony service/support center.
-

[▶ How to Use](#)**Troubleshooting**

[Hardware](#)

[Software](#)

[Network / Internet](#)

[Backup / Recovery](#)

[Security](#)

[Peripheral Devices](#)

What should I do if my VAIO computer becomes unstable (Windows starts)?

- Try the suggestions below:
 - Start VAIO Care to search for a solution. [\[Details\]](#)
 - Restore computer system files. [\[Details\]](#)
Use the restore point that you created before your VAIO computer becomes unstable.
 - Uninstall software or a software driver if your VAIO computer has become unstable after you installed the software or the software driver.
 - Reinstall the preinstalled software or software drivers on your VAIO computer if such software or software drivers have not been working properly. [\[Details\]](#)
 - Restore your VAIO computer from a system image backup if you have created the backup. Refer to Windows Help and Support for more information.
- If the problem persists, follow the instructions in Recovering from the Recovery Area to recover your VAIO computer. [\[Details\]](#)
 - If you have not yet created Recovery Media, create the Recovery Media. [\[Details\]](#)
 - Be sure to make a backup copy of your valuable data before recovering your VAIO computer. Refer to Windows Help and Support for more information.

Note

- Recovering your VAIO computer will delete all the data on the built-in storage device.
-

[▶ How to Use](#)**Troubleshooting**

[Hardware](#)

[Software](#)

[Network / Internet](#)

[Backup / Recovery](#)

[Security](#)

[Peripheral Devices](#)

What should I do if my VAIO computer becomes unstable (Windows does not start)?

- Try the suggestions below:
 - Restore computer system files. [\[Details\]](#)
Use the restore point that you created before your VAIO computer becomes unstable.
 - Restore your VAIO computer from a system image backup if you have created the backup. Refer to Windows Help and Support for more information.
Any file you have created or changed after you created the system image backup will not be restored. You need to back up such a file with VAIO Care Rescue. [\[Details\]](#)
- Use VAIO Hardware Diagnostics to identify problems on your VAIO computer.
 - With the software, you can check if the computer hardware (a CPU, a memory module, and a built-in storage device) needs to be replaced. To start VAIO Hardware Diagnostics, click Tools and VAIO Hardware Diagnostics in VAIO Care Rescue.
- Follow the instructions in Recovering from the Recovery Area to recover your VAIO computer. [\[Details\]](#)
 - If you have not backed up your data, be sure to make a backup copy of your valuable data using VAIO Care Rescue before recovering your VAIO computer. [\[Details\]](#)
If you have a backup created with the Windows backup feature before your VAIO computer becomes unstable, but you have created or changed the file after that, back up such a file with VAIO Care Rescue.

Note

- Recovering your VAIO computer will delete all the data on the built-in storage device.

[▶ How to Use](#)

Troubleshooting

[Hardware](#)

[Software](#)

[Network / Internet](#)

[Backup / Recovery](#)

[Security](#)

[Peripheral Devices](#)

What should I do if I cannot complete the recovery process?

- Disconnect all unnecessary external devices from your VAIO computer.
 - Try the suggestions below:
 - Check the condition of Recovery Media. If you are using optical discs, check the discs for dirt or damage. If the discs are not clean, clean them and try recovering your VAIO computer again.
 - If you cannot recover your VAIO computer from the recovery area, restart the computer and recover the computer from the recovery area again, or use Recovery Media.
 - If you cannot recover your VAIO computer using a USB optical drive or USB flash drive, connect the drive to another USB port on the computer, then turn off the computer and try recovering it again.
 - If the problem persists, visit the VAIO online support website for further assistance.
-

[▶ How to Use](#)

Troubleshooting

[Hardware](#)

[Software](#)

[Network / Internet](#)

[Backup / Recovery](#)

[Security](#)

[Peripheral Devices](#)

What should I do if I cannot create Recovery Media?

- Try the suggestions below:
 - Download and install the latest updates using VAIO Update.
 - Restart your VAIO computer. And then, try to create Recovery Media again.
 - If an AC adapter is supplied with an external optical disc drive, plug the AC adapter into a power source.
 - Try other reliable media.
 - If the problem persists, visit the VAIO online support website for further assistance.
-

[▶ How to Use](#)**Troubleshooting**

[Hardware](#)

[Software](#)

[Network / Internet](#)

[Backup / Recovery](#)

[Security](#)

[Peripheral Devices](#)

How do I create Recovery Media?

- You can create Recovery Media using VAIO Care. [\[Details\]](#)
-

[▶ How to Use](#)

Troubleshooting

[Hardware](#)

[Software](#)

[Network / Internet](#)

[Backup / Recovery](#)

[Security](#)

[Peripheral Devices](#)

What should I do if I cannot recover my VAIO computer from the recovery area?

- Recover your VAIO computer from Recovery Media if you have used software to modify the recovery area, installed a different operating system from the preinstalled one, or formatted the built-in storage device without using VAIO Care Rescue.
 - If the problem persists, visit the VAIO online support website for further assistance.
-

[▶ How to Use](#)**Troubleshooting**

[Hardware](#)

[Software](#)

[Network / Internet](#)

[Backup / Recovery](#)

[Security](#)

[Peripheral Devices](#)

How can I restore my VAIO computer system to its factory default settings?

- There are two ways to recover your VAIO computer system: from Recovery Media [\[Details\]](#) and from the recovery area [\[Details\]](#).
-

[▶ How to Use](#)

Troubleshooting

[Hardware](#)

[Software](#)

[Network / Internet](#)

[Backup / Recovery](#)

[Security](#)

[Peripheral Devices](#)

How can I reinstall the original software and drivers?

- You can restore the preinstalled software and drivers using VAIO Care. To restore them, start VAIO Care [\[Details\]](#) and then click Advanced Tools, Restore and recovery, and Reinstall applications and drivers. Refer to the help file included with VAIO Care for more information.
-

[▶ How to Use](#)

Troubleshooting

[Hardware](#)

[Software](#)



[Network / Internet](#)

[Backup / Recovery](#)

[Security](#)

[Peripheral Devices](#)

What should I do if VAIO Care Rescue Mode starts when I turn on my VAIO computer?

- You may have pressed not the  (Power) button but the ASSIST button. Exit VAIO Care Rescue Mode and check where the  (Power) button is located on your VAIO computer.
-

[▶ How to Use](#)**Troubleshooting**

[Hardware](#)

[Software](#)

[Network / Internet](#)

[Backup / Recovery](#)

[Security](#)

[Peripheral Devices](#)

Why does the System Properties window display a slower CPU speed than the maximum?

- This is normal. Because your VAIO computer's CPU utilizes a type of CPU speed controlling technology for power conservation purposes, the System Properties window may display the current CPU speed instead of the maximum speed.
-

[▶ How to Use](#)

Troubleshooting

[Hardware](#)

[Software](#)

[Network / Internet](#)

[Backup / Recovery](#)

[Security](#)

[Peripheral Devices](#)

What should I do if my game software does not work or it keeps crashing?

- Check the website of the game if there are any patches or updates to download.
 - Make sure you have installed the latest video driver software.
 - On some VAIO computer models, the graphics memory is shared with the system. The optimal graphics performance in such a case is not guaranteed.
-

[▶ Troubleshooting](#)

How to Use

Parts Description

Setup

Network / Internet

Connections

Settings

Playback

Backup / Recovery

Security

Other Operations

Notifications

Parts Description

[Keyboard](#)

[Mouse](#)

[VAIO computer](#)

[▶ Troubleshooting](#)

How to Use

[Parts Description](#)[Setup](#)[Network / Internet](#)[Connections](#)[Settings](#)[Playback](#)[Backup / Recovery](#)[Security](#)[Other Operations](#)[Notifications](#)

Keyboard

[Parts and Controls of the Keyboard](#)

Describes the features of the keyboard, such as keys, buttons and indicator lights.

You might be looking for the following topics:

[About the Usage Environment for the Keyboard](#)[Checking the Caps Lock / Num Lock / Scroll Lock States](#)[Checking the Remaining Battery Power of the Keyboard](#)[Combinations and Functions with the Fn Key](#)[Connecting the Wireless Keyboard](#)[Replacing the AA Battery of the Keyboard](#)

[▶ Troubleshooting](#)

How to Use

Parts Description

Setup

Network / Internet

Connections

Settings

Playback

Backup / Recovery

Security

Other Operations

Notifications

Mouse

[Parts and Controls of the Mouse](#)

Describes the features of the mouse, such as buttons.

You might be looking for the following topics:

[About the Usage Environment for the Mouse](#)

[Connecting the Wireless Mouse](#)

[Replacing the AA Battery of the Mouse](#)

[▶ Troubleshooting](#)**How to Use****Parts Description**

[Setup](#)

[Network / Internet](#)

[Connections](#)

[Settings](#)

[Playback](#)

[Backup / Recovery](#)

[Security](#)

[Other Operations](#)

[Notifications](#)

VAIO computer[Parts and Controls on the Back](#)

Describes the features on the back of the VAIO computer, such as connection ports.

[Parts and Controls on the Front](#)

Describes the features on the front of the VAIO computer, such as buttons and indicator lights.

[Parts and Controls on the Sides](#)

Describes the features on the sides of the VAIO computer, such as connection ports.

You might be looking for the following topics:

[About the ASSIST Button](#)[Adding and Removing Memory Modules](#)[Booting Your VAIO Computer from External Devices](#)[Checking Supplied Items](#)[Customizing Your VAIO Computer](#)[Keeping Your VAIO Computer in Optimum Condition \(VAIO Care\)](#)[Notes on Adding and Removing Memory Modules](#)[Setting Up an Appropriate Work Environment](#)[Setting the Stand](#)[Updating Your VAIO Computer](#)[Using VAIO Update](#)[Viewing the System Information](#)

[▶ Troubleshooting](#)

How to Use

Parts Description

Setup

Network / Internet

Connections

Settings

Playback

Backup / Recovery

Security

Other Operations

Notifications

Setup

[Battery](#)

[Keyboard](#)

[Mouse](#)

[Supplied items](#)

[Display](#)

[Memory module](#)

[Power](#)

[VAIO computer](#)

[▶ Troubleshooting](#)

How to Use

[Parts Description](#)[Setup](#)[Network / Internet](#)

[Connections](#)

[Settings](#)

[Playback](#)

[Backup / Recovery](#)

[Security](#)

[Other Operations](#)

[Notifications](#)

Battery

[Charging the Battery Pack](#)

The battery pack can be charged even while you are using your VAIO computer when the computer is connected to a power source.

[Installing/Removing the Battery Pack](#)

Install the battery pack into the battery compartment on the bottom of your VAIO computer.

You might be looking for the following topics:

[Changing the Rapid Wake \(Sleep Mode\) Settings](#)[Charge Indicator Status List](#)[Checking the Battery Charge Capacity](#)[Extending the Battery Life](#)[Notes on Using the Battery Pack](#)

[▶ Troubleshooting](#)

How to Use

[Parts Description](#)[Setup](#)[Network / Internet](#)

[Connections](#)

[Settings](#)

[Playback](#)

[Backup / Recovery](#)

[Security](#)

[Other Operations](#)

[Notifications](#)

Display

[Adjusting the Angle of the Screen](#)

You can adjust the screen angle of your choice.

You might be looking for the following topics:

[About the Touch Screen<Touch screen equipped models>](#)

[Changing the LCD Brightness](#)

[Changing the Resolution \(Size\) of the Screen Image](#)

[Changing the Resolution \(Size\) of the Screen Image on an HDMI-Connected Device](#)

[Enable/Disable the Touch Screen<Touch screen equipped models>](#)

[Enlarging the Text Size \(DPI\)<Touch screen equipped models>](#)

[How to Use the Touch Screen<Touch screen equipped models>](#)

[Notes on Using the Touch Screen<Touch screen equipped models>](#)

[Notes on the LCD screen](#)

[▶ Troubleshooting](#)

How to Use

[Parts Description](#)[Setup](#)[Network / Internet](#)

[Connections](#)

[Settings](#)

[Playback](#)

[Backup / Recovery](#)

[Security](#)

[Other Operations](#)

[Notifications](#)

Keyboard

[About the Usage Environment for the Keyboard](#)

This section explains how to use the wireless keyboard.

[Replacing the AA Battery of the Keyboard](#)

Change the AA battery in the keyboard when the battery power becomes low.

You might be looking for the following topics:

[Checking the Caps Lock / Num Lock / Scroll Lock States](#)

[Checking the Remaining Battery Power of the Keyboard](#)

[Combinations and Functions with the Fn Key](#)

[Connecting the Wireless Keyboard](#)

[Parts and Controls of the Keyboard](#)

[▶ Troubleshooting](#)

How to Use

[Parts Description](#)[Setup](#)[Network / Internet](#)

[Connections](#)

[Settings](#)

[Playback](#)

[Backup / Recovery](#)

[Security](#)

[Other Operations](#)

[Notifications](#)

Memory module

[Adding and Removing Memory Modules](#)

If you want to increase your computer's speed or improve performance when running programs simultaneously, increase the amount of memory by installing optional memory modules.

[Notes on Adding and Removing Memory Modules](#)

Before adding or removing memory modules, read the following precautions thoroughly.

You might be looking for the following topics:

[Viewing the System Information](#)

[▶ Troubleshooting](#)

How to Use

[Parts Description](#)[Setup](#)[Network / Internet](#)

[Connections](#)

[Settings](#)

[Playback](#)

[Backup / Recovery](#)

[Security](#)

[Other Operations](#)

[Notifications](#)

Mouse

[About the Usage Environment for the Mouse](#)

This section explains how to use the wireless mouse.

[Replacing the AA Battery of the Mouse](#)

Change the AA battery in the mouse when the battery power becomes low.

You might be looking for the following topics:

[Connecting the Wireless Mouse](#)

[Parts and Controls of the Mouse](#)

[▶ Troubleshooting](#)

How to Use

[Parts Description](#)[Setup](#)[Network / Internet](#)

[Connections](#)

[Settings](#)

[Playback](#)

[Backup / Recovery](#)

[Security](#)

[Other Operations](#)

[Notifications](#)

Power

[Charging the Battery Pack](#)

The battery pack can be charged even while you are using your VAIO computer when the computer is connected to a power source.

[Connecting a Power Source](#)

Connect your VAIO computer to an AC power source. Carefully read the precautions in [Notes on Using the Power Source](#) before connection. [[Details](#)]

[Installing/Removing the Battery Pack](#)

Install the battery pack into the battery compartment on the bottom of your VAIO computer.

[Shutting Down Your VAIO Computer](#)

Shut down your VAIO computer properly to avoid losing unsaved data.

[Turning on Your VAIO Computer](#)

Turn on your VAIO computer to start Windows. Carefully read the precautions in [Notes on Using the Power Source](#) before turning on. [[Details](#)]

You might be looking for the following topics:

[Changing the Rapid Wake \(Sleep Mode\) Settings](#)[Charge Indicator Status List](#)[Notes on Sleep Mode](#)[Notes on Using the Power Source](#)[Restarting Your VAIO Computer](#)[Selecting a Power Plan](#)[Using Sleep Mode](#)

[▶ Troubleshooting](#)

How to Use

[Parts Description](#)[Setup](#)[Network / Internet](#)

[Connections](#)

[Settings](#)

[Playback](#)

[Backup / Recovery](#)

[Security](#)

[Other Operations](#)

[Notifications](#)

Supplied items

[Checking Supplied Items](#)

Check all items packed with the product before use.

[▶ Troubleshooting](#)

How to Use

[Parts Description](#)[Setup](#)[Network / Internet](#)

[Connections](#)

[Settings](#)

[Playback](#)

[Backup / Recovery](#)

[Security](#)

[Other Operations](#)

[Notifications](#)

VAIO computer

[Adding and Removing Memory Modules](#)

If you want to increase your computer's speed or improve performance when running programs simultaneously, increase the amount of memory by installing optional memory modules.

[Checking Supplied Items](#)

Check all items packed with the product before use.

[Notes on Adding and Removing Memory Modules](#)

Before adding or removing memory modules, read the following precautions thoroughly.

[Setting Up an Appropriate Work Environment](#)

This topic describes where to or not to place your VAIO computer and ergonomic instructions.

[Setting the Stand](#)

This section describes how to set the stand.

You might be looking for the following topics:

[About the ASSIST Button](#)[Booting Your VAIO Computer from External Devices](#)[Customizing Your VAIO Computer](#)[Keeping Your VAIO Computer in Optimum Condition \(VAIO Care\)](#)[Parts and Controls on the Back](#)[Parts and Controls on the Front](#)[Parts and Controls on the Sides](#)[Updating Your VAIO Computer](#)[Using VAIO Update](#)[Viewing the System Information](#)

[▶ Troubleshooting](#)

How to Use

Parts Description

Setup

Network / Internet

Connections

Settings

Playback

Backup / Recovery

Security

Other Operations

Notifications

Network / Internet

[Internet](#)

[LAN](#)

[Wireless LAN](#)

[▶ Troubleshooting](#)

How to Use

[Parts Description](#)

[Setup](#)

[Network / Internet](#)

[Connections](#)

[Settings](#)

[Playback](#)

[Backup / Recovery](#)

[Security](#)

[Other Operations](#)

[Notifications](#)

Internet

[About a Security Key for Wi-Fi \(Wireless LAN\)](#)

A security key is a security protocol for a wireless LAN that encrypts data transmitted on the wireless LAN.

[About the Internet Connection Services](#)

The following types of Internet connection services are available.

[About the Network \(LAN\)](#)

The network (LAN) enables you to connect your VAIO computer to the Internet and transfer data between the computer and other devices.

[About the Wi-Fi \(Wireless LAN\) Standards](#)

The Wireless Local Area Network (WLAN) allows your VAIO computer to connect to a network through a wireless connection.

[Connecting to the Internet with a Wired Connection](#)

Before using the Internet, you need to sign up with an Internet Service Provider (ISP) and set up devices required for connecting your VAIO computer to the Internet.

[Disabling the Wi-Fi \(Wireless LAN\) Function](#)

You can disable the Wi-Fi (Wireless LAN) function by following these steps.

[Launching the Web Browser \(WEB Button\)<WEB Button equipped models>](#)

By pressing the WEB button, you can launch the default web browser.

[Notes on Using the Wi-Fi \(Wireless LAN\) Function](#)

Before using the Wi-Fi (wireless LAN) function, read the following precautions for correct use.

[Starting Wi-Fi \(Wireless LAN\) Communications](#)

You can establish Wi-Fi (wireless LAN) communications between your VAIO computer and an access point (not supplied).

[Stopping Wi-Fi \(Wireless LAN\) Communications](#)

You can stop Wi-Fi (wireless LAN) communications by following these steps.

[Using the Antivirus App for Your VAIO Computer](#)

Protect your VAIO computer against computer viruses by using the antivirus app.

[▶ Troubleshooting](#)

How to Use

[Parts Description](#)

[Setup](#)

[Network / Internet](#)

[Connections](#)

[Settings](#)

[Playback](#)

[Backup / Recovery](#)

[Security](#)

[Other Operations](#)

[Notifications](#)

LAN

[About the Internet Connection Services](#)

The following types of Internet connection services are available.

[About the Network \(LAN\)](#)

The network (LAN) enables you to connect your VAIO computer to the Internet and transfer data between the computer and other devices.

[About the Wi-Fi \(Wireless LAN\) Standards](#)

The Wireless Local Area Network (WLAN) allows your VAIO computer to connect to a network through a wireless connection.

[Connecting to the Internet with a Wired Connection](#)

Before using the Internet, you need to sign up with an Internet Service Provider (ISP) and set up devices required for connecting your VAIO computer to the Internet.

[▶ Troubleshooting](#)

How to Use

[Parts Description](#)

[Setup](#)

[Network / Internet](#)

[Connections](#)

[Settings](#)

[Playback](#)

[Backup / Recovery](#)

[Security](#)

[Other Operations](#)

[Notifications](#)

Wireless LAN

[About a Security Key for Wi-Fi \(Wireless LAN\)](#)

A security key is a security protocol for a wireless LAN that encrypts data transmitted on the wireless LAN.

[About the Internet Connection Services](#)

The following types of Internet connection services are available.

[About the Wi-Fi \(Wireless LAN\) Standards](#)

The Wireless Local Area Network (WLAN) allows your VAIO computer to connect to a network through a wireless connection.

[Disabling the Wi-Fi \(Wireless LAN\) Function](#)

You can disable the Wi-Fi (Wireless LAN) function by following these steps.

[Notes on Using the Wi-Fi \(Wireless LAN\) Function](#)

Before using the Wi-Fi (wireless LAN) function, read the following precautions for correct use.

[Starting Wi-Fi \(Wireless LAN\) Communications](#)

You can establish Wi-Fi (wireless LAN) communications between your VAIO computer and an access point (not supplied).

[Stopping Wi-Fi \(Wireless LAN\) Communications](#)

You can stop Wi-Fi (wireless LAN) communications by following these steps.

[▶ Troubleshooting](#)

How to Use

Parts Description

Setup

Network / Internet

Connections

Settings

Playback

Backup / Recovery

Security

Other Operations

Notifications

Connections

[Audio](#)

[Battery](#)

[Display](#)

[Headphones](#)

[Keyboard](#)

[Microphone](#)

[Peripheral device](#)

[Speakers](#)

[Wireless LAN](#)

[BLUETOOTH](#)

[CD/DVD/BD](#)

[HDMI](#)

[Internet](#)

[LAN](#)

[Mouse](#)

[Power](#)

[USB](#)

[▶ Troubleshooting](#)

How to Use

[Parts Description](#)

[Setup](#)

[Network / Internet](#)

[Connections](#)

[Settings](#)

[Playback](#)

[Backup / Recovery](#)

[Security](#)

[Other Operations](#)

[Notifications](#)

Audio

[Changing the Sound Output Device](#)

If there is no sound from the device connected to your VAIO computer, you need to change the device for sound output.

[Connecting External Speakers or Headphones](#)

You can connect external sound output devices (such as speakers or headphones) to your VAIO computer.

[Connecting an External Microphone](#)

You can connect an external microphone to your VAIO computer and enjoy voice chat, etc.

You might be looking for the following topics:

[Adjusting the Microphone Volume](#)[Adjusting the Speakers Volume](#)[Adjusting the Volume in Windows](#)[Playing Surround Sound Using S-FORCE Front Surround 3D](#)

[▶ Troubleshooting](#)

How to Use

[Parts Description](#)

[Setup](#)

[Network / Internet](#)

[Connections](#)

[Settings](#)

[Playback](#)

[Backup / Recovery](#)

[Security](#)

[Other Operations](#)

[Notifications](#)

BLUETOOTH

[About BLUETOOTH\(R\) Security](#)

The BLUETOOTH wireless technology has an authentication function, which allows you to control communication with other devices.

[About the BLUETOOTH\(R\) Function](#)

You can establish wireless communications between your VAIO computer and other BLUETOOTH devices, such as another computer, a smartphone, a mobile phone, a headset, or a mouse.

[Communicating with Another BLUETOOTH\(R\) Device such as a Mouse](#)

You can connect BLUETOOTH devices to your VAIO computer.

[Notes on Using the BLUETOOTH\(R\) Function](#)

Before using the BLUETOOTH function, read the following precautions for correct use.

[Stopping BLUETOOTH\(R\) Communications](#)

You can stop BLUETOOTH communications by following these steps.

[▶ Troubleshooting](#)

How to Use

[Parts Description](#)

[Setup](#)

[Network / Internet](#)

[Connections](#)

[Settings](#)

[Playback](#)

[Backup / Recovery](#)

[Security](#)

[Other Operations](#)

[Notifications](#)

Battery

[Installing/Removing the Battery Pack](#)

Install the battery pack into the battery compartment on the bottom of your VAIO computer.

You might be looking for the following topics:

[Changing the Rapid Wake \(Sleep Mode\) Settings](#)[Charge Indicator Status List](#)[Charging the Battery Pack](#)[Checking the Battery Charge Capacity](#)[Extending the Battery Life](#)[Notes on Using the Battery Pack](#)

[▶ Troubleshooting](#)

How to Use

[Parts Description](#)

[Setup](#)

[Network / Internet](#)

[Connections](#)

[Settings](#)

[Playback](#)

[Backup / Recovery](#)

[Security](#)

[Other Operations](#)

[Notifications](#)

CD/DVD/BD

[Connecting an External Drive](#)

Connect an external disc drive or hard disk drive to a USB port on your VAIO computer.

You might be looking for the following topics:

[About Region Codes<Optical disc drive equipped models>](#)

[Booting Your VAIO Computer from External Devices](#)

[Handling Discs<Optical disc drive equipped models>](#)

[Inserting/Removing a Disc<Optical disc drive equipped models>](#)

[Notes on Using Discs<Optical disc drive equipped models>](#)

[Supported Discs<Optical disc drive equipped models>](#)

[▶ Troubleshooting](#)

How to Use

[Parts Description](#)

[Setup](#)

[Network / Internet](#)

[Connections](#)

[Settings](#)

[Playback](#)

[Backup / Recovery](#)

[Security](#)

[Other Operations](#)

[Notifications](#)

Display

[Changing the Resolution \(Size\) of the Screen Image on an HDMI-Connected Device](#)

You can change the screen resolution or size of your VAIO computer's screen image displayed on an external display, such as a TV, connected to the computer with an HDMI cable (not supplied).

[Notes on the LCD screen](#)

Read the following precautions for correct use of the LCD screen.

You might be looking for the following topics:

[About the Touch Screen<Touch screen equipped models>](#)

[Adjusting the Angle of the Screen](#)

[Changing the LCD Brightness](#)

[Changing the Resolution \(Size\) of the Screen Image](#)

[Enable/Disable the Touch Screen<Touch screen equipped models>](#)

[Enlarging the Text Size \(DPI\)<Touch screen equipped models>](#)

[How to Use the Touch Screen<Touch screen equipped models>](#)

[Notes on Using the Touch Screen<Touch screen equipped models>](#)

[▶ Troubleshooting](#)

How to Use

[Parts Description](#)

[Setup](#)

[Network / Internet](#)

[Connections](#)

[Settings](#)

[Playback](#)

[Backup / Recovery](#)

[Security](#)

[Other Operations](#)

[Notifications](#)

HDMI

[Changing the Resolution \(Size\) of the Screen Image on an HDMI-Connected Device](#)

You can change the screen resolution or size of your VAIO computer's screen image displayed on an external display, such as a TV, connected to the computer with an HDMI cable (not supplied).

[▶ Troubleshooting](#)

How to Use

[Parts Description](#)

[Setup](#)

[Network / Internet](#)

[Connections](#)

[Settings](#)

[Playback](#)

[Backup / Recovery](#)

[Security](#)

[Other Operations](#)

[Notifications](#)

Headphones

[Connecting External Speakers or Headphones](#)

You can connect external sound output devices (such as speakers or headphones) to your VAIO computer.

[▶ Troubleshooting](#)

How to Use

[Parts Description](#)

[Setup](#)

[Network / Internet](#)

[Connections](#)

[Settings](#)

[Playback](#)

[Backup / Recovery](#)

[Security](#)

[Other Operations](#)

[Notifications](#)

Internet

[About a Security Key for Wi-Fi \(Wireless LAN\)](#)

A security key is a security protocol for a wireless LAN that encrypts data transmitted on the wireless LAN.

[About the Internet Connection Services](#)

The following types of Internet connection services are available.

[About the Network \(LAN\)](#)

The network (LAN) enables you to connect your VAIO computer to the Internet and transfer data between the computer and other devices.

[About the Wi-Fi \(Wireless LAN\) Standards](#)

The Wireless Local Area Network (WLAN) allows your VAIO computer to connect to a network through a wireless connection.

[Connecting to the Internet with a Wired Connection](#)

Before using the Internet, you need to sign up with an Internet Service Provider (ISP) and set up devices required for connecting your VAIO computer to the Internet.

[Disabling the Wi-Fi \(Wireless LAN\) Function](#)

You can disable the Wi-Fi (Wireless LAN) function by following these steps.

[Launching the Web Browser \(WEB Button\)<WEB Button equipped models>](#)

By pressing the WEB button, you can launch the default web browser.

[Notes on Using the Wi-Fi \(Wireless LAN\) Function](#)

Before using the Wi-Fi (wireless LAN) function, read the following precautions for correct use.

[Starting Wi-Fi \(Wireless LAN\) Communications](#)

You can establish Wi-Fi (wireless LAN) communications between your VAIO computer and an access point (not supplied).

[Stopping Wi-Fi \(Wireless LAN\) Communications](#)

You can stop Wi-Fi (wireless LAN) communications by following these steps.

[Using the Antivirus App for Your VAIO Computer](#)

Protect your VAIO computer against computer viruses by using the antivirus app.

[▶ Troubleshooting](#)

How to Use

[Parts Description](#)

[Setup](#)

[Network / Internet](#)

[Connections](#)

[Settings](#)

[Playback](#)

[Backup / Recovery](#)

[Security](#)

[Other Operations](#)

[Notifications](#)

Keyboard

[About the Usage Environment for the Keyboard](#)

This section explains how to use the wireless keyboard.

[Connecting the Wireless Keyboard](#)

If you cannot use the wireless keyboard supplied with the computer, it is likely that wireless connection setup is required between the wireless keyboard and your VAIO computer.

You might be looking for the following topics:

[Checking the Caps Lock / Num Lock / Scroll Lock States](#)

[Checking the Remaining Battery Power of the Keyboard](#)

[Combinations and Functions with the Fn Key](#)

[Parts and Controls of the Keyboard](#)

[Replacing the AA Battery of the Keyboard](#)

[▶ Troubleshooting](#)

How to Use

[Parts Description](#)

[Setup](#)

[Network / Internet](#)

[Connections](#)

[Settings](#)

[Playback](#)

[Backup / Recovery](#)

[Security](#)

[Other Operations](#)

[Notifications](#)

LAN

[About the Internet Connection Services](#)

The following types of Internet connection services are available.

[About the Network \(LAN\)](#)

The network (LAN) enables you to connect your VAIO computer to the Internet and transfer data between the computer and other devices.

[About the Wi-Fi \(Wireless LAN\) Standards](#)

The Wireless Local Area Network (WLAN) allows your VAIO computer to connect to a network through a wireless connection.

[Connecting to the Internet with a Wired Connection](#)

Before using the Internet, you need to sign up with an Internet Service Provider (ISP) and set up devices required for connecting your VAIO computer to the Internet.

[▶ Troubleshooting](#)

How to Use

[Parts Description](#)

[Setup](#)

[Network / Internet](#)

[Connections](#)

[Settings](#)

[Playback](#)

[Backup / Recovery](#)

[Security](#)

[Other Operations](#)

[Notifications](#)

Microphone

[Connecting an External Microphone](#)

You can connect an external microphone to your VAIO computer and enjoy voice chat, etc.

You might be looking for the following topics:

[Adjusting the Microphone Volume](#)

[▶ Troubleshooting](#)

How to Use

[Parts Description](#)

[Setup](#)

[Network / Internet](#)

[Connections](#)

[Settings](#)

[Playback](#)

[Backup / Recovery](#)

[Security](#)

[Other Operations](#)

[Notifications](#)

Mouse

[About the Usage Environment for the Mouse](#)

This section explains how to use the wireless mouse.

[Connecting the Wireless Mouse](#)

If you cannot use the wireless mouse supplied with your VAIO computer, it is likely that wireless connection setup is required between the wireless mouse and the computer.

You might be looking for the following topics:

[Parts and Controls of the Mouse](#)[Replacing the AA Battery of the Mouse](#)

[▶ Troubleshooting](#)

How to Use

[Parts Description](#)

[Setup](#)

[Network / Internet](#)

[Connections](#)

[Settings](#)

[Playback](#)

[Backup / Recovery](#)

[Security](#)

[Other Operations](#)

[Notifications](#)

Peripheral device

[Changing the Sound Output Device](#)

If there is no sound from the device connected to your VAIO computer, you need to change the device for sound output.

[Connecting an External Microphone](#)

You can connect an external microphone to your VAIO computer and enjoy voice chat, etc.

[Notes on the LCD screen](#)

Read the following precautions for correct use of the LCD screen.

[▶ Troubleshooting](#)

How to Use

[Parts Description](#)

[Setup](#)

[Network / Internet](#)

[Connections](#)

[Settings](#)

[Playback](#)

[Backup / Recovery](#)

[Security](#)

[Other Operations](#)

[Notifications](#)

Power

[Connecting a Power Source](#)

Connect your VAIO computer to an AC power source. Carefully read the precautions in [Notes on Using the Power Source](#) before connection. [[Details](#)]

[Installing/Removing the Battery Pack](#)

Install the battery pack into the battery compartment on the bottom of your VAIO computer.

You might be looking for the following topics:

[Changing the Rapid Wake \(Sleep Mode\) Settings](#)[Charge Indicator Status List](#)[Charging the Battery Pack](#)[Notes on Sleep Mode](#)[Notes on Using the Power Source](#)[Restarting Your VAIO Computer](#)[Selecting a Power Plan](#)[Shutting Down Your VAIO Computer](#)[Turning on Your VAIO Computer](#)[Using Sleep Mode](#)

[▶ Troubleshooting](#)

How to Use

[Parts Description](#)

[Setup](#)

[Network / Internet](#)

[Connections](#)

[Settings](#)

[Playback](#)

[Backup / Recovery](#)

[Security](#)

[Other Operations](#)

[Notifications](#)

Speakers

[Connecting External Speakers or Headphones](#)

You can connect external sound output devices (such as speakers or headphones) to your VAIO computer.

You might be looking for the following topics:

[Adjusting the Speakers Volume](#)

[▶ Troubleshooting](#)

How to Use

[Parts Description](#)

[Setup](#)

[Network / Internet](#)

[Connections](#)

[Settings](#)

[Playback](#)

[Backup / Recovery](#)

[Security](#)

[Other Operations](#)

[Notifications](#)

USB

Charging a USB Device

You can charge a USB device even while your VAIO computer is off, in Hibernate mode, or Sleep mode by enabling the USB charging settings.

Connecting a USB Device

You can connect a Universal Serial Bus (USB) device such as a mouse, floppy disk drive, speaker or printer to your VAIO computer.

[▶ Troubleshooting](#)

How to Use

[Parts Description](#)

[Setup](#)

[Network / Internet](#)

[Connections](#)

[Settings](#)

[Playback](#)

[Backup / Recovery](#)

[Security](#)

[Other Operations](#)

[Notifications](#)

Wireless LAN

[About a Security Key for Wi-Fi \(Wireless LAN\)](#)

A security key is a security protocol for a wireless LAN that encrypts data transmitted on the wireless LAN.

[About the Internet Connection Services](#)

The following types of Internet connection services are available.

[About the Wi-Fi \(Wireless LAN\) Standards](#)

The Wireless Local Area Network (WLAN) allows your VAIO computer to connect to a network through a wireless connection.

[Disabling the Wi-Fi \(Wireless LAN\) Function](#)

You can disable the Wi-Fi (Wireless LAN) function by following these steps.

[Notes on Using the Wi-Fi \(Wireless LAN\) Function](#)

Before using the Wi-Fi (wireless LAN) function, read the following precautions for correct use.

[Starting Wi-Fi \(Wireless LAN\) Communications](#)

You can establish Wi-Fi (wireless LAN) communications between your VAIO computer and an access point (not supplied).

[Stopping Wi-Fi \(Wireless LAN\) Communications](#)

You can stop Wi-Fi (wireless LAN) communications by following these steps.

[▶ Troubleshooting](#)

How to Use

Parts Description

Setup

Network / Internet

Connections

Settings

Playback

Backup / Recovery

Security

Other Operations

Notifications

Settings

[Audio](#)

[Battery](#)

[CD/DVD/BD](#)

[Display](#)

[HDMI](#)

[Microphone](#)

[Peripheral device](#)

[Recovery](#)

[Sensor](#)

[Speakers](#)

[Touch panel](#)

[BIOS](#)

[Button](#)

[Camera](#)

[Encryption](#)

[Memory module](#)

[Password](#)

[Power](#)

[Security](#)

[Service and support](#)

[TPM](#)

[VAIO computer](#)

[▶ Troubleshooting](#)

How to Use

[Parts Description](#)

[Setup](#)

[Network / Internet](#)

[Connections](#)

[Settings](#)

[Playback](#)

[Backup / Recovery](#)

[Security](#)

[Other Operations](#)

[Notifications](#)

Audio

[Adjusting the Microphone Volume](#)

You can adjust the volume level of the microphone.

[Adjusting the Speakers Volume](#)

You can change the volume level of the speakers and headphones.

[Adjusting the Volume in Windows](#)

You can adjust the volume on each app from wi0210.

[Changing the Sound Output Device](#)

If there is no sound from the device connected to your VAIO computer, you need to change the device for sound output.

[Playing Surround Sound Using S-FORCE Front Surround 3D](#)

S-FORCE Front Surround 3D is a virtual surround technology which allows you to enjoy powerful and realistic surround sound using the built-in speakers. Its effect is especially noticeable when you are watching movies.

You might be looking for the following topics:

[Connecting External Speakers or Headphones](#)

[Connecting an External Microphone](#)

[▶ Troubleshooting](#)

How to Use

[Parts Description](#)

[Setup](#)

[Network / Internet](#)

[Connections](#)

[Settings](#)

[Playback](#)

[Backup / Recovery](#)

[Security](#)

[Other Operations](#)

[Notifications](#)

BIOS

[About the ASSIST Button](#)

Press the ASSIST button to perform regular maintenance of your VAIO computer or to solve problems you might encounter when using the computer.

[Booting Your VAIO Computer from External Devices](#)

You can boot your VAIO computer from external devices, such as an optical disc drive, a USB floppy disk drive, or a USB flash drive by using the BIOS function.

[Removing the Power-on Password](#)

If power-on password input for booting up your VAIO computer is no longer necessary, follow these steps to remove the machine password and user password.

[Setting/Changing the Power-on Password](#)

You can set a password (power-on password) for booting up your VAIO computer, using the BIOS function. Entry of the power-on password will be prompted after the VAIO logo appears to start the computer.

[Using Intel\(R\) Anti-Theft Technology<Intel\(R\) Anti-Theft Technology supported models>](#)

You can change the Intel(R) Anti-Theft Technology settings in the BIOS setup screen.

[▶ Troubleshooting](#)

How to Use

[Parts Description](#)

[Setup](#)

[Network / Internet](#)

[Connections](#)

[Settings](#)

[Playback](#)

[Backup / Recovery](#)

[Security](#)

[Other Operations](#)

[Notifications](#)

Battery

[Notes on Using the Battery Pack](#)

Before using the battery pack, read the following precautions for correct use.

You might be looking for the following topics:

[Changing the Rapid Wake \(Sleep Mode\) Settings](#)[Charge Indicator Status List](#)[Charging the Battery Pack](#)[Checking the Battery Charge Capacity](#)[Extending the Battery Life](#)[Installing/Removing the Battery Pack](#)

[▶ Troubleshooting](#)

How to Use

[Parts Description](#)

[Setup](#)

[Network / Internet](#)

[Connections](#)

[Settings](#)

[Playback](#)

[Backup / Recovery](#)

[Security](#)

[Other Operations](#)

[Notifications](#)

Button

[About the ASSIST Button](#)

Press the ASSIST button to perform regular maintenance of your VAIO computer or to solve problems you might encounter when using the computer.

[▶ Troubleshooting](#)

How to Use

[Parts Description](#)

[Setup](#)

[Network / Internet](#)

[Connections](#)

[Settings](#)

[Playback](#)

[Backup / Recovery](#)

[Security](#)

[Other Operations](#)

[Notifications](#)

CD/DVD/BD

[Booting Your VAIO Computer from External Devices](#)

You can boot your VAIO computer from external devices, such as an optical disc drive, a USB floppy disk drive, or a USB flash drive by using the BIOS function.

You might be looking for the following topics:

[About Region Codes<Optical disc drive equipped models>](#)[Connecting an External Drive](#)[Handling Discs<Optical disc drive equipped models>](#)[Inserting/Removing a Disc<Optical disc drive equipped models>](#)[Notes on Using Discs<Optical disc drive equipped models>](#)[Supported Discs<Optical disc drive equipped models>](#)

[▶ Troubleshooting](#)

How to Use

[Parts Description](#)

[Setup](#)

[Network / Internet](#)

[Connections](#)

[Settings](#)

[Playback](#)

[Backup / Recovery](#)

[Security](#)

[Other Operations](#)

[Notifications](#)

Camera

[Using the Built-in Camera<Built-in camera equipped models>](#)

If your VAIO computer is equipped with a built-in camera, you can make a video call through the Internet using communication software, such as Windows Live Messenger. For detailed information on how to use the software, refer to the help file included with the software.

You might be looking for the following topics:

[Notes on the Built-in Camera<Built-in camera equipped models>](#)

[▶ Troubleshooting](#)

How to Use

[Parts Description](#)

[Setup](#)

[Network / Internet](#)

[Connections](#)

[Settings](#)

[Playback](#)

[Backup / Recovery](#)

[Security](#)

[Other Operations](#)

[Notifications](#)

Display

[Changing the LCD Brightness](#)

You can adjust the LCD brightness.

[Changing the Resolution \(Size\) of the Screen Image](#)

You can change the screen resolution to adjust the size of the characters and images on the computer screen.

[Changing the Resolution \(Size\) of the Screen Image on an HDMI-Connected Device](#)

You can change the screen resolution or size of your VAIO computer's screen image displayed on an external display, such as a TV, connected to the computer with an HDMI cable (not supplied).

[Enable/Disable the Touch Screen<Touch screen equipped models>](#)

By default, the touch screen of your VAIO computer is enabled. To disable/enable the touch screen, follow these steps:

[Enlarging the Text Size \(DPI\)<Touch screen equipped models>](#)

You can change the DPI to enlarge the font size, making it easier to touch specific text.

[How to Use the Touch Screen<Touch screen equipped models>](#)

You can tap the touch screen or make a simple motion with your fingers to operate your VAIO computer.

[Notes on Using the Touch Screen<Touch screen equipped models>](#)

Before using the touch screen, read the following precautions for correct use.

[Notes on the LCD screen](#)

Read the following precautions for correct use of the LCD screen.

You might be looking for the following topics:

[About the Touch Screen<Touch screen equipped models>](#)

[Adjusting the Angle of the Screen](#)

[▶ Troubleshooting](#)

How to Use

[Parts Description](#)

[Setup](#)

[Network / Internet](#)

[Connections](#)

[Settings](#)

[Playback](#)

[Backup / Recovery](#)

[Security](#)

[Other Operations](#)

[Notifications](#)

Encryption

[Encrypting Your Data with the TPM \(BitLocker\)<TPM security chip equipped models><BitLocker supported models>](#)

You can use BitLocker included with Windows 8 Pro to encrypt the data on the built-in storage device.

[Notes on Using the TPM<TPM security chip equipped models>](#)

Before using the Trusted Platform Module (TPM), read the following precautions for correct use.

[▶ Troubleshooting](#)

How to Use

[Parts Description](#)

[Setup](#)

[Network / Internet](#)

[Connections](#)

[Settings](#)

[Playback](#)

[Backup / Recovery](#)

[Security](#)

[Other Operations](#)

[Notifications](#)

HDMI

[Changing the Resolution \(Size\) of the Screen Image on an HDMI-Connected Device](#)

You can change the screen resolution or size of your VAIO computer's screen image displayed on an external display, such as a TV, connected to the computer with an HDMI cable (not supplied).

[▶ Troubleshooting](#)

How to Use

[Parts Description](#)

[Setup](#)

[Network / Internet](#)

[Connections](#)

[Settings](#)

[Playback](#)

[Backup / Recovery](#)

[Security](#)

[Other Operations](#)

[Notifications](#)

Memory module

[Viewing the System Information](#)

You can view the system information of your VAIO computer.

You might be looking for the following topics:

[Adding and Removing Memory Modules](#)[Notes on Adding and Removing Memory Modules](#)

[▶ Troubleshooting](#)

How to Use

[Parts Description](#)

[Setup](#)

[Network / Internet](#)

[Connections](#)

[Settings](#)

[Playback](#)

[Backup / Recovery](#)

[Security](#)

[Other Operations](#)

[Notifications](#)

Microphone

[Adjusting the Microphone Volume](#)

You can adjust the volume level of the microphone.

You might be looking for the following topics:

[Connecting an External Microphone](#)

[▶ Troubleshooting](#)

How to Use

[Parts Description](#)

[Setup](#)

[Network / Internet](#)

[Connections](#)

[Settings](#)

[Playback](#)

[Backup / Recovery](#)

[Security](#)

[Other Operations](#)

[Notifications](#)

Password

[Creating/Changing/Removing Your Windows Password](#)

Setting the Windows password allows you to protect your VAIO computer from unauthorized access by making the user enter the password when the computer is turned on or returns from power saving mode to Normal mode.

[Removing the Power-on Password](#)

If power-on password input for booting up your VAIO computer is no longer necessary, follow these steps to remove the machine password and user password.

[Setting/Changing the Power-on Password](#)

You can set a password (power-on password) for booting up your VAIO computer, using the BIOS function. Entry of the power-on password will be prompted after the VAIO logo appears to start the computer.

[▶ Troubleshooting](#)

How to Use

[Parts Description](#)

[Setup](#)

[Network / Internet](#)

[Connections](#)

[Settings](#)

[Playback](#)

[Backup / Recovery](#)

[Security](#)

[Other Operations](#)

[Notifications](#)

Peripheral device

[Changing the Sound Output Device](#)

If there is no sound from the device connected to your VAIO computer, you need to change the device for sound output.

[Notes on the LCD screen](#)

Read the following precautions for correct use of the LCD screen.

You might be looking for the following topics:

[Connecting an External Microphone](#)

[▶ Troubleshooting](#)

How to Use

[Parts Description](#)

[Setup](#)

[Network / Internet](#)

[Connections](#)

[Settings](#)

[Playback](#)

[Backup / Recovery](#)

[Security](#)

[Other Operations](#)

[Notifications](#)

Power

[Notes on Sleep Mode](#)

Read the following precautions before using Sleep mode.

[Notes on Using the Power Source](#)

Read the following precautions before plugging your VAIO computer into an AC power source.

[Selecting a Power Plan](#)

Power management helps you set up power plans to suit your requirements for power consumption.

[Using Sleep Mode](#)

In Sleep mode, all unnecessary devices of your VAIO computer are turned off, though some devices stay on to retain the computer's state including data you are working on. Sleep mode is useful when you take a short rest, for example.

You might be looking for the following topics:

[Changing the Rapid Wake \(Sleep Mode\) Settings](#)[Charge Indicator Status List](#)[Charging the Battery Pack](#)[Connecting a Power Source](#)[Installing/Removing the Battery Pack](#)[Restarting Your VAIO Computer](#)[Shutting Down Your VAIO Computer](#)[Turning on Your VAIO Computer](#)

[▶ Troubleshooting](#)

How to Use

[Parts Description](#)

[Setup](#)

[Network / Internet](#)

[Connections](#)

[Settings](#)

[Playback](#)

[Backup / Recovery](#)

[Security](#)

[Other Operations](#)

[Notifications](#)

Recovery

[About the ASSIST Button](#)

Press the ASSIST button to perform regular maintenance of your VAIO computer or to solve problems you might encounter when using the computer.

You might be looking for the following topics:

[About Recovery](#)[Checking the Volume of the Recovery Area](#)[Creating Recovery Media](#)[Notes on Recovery](#)[Recovering from Recovery Media](#)[Recovering from the Recovery Area](#)[Removing Recovery Contents to Free up Disk Space](#)

[▶ Troubleshooting](#)

How to Use

[Parts Description](#)

[Setup](#)

[Network / Internet](#)

[Connections](#)

[Settings](#)

[Playback](#)

[Backup / Recovery](#)

[Security](#)

[Other Operations](#)

[Notifications](#)

Security

[Updating Your VAIO Computer](#)

Be sure to update your VAIO computer with the following software applications to enhance the computer's efficiency, security, and functionality.

[▶ Troubleshooting](#)

How to Use

[Parts Description](#)

[Setup](#)

[Network / Internet](#)

[Connections](#)

[Settings](#)

[Playback](#)

[Backup / Recovery](#)

[Security](#)

[Other Operations](#)

[Notifications](#)

Sensor

[About Built-In Sensors](#)

A built-in accelerometer and digital compass (magnetometer) enable you to use the following functions.

[Notes on Built-In Sensors](#)

Before using built-in sensors, read the following precautions for correct use.

[▶ Troubleshooting](#)

How to Use

[Parts Description](#)

[Setup](#)

[Network / Internet](#)

[Connections](#)

[Settings](#)

[Playback](#)

[Backup / Recovery](#)

[Security](#)

[Other Operations](#)

[Notifications](#)

Service and support

[Keeping Your VAIO Computer in Optimum Condition \(VAIO Care\)](#)

With VAIO Care, you can perform the following operations to keep your VAIO computer running at an optimum level.

[Updating Your VAIO Computer](#)

Be sure to update your VAIO computer with the following software applications to enhance the computer's efficiency, security, and functionality.

[Using VAIO Update](#)

VAIO Update provides a service that informs you of available update information, such as important notices or update programs, to keep your VAIO computer up to date.

You might be looking for the following topics:

[About Online Support Website](#)

[Solving Common Problems with Your VAIO Computer](#)

[▶ Troubleshooting](#)

How to Use

[Parts Description](#)

[Setup](#)

[Network / Internet](#)

[Connections](#)

[Settings](#)

[Playback](#)

[Backup / Recovery](#)

[Security](#)

[Other Operations](#)

[Notifications](#)

Speakers

[Adjusting the Speakers Volume](#)

You can change the volume level of the speakers and headphones.

You might be looking for the following topics:

[Connecting External Speakers or Headphones](#)

[▶ Troubleshooting](#)

How to Use

[Parts Description](#)

[Setup](#)

[Network / Internet](#)

[Connections](#)

[Settings](#)

[Playback](#)

[Backup / Recovery](#)

[Security](#)

[Other Operations](#)

[Notifications](#)

TPM

[Encrypting Your Data with the TPM \(BitLocker\)<TPM security chip equipped models><BitLocker supported models>](#)

You can use BitLocker included with Windows 8 Pro to encrypt the data on the built-in storage device.

[Notes on Using the TPM<TPM security chip equipped models>](#)

Before using the Trusted Platform Module (TPM), read the following precautions for correct use.

[▶ Troubleshooting](#)

How to Use

[Parts Description](#)

[Setup](#)

[Network / Internet](#)

[Connections](#)

[Settings](#)

[Playback](#)

[Backup / Recovery](#)

[Security](#)

[Other Operations](#)

[Notifications](#)

Touch panel

[Enable/Disable the Touch Screen<Touch screen equipped models>](#)

By default, the touch screen of your VAIO computer is enabled. To disable/enable the touch screen, follow these steps:

[Enlarging the Text Size \(DPI\)<Touch screen equipped models>](#)

You can change the DPI to enlarge the font size, making it easier to touch specific text.

[How to Use the Touch Screen<Touch screen equipped models>](#)

You can tap the touch screen or make a simple motion with your fingers to operate your VAIO computer.

[Notes on Using the Touch Screen<Touch screen equipped models>](#)

Before using the touch screen, read the following precautions for correct use.

You might be looking for the following topics:

[About the Touch Screen<Touch screen equipped models>](#)

[▶ Troubleshooting](#)

How to Use

[Parts Description](#)

[Setup](#)

[Network / Internet](#)

[Connections](#)

[Settings](#)

[Playback](#)

[Backup / Recovery](#)

[Security](#)

[Other Operations](#)

[Notifications](#)

VAIO computer

[About the ASSIST Button](#)

Press the ASSIST button to perform regular maintenance of your VAIO computer or to solve problems you might encounter when using the computer.

[Booting Your VAIO Computer from External Devices](#)

You can boot your VAIO computer from external devices, such as an optical disc drive, a USB floppy disk drive, or a USB flash drive by using the BIOS function.

[Customizing Your VAIO Computer](#)

(VAIO Control Center) allows you to access system information and to change settings of various kinds of functions such as display and sounds.

[Keeping Your VAIO Computer in Optimum Condition \(VAIO Care\)](#)

With VAIO Care, you can perform the following operations to keep your VAIO computer running at an optimum level.

[Updating Your VAIO Computer](#)

Be sure to update your VAIO computer with the following software applications to enhance the computer's efficiency, security, and functionality.

[Using VAIO Update](#)

VAIO Update provides a service that informs you of available update information, such as important notices or update programs, to keep your VAIO computer up to date.

[Viewing the System Information](#)

You can view the system information of your VAIO computer.

You might be looking for the following topics:

[Adding and Removing Memory Modules](#)[Checking Supplied Items](#)[Notes on Adding and Removing Memory Modules](#)[Parts and Controls on the Back](#)[Parts and Controls on the Front](#)[Parts and Controls on the Sides](#)[Setting Up an Appropriate Work Environment](#)[Setting the Stand](#)

[▶ Troubleshooting](#)

How to Use

Parts Description

Setup

Network / Internet

Connections

Settings

Playback

Backup / Recovery

Security

Other Operations

Notifications

Playback

[CD/DVD/BD](#)

[▶ Troubleshooting](#)

How to Use

[Parts Description](#)

[Setup](#)

[Network / Internet](#)

[Connections](#)

[Settings](#)

[Playback](#)

[Backup / Recovery](#)

[Security](#)

[Other Operations](#)

[Notifications](#)

CD/DVD/BD

[About Region Codes<Optical disc drive equipped models>](#)

The following is a list of DVD region codes indicating playable regions of DVD media.

[Inserting/Removing a Disc<Optical disc drive equipped models>](#)

Insert/remove a disc to/from your VAIO computer that is turned on.

[Supported Discs<Optical disc drive equipped models>](#)

This topic explains media types that are playable/recordable on your VAIO computer.

You might be looking for the following topics:

[Booting Your VAIO Computer from External Devices](#)

[Connecting an External Drive](#)

[Handling Discs<Optical disc drive equipped models>](#)

[Notes on Using Discs<Optical disc drive equipped models>](#)

[▶ Troubleshooting](#)

How to Use

[Parts Description](#)

[Setup](#)

[Network / Internet](#)

[Connections](#)

[Settings](#)

[Playback](#)

[Backup / Recovery](#)

[Security](#)

[Other Operations](#)

[Notifications](#)

Backup / Recovery

[BIOS](#)

[Built-in storage device](#)

[CD/DVD/BD](#)

[Recovery](#)

[VAIO computer](#)

[Backup](#)

[Button](#)

[Partition](#)

[Service and support](#)

[▶ Troubleshooting](#)

How to Use

[Parts Description](#)

[Setup](#)

[Network / Internet](#)

[Connections](#)

[Settings](#)

[Playback](#)

[Backup / Recovery](#)

[Security](#)

[Other Operations](#)

[Notifications](#)

BIOS

[About the ASSIST Button](#)

Press the ASSIST button to perform regular maintenance of your VAIO computer or to solve problems you might encounter when using the computer.

[Booting Your VAIO Computer from External Devices](#)

You can boot your VAIO computer from external devices, such as an optical disc drive, a USB floppy disk drive, or a USB flash drive by using the BIOS function.

You might be looking for the following topics:

[Removing the Power-on Password](#)[Setting/Changing the Power-on Password](#)[Using Intel\(R\) Anti-Theft Technology<Intel\(R\) Anti-Theft Technology supported models>](#)

[▶ Troubleshooting](#)

How to Use

[Parts Description](#)

[Setup](#)

[Network / Internet](#)

[Connections](#)

[Settings](#)

[Playback](#)

[Backup / Recovery](#)

[Security](#)

[Other Operations](#)

[Notifications](#)

Backup

[About Backup](#)

The backup process creates a backup copy of your data stored on the built-in storage device and saves it to another location.

[About Types of Backup](#)

You can use the Windows Backup and Restore feature to back up your valuable data.

[Backing Up Your Data when You cannot Start Windows](#)

If you cannot start Windows, back up your data with VAIO Care Rescue.

[Creating a Restore Point](#)

A restore point enables you to restore your computer system files to a previous state, depending on when the restore point was created.

[Restoring System Files Using the Restore Point when You cannot Start Windows](#)

When you cannot start Windows, follow these steps to restore computer system files.

[Restoring Your Data with VAIO Data Restore Tool](#)

If you backed up files previously using VAIO Care Rescue, use VAIO Data Restore Tool to restore these files.

[▶ Troubleshooting](#)

How to Use

[Parts Description](#)

[Setup](#)

[Network / Internet](#)

[Connections](#)

[Settings](#)

[Playback](#)

[Backup / Recovery](#)

[Security](#)

[Other Operations](#)

[Notifications](#)

Built-in storage device

[Checking the Volume of the Recovery Area](#)

Your built-in storage device contains the recovery area where the data for the system recovery is stored.

[Creating Other Drives \(Modifying Partitions\)](#)

Partitions are divided areas on your built-in storage device. Dividing the built-in storage device into more than one partition may have various advantages, such as separating the system files from your data files.

[Creating Partitions](#)

This topic describes how to create partitions.

[Removing Recovery Contents to Free up Disk Space](#)

Your built-in storage device contains the recovery area where the data for system recovery is stored. If your VAIO computer includes a solid state drive (SSD), you might want to minimize the recovery area by removing such data.

[▶ Troubleshooting](#)

How to Use

[Parts Description](#)

[Setup](#)

[Network / Internet](#)

[Connections](#)

[Settings](#)

[Playback](#)

[Backup / Recovery](#)

[Security](#)

[Other Operations](#)

[Notifications](#)

Button

[About the ASSIST Button](#)

Press the ASSIST button to perform regular maintenance of your VAIO computer or to solve problems you might encounter when using the computer.

[▶ Troubleshooting](#)

How to Use

[Parts Description](#)

[Setup](#)

[Network / Internet](#)

[Connections](#)

[Settings](#)

[Playback](#)

[Backup / Recovery](#)

[Security](#)

[Other Operations](#)

[Notifications](#)

CD/DVD/BD

[Booting Your VAIO Computer from External Devices](#)

You can boot your VAIO computer from external devices, such as an optical disc drive, a USB floppy disk drive, or a USB flash drive by using the BIOS function.

You might be looking for the following topics:

[About Region Codes<Optical disc drive equipped models>](#)

[Connecting an External Drive](#)

[Handling Discs<Optical disc drive equipped models>](#)

[Inserting/Removing a Disc<Optical disc drive equipped models>](#)

[Notes on Using Discs<Optical disc drive equipped models>](#)

[Supported Discs<Optical disc drive equipped models>](#)

[▶ Troubleshooting](#)

How to Use

[Parts Description](#)

[Setup](#)

[Network / Internet](#)

[Connections](#)

[Settings](#)

[Playback](#)

[Backup / Recovery](#)

[Security](#)

[Other Operations](#)

[Notifications](#)

Partition

[Creating Other Drives \(Modifying Partitions\)](#)

Partitions are divided areas on your built-in storage device. Dividing the built-in storage device into more than one partition may have various advantages, such as separating the system files from your data files.

[Creating Partitions](#)

This topic describes how to create partitions.

[▶ Troubleshooting](#)

How to Use

[Parts Description](#)

[Setup](#)

[Network / Internet](#)

[Connections](#)

[Settings](#)

[Playback](#)

[Backup / Recovery](#)

[Security](#)

[Other Operations](#)

[Notifications](#)

Recovery

[About Recovery](#)

Recovery is the process of restoring your VAIO computer back to its original factory condition.

[About the ASSIST Button](#)

Press the ASSIST button to perform regular maintenance of your VAIO computer or to solve problems you might encounter when using the computer.

[Checking the Volume of the Recovery Area](#)

Your built-in storage device contains the recovery area where the data for the system recovery is stored.

[Creating Recovery Media](#)

Follow the instructions below to create Recovery Media.

[Notes on Recovery](#)

Read the following notes thoroughly before recovering your VAIO computer.

[Recovering from Recovery Media](#)

If the recovery area data has been corrupted or erased, you can use Recovery Media to recover your VAIO computer. However, it takes longer time to recover using Recovery Media than using the recovery area.

[Recovering from the Recovery Area](#)

Recovery from the recovery area on the built-in storage device is faster than recovery using Recovery Media.

[Removing Recovery Contents to Free up Disk Space](#)

Your built-in storage device contains the recovery area where the data for system recovery is stored. If your VAIO computer includes a solid state drive (SSD), you might want to minimize the recovery area by removing such data.

[▶ Troubleshooting](#)

How to Use

[Parts Description](#)

[Setup](#)

[Network / Internet](#)

[Connections](#)

[Settings](#)

[Playback](#)

[Backup / Recovery](#)

[Security](#)

[Other Operations](#)

[Notifications](#)

Service and support

[Keeping Your VAIO Computer in Optimum Condition \(VAIO Care\)](#)

With VAIO Care, you can perform the following operations to keep your VAIO computer running at an optimum level.

You might be looking for the following topics:

[About Online Support Website](#)[Solving Common Problems with Your VAIO Computer](#)[Updating Your VAIO Computer](#)[Using VAIO Update](#)

[▶ Troubleshooting](#)

How to Use

[Parts Description](#)

[Setup](#)

[Network / Internet](#)

[Connections](#)

[Settings](#)

[Playback](#)

[Backup / Recovery](#)

[Security](#)

[Other Operations](#)

[Notifications](#)

VAIO computer

[About the ASSIST Button](#)

Press the ASSIST button to perform regular maintenance of your VAIO computer or to solve problems you might encounter when using the computer.

[Booting Your VAIO Computer from External Devices](#)

You can boot your VAIO computer from external devices, such as an optical disc drive, a USB floppy disk drive, or a USB flash drive by using the BIOS function.

[Keeping Your VAIO Computer in Optimum Condition \(VAIO Care\)](#)

With VAIO Care, you can perform the following operations to keep your VAIO computer running at an optimum level.

You might be looking for the following topics:

[Adding and Removing Memory Modules](#)[Checking Supplied Items](#)[Customizing Your VAIO Computer](#)[Notes on Adding and Removing Memory Modules](#)[Parts and Controls on the Back](#)[Parts and Controls on the Front](#)[Parts and Controls on the Sides](#)[Setting Up an Appropriate Work Environment](#)[Setting the Stand](#)[Updating Your VAIO Computer](#)[Using VAIO Update](#)[Viewing the System Information](#)

[▶ Troubleshooting](#)

How to Use

Parts Description

Setup

Network / Internet

Connections

Settings

Playback

Backup / Recovery

Security

Other Operations

Notifications

Security

[BIOS](#)

[Internet](#)

[Service and support](#)

[VAIO computer](#)

[Encryption](#)

[Password](#)

[TPM](#)

[▶ Troubleshooting](#)

How to Use

[Parts Description](#)

[Setup](#)

[Network / Internet](#)

[Connections](#)

[Settings](#)

[Playback](#)

[Backup / Recovery](#)

[Security](#)

[Other Operations](#)

[Notifications](#)

BIOS

[Removing the Power-on Password](#)

If power-on password input for booting up your VAIO computer is no longer necessary, follow these steps to remove the machine password and user password.

[Setting/Changing the Power-on Password](#)

You can set a password (power-on password) for booting up your VAIO computer, using the BIOS function. Entry of the power-on password will be prompted after the VAIO logo appears to start the computer.

You might be looking for the following topics:

[About the ASSIST Button](#)

[Booting Your VAIO Computer from External Devices](#)

[Using Intel\(R\) Anti-Theft Technology<Intel\(R\) Anti-Theft Technology supported models>](#)

[▶ Troubleshooting](#)

How to Use

[Parts Description](#)

[Setup](#)

[Network / Internet](#)

[Connections](#)

[Settings](#)

[Playback](#)

[Backup / Recovery](#)

[Security](#)

[Other Operations](#)

[Notifications](#)

Encryption

[Encrypting Your Data with the TPM \(BitLocker\)<TPM security chip equipped models><BitLocker supported models>](#)

You can use BitLocker included with Windows 8 Pro to encrypt the data on the built-in storage device.

[Notes on Using the TPM<TPM security chip equipped models>](#)

Before using the Trusted Platform Module (TPM), read the following precautions for correct use.

[▶ Troubleshooting](#)

How to Use

[Parts Description](#)

[Setup](#)

[Network / Internet](#)

[Connections](#)

[Settings](#)

[Playback](#)

[Backup / Recovery](#)

[Security](#)

[Other Operations](#)

[Notifications](#)

Internet

[Launching the Web Browser \(WEB Button\)<WEB Button equipped models>](#)

By pressing the WEB button, you can launch the default web browser.

[Using the Antivirus App for Your VAIO Computer](#)

Protect your VAIO computer against computer viruses by using the antivirus app.

You might be looking for the following topics:

[About a Security Key for Wi-Fi \(Wireless LAN\)](#)[About the Internet Connection Services](#)[About the Network \(LAN\)](#)[About the Wi-Fi \(Wireless LAN\) Standards](#)[Connecting to the Internet with a Wired Connection](#)[Disabling the Wi-Fi \(Wireless LAN\) Function](#)[Notes on Using the Wi-Fi \(Wireless LAN\) Function](#)[Starting Wi-Fi \(Wireless LAN\) Communications](#)[Stopping Wi-Fi \(Wireless LAN\) Communications](#)

[▶ Troubleshooting](#)

How to Use

[Parts Description](#)

[Setup](#)

[Network / Internet](#)

[Connections](#)

[Settings](#)

[Playback](#)

[Backup / Recovery](#)

[Security](#)

[Other Operations](#)

[Notifications](#)

Password

[Creating/Changing/Removing Your Windows Password](#)

Setting the Windows password allows you to protect your VAIO computer from unauthorized access by making the user enter the password when the computer is turned on or returns from power saving mode to Normal mode.

[Removing the Power-on Password](#)

If power-on password input for booting up your VAIO computer is no longer necessary, follow these steps to remove the machine password and user password.

[Setting/Changing the Power-on Password](#)

You can set a password (power-on password) for booting up your VAIO computer, using the BIOS function. Entry of the power-on password will be prompted after the VAIO logo appears to start the computer.

[▶ Troubleshooting](#)

How to Use

[Parts Description](#)

[Setup](#)

[Network / Internet](#)

[Connections](#)

[Settings](#)

[Playback](#)

[Backup / Recovery](#)

[Security](#)

[Other Operations](#)

[Notifications](#)

Service and support

[Keeping Your VAIO Computer in Optimum Condition \(VAIO Care\)](#)

With VAIO Care, you can perform the following operations to keep your VAIO computer running at an optimum level.

[Using VAIO Update](#)

VAIO Update provides a service that informs you of available update information, such as important notices or update programs, to keep your VAIO computer up to date.

You might be looking for the following topics:

[About Online Support Website](#)

[Solving Common Problems with Your VAIO Computer](#)

[Updating Your VAIO Computer](#)

[▶ Troubleshooting](#)

How to Use

[Parts Description](#)

[Setup](#)

[Network / Internet](#)

[Connections](#)

[Settings](#)

[Playback](#)

[Backup / Recovery](#)

[Security](#)

[Other Operations](#)

[Notifications](#)

TPM

[Encrypting Your Data with the TPM \(BitLocker\)<TPM security chip equipped models><BitLocker supported models>](#)

You can use BitLocker included with Windows 8 Pro to encrypt the data on the built-in storage device.

[Notes on Using the TPM<TPM security chip equipped models>](#)

Before using the Trusted Platform Module (TPM), read the following precautions for correct use.

[▶ Troubleshooting](#)

How to Use

[Parts Description](#)

[Setup](#)

[Network / Internet](#)

[Connections](#)

[Settings](#)

[Playback](#)

[Backup / Recovery](#)

[Security](#)

[Other Operations](#)

[Notifications](#)

VAIO computer

[Keeping Your VAIO Computer in Optimum Condition \(VAIO Care\)](#)

With VAIO Care, you can perform the following operations to keep your VAIO computer running at an optimum level.

[Using VAIO Update](#)

VAIO Update provides a service that informs you of available update information, such as important notices or update programs, to keep your VAIO computer up to date.

You might be looking for the following topics:

[About the ASSIST Button](#)[Adding and Removing Memory Modules](#)[Booting Your VAIO Computer from External Devices](#)[Checking Supplied Items](#)[Customizing Your VAIO Computer](#)[Notes on Adding and Removing Memory Modules](#)[Parts and Controls on the Back](#)[Parts and Controls on the Front](#)[Parts and Controls on the Sides](#)[Setting Up an Appropriate Work Environment](#)[Setting the Stand](#)[Updating Your VAIO Computer](#)[Viewing the System Information](#)

[▶ Troubleshooting](#)

How to Use

[Parts Description](#)

[Setup](#)

[Network / Internet](#)

[Connections](#)

[Settings](#)

[Playback](#)

[Backup / Recovery](#)

[Security](#)

[Other Operations](#)

[Notifications](#)

Other Operations

[BIOS](#)

[Built-in storage device](#)

[Camera](#)

[Keyboard](#)

[Memory module](#)

[Partition](#)

[Touch panel](#)

[VAIO computer](#)

[Battery](#)

[CD/DVD/BD](#)

[Display](#)

[Memory card](#)

[Mouse](#)

[Power](#)

[USB](#)

[▶ Troubleshooting](#)

How to Use

[Parts Description](#)

[Setup](#)

[Network / Internet](#)

[Connections](#)

[Settings](#)

[Playback](#)

[Backup / Recovery](#)

[Security](#)

[Other Operations](#)

[Notifications](#)

BIOS

[Using Intel\(R\) Anti-Theft Technology<Intel\(R\) Anti-Theft Technology supported models>](#)

You can change the Intel(R) Anti-Theft Technology settings in the BIOS setup screen.

You might be looking for the following topics:

[About the ASSIST Button](#)

[Booting Your VAIO Computer from External Devices](#)

[Removing the Power-on Password](#)

[Setting/Changing the Power-on Password](#)

[▶ Troubleshooting](#)

How to Use

[Parts Description](#)

[Setup](#)

[Network / Internet](#)

[Connections](#)

[Settings](#)

[Playback](#)

[Backup / Recovery](#)

[Security](#)

[Other Operations](#)

[Notifications](#)

Battery

[Changing the Rapid Wake \(Sleep Mode\) Settings](#)

You can change the Rapid Wake settings on VAIO Control Center.

[Charge Indicator Status List](#)

The charge indicator light turns on or blinks differently according to conditions.

[Charging the Battery Pack](#)

The battery pack can be charged even while you are using your VAIO computer when the computer is connected to a power source.

[Checking the Battery Charge Capacity](#)

The battery pack is consumable. The capacity gradually declines through repeated cycles of recharging and discharging. As a result, the battery life becomes short even if it is fully charged and eventually the battery pack reaches the end of its life.

[Extending the Battery Life](#)

When your VAIO computer is running on battery power, you can extend the battery life using the following methods.

You might be looking for the following topics:

[Installing/Removing the Battery Pack](#)

[Notes on Using the Battery Pack](#)

[▶ Troubleshooting](#)

How to Use

[Parts Description](#)

[Setup](#)

[Network / Internet](#)

[Connections](#)

[Settings](#)

[Playback](#)

[Backup / Recovery](#)

[Security](#)

[Other Operations](#)

[Notifications](#)

Built-in storage device

[Creating Other Drives \(Modifying Partitions\)](#)

Partitions are divided areas on your built-in storage device. Dividing the built-in storage device into more than one partition may have various advantages, such as separating the system files from your data files.

[Creating Partitions](#)

This topic describes how to create partitions.

You might be looking for the following topics:

[Checking the Volume of the Recovery Area](#)

[Removing Recovery Contents to Free up Disk Space](#)

[▶ Troubleshooting](#)

How to Use

[Parts Description](#)

[Setup](#)

[Network / Internet](#)

[Connections](#)

[Settings](#)

[Playback](#)

[Backup / Recovery](#)

[Security](#)

[Other Operations](#)

[Notifications](#)

CD/DVD/BD

[Inserting/Removing a Disc<Optical disc drive equipped models>](#)

Insert/remove a disc to/from your VAIO computer that is turned on.

You might be looking for the following topics:

[About Region Codes<Optical disc drive equipped models>](#)

[Booting Your VAIO Computer from External Devices](#)

[Connecting an External Drive](#)

[Handling Discs<Optical disc drive equipped models>](#)

[Notes on Using Discs<Optical disc drive equipped models>](#)

[Supported Discs<Optical disc drive equipped models>](#)

[▶ Troubleshooting](#)

How to Use

[Parts Description](#)

[Setup](#)

[Network / Internet](#)

[Connections](#)

[Settings](#)

[Playback](#)

[Backup / Recovery](#)

[Security](#)

[Other Operations](#)

[Notifications](#)

Camera

[Notes on the Built-in Camera<Built-in camera equipped models>](#)[Using the Built-in Camera<Built-in camera equipped models>](#)

If your VAIO computer is equipped with a built-in camera, you can make a video call through the Internet using communication software, such as Windows Live Messenger. For detailed information on how to use the software, refer to the help file included with the software.

[▶ Troubleshooting](#)

How to Use

[Parts Description](#)

[Setup](#)

[Network / Internet](#)

[Connections](#)

[Settings](#)

[Playback](#)

[Backup / Recovery](#)

[Security](#)

[Other Operations](#)

[Notifications](#)

Display

[About the Touch Screen<Touch screen equipped models>](#)

The touch screen enables direct interaction with your VAIO computer using your finger(s). You can perform various gestures on the touch screen instead of mouse operations, such as selecting items and scrolling.

[Adjusting the Angle of the Screen](#)

You can adjust the screen angle of your choice.

[How to Use the Touch Screen<Touch screen equipped models>](#)

You can tap the touch screen or make a simple motion with your fingers to operate your VAIO computer.

[Notes on Using the Touch Screen<Touch screen equipped models>](#)

Before using the touch screen, read the following precautions for correct use.

You might be looking for the following topics:

[Changing the LCD Brightness](#)[Changing the Resolution \(Size\) of the Screen Image](#)[Changing the Resolution \(Size\) of the Screen Image on an HDMI-Connected Device](#)[Enable/Disable the Touch Screen<Touch screen equipped models>](#)[Enlarging the Text Size \(DPI\)<Touch screen equipped models>](#)[Notes on the LCD screen](#)

[▶ Troubleshooting](#)

How to Use

[Parts Description](#)

[Setup](#)

[Network / Internet](#)

[Connections](#)

[Settings](#)

[Playback](#)

[Backup / Recovery](#)

[Security](#)

[Other Operations](#)

[Notifications](#)

Keyboard

[Checking the Caps Lock / Num Lock / Scroll Lock States](#)

You can check if the keyboard is in the Caps Lock/Num Lock/Scroll Lock states by the indicator light of the keyboard and the icons in the notification area.

[Checking the Remaining Battery Power of the Keyboard](#)

The remaining battery power of the keyboard can be checked by the battery indicator.

[Combinations and Functions with the Fn Key](#)

Press and hold down the Fn key and another key simultaneously to perform a keyboard shortcut action.

[Replacing the AA Battery of the Keyboard](#)

Change the AA battery in the keyboard when the battery power becomes low.

You might be looking for the following topics:

[About the Usage Environment for the Keyboard](#)

[Connecting the Wireless Keyboard](#)

[Parts and Controls of the Keyboard](#)

[▶ Troubleshooting](#)

How to Use

[Parts Description](#)

[Setup](#)

[Network / Internet](#)

[Connections](#)

[Settings](#)

[Playback](#)

[Backup / Recovery](#)

[Security](#)

[Other Operations](#)

[Notifications](#)

Memory card

About “Memory Stick”

“Memory Stick” is a compact, portable, and versatile IC recording media especially designed for exchanging and sharing digital data with compatible products, such as digital cameras and other devices. Because it is removable, it can be used for external data storage.

Compatible “Memory Stick”

The “Memory Stick” slot on your VAIO computer can accommodate the following sizes and types of media:

Formatting “Memory Stick”

“Memory Stick” is formatted in the specific FAT format by default and is ready for use. Be sure to use the device that is designed to format the media and supports “Memory Stick” when formatting the media.

Inserting/Removing SD Memory Cards

Your VAIO computer is equipped with an SD memory card slot. You can use this slot to transfer data among digital cameras, camcorders, music players, and other audio/video devices.

Inserting/Removing “Memory Stick”

You can use “Memory Stick” to save data or transfer images between a digital camera and your VAIO computer. To insert/remove “Memory Stick”, follow these steps.

Notes on Using SD Memory Cards

Before using SD memory cards, read the following precautions for correct use.

Notes on Using “Memory Stick”

Before using “Memory Stick”, read the following precautions for correct use.

[▶ Troubleshooting](#)

How to Use

[Parts Description](#)

[Setup](#)

[Network / Internet](#)

[Connections](#)

[Settings](#)

[Playback](#)

[Backup / Recovery](#)

[Security](#)

[Other Operations](#)

[Notifications](#)

Memory module

[Adding and Removing Memory Modules](#)

If you want to increase your computer's speed or improve performance when running programs simultaneously, increase the amount of memory by installing optional memory modules.

[Notes on Adding and Removing Memory Modules](#)

Before adding or removing memory modules, read the following precautions thoroughly.

You might be looking for the following topics:

[Viewing the System Information](#)

[▶ Troubleshooting](#)

How to Use

[Parts Description](#)

[Setup](#)

[Network / Internet](#)

[Connections](#)

[Settings](#)

[Playback](#)

[Backup / Recovery](#)

[Security](#)

[Other Operations](#)

[Notifications](#)

Mouse

[Replacing the AA Battery of the Mouse](#)

Change the AA battery in the mouse when the battery power becomes low.

You might be looking for the following topics:

[About the Usage Environment for the Mouse](#)[Connecting the Wireless Mouse](#)[Parts and Controls of the Mouse](#)

[▶ Troubleshooting](#)

How to Use

[Parts Description](#)

[Setup](#)

[Network / Internet](#)

[Connections](#)

[Settings](#)

[Playback](#)

[Backup / Recovery](#)

[Security](#)

[Other Operations](#)

[Notifications](#)

Partition

[Creating Other Drives \(Modifying Partitions\)](#)

Partitions are divided areas on your built-in storage device. Dividing the built-in storage device into more than one partition may have various advantages, such as separating the system files from your data files.

[Creating Partitions](#)

This topic describes how to create partitions.

[▶ Troubleshooting](#)

How to Use

[Parts Description](#)

[Setup](#)

[Network / Internet](#)

[Connections](#)

[Settings](#)

[Playback](#)

[Backup / Recovery](#)

[Security](#)

[Other Operations](#)

[Notifications](#)

Power

[Changing the Rapid Wake \(Sleep Mode\) Settings](#)

You can change the Rapid Wake settings on VAIO Control Center.

[Charge Indicator Status List](#)

The charge indicator light turns on or blinks differently according to conditions.

[Charging the Battery Pack](#)

The battery pack can be charged even while you are using your VAIO computer when the computer is connected to a power source.

[Restarting Your VAIO Computer](#)

After changing the settings or installing an app on your VAIO computer, you may be required to restart the computer.

[Shutting Down Your VAIO Computer](#)

Shut down your VAIO computer properly to avoid losing unsaved data.

[Turning on Your VAIO Computer](#)

Turn on your VAIO computer to start Windows. Carefully read the precautions in Notes on Using the Power Source before turning on. [Details]

[Using Sleep Mode](#)

In Sleep mode, all unnecessary devices of your VAIO computer are turned off, though some devices stay on to retain the computer's state including data you are working on. Sleep mode is useful when you take a short rest, for example.

You might be looking for the following topics:

[Connecting a Power Source](#)[Installing/Removing the Battery Pack](#)[Notes on Sleep Mode](#)[Notes on Using the Power Source](#)[Selecting a Power Plan](#)

[▶ Troubleshooting](#)

How to Use

[Parts Description](#)

[Setup](#)

[Network / Internet](#)

[Connections](#)

[Settings](#)

[Playback](#)

[Backup / Recovery](#)

[Security](#)

[Other Operations](#)

[Notifications](#)

Touch panel

[About the Touch Screen<Touch screen equipped models>](#)

The touch screen enables direct interaction with your VAIO computer using your finger(s). You can perform various gestures on the touch screen instead of mouse operations, such as selecting items and scrolling.

[How to Use the Touch Screen<Touch screen equipped models>](#)

You can tap the touch screen or make a simple motion with your fingers to operate your VAIO computer.

[Notes on Using the Touch Screen<Touch screen equipped models>](#)

Before using the touch screen, read the following precautions for correct use.

You might be looking for the following topics:

[Enable/Disable the Touch Screen<Touch screen equipped models>](#)

[Enlarging the Text Size \(DPI\)<Touch screen equipped models>](#)

[▶ Troubleshooting](#)

How to Use

[Parts Description](#)

[Setup](#)

[Network / Internet](#)

[Connections](#)

[Settings](#)

[Playback](#)

[Backup / Recovery](#)

[Security](#)

[Other Operations](#)

[Notifications](#)

USB

Charging a USB Device

You can charge a USB device even while your VAIO computer is off, in Hibernate mode, or Sleep mode by enabling the USB charging settings.

Connecting a USB Device

You can connect a Universal Serial Bus (USB) device such as a mouse, floppy disk drive, speaker or printer to your VAIO computer.

[▶ Troubleshooting](#)

How to Use

[Parts Description](#)

[Setup](#)

[Network / Internet](#)

[Connections](#)

[Settings](#)

[Playback](#)

[Backup / Recovery](#)

[Security](#)

[Other Operations](#)

[Notifications](#)

VAIO computer

[Adding and Removing Memory Modules](#)

If you want to increase your computer's speed or improve performance when running programs simultaneously, increase the amount of memory by installing optional memory modules.

[Notes on Adding and Removing Memory Modules](#)

Before adding or removing memory modules, read the following precautions thoroughly.

You might be looking for the following topics:

[About the ASSIST Button](#)[Booting Your VAIO Computer from External Devices](#)[Checking Supplied Items](#)[Customizing Your VAIO Computer](#)[Keeping Your VAIO Computer in Optimum Condition \(VAIO Care\)](#)[Parts and Controls on the Back](#)[Parts and Controls on the Front](#)[Parts and Controls on the Sides](#)[Setting Up an Appropriate Work Environment](#)[Setting the Stand](#)[Updating Your VAIO Computer](#)[Using VAIO Update](#)[Viewing the System Information](#)

[▶ Troubleshooting](#)

How to Use

[Parts Description](#)

[Setup](#)

[Network / Internet](#)

[Connections](#)

[Settings](#)

[Playback](#)

[Backup / Recovery](#)

[Security](#)

[Other Operations](#)

[Notifications](#)

Notifications

[CD/DVD/BD](#)

[Important notice](#)

[Read this first](#)

[Service and support](#)

[VAIO computer](#)

[Care and maintenance](#)

[Product registration](#)

[Security](#)

[Supplied items](#)

[▶ Troubleshooting](#)

How to Use

[Parts Description](#)

[Setup](#)

[Network / Internet](#)

[Connections](#)

[Settings](#)

[Playback](#)

[Backup / Recovery](#)

[Security](#)

[Other Operations](#)

[Notifications](#)

CD/DVD/BD

[About Region Codes<Optical disc drive equipped models>](#)

The following is a list of DVD region codes indicating playable regions of DVD media.

[Handling Discs<Optical disc drive equipped models>](#)

Read the following to protect data stored on discs and take proper care of discs.

[Notes on Using Discs<Optical disc drive equipped models>](#)

Observe the following notes when using discs on your VAIO computer.

[Supported Discs<Optical disc drive equipped models>](#)

This topic explains media types that are playable/recordable on your VAIO computer.

You might be looking for the following topics:

[Booting Your VAIO Computer from External Devices](#)

[Connecting an External Drive](#)

[Inserting/Removing a Disc<Optical disc drive equipped models>](#)

[▶ Troubleshooting](#)

How to Use

[Parts Description](#)

[Setup](#)

[Network / Internet](#)

[Connections](#)

[Settings](#)

[Playback](#)

[Backup / Recovery](#)

[Security](#)

[Other Operations](#)

[Notifications](#)

Care and maintenance

[Cleaning Your VAIO computer/LCD screen](#)

Before cleaning your VAIO computer, read the following precautions for the correct cleaning procedure.

[▶ Troubleshooting](#)

How to Use

[Parts Description](#)

[Setup](#)

[Network / Internet](#)

[Connections](#)

[Settings](#)

[Playback](#)

[Backup / Recovery](#)

[Security](#)

[Other Operations](#)

[Notifications](#)

Important notice

[About the International ENERGY STAR\(R\) Program](#)

The following information is applicable to ENERGY STAR qualified products only.

[About the Software License](#)

This product contains software owned by Sony and licensed by third parties. Use of such software is subject to the terms and conditions of license agreements enclosed with this product.

[Handling the Built-in Storage Device](#)

The built-in storage device (hard disk drive or solid state drive) has a high storage density and reads or writes data in a short time. However, it can be easily damaged if improperly used.

[Safety Information](#)

Refer to the supplied safety manual for detailed safety information.

[Trademarks](#)

[▶ Troubleshooting](#)

How to Use

[Parts Description](#)

[Setup](#)

[Network / Internet](#)

[Connections](#)

[Settings](#)

[Playback](#)

[Backup / Recovery](#)

[Security](#)

[Other Operations](#)[Notifications](#)

Product registration

[About Online Support Website](#)

The online support website provides information about frequently asked questions about your VAIO computer.

[▶ Troubleshooting](#)

How to Use

[Parts Description](#)

[Setup](#)

[Network / Internet](#)

[Connections](#)

[Settings](#)

[Playback](#)

[Backup / Recovery](#)

[Security](#)

[Other Operations](#)

[Notifications](#)

Read this first

[Read This First](#)

Congratulations on your purchase of this VAIO(R) computer.

[▶ Troubleshooting](#)

How to Use

[Parts Description](#)

[Setup](#)

[Network / Internet](#)

[Connections](#)

[Settings](#)

[Playback](#)

[Backup / Recovery](#)

[Security](#)

[Other Operations](#)

[Notifications](#)

Security

[Updating Your VAIO Computer](#)

Be sure to update your VAIO computer with the following software applications to enhance the computer's efficiency, security, and functionality.

[▶ Troubleshooting](#)

How to Use

[Parts Description](#)

[Setup](#)

[Network / Internet](#)

[Connections](#)

[Settings](#)

[Playback](#)

[Backup / Recovery](#)

[Security](#)

[Other Operations](#)

[Notifications](#)

Service and support

[About Online Support Website](#)

The online support website provides information about frequently asked questions about your VAIO computer.

[Solving Common Problems with Your VAIO Computer](#)

If you have any problem operating your VAIO computer, try these suggestions before contacting an authorized Sony service/support center or your local Sony dealer directly.

[Updating Your VAIO Computer](#)

Be sure to update your VAIO computer with the following software applications to enhance the computer's efficiency, security, and functionality.

You might be looking for the following topics:

[Keeping Your VAIO Computer in Optimum Condition \(VAIO Care\)](#)

[Using VAIO Update](#)

[▶ Troubleshooting](#)

How to Use

[Parts Description](#)

[Setup](#)

[Network / Internet](#)

[Connections](#)

[Settings](#)

[Playback](#)

[Backup / Recovery](#)

[Security](#)

[Other Operations](#)[Notifications](#)

Supplied items

Checking Supplied Items

Check all items packed with the product before use.

[▶ Troubleshooting](#)

How to Use

[Parts Description](#)

[Setup](#)

[Network / Internet](#)

[Connections](#)

[Settings](#)

[Playback](#)

[Backup / Recovery](#)

[Security](#)

[Other Operations](#)

[Notifications](#)

VAIO computer

[Checking Supplied Items](#)

Check all items packed with the product before use.

[Setting Up an Appropriate Work Environment](#)

This topic describes where to or not to place your VAIO computer and ergonomic instructions.

[Updating Your VAIO Computer](#)

Be sure to update your VAIO computer with the following software applications to enhance the computer's efficiency, security, and functionality.

You might be looking for the following topics:

[About the ASSIST Button](#)[Adding and Removing Memory Modules](#)[Booting Your VAIO Computer from External Devices](#)[Customizing Your VAIO Computer](#)[Keeping Your VAIO Computer in Optimum Condition \(VAIO Care\)](#)[Notes on Adding and Removing Memory Modules](#)[Parts and Controls on the Back](#)[Parts and Controls on the Front](#)[Parts and Controls on the Sides](#)[Setting the Stand](#)[Using VAIO Update](#)[Viewing the System Information](#)

[▶ How to Use](#)

Troubleshooting

Hardware

Software

Network / Internet

Backup / Recovery

Security

Peripheral Devices

Hardware

Audio

BLUETOOTH

CD/DVD/BD

Computer

Floppy disk

LAN

Microphone

Power

Software

Wireless LAN

BIOS

Battery

Camera

Display

Keyboard

Memory card

Password

Sensor

USB

[▶ How to Use](#)**Troubleshooting****Hardware**

Software

Network / Internet

Backup / Recovery

Security

Peripheral Devices

Audio[What should I do if I do not hear sound from speakers or headphones?](#)[What should I do if I hear microphone feedback from speakers when using my microphone?](#)[What should I do if my microphone does not work?](#)[What should I do if sound interruptions occur during video or audio playback?](#)

[▶ How to Use](#)

Troubleshooting

Hardware

Software

Network / Internet

Backup / Recovery

Security

Peripheral Devices

BIOS

What should I do if I forget the power-on password to start my VAIO computer?

[▶ How to Use](#)

Troubleshooting

Hardware

Software

Network / Internet

Backup / Recovery

Security

Peripheral Devices

BLUETOOTH

[What should I do if I cannot find the BLUETOOTH\(R\) device I want to communicate with?](#)

[What should I do if I cannot use the BLUETOOTH\(R\) function?](#)

[What should I do if other BLUETOOTH\(R\) devices cannot connect to my VAIO computer?](#)

[What should I do if the BLUETOOTH\(R\) icon is not displayed in the desktop notification area?](#)

[Why can't I exchange business card data with a smartphone or a mobile phone?](#)

[Why can't I use BLUETOOTH\(R\) devices when I switch users?](#)

[Why can't I use the BLUETOOTH\(R\) function when I log onto my VAIO computer as a user with a standard user account?](#)

[Why is my BLUETOOTH\(R\) connection slow?](#)

[▶ How to Use](#)

Troubleshooting

Hardware

Software

Network / Internet

Backup / Recovery

Security

Peripheral Devices

Battery

What should I do if a message appears indicating that the battery pack is incompatible or has been incorrectly installed, after which my VAIO computer enters Hibernate mode?

Why can't I fully charge my battery pack?

Why doesn't my VAIO computer enter Hibernate mode when the battery pack is running out of power?

Why is my VAIO computer running slowly and the CPU clock frequency low while the computer is running on battery power?

[▶ How to Use](#)**Troubleshooting****Hardware**

Software

Network / Internet

Backup / Recovery

Security

Peripheral Devices

CD/DVD/BD[What should I do if I cannot play a disc, or dropped frames and/or sound interruptions occur during playback?](#)[What should I do if I cannot remove the disc from the optical disc drive?](#)[Why can't I write data to a disc?](#)[Why does it take time to write data to DVD writable media?](#)

[▶ How to Use](#)**Troubleshooting**[Hardware](#)[Software](#)[Network / Internet](#)[Backup / Recovery](#)[Security](#)[Peripheral Devices](#)**Camera**[What should I do if captured images contain dropped frames and audio interruptions?](#)[What should I do if captured images flicker?](#)[Why are captured images poor in quality?](#)[Why does the viewfinder show no images or poor-quality images?](#)[Why is the video input from the built-in camera suspended momentarily?](#)

[▶ How to Use](#)

Troubleshooting

Hardware

Software

Network / Internet

Backup / Recovery

Security

Peripheral Devices

Computer

[Why does the System Properties window display a slower CPU speed than the maximum?](#)

[Why is my VAIO computer running slowly and the CPU clock frequency low while the computer is running on battery power?](#)

[▶ How to Use](#)**Troubleshooting**[Hardware](#)[Software](#)[Network / Internet](#)[Backup / Recovery](#)[Security](#)[Peripheral Devices](#)

Display

[How do I change the LCD brightness?](#)[What should I do if I cannot see proper images on the computer screen?](#)[What should I do if captured images contain dropped frames and audio interruptions?](#)[What should I do if captured images flicker?](#)[What should I do if my computer screen goes blank?](#)[What should I do if some items do not fit on the computer screen?](#)[What should I do if videos are not displayed on the computer screen?](#)[What should I do if videos are not displayed smoothly?](#)[Why do sound interruptions and/or dropped frames occur when I play high-definition videos, such as those recorded with the AVCHD digital video camcorder?](#)[Why does the viewfinder show no images or poor-quality images?](#)

[▶ How to Use](#)

Troubleshooting

Hardware

Software

Network / Internet

Backup / Recovery

Security

Peripheral Devices

Floppy disk

[What should I do if I cannot boot my VAIO computer from the floppy disk drive?](#)

You might be looking for the following topics:

[What should I do if I cannot remove my floppy disk?](#)

[What should I do if I cannot save data on my floppy disk?](#)

[What should I do if my VAIO computer does not recognize the floppy disk?](#)

[▶ How to Use](#)**Troubleshooting****Hardware**

Software

Network / Internet

Backup / Recovery

Security

Peripheral Devices

Keyboard

[What should I do if I cannot enter certain characters with my keyboard?](#)[What should I do if my keyboard configuration is wrong?](#)

[▶ How to Use](#)

Troubleshooting

Hardware

Software

Network / Internet

Backup / Recovery

Security

Peripheral Devices

LAN

How can I find the physical address (MAC address) of the built-in wireless network interface of my VAIO computer?

What should I do if I cannot connect my VAIO computer to an access point (or the Internet)?

What should I do if I cannot play back movies or audio tracks received via Wi-Fi (wireless LAN), or their playback is interrupted? Why is the data transfer speed slow?

What should I do if I cannot use the Wi-Fi (wireless LAN) function?

What should I do if I do not know the SSID or security key for the access point?

What should I do if the text size on the website is small or large?

What should I do if the website is not displayed?

[▶ How to Use](#)

Troubleshooting

Hardware

Software

Network / Internet

Backup / Recovery

Security

Peripheral Devices

Memory card

[Why can't I write data to a memory card?](#)[Why doesn't the memory card icon appear in the Computer window?](#)[Why doesn't the "Memory Stick" icon appear in the Computer window?](#)

[▶ How to Use](#)

Troubleshooting

Hardware

Software

Network / Internet

Backup / Recovery

Security

Peripheral Devices

Microphone

[What should I do if I hear microphone feedback from speakers when using my microphone?](#)

[What should I do if my microphone does not work?](#)

[▶ How to Use](#)**Troubleshooting****Hardware**

Software

Network / Internet

Backup / Recovery

Security

Peripheral Devices

Password[What should I do if I forget the Windows password?](#)[What should I do if I forget the power-on password to start my VAIO computer?](#)[What should I do if the Enter Onetime Password message appears and Windows does not start after I enter a wrong power-on password three times consecutively?](#)

[▶ How to Use](#)

Troubleshooting

Hardware

Software

Network / Internet

Backup / Recovery

Security

Peripheral Devices

Power

[What should I do if I cannot turn off my VAIO computer?](#)

[What should I do if VAIO Care Rescue Mode starts when I turn on my VAIO computer?](#)

[What should I do if my VAIO computer does not enter Hibernate mode?](#)

[What should I do if my VAIO computer does not enter Sleep mode?](#)

[What should I do if my VAIO computer does not turn on \(the power indicator light does not turn on in green\)?](#)

[What should I do if my VAIO computer does not turn on or the power button does not work \(the power indicator light blinks fast\)?](#)

[What should I do if the power indicator light turns on in green when I press the power button but the screen remains blank?](#)

[Why does a message appear and Windows fail to start when I turn on my VAIO computer?](#)

[Why does my VAIO computer automatically turn off?](#)

[Why doesn't my VAIO computer enter Hibernate mode when the battery pack is running out of power?](#)

[Why doesn't my computer screen turn off after the automatic turn-off time has passed?](#)

[▶ How to Use](#)

Troubleshooting

[Hardware](#)[Software](#)[Network / Internet](#)[Backup / Recovery](#)[Security](#)[Peripheral Devices](#)

Sensor

[Why doesn't the built-in digital compass show the correct direction?](#)[Why doesn't the computer screen rotate?](#)

[▶ How to Use](#)

Troubleshooting

Hardware

Software

Network / Internet

Backup / Recovery

Security

Peripheral Devices

Software

Why do sound interruptions and/or dropped frames occur when I play high-definition videos, such as those recorded with the AVCHD digital video camcorder?

You might be looking for the following topics:

[What should I do if my game software does not work or it keeps crashing?](#)

[▶ How to Use](#)

Troubleshooting

Hardware

Software

Network / Internet

Backup / Recovery

Security

Peripheral Devices

USB

[What should I do if I cannot boot my VAIO computer from the floppy disk drive?](#)

[What should I do if I cannot charge the device connected to the USB port that supports USB charging?](#)

You might be looking for the following topics:

[What should I do if I cannot print a document?](#)

[What should I do if I cannot remove my floppy disk?](#)

[What should I do if I cannot save data on my floppy disk?](#)

[What should I do if my VAIO computer does not recognize the USB device?](#)

[What should I do if my VAIO computer does not recognize the floppy disk?](#)

[▶ How to Use](#)

Troubleshooting

Hardware

Software

Network / Internet

Backup / Recovery

Security

Peripheral Devices

Wireless LAN

How can I find the physical address (MAC address) of the built-in wireless network interface of my VAIO computer?

What should I do if I cannot connect my VAIO computer to an access point (or the Internet)?

What should I do if I cannot play back movies or audio tracks received via Wi-Fi (wireless LAN), or their playback is interrupted? Why is the data transfer speed slow?

What should I do if I cannot use the Wi-Fi (wireless LAN) function?

What should I do if I do not know the SSID or security key for the access point?

What should I do if the text size on the website is small or large?

What should I do if the website is not displayed?

[▶ How to Use](#)

Troubleshooting

Hardware

Software

Network / Internet

Backup / Recovery

Security

Peripheral Devices

Software

[Display](#)

[Software](#)

[▶ How to Use](#)

Troubleshooting

[Hardware](#)[Software](#)[Network / Internet](#)

[Backup / Recovery](#)

[Security](#)

[Peripheral Devices](#)

Display

[Why do sound interruptions and/or dropped frames occur when I play high-definition videos, such as those recorded with the AVCHD digital video camcorder?](#)

You might be looking for the following topics:

[How do I change the LCD brightness?](#)

[What should I do if I cannot see proper images on the computer screen?](#)

[What should I do if captured images contain dropped frames and audio interruptions?](#)

[What should I do if captured images flicker?](#)

[What should I do if my computer screen goes blank?](#)

[What should I do if some items do not fit on the computer screen?](#)

[What should I do if videos are not displayed on the computer screen?](#)

[What should I do if videos are not displayed smoothly?](#)

[Why does the viewfinder show no images or poor-quality images?](#)

[▶ How to Use](#)

Troubleshooting

[Hardware](#)[Software](#)[Network / Internet](#)

[Backup / Recovery](#)

[Security](#)

[Peripheral Devices](#)

Software

[What should I do if my game software does not work or it keeps crashing?](#)

[Why do sound interruptions and/or dropped frames occur when I play high-definition videos, such as those recorded with the AVCHD digital video camcorder?](#)

[▶ How to Use](#)

Troubleshooting

Hardware

Software

Network / Internet

Backup / Recovery

Security

Peripheral Devices

Network / Internet

[BLUETOOTH](#)

[LAN](#)

[Wireless LAN](#)

[▶ How to Use](#)**Troubleshooting**

[Hardware](#)

[Software](#)[Network / Internet](#)[Backup / Recovery](#)

[Security](#)

[Peripheral Devices](#)

BLUETOOTH

[What should I do if I cannot find the BLUETOOTH\(R\) device I want to communicate with?](#)

[What should I do if I cannot use the BLUETOOTH\(R\) function?](#)

[What should I do if other BLUETOOTH\(R\) devices cannot connect to my VAIO computer?](#)

[What should I do if the BLUETOOTH\(R\) icon is not displayed in the desktop notification area?](#)

[Why can't I exchange business card data with a smartphone or a mobile phone?](#)

[Why can't I use BLUETOOTH\(R\) devices when I switch users?](#)

[Why can't I use the BLUETOOTH\(R\) function when I log onto my VAIO computer as a user with a standard user account?](#)

[Why is my BLUETOOTH\(R\) connection slow?](#)

[▶ How to Use](#)

Troubleshooting

[Hardware](#)

[Software](#)[Network / Internet](#)[Backup / Recovery](#)

[Security](#)

[Peripheral Devices](#)

LAN

[How can I find the physical address \(MAC address\) of the built-in wireless network interface of my VAIO computer?](#)

[What should I do if I cannot connect my VAIO computer to an access point \(or the Internet\)?](#)

[What should I do if I cannot play back movies or audio tracks received via Wi-Fi \(wireless LAN\), or their playback is interrupted? Why is the data transfer speed slow?](#)

[What should I do if I cannot use the Wi-Fi \(wireless LAN\) function?](#)

[What should I do if I do not know the SSID or security key for the access point?](#)

[What should I do if the text size on the website is small or large?](#)

[What should I do if the website is not displayed?](#)

[▶ How to Use](#)**Troubleshooting**

[Hardware](#)

[Software](#)[Network / Internet](#)[Backup / Recovery](#)

[Security](#)

[Peripheral Devices](#)

Wireless LAN

[How can I find the physical address \(MAC address\) of the built-in wireless network interface of my VAIO computer?](#)

[What should I do if I cannot connect my VAIO computer to an access point \(or the Internet\)?](#)

[What should I do if I cannot play back movies or audio tracks received via Wi-Fi \(wireless LAN\), or their playback is interrupted? Why is the data transfer speed slow?](#)

[What should I do if I cannot use the Wi-Fi \(wireless LAN\) function?](#)

[What should I do if I do not know the SSID or security key for the access point?](#)

[What should I do if the text size on the website is small or large?](#)

[What should I do if the website is not displayed?](#)

[▶ How to Use](#)

Troubleshooting

Hardware

Software

Network / Internet

Backup / Recovery

Security

Peripheral Devices

Backup / Recovery

[Floppy disk](#)

[Recovery](#)

[USB](#)

[▶ How to Use](#)

Troubleshooting

[Hardware](#)

[Software](#)

[Network / Internet](#)

[Backup / Recovery](#)

[Security](#)

[Peripheral Devices](#)

Floppy disk

[What should I do if I cannot boot my VAIO computer from the floppy disk drive?](#)

You might be looking for the following topics:

[What should I do if I cannot remove my floppy disk?](#)

[What should I do if I cannot save data on my floppy disk?](#)

[What should I do if my VAIO computer does not recognize the floppy disk?](#)

[▶ How to Use](#)

Troubleshooting

[Hardware](#)

[Software](#)

[Network / Internet](#)

[Backup / Recovery](#)

[Security](#)

[Peripheral Devices](#)

Recovery

[How can I reinstall the original software and drivers?](#)[How can I restore my VAIO computer system to its factory default settings?](#)[How do I create Recovery Media?](#)[What should I do if I cannot complete the recovery process?](#)[What should I do if I cannot create Recovery Media?](#)[What should I do if I cannot recover my VAIO computer from the recovery area?](#)[What should I do if my VAIO computer becomes unstable \(Windows does not start\)?](#)[What should I do if my VAIO computer becomes unstable \(Windows starts\)?](#)

[▶ How to Use](#)

Troubleshooting

[Hardware](#)[Software](#)[Network / Internet](#)[Backup / Recovery](#)[Security](#)[Peripheral Devices](#)

USB

[What should I do if I cannot boot my VAIO computer from the floppy disk drive?](#)

You might be looking for the following topics:

[What should I do if I cannot charge the device connected to the USB port that supports USB charging?](#)

[What should I do if I cannot print a document?](#)

[What should I do if I cannot remove my floppy disk?](#)

[What should I do if I cannot save data on my floppy disk?](#)

[What should I do if my VAIO computer does not recognize the USB device?](#)

[What should I do if my VAIO computer does not recognize the floppy disk?](#)

[▶ How to Use](#)

Troubleshooting

Hardware

Software

Network / Internet

Backup / Recovery

Security

Peripheral Devices

Security

[BIOS](#)

[Password](#)

[▶ How to Use](#)**Troubleshooting**

[Hardware](#)

[Software](#)

[Network / Internet](#)

[Backup / Recovery](#)

[Security](#)

[Peripheral Devices](#)

BIOS

[What should I do if I forget the power-on password to start my VAIO computer?](#)

[▶ How to Use](#)

Troubleshooting

[Hardware](#)

[Software](#)

[Network / Internet](#)

[Backup / Recovery](#)

[Security](#)

[Peripheral Devices](#)

Password

[What should I do if I forget the Windows password?](#)[What should I do if I forget the power-on password to start my VAIO computer?](#)[What should I do if the Enter Onetime Password message appears and Windows does not start after I enter a wrong power-on password three times consecutively?](#)

[▶ How to Use](#)

Troubleshooting

[Hardware](#)

[Software](#)

[Network / Internet](#)

[Backup / Recovery](#)

[Security](#)

[Peripheral Devices](#)

Peripheral Devices

[Floppy disk](#)

[Printer](#)

[USB](#)

[▶ How to Use](#)

Troubleshooting

[Hardware](#)

[Software](#)

[Network / Internet](#)

[Backup / Recovery](#)

[Security](#)

[Peripheral Devices](#)

Floppy disk

[What should I do if I cannot boot my VAIO computer from the floppy disk drive?](#)

[What should I do if I cannot remove my floppy disk?](#)

[What should I do if I cannot save data on my floppy disk?](#)

[What should I do if my VAIO computer does not recognize the floppy disk?](#)

[▶ How to Use](#)

Troubleshooting

Hardware

Software

Network / Internet

Backup / Recovery

Security

Peripheral Devices

Printer

[What should I do if I cannot print a document?](#)

[▶ How to Use](#)

Troubleshooting

Hardware

Software

Network / Internet

Backup / Recovery

Security

Peripheral Devices

USB

[What should I do if I cannot boot my VAIO computer from the floppy disk drive?](#)

[What should I do if I cannot print a document?](#)

[What should I do if I cannot remove my floppy disk?](#)

[What should I do if I cannot save data on my floppy disk?](#)

[What should I do if my VAIO computer does not recognize the USB device?](#)

[What should I do if my VAIO computer does not recognize the floppy disk?](#)

You might be looking for the following topics:

[What should I do if I cannot charge the device connected to the USB port that supports USB charging?](#)
