

Thank you for purchasing a Sony Ericsson Z555a.  
Discover gesture control. Show it off.

For additional phone content, go to  
[www.sonyericsson.com/fun](http://www.sonyericsson.com/fun).

Register now to get a suite of tools, free online  
storage, special offers, news and competitions  
at [www.sonyericsson.com/myphone](http://www.sonyericsson.com/myphone).

For product support, go to [www.sonyericsson.com/support](http://www.sonyericsson.com/support).

## Accessories – More for your Phone

### Bluetooth™ Car Speakerphone HCB-105

A portable handsfree solution for use  
in the car



### Bluetooth Headset HBH-PV770

A lightweight headset with high  
performance



### Design Collection IDC-22

Phone case in soft leather with  
integrated mirror



These accessories can be purchased separately but  
may not be available in every market. To view the  
full range go to [www.sonyericsson.com/accessories](http://www.sonyericsson.com/accessories).

## Contents

<b>Getting Started</b> .....	<b>5</b>	Voicemail .....	23
Assembly .....	5	Forwarding Calls .....	23
Turning on the Phone .....	6	More than One Call .....	24
Making and Receiving Calls .....	7	Conference Calls .....	25
Help in your Phone .....	7	My Numbers .....	25
Charging the Battery .....	8	Accept Calls .....	25
Phone Overview .....	9	Restricted Dialing .....	26
Menu Overview .....	11	Fixed Dialing .....	26
Navigation .....	13	Call Time and Cost .....	26
Shortcuts .....	14	Business Cards .....	27
Activity Menu .....	15	<b>Messaging</b> .....	<b>27</b>
File Manager .....	15	Text Messages .....	27
Phone Language .....	17	Picture Messages .....	29
Entering Text .....	18	Templates .....	30
<b>Calling</b> .....	<b>19</b>	Voice Messages .....	31
Making and Receiving Calls .....	19	Email .....	31
Emergency Calls .....	19	My Friends .....	34
Contacts .....	20	Area and Cell Information .....	35
Groups .....	22	<b>Imaging</b> .....	<b>36</b>
Call List .....	22	Camera .....	36
Speed Dial .....	23	Transferring Pictures .....	37
		Pictures .....	38

<b>Entertainment .....</b>	<b>39</b>	Tasks .....	55
Stereo Portable Handsfree .....	39	Notes .....	55
Transferring Music from a Computer .....	39	Timer, Stopwatch and Calculator .....	56
Radio .....	40	Code Memo .....	56
PlayNow™ .....	40	Profiles .....	57
Ringtones and Melodies .....	41	Time and Date .....	58
MusicDJ™ .....	42	Themes .....	58
Sound Recorder .....	42	Locks .....	58
Video Player .....	43	IMEI Number .....	59
Games .....	43	<b>Troubleshooting .....</b>	<b>60</b>
Applications .....	43	Common Questions .....	60
<b>Connectivity .....</b>	<b>44</b>	Error Messages .....	61
Settings .....	44	<b>Important Information .....</b>	<b>63</b>
Using Internet .....	44	Guidelines for Safe and Efficient Use .....	65
RSS Reader .....	46	Limited Warranty .....	69
Bluetooth™ Wireless Technology .....	46	FCC Statement .....	72
Using the USB Cable .....	49	Declaration of Conformity for Z555a .....	72
PC Suite .....	50	<b>Index .....</b>	<b>73</b>
Synchronizing .....	50		
Update Service .....	51		
<b>More Features .....</b>	<b>52</b>		
Gesture Control .....	52		
Alarms .....	53		
Calendar .....	53		

## Sony Ericsson Z555a

GSM 850/1800/1900

This User guide is published by Sony Ericsson Mobile Communications AB or its local affiliated company, without any warranty. Improvements and changes to this User guide necessitated by typographical errors, inaccuracies of current information, or improvements to programs and/or equipment, may be made by Sony Ericsson Mobile Communications AB or its local affiliated company at any time and without notice. Such changes will, however, be incorporated into new editions of this User guide.

All rights reserved.

©Sony Ericsson Mobile Communications AB, 2007

Publication number: 1205-9962.1

Please note:

Some of the services in this User guide are not supported by all networks. *This also applies to the GSM International Emergency Number 112.*

Please contact your network operator or service provider if you are in doubt whether you can use a particular service or not.

Please read the *Guidelines for safe and efficient use* and the *Limited warranty* chapters before you use your phone.

Your phone has the capability to download, store and forward additional content, for example ringtones. The use of such content may be restricted or prohibited by rights of third parties, including but not limited to restriction under applicable copyright laws. You, and not Sony Ericsson, are entirely responsible for additional content that you download to or forward from your phone. Prior to your use of any additional content, please verify that your intended use is properly licensed or is otherwise authorized. Sony Ericsson does not guarantee the accuracy, integrity or quality of any additional content or any other third party content. Under

no circumstances will Sony Ericsson be liable in any way for your improper use of additional content or other third party content.

Bluetooth is a trademark or registered trademark of Bluetooth SIG Inc. and any use of such mark by Sony Ericsson is under license.

The Liquid Identity logo, PlayNow and MusicDJ are trademarks or registered trademarks of Sony Ericsson Mobile Communications AB.

Sony, Memory Stick Micro and M2 are trademarks or registered trademarks of Sony Corporation.

Ericsson is a trademark or registered trademark of Telefonaktiebolaget LM Ericsson.

Adobe and Photoshop are trademarks or registered trademarks of Adobe Systems Incorporated in the United States and/or other countries.

Microsoft, Windows, Outlook and Vista are trademarks or registered trademarks of Microsoft Corporation in the United States and/or other countries.

T9™ Text Input is a trademark or a registered trademark of Tegic Communications. T9™ Text Input is licensed under one or more of the following: U.S. Pat. Nos. 5,818,437, 5,953,541, 5,187,480, 5,945,928, and 6,011,554; Canadian Pat. No. 1,331,057, United Kingdom Pat. No. 2238414B; Hong Kong Standard Pat. No. HK0940329; Republic of Singapore Pat. No. 51383; Euro.Pat. No. 0 842 463(96927260.8) DE/DK, FI, FR, IT, NL, PT, ES, SE, GB; and additional patents are pending worldwide.

Java and all Java based trademarks and logos are trademarks or registered trademarks of Sun Microsystems, Inc. in the U.S. and other countries.

End-user license agreement for Sun™ Java™ J2ME™.

Restrictions: Software is confidential copyrighted information of Sun and title to all copies is retained by Sun and/or its licensors. Customer shall not modify, decompile, disassemble, decrypt, extract, or otherwise reverse engineer Software. Software may not be leased, assigned, or sublicensed, in whole or in part.

Export Regulations: Software, including technical data, is subject to U.S. export control laws, including the U.S. Export Administration Act and its associated regulations, and may be subject to export or import regulations in other countries. Customer agrees to comply strictly with all such regulations and acknowledges that it has the responsibility to obtain licenses to export, re-export, or import Software. Software may not be downloaded, or otherwise exported or re-exported (i) into, or to a national or resident of, Cuba, Iraq, Iran, North Korea, Libya, Sudan, Syria (as such listing may be revised from time to time) or any country to which the U.S. has embargoed goods; or (ii) to anyone on the U.S. Treasury Department's list of Specially Designated Nations or the U.S. Commerce Department's Table of Denial Orders. Restricted Rights: Use, duplication or disclosure by the United States government is subject to the restrictions as set forth in the Rights in Technical Data and Computer Software Clauses in DFARS 252.227-7013(c) (1) (ii) and FAR 52.227-19(c) (2) as applicable. Other product and company names mentioned herein may be the trademarks of their respective owners. Any rights not expressly granted herein are reserved. All illustrations are for illustration only and may not accurately depict the actual phone.

## Instruction Symbols

The following appear in the User guide.

 Note

 Tip

 Warning

 A service or function is network- or subscription-dependent. Contact your network operator for details.

> Use a selection or navigation key to scroll and select. See *Navigation* on page 13.

 Press the navigation key center.

 Press the navigation key up.

 Press the navigation key down.

 Press the navigation key left.

 Press the navigation key right.

## Getting Started

### Assembly

Before you start using your phone, you need to insert a SIM card and the battery.

#### To insert the SIM card



- 1 Remove the battery cover.
- 2 Slide the SIM card into its holder with the contacts facing down.

#### To insert the battery



- 1 Insert the battery with the label side up and the connectors facing each other.
- 2 Replace the battery cover.

## Turning on the Phone

### To turn on the phone



- 1 Press and hold down **(⓪)**.
- 2 Enter your SIM card PIN, if requested.
- 3 Select a language.
- 4 Select **Yes** to use the setup wizard.

! *If you make a mistake when you enter your PIN, you can press **(C)** to delete numbers from the screen.*

#### SIM card

The SIM (Subscriber Identity Module) card, which you get from your network operator, contains information about your subscription. Always turn off your phone and detach the charger before you insert or remove the SIM card.

! *You can save contacts on the SIM card before you remove it from your phone. See *To copy names and numbers to the SIM card* on page 21.*

#### PIN

You may need a PIN (Personal Identification Number) to activate the services in your phone. Your PIN is supplied by your network operator. Each PIN digit appears as \*, unless it starts with emergency number digits, for example, 112 or 911. You can see and call an emergency number without entering a PIN.

#### To delete numbers from the display

- Press **(C)**.

! *If you enter the wrong PIN three times in a row, **PIN Blocked** appears. To unblock it, you need to enter your PUK (Personal Unblocking Key). See *SIM card lock* on page 58.*

#### Startup screen

The startup screen appears when you turn your phone on. See *Using pictures* on page 38.



### Standby

After you have turned your phone on and entered your PIN, the name of the network operator appears on the screen. This is called standby.

### Making and Receiving Calls

You must turn on your phone and be within range of a network.

#### *To make a call*

- 1 From standby enter a phone number (with international country code and area code, if applicable).
- 2 Select **Call**.

#### *To answer a call*

- Select **Answer**.

#### *To reject a call*

- Select **Busy**.

### Help in your Phone

Help and information is available in your phone at any time. See *Navigation* on page 13.

#### *To use the setup wizard*

- 1 From standby select **Menu > Settings > the General tab > Setup Wizard**.
- 2 Select an option.

#### *To view information about functions*

- Scroll to a function and select **Info**, if available. In some cases, **Info** appears under **More**.

#### *To view the phone demonstration*

- From standby select **Menu > Entertainment > Demo Tour**.

#### **Settings download**

You can download settings to your phone. These settings let you use functionality that require Internet accounts, for example, picture messaging and email.

#### *To download settings*

- From standby select **Menu > Settings > the General tab > Setup Wizard > Settings Download**.

! *Contact your network operator or service provider for more information.*

### Charging the Battery

The phone battery is partly charged when you buy it.

#### To charge the battery



- 1 Connect the charger to the phone. It takes approximately 2.5 hours to fully charge the battery.
- 2 Remove the charger by tilting the plug upwards.

💡 *You can use your phone while it is charging. You can charge the battery at any time and for more or less than 2.5 hours. You can interrupt the charging without damaging the battery.*

## Phone Overview

- 1 Screen
- 2 Selection key
- 3 Connector for charger, handsfree and USB cable
- 4 Back key
- 5 Internet key
- 6 On/off key
- 7 Selection key
- 8 Clear key
- 9 Activity menu key
- 10 Navigation key
- 11 Silent key

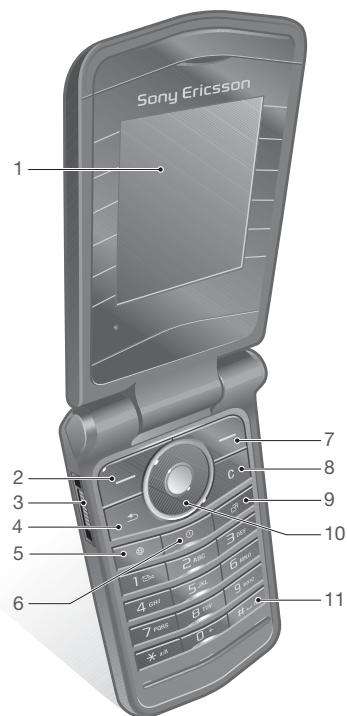

- 12 Gesture control light
- 13 Camera
- 14 Memory card slot (under the cover)
- 15 Volume buttons
- 16 External display

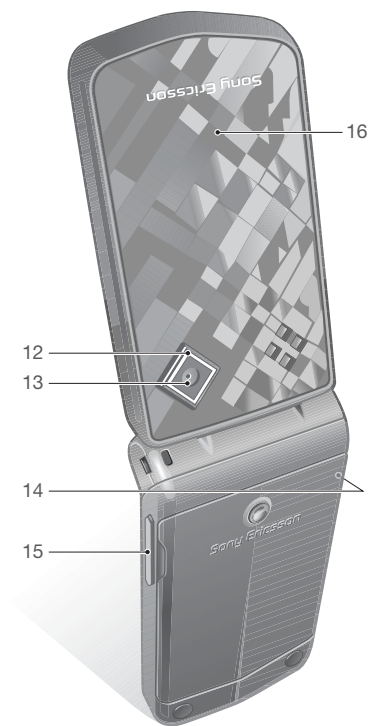

## 10 Getting Started

## Menu Overview



PlayNow™\*



Internet\*



Entertainment

Online Services\*  
Games  
Video Player  
MusicDJ™  
Record Sound  
Demo Tour



Camera



Messaging

Write New      Sent Messages  
Inbox            Saved Messages  
Email            My Friends\*  
RSS Reader    Call Voicemail  
Drafts           Templates  
Outbox           Settings



Music Player



File Manager\*\*



Contacts



Radio



Calls\*\*



All



Answered



Dialed



Missed



Organizer

Alarms  
Applications  
Calendar  
Tasks  
Notes  
Synchronization  
Timer  
Stopwatch  
Calculator  
Code Memo



## Settings\*\*



- General
- Profiles
- Time & Date
- Language
- Update Service
- Gesture control
- New Events
- Shortcuts
- Security
- Setup Wizard
- Phone Status
- Master Reset



- Sounds & Alerts
- Ring Volume
- Ringtone
- Silent Mode
- Increasing Ring
- Vibrating Alert
- Message Alert
- Key Sound



- Display
- Wallpaper
- Themes
- Startup Screen
- Screen Saver
- Brightness
- Edit Line Names\*



- Calls
- Speed Dial
- Forward Calls
- Switch to Line 2\*
- Manage Calls
- Time & Cost\*
- Show/Hide My No.
- Handsfree
- Open to Answer



- Connectivity
- Bluetooth
- USB Connection
- Synchronization
- Device Mgmt.
- Mobile Networks
- Data Comm.
- Internet Settings
- Accessories

\* Some menus are operator-, network- and subscription-dependent.

\*\* You can use the navigation key to scroll between tabs in submenus. For more information, see Navigation on page 13.

## Navigation

The main menus are shown as icons.  
Some submenus include tabs.

### To navigate the phone menus







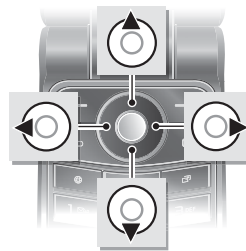

- 1 From standby select **Menu**.
- 2 Use the navigation key to move through the menus.

### To scroll between the tabs

- Scroll to a tab by pressing the navigation key left or right.



### Key

	Go to the main menus or select items
	Scroll between the menus and tabs
	Select options shown immediately above these keys on the screen
	Go back one level in the menus. Press and hold down to return to standby or end a function
	Delete items, such as pictures, sounds and contacts. Press and hold down to silence the microphone during a call
	Open the browser
	Turn the phone on/off
	Open the activity menu
	Press and hold down to call your voicemail service (if set)