

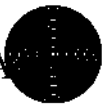

J220a

**Sony Ericsson**

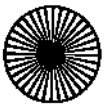

# Contents

Getting to know your phone . . . . .	4
Icons . . . . .	9
Menu overview . . . . .	11
Calling . . . . .	15
Messaging . . . . .	31
Personalizing your phone . . . . .	38
Internet . . . . .	46
More features . . . . .	55
Security . . . . .	58
Troubleshooting . . . . .	62
Additional information . . . . .	65
Index . . . . .	79

## Sony Ericsson

GSM 850/1900

This user guide is published by Sony Ericsson, without any warranty. Improvements and changes to this user guide necessitated by typographical errors, inaccuracies of current information, or improvements to programs and/or equipment, may be made by Sony Ericsson at any time and without notice. Such changes will, however, be incorporated into new editions of this user guide.

All rights reserved.

© Sony Ericsson Mobile Communications AB, 2005

Publication number: AE/LZT 108 8127 R1A

Please note:

Some of the services in this user guide are not supported by all networks. *This also applies to the GSM International Emergency Number 112.*

Please contact your network operator or service provider if you are in doubt whether you can use a particular service or not.

Please read the *Guidelines for safe and efficient use* and the *Limited warranty* chapters before you use your mobile phone.

T9™ Text Input is a trademark or a registered trademark of Tegic Communications.

T9™ Text Input is licensed under one or more of the following:

U.S. Pat. Nos. 5,818,437, 5,953,541, 5,187,480, 5,945,928, and 6,011,554;

Canadian Pat. No. 1,331,057;

United Kingdom Pat. No. 2238414B;

2

Hong Kong Standard Pat. No. HK0940329;  
Republic of Singapore Pat. No. 51383;  
Euro. Pat. No. 0 842 463 (96927260.8) DE/DK, FI, FR, IT,  
NL, PT, ES, SE, GB; and additional patents are pending  
worldwide.

Your mobile phone has the capability to download, store and forward additional content, e.g. ringtones. The use of such content may be restricted or prohibited by rights of third parties, including but not limited to restriction under applicable copyright laws. You, and not Sony Ericsson, are entirely responsible for additional content that you download to or forward from your mobile phone. Prior to your use of any additional content, please verify that your intended use is properly licensed or is otherwise authorized. Sony Ericsson does not guarantee the accuracy, integrity or quality of any additional content or any other third party content. Under no circumstances will Sony Ericsson be liable in any way for your improper use of additional content or other third party content.

Other product and company names may be the trademarks of their respective owners.

Sony Ericsson advises users to backup their personal data information.

All illustrations are for illustration only and may not accurately depict the actual phone.

Any rights not expressly granted herein are reserved.

## Getting to know your phone

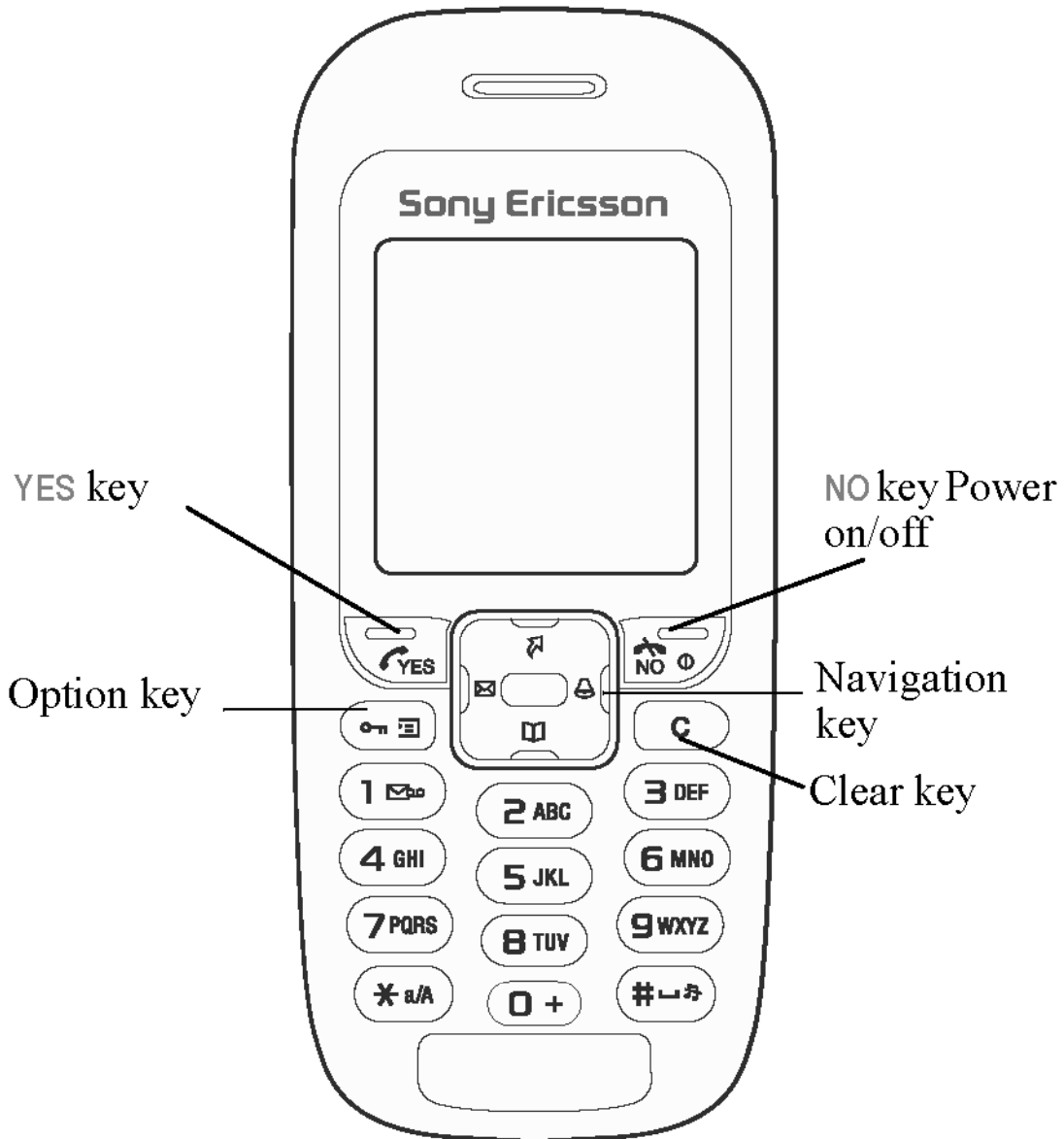

## Assembling your phone

Before you can use your phone you need to:

- Insert the SIM card.
- Attach and charge the battery.

## User guide symbols

The following symbols appear in this user guide:

▶ Use the navigation key to scroll and select.

➡ See also page.xx

 Important

 Note

 This symbol indicates that a service or function is network – or subscription-dependent. Because of this, all menus may not be available in your phone. Please consult your network operator for more information.

## SIM card and battery information

The SIM (Subscriber Identity Module) card, which you get from your network operator, contains information about your subscription and phonebook. Always turn off the phone and detach the charger before you insert or remove a SIM card.

 *If you have been using a SIM card in another phone, make sure that your information is saved to the SIM card before you remove it from the other phone.*

➡ *17 Phonebook.*

## To insert the SIM card and battery

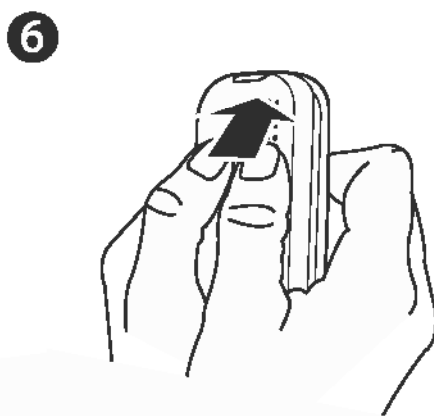
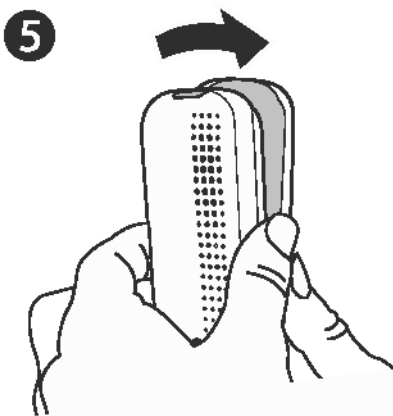
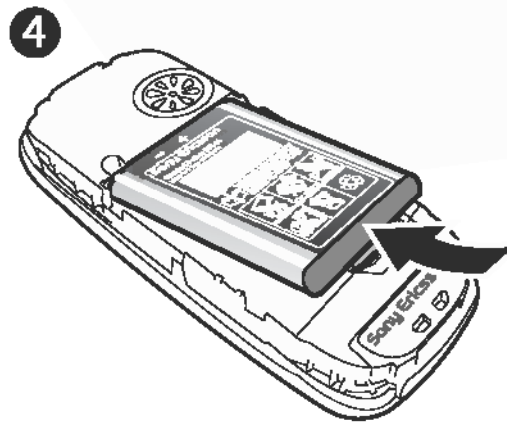
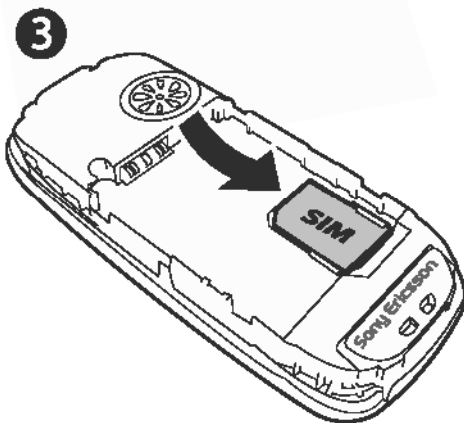
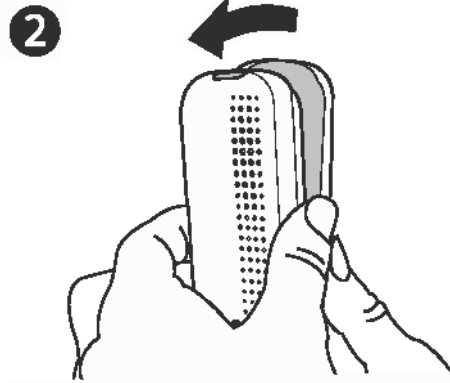
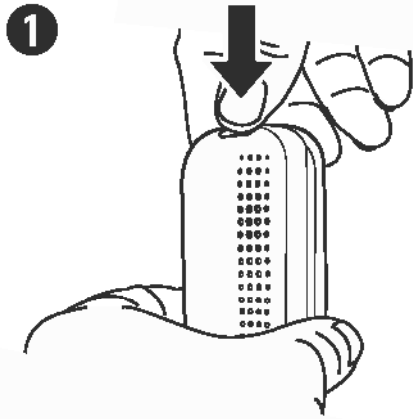

6



- 1** Press to release the cover as shown in the picture.
- 2** Gently pull the cover away from the phone.
- 3** Insert the SIM card. Make sure the SIM card is placed under the silvery holders.
- 4** Place the battery on the back of the phone with the label side up and the connectors facing each other.
- 5** Replace the cover as shown in the picture.
- 6** Press to close the cover.

### ***To charge the battery***

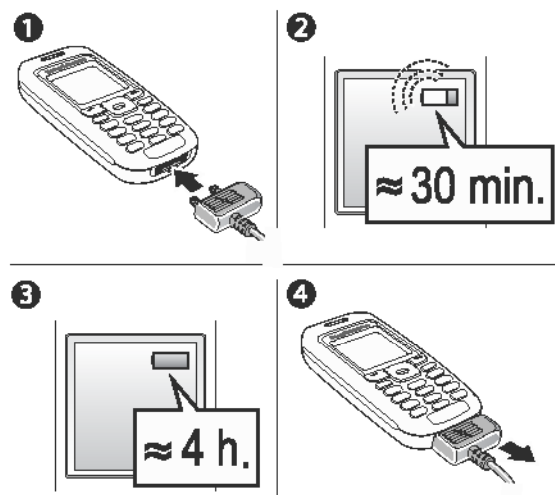



- 1** Connect the charger to the phone. The flash symbol on the charger plug must face upwards.
- 2** It may take up to 30 minutes before the battery icon appears on the screen.
- 3** Wait approximately 4 hours or until the battery icon indicates that the battery is fully charged. If you do not see the battery icon after this time, press any key to activate the screen.
- 4** Remove the charger by pulling it out.

 *The time and date are reset when you remove the battery.*

## PIN

You may need a PIN (Personal Identification Number) to activate the services in your phone. Your PIN is provided by your network operator.

If you make a mistake while entering your PIN, delete the number by pressing **(C)**.

 *If you enter the wrong PIN three times in a row, the SIM card is blocked and the message PIN blocked appears. To unblock it, you need to enter your PUK (Personal Unblocking Key),  58 SIM card lock.*

### ***To turn the phone on and off***



- Press and hold **(P)**.
- Enter your PIN, if requested.
- Press and hold **(P)** to turn off the phone.

### ***To make and receive calls***

- Enter the area code and phone number ► YES to make the call.
- ► NO to end the call.
- When the phone rings, ► YES.

## Icons

The following icons appear on the desktop and in the status bar.



Tells you the status of the battery.



Tells you the strength of the GSM network signal.



**Calls** – Handling of call time, call cost information and ongoing calls.



**Internet Services** – Gives you access to Internet services.



**Alarms** – Alarm clock and recurrent alarm.



**Fun & Games** – Games and applications.



**Messaging** – Handling of text (SMS), picture (MMS) and voice messages.



**Silent** – Set the phone to silent. The alarm clock rings even if the phone is set to silent.



**Organizer** – Calendar, tasks, timer and other extras.



**Phonebook** – Your personal phonebook.



**Settings** – Personal settings including profiles, display, language, connectivity, time and locks.

## Main menu view

Change the main menu view from multiple to single icons.

### *To change the main menu view*

- 1 ▶ Settings ▶ YES ▶ Display ▶ YES ▶ Main Menu View ▶ YES.
- 2 Select **Grid View** or **List View**.

## Navigating the menus

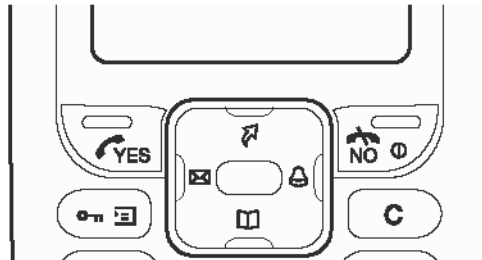

- Press (navigation key) to go to the desktop.
- Press to move through the menus.
- Press **NO** to go back one level in the menus.
- Press and hold **NO** to return to standby.

## Shortcuts

From standby, you can use the navigation key to go directly to a function.

- Press to write a message.
- Press to access **My Shortcuts**.
- Press to set an alarm.
- Press to enter the phonebook.

### *To create a shortcut*

- 1 ▶ Settings ▶ YES ▶ My Shortcuts ▶ YES ▶ Navig. key up ▶ YES.
- 2 Scroll to and select a shortcut ▶ YES.  
To access your shortcut, press .





## Menu overview

- |   |  |   |
|---|--|---|
| <p><b>1. Calls</b><br/>                     Missed Calls<br/>                     Call List<br/>                     Manage Calls<br/>                     Time &amp; Cost<br/>                     Switch to Line 2*<br/>                     Clear Call List</p>                    | <p><b>2. Internet Services</b><br/>                     Sony Ericsson<br/>                     Bookmarks<br/>                     Enter Address<br/>                     Push Inbox<br/>                     Options</p> | <p><b>3. Alarms</b><br/>                     Alarm<br/>                     Recurrent Alarm</p>   |
| <p><b>4. Fun &amp; Games</b><br/>                     Games<br/>                     My Pictures<br/>                     More Pictures<br/>                     My Sounds<br/>                     More Sounds<br/>                     Themes<br/>                     Composer</p> | <p><b>5. Messaging</b><br/>                     Text Message<br/>                     Picture Message<br/>                     Call Voicemail<br/>                     Options</p>                                       | <p><b>6. Silent</b><br/>                     Turn On Silent<br/>                     Silent off?</p>  |
| <p><b>7. Organizer</b><br/>                     Calendar<br/>                     Tasks<br/>                     Timer<br/>                     Stopwatch<br/>                     Calculator</p>   | <p><b>8. Phonebook</b><br/>                     Find and Call<br/>                     Add Number<br/>                     Find and Edit<br/>                     Memory Status<br/>                     Options</p>     | <p><b>9. Settings</b><br/>                     Sounds &amp; Alerts<br/>                     Time and Date<br/>                     Display<br/>                     Profiles<br/>                     Language<br/>                     Locks<br/>                     Handsfree<br/>                     Connect<br/>                     My Shortcuts<br/>                     Master Reset</p> |

*\* Network- and subscription- dependent.*



## Phone language

Most SIM cards automatically set the language used in the menu to the language of the country where you bought your SIM card. If this is not the case, the predefined language is English.

-  *You can always choose **Automatic** by pressing  8888  in standby mode.*
- You can always choose **English** by pressing  0000  in standby.*

### **To change the phone language**

- 1 ▶ **Settings** ▶ YES ▶ **Language** ▶ YES ▶ **Menus** ▶ YES.
- 2 Select a language ▶ YES.



-  *You can press  instead of the YES key to select an item.*

## More options

Press  to enter a list of options. There are different alternatives in the list of options depending on where you are in the menus.

## Delete and edit items

### **Two ways to delete items**

- Select an item and press .
- Select an item, press  ▶ **Delete**.

### **To edit items**

Select an item, press  ▶ **Edit**.

## Entering letters and characters

When writing messages and notes there are two ways to enter letters and characters:

- Multitap text input
- T9™ Text Input

### *To enter letters using multitap input*

- Press **[2]** - **[9]** until the desired character appears on the screen.
- Press **[\*a/A]** to shift between capital and lower-case letters.
- Press and hold **[0+]** - **[9]** to enter numbers.
- Press **[C]** to delete letters and numbers.
- Press **[1]** for the most common punctuation marks.
- Press **[#-#]** to add a space.

### **T9™ Text Input**

The T9™ Text Input method uses a built-in dictionary to recognize the most commonly used word for each sequence of key presses. This way, you press each key only once, even if the letter you want is not the first letter on the key.

### *To enter letters using T9 Text Input*

- 1 For example, if you want to write the word “Jane”, press **[5]**, **[2]**, **[6]**, **[3]**.
- 2 If the word shown is the one you want, press **[#-#]** to accept and add a space. To accept a word without adding a space, press **[>]**. If the word shown is not the one you want, press **[▲]** or **[▼]** repeatedly to view alternative words.
- 3 Continue writing your message. To enter a period or other punctuation marks, press **[1]** and then **[▲]** or **[▼]** repeatedly. Accept and add a space by pressing **[#-#]**.

### ***To switch between writing methods***

Before, or while entering letters, press and hold  to switch between writing methods.

### **Options list**

Press  to enter a list of options that offers different alternatives when writing a message.



## **Calling**

### **Making and receiving calls**

Before you can make or receive calls, you must turn on the phone and be within range of a network, ➤ *8 To turn the phone on and off.*

If your subscription includes the Calling Line Identification (Caller ID) service and the caller's number is identified, the number is displayed. If you have saved the number in the phonebook, the name and number are displayed. If the number is a restricted number, **Withheld** is displayed.

#### ***To make a call***

Enter the area code and phone number ► YES to make the call.  
► NO to end the call.

#### ***To re-dial a number***

If the connection failed and **Retry?** is displayed ► YES.

 *Do not hold the phone to your ear while waiting.  
When the call is connected, the phone gives a loud signal.*



#### ***To answer a call***

► YES.

#### ***To reject a call***

► NO.

#### ***To change the speaker volume during a call***

Press  or  to increase or decrease the speaker volume during a call.

### **To check your missed calls**

- 1 When **Missed calls:** is displayed, ► YES to display the missed calls.
- 2 To call a number, scroll to the number ► YES.

### **To make international calls**

- 1 Press and hold  until a + sign appears on the screen.
- 2 Enter the country code, area code (without the leading zero) and phone number ► YES.

## **Emergency calls**

Your phone supports the international emergency numbers, 112, 911 and 08. These numbers can normally be used to make an emergency call in any country, with or without a SIM card inserted, if a GSM network that supports these numbers is within range. Your network operator may have saved additional local emergency numbers on the SIM card.

### **To make an emergency call**

Enter, for example, 112 (the international emergency number) ► YES.

 *Some network operators may require that a SIM card is inserted, and in some cases that the PIN has been entered as well.*

### **To view your local emergency numbers**

► Phonebook ► YES ► Options ► YES ► Special Numbers  
► YES ► Emerg. Numbers ► YES.

## **Call list**

The numbers of the last calls that you have made or received are saved in the call list.

### ***To call a number from the call list***

► YES from standby and scroll to the name or number you want to call ► YES.

### ***To clear the call list***

► Calls ► YES ► Clear Call List ► YES.

## **Phonebook**

Your phone has a phonebook in which you can save numbers and accompanying names (an entry).

### ***To save a number together with a name***

- 1** ► Phonebook ► YES ► Add Number ► YES.
- 2** Select **Add New** to enter the phone number that you want to save, or select any numbers from the list by pressing YES.
- 3** Enter a name that you want to associate with the phone number ► YES, ➡ *13 Entering letters and characters*.
- 4** ► YES again to save the entry in the suggested position.

## **Pictures and personal rings**

You can add a picture and a ringtone to phonebook entries.



### ***To add a picture to a phonebook entry***

- 1** ► Phonebook ► YES ► Options ► YES ► Picture ► YES.
- 2** ► Add New ► YES.
- 3** ► YES to go to the phonebook. Scroll to the phonebook entry you want ► YES.
- 4** This takes you to **Picture**. Select a picture ► YES.



### ***To add a ringtone to a phonebook entry***

- 1 ▶ Phonebook ▶ YES ▶ Options ▶ YES ▶ Personal Rings  
▶ YES.
- 2 ▶ Add New ▶ YES.
- 3 Press  to go to the phonebook. Scroll to the phonebook entry you want ▶ YES.
- 4 This takes you to **Personal Rings**. Select a ringtone ▶ YES.

### ***To call a number saved in the phonebook***

- 1 ▶ Phonebook ▶ YES ▶ Find and Call ▶ YES.
- 2 Enter the name or the first letter of the name ▶ YES.
- 3 If the name displayed is not the one you want, press  or  until you find the correct name and number.
- 4 ▶ YES to make the call.



### **Speed dialing**

You can save the phone numbers that you wish to reach easily in positions  -  in your phone.

### ***To speed dial***

From standby, enter the position number ▶ YES.

### **Shortcuts to phonebook entries**

When in standby, press and hold the keys  -  to find an entry beginning with the first letter on that key, or the closest following.

### **Ask to save**

If **Ask to Save** is on, you are asked if you want to save any called or answered number that is not already saved in your phonebook.

 *Your subscription must support the Calling Line Identification Service (Caller ID), if you want to save answered numbers.*

**To turn the Ask to save function on or off**

► Phonebook ► YES ► Options ► YES ► Ask to Save ► YES  
select On or Off ► YES.

**To edit an entry in the phonebook**

- 1 ► Phonebook ► YES ► Find and Edit ► YES.
- 2 Enter the name or the first letter of the name ► YES.
- 3 ► YES to select the entry.
- 4 ► Edit ► YES.
- 5 When you have finished editing ► YES to save your changes.

**To delete an entry from the phonebook**

- 1 ► Phonebook ► YES ► Find and Edit ► YES.
- 2 Enter the name or the first few letters of the name ► YES.  
When the entry you want to delete is highlighted ► YES.
- 3 ► Delete ► YES.

**Sort order**

You may change the sort order of your phonebook entries, so that they are sorted according to their position number instead of the name.

**To choose a sort order**

- 1 ► Phonebook ► YES ► Options ► YES ► Sort Order ► YES.
- 2 Select a sort order ► YES.

**Phonebook memories**

Phonebook entries are saved on your SIM card. The number of entries you can save depends on your SIM card. You can still access them if you use the card with another phone.

You can also save your entries in the phone memory when all SIM positions are occupied.

## Choosing where to save an entry

- To save the number in the position suggested ► YES.
- To save the number in another position, press **G** to delete the position number, enter a new position number ► YES.
- To save the number in the phone memory, you first need to know how many positions you have got on your SIM card. You can check this in the **Memory Status** menu.

### ***To check the status of the memories***

► Phonebook ► YES ► Memory Status ► YES.

## Replacing entries

If you try to save a phone number in a position which already contains a phone number, the message **Overwrite?** appears. Press YES to replace the number or press NO if you do not want to replace the old number.

### ***To delete all entries from the phone memory***

- 1 ► Phonebook ► YES ► Options ► YES ► Delete all? ► YES ► YES.
- 2 Enter the phone lock code (0000 or a new code) ► YES.  
If you delete all entries from the phone memory, the entries on your SIM card are not deleted.

## Copy phonebook entries

You can copy phonebook entries between your phone memory and the SIM card.

### ***To copy entries to the SIM card***

► Phonebook ► YES ► Options ► YES ► Copy to SIM ► YES.

### ***To copy entries to the phone***

► Phonebook ► YES ► Options ► YES ► Copy from SIM ► YES.

## Groups

You can create a group of phonebook entries. You can then send a text message to all members of that group at the same time ➤ *31 Text messages.*

### ***To create a new group***

- 1 ▶ Phonebook ▶ YES ▶ Options ▶ YES ▶ Groups ▶ YES  
▶ Add New ▶ YES.
- 2 Enter a name for the group ▶ YES.
- 3 ▶ Add New ▶ YES.
- 4 Select an entry in your phonebook ▶ YES.
- 5 To add the next member, repeat steps 3 and 4.
- 6 ▶ NO to leave the menu.

### ***To add a member to an existing group***

Select the group you want ▶ YES ▶ Edit ▶ YES ▶ Add New  
▶ YES.

## Voice mail

If your subscription includes an answering service, callers can leave a voicemail message when you cannot answer a call.

### **Calling your voicemail service**

You can easily call your voicemail service by pressing and holding **(1)**, if you have saved your voicemail number in the phone. You can get the number from your service provider.

### ***To enter a voicemail number***

▶ Messaging ▶ YES ▶ Options ▶ YES ▶ Voicemail No. ▶ YES.

## Call time

During a call, the duration of the call is shown in the display. You can check the duration of your last call, outgoing calls and the total time.

### ***To check the call time and reset timer***

- 1 ▶ **Calls** ▶ YES ▶ **Time & Cost** ▶ YES ▶ **Call Timers** ▶ YES.
- 2 Select an option ▶ YES.
- 3 Select **Reset Timers** to reset the call time meter.

### **Call cost and cost information**

Check with your network operator or service provider for information about these services.

-  *If you subscribe to cost information, you must enter your PIN2 to clear the cost or time counter,*  
 ➤ 58 *Security for information about PIN2.*

### ***To check the call cost and reset cost meter***

- 1 ▶ **Calls** ▶ YES ▶ **Time & Cost** ▶ YES ▶ **Call Costs** ▶ YES.
- 2 Select an option ▶ YES.
- 3 Select **Clear Total Cost** to reset the call cost meter.

### **Setting the call cost**

You can use the tariff function to specify the price per call unit. If you do not specify a price per call unit, the number of call units is displayed.

### ***To enter the price per call unit***

- 1 ▶ **Calls** ▶ YES ▶ **Time & Cost** ▶ YES ▶ **Call Costs** ▶ YES  
 ▶ **Set Rate** ▶ YES.
- 2 Enter your PIN2 ▶ YES.
- 3 Select **Change Rate** ▶ YES.
- 4 Enter the code for the currency you want, (for example GBP for Pounds Sterling) ▶ YES.
- 5 Enter the price per call unit ▶ YES. To enter a decimal point, press **\*a/A**.



## Credit limit for calls

You can enter a total amount of money that can be used for making calls. When the amount reaches zero, no more calls can be made. Please note that the credit limit is only an estimated value.

### ***To set a credit limit***

- 1 ▶ **Calls** ▶ YES ▶ **Time & Cost** ▶ YES ▶ **Call Costs** ▶ YES  
▶ **Set Credit** ▶ YES.
- 2 Enter your PIN2 ▶ YES.
- 3 Select **Change** ▶ YES.
- 4 Enter an amount ▶ YES.

## Forwarding calls

If you cannot answer incoming voice or data calls, you can forward them to another number.

 *When the Restrict Calls function is on, some Forward Calls options cannot be activated.*

For voice calls, you can choose between the following forward alternatives:

- **All Line 1 Calls** – Forward all line 1 calls.
- **All Line 2 Calls** – Forward all line 2 calls.
- **When Busy** – Forward calls if you are already on the phone.
- **Not Reachable** – Forward calls if you are unreachable.
- **No Reply** – Forward calls that you do not answer within a specified time limit (operator-dependent).

### ***To turn on a call forward***

- 1 ▶ **Calls** ▶ YES ▶ **Manage Calls** ▶ YES ▶ **Forward Calls** ▶ YES.
- 2 Select a call category and then a forward alternative ▶ YES.
- 3 Select **Activate** ▶ YES.
- 4 Enter the phone number to which you want your calls to be forwarded ▶ YES, or retrieve it from the phonebook.

**To turn off a call forward**

- 1 ▶ Calls ▶ YES ▶ Manage Calls ▶ YES ▶ Forward Calls ▶ YES.
- 2 Select a forward alternative ▶ Cancel.

**To check the status of a call forward**

- 1 ▶ Calls ▶ YES ▶ Manage Calls ▶ YES ▶ Forward Calls ▶ YES.
- 2 Select a call type ▶ YES.
- 3 Select the forward ▶ YES ▶ Get Status ▶ YES.

**To check the status of all call forwards**

- ▶ Calls ▶ YES ▶ Manage Calls ▶ YES ▶ Forward Calls ▶ YES
- ▶ Check All ▶ YES.

**More than one call**

You can handle more than one call simultaneously. For example, you can put an ongoing call on hold, while you make or answer a second call, and then switch between the two calls. You cannot answer a third call without ending one of the first two calls.

 *During a call the Ongoing Call menu replaces the Calls menu.*

**Call waiting service**

If the call waiting service is activated, you hear a beep if you receive a second call during an ongoing call.

**To activate or deactivate the call waiting service**

- ▶ Calls ▶ YES ▶ Manage Calls ▶ YES ▶ Call Waiting ▶ YES
- ▶ Activate.

### ***To make a second call***



- 1 ▶ YES to put the ongoing call on hold. You can only put one call on hold.
- 2 Enter the number you want to call ▶ YES, or retrieve a number from the phonebook. To reach different options press .

### ***To receive a second call***

- To answer the second call and put the ongoing call on hold
  - ▶ Answer.
- To reject the second call and continue the ongoing call
  - ▶ Busy.
- To answer the second call and to end the ongoing call
  - ▶ Release & Answ.

### **Handling two calls**

When you have one ongoing call and one call on hold, you can do the following:

- ▶ YES to switch between the two calls.
- Press  ▶ **Join Calls** to join the two calls into a conference call.
- Press  ▶ **Transfer Call** to connect the two calls. You are disconnected from both calls.
- ▶ NO to end the ongoing call ▶ YES to retrieve the held call.
- ▶ NO twice to end both calls.

### **Conference calls**

You can have a joint conversation (conference call) with up to five people. You can also put a conference on hold and make another call.

 *There may be additional charges for calls involving multiple parties. Contact your service provider for more information.*

## Creating a conference call

To create a conference call, you must first have one ongoing call and one call on hold.

### ***To join the two calls into a conference call***

Press  ► **Join Calls** ► YES.

### ***To add a new participant***

- 1 ► YES to put the conference call on hold.
- 2 Call the next person you wish to include in the conference call.
- 3 Press  ► **Join Calls** ► YES. Repeat steps 1 to 3 to include more participants.

### ***To release a participant***

- 1 Press  ► **Release Party** ► YES.
- 2 Select the participant ► YES.



### ***To end the conference call***

► NO.

## Having a private conversation

You can have a private conversation with one of the participants and put the other participants on hold.

### ***To start a private conversation***

- 1 Press  ► **Extract Part** to select the participant that you want to talk with.
- 2 Press  ► **Join Calls** to resume the conference call.

## Restricted dialing

You can use the restrict calls service to restrict outgoing and incoming calls. To use this service, you need a password which you get from your service provider.

 *If you forward incoming calls, you cannot activate some Restrict Calls options.*

The following calls can be restricted:

- **All Outgoing** – All outgoing calls.
- **Outgoing Intl.** – All outgoing international calls.
- **Outg. Intl. Roam** – All outgoing international calls except to your home country.
- **All Incoming** – All incoming calls.
- **Inc. when Roam** – All incoming calls when you are abroad (when roaming).

### ***To turn a call restriction on or off***

- 1** ▶ **Calls** ▶ **YES** ▶ **Manage Calls** ▶ **YES** ▶ **Restrict Calls** ▶ **YES**.
- 2** Select an option ▶ **YES**.
- 3** Select **Activate** or **Cancel** ▶ **YES**.
- 4** Enter your PIN ▶ **YES**.

## **Fixed dialing**

The fixed dialing function allows calls to be made only to certain numbers saved on the SIM card.

Fixed dialing requires a SIM card that allows fixed numbers to be saved. The fixed numbers are protected by your PIN2. You can save partial numbers or numbers with question marks.

- **Partial numbers:** Saving 0123456 allows calls to be made to all numbers starting with 0123456.
- **Numbers with question marks:** Saving 01234567?0, allows calls to be made to numbers from 0123456700 to 0123456790. To enter a question mark, press and hold .

 *Calls to international emergency numbers can still be made, even when the fixed dialing function is on.*

**To turn fixed dialing on or off**

- 1 ▶ Phonebook ▶ YES ▶ Options ▶ YES ▶ Fixed Dialing ▶ YES.
- 2 Enter your PIN2 ▶ YES.
- 3 Select On or Off ▶ YES.

**To save a fixed number**

- 1 ▶ Phonebook ▶ YES ▶ Options ▶ YES ▶ Special Numbers  
▶ YES ▶ Fixed Numbers ▶ YES.
- 2 ▶ Add New and enter the number ▶ YES.

**Closed user groups**

The closed user group function is a way of lowering call costs. On some networks it is cheaper to make calls within a call group. You can save 10 groups.

**To add a group**

- 1 ▶ Calls ▶ YES ▶ Manage Calls ▶ YES ▶ Closed Groups  
▶ YES ▶ Edit List ▶ YES.
- 2 ▶ Add New ▶ YES.
- 3 Enter the name of the user group ▶ YES.
- 4 Enter the index number ▶ YES. You get the index number from your operator.

**To activate a group**

- 1 ▶ Calls ▶ YES ▶ Manage Calls ▶ YES ▶ Closed Groups  
▶ YES ▶ Edit List ▶ YES.
- 2 Select a group ▶ YES.
- 3 ▶ Activate ▶ YES. Calls can only be made within the selected group.

**To call outside a closed user group**

- ▶ Calls ▶ YES ▶ Manage Calls ▶ YES ▶ Closed Groups  
▶ Open Calls ▶ On.

## Accept calls

With the accept calls service, you can choose to receive calls only from certain numbers.

### ***To add numbers to the accepted callers list***

- 1 ▶ Calls ▶ YES ▶ Manage Calls ▶ YES ▶ Accept Calls ▶ YES  
▶ Accepted List ▶ YES.
- 2 ▶ Add New ▶ YES.
- 3 Select an option ▶ YES.
- 4 Select an entry ▶ YES.

### ***To select an accept option***

- ▶ Calls ▶ YES ▶ Manage Calls ▶ YES ▶ Accept Calls ▶ YES
- ▶ Accept Options ▶ YES select an option ▶ YES.

## Additional calling functions

### Tone signals

You can use telephone banking services or control an answering machine by sending tone signals (also known as DTMF tones or touch tones) during a call.

### ***To send and clear tones***

- Press the number keys  - ,  and .
- To clear the display after a call ▶ NO.

### Notepad

You can use the phone to make a note of a phone number during a call. When you press the number keys, the person you are talking to hears tone signals. To turn these tone signals off during the call, press  ▶ Turn Off Tones ▶ YES. When you end the call, the number remains in the display. To call the number ▶ YES.

## Showing or hiding your number

If your subscription supports CLIR (Calling Line Identification Restriction), you can hide your phone number when making a call.

### ***To show or hide your phone number***

- 1 Enter the phone number you want to call, press .
- 2 ► Hide My Number or Show MyNumber ► YES.



## Messaging

### Service numbers

You must have a service center number before you can send a text message. This number is provided by your operator. If it is not saved on your SIM card, you must specify the number yourself.



#### ***To check the number to your service center***

- 1 ▶ Messaging ▶ YES ▶ Text Message ▶ YES ▶ Options  
▶ YES ▶ Service Centers ▶ YES. If no number is found  
▶ Add New ▶ YES.
- 2 Enter the number, including the international + sign and country/region code ▶ YES.

### Text messages

You can use the SMS (Short Message Service) to send and receive text messages. Text messages can contain pictures and sound effects.

#### ***To send a text message***

- 1 ▶ Messaging ▶ YES ▶ Text Message ▶ YES ▶ Write New  
▶ YES.
- 2 Enter your message ▶ YES,  13 Entering letters and characters.
- 3 Enter the recipient's phone number or retrieve it from the phonebook by pressing .
- 4 ▶ YES to send the message.

#### ***To insert an item in a text message***

- 1 ▶ Messaging ▶ YES ▶ Text Message ▶ YES ▶ Write New  
▶ YES.
- 2 Press  to enter the option menu.

- 3 Select **Add Symbol** or **Insert Item** ► YES.
- 4 Select **Picture**, **Sound**, **Melody** or **Animation** ► YES.
- 5 Select an object or symbol ► YES. ► YES again to confirm.

### **Sending a text message to a group**

You can send text messages to groups that you have specified and saved in your phonebook, ► *21 Groups*. You will be charged for each group member.

#### ***To send a text message to a group***

- 1 ► **Messaging** ► YES ► **Text Message** ► YES ► **Write New** ► YES.
- 2 Enter your message ► YES.
- 3 Press  ► **Groups** ► YES.
- 4 Select a group ► YES.

### **Text formatting**

You can change the style, size and alignment of the text in a text message.

#### ***To format the text in a text message***

- 1 ► **Messaging** ► YES ► **Text Message** ► YES ► **Write New** ► YES.
- 2 Write the text message.
- 3 Press  ► **Text Format** ► YES.
- 4 Select **Text Size**, **Text Style**, **Alignment** or **New Paragraph** ► YES. Select a format ► YES.

 *Text formatting only applies when Latin characters are used.*

## Long messages

The maximum number of characters that a text message can contain depends on the writing language. You can send a longer message by linking two or more messages. You are charged for the number of linked messages.

### **To turn long messages on**

- ▶ **Messaging** ▶ YES ▶ **Text Message** ▶ YES ▶ **Options** ▶ YES
- ▶ **Long Messages** ▶ YES ▶ **On** ▶ YES.

 *Check with your service provider for the maximum number of messages that can be linked.*

## Message options

You can set a default value for the message options below, or you can turn on the **Set on Send** option which means that you choose the settings each time you send a message.

- **Text Message Type** – The phone supports different types of messages. Your service provider may offer the service of converting a text message into a format (email, for example) that suits the equipment that is going to receive the message.
- **Validity Period** – If your message cannot be delivered, your service center can save the message to send it later.
- **Request Reply** – Include a reply request if you want the recipient of your message to reply.
- **Status Request** – Check if a message has been delivered.

### **To set a default message option**

- 1** ▶ **Messaging** ▶ YES ▶ **Text Message** ▶ YES ▶ **Options** ▶ YES.
- 2** Select **Text Message Type**, **Validity Period**, **Request Reply**, or **Status Request** ▶ YES.
- 3** Select an option from the list ▶ YES.

## Templates

If you have one or more messages that you send often, you can save these as templates.

### ***To create a template***

- 1 ▶ **Messaging** ▶ YES ▶ **Text Message** ▶ YES ▶ **Templates** ▶ YES ▶ **Add New** ▶ YES.
- 2 Enter the message ▶ YES to save the template.

### ***To use a template***

Select a template from the **Templates** list in the **Messaging** menu, and proceed as described on ➤ *31 To send a text message*.

### ***To check the number of sent messages***

- ▶ **Calls** ▶ YES ▶ **Time & Cost** ▶ YES ▶ **Text Msg. Counter** ▶ YES
- ▶ **Show Counter** ▶ YES.

### ***To reset the message counter***

- ▶ **Calls** ▶ YES ▶ **Time & Cost** ▶ YES ▶ **Text Msg. Counter** ▶ YES
- ▶ **Reset Counter** ▶ YES.

## Receiving a message

When you receive a message, press YES to read the message now or NO to read the message later.

### ***To reply to a message***

- 1 When you have read the message ▶ YES.
- 2 ▶ **Reply** ▶ YES.
- 3 Select the message you want to send as a reply ▶ YES. You can choose between: **Write New**, **Include This Msg.** or a template if available.
- 4 Write your message ▶ YES.

### ***To forward a message***

- 1 When you have read the message ► YES.
- 2 ► **Forward** ► YES. Continue in the same way as when sending a new text message.

### ***To call a phone number found in a message***

When the number is highlighted ► YES.

### ***To call the sender of the message***

- 1 When you have read the message ► YES.
- 2 ► **Call** ► YES.

### ***To delete a message***

When you have read the message ► YES ► **Delete** ► YES.

### ***Saving incoming messages***

Text messages are automatically saved in the phone memory. When the phone memory is full, they are automatically saved on the SIM card. When both phone memory and SIM card memory are full, you must delete messages to be able to receive new messages. Messages that you have saved on the SIM card can remain there until you have deleted them.

### ***To save a message on the SIM card***

When you have read the message ► YES ► **Save on SIM** ► YES.

### ***Picture messages***

Picture messages can contain text, pictures and sounds. They are sent via MMS (Multimedia Messaging Service) to a mobile phone or via email. The sender and receiver of a picture message must have a subscription that supports MMS.

## Before you start

Make sure you have the following settings:

- An address to your service center.
- A specific WAP profile for multimedia messages.

 *Contact your network operator to automatically download settings or for more information. You can also use the Phone setup on [www.SonyEricsson.com/support](http://www.SonyEricsson.com/support) to get the settings you need. Choose region and country, then select Phone setup and your phone model.*

### **To enter the service center address**

- ▶ Messaging ▶ YES ▶ Picture Message ▶ YES ▶ Options ▶ YES
- ▶ Message Server ▶ YES.

### **To select or enter settings for MMS**

- ▶ Messaging ▶ YES ▶ Picture Message ▶ YES ▶ Options ▶ YES ▶ Internet Profile ▶ YES.
- Select **Select or Create New.** ➔ 50 *To enter Internet profile settings manually.*

## More options

You can set different options for sending and receiving picture messages.

### **To select an option**

- ▶ Messaging ▶ YES ▶ Picture Message ▶ YES ▶ Options ▶ YES.

### **To write and send a picture message**

- ▶ Messaging ▶ YES ▶ Picture Message ▶ YES ▶ Write New ▶ YES.
- Select from the submenus ▶ YES.
- Enter the information you want to send ▶ YES.

- 4 ▶ YES to add other items or more options.
- 5 ▶ **Send message** ▶ YES. Enter the recipient's phone number or retrieve it from the phonebook by pressing  ▶ YES.

### ***To view a picture message***

▶ YES. The message is automatically displayed. Press any key to stop.

When you have viewed a picture message, you can use the navigation key to scroll through the message again. When an item is highlighted, press  to save it in your phone.

When you have read the message, ▶ **Proceed**, to select one of the following options: **View Again**, **Information**, **Reply**, **Reply All**, **Forward**, **Save Template**, **Call** or **Delete**. ▶ NO to close the message.

### **Area information**

Area information, for example, a local traffic report, is sent to all subscribers in a certain network area. You cannot save area messages.

### ***To turn area information on or off***

- 1 ▶ **Messaging** ▶ YES ▶ **Options** ▶ YES ▶ **Area Info.** ▶ YES  
▶ **Reception** ▶ YES.
- 2 ▶ **On or Off** ▶ YES.

### **Cell information**

The cell information channel is used by some network operators for sending messages to their subscribers within a certain network area.

### ***To turn the cell information channel on or off***

- 1 ▶ **Messaging** ▶ YES ▶ **Options** ▶ YES ▶ **Area Info.** ▶ YES  
▶ **Cell Information** ▶ YES.
- 2 Select **On or Off** ▶ YES.

## Personalizing your phone

### *To change a Style-Up cover*

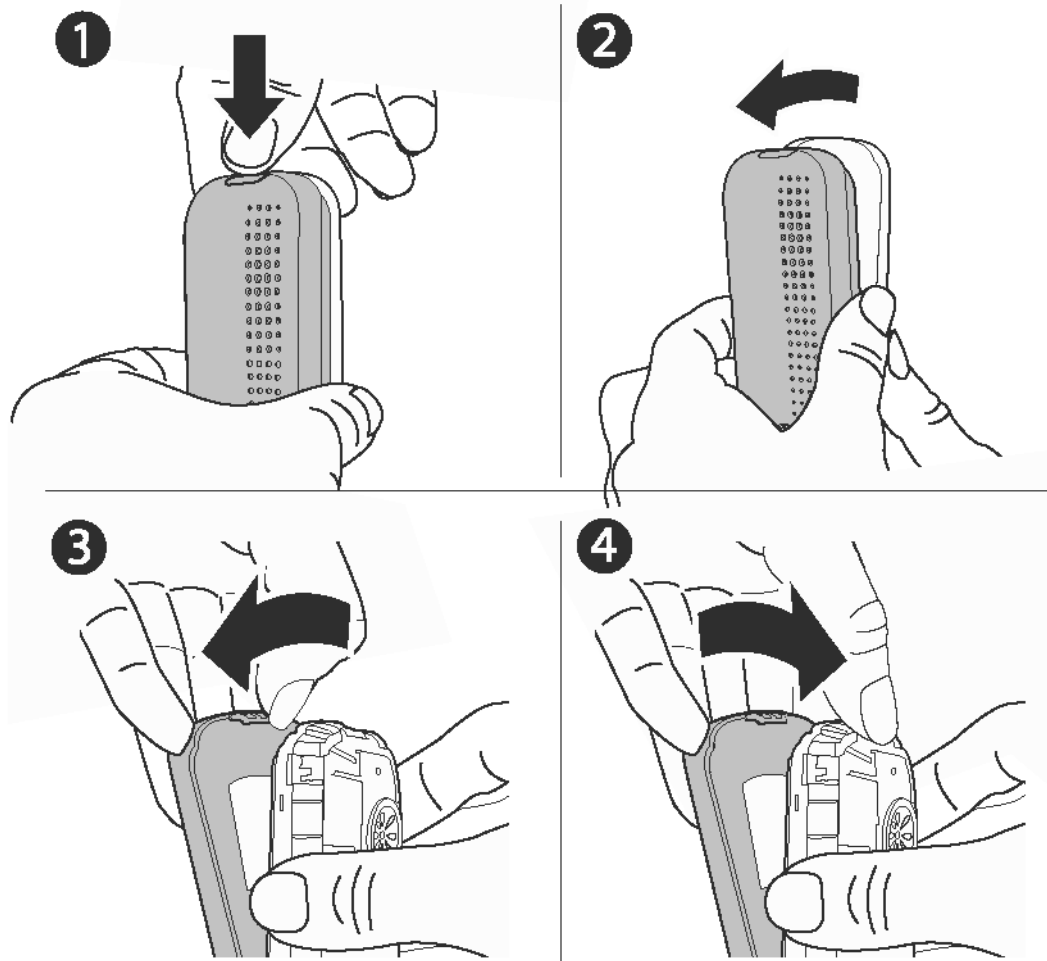

- 1** Press to release the back cover as shown in the picture.
- 2** Pull the back cover away from the phone.
- 3** Gently lift the release catch to remove the front cover.
- 4** Make sure the keypad is in place, and gently press the front cover on to the phone.



## Themes

You can change the appearance of the display by using themes. Your phone comes with a number of predefined themes.

### ***To select a theme***

► Fun & Games ► YES ► Themes ► YES.

### ***To adjust the display contrast***

► Settings ► YES ► Display ► YES ► Contrast ► YES.

## Pictures

Your phone comes with a number of pictures. All pictures are saved in **My Pictures** in the **Fun & Games** menu.

You can:

- Set a picture as a wallpaper when in standby mode.
- Assign a picture to an entry in the phonebook.
- Insert a picture in a picture message.
- Download a picture from the Internet.

## Handling pictures

You can also add, delete or rename pictures in **My Pictures**. The number of pictures that can be saved depends on available memory. File types supported are GIF, JPEG and WBMP.

 *You cannot rename or delete predefined pictures*

### ***To view your pictures***

- 1 ► Fun & Games ► YES ► My Pictures ► YES.
- 2 The pictures are shown in thumbnail view. To get a full view ► YES.

 *Animations can only be viewed when inserting an item in a text message, ➔ 31 To insert an item in a text message.*

### ***To select a picture as wallpaper***

- 1 ▶ Settings ▶ YES ▶ Display ▶ YES ▶ Wallpaper ▶ YES  
▶ Select Picture ▶ YES.
- 2 Select a picture ▶ YES.

### ***To turn the wallpaper on or off***

- ▶ Settings ▶ YES ▶ Display ▶ YES ▶ Wallpaper ▶ YES
- ▶ Activate, select On or Off.

### **Exchanging pictures**

You can send and receive pictures in picture messages. For more information on sending pictures in messages, ➔ *31 Messaging*.

 *You are not allowed to exchange copyright-protected material.*

### ***To send a picture***

- 1 ▶ Fun & Games ▶ YES ▶ My Pictures ▶ YES.
- 2 Select a picture ▶ YES. Press .
- 3 ▶ Send ▶ YES and write a message.

### ***To receive a picture via a message***

When you receive a picture via a message, a new message appears in your inbox. Highlight the picture in the message by using the navigation key to select it, press  ▶ Save to save it in **My Pictures**.

### **Ringtones and melodies**



Your phone comes with a number of standard and polyphonic melodies which can be used as ringtones. You can create and edit melodies, and send them to a friend in a text message. You can also download new melodies from the Internet.

 *You are not allowed to exchange copyright-protected material.*

### **To select a ringtone**

► Settings ► YES ► Sounds & Alerts ► YES ► Ringtone ► YES.

### **To set the ringtone volume**

- 1 ► Settings ► YES ► Sounds & Alerts ► YES ► Ring Volume ► YES.
- 2 Press  or  to decrease or increase the volume.
- 3 ► YES to save the setting.

### **To turn the ringtone on or off**





There are two ways to turn on or off the ringtone:

- ► Silent ► YES ► Turn On Silent or Silent off? ► YES.
- Press  from standby, and select Turn On Silent or Turn Off Silent. All signals except the alarm signal and timer are turned off.

### **To compose your own ringtone**

You can compose your own personal ringtones.

Options available when composing a ringtone are:

- Press a key to enter a note. Press and hold the key to make it a long note.
- Press  to raise the note one octave.
- Press  once to raise the note one semitone.
- Press  twice to lower the note one semitone.
- Press  to remove notes.

### **To compose a ringtone**

- 1 ► Fun & Games ► YES ► Composer ► YES.
- 2 Compose your ringtone using the options described above.
- 3 To listen to your ringtone ► YES.
- 4 Press YES again to save and name it, or NO to continue composing.

## Exchanging ringtones and melodies

You can send and receive a sound, ringtone or melody via picture messages or download it from the Internet.

 *You cannot exchange a polyphonic melody via text messages.*

### To send a melody

- 1 ▶ Fun & Games ▶ YES ▶ My Sounds ▶ YES.
- 2 Select a melody and press .
- 3 ▶ Send ▶ YES.

## Increasing ring

You can choose a ringtone that rises in steps from the lowest volume to the highest, or you can choose a ringtone with a constant volume.

### To turn increasing ring on or off

- ▶ Settings ▶ YES ▶ Sounds & Alerts ▶ YES ▶ Increasing Ring.  
Select On or Off.

## Sounds & alerts

You can choose to be notified of an incoming call by the buzzing of the vibrating alert. You can set the phone's vibrating alert to **On**, **On If Silent** or **Off**.

From **Sounds & Alerts** in the **Settings** menu, you can also select:

- **Message Alert** when messages are received.
- **Key Sound** when using the keypad.

### To set the vibrating alert

- 1 ▶ Settings ▶ YES ▶ Sounds & Alerts ▶ YES ▶ Vibrating Alert ▶ YES.
- 2 Select the setting you want ▶ YES.

## Display light

The display light can be set to **On** or **Automatic**. Automatic is the default setting for the display light and is designed to optimize standby time. In automatic mode, the display light is turned off a few seconds after you last press a key.

 *If set to On, the display light consumes extra battery power and reduces standby time.*

### **To activate the screen**

Press **C** from standby.

### **To set the display light**

► Settings ► YES ► Display ► YES ► Light ► YES.

### **To set the display contrast**

► Settings ► YES ► Display ► YES ► Contrast ► YES.

## Time and date

### **To set the time**

► Settings ► YES ► Time and Date ► YES ► Set Time ► YES.

### **To set the time format**

► Settings ► YES ► Time and Date ► YES ► Time Format ► YES.

### **To set the date**

► Settings ► YES ► Time and Date ► YES ► Set Date ► YES.

### **To set the date format**

► Settings ► YES ► Time and Date ► YES ► Date Format ► YES.

## Answering mode

When using a portable handsfree kit, you can choose to answer a call by pressing any key (except the NO key), or setting the phone to answer the call automatically.

### *To select answering mode*

► Settings ► YES ► Handsfree ► YES ► Answering Mode ► YES.

## My phone numbers

You can check your own phone number(s).

### *To check your phone number*

► Phonebook ► YES ► Options ► Special Numbers ► YES  
► My Numbers ► YES. If your number is not saved on your SIM card, you can enter it yourself.

## Profiles

Your phone has predefined profiles which are set to suit a certain environment. You can rename or change these profiles.

### *To select a profile*

► Settings ► YES ► Profiles ► YES ► Select Profile ► YES.

### *To change a profile setting*

- 1 ► Settings ► YES ► Profiles ► YES ► Edit Profile ► YES.
- 2 Select a setting ► YES.
- 3 Change the profile settings ► YES to confirm.

### *To rename a profile*

► Settings ► YES ► Profiles ► YES ► Edit Profile ► YES  
► Profile name: ► YES.

### ***To reset all profiles***

► Settings ► YES ► Profiles ► YES ► Reset Profiles ► YES.

### **Master reset**

You can reset all the settings in the phone to the way they were when you bought your phone by selecting **Reset Settings**. If you also want to delete all phonebook entries, messages and other personal data, select **Reset All** instead.

 *If you select **Reset All**, content such as melodies and pictures that you have downloaded, received or edited is also deleted.*

### ***To reset the phone***

- 1** ► Settings ► YES ► Master Reset ► YES.
- 2** Select **Reset Settings** or **Reset All** ► YES.
- 3** ► YES to continue.
- 4** Enter the phone lock code (*0000* or a new code) ► YES.



## Internet

### Setting up the Internet

In order to use the Internet the following are required:

- A phone subscription that supports data transmission.
- Settings entered in your phone.
- You may also have to register as an Internet user with your service provider or network operator.

 *More information about setting up is available in the Getting Started Guides at [www.SonyEricsson.com/support](http://www.SonyEricsson.com/support).*

### Receiving settings in a text message



Your GSM network operator or Internet service provider may be able to send your settings direct to your phone in a text message (SMS).

### Request settings from Sony Ericsson

Use a PC to go to [www.SonyEricsson.com/support](http://www.SonyEricsson.com/support) to request that a text message with the settings be sent to your phone.

### ***To install settings***

When the message arrives, **New settings received. Install?** appears:

- Press **YES** to install the new settings. If settings already exist in your phone you can either keep or replace them,  *47 Advanced setting information.*
- Press **NO** to cancel installation.  
After installation,  *52 Using the Internet browser.*



## Set up with the wizard

If your phone is not set up for Internet, you can ask your network operator or service provider to provide you with Internet settings information. Then you can simply use the wizard in your phone to help guide you through the relevant settings.

### ***To use the wizard for setting up Internet***

- 1 ▶ **Internet Services** ▶ YES ▶ homepage (for example Sony Ericsson) ▶ YES. The wizard now starts if no settings exist.
- 2 Enter and save settings when asked, press YES to confirm.

## Advanced setting information

Some advanced settings that are described in the following texts may not be mandatory, please consult your network operator or service provider for more information.

A **data account** includes connection settings for access to a server at your service provider, for example via WAP or via e-mail.

An **Internet profile** includes user settings that allow Web browsing.

To use the Web browser, via an Internet service provider, you need settings for a specific **data account** for Internet and an **Internet profile**.

To send a text message (SMS) to an email address via your network operator, you need to set an email gateway phone number.

## Data account settings

You can have several data accounts saved in your phone, with different settings for different purposes. The main setting for a data account is the **Account Type** (connection method).

 *If there are no data account or Internet profile settings in your phone, you can enter data account settings when you enter Internet profile settings.*

You can choose from **GPRS Data** or **GSM Data** account types. If you want to change access type, you have to create a new data account and select the access type you want to use.

## **GPRS**

GPRS (General Packet Radio Service) allows fast and efficient access where you can always be online. You need a subscription that supports GPRS.

GPRS settings that are available:

- **APN** (Access point name address) – The address of the external network you want to connect to, either an IP address or a text string.
- **User ID** – Your username to log on to an external network.
- **Password** – Your password to log on to an external network.
- **Pwd. Request** – If this setting is on, you are asked for a password each time you log on to the external network.
- **Allow Calls** (Preferred service) – If you want to be able to accept incoming calls during a GPRS session, select **Automatic**. If not, select **GPRS Only**.
- **IP Address** – The IP address that the phone uses when communicating with the network. If you do not enter an address, the network provides you with a temporary IP address.
- **DNS Address** – If the network does not provide the IP address to the DNS server automatically, you may enter it here.
- **Advan. Settings** (Advanced settings) – These are optional. Consult your network operator.

## **GSM**

GSM settings include some settings that are similar to GPRS settings and some that are GSM specific as follows:

- **Phone Number** – The phone number of your Internet service provider.
- **Data Rate** – Select the speed you want for the connection.
- **Dial Type** – Select Analog or ISDN connection.

### ***To create a data account manually***

- 1** ▶ Settings ▶ Connect ▶ YES ▶ Data Comm. ▶ YES  
▶ Data Accounts ▶ YES ▶ Add account? ▶ YES.
- 2** Select an account type for access and enter a name for the data account.
- 3** Enter the settings that you have received from your network operator or service provider. ▶ YES to confirm each setting.
- 4** Save? ▶ YES.

### ***To edit a data account***

- 1** ▶ Settings ▶ Connect ▶ YES ▶ Data Comm. ▶ YES  
▶ Data Accounts ▶ YES.
- 2** Select a data account ▶ YES.
- 3** ▶ Edit.
- 4** Select the setting you want to edit ▶ YES. Edit the setting  
▶ YES.
- 5** Repeat step 4 for other settings you want to edit.

## **Preferred service**

You can set GPRS or GSM as the preferred service.

### ***To select preferred service***

- ▶ Settings ▶ Connect ▶ YES ▶ Data Comm. ▶ YES ▶ Pref. Service  
▶ YES and select GPRS and GSM or GSM Only ▶ YES.

## Internet profile settings

The Internet settings are stored in an Internet profile. In most cases you only need to use one profile to access the Internet.

You set up and use additional Internet profiles, for example, when accessing secure Internet sites. You then simply switch between profiles when you need to change the network connection.

Make sure you have a data account set up between your phone and the Internet server, as described on [47 Data account settings](#).

### **To enter Internet profile settings manually**

- 1 ▶ Internet Services ▶ YES ▶ Options ▶ YES ▶ Internet Profiles ▶ YES.
- 2 ▶ Add profile? to add a new profile or select an existing profile that you want to edit ▶ YES.

### **To enter information in a new profile**

When selecting **Add profile?** enter a name for the profile  
 ▶ YES ▶ **Connect using:** ▶ YES, select the data account to be used ▶ YES and enter the **IP Address** ▶ YES. A list appears. Scroll to **Save?** ▶ YES.

### **To edit an existing profile**

When selecting an existing profile, you can do the following:

- **Rename** – Change the name of the profile.
- **Connect Using** – Select data account.
- **IP Address** – WAP gateway server address.
- **Advanced** – More profile settings, see below.
- **Delete** – Remove the profile.

### ***To use advanced profile settings***

If you select **Advanced** you can do the following:

- **Chg. Homepage** – Enter the address of the site you want as the homepage.
- **Second Account** – Select an alternative data account, if the first in **Connect Using** fails.
- **User ID** – Enter your username for the WAP gateway.
- **Password** – Enter your password for the WAP gateway.
- **Security** – See Internet security settings.
- **Show Pictures** – View pictures while browsing.

### **Internet security**

Your phone has support for secure browsing. Security for a connection between a WAP gateway and an Internet service provider is the responsibility of the service provider.

### ***To turn on a secure connection***

- 1 ▶ **Internet Services** ▶ YES ▶ **Options** ▶ YES ▶ **Internet Profiles** ▶ YES.
- 2 Select the profile to be used ▶ YES.
- 3 ▶ **Advanced** ▶ YES ▶ **Security** ▶ YES.
- 4 ▶ **On** ▶ YES.

### **Trusted certificates**

To establish a secure connection when using certain Internet services, for example banking or shopping, you need certificates in your phone.

### ***To check the certificates in your phone***

- ▶ **Internet Services** ▶ YES ▶ **Options** ▶ YES ▶ **Advanced** ▶ YES  
▶ **Security** ▶ YES ▶ **Trusted Certif.** ▶ YES.

## Using the Internet browser

Settings may already be entered when you buy the phone. Otherwise you can receive the settings from your network operator or your service provider in a text message. You can also use the Phone setup on [www.SonyEricsson.com/support](http://www.SonyEricsson.com/support) to get the settings you need. Choose region and country, then select Phone setup and your phone model.

### Internet access

There are two ways to access the Internet:

- Direct access via the options key
- Access via the menu system

### ***To access the Internet directly***

Press  and select **Sony Ericsson**.

### ***To access the Internet via the menus***

- ▶ **Internet Services** ▶ **YES**. Select one of the following:
  - Open your homepage, for example, Sony Ericsson.
  - Go to one of your bookmarks. Select **Bookmarks** ▶ **YES**.
  - Enter the address of an Internet site. Select **Enter Address** ▶ **YES**. **New address?** to enter a new address or select one of the 10 latest entered addresses. When you enter an address, the normal `http://` prefix is not needed.

### ***To stop browsing***

- Press and hold **NO** or
- Press  ▶ **Exit Browser**.

## Options when browsing

When you have started browsing, you can reach different browsing options by pressing .

The options menu is dynamic. Its content may vary depending on which site you are visiting.

The options menu contains the following:

- **Bookmarks** – Add the site you are currently browsing to your list of bookmarks, or see the list of bookmarks for the current profile.
- **Push Inbox** – Displays received push messages.
- **Enter Address** – Enter the Internet address of a site you want to visit.
- **Save Picture** – Save a picture from the site.
- **Send as Text Msg.** – Send a text message with a link to the current Web page to another phone.
- **Reload** – Refresh the contents of the Web page.
- **Exit Browser** – Disconnect and go to standby.
- **Status** – Display current status information, for example, profile, access type, connection time, data rate, security, address.
- **Set as homepg** – Set the current site as the homepage of the Internet profile you are using.

## Using bookmarks

You use bookmarks in your mobile phone just as you do with a PC Internet browser. You can have up to 25 bookmarks.

### *To work with bookmarks*

- 1 ▶ **Internet Services** ▶ YES ▶ **Bookmarks** ▶ YES.
- 2 Select the bookmark you want to work with ▶ .
- 3 ▶ **Go to Bookmark, Edit, Delete, Send as Text Msg.,**  
or **Set as homepg** ▶ YES.

## Downloading

You can download, for example, pictures and ringtones from Web sites directly to your phone.

 *Make sure the file sizes do not exceed the free memory in your phone, ➤ 60 Memory status for more information.*

### **To download from [www.SonyEricsson.com](http://www.SonyEricsson.com)**

- 1 ▶ Internet Services ▶ YES ▶ Bookmarks ▶ YES  
▶ Sony Ericsson ▶ YES.
- 2 Select what you want to download and follow the instructions that appear ▶ YES.

### **Stored information**

The following information can be saved in your phone:

- Cache – Improves memory efficiency.
- Passwords – Improves server access efficiency.
- Cookies – Improves site access efficiency.

It is advisable to clear any sensitive information about previously visited Internet services.

### **To allow Internet information in your phone**

- 1 ▶ Internet Services ▶ YES ▶ Options ▶ YES ▶ Advanced ▶ YES.
- 2 Select the information to allow ▶ YES.

### **To clear cache, password list, cookies or push inbox**

- 1 ▶ Internet Services ▶ YES ▶ Options ▶ YES ▶ Advanced ▶ YES.
- 2 Select the information to be cleared ▶ YES to confirm.



## More features

### Alarm clock

The alarm clock rings even if the phone is set to silent or turned off.

#### **To set an alarm**

- 1 ▶ Alarms ▶ YES ▶ Alarm or Recurrent Alarm ▶ YES.
- 2 Enter the time ▶ YES and day, if the alarm is recurrent, by scrolling and pressing **(\*)** ▶ YES.

#### **To turn the alarm off**

Press any key to turn the alarm signal off when it rings. If you do not want the alarm to be repeated ▶ YES.

#### **To change the alarm time**

▶ Alarms ▶ YES ▶ Alarm ▶ YES ▶ Set New Time ▶ YES.

#### **To cancel the alarm**

▶ Alarms ▶ YES. Select Alarm or Recurrent Alarm ▶ YES  
▶ Cancel ▶ YES.

#### **To select an alarm signal**



▶ Settings ▶ YES ▶ Sounds & Alerts ▶ YES ▶ Alarm Signal  
▶ YES.

## Stopwatch

The stopwatch is turned off when you answer an incoming call or when you exit the stopwatch menu.

#### **To use the stopwatch**





- ▶ Organizer ▶ YES ▶ Stopwatch ▶ YES then press:
- **(C)** to reset.
  - **(#-0)** to save up to nine lap times.

- YES to start, stop or re-start.
- NO to stop.
-  or  to check saved lap times.

## Calculator

The phone has a built-in calculator, which can add, subtract, divide and multiply.

### *To use the calculator*

- 1 ▶ Organizer ▶ YES ▶ Calculator ▶ YES.
- 2 Enter digits with the keypad, then press:
  -  or  to get  $\div$ ,  $\times$ ,  $-$ ,  $+$ , a decimal point or %.
  -  to delete the figure.
  - YES to calculate a result, equal to (=).
  -  to save to memory.
  -  to retrieve from memory.

## Timer

The phone has a timer that can be set to count down from 99 hours, 59 minutes, 59 seconds. When the signal rings, press any key to turn it off.

### *To set the timer*

- ▶ Organizer ▶ YES ▶ Timer ▶ YES.

## Calendar

In the calendar you can add tasks for things that you have to remember. The tasks can be edited or deleted.

### *To add a task*

- 1 ▶ Organizer ▶ YES ▶ Tasks ▶ YES.
- 2 ▶ Add task? ▶ YES.
- 3 Enter a description ▶ YES.

- 4 Set a reminder, if required, or ► NO to save.
- 5 Enter the start date and time ► YES.
- 6 ► Continue? ► YES.

### ***To set the reminder***

Select any of the predefined values or enter the alarm date  
► YES and the alarm time ► YES.

### ***To view a task***

- 1 ► Organizer ► YES ► Tasks ► YES.
- 2 Select View All Tasks ► YES.

### ***To delete a task***

Scroll to the task that you want to delete, press **C**.

### ***To delete all tasks***

► Organizer ► YES ► Tasks ► YES ► Delete All ► YES.

### ***To edit a task***

- 1 When the task is displayed ► YES ► YES.
- 2 ► Edit ► YES.
- 3 Edit the task ► YES, edit the reminder ► YES, edit the time and date ► Continue.

## **Games**

Information and games controls are given in help texts for each game.

### ***To start a game***

- 1 ► Fun & Games ► YES ► Games ► YES.
- 2 Select a game ► YES.
- 3 Select New Game or Resume Game ► YES.



## Security

### Keypad lock

#### ***To lock the keypad***

From standby, press  and select **Lock Keypad**.

#### ***To unlock the keypad***

Press  and then press .

### SIM card lock

The SIM card lock protects your subscription, but not your phone itself, from unauthorized use. If you change SIM cards, the phone still works with the new SIM card.

#### **PIN and PUK code**

Most SIM cards are locked at the time of purchase. If the SIM card lock is on, you have to enter a “PIN” (Personal Identification Number) every time you turn on your phone.

If you enter your PIN incorrectly three times in a row, the SIM card is blocked. This is indicated by the message **PIN blocked..** To unblock it you need to enter your “PUK” (Personal Unblocking Key). Your PIN and PUK are supplied by your operator.

#### ***To unblock your SIM card***

- 1** **PIN blocked.** appears.
- 2** Enter your PUK ► **YES**.
- 3** Enter a new four- to eight-digit PIN ► **YES**.
- 4** Re-enter the new PIN to confirm ► **YES**.

### ***To edit your PIN***

▶ **Settings** ▶ YES ▶ **Locks** ▶ YES ▶ **SIM Lock** ▶ YES ▶ **Change PIN** ▶ YES. If the message **Codes do not match.** appears, you entered the new PIN incorrectly. If the message **Wrong PIN.** appears, followed by **Old PIN:**, you entered your old PIN incorrectly.

### **PIN2**

Certain services are protected by a second PIN.

### ***To edit your PIN2***

▶ **Settings** ▶ YES ▶ **Locks** ▶ YES ▶ **SIM Lock** ▶ YES ▶ **Change PIN2** ▶ YES.

### ***To turn the SIM card lock on or off***

- 1** ▶ **Settings** ▶ YES ▶ **Locks** ▶ YES ▶ **SIM Lock** ▶ YES ▶ **Protection** ▶ YES.
- 2** ▶ **On or Off** ▶ YES.
- 3** Enter your PIN ▶ YES.

### **Phone lock**

The phone lock protects the phone against unauthorized use if it is stolen and the SIM card is exchanged. It is not on when you buy the phone. You can change the phone lock code (**0000**) to any four- to eight-digit personal code. The phone lock can be set to on, automatic or off.

 *The phone lock code must be entered to use **Master Reset**.*  
 ➔ *45 Master reset for more information.*

## Phone lock on

If the phone lock is on, the message **Phone locked.** appears each time you turn on the phone. You have to enter your code followed by **YES** to use your phone.

## Automatic

If the phone lock is set to automatic, you do not need to enter your phone lock code until a different SIM card is inserted in the phone.

### ***To set the phone lock***

- 1 ▶ **Settings** ▶ **YES** ▶ **Locks** ▶ **YES** ▶ **Phonelock** ▶ **YES** ▶ **Protection** ▶ **YES.**
- 2 Select an alternative ▶ **YES.**
- 3 Enter the phone lock code ▶ **YES.**

## Editing the phone lock code

It is important that you remember your new code. If you should forget it, you have to hand in your phone to your local Sony Ericsson retailer.

### ***To edit your phone lock code***

- ▶ **Settings** ▶ **YES** ▶ **Locks** ▶ **YES** ▶ **Phonelock** ▶ **YES** ▶ **Change Code** ▶ **YES.**

## Memory status

Check for example, how many positions are left in your phonebook or how much memory is used.

### ***To check the memory of the phonebook***

- ▶ **Phonebook** ▶ **YES** ▶ **Memory Status** ▶ **YES.**

***To check the memory for pictures or sounds***

- 1 ▶ Fun & Games ▶ YES, select one of the menus ▶ YES.
- 2 Press  ▶ Memory Status ▶ YES.

***To check memory for text messages***

- ▶ Messaging ▶ YES ▶ Text Message ▶ YES ▶ Options ▶ YES
- ▶ Memory Status ▶ YES.

***To delete saved files or information***

Select a file or information, press  ▶ YES. Please note that some factory default files and information cannot be deleted.

## Troubleshooting

This chapter lists some problems that you might encounter while using your phone. Some problems require that you call your service provider, but most of the problems you can easily correct yourself.

### The phone cannot be switched on

#### Recharge or replace the battery

➔ 6 To insert the SIM card and battery.



#### No indication of charging

When you start charging a battery that is empty or a battery that has not been used for a long time, it may take up to 30 minutes before the battery icon appears in the display.

#### Menu language

If the display shows a language that you do not understand, you can always set the following from standby:

Press  0000  for English menus.

Press  8888  for automatic, local menus.

#### Grey menu options

Grey text indicates a function that is temporarily unavailable, for example, due to your subscription or due to a certain setting which has not been turned on.

Since you cannot send pictures and sounds that are copyright-protected, the **Send** menu is sometimes unavailable.



## Error messages

### Insert SIM

There is no SIM card in the phone, it may need cleaning or you may have inserted it incorrectly, ➤ *6 To insert the SIM card and battery.*

### Insert correct SIM card

The phone is set to work only with certain SIM cards. Insert the correct SIM card.

### Inactive SIM

The SIM card is not activated. Contact your network operator for more information.

### Emergency calls only

You are within range of a network, but you are not allowed to use it. However, in an emergency, some operators allow you to call, for example, the international emergency number 112, ➤ *16 Emergency calls.*

### No network

There is no network within range or the received signal is too weak. You have to move to get a signal that is strong enough.

### Wrong PIN/Wrong PIN2

You have entered your PIN or PIN2 incorrectly. Enter the correct PIN or PIN2, and press YES, ➤ *58 SIM card lock.*

### Codes do not match

When you want to change a security code (for example your PIN) you have to confirm the new code by entering it again. The two codes that you have entered do not match ➤ *58 SIM card lock.*

### **PIN blocked/PIN2 blocked**

You have entered your PIN or PIN2 incorrectly three times in a row. To unblock, ➡ *58 SIM card lock*.

### **PUK blocked – contact operator**

You entered your personal unblocking key code (PUK) incorrectly 10 times in a row. Contact your network operator or service provider.

### **Phone locked**

The phone is locked. To unlock the phone, ➡ *59 Phone lock*.

### **Phone lock code**

Your phone comes with the phone lock code, 0000. You can change it to any four- to eight-digit code, ➡ *59 Phone lock*.

### **Number not permitted**

The fixed dialing function is on and the number you have dialed is not on your fixed numbers list, ➡ *27 Fixed dialing*.

## Additional information

### Sony Ericsson Consumer Web site

On [www.SonyEricsson.com/support](http://www.SonyEricsson.com/support) there is a section where help and tips are only a few clicks away. Here you find the latest software updates and tips on how to use your product more efficiently.

### Service and support

From now on you will have access to a portfolio of exclusive service advantages such as:

- Global and local websites providing support.
- A global network of Call Centers.
- An extensive network of Sony Ericsson service partners.
- A warranty period. Learn more about the warranty conditions in this user guide.

On [www.SonyEricsson.com](http://www.SonyEricsson.com), under the support section in the language of your choice, you will find the latest support tools and information, such as software updates, Knowledgebase, Phone setup and additional help when you require it.

For operator-specific services and features, please contact your network operator for more information.

You can also contact our Call Centers. See the phone number for the nearest Call Center in the list below. If your country/region is not represented in the list, please contact your local dealer. (The phone numbers below were correct at the time of going to print. On [www.SonyEricsson.com](http://www.SonyEricsson.com) you can always find the latest updates.)

In the unlikely event that your product needs service, please contact the dealer from whom it was purchased or one of our service partners. Save your original proof of purchase, you will need it if you need to claim warranty.

*For a call to one of our Call Centers you will be charged according to national rates, including local taxes, unless the phone number is a toll-free number.*

Australia	1-300 650 050 questions.AU@support.sonyericsson.com
Argentina	800-333-7427 questions.AR@support.sonyericsson.com
Austria	0810 200245 questions.AT@support.sonyericsson.com
Belgium	02-7451611 questions.BE@support.sonyericsson.com
Brazil	4001-0444 questions.BR@support.sonyericsson.com
Canada	1-866-766-9374 questions.CA@support.sonyericsson.com
Central Africa	+27 112589023 questions.CF@support.sonyericsson.com
Chile	123-0020-0656 questions.CL@support.sonyericsson.com
China	4008100000 questions.CN@support.sonyericsson.com
Colombia	18009122135 questions.CO@support.sonyericsson.com
Croatia	062 000 000 questions.HR@support.sonyericsson.com
Czech Republic	844 550 055 questions.CZ@support.sonyericsson.com
Denmark	33 31 28 28 questions.DK@support.sonyericsson.com
Finland	09-299 2000 questions.FI@support.sonyericsson.com
France	0 825 383 383 questions.FR@support.sonyericsson.com
Germany	0180 534 2020 questions.DE@support.sonyericsson.com

66

Greece	801-11-810-810 210-89 91 919 (from mobile) questions.GR@support.sonyericsson.com
Hong Kong	8203 8863 questions.HK@support.sonyericsson.com
Hungary	01 437 7300 questions.HU@support.sonyericsson.com
India	39011111 (Add STD code from a GSM connection) questions.IN@support.sonyericsson.com
Indonesia	021-2701388 questions.ID@support.sonyericsson.com
Ireland	1850 545 888 questions.IE@support.sonyericsson.com
Italy	06 48895206 questions.IT@support.sonyericsson.com
Malaysia	03-78809800 questions.MY@support.sonyericsson.com
Mexico	001-95-888-821-8408 questions.MX@support.sonyericsson.com
Netherlands	0900 899 8318 questions.NL@support.sonyericsson.com
New Zealand	0800-100150 questions.NZ@support.sonyericsson.com
Norway	815 00 840 questions.NO@support.sonyericsson.com
Philippines	02-6351860 questions.PH@support.sonyericsson.com
Poland	0 (prefix) 22 6916200 questions.PL@support.sonyericsson.com
Portugal	808 204 466 questions.PT@support.sonyericsson.com

Romania	(+4021) 401 0401 questions.RO@support.sonyericsson.com
Russia	095 7870986 questions.RU@support.sonyericsson.com
Singapore	67440733 questions.SG@support.sonyericsson.com
Slovakia	02-5443 6443 questions.SK@support.sonyericsson.com
South Africa	0861 632222 questions.ZA@support.sonyericsson.com
Spain	902 180 576 questions.ES@support.sonyericsson.com
Sweden	013-24 45 00 questions.SE@support.sonyericsson.com
Switzerland	0848 824 040 questions.CH@support.sonyericsson.com
Taiwan	02-25625511 questions.TW@support.sonyericsson.com
Thailand	02-2483030 questions.TH@support.sonyericsson.com
Turkey	0212 47 37 777 questions.TR@support.sonyericsson.com
United Arab Emirates	43 919880 questions.AE@support.sonyericsson.com
United Kingdom	08705 23 7237 questions.GB@support.sonyericsson.com
United States	1-866-766-9374 questions.US@support.sonyericsson.com
Venezuela	0-800-100-2250 questions.VE@support.sonyericsson.com

## Guidelines for Safe and Efficient Use

Please read this information before using your mobile phone.

These instructions are intended for your safety. Please follow these guidelines. If the product has been subject to any of the conditions listed below or you have any doubt of the proper function make sure to have the product checked by certified service partner before charging or using it. Failure to do so might lead to risk for product malfunction or even a potential hazard to your health.

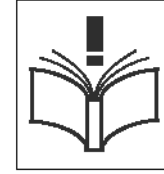

### Recommendations for safe use of product (mobile phone, battery, charger and other accessories)

- Always treat your product with care and keep it in a clean and dust-free place.
- **Warning!** May explode if disposed of in fire.
- Do not expose your product to liquid or moisture or humidity.
- Do not expose your product to extreme high or low temperatures. Do not expose the battery to temperatures above +60°C (+140°F).
- Do not expose your product to open flames or lit tobacco products.
- Do not drop, throw or try to bend your product.
- Do not paint your product.
- Do not attempt to disassemble or modify your product. Only Sony Ericsson authorised personnel should perform service.
- Do not use your product near medical equipment without requesting permission.
- Do not use your product when in, or around aircraft, or areas posted "turn off two-way radio".
- Do not use your product in an area where a potentially explosive atmosphere exists.
- Do not place your product or install wireless equipment in the area above your car's air bag.

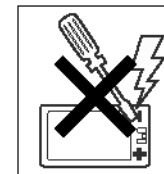
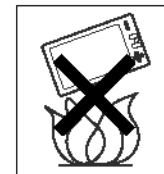
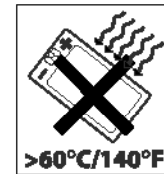

## CHILDREN

KEEP OUT OF CHILDRENS REACH. DO NOT ALLOW CHILDREN TO PLAY WITH YOUR MOBILE PHONE OR ITS ACCESSORIES. THEY COULD HURT THEMSELVES OR OTHERS, OR COULD ACCIDENTALLY DAMAGE THE MOBILE PHONE OR ACCESSORY. YOUR MOBILE PHONE OR ITS ACCESSORY MAY CONTAIN SMALL PARTS THAT COULD BE DETACHED AND CREATE A CHOKING HAZARD.



## Power supply (Charger)

Connect the AC power adapter only to designated power sources as marked on the product. Make sure the cord is positioned so that it will not be subjected to damage or stress. To reduce risk of electric shock, unplug the unit from any power source before attempting to clean it. The AC power adapter must not be used outdoors or in damp areas. Never alter the cord or plug. If the plug will not fit into the outlet, have a proper outlet installed by a qualified electrician.

Use only Sony Ericsson branded original chargers intended for use with your mobile phone. Other chargers may not be designed to the same safety and performance standards.

## Battery

We recommend that you fully charge the battery before you use your mobile phone for the first time. A new battery or one that has not been used for a long time could have reduced capacity the first few times it is used. The battery should only be charged in temperatures between +5°C (+41°F) and +45°C (+113°F).

Use only Sony Ericsson branded original batteries intended for use with your mobile phone. Using other batteries and chargers could be dangerous.

The talk and standby times depend on several different conditions such as signal strength, operating temperature, application usage patterns, features selected and voice or data transmissions when using the mobile phone.



Turn off your mobile phone before removing the battery. Do not allow the battery to be put into the mouth. Battery electrolytes may be toxic if swallowed. Do not let the metal contacts on the battery touch another metal object. This could short-circuit and damage the battery. Use the battery for the intended purpose only.

### **Personal medical devices**

Mobile phones may affect the operation of cardiac pacemakers and other implanted equipment. Please avoid placing the mobile phone over the pacemaker, e.g. in your breast pocket. When using the mobile phone, place it at the ear opposite the pacemaker. If a minimum distance of 15 cm (6 inches) is kept between the mobile phone and the pacemaker, the risk of interference is limited. If you have any reason to suspect that interference is taking place, immediately turn off your mobile phone. Contact your cardiologist for more information.

For other medical devices, please consult your physician and the manufacturer of the device.

### **Driving**

Please check if local laws and regulations restrict the use of mobile phones while driving or require drivers to use handsfree solutions. We recommend that you use only Sony Ericsson handsfree solutions intended for use with your product.

Please note that because of possible interference to electronic equipment, some vehicle manufacturers forbid the use of mobile phones in their vehicles unless a handsfree kit with an external antenna supports the installation.

Always give full attention to driving and pull off the road and park before making or answering a call if driving conditions so require.

### **Emergency calls**

Mobile phones operate using radio signals, which cannot guarantee connection under all conditions. Therefore you should never rely solely upon any mobile phone for essential communications (e.g. medical emergencies).

Emergency calls may not be possible in all areas, on all cellular networks, or when certain network services and/or mobile phone features are in use. Check with your local service provider.

## Antenna

This phone contains a built in antenna. Use of antenna devices not marketed by Sony Ericsson specifically for this model could damage your mobile phone, reduce performance, and produce SAR levels above the established limits (see below).

## Efficient use

Hold your mobile phone as you would any other phone. Do not cover the top of the phone when in use, as this affects call quality and may cause the phone to operate at a higher power level than needed, thus shortening talk and standby times.

## Radio frequency (RF) exposure and SAR

Your mobile phone is a low-power radio transmitter and receiver. When it is turned on, it emits low levels of radio frequency energy (also known as radio waves or radio frequency fields).

Governments around the world have adopted comprehensive international safety guidelines, developed by scientific organizations, e.g. ICNIRP (International Commission on Non-Ionizing Radiation Protection) and IEEE (The Institute of Electrical and Electronics Engineers Inc.), through periodic and thorough evaluation of scientific studies. These guidelines establish permitted levels of radio wave exposure for the general population. The levels include a safety margin designed to assure the safety of all persons, regardless of age and health, and to account for any variations in measurements. Specific Absorption Rate (SAR) is the unit of measurement for the amount of radio frequency energy absorbed by the body when using a mobile phone. The SAR value is determined at the highest certified power level in laboratory conditions, but the actual SAR level of the mobile phone while operating can be well below this value. This is because the mobile phone is designed to use the minimum power required to reach the network.

Variations in SAR below the radio frequency exposure guidelines do not mean that there are variations in safety. While there may be differences in SAR levels among mobile phones, all Sony Ericsson mobile phone models are designed to meet radio frequency exposure guidelines.

For phones sold in the U.S., before a phone model is available for sale to the public, it must be tested and certified to the FCC that it does not exceed the limit established by the government-adopted requirement for safe exposure. The tests are performed in positions and locations (that is, at the ear and worn on the body) as required by the FCC for each model. For body worn operation, this phone has been tested and meets FCC RF exposure guidelines when the handset is positioned a minimum of 15 mm from the body without any metal parts in the vicinity of the phone or when used with the original Sony Ericsson body worn accessory intended for this phone. Use of other accessories may not ensure compliance with FCC RF exposure guidelines.

A separate leaflet with SAR information for this mobile phone model is included with the material that comes with this mobile phone. This information can also be found, together with more information on radio frequency exposure and SAR, on: [www.SonyEricsson.com](http://www.SonyEricsson.com).

### **Accessible Solutions/Special Needs**

For phones sold in the U.S., you can use your TTY terminal with your Sony Ericsson mobile phone (with the necessary accessory). For information on Accessible Solutions for individuals with special needs call the Sony Ericsson Special Needs Center at 877 878 1996 (TTY) or 877 207 2056 (voice), or visit the Sony Ericsson Special Needs Center at [www.SonyEricsson-snc.com](http://www.SonyEricsson-snc.com).

### **Disposal of old electrical & electronic equipment**

This symbol on the product or on its packaging indicates that this product shall not be treated as household waste. Instead it shall be handed over to the applicable collection point for the recycling of electrical and electronic equipment. By ensuring this product is disposed

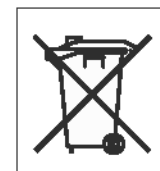

of correctly, you will help prevent potential negative consequences for the environment and human health, which could otherwise be caused by inappropriate waste handling of this product. The recycling of materials will help to conserve natural resources. For more detailed information about recycling of this product, please contact your local city office, your household waste disposal service or the shop where you purchased the product.

### **Disposing of the battery**

Please check local regulations for disposal of batteries or call your local Sony Ericsson Call Center for information.

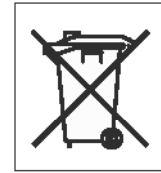

The battery should never be placed in municipal waste. Use a battery disposal facility if available.

### **End User Licence Agreement**

This wireless device ("Device") contains software owned by Sony Ericsson Mobile Communications AB ("Sony Ericsson") and its affiliated companies ("Sony Ericsson") and its third party suppliers and licensors ("Software").

As user of this Device, Sony Ericsson grants you a non-exclusive, non-transferable, non-assignable license to use the Software solely in conjunction with the Device on which it is installed. Nothing herein shall be construed as a sale of the Software to a user of this Device.

You shall not reproduce, modify, distribute, reverse engineer, decompile, otherwise alter or use any other means to discover the source code of the Software or any component of the Software. For avoidance of doubt, you are at all times entitled to transfer all rights and obligations to the Software to a third party, solely together with the Device with which you received the Software, provided always that such third party agrees in writing to be bound by these rules.

You are granted this license for a term of the useful life of this Device. You can terminate this license by transferring all your rights to the Device on which you have received the Software to a third party in writing. If you fail to comply with any of the terms and conditions set out in this license, it will terminate with immediate effect.

Sony Ericsson and its third party suppliers and licensors are the sole and exclusive owner of and retain all rights, title and interest in and to the Software. Sony Ericsson, and, to the extent that the Software contains material or code of a third party, such third party, shall be entitled third party beneficiaries of these terms.

The validity, construction and performance of this license shall be governed by the laws of Sweden. The foregoing shall apply to the full extent permitted by, when applicable, statutory consumer rights.

## Limited Warranty

Sony Ericsson provides this Limited Warranty for your mobile phone and original accessory delivered with your mobile phone (hereinafter referred to as "Product").

Should your Product need warranty service, please return it to the dealer from whom it was purchased, or contact your local Sony Ericsson Call Center (national rates may apply) or visit [www.SonyEricsson.com](http://www.SonyEricsson.com) to get further information.

## Our warranty

Subject to the conditions of this Limited Warranty, Sony Ericsson warrants this Product to be free from defects in design, material and workmanship at the time of its original purchase by a consumer, and for a subsequent period of one (1) year.

## What we will do

If, during the warranty period, this Product fails to operate under normal use and service, due to defects in design, materials or workmanship, Sony Ericsson authorised distributors or service partners, in the country/region\* where you purchased the Product, will, at their option, either repair or replace the Product in accordance with the terms and conditions stipulated herein.

Sony Ericsson and its service partners reserve the right to charge a handling fee if a returned Product is found not to be under warranty according to the conditions below.

Please note that some of your personal settings, downloads or other information may be lost when your Sony Ericsson Product is repaired or replaced. At present Sony Ericsson may be prevented by applicable law, other regulation or technical restrictions from making a backup copy of certain downloads. Sony Ericsson does not take any responsibility for any lost information of any kind and will not reimburse you for any such loss. You should always make backup copies of all the information stored on your Sony Ericsson Product such as downloads, calendar and contacts before handing in your Sony Ericsson Product for repair or replacement.

### Conditions

- 1** The warranty is valid only if the original proof of purchase issued to the original purchaser by a Sony Ericsson authorised dealer, specifying the date of purchase and serial number\*\*, for this Product, is presented with the Product to be repaired or replaced. Sony Ericsson reserves the right to refuse warranty service if this information has been removed or changed after the original purchase of the Product from the dealer.
- 2** If Sony Ericsson repairs or replaces the Product, the repaired or replaced Product shall be warranted for the remaining time of the original warranty period or for ninety (90) days from the date of repair, whichever is longer. Repair or replacement may involve the use of functionally equivalent reconditioned units. Replaced parts or components will become the property of Sony Ericsson.
- 3** This warranty does not cover any failure of the Product due to normal wear and tear, or due to misuse, including but not limited to use in other than the normal and customary manner, in accordance with the Sony Ericsson instructions for use and maintenance of the Product. Nor does this warranty cover any failure of the Product due to accident, software or hardware modification or adjustment, acts of God or damage resulting from liquid. A rechargeable battery can be charged and discharged hundreds of times. However, it will eventually wear out – this is not a defect. When the talk-time or standby time is noticeably shorter, it is time to replace your battery. Sony Ericsson recommends that you use only batteries and chargers approved by Sony Ericsson.

Minor variations in display brightness and color may occur between phones. There may be tiny bright or dark dots on the display. These are called defective pixels and occur when individual dots have malfunctioned and can not be adjusted. Two defective pixels are deemed acceptable. Minor variations in camera image appearance may occur between phones. This is nothing uncommon and is not regarded as a defective camera module.

- 4 Since the cellular system on which the Product is to operate is provided by a carrier independent from Sony Ericsson, Sony Ericsson will not be responsible for the operation, availability, coverage, services or range of that system.
- 5 This warranty does not cover Product failures caused by installations, modifications, or repair or opening of the Product performed by a non-Sony Ericsson authorised person.
- 6 The warranty does not cover Product failures which have been caused by use of accessories or other peripheral devices which are not Sony Ericsson branded original accessories intended for use with the Product.
- 7 Tampering with any of the seals on the Product will void the warranty.
- 8 THERE ARE NO EXPRESS WARRANTIES, WHETHER WRITTEN OR ORAL, OTHER THAN THIS PRINTED LIMITED WARRANTY. ALL IMPLIED WARRANTIES, INCLUDING WITHOUT LIMITATION THE IMPLIED WARRANTIES OF MERCHANTABILITY OR FITNESS FOR A PARTICULAR PURPOSE, ARE LIMITED TO THE DURATION OF THIS LIMITED WARRANTY. IN NO EVENT SHALL SONY ERICSSON OR ITS LICENSORS BE LIABLE FOR INCIDENTAL OR CONSEQUENTIAL DAMAGES OF ANY NATURE WHATSOEVER, INCLUDING BUT NOT LIMITED TO LOST PROFITS OR COMMERCIAL LOSS; TO THE FULL EXTENT THOSE DAMAGES CAN BE DISCLAIMED BY LAW.

Some countries/states do not allow the exclusion or limitation of incidental or consequential damages, or limitation of the duration of implied warranties, so the preceding limitations or exclusions may not apply to you.

The warranty provided does not affect the consumer's statutory rights under applicable legislation in force, nor the consumer's rights against the dealer arising from their sales / purchase contract.

### **\*EUROPEAN UNION (EU)**

If you have purchased your Product in an EU country you can have your Product serviced, under the conditions set out above, within the warranty period in any EU country where an identical Product is sold by an authorised Sony Ericsson distributor. To find out if your Product is sold in the EU country you are in, please call the local Sony Ericsson Call Center. Please observe that certain services may not be possible elsewhere than in the country of original purchase, for example due to the fact that your Product may have an interior or exterior which is different from equivalent models sold in other EU countries. It may not be possible to repair SIM-locked Products.

\*\* In some countries/regions additional information is requested. If so, this is clearly shown on the valid proof of purchase.

### **FCC Statement**

This device complies with Part 15 of the FCC rules. Operation is subject to the following two conditions:

(1) This device may not cause harmful interference, and (2) This device must accept any interference received, including interference that may cause undesired operation.





# Index

## A

alarm clock 55  
answering mode 44  
ask to save 18  
assembling, phone 6  
automatic redialing 16

## B

battery  
    charging 7  
    inserting 7  
buttons 8

## C

calculator 56  
calendar 56  
call costs 21  
    credit limit 23  
call time 21  
calling  
    from call list 17  
calls  
    accept 29  
    answering 15  
    automatic redialing 16  
    emergency 16  
    fixed dialing 27

    forwarding 23  
    making 8, 15  
    missed 15  
    put on hold 24  
    receiving 8  
    restrict 26

charging, battery 7

codes

    PIN 8

    PUK 8

conference calls 25

connectors 8

contrast (display) 43

## D

display  
    contrast 43  
    icons 9  
    light 43  
downloading 54

## E

emergency calls 16  
emergency numbers 16  
error messages 63

## F

fixed dialing 27

**G**

games 57  
     memory status 60  
 GPRS 48  
 groups  
     closed user groups 28  
     conference calls 25  
 groups. see phonebook 21  
 GSM 49  
 GSM frequencies 2

**H**

handsfree 44

**I**

icons, in display 9  
 Internet  
     bookmarks 53  
     downloading 54  
     options 53  
     security 51  
     setting up 46

**K**

key sound 42  
 keys 8

**L**

language  
     changing 12  
     in phone 12  
 locks  
     phone 59  
     SIM card 58

**M**

Main menu view 10  
 master reset 45  
 melodies, see ringtones 40  
 memory status 60  
 messages. see text messages  
 missed calls 15  
 my numbers 44

**O**

own number 44

**P**

personal ringtones 17  
 phone language 12  
 phone lock 59  
 phone overview 8  
 phonebook 17  
     ask to save 18  
     card memory 19  
     delete a phone number 19

edit a name 19  
 edit a phone number 19  
 groups 21  
 memory 19  
 memory status 60  
 phone memory 19  
 replacing entries 20  
 shortcuts 18  
 sort order 19  
 picture messages 35  
 pictures 39  
     exchange 40  
     memory status 60  
     send 40  
     wallpaper 40  
 PIN  
     change 59  
     PIN2 59  
 profiles 44  
 PUK 58

**R**  
 redialing 16  
 reset 45  
 ringtones 40

**S**  
 security  
     Internet 51  
     phone lock 59  
     SIM card 58  
 send a message 31  
 service center 31  
 silent ringtone 41  
 SIM card  
     copy phonebook entries 20  
     inserting 7  
     lock 58  
     unblock 58  
 SMS. see text messages  
 speed dial 18  
 stopwatch 55  
 Style-Up cover 38

**T**  
 text messages  
     call phone number 35  
     delete 35  
     forward 35  
     insert item 31  
     memory status 60  
     options 33  
     reply 34  
     save 35  
     send 31

themes 39  
memory status 60  
time settings 43

**U**  
unblocking  
PIN 8

**V**  
vibrating alert 42  
voice mail 21

**W**  
warranty 75

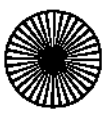
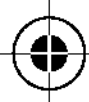
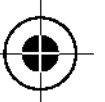
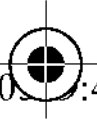
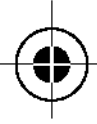
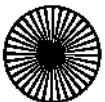

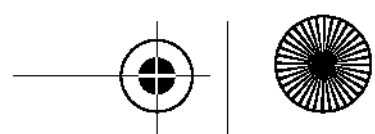
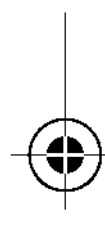
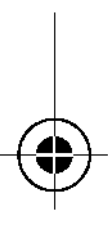
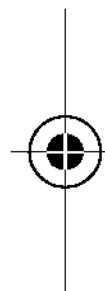
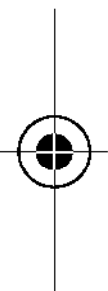
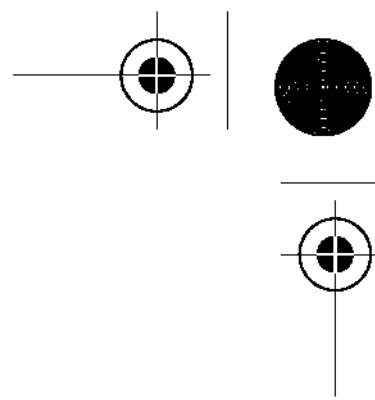
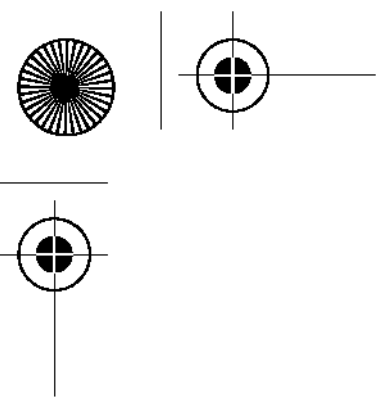

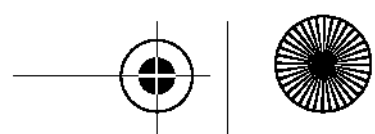
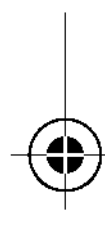
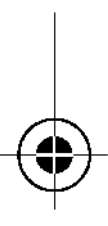
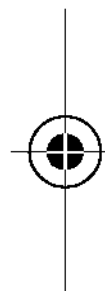
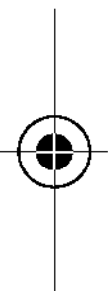
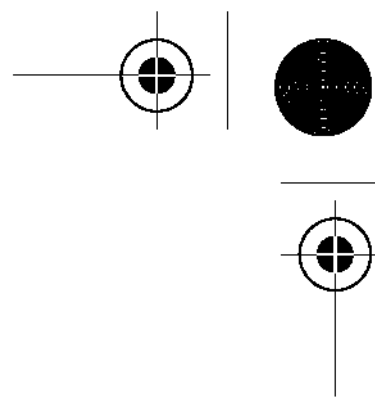
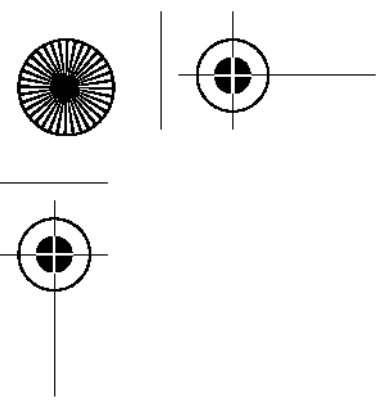

[www.SonyEricsson.com](http://www.SonyEricsson.com)



Sony Ericsson Mobile Communications AB  
SE-221 88 Lund, Sweden

AE/LZT 108 8127 R1A

Printed in XXX.