



# SO-02C

## INSTRUCTION MANUAL

1XX.X

## DOCOMO

### W-CDMA, GSM/GPRS and Wireless LAN Systems

Thank you for your purchase of "SO-02C".

For proper use of the SO-02C, read this manual and each manual attached to other optional devices carefully before and while you use the SO-02C. For more information on manuals, contact "General Inquiries" on the last page of this manual.

SO-02C is the efficient partner of yours. Please handle the SO-02C with care and use it regularly for a long time.

#### Before using the FOMA terminal

- Because a FOMA terminal operates using radio frequencies, it cannot be used inside a tunnel, underground, in a building or other locations where radio waves do not reach the FOMA terminal, in locations with weak radio wave condition, or outside of the FOMA's service area. The FOMA services may not be available on high upper floors of high-rise apartments or buildings, even if you can see no obstructions around you. On occasion, your calls may become disconnected even in areas with strong radio wave condition, even if you are not moving, or even if there are 4-antenna marks in the FOMA terminal's display.
- Please use discretion and mind your manners when using the FOMA terminal in public areas or crowded/quiet places to keep from bothering others.
- Note that because the FOMA terminal operates on radio frequencies, your calls are at risk of being intercepted by the third party. However, the W-CDMA, GSM/GPRS system automatically scrambles all calls through a private call feature. Therefore, even if third party successfully intercepts your call, they will only hear noise.
- The FOMA terminal operates on radio frequencies by converting voice into digital signals. If the caller moves into an area of adverse radio wave condition, the digital signal may not be restored accurately, and the voice received in the call may differ slightly from the actual voice.
- This FOMA terminal has FOMA Plus-Area and FOMA HIGH-SPEED Area support.
- The FOMA terminal can be used only via the FOMA network provided by DOCOMO and DOCOMO's roaming area.
- Always keep the information you save in the FOMA terminal in a separate note. Even if the data may be lost as a result of malfunction, repair, change, or other handling of the FOMA terminal, under no condition will DOCOMO be held liable for any lost data saved in the FOMA terminal.
- As with PCs, some user-installed applications may disrupt the stability of the FOMA terminal performance, or unexpectedly transmit information via the Internet causing improper use of your location information as well as personal information recorded on the terminal. Therefore, verify the supplier and operating conditions of the applications to be used before using them.



## About manuals of SO-02C

In addition to this manual, the operations of SO-02C are described in "Quick Start Guide" (in Japanese only) and "SO-02C e トリセツ (取扱説明書)" (SO-02C e Instruction manual)\* application of the FOMA terminal.

### "Quick Start Guide" (Supplied accessories)

The initial operations and settings after purchasing the FOMA terminal, screen view contents and operations of main function are explained. (In Japanese only)

### "Instruction Manual" (Application of the FOMA terminal)

Similarly to this manual, operations and settings of each function are explained. To use "SO-02C e トリセツ (取扱説明書)" (SO-02C e Instruction manual)\* application, from the Home screen, tap   [Instruction Manual]. For the first time using, download and install it according to the onscreen instructions. You can use the application as an electronic book. You can also shift to actual operations by tapping the description in the contents or view reference contents.

### ❖ Cautions

- For downloading or updating the application, a high packet communication charge will be applied because of a large amount data communication. For this reason, subscription of packet flat-rate service is highly recommended.
  - \* If you use Wi-Fi function to download, packet communication charges are not applied.

### "Instruction Manual" (PDF file)

Operations and settings of each function are explained.

It can be downloaded from NTT DOCOMO website.







<http://www.nttdocomo.co.jp/support/trouble/manual/download/index.html>







\* The URL and contents are subject to change without prior notice.

### ❖ Cautions

- Reproduction or reprint of all or part of this manual without prior permission is prohibited.
- Important information for SO-02C is posted in the following website. Be sure to check before using.  
[http://www.sonyericsson.co.jp/support/use\\_support/product/so-02c/](http://www.sonyericsson.co.jp/support/use_support/product/so-02c/)

## Operation descriptions

In this manual, each key operations are described with , , , , , . And selection operations of the icons or function items on the touch panel are described as follows.

Description	Operation
<b>From the Home screen, press  and tap [Settings].</b>	From the Home screen, press  (Menu) key and tap "Settings" on the screen.
<b>Tap [Settings] ► [Date &amp; time] ► [Set date].</b>	Tap "Settings" displayed on the screen, and then tap "Date & time" on the next screen and "Set date" on the following screen in order.
<b>Tap  or  to adjust the date.</b>	Tap  or  displayed on the screen and adjust the date.
<b>Touch and hold the title bar of the folder.</b>	Keep touching the title bar of the folder longer (1-2 seconds).

### ❖ Information

- In this manual, the instructions are described with the default Home screen. If you set the other application to the home screen, the operations may differ from the descriptions.
- Display examples and illustrations used in this manual are just images for explanations and may be different from actual ones.
- In this manual, the easier procedure is described for the functions and settings which have multiple operating procedures.

- Please note that "SO-02C" is called the "FOMA terminal" in this "Instruction Manual".

## Accessories and main options

### Supplied accessories

- SO-02C (with warranty and Back Cover SO14)

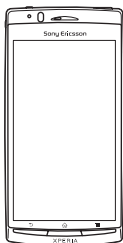

- Quick Start Guide (In Japanese only)

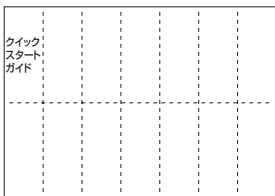

- Notes on usage  
Safety/Handling precautions

- Battery Pack SO05

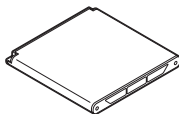

- AC Adapter Cable SO02 (with warranty)

<AC adapter>

<microUSB cable>

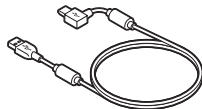
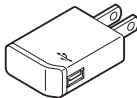

- microSDHC card (16GB)\* (Sample)



\* Inserted in the FOMA terminal when purchased.

- Stereo Headset with Microphone (Sample)



## Contents

About manuals of SO-02C . . . . .	1
Accessories and main options . . . . .	3
Safety Precautions (Always follow these directions) . . . . .	9
Handling precautions . . . . .	17



<b>Before Using the Handset</b> → P.23	• Part names and functions . . . . .	23
	• UIM . . . . .	24
	• microSD card . . . . .	25
	• Charging . . . . .	26
	• Turning power on and off . . . . .	30
	• Initial settings (Setup guide) . . . . .	31
	• Status bar . . . . .	32
	• Notification panel . . . . .	34
	• Notification LED . . . . .	34
	• Basic operations . . . . .	35
	• Home screen . . . . .	38
	• Searching information in the FOMA terminal and web pages . . . . .	42
	• Applications screen . . . . .	43
• Character entry . . . . .	46	
• Settings of entering characters . . . . .	53	
• Settings of Japanese keyboard . . . . .	53	
<b>Calling/Network Services</b> → P.57	• Making/Receiving calls . . . . .	57
	• Call log . . . . .	60
	• Contacts . . . . .	61
	• Network Services . . . . .	71

<b>Settings</b> → P.79	<ul style="list-style-type: none"> <li>• Viewing the setting menu ..... 79</li> <li>• Wireless &amp; networks ..... 79</li> <li>• Call settings ..... 86</li> <li>• Sound ..... 87</li> <li>• Display ..... 89</li> <li>• Location &amp; security ..... 90</li> <li>• Applications ..... 95</li> <li>• Accounts &amp; sync ..... 97</li> <li>• Privacy ..... 100</li> <li>• Storage ..... 101</li> <li>• Language &amp; keyboard ..... 102</li> <li>• Voice input &amp; output ..... 102</li> <li>• Accessibility ..... 103</li> <li>• Date &amp; time ..... 103</li> <li>• About phone ..... 104</li> </ul>
<b>Mail/Internet</b> → P.105	<ul style="list-style-type: none"> <li>• Email ..... 105</li> <li>• sp-mode mail ..... 110</li> <li>• Using Gmail ..... 111</li> <li>• Google Talk (Chat) ..... 111</li> <li>• Message (SMS) ..... 112</li> <li>• Using Browser ..... 114</li> </ul>
<b>Multimedia</b> → P.120	<ul style="list-style-type: none"> <li>• Using the camera ..... 120</li> <li>• Playing multimedia content ..... 133</li> <li>• Viewing photos/videos with Gallery ..... 134</li> <li>• Playing video with YouTube ..... 138</li> <li>• Connecting the FOMA terminal to TV to watch photos and videos ..... 139</li> <li>• Music player ..... 140</li> <li>• TrackID ..... 143</li> </ul>
<b>File management</b> → P.144	<ul style="list-style-type: none"> <li>• Handling a file ..... 144</li> <li>• Transferring and moving data ..... 144</li> <li>• Using Bluetooth function ..... 149</li> <li>• Sharing files with DLNA devices via Media server ..... 153</li> </ul>

<p><b>Applications</b> → P.154</p>	<ul style="list-style-type: none"> <li>• Using Android Market ..... 154</li> <li>• Using DOCOMO Market ..... 154</li> <li>• Timescape™ ..... 155</li> <li>• About location services ..... 159</li> <li>• FM radio ..... 165</li> <li>• Calendar ..... 166</li> <li>• Clock/Alarm ..... 168</li> <li>• Evernote ..... 170</li> <li>• OfficeSuite ..... 170</li> <li>• Other applications ..... 170</li> </ul>
<p><b>Overseas use</b> → P.173</p>	<ul style="list-style-type: none"> <li>• Overview of International roaming (WORLD WING) ..... 173</li> <li>• Available Services ..... 173</li> <li>• Before using ..... 174</li> <li>• Making/Receiving calls in the country you stay ..... 178</li> </ul>
<p><b>Appendix/Index</b> → P.180</p>	<ul style="list-style-type: none"> <li>• Optional and related devices ..... 180</li> <li>• Troubleshooting ..... 180</li> <li>• Warranty and After Sales Services ..... 185</li> <li>• Updating software ..... 188</li> <li>• Main specifications ..... 190</li> <li>• Specific Absorption Rate of Mobile Phone, etc. .... 193</li> <li>• End User Licence Agreement ..... 206</li> <li>• About Open Source Software ..... 207</li> <li>• Export Controls and Regulations ..... 208</li> <li>• Intellectual Property Right ..... 208</li> <li>• Index ..... 211</li> </ul>





## Notes on usage

- The FOMA terminal does not support i-mode sites (programs) or i-αpli.
- The FOMA terminal automatically performs communication for synchronizing data, checking the latest software version, maintain connection with the server, etc. If you transmit a large amount of data such as downloading applications or watching movie, a packet communication charge becomes high. Subscription of packet flat-rate service is highly recommended.
- This FOMA terminal cannot be used as a modem.
- Public mode (Driving mode) is not supported.
- Setting the phone to silent mode does not mute sounds (playback of video or music, alarm, etc.) other than the ring tone, operation sound, and notification sounds.
- The names of the operators are displayed when the screen is locked.
- Your phone number (own number) can be checked as follows:  
From the Home screen, press  and tap [Settings] ► [About phone] ► [Status].
- The software version of your FOMA terminal can be checked as follows:  
From the Home screen, press  and tap [Settings] ► [About phone].
- You can perform software update by downloading an update file with a PC via Internet and connecting the PC to the FOMA terminal. For details, see "Connecting to a PC and updating" (P.189).
- By some software updates, the operating system (OS) may be version-upgraded for improving the FOMA terminal quality. For this reason, you always need to use the latest OS version. And some applications that used in the previous OS version may not be available or some unintended bugs may occur.
- When using the FOMA terminal inserting some UIM other than UIM (FOMA card) (white), voice calls and packet communication may not be available in some overseas networks. For using overseas, please visit a docomo Shop near you. DOCOMO exchanges UIM (FOMA card) (green) for UIM (FOMA card) (white) free of charge.
- Set the screen lock to ensure the security of your FOMA terminal for its loss. For details, see "Screen lock" (P.93).

- If your FOMA terminal is lost, change your each account password to invalidate authentication using a PC to prevent other persons from using Google services such as Google Talk, Gmail, Android Market, etc., Facebook, Twitter and mixi.
- The FOMA terminal supports only sp-mode, mopera U and Business mopera Internet. Other providers are not supported.

## Safety Precautions (Always follow these directions)

- For safe and proper use of the FOMA terminal, please read the "Safety Precautions" prior to use. Keep the Manual in a safe place for future reference.
- ALWAYS observe the safety precautions since they intend to prevent personal injury or property damage.
- The following symbols indicate the different levels of injury or damage that may result if the guidelines are not observed and the FOMA terminal is used improperly.

 <b>DANGER</b>	Failure to observe these guidelines may immediately result in death or serious injury.
 <b>WARNING</b>	Failure to observe these guidelines may result in death or serious injury.
 <b>CAUTION</b>	Failure to observe these guidelines may result in injury and property damage.

- The following symbols indicate specific directions.

 Don't	Indicates prohibited actions.
 No disassembly	Indicates not to disassemble.
 No wet hands	Indicates not to handle with wet hands.
 No liquids	Indicates not to use where it could get wet.
 Do	Indicates compulsory actions in accordance with instructions.
 Unplug	Indicates to remove the power plug from the outlet.

- "Safety Precautions" are described in the following categories:
  1. Handling the FOMA terminal, Battery Pack, AC Adapter cable, and UIM (general)..... 10
  2. Handling the FOMA terminal ..... 11
  3. Handling the Battery Pack ..... 13
  4. Handling the AC Adapter cable..... 14
  5. Handling the UIM ..... 15
  6. Handling the FOMA terminal near electronic medical equipment..... 16
  7. Material list ..... 17

## 1. Handling the FOMA terminal, Battery Pack, AC Adapter cable, and UIM (general)

### DANGER



Don't

Do not use, store, or leave the FOMA terminal, battery pack, AC adapter cable, or UIM in a place subject to high temperature such as close to fire, under direct sunlight, or in a car on an extremely hot day. Doing so may cause fire, burns or injury.



Don't

Do not place the FOMA terminal, battery pack, AC adapter cable, or UIM inside cooking appliance such as a microwave oven or high-pressure containers. Doing so may cause fire, burns, injury or electric shock.



No disassembly

Do not disassemble or modify the FOMA terminal, battery pack, AC adapter cable, or UIM. Doing so may cause fire, burns, injury or electric shock.



No liquids

Do not let the FOMA terminal, battery pack, AC adapter cable, or UIM get wet with water, drinking water, urine of pet animals, etc. Doing so may cause fire, burns, injury or electric shock.



Do

Use the battery pack and AC adapter cable for the FOMA terminal specified by DOCOMO. Failure to do so may cause fire, burns, injury or electric shock.

### WARNING



Don't

Do not subject the FOMA terminal, battery pack, AC adapter cable, or UIM to excessive force or throw it. Doing so may cause fire, burns, injury or electric shock.



Don't

Do not allow the microUSB connection jack, headset connection jack or HDMI connection jack to come in contact with conducting foreign substances (a piece of metal, pencil lead, etc.). Never allow these objects to get into the connection jack. Doing so may cause fire, burns, injury or electric shock.



Don't

Do not cover or wrap the FOMA terminal, battery pack, AC adapter cable, or UIM with a cloth or bedding in use or while charging. Doing so may cause fire or burns.



Do

Power off the FOMA terminal before you step into a place where flammable gas can leak, such as gas stations. Do not charge the battery. Gas may catch fire.



Do

If you notice anything unusual about the FOMA terminal, battery pack, AC adapter cable, or UIM such as an unusual odor, overheating, discoloration or deformation during operation, charging or storage, immediately perform the following measures.

- Remove the power plug from the power outlet.
- Power off the FOMA terminal.
- Remove the battery pack from the FOMA terminal.

Failure to do so may cause fire, burns, injury or electric shock.

## CAUTION



Don't

Do not place on an unstable or inclined platform.  
Doing so may cause the device to fall and cause injury.



Don't

Do not keep in a place that is very humid, dusty, or subject to high temperature.  
Doing so may cause fire, burns or electric shock.



Do

If children use the FOMA terminal, parents or guardians should give them the proper instructions for use. Make sure that they use the FOMA terminal as instructed.  
Failure to do so may cause injury.



Do

Keep the FOMA terminal, battery pack, AC adapter cable, or UIM out of the reach of babies and infants.  
Failure to do so may cause accidental swallowing or injury.



Do

Be careful especially when you use the FOMA terminal while it has been continuously connected to the AC adapter cable for a long period of time.  
If you play a game etc. while charging for a long time, the temperature of the FOMA terminal, battery pack and AC adapter cable may rise.  
If you are directly in contact with hot parts for a long period of time, it may cause your skin to become red, itch, or develop a rash depending on your physical condition and also it may cause low-temperature burn.

## 2. Handling the FOMA terminal



## WARNING



Don't

Do not light up the flash/photo light in front of person's eyes since strong light is emitted from the FOMA terminal.  
Also, do not look straight the light-emitting part when the flash/photo light lights up.  
Failure to do so may cause reduce visual acuity. Especially to shoot infants or young children, step away from them more than 1 m.



Don't

Do not allow a foreign substance such as water and other liquids, metal parts, or flammables to get in the UIM or microSD card insertion slot on the FOMA terminal.  
Doing so may cause fire, burns, injury or electric shock.



Don't

Do not turn on the light toward a driver of a car etc.  
Doing so may disturb driving and cause an accident.

## **WARNING**

Power off the FOMA terminal in a place where the use is prohibited such as in airplane or hospital.

Failure to do so may affect electronic equipment and electronic medical equipment. If you set the automatic power-on function, cancel it before powering off the FOMA terminal.

Follow the instructions of each medical facility for the use of mobile phones on their premises.

Prohibited acts such as mobile phone usage on board an airplane may be punished by law.

If the microUSB cable is connected into the microUSB connection jack for charging etc., the FOMA terminal is automatically powered on. Be careful not to connect the microUSB cable in a place where the use is prohibited such as in airplane or hospital.

**Always keep the FOMA terminal away from your ear when you talk setting the hands-free function.**

**Also, when you play game or play back music connecting the Earphone/Microphone, etc. to the FOMA terminal, adjust the volume adequately.**

If the volume is too loud, it may cause difficulty in hearing. Moreover, if you barely hear the surrounding sounds, it may cause an accident.

**If you have a weak heart, set the vibrator or ringtone volume carefully.**

Failure to do so may affect your heart.



Do



Do



Do

## **WARNING**

If you are wearing any electronic medical equipment, check with the relevant medical electronic equipment manufacturer or vendor whether the operation may be affected by radio waves.

The radio waves from the FOMA terminal may affect electronic medical equipment.

**Power off the FOMA terminal near electronic devices or equipment operating on high precision control or weak signals.**

Failure to do so may interfere with the operation of electronic devices or equipment.

\* The followings are some electronic devices or equipment that you should be careful of: Hearing aids, implantable cardiac pacemaker, implantable cardioverter defibrillator, other electronic medical equipment, fire detector, automatic door, and other automatically controlled devices or equipment.

If you use an implantable cardiac pacemaker, implantable cardioverter defibrillator, or other electronic medical equipment, check with the relevant medical electronic equipment manufacturer or vendor whether the operation can be affected by radio waves.

**Be careful about broken glasses or exposed internal from the FOMA terminal if the display or the camera lens is broken.**

Shatterproof film-applied hardened glass is used on the display surface and the acrylic resin is applied on camera lens so as not to be shattered when broken. But they may cause injury if you touch a cut surface or exposed portion mistakenly.



Do



Do



Do

## CAUTION



Don't

Do not swing the FOMA terminal around by holding the strap. The FOMA terminal may hit you or others and cause accident such as injury.



Don't

Do not use damaged FOMA terminal. Doing so may cause fire, burns, injury or electric shock.

If the display is mistakenly damaged and when the liquid crystal runs out, do not get it on your skin such as face, hands, etc. Doing so may cause blindness or injury on your skin.



Don't

If the liquid crystal gets in your eye or mouth, rinse with clean running water, and get medical treatment immediately. Also, if it gets on your skin or clothes, use something such as alcohol to wipe off and wash it with soap in clear water.

To use the FOMA terminal in car, check with automobile manufacturer or dealer to determine how the device is affected by radio waves before using.



Do

In rare cases, using the phone in some vehicle models can cause the vehicle's electronic equipment to malfunction. In that case, stop using the FOMA terminal immediately.

The use of the FOMA terminal may cause itching, rashes, eczema, or other symptoms depending on the user's physical condition. Immediately stop using and get medical treatment in such a case.



Do

For material of each part, see "7. Material list" (P.17).

## CAUTION



Do

When watching the display, take a certain distance from the display in a fully bright place. Failure to do so may reduce visual acuity.

## 3. Handling the Battery Pack

- Check the type of the battery by the label on the battery pack.

Display	Type of Battery
Li-ion 00	Lithium Ion Battery

## DANGER



Don't

Do not touch the battery pack terminal with a metal object such as a wire. Also, do not carry or keep the battery pack together with metal objects such as a necklace. Doing so may cause battery pack to ignite, explode, overheat or leak.



Don't

Check the orientation of battery pack to install it to the FOMA terminal, and do not forcibly attach the battery pack to FOMA terminal if you are having trouble installing it. Doing so may cause battery pack to ignite, explode, overheat or leak.



Don't

Do not throw the battery pack into fire. Doing so may cause battery pack to ignite, explode, overheat or leak.



Don't

Do not stick a nail into the battery pack, hit it with a hammer, or step on it. Doing so may cause battery pack to ignite, explode, overheat or leak.

## DANGER



Do

If the battery fluid gets into your eyes, do not rub, rinse with clean running water, and get medical treatment immediately.

Failure to do so may cause blindness.

## WARNING



Don't

If the battery pack seems to have abnormalities such as deformation or scratches due to falling, never use it.

Doing so may cause battery pack to ignite, explode, overheat or leak.



Do

If the battery pack leaks or hears an unusual odor, immediately stop using and move it away from fire.

The leaking liquid may ignite fire, catch fire, or explode.



Do

Be careful about your pet not to bite the battery pack.

Failure to do so may cause battery pack to ignite, explode, overheat or leak.

## CAUTION



Don't

Do not discard the battery pack together with other garbage.

The battery pack may become the source of fire or environmental destruction. Take the used battery pack to our service counter (docomo Shop, etc.) after insulating it by affixing an adhesive tape on the terminal of it or follow the instructions of the local authorities in charge of collecting used battery packs.

## CAUTION



Don't

Do not use or charge the wet battery pack. Doing so may cause battery pack to ignite, explode, overheat or leak.

If fluid etc. leaks out from battery pack, do not make the fluid contact with your skin or face or hands.

Doing so may cause blindness or injury on your skin.

If the fluid etc. put into your eyes or mouth, or contacts skin or clothes, immediately flush the contacted area with clean running water.

If the fluid put into the eyes or mouth, immediately see a doctor after flushing.



Do

## 4. Handling the AC Adapter cable

### WARNING



Don't

Do not use the microUSB cable if it is damaged.

Doing so may cause fire, burns or electric shock.



Don't

Do not use the AC adapter cable in a very humid or steamy place such as bathroom.

Doing so may cause fire, burns or electric shock.



Don't

Do not touch the AC adapter cable if you hear thunder.

Doing so may cause electric shock.



## WARNING



Don't

Do not short-circuit the microUSB plug while it is connected to the power outlet. Do not touch the microUSB plug with your hands, fingers, or any part of your body.

Doing so may cause fire, burns or electric shock.



Don't

Do not place any heavy objects on the microUSB cable.

Doing so may cause fire, burns or electric shock.



Don't

When you insert and remove AC adapter from power outlet, do not contact a metal strap or other metal objects with the jack.

Doing so may cause fire, burns or electric shock.



No wet hands

Do not touch the cord of the AC adapter cable or the power outlet with wet hands.

Doing so may cause fire, burns or electric shock.



Do

Use the adapter only on the specified power supply and voltage.

Use the AC adapter cable available overseas when you charge the battery overseas.

Failure to do so may cause fire, burns or electric shock.

AC adapter cable: AC 100 V to 240 V (Make sure to connect the adapter to a household AC power outlet.)



Do

Clean dust from the power plug.

Failure to do so may cause fire, burns or electric shock.

## WARNING



Do

When you connect the AC adapter to the power outlet, insert it firmly.

Failure to do so may cause fire, burns or electric shock.



Do

Hold the power plug, not the microUSB cable, when you remove the AC adapter from the power outlet.

Failure to do so may cause fire, burns or electric shock.



Unplug

Remove the power plug from the power outlet when not used for a long period of time.

Failure to do so may cause fire, burns or electric shock.



Unplug

If liquid such as water gets into the adapter, immediately remove it from the power outlet.

Failure to do so may cause fire, burns or electric shock.



Unplug

Before cleaning, remove the power plug from the power outlet.

Failure to do so may cause fire, burns or electric shock.

## 5. Handling the UIM

### CAUTION



Do

Please be careful not to touch a cut surface when you remove the UIM.

Failure to do so may cause injury.

## 6. Handling the FOMA terminal near electronic medical equipment

- The following instructions observe the guidelines of the Electromagnetic Compatibility Conference, Japan to protect electronic medical equipment from radio waves from mobile phones.

### WARNING

Please observe the following guidelines in medical facilities.

- Do not take the FOMA terminal into the operating rooms, ICU (Intensive Care Unit), or CCU (Coronary Care Unit).
- Power off the FOMA terminal inside hospital wards.
- Power off the FOMA terminal in the lobby and other places if there are any electronic medical equipment operating in the vicinity.
- Follow the instructions of each medical facility when they specify areas forbidding to use and carrying a mobile phone.
- If you set the automatic power-on function, cancel it before powering off the FOMA terminal.



Do

Power off the FOMA terminal in crowded places such as rush-hour trains. There may be a person with an implantable cardiac pacemaker or implantable cardioverter defibrillator near you.



Do

The radio waves from the FOMA terminal may affect the operation of implantable cardiac pacemaker or implantable cardioverter defibrillator.

### WARNING

If you use an implantable cardiac pacemaker or implantable cardioverter defibrillator, keep the FOMA terminal more than 22 cm away from the implant at all times.



Do

The radio waves from the FOMA terminal may affect the operation of implantable cardiac pacemaker or implantable cardioverter defibrillator.

If you need to use electronic medical equipment other than implantable cardiac pacemaker or implantable cardioverter defibrillator outside medical facilities such as treating at home, check with the relevant medical electronic equipment manufacturer whether the operation may be affected by radio waves.



Do

The radio waves from the FOMA terminal may affect the performance of electronic medical equipment.

## 7. Material list

Part	Material	Surface treatment
Exterior case (Front)	PC resin (with glass)	UV coating
Proximity sensor	PC resin	None
Light sensor	PC resin	None
Notification LED	PC resin	None
Exterior case (Back, HDMI connector cover)	PC resin (with glass)	Non-conductive vacuum metallization (tin)+UV coating
Hardware key (Back key, Home key, Menu key, Camera key, Volume key, Power key)	PC resin	Non-conductive vacuum metallization (tin)+UV coating
Transparent plate (Display)	Hardened glass	Shatterproof film (PET)
Transparent plate (Camera lens)	PMMA	Hard coating
Flash/Photo light	PC resin	None
Back cover	PC resin	Non-conductive vacuum metallization (tin)+UV coating

## Handling precautions

### Common precautions

- Do not expose to water.

The FOMA terminal, battery pack, AC Adapter cable, and UIM are not waterproof. Do not use them in a humid place such as bathroom or in the rain. If you carry the FOMA terminal on your body, perspiration may corrode the internal parts of the FOMA terminal and cause malfunction. Note that if a trouble is diagnosed as exposure to water or other liquid, repairs of the FOMA terminal may not be covered by the Warranty or it may not be possible to repair such phones. In that case, even if the FOMA terminal can be repaired, it is repaired at the owner's expense.

- Clean the FOMA terminal with a dry soft cloth (such as used for cleaning eyeglasses).
  - Do not rub it roughly with a dry cloth. The display may be damaged.
  - Drops of water or dirt left on the display may cause stains.
  - Do not use alcohol, thinner, benzene, cleaning detergent, etc. to clean the FOMA terminal. These chemicals may erase the printing on the FOMA terminal or cause discoloration.

- Clean the terminals occasionally with a dry cotton swab.

If the jack is soiled, connection gets worse and it may cause power to be turned off or insufficient battery charge, so clean the jack with a dry cotton swab etc. When cleaning, be careful not to damage the terminals.

- Do not leave the FOMA terminal near the air conditioning vent.

Extreme temperature changes may produce condensation and corrode the internal parts of the FOMA terminal, causing it to malfunction.

- Make sure to use the FOMA terminal or battery pack without excessive force. If you put the FOMA terminal in a bag full of items or sit down with the FOMA terminal in the pocket of your cloth, it may damage the display, and internal circuit board, and the battery pack and cause the FOMA terminal to malfunction.

Also, while the external device is connected to the microUSB connection jack, headset connection jack or HDMI connection jack, it may damage the connector and cause malfunction.

- Do not rub or scratch the display with metal.

The display may get scratched and it may cause malfunction or damage.

- Make sure to see the user's manuals supplied with the battery pack and AC adapter cable.

## **FOMA terminal precautions**

- Do not press touch panel surface forcibly, or not operate with a sharp-pointed objects such as nail, ballpoint pen, pin, etc.  
Doing so may cause damage of touch panel.
- Do not use the FOMA terminal in extremely hot or cold places.  
Use the FOMA terminal within a temperature range of 5°C to 35°C and a humidity range of 45% to 85%.
- Using the FOMA terminal near ordinary phone, television or radio may cause interference in these electric appliances. Make sure to move far away from them when using the FOMA terminal.
- Note down the information saved in the FOMA terminal in a separate note and keep it safely.  
Under no condition will DOCOMO be held liable for any damaged or lost data saved in the FOMA terminal.
- Do not drop or give a strong impact to the FOMA terminal.  
Doing so may cause malfunction or damage.
- Do not plug the connector of the external device into the microUSB connection jack, headset connection jack or HDMI connection jack at the slant or pull it while connecting.  
Doing so may cause malfunction or damage.

- The FOMA terminal could become warm while in use and charging. This condition is not abnormal. You can continue charging the battery.
- Do not leave the camera under direct sunlight.  
If you do so, some of the elements may melt or become faded.
- Use the FOMA terminal with the HDMI connection jack cover closed.  
Failure to do so may get dust or water inside and cause malfunction.
- Do not use the FOMA terminal without the back cover.  
Doing so may cause the battery pack fall, malfunction, and damage.
- Do not remove the microSD card or power off the FOMA terminal while using the microSD card.  
Doing so may cause data loss or malfunction.
- Do not let magnetic cards, etc. come close to the FOMA terminal.  
The magnetic data in cash cards, credit cards, telephone cards, floppy disks, etc. may be erased.
- Do not bring strong magnetic objects close to the FOMA terminal.  
Strong magnetic objects may cause misoperation.

## Battery pack precautions

- The battery pack is a consumable accessory.  
Even if the operating time of the FOMA terminal varies depending on the operating conditions and other factors, when the length of time you can use the FOMA terminal with a fully charged battery becomes unusually short, it is time to replace the battery pack. Purchase the battery pack specified in this manual.
- Charge the battery pack in an environment with the proper ambient temperature (5°C to 35°C).
- The operating time of the battery pack varies depending on the operating environment and the secular degradation level of the battery pack.
- Depending on the use condition, the battery pack may be inflated as it comes to the end of its life. This is not a malfunction.
- Do not store the battery pack in the following cases:
  - The battery is fully charged (immediately after the charging is complete)
  - The battery has run out (the phone cannot power on)The performance and life of the battery pack may deteriorate.  
It is recommended that you store the battery pack with the remaining battery level of about 40 percent as a guide.

## ■ AC adapter cable precautions

- Charge the battery pack in an environment with the proper ambient temperature (5°C to 35°C).
- Do not charge in the following places.
  - Places that are very humid, dusty or exposed to strong vibrations.
  - Near ordinary phone or TV/radio.
- The AC adapter cable could become warm while charging. This condition is not abnormal. You can continue using the FOMA terminal.
- When you use the power outlet with a mechanism to prevent the plug from being removed, follow the instructions on the outlet's user's manual.
- Do not give a strong impact to the adapter. Also, do not bend or deform the microUSB plug.  
Doing so may cause malfunction.

## ■ UIM precautions

- Do not use unnecessary force to insert/remove the UIM.
- Do not insert and use the UIM with another IC card reader/writer. Please note that you are wholly liable for any damage or malfunction as a result of such action.
- Always keep the IC portion clean when you use the card.

- Clean the FOMA terminal with a dry soft cloth (such as used for cleaning eyeglasses).
- Note down the information saved in the UIM in a separate note and keep it safely.  
Under no condition will DOCOMO be held liable for any damaged or lost data saved in the FOMA terminal.
- Take an expended UIM to sales outlet such as docomo Shop for proper disposal in order to protect the environment.
- Do not carelessly damage, contact, or short-circuit an IC.  
Doing so may cause data loss or malfunction.
- Do not drop a UIM or subject it to impact.  
Doing so may cause malfunction.
- Do not bend a UIM or place a heavy object on it.  
Doing so may cause malfunction.
- Do not insert the UIM on which any label or seal is stuck into the FOMA terminal.  
Doing so may cause malfunction.

## Bluetooth function precautions

- To secure the Bluetooth communication security, the FOMA terminal supports the security function compliant with Bluetooth standards, but the security may not be sufficient depending on the setting.

Concern about the communication using the Bluetooth function.

- Please be aware that DOCOMO is not responsible for data leak when making data communications using Bluetooth.
- You can use a headset, handsfree, and audio profiles on the FOMA terminal. The audio/video remote control may be available for audio profile.
- Frequency band

The frequency band used by the FOMA terminal's Bluetooth/wireless LAN function is indicated on the battery storage section. The following are the descriptions:

2.4FH1/DS4/OF4

2.4: This radio equipment uses the 2400 MHz band.

FH/DS/OF: Modulation scheme is the FH-SS, DS-SS, or OFDM system.

- The estimated interference distance is 10 m or less.
- The estimated interference distance is 40 m or less.

■ ■ ■: The full band between 2400 MHz and 2483.5 MHz is used and the band of the mobile identification device can be avoided.

Available channels vary depending on the country.

For use in an aircraft, contact the airline beforehand.

### Bluetooth cautions

The operating frequency band of this equipment is used by industrial, scientific, consumer and medical equipment including microwave ovens, premises radio stations for identifying mobile units used in the manufacturing lines of plants (radio stations requiring a license), specified low power radio stations (radio stations requiring no license) and amateur radio stations (hereinafter referred to as "another station").

- Before using this equipment, confirm that "another station" is not being operated nearby.
- In the event of this equipment causing harmful radio wave interference with "another station", promptly change the operating frequency or stop radio wave emission by turning off the power, etc.
- If you have further questions, contact "General Inquiries" on the last page of this manual.

## Wireless LAN (WLAN) precautions

### • Wireless LAN

Do not use wireless LAN near magnetic devices such as electrical appliances or AV/OA devices, or in radio waves.

- Magnetism or radio waves may increase noises or disable communications (especially when using a microwave oven).
- When used near TV, radio, etc., reception interference may occur, or channels on the TV screen may be disturbed.
- If there are multiple wireless LAN access points nearby and the same channel is used, search may not work correctly.

### • 2.4 GHz device cautions

The operating frequency band of the WLAN device is used by industrial, scientific, consumer and medical equipment including home electric appliances such as microwave ovens, premises radio stations for identifying mobile units used in the manufacturing lines of plants (radio stations requiring a license), specified low power radio stations (radio stations requiring no license) and amateur radio stations (radio stations requiring a license).

1. Before using the device, confirm that premises radio stations for identifying mobile units, specified low power radio stations and amateur radio stations are not being operated nearby.

2. If the device causes harmful radio interference to premises radio stations for identifying mobile units, immediately change the frequency band or stop use, and contact "General Inquiries" on the last page of this manual for crosstalk avoidance, etc. (e.g. partition setup).
3. If the device causes radio interference to specified low power radio stations or amateur radio stations, contact "General Inquiries" on the last page of this manual.

## Cautions

- Do not use altered FOMA terminal.  
Using an altered device is a violation of the Radio Law.  
A "Technical Conformity Mark" affixed on the manufacturer's specification sticker certifies that the FOMA terminal meets technical regulations for specified radio equipment that are based on the Radio Law. If you remove the screws and alter the inside of the FOMA terminal, the technical regulations conformity certification becomes invalid. Do not use the FOMA terminal with the certification invalid, as it is a violation of the Radio Law.
- Be careful when using the FOMA terminal while driving.  
Using a handheld mobile phone while driving will result in a penalty. However, absolutely necessary cases such as rescue of a sick person or maintaining public's safety are exempted.



## Part names and functions

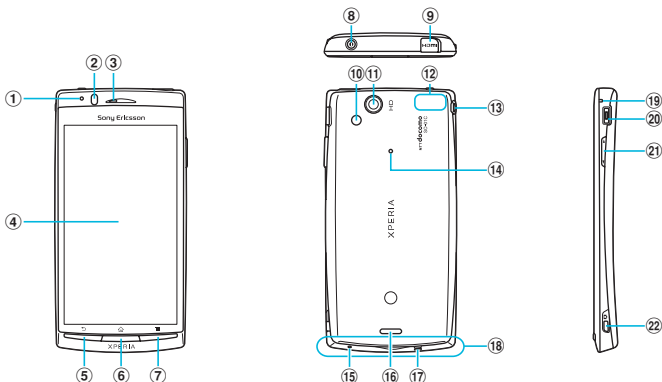

- ① Light sensor: Used for auto controlling of the screen brightness.
- ② Proximity sensor: Turns on or off the touch screen to prevent misoperation during a call.
- ③ Ear speaker
- ④ Touch screen
- ⑤ Back key
- ⑥ Home key
- ⑦ Menu key
- ⑧ Power key/Screen lock key
- ⑨ HDMI connector (type D)
- ⑩ Flash/Photo light
- ⑪ Camera lens
- ⑫ GPS antenna section\*
- ⑬ Headset connector

- ⑭ Second microphone: Reduces noise to make easy to listen.
- ⑮ Microphone
- ⑯ Speaker
- ⑰ Strap hole
- ⑱ FOMA antenna section\*
- ⑲ Notification LED
- ⑳ Connector for microUSB cable
- ㉑ Volume key/Zoom key
- ㉒ Camera key

\* The antenna is built into the main body. Covering around the antenna with your hand may affect the quality.

### ❖ Note

- Do not put stickers etc. on each sensors.

## UIM

The UIM is an IC card recorded user information such as your phone number etc. When the UIM is not inserted to the FOMA terminal, you cannot use some functions (phone function, etc.) of the FOMA terminal.

- In this FOMA terminal, the UIM (blue) is not available. If you have the UIM (blue), bring it to the nearest docomo Shop to replace.
- When inserting/removing the UIM, make sure to power off the FOMA terminal. Do not connect the AC Adapter cable.

### Security codes of the UIM

The UIM has a Security code, namely PIN. It is set "0000" at the subscription. They can be changed by yourself. (P.93)

## Inserting UIM

- 1 Put your thumb nail into the groove, hold it up in the direction of the arrow (1) to remove the back cover.**

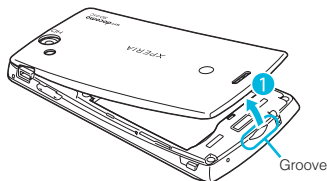

- 2 Remove the battery pack, and insert the UIM into the holder with the gold-colored contacts facing down.**

- Check the insert direction (corner cut) of the UIM.

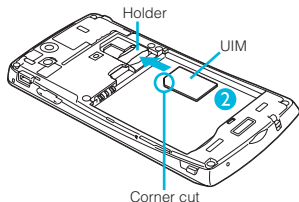

## Removing UIM

- 1 Remove the back cover, the battery pack, and slide the UIM out holding it with your finger.

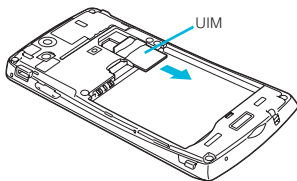

## microSD card

You can use microSD card for any other compatible devices.

- When a microSD card is not inserted, camera functions, playing or downloading music or videos are not available.
- The FOMA terminal supports microSD card of up to 2GB, and microSDHC card of up to 32GB (As of March, 2011).

## Inserting microSD card

- 1 Put your thumb nail into the groove, hold it up in the direction of the arrow (1) to remove the back cover.

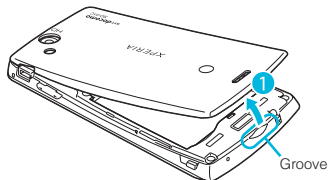

- 2 Insert a microSD card into the holder with the gold-colored contacts facing down.

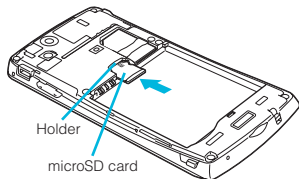

## Removing microSD card

- 1 Remove the back cover, the battery pack, and slide the microSD card out with holding it with your finger.

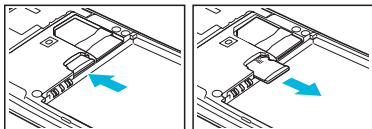

## Charging

The battery pack is not full charged when you purchased the FOMA terminal.

### Charging time

Charging time is an estimate of the time required to charge a completely empty battery pack. Charging under low temperature requires longer time.

AC Adapter Cable SO02 (included accessory)	Approx. 170 min.
---	------------------

## Operation time on full charge (estimate)

The following time varies by the battery condition or operating environment. For the details, see (P.191).

<b>Continuous stand-by time</b>	FOMA/3G	Stationary (Auto): Approx. 400 hours Moving (Auto): Approx. 290 hours Moving (3G static): Approx. 360 hours
	GSM	Approx. 270 hours (stationary)
<b>Continuous call time</b>	FOMA/3G	Approx. 340 min.
	GSM	Approx. 390 min.

## Battery pack life

Use the battery pack for SO-02C, SO05.

- The battery pack is a consumable accessory. The usage duration of the battery per one charge decreases gradually each time the battery is recharged.
- When the usage duration per one charge becomes about half of a new battery pack, the life if the battery pack is assumed to be almost over. It is recommended that you replace the battery pack ahead of time. Depending on the usage condition, the battery pack may be inflated as it comes to be end of its life. This is not a malfunction.

- Return all spent battery packs to NTT DOCOMO or a dealer, or a recycling shop to protect the environment.



## Do not charge the battery pack for a long time (several days)

- If you remain charging the FOMA terminal for a long time, the power supply starts from the battery pack after completion of charging. The usage time duration may be short. In that case, please charge it again correctly. For recharging, remove the FOMA terminal from the AC Adapter cable and reconnect it again.

## Charging

- The included AC adapter's power plug is compatible with AC100V to 240V. For using the FOMA terminal overseas, a plug adapter that fits the electrical outlets in the country you stay is needed. Do not use an electrical transformer for overseas use to charge the FOMA terminal.
- Use the included AC Adapter cable for charging.
- When charging starts, the notification LED turns on in red/orange/green. Green means the remaining battery level reaches more than 90%. To check the battery level, press  from the Home screen, then tap [Settings] ► [About phone] ► [Status] and check "Battery level". When charging is completed, "100%" is displayed in the battery level.
- When you start charging the battery with the FOMA terminal powered off, the power turns on. However, you cannot operate the FOMA terminal. Do not charge the battery in a place where the use is prohibited such as in airplane or hospital.

## Attaching the battery pack

- 1 Put your thumb nail into the groove, hold it up in the direction of the arrow (➡) to remove the back cover.

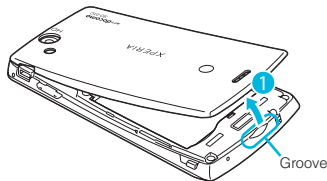

- 2** Insert it in the direction of an arrow (2) with "Sony Ericsson" label facing up, joining the each tab of the FOMA terminal and the battery pack.

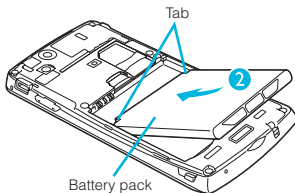

- 3** Check the direction of the battery pack and attach to the terminal body (3), press each tab to close it firmly (4).

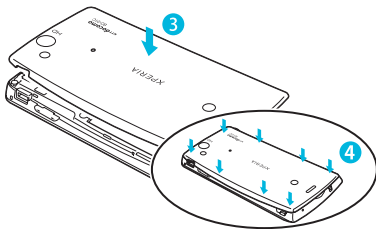

## Removing the battery pack

- 1** Remove the back cover, put your thumb nail into the groove of the FOMA terminal, hold the battery pack up in the direction of the arrow (1) to remove.

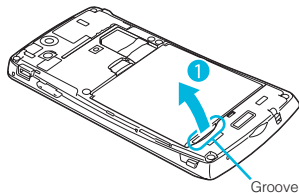

### ❖ Information

- When attaching/removing the battery pack, make sure to power off the FOMA terminal.

## Charging with the AC Adapter

- 1** Insert the supplied microUSB cable horizontally with the microUSB plug engraved side facing up into the connector for USB cable of the FOMA terminal.

- 2** Insert the microUSB cable horizontally with the USB plug engraved side facing up into the connector for USB of the AC Adapter, and insert the AC Adapter plug to the power outlet.
- 3** When the charging is completed, remove the microUSB plug of the microUSB cable from the FOMA terminal.
- 4** Remove the AC Adapter from the power outlet.

❖ **Note**

- If the microUSB cable is connected into the connector for external devices for charging etc, the FOMA terminal is automatically powered on. Be careful not to connect the microUSB cable in a place where the use is prohibited such as in airplane or hospital.

## Charging with a PC

- 1** Insert the microUSB cable horizontally with the microUSB plug engraved side facing up into the connector for USB cable of the FOMA terminal.

- 2** Insert the USB plug of the microUSB cable into the USB port of a PC.
  - When "PC Companion software" screen appears on the FOMA terminal, tap [Skip].
  - When a screen for new hardware detection etc. appears on the PC, select [Cancel].
- 3** When the charging is completed, remove the microUSB plug of the microUSB cable from the FOMA terminal.
- 4** Remove the USB plug of the microUSB cable from the USB port of the PC.

❖ **Note**

- If the microUSB cable is connected into the USB connection jack for charging etc, the FOMA terminal is automatically powered on although the operations are not available. Be careful not to connect the microUSB cable in a place where the use is prohibited such as in airplane or hospital.
- Check the connecting direction to connect correctly. Wrong connection may cause damage.

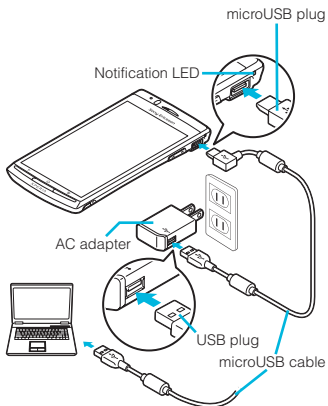

## Turning power on and off

### Turning power on

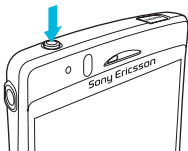

- 1 Press **Ⓢ** for over a second.
  - The key lock screen appears.



### 2 Deactivate the key lock.

- For deactivating the key lock, see "Unlocking the keys" (P.31).

#### ❖ Information

- The first time you turn ON, "Setup guide" (P.31) appears.
- If you activate the screen lock or SIM card lock, a PIN code entry screen appears when turning power on. Enter the PIN code and tap [OK]. To correct the wrong PIN entry, tap  / .

## Turning power off

- 1 Press **Ⓢ** for over a second.
  - Phone options menu appears.
- 2 Tap [Power off].
- 3 Tap [OK].

## Setting Key lock

When the key lock is set, the screen light turns off. You can avoid the touch screen or button from false operations.

- The FOMA terminal keys are locked with turning the screen light off after the specified time duration.



- 1 Press **Ⓢ**.





## ❖ Information

- For details on settings for turning the backlight off and the duration of time before the key lock activation, see "Adjusting the idle time before the screen turns off" (P.90).
- There is no function to deactivate the key lock.
- If you set the screen lock, entering the pattern, PIN or password is needed before the screen unlock. For details on the screen lock settings, see "Screen lock" (P.93).

## Unlocking the keys



A key unlocking screen appears when turning the power on or the backlight on by pressing  / .

- 1 Touch  and drag  to  until it laps over.



Key lock

## ❖ Information

-  appears on the right until you touch . You can switch the ringtone ON/OFF without unlocking the keys and screen by touching  and dragging to the left.

## Initial settings (Setup guide)

When you turn on the FOMA terminal for the first time, Setup guide appears to import contacts saved in the UIM and the microSD card and make settings of language, date and time, etc.

## ❖ Information

- Even if you skip Setup guide, you can set or change the items later as required. To change the settings later, from the Home screen, press , then tap [Settings] or [Setup guide] to set up from the menu.

- 1 Press  for over a second.
  - A screen for selecting language appears.
- 2 Tap [English (United States)] ▶ [次へ (Next)].
  - "Welcome Learn how to use the phone with this easy guide" appears. You can check the operations of main functions and initial settings.
- 3 Tap [Next].
  - Tap [Change] to change Date & time (P.103).
- 4 Tap [Next].
  - Tap [View] to check how to use the keyboard.

## 5 Tap [Next].

- Tap [View] to check how to use the application Timescape.

## 6 Tap [Next].

- Tap [Import] ► [Yes] to import contacts in SIM.
- Tap [Set up] to make settings of Wireless network (P.82), Google account (P.97), Email (P.105) and Timescape (P.155).

## 7 Tap [Next] ► [Finish].

The Home screen appears.

### ❖ Information

- To set the online service settings, enabling data connection (3G/GPRS) is required. For checking the data connection status, see "Status icons" (P.32).

## Status bar

A status bar appears at the top of the screen. In the status bar, the FOMA terminal status and notification are displayed. Notification icons appear on the left side, and the FOMA terminal status icons appear on the right side of the status bar.



Status bar



### ❖ Note

- If you cancel the status bar forcibly (P.96), operations may not be performed correctly.

## Status icons























The status icons displayed on the screen are as follows.













	Signal strength		Connecting to Bluetooth device
	During International roaming		GPS function is activated
	No signal		During Data synchronization
	FOMA HIGH-SPEED available		Airplane mode is activated
	Sending and downloading via FOMA HIGH-SPEED		Silent mode (vibration) ON
	GPRS available		Sound OFF (Ringtone volume 0)
	Sending and downloading GPRS data		Speakerphone on
	3G available		Microphone is set to mute
	Sending and downloading 3G data		An alarm is set
	Connecting to Wi-Fi		Battery status

	Wi-Fi open network available		The battery is charging
	The Bluetooth function is ON.		UIM is locked or not inserted.

## Notification icons

The notification icons displayed on the screen are as follows.

	New email message		Missed call
	New Gmail message		New voice mail
	New SMS message		Upcoming calendar event
	Problem with SMS message delivery		Playing a track
	New instant message		FM radio in use
	New Facebook message		USB is connected
	Uploading data to Facebook		HDMI connected
	Uploading data to Facebook completed		Data communication invalid
	Receiving/Downloading data		Connecting to a VPN
	Sending/Uploading data		Not connected to a VPN
	Data connected via Bluetooth		Media server activated

	Installation is completed (when installing applications from Android Market, etc).		Media server connection notification
	Software update notification or updating software		Client device is connected to Media server
	Update notification (when update of the installed market application is notified)		Red: Error messages Yellow: Warning messages
	Calling		Problem with sign-in/sync
	Calling with Bluetooth device		Setup guide unchecked
	Call on hold		More (undisplayed) notifications

## Notification panel

Notification icons are displayed in the Notification panel. You can open notifications, such as messages, reminders, or event notifications directly from the Notification panel.

### Opening/Closing the Notification panel

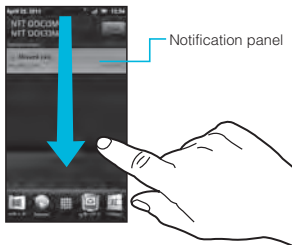

- 1 Drag the status bar downwards.**
  - Press  to close the Notification panel.

## Clearing the Notification panel

- 1 From the Notification panel, tap [Clear].**

### ❖ Information

- Some notifications cannot be cleared.

## Notification LED

Notification LED provides information on the FOMA terminal status, incoming/receiving, etc.

### LED status

Status	Indication
<b>Red</b>	The battery is charging when the remaining battery level is less than 10 %.
<b>Flashing red</b>	The battery level is not enough for activating the FOMA terminal for turning ON.
<b>Green</b>	The battery is charging when the remaining battery level is more than 90 %.
<b>Flashing green</b>	Missed calls, incoming messages (SMS) or emails exist.
<b>Orange</b>	The battery is charging when the remaining battery level is 10 % - 90 %.

## Basic operations

### Basic hardware key operation

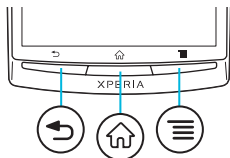

	Back	<ul style="list-style-type: none"><li>• Go back to the previous screen. Or close a dialog box, an options menu, or the Notifications panel.</li><li>• Close the software keyboard.</li></ul>
	Home	<ul style="list-style-type: none"><li>• Go to the Home screen.</li><li>• Press and hold down for over a second to open the recently used applications window.</li></ul>
	Menu	<ul style="list-style-type: none"><li>• Open a list of options available in the current screen or application.</li><li>• Press and hold down for over a second when entering characters switches display/ not display the software keyboard.</li><li>• From the Home screen, press and hold down for over a second to display the keyboard. Tap any key to start Google Search.</li></ul>

\* In this manual, each key operation is described with , , .

### Using the touch screen

#### Precautions on using touch screen

- Touch screen is designed for being touched lightly with fingers. Do not push it forcibly with a finger or press it with sharp objects (nail, ballpoint pen, pin, etc.).
- Touching the touch screen may not work in the following cases. Note that it may cause malfunction.
  - Operation with gloved hands
  - Operation with tip of fingernail
  - Operation with foreign object on the screen
  - Operation with protective sheet or seal on the screen

## Operations on the touch screen

### ■ Tap

Touch an item such as icon or menu with your finger lightly and release it.

- Double-tap means tapping twice quickly.

### ■ Touch

Touch and hold an icon or menu item long.

### ■ Flick

Stroke the screen with your finger lightly and flick up/down/left/right.

Flick operation is used to switch or scroll the screen.

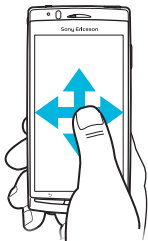

### ■ Drag

Touch the screen, drag to the desired position and release the finger.



### ■ Pinch

Touch the screen with two fingers and widen (pinch-out) or narrow (pinch-in) the fingers' distance.

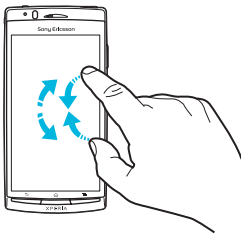
On some screens, pinch-out to zoom in and pinch-in to zoom out.



### ❖ Information

- You can zoom in or out also by double-tapping or by tapping the zoom control icons (  /  ). The zoom control icons may appear when you drag in any direction on the screen.

## Selecting items quickly from a list

Some lists have Japanese syllabary and alphabetic index on the right side of the screen.

- Drag your finger along the index to scroll through the list.

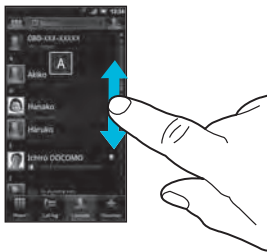

- Tap the index character to move on the list.

## Marking or unmarking options

You can switch ON/OFF of the option settings by marking or unmarking the checkboxes or radio buttons.

- To switch ON/OFF of the option setting, tap the checkbox or radio button.

### Checkboxes

Marked	<input checked="" type="checkbox"/>
Unmarked	<input type="checkbox"/>

### Radio buttons

Marked	<input checked="" type="radio"/>
Unmarked	<input type="radio"/>

## Home screen

The Home screen is the starting point of the FOMA terminal. You can personalize the Home screen by adding or moving, for example, application shortcuts and widgets, or changing the wallpaper. The Home screen can be extended with two screens for the left and right.

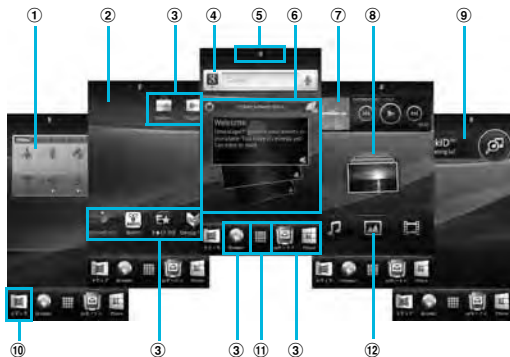

- ① Widget: Status switch
- ② Wallpaper
- ③ Shortcuts (applications)
- ④ Widget: Google search (P.42)
- ⑤ Home screen position
- ⑥ Widget: Timescape™
- ⑦ Widget: Music player
- ⑧ Widget: Photos and videos
- ⑨ Widget: TrackID™
- ⑩ Media folder (Gallery, Music and FM radio)
- ⑪ Application button
- ⑫ Widget: Media shortcuts



## Switching the Home screen

### 1 Flick the Home screen to left or right.

- The Home screen switches.

#### ❖ Information

- You can check the current position of the Home screen with  at the top of the screen.

## Changing the Home screen

### 1 From the Home screen, press



### 2 Tap [Add].

- "Add to home screen" menu appears to change the Home screen.

#### ■ Add to home screen

<b>Shortcuts</b>	Add shortcuts of applications or setting screens. (P.39)
<b>Widgets</b>	Add widgets. (P.39)
<b>Folder</b>	Add folders to collect shortcuts, etc. (P.40)
<b>Wallpapers</b>	Change the wallpaper. (P.41)

#### ❖ Information

- "Add to home screen" appears also by touching and holding anywhere on the Home screen without icons.

## Adding a shortcut on the Home screen

### 1 In "Add to home screen" menu, tap [Shortcuts].

### 2 Select a shortcut you want to add.

- The shortcut appears on the Home screen.

#### ❖ Information

- You can add shortcuts of applications on the Home screen also by the following operation.
  - From the Home screen, tap , touch and hold down an icon until the Home screen appears and release the finger where you want to place the shortcut.

## Adding widgets

### 1 In "Add to home screen" menu, tap [Widgets].

- A list of widgets appears.

<b>Analogue clock</b>	Display the analog clock.
<b>Calendar</b>	Display the calendar.
<b>Data traffic</b>	Switch ON/OFF of data communication.
<b>Digital clock</b>	Display the digital clock.
<b>Facebook</b>	View comments of members.
<b>Google Search</b>	Display the Quick search box.
<b>Home screen tips</b>	Display tips of the Home screen operation.

<b>Latitude</b>	View locations of members.
<b>Market</b>	Display recommended applications of Android Market.
<b>Media shortcuts</b>	Display Music player and Gallery (photos, videos).
<b>Music player</b>	Display Music player.
<b>News &amp; Weather</b>	Display news and weather.
<b>Photos and videos</b>	Display shot photos and videos.
<b>Picture frame</b>	Crop the shot photo to display on the Home screen.
<b>Power Control</b>	Display the setting buttons for turning on Wi-Fi function, Bluetooth function, the GPS function, synchronization and brightness (switch).
<b>Rate Places</b>	Display information of nearby stores or post word of mouth.
<b>Status switch</b>	Display the setting buttons for turning on Airplane mode, Bluetooth function, the GPS function, Wi-Fi, and for switching speakerphone ON, vibrate, and Mobile network settings.
<b>Timescape™ widget</b>	Display the latest Timescape tile.
<b>TrackID™</b>	Display TrackID™.
<b>YouTube</b>	Display the list of frequently played movies and recommended.

## 2 Select an item.

### ❖ Information

- If you install an application with widget from Android Market, the installed widget is added to the widget list.

## Displaying widget on the Home screen by a list

---

- 1 From the Home screen, pinch-in.**
  - A list of the widgets on the Home screen appears.

### ❖ Information

- To return to the Home screen, pinch-out or tap [Exit overview].

## Adding a folder to the Home screen

---

- 1 In "Add to home screen" menu, tap [Folder].**
- 2 Select the folder icon you want to add.**
  - To change the folder name, tap [Create new folder] entry box.
- 3 Tap [Done].**
  - The folder appears on the Home screen.

## Adding items to a folder

---

- 1 From the Home screen, touch and hold a shortcut icon until the FOMA terminal vibrates.**
- 2 Drag the shortcut icon over to the folder.**
- 3 Release your finger from the icon.**
  - The shortcut is added in a folder.

## Renaming a folder

---

- 1 Tap the folder to open it.**
- 2 Touch and hold the title bar of the folder.**
  - A dialog box for changing folder settings appears.
- 3 Tap entry box of [Folder name] and enter a folder name, and tap [Done].**
  - To change the folder icon, tap a folder from [Select folder icon].

## Changing wallpaper

---

- 1 In "Add to home screen" menu, tap [Wallpapers].**

- 2 Tap [Gallery]/[Live wallpapers]/[Sony Ericsson wallpapers].**
  - When you tap [Gallery], select an image to set to the wallpaper, pinch the cropping frame or drag it to area you want to use as wallpaper, and tap [Save].
  - When you tap [Live wallpapers], select a content, tap [Set wallpaper]. You can also download and add Live wallpaper content from a web page.
  - When you tap [Sony Ericsson wallpapers], select an image to set to the wallpaper, tap [Select wallpaper].



### ❖ Information

- From the Home screen, you can also press  and tap [Wallpaper].

## Moving an icon on the Home screen

- 1 From the Home screen, touch and hold an icon until the FOMA terminal vibrates.**
- 2 Keep touching the icon and drag it.**
  - To move to another Home screen, keep touching the icon and drag to left or right.
- 3 Release your finger from the icon.**



## Deleting an icon from the Home screen

- 1 From the Home screen, touch and hold an icon until  appears at the bottom of the screen.
- 2 Drag the icon to .
  - The icon lights up in red.
- 3 Release your finger from the icon.



## Searching information in the FOMA terminal and web pages

Enter a word in the search box to browse the information in the FOMA terminal or on the Internet.

- 1 Tap the search box (P.38) on the top of the browser screen.
  - The software keyboard appears.
- 2 Enter a search word.
  - Search suggestions appear as you enter a character.
  - For character entry, see "Character entry" (P.46).



- 3 Tap a search item or .
  - To enter a search word again, press .

### Information

- Tap  to set the search range from "All", "Web" and "Apps".
- Tap  to enter a search word by voice to browse the Internet.

## Search settings

You can set search engines to use for Quick search box or set search objectives in the FOMA terminal.

- 1 From the Home screen, tap , then tap [Google Search].
- 2 Press , then tap [Search settings].
  - A search settings screen appears.  
You can set the following items.

Google search	
	You can set whether to display search options when a search word is entered, or whether to reflect the previous search result in the search options. You can also open the web search log settings page by Browser. <ul style="list-style-type: none"><li>• You need to create your Google account.</li></ul>

<b>Searchable items</b>	You can change the search range by marking/unmarking data categories (web, application, contacts selection list, music search) in the FOMA terminal to search.
<b>Clear shortcuts</b>	You can set not to display recently selected search results.

## Applications screen

You can access the applications installed in the FOMA terminal using the Applications screen.

### Displaying applications screen





Application button

#### 1 From the Home screen, tap .







- On the Applications screen, flick left or right to switch the Applications screen.















#### ❖ Information











- To close the Applications screen, tap  or press  or .















## Applications

The applications displayed on the Applications screen by default are as follows.

Icon	Application	Description
	docomo market	Quick access to the DOCOMO recommended web pages or convenient applications.
	BeeTV	Watch programs for mobile phone after log in.
	E★eBURiSTA (E★eBURiSTA)	View electronic books.
	BOOK STORA 2DFACTO (Book store 2DFACTO)	View electronic books
	PlayNow	Browse a variety of benefic information.
	Contacts	Keep contacts of your friends and colleagues.
	Phone	Make and receive calls, and switch between calls.
	Messaging	Send and receive message (SMS).
	Browser	Browse Web and WAP sites (except for WML) and download files.

Icon	Application	Description
	Timescape™	Keep track of all daily communication and media events.
	Settings	Make the FOMA terminal settings.
	Setup guide	Display Setup guide.
	Music	Play music.
	Gallery	View photos and videos.
	Clock	Set an alarm, clock, etc.
	Email	Send and receive emails (multiple accounts are also available).
	Market	Download and buy new applications.
	Calendar	Keep track of your schedule.
	Maps	View current location, find another locations and calculate routes.
	Gmail	Email application
	Talk	Chat on Google Talk.
	Navigation	Display Google Map.
	Places	The application using information registered on Google Map

Icon	Application	Description
	Latitude	A communication tool to share and use your location information with members
	Calculator	Perform basic calculations such as addition, subtraction, multiplication, and division.
	YouTube	Share and view videos from all over the world.
	Evernote	The application for managing private online files
	spモードメール (sp-mode mail)	Email application
	定型文 (Fixed phrase)	Manage phrases to quote when entering characters.
	Instruction Manual	Display the FOMA terminal instruction manual.
	News & Weather	Display news and weather.
	Downloads	Display a list of downloaded items.
	PhoneBookCopy	Copy contacts data to the other FOMA terminal.

Icon	Application	Description
	Phonebook backup	Back up contacts data
	OfficeSuite	Browse and read text documents.
	TrackID™	Music information confirmation service
	Google Search	Search information in the FOMA terminal and web pages.
	Voice Search	Search by voice.
	Media server	Set up and manage Media server.
	Startup Guide	Supports basic operation and initial settings of docomo smartphone.
	FM radio	Listen to FM radio.
	ToruCa	Download store information or coupon from a portal website.
	Camera	Take photos and record video clips.
	Campaign Navi	View campaign information for Xperia.
	mora touch	mora touch, the music download site
	Facebook	Sign in to Facebook.
	Alarms	Set alarm clock.

Icon	Application	Description
	life.episode™	View the latest information such as news or music.

### ❖ Information

- Some application names may not be displayed fully.

## Sorting applications

You can sort the applications displayed on the Applications screen from the "Sorting" menu.



### 1 On the Applications screen, tap



- "Sorting" menu appears.

<b>Custom sorting</b>	Select an application icon to sort. (P.46)
<b>Alphabetical</b>	Sort in alphabetical order.
<b>Most used</b>	Sort in frequency order.
<b>Recently installed</b>	Sort in install date order.

## Selecting an application to move

- 1 On the Applications screen, tap , then drag an application icon you want to move.**
  - If  does not appear on the Applications screen, select "Custom sorting" from the "Sorting" menu (P.45).
- 2 Release your finger from the application icon.**
  - The application icon moves.
- 3 Tap .**

### ❖ Information

- To move icons to another Applications screen, drag the icon to the side edge of the screen.
- To add the Applications screen, drag the icon to the rightmost screen.

## Opening the recently used applications window

You can view and access recently used applications from this window.

- 1 Press  for over a second.**
  - A recently used applications appear on a list.

## Character entry

To enter characters, use the software keyboard which appears when you tap the character input box in a message, contacts, etc.

### ❖ Information

- Press  to return to the previous screen from the character entry screen.

## Selecting input method

In this FOMA terminal, you can select Input method (keyboard type) from "Chinese keyboard", "Japanese keyboard" and "Default input".

<b>Chinese keyboard</b>	Select to enter Chinese.
<b>Default input</b>	Select a language for text entry. Select to enter language other than Japanese.
<b>Japanese keyboard</b>	Select to enter Japanese.

- 1 On a character entry screen, touch and hold the text box.**
- 2 Tap [Input method] ► [Chinese keyboard]/[Default input]/[Japanese keyboard].**



### ❖ Information

- You can change Input method (keyboard type) during character entry.

## Software keyboard

For Japanese keyboard, there are two types of software keyboards: QWERTY and numeric key.

### ❖ Information

- The key display of software keyboard varies depending on the entry screen, character mode or settings.

### ■ QWERTY software keyboard

Japanese characters can be entered in "Romaji input" mode.



Portrait



Landscape

### ■ Numeric software keyboard

Japanese characters can be entered in "Kana input" mode.







Portrait



Landscape

## Switching the keyboard

- 1 On the character entry screen, touch and hold the character mode icon .
  - 2 Tap  / .
- : The numeric software keyboard appears.
  - : The QWERTY software keyboard appears.

### ❖ Information









- The QWERTY software keyboard is set by default. Also, "Popup on key press", "Auto capitalization", "Word suggestion" and "Error correction" are set to on.









## Entering characters on the QWERTY software keyboard

Use the QWERTY software keyboard to enter Japanese characters in "Romaji input" mode.

### The main functions of the touch-keys

- To change character modes and other input operations, tap the following icons on the QWERTY software keyboard.

Icon	Function
	Each time you tap, the character mode switches "Number" → "Hiragana/Kanji" → "Alphabet" in order. あ: Hiragana/Kanji Aa: one-byte alphabet/A: two-byte alphabet 12: one-byte number/ 1: two-byte number
 <b>Touch and hold</b>	Display a character mode switch window. <b>Keyboard switch:</b>  /  <b>Character mode switch:</b>  (two-byte),  (one-byte)
	Each time you tap this icon, a list of pictograms (only for sp mode mail) one-byte symbols, two-byte symbols and smileys can be switched.
 <b>Touch and hold</b>	A list of plug-in applications appears and you can activate the plug-in application.

Icon	Function
	Enter punctuation marks such as ? and !. Flick from side to side and enter a space, ·, ~, …, 「, 」, (, and ).
	Move the cursor*1 to the left. Touch and hold to move continuously. Or change the range for conversion.
	Move the cursor*1 to the right. Touch and hold to move continuously. Or change the range for conversion. When there is an unfixed character string with the cursor at the right end, tap to enter the same character as the one at the end.
 *2	Fix input characters and converted characters. When characters are already fixed, enter a line feed at the cursor position.
	Delete the character before the cursor. Touch and hold to delete characters continuously.
	Appears in Japanese (Romaji) input mode. Make settings of "Change settings" and "Input Method".
	Appears before conversion is fixed. Tap to switch conversion methods to "直変換".
	In alphanumerics input mode, tap to switch upper case and lower case. In number input mode, tap to switch symbols possible to enter with the keyboard.

- \*1 When any characters are entered, just touch the desired position on the entered character string to move the cursor.
- \*2 On some screens such as the search box or mail account registration screen, "Next", "Done", "Go", etc. appear.

## Changing display keys

- For Japanese input, you can set not to display less-frequent-used keys (Q, X, C, etc.) on the QWERTY software keyboard.

### 1 When entering characters with QWERTY software keyboard, tap .

### 2 Tap [Change settings] ► [Select display keys].



### 3 Unmark the checkbox of the key you want to hide.

### 4 Tap [OK].

## Changing symbols

- You can change symbols (12) displayed in  (Symbol assistant area) to the ones you use frequently.

### 1 When entering characters with QWERTY software keyboard, tap .

### 2 Tap [Change settings] ► [Change symbols].

- A list of 12 symbols to be displayed on QWERTY software keyboard appears.



### 3 Tap a symbol you want to change and delete character previously set, then enter a character to display.

### 4 Tap [OK].

## Selecting an assistant keyboard

When you enter in Hiragana/Kanji input mode using the QWERTY software keyboard, you can change the assistant keyboard to make the frequent using keys to be displayed widely for easy tapping.

- 1 **When entering characters with QWERTY software keyboard, tap .**
- 2 **Tap [Change settings] ► [Choose key type].**
- 3 **Tap any of [Static key resizing]/ [Key highlight while typing]/ [Dynamic key resizing with highlight]/[Off].**

### ■ Static key resizing

Widen frequent using key for easy tapping.



### ■ Key highlight while typing

Widen frequent using key and highlight the key that is predicted for the next entry.



### ■ Dynamic key resizing with highlight

Widen the key that is predicted for the next entry much further and highlight it.



### ■ Off

Display equally the width of each key.



## Entering characters on the numeric software keyboard

Use the numeric software keyboard to enter Japanese characters in "Kana input" mode.

### The main functions of the touch-keys

- To change character modes and other entering operations, tap the following icons on the numeric software keyboard.

Icon	Function
	Each time you tap, the character mode switches "Number" → "Hiragana/Kanji" → "Alphabet" in order. あ: Hiragana/Kanji Aa: one-byte alphabet/A: two-byte alphabet 12: one-byte number/ 1: two-byte number
<b>Touch and hold</b>	Display a character mode switch window. <b>Keyboard switch:</b> <b>Character mode switch:</b> (two-byte),  (one-byte)
	Each time you tap this icon, a list of pictograms (only for sp-mode mail) one-byte symbols, two-byte symbols and smileys can be switched.
<b>Touch and hold</b>	A list of plug-in applications appears and you can activate the plug-in application.

Icon	Function
	Appears before conversion is fixed to switch conversion methods ("予測変換", "直変換").
	Display the previous character (opposite order).
	Appears before conversion is fixed to return to text before conversion.
	Move the cursor*1 to the left. Touch and hold to move continuously. Or change the range for conversion.
	Move the cursor*1 to the right. Touch and hold to move continuously. Or change the range for conversion. When there is an unfixed character string with the cursor at the right end, tap to enter the same character as the one at the end.
	Fix entered or converted characters. When characters are already fixed, enter a line feed at the cursor position.
	Delete the character before the cursor. Touch and hold to delete characters continuously.
	Display the first candidate of direct conversion. When any character is entered, a space can be entered.

\*1 When any characters are entered, just touch the desired position on the entered character string to move the cursor.

\*2 On some screens such as the search box or mail account registration screen, "Next", "Done", "Go", etc. appear.

## Settings of key entry

### ■ Flick input



Flick up/down/left/right to enter characters in each column of kana syllabary.

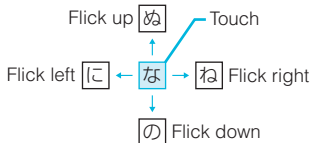

#### • Ex: Entering characters in "な" column

You can enter "な" only by touching. Flick left for "に", up for "ぬ", right for "ね" and down for "の".



- To switch upper/lower case or change to voiced sound, tap .
- Flick input is available by default. You can cancel by the following operation beforehand.
  - ① From the Home screen, press  and tap [Settings].

- ② Tap [Language & keyboard] → [Japanese keyboard].
- ③ Unmark the checkbox of "Flick input".

### ■ Toggle entry

Tap the same key continuously to enter the assigned character.

To enter characters assigned to the same key continuously, operate the followings.



#### • Ex: To enter "あお"

- ① Tap "あ" once.
- ② Tap , and tap "あ" 5 times.

#### • Ex: To enter "ca"

- ① Tap "ABC" 3 times.
- ② Tap , and tap "ABC" once.

### ❖ Information

- When a certain time is passed after the key tapped, the tapped key's highlighter goes off and you can enter a character assigned to the same key consecutively without tapping .
- To switch upper/lower case or change to voiced sound, tap .
- Operate the following to enter characters in the toggle entry while Flick input is set.
  - ① From the Home screen, press  and tap [Settings].
  - ② Tap [Language & keyboard] → [Japanese keyboard].
  - ③ Mark [Multitap text input] checkbox.

## Editing text

While entering characters, touch and hold the text box to display the "Edit text" menu and edit entered text.

<b>Select word</b>	Drag the slider to select a part of entered text.
<b>Select all</b>	Select all entered text.
<b>Input method</b>	P.46
<b>Add "xx" to dictionary</b>	Add the entered text to the dictionary.
<b>Cut</b>	Display when "Select word"/"Select all" is selected. Cut the text selected by "Select word"/"Select all".
<b>Copy</b>	Display when "Select word"/"Select all" is selected. Copy the text selected by "Select word"/"Select all".
<b>Paste</b>	Display when "Cut"/"Copy" is selected. Paste the cut/copied text by "Cut"/"Copy".

## Settings of entering characters

For each type of keyboard, you can make settings related to character entry.

- 1 From the Home screen, press , then tap [Settings] ► [Language & keyboard].**

## 2 Tap [Default input]/[Japanese keyboard]/[Chinese keyboard].

- The settings screen for each keyboard appears. Tap an item displayed on the screen to set.

### ❖ Information

- The items vary depending on the keyboard type.
- The setting screen for "Chinese keyboard" is displayed in English. When Select language (P.102) set to Chinese (中文), it appears in Chinese.

## Settings of Japanese keyboard

### 12 key keyboard settings

You can make keyboard settings such as Key sound, Vibrate, etc.

- 1 From the Home screen, press  and tap [Settings] ► [Language & keyboard] ► [Japanese keyboard].**

- The setting screen for Japanese keyboard appears. Tap [12 key keyboard settings] to set the items.

<b>Key sound</b>	Set whether to sound at the time of key tapping.
<b>Vibrate</b>	Set whether to vibrate at the time of key tapping.

<b>Popup on key press</b>	Set to popup the key you have tapped at the time of key tapping.
<b>Auto capitalization</b>	Set to capitalize automatically the top letter you enter in English input mode.
<b>Keep keyboard type</b>	Set to stabilize the last status of keyboard by screen orientation and kana/alphabet/number input mode.

## Keyboard skin

You can change keyboard skin.

- 1 From the Home screen, press , then tap [Settings] ► [Language & keyboard].
- 2 Tap [Japanese keyboard] ► [Select keyboard skin].
- 3 Select a keyboard and tap [Set skin].

### ❖ Information

- You can also download and add keyboard skins from a website.

## Word suggestion

The Word suggestion function shows predicted conversion candidates when you enter Japanese/English characters. Mark the checkbox of Word suggestion checkbox to set options "Error correction" and "Auto space" These options help you entering characters with ease.

### Setting Word suggestion

- 1 From the Home screen, press , then tap [Settings] ► [Language & keyboard].
- 2 Tap [Japanese keyboard].
- 3 Mark [Word suggestion] checkbox.

### Setting Error correction

- Error correction corrects mistyped characters and shows conversion candidates before conversion in one-byte alphabet input mode when entering characters with QWERTY software keyboard.

- 1 From the Home screen, press , then tap [Settings] ► [Language & keyboard].
- 2 Tap [Japanese keyboard].



## 3 Mark [Error correction] checkbox.

### Setting Auto space

---

- When selecting English word suggestion, Auto space enters a space next to the entered character. However, space is not entered automatically in the mail address or URL input fields.

## 1 From the Home screen, press , then tap [Settings] ► [Language & keyboard].

## 2 Tap [Japanese keyboard].

## 3 Mark [Auto space] checkbox.

### User dictionary

To display the word as the preferred candidate when entering characters, set the user dictionary beforehand.

### Registering words in user dictionaries

---

There are two types of user dictionaries: "My words Japanese" (Kana/Kanji) and "My words English" (one-byte alphabet).

## 1 From the Home screen, press , then tap [Settings] ► [Language & keyboard].

## 2 Tap [Japanese keyboard].

## 3 Tap [My words Japanese]/[My words English].

## 4 Press , then tap [Add].

## 5 Tap the character input box for "Reading" and fill it out, then tap [次へ (Next)].

## 6 Enter a word in the input box for "Word" and tap [完了 (Done)].

## 7 Tap [Save].

### Setting Words by learning

---

## 1 From the Home screen, press , then tap [Settings] ► [Language & keyboard].

## 2 Tap [Japanese keyboard] ► [Words by learning].

## 3 Mark [Save word while typing].



- To reset all learning, tap "Delete saved words" ► [OK].

## Using plug-in application "定型文 (Fixed phrase)"

You can quote phrases with the plug-in application "定型文". To call up "定型文", touch and hold down  when entering characters. Phrases are saved in 5 categories of "インターネット (Internet)", "あいさつ (Greeting)", "ビジネス (Business)", "返事 (Reply)", "プライベート (Private)" in advance. You can add, delete and edit categories and phrases.

### Adding a category of phrases

Add a new category and register a phrase.

- 1 From the Home screen, tap , then tap [定型文 (Fixed phrase)].**  
A list of categories appears.
- 2 Press , then tap [カテゴリー追加 (Add category)].**
- 3 Enter the category name and tap [OK].**
- 4 Tap [新規追加 (Add phrase)] and enter a phrase.**
- 5 Tap [OK].**

### ❖ Information

- When you tap each category, a list of registered phrases appears. Tap a phrase to edit/delete.
- To restore the default phrases, in the category list, press , then tap [初期化 (Reset)].

## Adding a plug-in application

You can install and add plug-in applications to use when entering characters.

- 1 From the Home screen, press , then tap [Settings] ► [Language & keyboard].**
- 2 Tap [Japanese keyboard] ► [Manage applications].**
- 3 On the Info screen, tap [OK].**  
The plug-in setting screen appears.
- 4 Tap [Download new applications].**
- 5 Tap an application and follow the onscreen instructions.**

### ❖ Information

- Marked plug-in applications in the plug-in setting screen can be activated in the character entry screen.

## Making/Receiving calls

### Making a call

- 1 From the Home screen, tap [Phone].**
- 2 Enter the number of the recipient and tap [Call].**
  - If a wrong number is entered, tap  on the right of the phone number field to delete the number.

### Entering pause (,)

This function allows you to operate voice mail at home, to reserve tickets or to check the balance of a bank account, etc.

- 1 From the Home screen, tap [Phone].**
- 2 Enter the number of the recipient and touch and hold the asterisk (\*) key until a comma (,) appears.**

### Making an emergency call

When the FOMA terminal is within range of the service area, you can make an emergency call of 110 (Police), 119 (Fire and ambulance) or 118 (Japan Coast Guard).

- 1 From the Home screen, tap [Phone].**
- 2 Enter the emergency number and tap [Call].**
  - If a wrong number is entered, tap  on the right of the phone number field to delete the number.

#### ◆Note

- In Japan, when UIM is not inserted to the FOMA terminal, the emergency numbers of 110/119/118 are not available.
- This FOMA terminal supports "Emergency call location information". If you use the FOMA terminal to place a call to emergency numbers such as 110, 118, or 119, the information of a location where you are calling from (location information) is automatically notified to the Emergency call acceptance organization such as the Police Station. The Emergency call acceptance organization may not be able to figure out your exact location depending on the location where you place a call or radio wave condition. If you make a call without the caller ID, such as by entering a phone number with "184" for each call, the location information and phone number are not notified. However, the Emergency call acceptance organization may decide to obtain the location information and phone number regardless of your settings when they consider it is necessary for lifesaving, etc. Note that the areas/time for which the "Emergency call location information" is ready to be used vary depending on the preparatory state of each Emergency call acceptance organization.

- When you call the Police (110), Fire/Ambulance (119), or Maritime rescue (118) from the FOMA terminal, clearly indicate that you are calling from a mobile phone, then give your present location and mobile phone number. Also, make a point to call in a stationary position to prevent the call from being dropped. Do not power off the FOMA terminal for at least 10 minutes after the emergency call just in case the Police or Fire/Ambulance may have to get in contact with you.
- Note that you may not connect to the local Fire Department or Police Station depending on where you are calling from. In this case, try to call from a public phone or an ordinary phone in the neighborhood.

## Making an emergency call while UIM is locked

- 1 Tap [Emergency call].
- 2 Enter the emergency number and tap [Call].
  - If a wrong number is entered, tap  on the right of the phone number field to delete the number.

### ❖ Note

- In Japan, while entering PIN code on the screen (P.93) or during PUK lock (P.93), the emergency numbers of 110/119/118 are not available.

## Ending a call



- 1 Tap [End call].

## Making an international call (WORLD CALL)

For details on WORLD CALL, refer to DOCOMO International Services website.



- 1 From the Home screen, tap [Phone].
- 2 Touch and hold [0] key until "+" sign appears.
  - When making an international call, "+" is replaced by an international access code.
- 3 Enter the country code ► Area code ► A phone number of recipient and tap [Call].
  - If the area code begins with "0", omit "0". However, "0" may be required to dial to some countries or areas such as Italy.

## Receiving a call

- 1 While receiving a call, touch  (left) and drag it to  (right).
- ❖ Information
- If you are using regular headphones without a microphone, you need to speak to the microphone of the FOMA terminal.

- The icon appears even during the screen lock or key lock, and you can answer a call by the same operation.

## Declining a call

- 1 While receiving a call, touch  (right) and drag it to  (left).

### ❖ Information

- The icon appears even during the screen lock or key lock, and you can decline a call by the same operation.

## Using Stereo Headset with Microphone

You can make or answer a call with Stereo Headset with Microphone (Sample) connecting to the FOMA terminal.

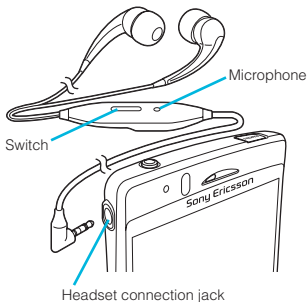

## ■ Making a call

- 1 Make a call with Stereo Headset with Microphone connected.

- An operation of making call is the same as usual operation. (P.57)

- 2 Press the switch to end the call.

## ■ Receiving a call

- 1 While receiving a call, press the switch of Stereo Headset with Microphone.

- The call is connected.
- When receiving a call, you can decline the call by pressing the switch for over a second.

- 2 To end a call, press the switch again.

### ❖ Information

- Even when you listen to music with Stereo Headset with Microphone connecting to the FOMA terminal, you can answer a call by pressing the switch. Music pauses on calling, and restarts when ending the call.

## Adjusting the ear speaker volume

- 1 Press   during a call.



## ❖ Information

- You can adjust the ear speaker volume only during a call.

## Muting the ringtone for an incoming call



- Press  when a call is received.

## ❖ Information

- You can also press  to mute the ringtone for an incoming call.
- To change ringtone volume other than when receiving, press up or down of  on the Home screen to adjust the ringtone volume.

## Call Options

By using the call option during a call, you can make a call on hold or mute the microphone.



<b>Hold</b>	During a call, press  , tap [Hold]. To cancel hold, while a call is on hold, tap [Retrieve call]. <ul style="list-style-type: none"><li>To set a call on hold, "Call waiting" subscription is required. (P.74)</li></ul>
<b>Contacts</b>	Display the contacts list during a call.
<b>Speaker</b>	Set speakerphone ON/OFF. <ul style="list-style-type: none"><li>When the speakerphone is ON, a speakerphone icon  appears in the status bar.</li></ul>

<b>Mute</b>	Set muting ON/OFF of the microphone during a call. <ul style="list-style-type: none"><li>When the microphone is muted, a mute icon  appears in the status bar.</li></ul>
<b>Dialpad</b>	Enter the phone number to add to make a call. <ul style="list-style-type: none"><li>The ongoing call is automatically on hold.</li><li>To add a call, "Call waiting" subscription is required. (P.74)</li></ul>
<b>End call</b>	End a call.

## ❖ Note

- Do not bring the FOMA terminal close to your ear with the speakerphone ON to avoid hearing damage.

## Call log

In the call log, missed () , received () , and dialed () calls are displayed with the icons.

## Displaying missed calls

When you have missed calls,  appears in the status bar.

- Drag the status bar downwards.
- Tap [Missed call].

## Calling a number from the call log

- 1 From the Home screen, tap [Phone] ► [Call log].
- 2 Tap  next to the desired number.

## Adding a number from the call log to your contacts

- 1 From the Home screen, tap [Phone] ► [Call log].
- 2 Tap and hold the number, then tap [Add to Contacts].
  - You can select [Add to Contacts] from the menu displayed when you tap the number.
- 3 Tap desired contact, or tap [Create new contact].
  - Tap [Create new contact] to display a screen for selection of the saving locations appears. You can select Phone contact or docomo account as the saving location.
- 4 Edit the contact details and tap [Done].

## Deleting the call log

- 1 From the Home screen, tap [Phone] ► [Call log].
- 2 Press , and tap [Clear call log].

### ❖ Information

- You can delete only one contact by touching and holding a contact to delete on the call log list, then tapping [Delete from call log].

## Contacts

In Contacts, you can enter all your information for your personal contacts, for example, phone numbers, email addresses and web service accounts. When you view a contact, you get quick access to all communication with that contact.

## Opening Contacts

- 1 From the Home screen, tap , then tap [Contacts].
  - You can also open Contacts from the Home screen, tap [Phone] ► [Contacts].

## ❖ Information

- The first time you open Contacts, a setup wizard starts. In the setup wizard, you can load contacts from UIM or microSD card, or synchronize contacts with the account that you specified in advance. To use Contacts, tap [Open Phonebook].

## Contacts screen

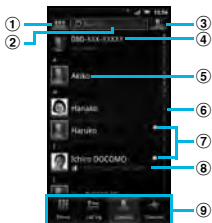

On the Contacts screen, you can view details of your contacts. You can add a contact picture, and display updated information of online services.



- ① Set conditions of contacts to display
  - ② Contact search field
  - ③ Key for adding a new contact
  - ④ Your own phone number
  - ⑤ A contact saved in Contacts
  - ⑥ Japanese syllabary or alphabetical index for browsing contacts
  - ⑦ Online status\* of Google Talk (Chat) (P.111)
  - ⑧ Updates from your Facebook contacts
  - ⑨ Screen tabs (Phone/Call log/Contacts/Favorites)
- \* Depending on the usage, it may be different from online display of Google Talk.

## Managing contacts

### Adding a contact

- 1 From the Home screen, tap , then tap [Contacts].
- 2 Press , then tap [New contact].
- 3 Tap [docomo]/[Phone contact].
  - When you set Google account etc., it appears as a saving location.
- 4 Enter a name.
- 5 Enter or select the desired additional information for the contact.
  - You can add items other than phone number, email address and ringtone by tapping [Add field].
- 6 Tap [Done].





## ❖ Information

- You can also add a contact by tapping ③ () on the Contacts screen (P.62).
- For using "Send calls directly to voicemail.", a subscription of Voice Mail service is required. For details, see "Voice Mail Service" (P.72).
- When you save "ふりがな (姓/名) (Reading (Last name/First name))", contacts list is displayed according to Japanese syllabary order or alphabets (only when Select language is set to 日本語 (Japanese)).



## Using shortcuts of Contacts

When you tap the photo (image) part on contacts list screen, shortcuts for phone number, mail, etc. appear. Tap the shortcut to make a call, or create and send a mail.

	Make a call to saved phone number.
	"Info" filter screen (P.68) of the contact appears.
	Create and send message (SMS).
	Select an email application to create and send an email.

\* You can also use the registered Google Talk account, addresses, etc.



### ❖ Information

- When you tap a part other than photo (image) on the contacts list screen, "Info" filter screen (P.68) of the contact appears instead of shortcuts.
- Email shortcut appears when email address is saved in the selected contact and you have set your email account.



## Searching for a contact

- 1 From the Home screen, tap , then tap [Contacts].**
- 2 Enter searching name or reading in the search field.**
  - All contacts beginning with those letters appear.

### ❖ Information

- You can switch the view contacts between "Contacts w. ph. number" and "Online contacts" by tapping  (  ) on the Contacts screen (P.62). Also, you can set to show/hide contacts by account or group.

## Editing a contact

- 1 From the Home screen, tap , then tap [Contacts].**
- 2 Tap the name part of contact you want to edit.**
  - "Info" filter screen (P.68) of the contact appears.
  - When you tap the image (photo) part of the contact, contact shortcuts appear. Tap  to display "Info" filter screen (P.68).
- 3 Tap [Edit].**
  - By tapping  (Add field) on the editing screen, you can add information to enter.
- 4 Edit the desired information and tap [Done].**

## Linking contacts

You can bind multiple contacts together into one.

- 1 From the Home screen, tap , then tap [Contacts].**

## 2 Touch and hold the desired contact, then tap [Join contacts].

- The link candidates appear.

## 3 Tap the contact to link.

## 4 Tap [OK].

### ❖ Information

- To cancel link of contacts, on Contact edit screen, press , then tap [Separate].

## Auto linking function

Contacts of the same name registered in different saving locations separately are automatically linked and collected as one.

### ■ Conditions automatically linked

If different saving locations (Phone contact/docomo account/Google account) are registered, they are automatically linked.

#### Examples:

Saving location: Phone contact Last name: Docomo First name: Ichiro	Saving location: docomo account Last name: Docomo First name: Ichiro
Saving location: Google account (□□□@gmail.com)* Last name: Docomo First name: Ichiro	Saving location: Google account (△△△@gmail.com)* Last name: Docomo First name: Ichiro

\* When you set two or more Google accounts etc., they are recognized as different saving locations and the contacts are automatically linked.

Alternatively, contacts whose saving locations (account types) are different and registered in any of the following conditions, the contacts are automatically linked.

#### Examples:

Contacts are registered turning over the last name and first name.

Contacts are registered turning over the last name and first name.	
Last name: Docomo First name: Ichiro	Last name: Ichiro First name: Docomo
The last name and first name are registered in the same field, or only the last names or first names are registered in contacts.	
Last name: Docomo First name: Ichiro	Last name: Docomo Ichiro First name:
Different last names/first names are registered under the same reading (only when Select language is set to 日本語 (Japanese)).	
Last name: ドコモ (Docomo) First name: 一郎 (Ichiro) Last name (reading): どこも First name (reading): いちろう	Last name: 土戸茂 (Docomo) First name: 伊知朗 (Ichiro) Last name (reading): どこも First name (reading): いちろう

The last names/first names are the same as the reading of last names/first names (only when Select language is set to 日本語 (Japanese)).

Last name:  
ドコモ (Docomo)  
First name: 一郎 (Ichiro)  
Last name (reading):  
どこも  
First name (reading):  
いちろう

Last name: どこも  
First name: いちろう

Last names/first names are not registered but the identical phone numbers or mail addresses are registered (similar last names/first names may be linked)

Last name:  
ドコモ (Docomo)  
First name: 一郎 (Ichiro)  
Phone number:  
090△△△△△△△△△△

Last name:  
First name:  
Phone number:  
090△△△△△△△△△△

### ❖ Information

- If last names/first names are registered in the following conditions, the contacts are also automatically linked.
  - Two-byte hiragana/two-byte katakana/one-byte katakana
  - Upper case/Lower case of alphabets
  - The same characters with or without accent marks or phonetic symbols

## ■ Conditions not automatically linked

Contacts with the same last name/first name but registered in the same saving location are not automatically linked.

### Examples:

Saving location: Phone contact Last name: Docomo First name: Ichiro	Saving location: Phone contact Last name: Docomo First name: Ichiro
---	---

## Deleting contacts

**1 From the Home screen, tap , then tap [Contacts].**

**2 Press , then tap [Delete contacts].**

**3 Mark the contacts you want to delete.**

- If you want to delete all contacts, tap [Mark all].

**4 Tap [Delete] ► [OK].**

### ❖ Information

- You can also delete the contacts by touching and holding a contact on the Contacts screen, then tapping [Delete contact].



## Calling a contact

---

- 1 From the Home screen, tap , then tap [Contacts].
- 2 Tap a name of contact to call to.
- 3 Tap a desired phone number.

## Checking Myself and editing contact information

---

- 1 From the Home screen, tap , then tap [Contacts].
- 2 Tap [XXX-XXXX-XXXX] (My number) at the top of the contact list.
- 3 Tap [Edit].
  - The "Myself" edit screen appears.
- 4 Enter the new information or make the changes you want.
  - By tapping  (Add field) on the editing screen, you can add information to enter.
- 5 When you are done, tap [Done].



### ❖ Information

- In "Myself", you can add multiple phone numbers, emails, etc. The history of dialed/received calls from the registered phone numbers is displayed in "Call log" of "Info" filter screen (P.68).

## Sending your contact via Bluetooth/Email/Gmail

---

You can send the saved contacts or "Myself" information by using Bluetooth function (P.149), email attachment, etc.



- 1 From the Home screen, tap , then tap [Contacts].
- 2 Tap [XXX-XXXX-XXXX] (My number) or the contact.
- 3 Press , then tap [Send contact].
- 4 On the send confirmation screen, tap [OK].
  - Using Bluetooth function  
Tap [Bluetooth] ► [Turn on] ► Select a destination device from the list.
    - Bluetooth function is ON and searches destination devices.
    - When Bluetooth function is already ON, Bluetooth terminal scan screen appears.

## ■ Attaching contacts to Email/Gmail

Tap [Email]/[Gmail].

- Create an email on each compose screen, and send it.
- "Email" appears when you have set an email account. If you select "Gmail" when you have not set an account, setup wizard appears. You can create and send email after settings are done.

### ❖ Information

- You can send multiple registered contacts all at once.
  - From the Home screen, tap  ► [Contacts], press  and tap [Send contacts]. Mark the checkboxes for the contacts you want to send and tap [Send]. If you want to mark all contacts, tap [Mark all]. On the send confirmation screen, tap [OK].

## Marking a contact as a favorite



You can mark a contact as a favorite. The favorite list provides quick access to the contacts you have marked.

- 1 From the Home screen, tap , then tap [Contacts].**
- 2 Touch and hold the contact you want to mark.**
- 3 Tap [Add to Favorites].**

### ❖ Information

- You can also add the contacts to favorites by tapping [Favorites] on "Info" filter screen (P.68).
- On the Contacts screen, tap [Favorites] to display contacts registered to Favorites.

## Setting a photo to a contact

- 1 From the Home screen, tap , then tap [Contacts].**
- 2 Tap the contact.**
- 3 Tap [Edit].**
- 4 Tap .**
- 5 Tap [Gallery]/[Take new photo].**
  - Select [Gallery] to select a saved photo and add it.
  - Select [Take new photo] to shoot a photo and save it.
- 6 Tap [Done].**

### ❖ Information

- You can also set photo to a contact by the following operation.
  - From the Home screen, tap  ► Tap [Gallery] and select an image to set. Tap [Menu] at the lower right of the screen ► [More] ► [Set as] ► [Contact picture] and select a contact you want to register to, and then tap [Save].



## The contact information filter

When you are viewing a contact details screen, you can flick the filter at the bottom of the screen right or left to show the following information.

Filter	Information
<b>Info</b>	Contact phone numbers, mail addresses, addresses, Facebook information, etc.
<b>Facebook</b>	Facebook status updates for the contact <ul style="list-style-type: none"><li>• Appears if you have set Facebook account in Timescape.</li></ul>
<b>Messaging</b>	Message (SMS) conversations with the contact
<b>Calls</b>	Call history for the contact

## Setting to display Facebook updates on contacts

You can view the Facebook update information if the contacts are linked to online services such as Facebook.

- 1 From the Home screen, tap , then tap [Contacts].**
- 2 Press , tap [Settings] ► [Accounts & sync] ► [Add account].**

### 3 Tap [Facebook].

- For the first time to login to Facebook, a message confirming if you agree or not agree with the End user license agreement appears.

### 4 Enter account information and tap [Login].

- After log in, the confirmation screen for synchronizing contacts with members appears. Tap Select any of [Sync all]/[Sync with existing contacts]/[Don't sync].

### 5 Tap [Next] ► [Finish].

#### ❖ Information

- To display Facebook filter in "Info" filter screen (P.68), login to Facebook from Timescape to refresh in Timescape.

## Exporting/Importing contacts

You can export/import contacts from/to microSD card or UIM. This is useful, for example, when you want to transfer the contact information to another phone.



#### ❖ Information

- You can also use a synchronization service for synchronizing your contacts. For details, see "Data synchronization" (P.99).

- When contacts are imported to other mobile phone, phone number type "Mobile:/M", "Work:/W" or "Home:/H" may appear at the next to the name of the contacts backed up from the FOMA terminal to UIM. If there is no corresponding item, "/O" may appear.



## Exporting all contacts on microSD card

---

- 1** From the Home screen, tap , then tap [Contacts].
- 2** Press , then tap [Back up contacts]. ► [Memory card] (microSD card).
- 3** Tap [OK].

## Importing contacts from microSD card

---

- 1** From the Home screen, tap , then tap [Contacts].
- 2** Press , then tap [Import contacts]. ► [Memory card] (microSD card).
- 3** Tap [docomo]/[Phone contact].
  - When you set Google account etc., it appears as an import destination.

## 4 Select the vCard file to import.

- If there is only one file, vCard file selection screen does not appear. The file is imported immediately.
- If a file has multiple contacts, they are imported all at once.
- If there are two or more vCard files, tap any of [Import vCard file]/[Import vCard files]/[Import all vCard files] to select.



## 5 Tap [OK].

### ❖ Information

- Some part of data may not be imported or exported depending on the contacts.

## Exporting names and numbers on UIM

---

- 1** From the Home screen, tap , then tap [Contacts].
- 2** Press , then tap [Back up contacts]. ► [SIM card].
- 3** Mark the contacts you want to copy.
  - If you want to mark all contacts, tap [Mark all].
- 4** Tap [Back up].

## 5 Tap [Add contacts]/[Replace all contacts].

- If you select [Replace all contacts], all existing UIM information is replaced.

### ❖ Information

- When you copy a contact to the UIM, only the contact name and the first number is saved. This is due to limited memory on a UIM.
- Contacts without phone number cannot be saved to the UIM.

## Importing contacts from UIM

1 From the Home screen, tap , then tap [Contacts].

2 Press , then tap [Import contacts]. ► [SIM card].

3 Tap [docomo]/[Phone contact].  
• When you set Google account etc., it appears as an import destination.

4 To import one contact, tap the contact you want to import.  
• To import all contacts, press , then tap [Import all].  
• If there is a contact whose name is matched with the imported contact, the contact is imported as a separated one.

### ❖ Information

- Only a name and the first phone number can be imported to a contact.

## Using PhoneBookCopy

You can copy the Contacts data to or from another FOMA terminal by using microSD card. You can also copy the Contacts data registered in Google account to docomo account.

1 From the Home screen, tap , then tap [PhoneBookCopy].  
• For the first time of use, agree to "使用許諾契約書 (License Agreement)".

## Exporting contacts saved in docomo account to microSD card

1 On the "エクスポート (Export)" tab screen, tap [開始 (Start)].

## Importing contacts on microSD card to docomo account

1 On the "インポート (Import)" tab screen, tap a file you want to import.  
2 Tap [上書き (Overwrite)]/[追加 (Add)].