



MY FIRST HOUR



Sony Ericsson

XPERIA
Xperia™ ray

Startup guide

Sony Ericsson Mobile Communications AB
SE-221 88 Lund, Sweden
www.sonyericsson.com

1250-1259.1

Welcome

Important information

Please read the *Important information* leaflet before you use your mobile phone.

Assembly

To remove the battery cover

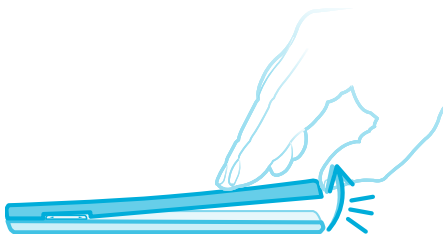

- 💡 Use a thumb nail so that you can lift up the cover with more force.

To insert the SIM card and the battery

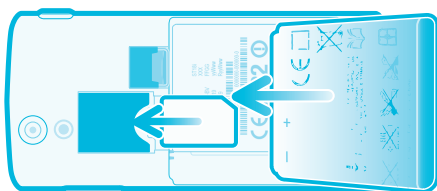

To attach the battery cover

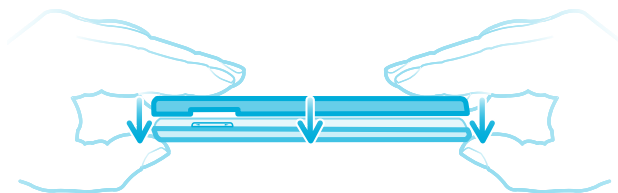

Phone basics

Phone overview

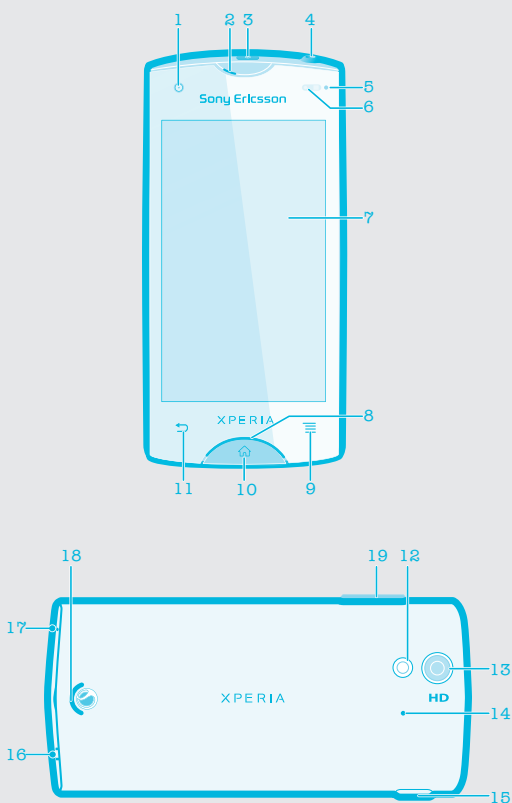

- | | |
|---------------------------------------|---|
| 1. Front camera lens | 11. Back key |
| 2. Ear speaker | 12. Camera LED light |
| 3. Power key | 13. Main camera lens |
| 4. Headset connector | 14. Second microphone |
| 5. Light sensor | 15. Connector for charger/
USB cable |
| 6. Proximity sensor | 16. Strap hole |
| 7. Touch screen | 17. Main microphone |
| 8. Notification LED/Battery
status | 18. Speaker |
| 9. Menu key | 19. Volume key/Zoom key |
| 10. Home key | |

Turning on the phone

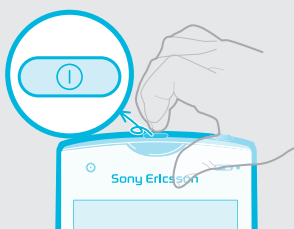

To turn on the phone



- ! It may take a while for the phone to start up.

Waking up the screen

To activate the screen

- Press  or press  briefly.



To unlock the screen



- Drag the  icon to the right across the screen.

Using the keys



-  Back
 - Go back to the previous screen
 - Close the on-screen keypad, a dialog box, an options menu, or the Notification panel
-  Home
 - Go to the Home screen
 - Activate the screen if the screen goes dark
 - Press and hold to open a window showing your most recently used applications
-  Menu
 - Open a list of options available in the current screen or application

Set up your phone

What is Android?

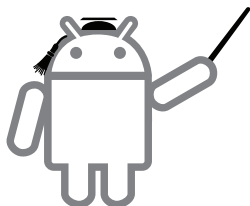

Android is your phone's operating system. Since it's developed by Google™, your phone is preloaded with several Google™ services, such as Google Maps™ and Google™ web search. To use some of the services provided by Google™, you need a Google account. With a Google account you can access Android Market™ – an application store providing both free and paid applications for easy download to your phone.

What is different about Android?

Android™ is an open system, which means that you're not limited to using applications and services from only one provider.

Google™ account

Use Gmail™ to send emails, Google Talk™ to chat with friends, and Android Market™ to download applications.

To add an account

- 1 From your Home screen, tap .
- 2 Tap **Settings** > **Accounts & sync** > **Add account**.
- 3 Tap the account type you want to add and then follow the registration wizard.

Basic settings

The first time you start your phone, a setup guide explains basic phone functions and helps you enter essential settings. You can also access the setup guide later.

To access the setup guide

- 1 From the Home screen, tap .
- 2 Find and tap **Setup guide**.

Transferring contacts from your old phone



When you buy a new phone, one of the first challenges is to transfer your contacts and phone numbers from your old phone. This procedure can sometimes be complicated. In this section we give you the big picture and outline solutions based on the type of your old phone. We also tell you where you can find detailed step-by-step instructions.

My old phone is a non-Android™ phone

Sony Ericsson

Transfer the contacts from your old Sony Ericsson phone to your new phone in a few steps:

- 1 **New phone:** Connect your new phone to an Internet-connected PC using a USB cable.
- 2 **New phone:** If prompted, tap the screen to launch the installation of PC Companion on the PC.
- 3 **PC:** In PC Companion, select the option to transfer or synchronise your contacts.
- 4 With your old phone and its USB cable at hand, follow the instructions on the PC screen to transfer your contacts from the old phone to your new one.

To view detailed step-by-step instructions, visit www.sonyericsson.com/support/contacts.

Nokia

Transfer the contacts from your old Nokia Symbian™ phone to your new phone in a few steps.

- ! This method only works for Nokia phones using the S60 platform.
- 1 **New phone:** Connect your new phone to an Internet-connected PC using a USB cable.
 - 2 **New phone:** If prompted, tap the screen to launch the installation of PC Companion on the PC.
 - 3 **PC:** In PC Companion, select the option to transfer or synchronise your contacts.
 - 4 With your old phone and its USB cable at hand, follow the instructions on the PC screen to transfer your contacts from the old phone to your new one.

To view detailed step-by-step instructions, visit www.sonyericsson.com/support/contacts.

iPhone™

Transfer your iPhone™ contacts to your new phone via a Google™ account:

- 1 Connect your iPhone to a PC and start the iTunes™ application. Click the **Info** tab in iTunes™ and select to sync the phone with Google™ Contacts.
If you use a Mac® computer, you need to export your contacts in vCard format from the Mac® Address Book into a vCard file, and then import the vCard file into your Google™ account.
- 2 Once your iPhone contacts are moved to your Google™ account, you need to synchronise your new phone with your Google™ account.

To view detailed step-by-step instructions, visit www.sonyericsson.com/support/contacts.

Other phone

Transfer the contacts from your old phone to a computer and then use Google Sync™ to transfer the contacts to your new phone.

- 1 **Old phone:** Transfer the contacts from your old phone to a computer. The most practical way to do this is by using a memory card.
- 2 Make a note of where you copy the contacts file. This kind of file is usually in vCard (.vcf) or a .csv format.
- 3 **Computer:** Go to www.google.com/contacts and sign in, or create a new Google™ account. Click **Import** and browse to the location of the contacts file, then click **Open**. Your contacts are now stored in your Google account.
- 4 **New phone:** Set up your Google account to work in the phone and then synchronise your contacts.

- 💡 You can also use a mobile phone management software application to transfer the contacts to a computer.

To view detailed step-by-step instructions, visit www.sonyericsson.com/support/contacts.

My old phone is an Android™ phone

Transfer the contacts from your old Android phone directly to your new phone with Google sync™:

- 1 Synchronise the contacts from your old phone with your Google™ account, if you haven't done so already. You can only synchronise contacts that are saved as Google™ account contacts.
- 2 Set up your Google account to work in the new phone. As part of the setup, your contacts get

downloaded to the phonebook application in the phone.

- ! If you have contacts in your phonebook that are not saved as Google™ account contacts, you must first export them to a memory card and then import them again and save them as Google™ account contacts in your phone.

To view detailed step-by-step instructions, visit www.sonyericsson.com/support/contacts.

Finding your way

Home screen

Your phone Home screen is the equivalent of the desktop on a computer. You can customise your Home screen with widgets, shortcuts, folders, themes, wallpaper and other items.

The Home screen extends beyond the regular screen display width, so you need to flick left or right to view content in one of the screen's four extensions.



The items in the bar at the bottom of the screen are always available for quick access.

To go to the Home screen

- Press .

To browse the Home screen

- Flick right or left.

To change your Home screen wallpaper

- 1 From your Home screen, press .
- 2 Tap **Wallpaper**, then select a wallpaper.

Widgets

Widgets are small applications that you can use directly on your Home screen. For example, the **Music player** widget allows you to start playing music directly and the Sony Ericsson Timescape™ widget displays incoming messages.

Application screen

The Application screen, which you open from your Home screen, contains the applications that come

installed with your phone as well as the applications you download.

The Application screen extends beyond the regular screen width, so you need to flick left and right to view all content.

To open the Application screen

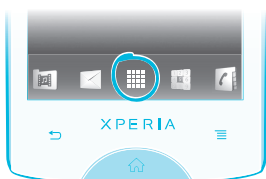

- From your Home screen, tap .

To open an application

- From your Home screen or the Application screen, tap the application.

Applications

An application is a phone program that helps you perform a task. For example, there are applications to make calls, take photos and download more applications.

Status and notifications

The status bar at the top of your screen shows what's going on in your phone. For example, new message and calendar notifications appear here.



Checking notifications and ongoing activities

You can drag down the status bar to open the Notification panel and get more information. For example, open a new message or view a calendar event from the Notification panel. You can also open running applications, such as the music player.

To open the Notification panel

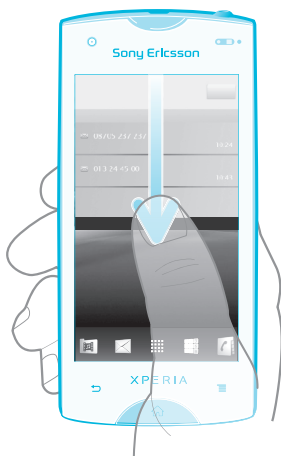

- Drag the status bar downwards.

Phone settings menu

View and change your phone settings from the Settings menu.



To access the phone settings

- 1 From the Home screen, tap .
- 2 Tap **Settings**.

More basics

Calling

To make a call by dialling

- 1 From your Home screen, tap .
- 2 Find and tap **Phone**.
- 3 Enter the number of the recipient and tap **Call**. To delete a number, tap .

To end a call

- Tap **End call**.





To answer a call



- Drag  to the right across the screen.

Multimedia and text messaging

To create and send a message

- 1 From your Home screen, tap , then find and tap .
- 2 Tap **New message**.
- 3 Tap **Write message** and enter your message text.
- 4 To add a recipient, tap **Add recipient**, then select a contact or enter the full number manually.
- 5 If you want to add a media file, tap  and select an option.
- 6 If you want to add or remove recipients before sending the message, press . To add a recipient, tap **Add recipient**. To remove a recipient, tap **Edit recipients** and tap  next to a recipient field. When you are finished, tap **Done**.
- 7 To send the message, tap **Send**.

Legal information

Sony Ericsson ST18i/ST18a

Android Market™ is not available in all countries. Some of the services and features described in this Startup guide are not supported in all countries/regions or by all networks and/or service providers in all areas. Without limitation, this applies to the GSM International Emergency Number 112. Please contact your network operator or service provider to determine availability of any specific service or feature and whether additional access or usage fees apply.

This Startup guide is published by Sony Ericsson Mobile Communications AB or its local affiliated company, without any warranty. Improvements and changes to this Startup guide necessitated by typographical errors, inaccuracies of current information, or improvements to programs and/or equipment, may be made by Sony Ericsson Mobile Communications AB at any time and without notice. Such changes will, however, be incorporated into new editions of this Startup guide.

All rights reserved.

©Sony Ericsson Mobile Communications AB, 2011

Publication number: 1250-1259.1

Your mobile phone has the capability to download, store and forward additional content, e.g. ringtones. The use of such content may be restricted or prohibited by rights of third parties, including but not limited to restriction under applicable copyright laws. You, and not Sony Ericsson, are entirely responsible for additional content that you download to or forward from your mobile phone. Prior to your use of any additional content, please verify that your intended use is properly licensed or is otherwise authorized. Sony Ericsson does not guarantee the accuracy, integrity or quality of any additional content or any other third party content. Under no circumstances will Sony Ericsson be liable in any way for your improper use of additional content or other third party content.

This Startup guide may reference services or applications provided by third parties. Use of such programming or services may require separate registration with the third party provider and may be subject to additional terms of use. For applications accessed on or through a third-party website, please review such websites' terms of use and applicable privacy policy in advance. Sony Ericsson does not warrant or guarantee the availability or performance of any third-party websites or offered services.

Remove the battery to see regulatory information such as the CE mark.

All product and company names mentioned herein are the trademarks or registered trademarks of their respective owners. Any rights not expressly granted herein are reserved. All other trademarks are property of their respective owners.

Visit www.sonyericsson.com/cws/corporate/common/legal/disclaimer for more information.

All illustrations are for illustration only and may not accurately depict the actual phone.

This product is protected by certain intellectual property rights of Microsoft. Use or distribution of such technology outside of this product is prohibited without a license from Microsoft.

Explore more and get support



User guide

A full-length User guide is available in the support application in your phone and at www.sonyericsson.com/support.



Support in the phone

Get user support directly in your phone using the support application.

To access the support application

- 1 From your Application screen, find and tap .
 - 2 Find and tap the required support item.
-



Support on the web

Visit www.sonyericsson.com/support to access a range of support and get the most from your phone.



Customer support

Customer support – if all else fails. Access the relevant support number on the Sony Ericsson website by clicking the **Contact us** link at the bottom of the page.

www.sonyericsson.com/support

www.sonyericsson.com

FCC Statement

Declaration of Conformity



Sony Ericsson

Sony Ericsson Mobile Communications AB
SE-221 88 Lund, Sweden

1250-1377.1

Sony Ericsson ST18i

UMTS HSPA Band 1 8 GSM GPRS/EDGE 850/900/1800/1900

Important Information

United States & Canada

THIS PHONE MODEL HAS BEEN CERTIFIED IN COMPLIANCE WITH THE GOVERNMENT'S REQUIREMENTS FOR EXPOSURE TO RADIO WAVES.

The ST18i Series mobile phones have been designed to comply with applicable safety requirements for exposure to radio waves. Your wireless phone is a radio transmitter and receiver. It is designed to not exceed the limits* of exposure to radio frequency (RF) energy set by governmental authorities. These limits establish permitted levels of RF energy for the general population. The guidelines are based on standards that were developed by international scientific organizations through periodic and thorough evaluation of scientific studies. The standards include a safety margin designed to assure the safety of all individuals, regardless of age and health.

The radio wave exposure guidelines employ a unit of measurement known as the Specific Absorption Rate (SAR). Tests for SAR are conducted using standardized methods with the phone transmitting at its highest certified power level in all used frequency bands. While there may be differences between the SAR levels of various phone models, they are all designed to meet the relevant guidelines for exposure to radio waves. For more information on SAR, please refer to the safe and efficient use chapter in the User Guide.

The highest SAR value as reported to the authorities for this phone model when tested for use by the ear is 1.09 W/kg*, and when worn on the body is 0.34 W/kg* for speech and 0.99 W/kg* for data calls. For body-worn operation, the phone has been tested when positioned a minimum of 15 mm from the body without any metal parts in the vicinity of the phone or when properly used with an appropriate Sony Ericsson accessory and worn on the body. For devices which include "WiFi hotspot" functionality, body-worn SAR measurements for operation of the device operating in WiFi hotspot mode were taken using a separation distance of 10mm.

2

Renseignements importants

États-Unis et Canada

CE MODÈLE DE TÉLÉPHONE A ÉTÉ CERTIFIÉ CONFORME AUX EXIGENCES GOUVERNEMENTALES RELATIVES À L'EXPOSITION AUX ONDES RADIOÉLECTRIQUES.

Les téléphones mobiles de la ST18i ont été conçus pour répondre aux normes de sécurité en vigueur en matière d'exposition aux ondes radioélectriques. Votre téléphone sans fil est un émetteur et un récepteur radio. Il est conçu de manière à ne pas dépasser les limites* d'exposition à l'énergie des fréquences radio (RF) établies par les autorités gouvernementales. Ces limites fixent les niveaux maximaux d'énergie RF auxquels peut être soumis le grand public. Ces lignes directrices sont basées sur des normes qui ont été élaborées par des organisations scientifiques internationales par le biais d'évaluations périodiques et approfondies des études scientifiques. Ces normes prévoient une marge de sécurité visant à assurer la protection de tous les individus, peu importe leur âge et leur état de santé.

Les lignes directrices relatives à l'exposition aux ondes radioélectriques utilisent une unité de mesure appelée « Taux d'absorption spécifique » (TAS). Les tests de TAS sont effectués selon des méthodes standardisées dans lesquelles le téléphone émet dans toutes les bandes de fréquences utilisées, à la plus forte puissance pour laquelle il a été homologué. Bien que le TAS puisse être différent d'un modèle de téléphone à un autre, tous les appareils sont conçus pour respecter les lignes directrices relatives aux ondes radioélectriques. Pour en savoir plus sur le TAS, reportez-vous au chapitre sur l'utilisation efficace et sans danger du guide de l'utilisateur.

Le TAS le plus élevé relevé par les autorités pour ce modèle de téléphone est de 1.09 W/kg* lorsqu'il est testé en utilisation près de l'oreille, et de 0.34 W/kg* pour les appels vocaux et de 0.99 W/kg* pour les transmissions de données lorsqu'il est porté sur le corps. En mode d'utilisation porté sur le corps, le téléphone a été testé lorsqu'il est à au moins 15 mm du corps et à l'écart de toute pièce en métal, ou lorsqu'il est utilisé de façon adéquate

4

Información importante

Estados Unidos y Canadá

ESTE MODELO DE TELÉFONO HA SIDO CERTIFICADO CONFORME A LOS REQUISITOS GUBERNAMENTALES PARA LA EXPOSICIÓN A ONDAS DE RADIO.

Los teléfonos móviles de la Serie ST18i han sido diseñados según los requisitos de seguridad aplicables para la exposición a ondas de radio. Su teléfono inalámbrico es un transmisor y receptor de radio. Está diseñado para no superar los límites* de exposición a energía de radiofrecuencia (RF) fijados por las autoridades gubernamentales. Estos límites establecen los niveles permitidos de energía de RF para la población general. Las especificaciones se basan en los estándares desarrollados por organizaciones científicas internacionales mediante evaluaciones periódicas y minuciosas de estudios científicos. Los estándares incluyen un margen de seguridad destinado a garantizar la seguridad de todas las personas, independientemente de la edad y de la salud.

Las especificaciones de la exposición a ondas de radio emplean una unidad de medida conocida como la Tasa específica de absorción (SAR, por su sigla en inglés). Las pruebas de SAR se llevan a cabo mediante el uso de métodos estandarizados con la transmisión telefónica al más alto nivel de energía registrado en todas las bandas de frecuencia utilizadas. Aunque es posible que haya diferencias entre los niveles de SAR de los diferentes modelos de teléfonos, todos están diseñados para cumplir con las especificaciones correspondientes de la exposición a ondas de radio. Para obtener más información sobre SAR, consulte el capítulo sobre uso seguro y eficaz que se encuentra en la Guía del usuario.

Según se reportó a las autoridades, el valor más alto de SAR de este modelo de teléfono cuando se probó usándolo cerca del oído es de 1.09 W/kg* y al usarlo en el cuerpo es de 0.34 W/kg* para hablar y 0.99 W/kg* para llamadas de datos. Para su uso cerca del cuerpo, el teléfono ha sido probado para su funcionamiento a una distancia mínima de 15 mm (0,59 pulg.) del cuerpo, sin que haya

6

Use of third-party accessories may result in different SAR levels than those reported.

**Before a phone model is available for sale to the public in the US, it must be tested and certified by the Federal Communications Commission (FCC) that it does not exceed the limit established by the government-adopted requirement for safe exposure*. The tests are performed in positions and locations (i.e., by the ear and worn on the body) as required by the FCC for each model. The FCC has granted an Equipment Authorization for this phone model with all reported SAR levels evaluated as in compliance with the FCC RF exposure guidelines. While there may be differences between the SAR levels of various phones, all mobile phones granted an FCC equipment authorization meet the government requirement for safe exposure. SAR information on this phone model is on file at the FCC and can be found under the Display Grant section of <http://www.fcc.gov/oet/fccid> after searching on FCC ID PY7A3880119. Additional information on SAR can be found on the Cellular Telecommunications & Internet Association (CTIA) website at <http://www.phonefacts.net>.

* In the United States and Canada, the SAR limit for mobile phones used by the public is 1.6 watts/kilogram (W/kg) averaged over one gram of tissue. The standard incorporates a margin of safety to give additional protection for the public and to account for any variations in measurements.

**This paragraph is only applicable to authorities and customers in the United States.

3

avec un accessoire Sony Ericsson et porté sur le corps. Pour les appareils munis de la fonctionnalité « point d'accès WiFi », en mode d'utilisation porté sur le corps, les mesures du TAS de l'appareil en mode WiFi ont été prises à une distance de sécurité de 10 mm. L'utilisation d'accessoires tiers peut produire des niveaux de TAS différents de ceux relevés.

**Avant qu'un modèle de téléphone ne soit mis en vente auprès du public aux États-Unis, la Commission fédérale des communications (CFC) doit le tester et certifier qu'il respecte les limites fixées dans les exigences gouvernementales d'exposition sans danger*. Pour chaque modèle, les tests sont effectués en position et aux endroits d'usage (c.-à-d. près de l'oreille et porté sur le corps), tel que requis par la CFC. La CFC a accordé une autorisation d'équipement pour ce modèle de téléphone, après que tous les niveaux de TAS indiqués aient été évalués et considérés conformes aux lignes directrices de la CFC en matière d'exposition aux radiofréquences. Même s'il peut y avoir des différences entre les niveaux de TAS des différents téléphones, tous les téléphones mobiles auxquels la CFC a accordé une autorisation d'équipement répondent aux normes gouvernementales en matière d'exposition sans danger. La CFC conserve dans ses dossiers l'information relative aux TAS relevés pour ce modèle de téléphone. Vous pouvez la consulter au <http://www.fcc.gov/oet/fccid> sous la rubrique « Display Grant », après avoir effectué une recherche sur CFC ID PY7A3880119. Vous trouverez des renseignements supplémentaires concernant le TAS sur le site Web de la Cellular Telecommunications & Internet Association (CTIA) au <http://www.phonefacts.net>.

* Aux États-Unis et au Canada, la limite de TAS des téléphones mobiles utilisés par le public est de 1,6 watt/kg (W/kg) en moyenne sur un gramme de tissu. Cette norme comporte une marge importante de sécurité afin d'assurer une protection supplémentaire et de tenir compte de toute variation dans les mesures.

**Ce paragraphe ne concerne que les autorités et les clients des États-Unis.

5

piezas metálicas cerca del teléfono o cuando se utiliza correctamente con el accesorio adecuado Sony Ericsson. En lo que respecta a los dispositivos que cuentan con la funcionalidad "Zona activa WiFi", las medidas SAR del uso cerca del cuerpo del dispositivo, el cual funciona en modo de zona activa WiFi, se tomaron mediante el uso de una distancia de separación de 10 mm. El uso de accesorios de terceros puede resultar en niveles de SAR diferentes a aquellos que se reportaron.

**Antes de que un modelo de teléfono se encuentre disponible para la venta al público en los Estados Unidos, la Comisión federal de telecomunicaciones (FCC) debe aprobarlo y certificar que no supera el límite establecido por el requisito adoptado por el gobierno para una exposición segura*. Las pruebas se llevan a cabo en posiciones y ubicaciones (es decir, cerca del oído y cerca del cuerpo) según lo requiere la FCC para cada modelo. La FCC ha otorgado una Autorización de equipo para este modelo de teléfono con todos los niveles de SAR reportados, los cuales fueron evaluados conforme a las especificaciones de exposición a RF de la FCC. Aunque es posible que haya diferencias entre los niveles de SAR de los diferentes teléfonos, todos los teléfonos móviles que cuentan con una autorización de equipo de la FCC cumplen con los requisitos gubernamentales para la exposición segura. La información sobre SAR de este modelo de teléfono está archivada en la FCC y puede encontrarla en la sección Display Grant (Mostrar subvención) en <http://www.fcc.gov/oet/fccid> después de buscar la ID PY7A3880119 de la FCC. Puede encontrar información adicional sobre SAR en el sitio Web de la Asociación de Telecomunicaciones Celulares e Internet (CTIA) en <http://www.phonefacts.net>.

* En los Estados Unidos y Canadá, el límite de SAR de los teléfonos móviles utilizados por el público es de 1.6 watts/kilogramo (W/kg) promediados sobre un gramo de tejido. El estándar incluye un margen de seguridad para proporcionarle una protección adicional al público y para tomar en cuenta cualquier variación en las medidas.

**Este párrafo se aplica únicamente a autoridades y clientes de los Estados Unidos.

7

Important Information

Latin & South America

Radio wave exposure and Specific Absorption Rate (SAR) information

The ST18i Series mobile phones have been designed to comply with applicable safety requirements for exposure to radio waves. These requirements are based on scientific guidelines that include safety margins designed to assure the safety of all persons, regardless of age and health.

The radio wave exposure guidelines employ a unit of measurement known as the Specific Absorption Rate, or SAR. Tests for SAR are conducted using standardised methods with the phone transmitting at its highest certified power level in all used frequency bands.

While there may be differences between the SAR levels of various phone models, they are all designed to meet the relevant guidelines for exposure to radio waves.

For more information on SAR, please refer to the safety chapter in the User Guide.

SAR data information for residents in countries that have adopted the SAR limit recommended by the International Commission on Non-Ionizing Radiation Protection (ICNIRP), which is 2 W/kg averaged over ten (10) gram of tissue (for example European Union, Japan, Brazil and New Zealand):

The highest SAR value for this model phone when tested by Sony Ericsson for use at the ear is 0.96 W/kg (10g).

8

Información importante

Latinoamérica y América del Sur

Información acerca de la exposición a ondas de radio y la Tasa específica de absorción (SAR)

El teléfono móvil ST18i ha sido diseñado para cumplir con los requisitos de seguridad aplicables de exposición a las ondas de radio. Dichos requisitos se basan en directrices científicas que establecen márgenes de seguridad con el fin de evitar perjuicios a todas las personas, independientemente de su edad o estado de salud.

Las directrices de exposición a ondas de radio utilizan una unidad de medida denominada coeficiente de absorción específica o SAR. Las pruebas de SAR se llevan a cabo utilizando métodos normalizados, con el teléfono transmitiendo en el nivel más elevado de potencia autorizado en todas las bandas de frecuencia utilizadas.

Aunque puede existir diferencias entre los niveles de SAR de diferentes modelos de teléfono, todos han sido diseñados para cumplir las directrices pertinentes sobre exposición a ondas de radio.

Para obtener más información sobre el SAR, consulte el capítulo sobre seguridad en la guía del usuario.

Información sobre datos de SAR para residentes de países en los que se haya adoptado el límite de SAR recomendado por la International Commission on Non-Ionizing Radiation Protection (ICNIRP, Comisión internacional de protección contra la radiación no ionizantes (ICNIRP, International Commission on Non-Ionizing Radiation Protection), es 2 W/kg promedio por cada diez (10) gramos de tejido (por ejemplo, la Unión Europea, Japón, Brasil y Nueva Zelanda):

El valor de SAR más elevado para este modelo de teléfono cuando Sony Ericsson realizó la prueba para su uso en la oreja era de 0,96 W/kg (10g).

9

Informação importante

América do Sul e Latina

Informações sobre SAR (Taxa de Absorção Específica) e exposição à radiofrequência

O celular ST18i foi projetado para cumprir os requisitos de segurança aplicáveis para exposição à radiofrequência. Esses requisitos têm como base diretrizes científicas que incluem as margens de segurança para garantir a segurança de todas as pessoas, independentemente da idade e da saúde.

As diretrizes de exposição à radiofrequência usam uma unidade de medida conhecida como SAR ou Taxa de Absorção Específica. Os testes de SAR são conduzidos por métodos padronizados com a transmissão telefônica em seu nível certificado de energia mais alto em todas as faixas de frequência usadas.

Embora possa haver diferenças entre os níveis de SAR de vários modelos de telefone, todos foram projetados para atender as diretrizes relevantes de exposição à radiofrequência.

Para obter mais informações sobre SAR, consulte o capítulo de segurança do Guia do Usuário.

Informações sobre os dados de SAR para moradores de países que adotaram o limite SAR recomendado pelo ICNIRP (International Commission on Non-Ionizing Radiation Protection) que é o limite médio de 2 W/kg em dez (10) gramas de tecido (por exemplo, União Europeia, Japão, Brasil e Nova Zelândia).

Quando testado pela Sony Ericsson, o valor de SAR mais alto para este modelo de telefone para uso junto ao ouvido foi de 0,96 W/kg (10g).

10

FCC Statement

This device complies with Part 15 of the FCC rules.

Operation is subject to the following two conditions: (1) This device may not cause harmful interference, and (2)

This device must accept any interference received, including interference that may cause undesired operation.

Any change or modification not expressly approved by Sony Ericsson may void the user's authority to operate the equipment.

This equipment has been tested and found to comply with the limits for a Class B digital device, pursuant to Part 15 of the FCC Rules. These limits are designed to provide reasonable protection against harmful interference in a residential installation. This equipment generates, uses and can radiate radio frequency energy and, if not installed and used in accordance with the instructions, may cause harmful interference to radio communications.

However, there is no guarantee that interference will not occur in a particular installation.

If this equipment does cause harmful interference to radio or television reception, which can be determined by turning the equipment off and on, the user is encouraged to try to correct the interference by one or more of the following measures:

- Reorient or relocate the receiving antenna.
- Increase the separation between the equipment and receiver.
- Connect the equipment into an outlet on a circuit different from that to which the receiver is connected.
- Consult the dealer or an experienced radio/TV technician for help.



11

Industry Canada Statement

This device complies with RSS-210 of Industry Canada.

Operation is subject to the following two conditions: (1) this device may not cause interference, and (2) this device must accept any interference, including interference that may cause undesired operation of the device.

This Class B digital apparatus complies with Canadian ICES-003.

Cet appareil numérique de la classe B est conforme à la norme NMB-003 du Canada.

12

Declaration of Conformity for ST18i

We, **Sony Ericsson Mobile Communications AB** of

Nya Vattentorget

SE-221 88 Lund, Sweden

declare under our sole responsibility that our product

Sony Ericsson type AAD-3880119-BV

and in combination with our accessories, to which this declaration relates is in conformity with the appropriate standards EN 301 511:V9.0.2, EN 301 908-1:V4.2.1, EN 301 908-2:V4.2.1, EN 300 328:V1.7.1, EN 300 440-2:V1.4.1, EN 301 489-7:V1.3.1, EN 301 489-17:V2.1.1, EN 301 489-24:V1.5.1, EN 301 489-3:V1.4.1 and EN 60 950-1:2006+A11:2009+A1:2010 following the provisions of, Radio Equipment and Telecommunication Terminal Equipment directive **1999/5/EC**.

Lund, May 2011

CE 0682

Dan Redin,

Corporate Vice President, Head of Development

We fulfil the requirements of the R&TTE Directive (1999/5/EC).

Ce produit est conforme aux directives de R&TTE (**1999/5/EC**).

Cumplimos con los requisitos de la Directiva R&TTE – Normas sobre equipos de terminales de radio y telecomunicaciones (**1999/5/EC**).

Atendemos aos requisitos da Diretriz R&TTE (**1999/5/EC**).

13

Sony Ericsson Consumer Web site

At www.sonyericsson.com/support there is a support section where help and tips are only a few clicks away. Here you will find the latest computer software updates and tips on how to use your product more efficiently.

Service and support

You have access to a portfolio of exclusive service advantages such as:

- Global and local Web sites providing support.
- A global network of Contact Centers.
- An extensive network of Sony Ericsson service partners.
- A warranty period. Learn more about the warranty conditions in the *Limited warranty* section.

At www.sonyericsson.com/support, you can find the latest support tools and information. For operator-specific services and features, please contact your network operator.

You can also contact our Contact Centers. If your country/region is not represented in the list below, please contact your local dealer. (Calls are charged according to national rates, including local taxes, unless the phone number is a toll-free number.)

If your product needs service, please contact the dealer from whom it was purchased, or one of our service partners. For warranty claims, save proof of purchase.

Guidelines for Safe and Efficient Use

Please follow these guidelines. Failure to do so might entail a potential health risk or product malfunction. If in doubt as to its proper function, have the product checked by a certified service partner before charging or using it.

Recommendations for care and safe use of our products

- Handle with care and keep in a clean and dust-free place.
- **Warning!** May explode if disposed of in fire.
- Do not expose to liquid or moisture or excess humidity.

phone. The SAR value is determined at the highest certified power level in laboratory conditions, but because the phone is designed to use the minimum power necessary to access the chosen network, the actual SAR level can be well below this value. There is no proof of difference in safety based on difference in SAR value.

Products with radio transmitters sold in the US must be certified by the Federal Communications Commission (FCC). When required, tests are performed when the phone is placed at the ear and when worn on the body. For body-worn operation, the phone has been tested when positioned a minimum of 15 mm from the body without any metal parts in the vicinity of the phone or when properly used with an appropriate Sony Ericsson accessory and worn on the body.

For more information about SAR and radio frequency exposure, go to: www.sonyericsson.com/health.

Flight mode

Bluetooth and WLAN functionality, if available in the device, can be enabled in Flight mode but may be prohibited onboard aircraft or in other areas where radio transmissions are prohibited. In such environments, please seek proper authorisation before enabling Bluetooth or WLAN functionality even in Flight mode.

Malware

Malware (short for malicious software) is software that can harm the mobile phone or other computers. Malware or harmful applications can include viruses, worms, spyware, and other unwanted programs. While the device does employ security measures to resist such efforts, Sony Ericsson does not warrant or represent that the device will be impervious to the introduction of malware. You can however reduce the risk of malware attacks by using care when downloading content or accepting applications, refraining from opening or responding to messages from unknown sources, using trustworthy services to access the Internet, and only downloading content to the mobile phone from known, reliable sources.

This licence is governed by the laws of Sweden. When applicable, the foregoing applies to statutory consumer rights.

In the event Software accompanying or provided in conjunction with your device is provided with additional terms and conditions, such provisions shall also govern your possession and usage of the Software.

Export regulations

Export regulations: Goods delivered under this Agreement may be the subject to import and export regulations of the European Union, the United States and other countries. Purchaser will comply with these applicable laws and regulations and will obtain and maintain any export and import license required for the delivery of goods to Purchaser under this Agreement. Without limiting the foregoing, and as an example, Purchaser will not knowingly export or re-export goods to destinations identified pursuant to Articles in Chapter II of European Council Regulation (EC) 428/2009 and specifically, and without limitation, Purchaser will also comply with U.S. government Export Administration Regulations ("EAR", 15 C.F.R. §§ 730-774, <http://www.bis.doc.gov/>) administered by Department of Commerce, Bureau of Industry and Security and economic sanctions regulations (30 C.F.R. §§ 500 et. seq., <http://www.treas.gov/offices/enforcement/ofac/>) administered by the U.S. Department of Treasury, Office of Foreign Assets Control.

Limited Warranty

Sony Ericsson Mobile Communications AB, SE-221 88 Lund, Sweden, (Sony Ericsson) or its local affiliated company, provides this Limited Warranty for your mobile phone, original accessory delivered with your mobile phone, and/or your mobile computing product (hereinafter referred to as "Product").

Should your Product need warranty service, please return it to the dealer from whom it was purchased, or contact your local

- For optimum performance, the product should not be operated in temperatures below -10°C(+14°F) or above +45°C(+113°F). Do not expose the battery to temperatures above +60°C(+140°F).



- Do not expose to flames or lit tobacco products.
- Do not drop, throw or try to bend the product.
- Do not paint or attempt to disassemble or modify the product. Only Sony Ericsson authorised personnel should perform service.



- Consult with authorised medical staff and the instructions of the medical device manufacturer before using the product near pacemakers or other medical devices or equipment.
- Discontinue use of electronic devices, or disable the radio transmitting functionality of the device, where required or requested to do so.
- Do not use where a potentially explosive atmosphere exists.
- Do not place the product, or install wireless equipment, in the area above an air bag in a car.
- **Caution:** Cracked or broken displays may create sharp edges or splinters that could be harmful upon contact.
- Do not use the Bluetooth Headset in positions where it is uncomfortable or will be subject to pressure.

Children

Warning! Keep out of the reach of children. Do not allow children to play with mobile phones or accessories. They could hurt themselves or others. Products may contain small parts that could become detached and create a choking hazard.



Power supply (Charger)

Connect the charger to power sources as marked on the product. Do not use outdoors or in damp areas. Do not alter or subject the cord to damage or stress. Unplug the unit before cleaning it. Never alter the plug. If it does not fit into the outlet, have a proper outlet installed by an electrician. When a power supply is connected there is a small drain of power. To avoid this small energy waste, disconnect the power supply when the product is fully charged.

Accessories

Use only Sony Ericsson branded original accessories and certified service partners. Sony Ericsson does not test third-party accessories. Accessories may influence RF exposure, radio performance, loudness, electric safety and other areas. Third-party accessories and parts may pose a risk to your health or safety or decrease performance.

Accessible Solutions/Special Needs

In the US, compatible Sony Ericsson phones may offer compatibility with TTY terminals (with use of necessary accessory). For more information call the Sony Ericsson Special Needs Center on 877 878 1996 (TTY) or 877 207 2056 (voice), or go to www.sonyericsson-snc.com.

Disposal of old electrical and electronic equipment

Electronic equipment and batteries should not be included as household waste but should be left at an appropriate collection point for recycling. This helps prevent potential negative consequences for the environment and human health. Check local regulations by contacting your local city office, your household waste disposal service, the shop where you purchased the product or calling a Sony Ericsson Contact Center. Do not attempt to remove internal batteries. Internal batteries shall be removed only by a waste treatment facility or trained service professional.



Disposing of the battery

Check local regulations or call a Sony Ericsson Contact Center for information. Never use municipal waste.



Memory card

If the product comes complete with a removable memory card, it is generally compatible with the handset purchased but may not be compatible with other devices or the capabilities of their memory cards. Check other devices for compatibility before purchase or use. If the product is equipped with a memory card reader, check memory card compatibility before purchase or use.

Sony Ericsson Contact Center (national rates may apply) or visit www.sonyericsson.com to get further information.

Our warranty

Subject to the conditions of this Limited Warranty, Sony Ericsson warrants this Product to be free from defects in design, material and workmanship at the time of its original purchase by a consumer. This Limited Warranty will last for a period of two (2) years as from the original date of purchase of the Product for your mobile phone, and for a period of one (1) year following the original purchase date of the Product for all original accessories (such as the battery, charger or handsfree kit) which may be delivered with your mobile phone.

What we will do

If, during the warranty period, this Product fails to operate under normal use and service, due to defects in design, materials or workmanship, Sony Ericsson authorised distributors or service partners, in the country/region* where you purchased the Product, will, at their option, either repair or replace the Product in accordance with the terms and conditions stipulated herein.

Sony Ericsson and its service partners reserve the right to charge a handling fee if a returned Product is found not to be under warranty according to the conditions below.

Please note that some of your personal settings, downloads and other information may be lost when your Sony Ericsson Product is repaired or replaced. At present, Sony Ericsson may be prevented by applicable law, other regulation or technical restrictions from making a backup copy of certain downloads. Sony Ericsson does not take any responsibility for any lost information of any kind and will not reimburse you for any such loss. You should always make backup copies of all the information stored on your Sony Ericsson Product such as downloads, calendar and contacts before handing in your Sony Ericsson Product for repair or replacement.

Use of charging devices that are not Sony Ericsson branded may pose increased safety risks.

Battery

New or idle batteries can have short-term reduced capacity. Fully charge the battery before initial use. Use for the intended purpose only. Charge the battery in temperatures between +5°C(+41°F) and +45°C(+113°F). Do not put the battery into your mouth. Do not let the battery contacts touch another metal object. Turn off the product before removing the battery. Performance depends on temperatures, signal strength, usage patterns, features selected and voice or data transmissions. Only Sony Ericsson service partners should remove or replace built-in batteries. Use of batteries that are not Sony Ericsson branded may pose increased safety risks. Replace the battery only with another Sony Ericsson battery that has been qualified with the product per the standard IEEE-1725. Use of an unqualified battery may present a risk of fire, explosion, leakage or other hazard.

Personal medical devices

Mobile phones may affect implanted medical equipment. Reduce risk of interference by keeping a minimum distance of 15 cm(6 inches) between the phone and the device. Use the phone at your right ear. Do not carry the phone in your breast pocket. Turn off the phone if you suspect interference. For all medical devices, consult a physician and the manufacturer.

Driving

Some vehicle manufacturers forbid the use of phones in their vehicles unless a handsfree kit with an external antenna supports the installation. Check with the vehicle manufacturer's representative to be sure that the mobile phone or Bluetooth handsfree will not affect the electronic systems in the vehicle. Full attention should be given to driving at all times and local laws and regulations restricting the use of wireless devices while driving must be observed.

Memory cards are generally formatted prior to shipping. To reformat the memory card, use a compatible device. Do not use the standard operating system format when formatting the memory card on a PC. For details, refer to the operating instructions of the device or contact customer support.

Warning!

If the device requires an adapter for insertion into the handset or another device, do not insert the card directly without the required adapter.

Precautions on memory card use

- Do not expose the memory card to moisture.
- Do not touch terminal connections with your hand or any metal object.
- Do not strike, bend, or drop the memory card.
- Do not attempt to disassemble or modify the memory card.
- Do not use or store the memory card in humid or corrosive locations or in excessive heat such as a closed car in summer, in direct sunlight or near a heater, etc.
- Do not press or bend the end of the memory card adapter with excessive force.
- Do not let dirt, dust, or foreign objects get into the insert port of any memory card adapter.
- Check you have inserted the memory card correctly.
- Insert the memory card as far as it will go into any memory card adapter needed. The memory card may not operate properly unless fully inserted.
- We recommend that you make a backup copy of important data. We are not responsible for any loss or damage to content you store on the memory card.
- Recorded data may be damaged or lost when you remove the memory card or memory card adapter, turn off the power while formatting, reading or writing data, or use the memory card in locations subject to static electricity or high electrical field emissions.

GPS/Location based functions
Some products provide GPS/Location based functions. Location determining functionality is provided "As is" and "With all faults". Sony Ericsson does not make any representation or warranty as to the accuracy of such location information.

Use of location-based information by the device may not be uninterrupted or error free and may additionally be dependent on network service availability. Please note that functionality may be reduced or prevented in certain environments such as building interiors or areas adjacent to buildings.

Caution: Do not use GPS functionality in a manner which causes distraction from driving.

Emergency calls

Calls cannot be guaranteed under all conditions. Never rely solely upon mobile phones for essential communication. Calls may not be possible in all areas, on all networks, or when certain network services and/or phone features are used.

Antenna

Use of antenna devices not marketed by Sony Ericsson could damage the phone, reduce performance, and produce SAR levels above the established limits. Do not cover the antenna with your hand as this affects call quality, power levels and can shorten talk and standby times.

Radio Frequency (RF) exposure and Specific Absorption Rate (SAR)

When the phone or Bluetooth handsfree is turned on, it emits low levels of radio frequency energy. International safety guidelines have been developed through periodic and thorough evaluation of scientific studies. These guidelines establish permitted levels of radio wave exposure. The guidelines include a safety margin designed to assure the safety of all persons and to account for any variations in measurements.

Specific Absorption Rate (SAR) is used to measure radio frequency energy absorbed by the body when using a mobile

Protection of personal information

Erase personal data before disposing of the product. To delete data, perform a master reset. Deleting data from the phone memory does not ensure that it cannot be recovered. Sony Ericsson does not warrant against recovery of information and does not assume responsibility for disclosure of any information even after a master reset.

Loudness warning!

Avoid volume levels that may be harmful to your hearing.

End User Licence Agreement

Software delivered with this device and its media is owned by Sony Ericsson Mobile Communications AB, and/or its affiliated companies and its suppliers and licensors.

Sony Ericsson grants you a non-exclusive limited licence to use the Software solely in conjunction with the Device on which it is installed or delivered. Ownership of the Software is not sold, transferred or otherwise conveyed.

Do not use any means to discover the source code or any component of the Software, reproduce and distribute the Software, or modify the Software. You are entitled to transfer rights and obligations to the Software to a third party, solely together with the Device with which you received the Software, provided the third party agrees in writing to be bound by the terms of this Licence.

This licence exists throughout the useful life of this Device. It can be terminated by transferring your rights to the Device to a third party in writing.

Failure to comply with any of these terms and conditions will terminate the licence immediately.

Sony Ericsson and its third party suppliers and licensors retain all rights, title and interest in and to the Software. To the extent that the Software contains material or code of a third party, such third parties shall be beneficiaries of these terms.



Conditions

1. This Limited Warranty is valid only if the original proof of purchase for this Product issued by a Sony Ericsson authorised dealer specifying the date of purchase and serial number**, is presented with the Product to be repaired or replaced. Sony Ericsson reserves the right to refuse warranty service if this information has been removed or changed after the original purchase of the Product from the dealer.
2. If Sony Ericsson repairs or replaces the Product, the repair for the defect concerned, or the replaced Product shall be warranted for the remaining time of the original warranty period or for ninety (90) days from the date of repair, whichever is longer. Repair or replacement may involve the use of functionally equivalent reconditioned units. Replaced parts or components will become the property of Sony Ericsson.
3. This warranty does not cover any failure of the Product due to normal wear and tear, or due to misuse, including but not limited to use in other than the normal and customary manner, in accordance with the Sony Ericsson instructions for use and maintenance of the Product. Nor does this warranty cover any failure of the Product due to accident, software or hardware modification or adjustment, acts of God or damage resulting from liquid.

A rechargeable battery can be charged and discharged more than a hundred times. However, it will eventually wear out – this is not a defect and corresponds to normal wear and tear. When the talk-time or standby time is noticeably shorter, it is time to replace the battery. Sony Ericsson recommends that you use only batteries and chargers approved by Sony Ericsson.

Minor variations in display brightness and colour may occur between phones. There may be tiny bright or dark dots on the display. These are called defective pixels and occur when individual dots have malfunctioned and can not be adjusted. Two defective pixels are deemed acceptable.

Minor variations in camera image appearance may occur between phones. This is nothing uncommon and is not regarded as a defective camera module.

4. Since the cellular system on which the Product is to operate is provided by a carrier independent from Sony Ericsson, Sony Ericsson will not be responsible for the operation, availability, coverage, services or range of that system.
5. This warranty does not cover Product failures caused by installations, modifications, or repair or opening of the Product performed by a non-Sony Ericsson authorised person.
6. The warranty does not cover Product failures which have been caused by use of accessories or other peripheral devices which are not Sony Ericsson branded original accessories intended for use with the Product. Sony Ericsson disclaims any and all warranties, whether express or implied, for failures caused to the Product or peripheral devices as a result of viruses, trojan horses, spyware, or other malicious software. Sony Ericsson strongly recommends that you install appropriate virus protection software on your Product and any peripheral devices connected to it, as available, and update it regularly, to better protect your device. It is understood, however, that such software will never fully protect your Product or its peripheral devices and Sony Ericsson disclaims all warranties, whether express or implied, in case of failure by such antivirus software to fulfil its intended purpose.
7. Tampering with any of the seals on the Product will void the warranty.

8. THERE ARE NO EXPRESS WARRANTIES, WHETHER WRITTEN OR ORAL, OTHER THAN THIS PRINTED LIMITED WARRANTY. ALL IMPLIED WARRANTIES, INCLUDING WITHOUT LIMITATION THE IMPLIED WARRANTIES OF MERCHANTABILITY OR FITNESS FOR A PARTICULAR PURPOSE, ARE LIMITED TO THE DURATION OF THIS LIMITED WARRANTY. IN NO EVENT SHALL SONY ERICSSON OR ITS LICENSORS BE LIABLE FOR INCIDENTAL OR CONSEQUENTIAL DAMAGES OF ANY NATURE WHATSOEVER, INCLUDING BUT NOT LIMITED TO LOST PROFITS OR COMMERCIAL LOSS TO THE FULL EXTENT THOSE DAMAGES CAN BE DISCLAIMED BY LAW.

Some countries/states do not allow the exclusion or limitation of incidental or consequential damages, or limitation of the duration

of implied warranties, so the preceding limitations or exclusions may not apply to you.

The warranty provided does not affect the consumer's statutory rights under applicable legislation in force, nor the consumer's rights against the dealer arising from their sales / purchase contract.

*Geographical scope of the warranty

If you have purchased your Product in a country member of the European Economic Area (EEA) or in Switzerland or the Republic of Turkey, and such Product was intended for sale in the EEA or in Switzerland or in Turkey, you can have your Product serviced in any EEA country or in Switzerland or in Turkey, under the warranty conditions prevailing in the country in which you require servicing, provided that an identical Product is sold in such country by an authorised Sony Ericsson distributor. To find out if your Product is sold in the country you are in, please call the local Sony Ericsson Contact Center. Please observe that certain services may not be available outside the country of original purchase, for example, due to the fact that your Product may have an interior or exterior which is different from equivalent models sold in other countries. Please note in addition that it may sometimes not be possible to repair SIM-locked Products.

** In some countries/regions additional information (such as a valid warranty card) may be requested.

Trademarks and acknowledgements

The Liquid Identity logo and Xperia are trademarks or registered trademarks of Sony Ericsson Mobile Communications AB.

Sony is a trademark or a registered trademark of Sony Corporation.

Ericsson is a trademark or registered trademark of Telefonaktiebolaget LM Ericsson.

Bluetooth is a trademark or a registered trademark of Bluetooth SIG Inc. and any use of such mark by Sony Ericsson is under license.

Support

Anguilla	1-800-080-9518 (Toll Free)	questions.CO@support.sonyericsson.com
Antigua and Barbuda	1-800-081-9518 (Toll Free)	questions.CO@support.sonyericsson.com
Argentina	0800-333-7427 (número gratuito)	questions.CO@support.sonyericsson.com
Australia	1300 650-050 (Toll Free)	questions.AU@support.sonyericsson.com
The Bahamas	1-800-205-6062 (Toll Free)	questions.CO@support.sonyericsson.com
Barbados	1-800-082-9518 (Toll Free)	questions.CO@support.sonyericsson.com
Belgique/België	02-0745 1611	questions.BE@support.sonyericsson.com
Belize	AN 815, PIN 5597 (Toll Free)	questions.CO@support.sonyericsson.com
Bermuda	1-800-083-9518 (Toll Free)	questions.CO@support.sonyericsson.com
Bolivia	800-100-542 (número gratuito)	questions.CO@support.sonyericsson.com
Brasil	4001-0444 (ligação gratuita)	questions.BR@support.sonyericsson.com
Canada	1 866 766 9374 (Toll Free / sans frais)	questions.CA@support.sonyericsson.com
Cayman Islands	1-800-084-9518 (Toll Free)	questions.CO@support.sonyericsson.com
Central and Southern Africa	+27 11 506 0123	questions.CF@support.sonyericsson.com
Česká republika	844 550 055	questions.CZ@support.sonyericsson.com
Chile	800-646-425 (número gratuito)	questions.CO@support.sonyericsson.com
Colombia	01800-0966-080 (número gratuito)	questions.CO@support.sonyericsson.com

16

Costa Rica	0 800 011 0400 (número gratuito)	questions.CO@support.sonyericsson.com
Danmark	3331 2828	questions.DK@support.sonyericsson.com
Deutschland	0180 534 2020 (ortsübliche Gebühren)	questions.DE@support.sonyericsson.com
Dominica	1-800-085-9518 (Toll Free)	questions.CO@support.sonyericsson.com
Ecuador	1-800-0102-50 (número gratuito)	questions.CO@support.sonyericsson.com
Eesti	06 032 032	questions.EE@support.sonyericsson.com
Egypt/مصر	16727	questions.EG@support.sonyericsson.com
Ελλάδα	801 11 810 810 +30 210 899 19 19 (από κινητό τηλέφωνο)	questions.GR@support.sonyericsson.com
El Salvador	800-6323 (número gratuito)	questions.CO@support.sonyericsson.com
España	902 180 576 (tarifa local)	questions.ES@support.sonyericsson.com
France	09 69 32 21 21 09 69 32 21 22 (Xperia™ uniquement)	questions.FR@support.sonyericsson.com
Guatemala	1-800-300-0057 (número gratuito)	questions.CO@support.sonyericsson.com
Haiti/Ayiti	AN 193, PIN 5598 (número gratuit / nimewo gratis)	questions.CO@support.sonyericsson.com
Honduras	AN 8000122, PIN 5599 (número gratuito)	questions.CO@support.sonyericsson.com
Hong Kong/香港	+852 8203 8863	questions.HK@support.sonyericsson.com
Hrvatska	062 000 000	questions.HR@support.sonyericsson.com
India/भारत	1800 11 1800 (Toll Free)	questions.IN@support.sonyericsson.com

17

	+91 (011) 39011111	
Indonesia	021 2701388	questions.ID@support.sonyericsson.com
Ireland	1850 545 888 (Local rate)	questions.IE@support.sonyericsson.com
Italia	06 48895206 (tariffa locale)	questions.IT@support.sonyericsson.com
Jamaica	1-800-442-3471 (Toll Free)	questions.CO@support.sonyericsson.com
Κύπρος/Κίβρις	0800 90 909	questions.CY@support.sonyericsson.com
Latvija	67 21 43 01	questions.LV@support.sonyericsson.com
Lietuva	8 700 55030	questions.LT@support.sonyericsson.com
Magyarország	01 880 47 47	questions.HU@support.sonyericsson.com
Malaysia	1800-88-9900 (Toll Free / bebas tol)	questions.MY@support.sonyericsson.com
Maroc/المغرب	+212 2 2958 344	questions.MA@support.sonyericsson.com
México	0 1800 000 4722 (número gratuito)	questions.MX@support.sonyericsson.com
Nederland	0800 8998318	questions.NL@support.sonyericsson.com
Nederlandse Antillen	001-866-509-8660 (gratis nummer)	questions.CO@support.sonyericsson.com
New Zealand	0800-100-150 (Toll Free)	questions.NZ@support.sonyericsson.com
Nicaragua	AN 1800-0166, PIN 5600 (número gratuito)	questions.CO@support.sonyericsson.com
Norge	815 00 840 (lokaltakst)	questions.NO@support.sonyericsson.com
Österreich	0810 200 245	questions.AT@support.sonyericsson.com
Pakistan/پاکستان	021 - 111 22 55 73	questions.PK@support.sonyericsson.com
Panamá	00800-787-0009 (número gratuito)	questions.CO@support.sonyericsson.com
Paraguay	009 800 54 20032 (número gratuito)	questions.CO@support.sonyericsson.com

18

Other product and company names mentioned herein may be the trademarks of their respective owners. Any rights not expressly granted herein are reserved.

Perú	0800-532-38 (número gratuito)	questions.CO@support.sonyericsson.com
Philippines/Pilipinas	+63 2 7891860	questions.PH@support.sonyericsson.com
Polska	+48 22 22 77 444	questions.PL@support.sonyericsson.com
Portugal	808 204 466 (chamada local)	questions.PT@support.sonyericsson.com
República Dominicana	1-800-751-3370 (número gratuito)	questions.CO@support.sonyericsson.com
România	+40 21 401 0401	questions.RO@support.sonyericsson.com
Saint Kitts and Nevis	1-800-087-9518 (Toll Free)	questions.CO@support.sonyericsson.com
Saint Vincent and the Grenadines	1-800-088-9518 (Toll Free)	questions.CO@support.sonyericsson.com
Schweiz/Suisse/Svizzera	0848 824 040	questions.CH@support.sonyericsson.com
Singapore	+65 6744 0733	questions.SG@support.sonyericsson.com
Slovenia	01 600 5000	questions.SI@support.sonyericsson.com
Slovensko	02 5443 6443	questions.SK@support.sonyericsson.com
South Africa	0861 632222 (+82) 1588 4170	questions.ZA@support.sonyericsson.com
South Korea/대한민국		
Suomi	09 299 2000	questions.FI@support.sonyericsson.com
Sverige	013 24 45 00 (lokal taxa)	questions.SE@support.sonyericsson.com
Trinidad and Tobago	1-800-080-9521 (Toll Free)	questions.CO@support.sonyericsson.com
Türkiye	+90 212 473 77 77	questions.TR@support.sonyericsson.com
United Kingdom	08705 237 237 (Local rate)	questions.GB@support.sonyericsson.com
United States	1 866 766 9374	questions.US@support.sonyericsson.com
Uruguay	000-401-787-013 (número gratuito)	questions.CO@support.sonyericsson.com
Venezuela	0-800-1-00-2250 (número gratuito)	questions.CO@support.sonyericsson.com

19

Viet Nam	1900 1525 (miễn phí)	questions.VN@support.sonyericsson.com
Беларусь	8 82 00 361 0001	questions.BY@support.sonyericsson.com
България	0800 1 8778	questions.BG@support.sonyericsson.com
Россия	+7 (495) 7870986	questions.RU@support.sonyericsson.com
Україна	(+380) 44 590 1515	questions.UA@support.sonyericsson.com
الأردن	+971 4 3919 880	questions.JO@support.sonyericsson.com
الإمارات العربية المتحدة (UAE)	+971 4 3919 880	questions.AE@support.sonyericsson.com
الكويت	+971 4 3919 880	questions.KW@support.sonyericsson.com
المملكة العربية السعودية	800-8200-727	questions.SA@support.sonyericsson.com
中国	+86 400 810 0000	questions.CN@support.sonyericsson.com
台灣	+886 2 25625511	questions.TW@support.sonyericsson.com
ไทย	02 2483 030	questions.TH@support.sonyericsson.com

20