

Sony Ericsson W300i

Contents

Getting Started	4	Connectivity	46
Assembly, SIM card, battery, turning on, startup menu.		Internet and email settings, synchronizing, Bluetooth, infrared, USB cable, update service.	
Getting to know your phone	9	More features	52
Phone overview, icons, menu overview, entering letters, file manager.		Alarm clock, calendar, tasks, profiles, time and date, SIM card lock, etc.	
Calling	18	Troubleshooting	57
Calls, contacts, voice control, call options.		Why doesn't the phone work the way I want?	
Messaging	30	Important information	59
Text messaging, picture messaging, voice messaging, email, My Friends.		Sony Ericsson Consumer Web site, service and support, safe and efficient use, warranty, declaration of conformity.	
Imaging	35	Index	71
Camera, video recorder, pictures.			
Entertainment	38		
Walkman®, radio, PlayNow™, ringtones, MusicDJ™, VideoDJ™, games and more.			

Sony Ericsson

GSM 850/900/1800/1900

This user guide is published by Sony Ericsson, without any warranty. Improvements and changes to this user guide necessitated by typographical errors, inaccuracies of current information, or improvements to programs and/or equipment, may be made by Sony Ericsson at any time and without notice. Such changes will, however, be incorporated into new editions of this user guide.

All rights reserved.

©Sony Ericsson Mobile Communications AB, 2005

Publication number: AE/LZT 123 xxxx PA1

Please note: Some of the services in this user guide are not supported by all networks. This also applies to the GSM International Emergency Number 112.

Please contact your network operator or service provider if you are in doubt whether you can use a particular service or not.

Please read the Guidelines for safe and efficient use and the Limited warranty chapters before you use your mobile phone.

Your mobile phone has the capability to download, store and forward additional content, e.g. ringtones. The use of such content may be restricted or prohibited by rights of third parties, including but not limited to restriction under applicable copyright laws.

You, and not Sony Ericsson, are entirely responsible for additional content that you download to or forward from your mobile phone. Prior to your use of any additional content, please verify that your intended use is properly licensed or is otherwise authorized. Sony Ericsson does not guarantee the accuracy, integrity or quality of any additional content or any other third party content. Under no circumstances will Sony Ericsson be liable in any way for your improper use of additional content or other third party content. QuickShare™, PlayNow™, MusicDJ™, PhotoDJ™ and VideoDJ™ are trademarks or registered trademarks of Sony Ericsson Mobile Communications AB.

The Bluetooth word mark and logos are owned by the Bluetooth SIG, Inc. and any use of such marks by Sony Ericsson is under license.

Memory Stick™ and Memory Stick Micro™ and M2 are trademarks or registered trademarks of Sony Corporation.

The Walkman® logo and symbol are registered trademarks of Sony Corporation.

Microsoft, Windows and PowerPoint are either registered trademarks or trademarks of Microsoft Corporation in the U.S and other countries/regions.

Mac OS is a trademark of Apple Computer, Inc., registered in the U.S. and other countries.

T9™ Text Input is a trademark or a registered trademark of Tegic Communications.

T9™ Text Input is licensed under one or more of the following: U.S. Pat. Nos. 5,818,437, 5,953,541, 5,187,480, 5,945,928, and 6,011,554; Canadian Pat. No. 1,331,057, United Kingdom Pat. No. 2238414B; Hong Kong Standard Pat. No. HK0940329; Republic of Singapore Pat. No. 51383; Euro.Pat. No. 0 842 463(96927260.8) DE/DK, FI, FR, IT, NL, PT, ES, SE, GB; and additional patents are pending worldwide.

Java and all Java based trademarks and logos are trademarks or registered trademarks of Sun Microsystems, Inc. in the U.S. and other countries. End-user license agreement for Sun™ Java™ JME™ .

- 1** Restrictions: Software is confidential copyrighted information of Sun and title to all copies is retained by Sun and/or its licensors. Customer shall not modify, decompile, disassemble, decrypt, extract, or otherwise reverse engineer Software. Software may not be leased, assigned, or sublicensed, in whole or in part.
- 2** Export Regulations: Software, including technical data, is subject to U.S. export control laws, including the U.S. Export Administration Act and its associated regulations, and may be subject to export or import regulations in other countries. Customer agrees to comply strictly with all such regulations and acknowledges that it has the

responsibility to obtain licenses to export, re-export, or import Software. Software may not be downloaded, or otherwise exported or re-exported (i) into, or to a national or resident of, Cuba, Iraq, Iran, North Korea, Libya, Sudan, Syria (as such listing may be revised from time to time) or any country to which the U.S. has embargoed goods; or (ii) to anyone on the U.S. Treasury Department's list of Specially Designated Nations or the U.S. Commerce Department's Table of Denial Orders.

- 3** Restricted Rights: Use, duplication or disclosure by the United States government is subject to the restrictions as set forth in the Rights in Technical Data and Computer Software Clauses in DFARS 252.227-7013(c) (1) (ii) and FAR 52.227-19(c) (2) as applicable.

Part of the software in this product is copyright © SyncML initiative Ltd. (1999-2002). All rights reserved.

Other product and company names mentioned herein may be the trademarks of their respective owners. Any rights not expressly granted herein are reserved.

Getting Started

Assembly, SIM card, battery, turning on, startup menu.

User guide symbols

The following instruction symbols appear in this user guide:

- ▶ Use the navigation key to scroll and select
➡ *10 Navigating the menus.*

- ⊙ Press the navigation key center.

- ⊙ Press the navigation key up.

- ⊙ Press the navigation key down.

- ⊙ Press the navigation key to the left.

- ⊙ Press the navigation key to the right.

- ➡ See also page ...

- 💡 Note



Indicates that a service or function is network- or subscription-dependent. Because of this, all menus may not be available in your phone. Consult your network operator for more information.

Assembly

First insert the SIM card, then insert and charge the battery to use your phone.



Save contacts to your SIM card before you remove it from another phone. Contacts may have been saved in the phone memory ➡ 19 Contacts.

SIM card

When you register as a subscriber with a network operator, you get a SIM (Subscriber Identity Module) card. The SIM card contains a computer chip that keeps track of your phone number, the services included in your subscription, and names and numbers in your contacts, among other things.

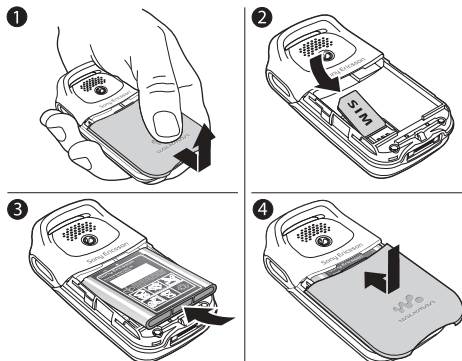
To insert the SIM card

- 1 Slide the cover open and lift it off.
- 2 Insert the SIM card. Make sure the SIM card is placed under the silvery holders.
- 3 Place the battery in the phone with the label side up and the connectors facing each other.
- 4 Place the cover on the phone and slide it into place.

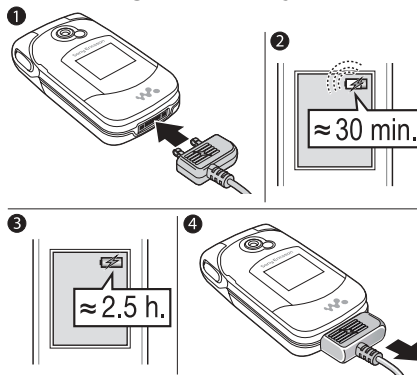
To charge the battery

- 1 Connect the charger to the phone. The flash symbol on the charger plug must face upwards.
- 2 It may take 30 minutes for the battery icon to appear.
- 3 Wait approximately 2.5 hours or until the battery icon indicates that the battery is fully charged. For an indication of charging, press \ominus to activate the screen.
- 4 Remove the charger by pulling it out.

Getting Started

 *Talk-time or standby time may become noticeably shorter due to wear and you may have to replace your battery. Only use approved batteries from Sony Ericsson*
➡ 63 Battery.

Memory Stick Micro™ (M2™)

Use a memory card to store, for example, pictures. If you use a memory card you can select to automatically store all pictures on the card
➡ 35 Camera options.

 *The Memory Stick Micro™ (M2™) media is generally compatible with the Memory Stick™ reader contained in this handset. The M2™ media may not be compatible with all other devices or all features of other devices with Memory Stick™ capabilities. Operation of the M2™ media on any other product is not guaranteed.*

To insert and remove the memory card

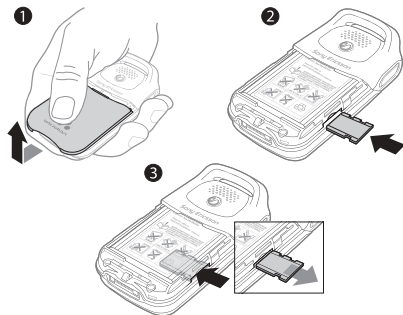

- 1 Slide the cover to open and lift it off.
- 2 Insert the memory card in the slot.
- 3 Press the edge of the memory card to release it from the slot.

PIN

You may need a PIN (Personal Identification Number) from your network operator to activate the services in your phone. Each PIN digit appears as *, unless it starts with emergency number digits, for example 112 or 911. The reason for this is to always let you make emergency calls without entering a PIN. ➔ *19 Emergency calls*. Press **C** to correct mistakes.

 *If you enter the wrong PIN three times in a row, the SIM card is blocked ➔ 55 SIM card lock.*

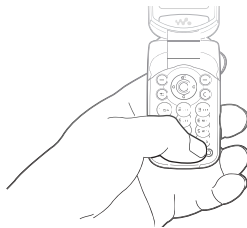
To turn the phone on and off

- 1** Press and hold **Ⓢ** to turn on or off.
- 2** Select whether you want to use the phone with all functionality or the Walkman® player only ➔ *8 Startup menu*.
- 3** Enter your SIM card PIN, if you have one.
- 4** At first start-up, select the language for phone menus.
- 5** ▶ **Yes** if you want the setup wizard to help you with instructions and tips or ▶ **No**.
The setup wizard is also available in the menu system, ▶ **Settings ▶ General ▶ Setup Wizard**.

Getting Started

Startup menu

When the startup menu is activated, each time you turn on the phone, you can select to listen to music only, instead of using the phone with full functionality. This means all transmitters of the phone are turned off, preventing disturbance of sensitive equipment, for example, in an airplane or in a hospital. You cannot make calls, receive calls, or send messages, etc. You can only use the Walkman® player. If you have selected **Music Only**, you can still receive calendar and task reminders, and the alarm can still signal.

 *Always follow regulations and any flight crew instructions with respect to onboard use of electronic devices.*

To deactivate the startup menu

- ▶ Settings ▶ the General ▶ Startup Menu.
- Select Don't Show.

To make and receive calls

Enter the area code and phone number ▶ Call to make the call. ▶ End Call to end the call. When the phone rings ▶ Answer to answer the call. For more information ➡ 18 Making and receiving calls.

Stereo Handsfree Headset

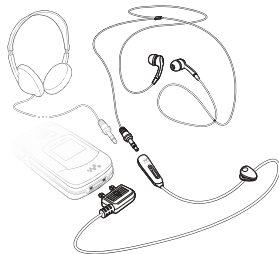

 *You can still answer calls and use the microphone when other compatible accessories are in use.*

Getting to know your phone

Phone overview, icons, menu overview, entering letters, file manager.

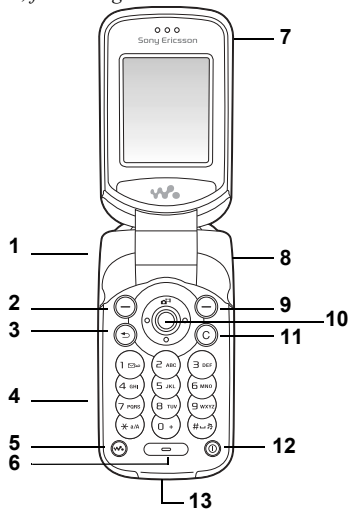

- 1 Play/Pause and Volume Key
- 2 Left Selection Key
- 3 Back Key
- 4 Memory card
- 5 Walkman® key
- 6 Microphone
- 7 Earpiece
- 8 Infrared Port
- 9 Right Selection Key
- 10 Navigation Key (quick camera access)
- 11 Clear Key
- 12 Power On/Off Key
- 13 Charger/USB Connection

Getting to know your phone

Navigating the menus

The main menus are shown as icons on the desktop. Some submenus include tabs that appear on the screen.

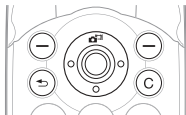

- Press the navigation key in the center or in a direction:
Press to go to the desktop or to select items.
Press , , or to move through menus and tabs.
- Press to go back one level in the menus or to end a function or application.
Press and hold to return to standby.
- Press to select the options shown immediately above these keys on the screen.
- Press to delete items.
- Scroll to a menu item ► **Info** to get help on selected features.
- ► **More** to enter a list of options.

Keys and Buttons

	Press to delete items, such as pictures, sounds and contacts. During a call, press and hold to mute the microphone.
	Press to open or minimize the Walkman player.
	Press to activate the camera.
	Press and hold to call your voicemail service (if set).
	Press and hold any of these keys to reach a contact beginning with a specific letter. Press multiple keys to quickly jump to that specific contact.
	Press any of these keys and press Call to speed dial.



Press to increase the volume during a call, or when using the Walkman player.

Press and hold to go forward or back one track.

In standby, press to view status information.

Quickly press twice to reject a call.

Press once to turn off the ringtone when receiving a call.

Press and hold to voice dial, alternatively say your magic word (if set).



Press and hold to set the phone to silent. The alarm signals even if the phone is set to silent.

Press once to turn off the ringtone when receiving a call.

► Info

Get more information, explanations or tips about selected features, menus or functions available in your phone. Scroll to a menu item
► Info.

► More

Enter a list of options. There are different alternatives in the list of options depending on where you are in the menus.

Getting to know your phone

Menu overview

 **PlayNow™***

 **Internet Services***

 **Entertainment**

- Online services*
- Games
- VideoDJ™
- PhotoDJ™
- MusicDJ™
- Remote Control
- Record Sound
- Demo Tour

 **Camera**

 **Messaging**

- Write New
- Inbox
- My Friends*
- Email
- Call Voicemail
- Drafts
- Outbox
- Sent Messages
- Saved Messages
- Templates
- Settings

 **WALKMAN**

 **File Manager*****

- All Files
- In Phone
- On Memory Stick

 **Contacts****

- Options:**
- Speed Dial
- My Business Card
- Groups
- SIM Contacts
- Special Numbers
- Advanced
- New Contact**

 **Radio**

Calls***

- All
- Answered
- Dialed
- Missed

Organizer

- Alarms
- Calendar
- Tasks
- Notes
- Calculator
- Synchronization
- Timer
- Stopwatch
- Applications
- Code Memo

Settings

General

- Profiles
- Time & Date
- Language
- Update Service
- Voice Control
- Shortcuts
- Play/
Pause Button
- Startup Menu
- Locks
- Setup Wizard
- Tips and Tricks
- Phone Status
- Master Reset

Sounds & Alerts

- Ring Volume
- Ringtone
- Silent mode
- Increasing Ring
- Vibrating Alert
- Open Phone Snds
- Message Alert
- Key Sound

Display

- Wallpaper
- Themes
- Startup Screen
- Screen Saver
- Brightness
- Sleep Mode Clock
- Edit Line Names*

Calls

- Forward Calls
- Switch to Line 2*
- Manage Calls
- Time & Cost
- Show/Hide My No.
- Open to Answer
- Handsfree

Connectivity

- Bluetooth
- Infrared Port
- USB Connection
- Synchronization
- Device Mgmt.
- Mobile Networks
- Data Comm.
- Internet Settings
- Streaming Settings
- Settings for Java™
- Accessories













* Some menus are operator-, network- and subscription-dependent.

** Options when phone contacts are set to default, options change when SIM contacts are set to default.

*** Use the navigation key to move across tabs in submenus.

Getting to know your phone

Status bar icons

Icon	Description
	Tells you the strength of the GSM network signal.
	GPRS network is within range and can be used.
	EDGE network is within range and can be used.
	Tells you the status of the battery.
	Tells you the status of the battery charging.
	You have missed an incoming call.
	You have received a voice message.
	Call and messaging function alerts are off, alarm is still on.
	You have received a text message.
	You have received an email message.
	You have received a picture message.
	You have an ongoing call.

 You have an appointment reminder.







 You have a task reminder.

 The magic word is activated.





Shortcuts

You can use keypad shortcuts to quickly go to a menu, and you can use predefined navigation key shortcuts to quickly reach certain functions. You can edit the navigation key shortcuts to suit your own needs.

Using keypad shortcuts

Enter the menus by pressing  and then enter the number of the menu to which you want to go. For example, to reach the fifth menu item, press . To reach the tenth, eleventh and twelfth menu items, press ,  and  respectively. To go back to standby, press and hold .

Using navigation key shortcuts

In standby, press , ,  or  to go to a shortcuts menu, or directly to a function.

To edit a navigation key shortcut

► **Settings** ► **General** ► **Shortcuts** and select which shortcut you want to edit ► **Edit**.

Shut down menu

Use the shut down menu to shut down the phone, turn on silent or activate a profile. For more information about profiles ➔ *52 Profiles*.

To open the shut down menu

Press  and select an option from the list.

File manager

Files such as pictures, videos, sounds, themes, games and applications are saved in folders in the phone memory. If you have a memory card inserted you can save the files on the memory card. Unrecognized files are saved in the **Other** folder.

File manager menu tabs

The file manager is divided into three tabs, and icons indicate where the files are saved.

- **All Files** – all content in the phone and on the memory card.
- **In Phone** – all content in the phone memory.
- **On Memory Stick** – all content on the memory card.

File information

If a file is protected, you may not be able to copy or send the file. View file information by highlighting the file ► **More** ► **Information**.

To move or copy a file

- 1 ► **File Manager**. Select a folder and scroll to a file ► **More** ► **Manage Files**.
- 2 Select **Move** or **Copy**.
- 3 ► **Memory Stick** or ► **Phone Memory**.
- 4 Select a folder, or ► **New Folder** name the folder ► **OK**.
- 5 ► **Paste**.

To select several files

- 1 ► **File Manager** and select a file ► **More** ► **Mark**.
- 2 ► **Mark Several** or ► **Mark All**. To select files, scroll and ► **Mark** or ► **Unmark**.

To check memory status

► **File Manager** ► **More** ► **Memory Status**.

Formatting the memory card

You can format a memory card if you want to delete all information from it, or if it has been corrupted.

Getting to know your phone

To format the memory card

- ▶ File Manager ▶ More ▶ Format M.S. ▶ Yes and enter your phone lock code. For more information
- ➡ 55 Phone lock.

Transferring files

For more information ➡ 50 Transferring files.

Languages

Select the language for phone menus and for writing.

To change the phone language

- ▶ Settings ▶ General ▶ Language
 - ▶ Phone Language, select a language.
- From standby, Press \odot 0000 \odot for English, or press \odot 8888 \odot for Automatic language.

To select writing languages

- ▶ Settings ▶ General ▶ Language
 - ▶ Writing Language.
- 2 Scroll and ▶ Mark to select languages. ▶ Save.

Entering letters

To enter letters using multitap text input

- Press \odot – \odot until the desired character appears.
- Press \odot to shift between capitals and lower case letters.
- Press and hold \odot – \odot to enter numbers.
- Press \odot to delete letters and numbers.
- Press \odot to add a space.
- Press \odot for the most common punctuation marks.
- Press and hold \odot to change writing method.

T9™ Text Input

The T9™ Text Input method uses a built-in dictionary to recognize the most commonly used word for each sequence of key presses. This way, you press each key only once, even if the letter you want is not the first letter on the key.

To enter letters using T9 Text Input

- 1 Scroll to a function where text input is possible, for example, ► **Messaging** ► **Write New** ► **Text Message**.
- 2 For example, if you want to write the word “Jane”, press (5), (2), (6), (3).
- 3 If the word shown is not the one you want, press Ⓢ or Ⓣ repeatedly to view alternative words. To accept a word and add a space, press (#→). To accept a word without adding a space, press Ⓢ.
- 4 Continue writing your message. To enter a period or other punctuation marks, press (1) and then Ⓢ or Ⓣ repeatedly. Accept and add a space by pressing (#→).

To add words to the T9 Text Input dictionary

- 1 While entering letters ► **More** ► **Spell Word**.
- 2 Edit the word by using multitap input. Navigate between the letters with Ⓢ and Ⓣ. To delete a character, press (C). To delete the entire word, press and hold (C).

- 3 When you have edited the word ► **Insert**. The word is added to the T9 Text Input dictionary. Next time you enter this word using T9 Text Input, it will appear as one of the alternative words.

To select another writing method

Before, or while entering letters, press and hold (*A/A) to select another writing method.

Options when entering letters

- **More** to view options when entering letters.

Calling

Calls, contacts, voice control, call options.

Making and receiving calls

Turn on the phone and make sure that you are within range of a network to make and receive calls

➡ **7 To turn the phone on and off.** If your subscription includes the Calling Line Identification service and the caller's number is identified, the number is displayed. If the number is saved in **Contacts**, the name, number, and picture are displayed. If the number is a restricted number, **Withheld** is displayed.

To make a call

Enter the phone number (with international country code and area code, if applicable) ▶ **Call** to make the call. ▶ **End Call** to end the call.

To redial a number

If the connection failed, **Retry?** is displayed ▶ **Yes**.



*Do not hold the phone to your ear while waiting.
When a call connects, the phone gives a loud signal.*

To answer or reject a call

Open your phone or ▶ **Answer** if your phone is already open.

To reject a call

Close your phone, ▶ **Busy** or quickly press twice on the volume button.

To select more options during a call

▶ **More** and select an option.

To turn off the microphone

Press and hold **(C)**. To resume, press and hold **(C)** again.

To use the loudspeaker during a voice call

▶ **More** ▶ **Turn On Speaker** or ▶ **Turn Off Speaker**.

Call list

Information about the last calls is saved in the call list.

To call a number from the call list

▶ **Calls** from standby and select a tab. Scroll to a name or number you want to call ▶ **Call**.

To add a call list number to contacts

- ▶ Calls from standby and select a tab. Scroll to the number you want to add ▶ **More**
▶ **Save Number**.
- Select a contact to add the number to or
▶ **New Contact**.

Emergency calls

Your phone supports the international emergency numbers, for example, 112 and 911. These numbers can normally be used to make an emergency call in any country, with or without a SIM card inserted, if a GSM network is in range.



In some countries, other emergency numbers may also be promoted. Your network operator may have saved additional local emergency numbers on the SIM card.

To make an emergency call

Enter, for example, 112 ▶ **Call**.

To view your local emergency numbers

- ▶ **Contacts** ▶ **Options** ▶ **Special Numbers**
- ▶ **Emergency Nos.**

Contacts

Choose **Phone Contacts** for detailed information saved in the phone memory or **SIM Contacts** for names and numbers only on the SIM card.

To select default contacts

- ▶ **Contacts** ▶ **Options** ▶ **Advanced**
▶ **Default Contacts**.
- Select **Phone Contacts** or **SIM Contacts**.

To add a contact

- ▶ **Contacts** ▶ **New Contact** ▶ **Add**.
- Select **Name:** ▶ **Add** enter the name ▶ **OK**.
- Select **New Number:** ▶ **Add** enter the number ▶ **OK**.
- For phone contacts only, select a number type. Scroll between tabs and select fields to enter more information. To enter symbols such as @
▶ **More** ▶ **Add Symbol** and select the symbol
▶ **Insert**. To save the contact, ▶ **Save**.



Enter the + sign and country code with all numbers.

Calling

To add a picture or a ringtone to a contact

- 1 ▶ **Contacts** and select the contact ▶ **More** ▶ **Edit Contact**.
- 2 Select the relevant tab, then select **Picture** or **Ringtone** ▶ **Add**. Select a file and ▶ **Save**.

To set the default number for a contact

To set the phone number to be displayed first for a contact, ▶ **Contacts** and scroll to the contact ▶ **More** ▶ **Default Number** and select a number.



To add your own business card

▶ **Contacts** ▶ **Options** ▶ **My Business Card** and enter the information for your business card ▶ **Save**.

To send your business card

▶ **Contacts** ▶ **Options** ▶ **My Business Card** ▶ **Send My Card**.

To call a phone contact

▶ **Contacts**. Scroll to, or enter the first letters of the contact you want to call. Use  or  to select a number ▶ **Call**.

To call a SIM contact

- If **SIM Contacts** is default, ▶ **Contacts** select the name and number from the list ▶ **Call**.
- If **Phone Contacts** is default, ▶ **Contacts** ▶ **Options** ▶ **SIM Contacts** select the name and number from the list ▶ **Call**.

Managing contacts

Copy contacts to and from the phone memory and the SIM card.

To copy names and numbers to the SIM card

- 1 ▶ **Contacts** ▶ **Options** ▶ **Advanced** ▶ **Copy to SIM**.
- 2 Select **Copy All** or **Copy a Number**.



When copying all contacts from the phone to the SIM card, all existing SIM card information is replaced.

To copy SIM contacts to phone contacts

- 1 ▶ **Contacts** ▶ **Options** ▶ **Advanced** ▶ **Copy from SIM**.
- 2 Select **Copy All** or **Copy a Number**.

To automatically save to the SIM card

- ▶ Contacts ▶ Options ▶ Advanced
▶ Auto Save on SIM.
- Select On.

To back up contacts on memory card

- ▶ Contacts ▶ Options ▶ Advanced
- ▶ Back Up To M.S. ▶ Yes.

To restore contacts from memory card

- ▶ Contacts ▶ Options ▶ Advanced
- ▶ Restore From M.S. ▶ Yes ▶ Yes.

To send contacts

- To send a selected contact, ▶ More
▶ Send Contact and select a transfer method.
- To send all contacts, ▶ Contacts ▶ Options
▶ Advanced ▶ Send All Contacts.

To edit a phone contact

- ▶ Contacts and select a contact ▶ More
▶ Edit Contact.
- Select a tab and edit the information ▶ Save.

To edit a SIM contact

- If SIM Contacts is default, ▶ Contacts or if Phone Contacts is default, ▶ Contacts
▶ Options ▶ SIM Contacts.
- Select the name and number you want to edit.
- ▶ More ▶ Edit Contact and edit the name and number.

To delete contacts

- To delete a selected contact, press .
- To delete all contacts, ▶ Contacts ▶ Options
▶ Advanced ▶ Delete All Contacts ▶ Yes and
▶ Yes. Names and numbers on the SIM card are not deleted.

To check the memory status

- ▶ Contacts ▶ Options ▶ Advanced
- ▶ Memory Status.



The number of entries you can save in the phone or on the SIM card depends on the available memory.

Synchronizing contacts

For more information, ➡ 47 Synchronizing.

Calling

Speed dialing

Save phone numbers that you want to reach easily in positions 1-9 in your phone.

To set or replace speed dialing numbers

- 1 ▶ **Contacts** ▶ **Options** ▶ **Speed Dial**.
- 2 Scroll to a position ▶ **Add** or **Replace** and select a phone number.

To speed dial

From standby, enter a speed dial number (1-9) ▶ **Call**.

Groups

Create a group of numbers and email addresses to send messages to several recipients at the same time. You can also use groups (with numbers) when you create accepted callers lists.

To create a group of numbers and email addresses

- 1 ▶ **Contacts** ▶ **Options** ▶ **Groups** ▶ **New Group** ▶ **Add**.
- 2 Enter a name for the group ▶ **Continue**.
- 3 **New** ▶ **Add** to find and select a contact number.
- 4 Repeat step 3 to add more numbers. ▶ **Done**.

Voicemail

If your subscription includes an answering service, callers can leave a voice message when you cannot answer a call.

To enter your voicemail number

Press and hold **1** ▶ **Yes** enter the number ▶ **OK**. You get the number from your service provider.

To call your voicemail service

If you have entered your voicemail number, press and hold **1**.

To check your voicemail number

▶ **Messaging** ▶ **Settings** ▶ **Voicemail Number**.

Voice control



Manage calls with your voice by creating voice commands to:

- Voice dial – call someone by saying the name.
- Activate voice control by saying a “magic word”.
- Answer and reject calls when using a handsfree.

Before voice dialing

Activate the voice dialing function and record your voice commands. An icon appears next to a phone number that has a voice command.

To activate voice dialing and record names

- 1 ▶ Settings ▶ General ▶ Voice Control
▶ Voice Dialing ▶ Activate ▶ Yes
▶ New Voice Cmd. and select a contact.
- 2 If the contact has more than one number, use  and  to view the numbers. Select the number to add the voice command to. Record a voice command such as “John mobile”.
- 3 Instructions appear. Wait for the tone and say the command that you want to record. The voice command is played back to you.
- 4 If the recording sounds ok ▶ Yes. If not ▶ No and repeat step 3.

To record another voice command for a contact
▶ New Voice Cmd. ▶ Add again and repeat steps 2-4 above.

Voice dialing tips

Follow these tips for recording voice commands. If your phone cannot detect your voice command, try re-recording by:

- recording the command in a quiet environment, with minimal background noise.
- speaking loudly and clearly.
- holding the phone away from your face.

Caller name

Hear your recorded contact name when you receive a call from that contact.

To turn the caller name on or off

- ▶ Settings ▶ General ▶ Voice Control
▶ Play Caller Name.

Voice dialing

Start voice dialing from standby using the phone, a portable handsfree, a Bluetooth headset or by saying your magic word.

Calling

To make a call

- 1 From standby, press and hold one of the volume buttons.
- 2 Wait for the tone and say a recorded name, for example “John mobile”. The name is played back to you and the call is connected.

To make a call with a handsfree

From standby, press and hold the handsfree button, or press the Bluetooth headset button ➡ 49 *To add a Bluetooth headset.*

The magic word

Record and use a voice command as a magic word to activate voice control without pressing any keys. The magic word can only be used with a handsfree.

 *Choose a long, unusual word or phrase that can easily be distinguished from ordinary background speech.*

To activate and record the magic word

- 1 ▶ **Settings** ▶ **General** ▶ **Voice Control** ▶ **Magic Word** ▶ **Activate.**
- 2 Instructions appear. ▶ **Continue.** Wait for the tone and say the magic word.

- 3 ▶ **Yes** to accept or ▶ **No** for a new recording.
- 4 Instructions appear. ▶ **Continue** and select the environments in which you want your magic word to be activated.

Voice answering

Answer or reject incoming calls by using your voice, when using a handsfree.

 *You can only use a MIDI, WAV (16 kHz), EMY or IMY file as a ringtone with voice answering.*

To activate voice answering and record voice answer commands

- 1 ▶ **Settings** ▶ **General** ▶ **Voice Control** ▶ **Voice Answer** ▶ **Activate.**
- 2 Instructions appear. ▶ **Continue.** Wait for the tone and say “Answer”, or another word.
- 3 ▶ **Yes** to accept or ▶ **No** for a new recording.
- 4 Instructions appear ▶ **Continue.** Wait for the tone and say “Busy”, or another word.
- 5 ▶ **Yes** to accept or ▶ **No** for a new recording.
- 6 Instructions appear. ▶ **Continue** and select the environments in which you want voice answering to be activated.

To answer or reject a call using voice commands

When the phone rings, say:

- “Answer” to connect the call or
- “Busy” to reject the call.

To edit your voice commands

- ▶ **Contacts** select the contact ▶ **More**
- ▶ **Edit Contact**. Scroll to the relevant tab.

To re-record a voice command

- ▶ **Settings** ▶ **General** ▶ **Voice Control**
▶ **Voice Dialing** ▶ **Edit Names**.
- Select a command ▶ **More** ▶ **Replace Voice**.
- Wait for the tone and say the command.

**Forwarding calls**

Forward calls, for example, to an answering service.



When the Restrict calls function is activated, some Forward calls options are not available.

To activate a call forward

- ▶ **Settings** ▶ **Calls** ▶ **Forward Calls**.
- Select a call type and forward option ▶ **Activate**.
- Enter the phone number to forward your calls to ▶ **OK**, or ▶ **Look up** to select a contact.

To deactivate a call forward

Scroll to the forward option ▶ **Deactivate**.

To check all forward options

▶ **Settings** ▶ **Calls** ▶ **Forward Calls** ▶ **Check All**.

**More than one call**

Handle more than one call simultaneously.

Call waiting service

When activated, you hear a beep if you receive a second call.

To activate the call waiting service

▶ **Settings** ▶ **Calls** ▶ **Manage Calls** ▶ **Call Waiting**
▶ **Activate**.

To make a second call

▶ **More** ▶ **Hold** to hold the ongoing call. Enter the number you want to call ▶ **Call**.

Receiving a second call

When you receive a second call, you can:

- ▶ **Answer** and put the ongoing call on hold.
- ▶ **Busy** to reject and continue the ongoing call.
- ▶ **Replace Active Call** to answer and to end the ongoing call.

Calling

Handling two calls

If you have an ongoing call and a call on hold, you can:

- ▶ **More ▶ Switch** to switch between the two calls.
- ▶ **More ▶ Join Calls** to join the two calls.
- ▶ **More ▶ Transfer Call**, to connect the two calls.

You are disconnected from both calls.



Contact your network operator to check if this function is supported.

- ▶ **End Call ▶ Yes** to retrieve the held call.
- ▶ **End Call ▶ No** to end both calls (operator dependent).

You cannot answer a third call without ending one of the first two calls or joining them into a conference call.



Conference calls

Start a conference call by joining an ongoing call and a call on hold. Put the conference on hold to call and add up to five participants or just to make another call.

To join the two calls into a conference call

- ▶ **More ▶ Join Calls**.

To add a new participant

- ▶ **More ▶ Hold** to put the joined calls on hold.
- ▶ **More ▶ Add Call** and call the next person.
- ▶ **More ▶ Join Calls**.
- Repeat the procedure to include more participants.

To release a participant

- ▶ **More ▶ Release Party** and select the participant.

To have a private conversation

- ▶ **More ▶ Talk to** and select the participant.
- ▶ **More ▶ Join Calls** to resume the conference call.



Two voice lines

Make separate calls with different phone numbers if your subscription supports alternate line service.

To select a line

- ▶ **Settings ▶ Calls** and select line 1 or 2.

To change the name of a line

- ▶ **Settings ▶ Display ▶ Edit Line Names** and select one of the lines to edit the name.
- ▶ **Join Calls** to resume the conference call.



Two voice lines

If you have a subscription that supports an alternate line service, your phone may have two voice lines with different phone numbers.

To select a line for outgoing calls

▶ Settings ▶ Calls and select line 1 or 2.

To change the name of a line

▶ Settings ▶ Display ▶ Edit Line Names and select one of the lines to edit the name.

My numbers

View, add and edit your own phone numbers.

To check your phone numbers

▶ Contacts ▶ Options ▶ Special Numbers
▶ My Numbers and select one of the options.

Accept calls

With the accept calls service, you can choose to receive calls only from certain phone numbers. Other calls are automatically rejected by a busy tone. If the call forward option **When Busy** is activated, calls are forwarded instead of rejected by a busy tone. The phone numbers of calls you have rejected are saved in the call list.

To add numbers to the accepted callers list

- ▶ Settings ▶ Calls ▶ Manage Calls
▶ Accept Calls ▶ Only from List ▶ Edit ▶ Add.
Select a contact.
- To add a group of contacts to the accepted callers list ▶ Groups (requires that you have created groups, ➔ 22 Groups).

To accept all calls

▶ Settings ▶ Calls ▶ Manage Calls
▶ Accept Calls ▶ All Callers.



Restricted dialing

You can use the restrict calls service to restrict outgoing and incoming calls. You need a password which you get from your service provider.



If you forward incoming calls, you cannot activate some Restrict calls options.

The following calls can be restricted:

- **All Outgoing** – All outgoing calls.
- **Outgoing Intl.** – All outgoing international calls.
- **Outgoing Intl Roam** – All outgoing international calls except to your home country.
- **All Incoming** – All incoming calls.
- **Inc. When Roaming** – All incoming calls when you are abroad (when roaming).

Calling

To activate or deactivate a call restriction

- 1 ▶ Settings ▶ Calls ▶ Manage Calls ▶ Restrict Calls and select an option.
- 2 Select **Activate** or **Deactivate**, enter your password ▶ **OK**.



Fixed dialing

The fixed dialing function allows calls to be made only to certain numbers saved on the SIM card. The fixed numbers are protected by your PIN2.



You can still call the international emergency numbers even when the fixed dialing function is activated.

Partial numbers can be saved. For example, saving 0123456 allows calls to be made to all numbers starting with 0123456.



When fixed dialing is activated, you cannot view or manage any phone numbers that are saved on the SIM card.

To activate or deactivate fixed dialing

- 1 ▶ Contacts ▶ Options ▶ Special Numbers ▶ Fixed Dialing and select **Activate** or **Deactivate**.
- 2 Enter your PIN2 ▶ **OK** and then ▶ **OK** again to confirm.

To save a fixed number

- ▶ Contacts ▶ Options ▶ Special Numbers ▶ Fixed Dialing ▶ Fixed Numbers ▶ New Number: and enter the information.

Call time

During a call, the duration of the call is shown on the screen. Check the duration of your last call, outgoing calls and the total time.

To check the call time

- ▶ Settings ▶ Calls ▶ Time & Cost ▶ Call Timers.

Closed user groups

If your network supports closed user groups, you may be able to call at lower costs. You can save up to ten groups. An index number is required from your network operator.

To add a group

- ▶ Settings ▶ Calls ▶ Manage Calls ▶ Closed Groups ▶ Edit List ▶ New Group ▶ Add. Enter the name of the user group ▶ Continue. Enter the index number ▶ Save.

To call outside a closed user group

- ▶ Settings ▶ Calls ▶ Manage Calls ▶ Closed Groups
- ▶ Open Calls ▶ On. To only call within the group
- ▶ Off.

Tone signals

Use telephone banking services or control an answering machine by sending tone signals during a call.

- To send the tones, press **[0+] - [9]**, **[*]/A** or **[#]-B**.
- To clear the screen after the call is finished, press **[C]**.
- To turn the tones on or off during a call, ▶ **More** and select **Disable Tones** or **Enable Tones**.

Notepad

Note down a phone number during a call. When you end the call, the number remains on the screen to call or save.

**Showing or hiding your number**

If your subscription supports the Calling Line Identification Restriction, you can hide your phone number when making a call.

To always show or hide your phone number

- 1 ▶ Settings ▶ Calls ▶ Show/Hide My No.
- 2 Select **Show Number**, **Hide Number** or **Network Default**.



Messaging

Text messaging, picture messaging, voice messaging, email, My Friends.



Your phone supports various messaging services. Contact your service provider about the services you can use, or for more information see www.sonyericsson.com/support.



If you send a message to a group, you are charged for each member of that group.



If there is no memory available, you must delete messages or emails before you can receive new ones ➔ 31 Long messages.

Text messaging (SMS)

Text messages can contain simple pictures, animations, melodies and sound effects.

Before you start

A service center number is provided by your network operator to send and receive text messages. It may already be saved on the SIM card or you can add the number yourself.

To set the service center number

- 1 ▶ **Messaging** ▶ **Settings** ▶ **Text Message** ▶ **Service Center**. The number is shown if it is saved on the SIM card.
- 2 If there is no number ▶ **New ServiceCenter** and enter the number, including the international “+” sign and country code ▶ **Save**.

To write and send a text message

- 1 ▶ **Messaging** ▶ **Write New** ▶ **Text Message**.
- 2 Write your message. To insert an item in your message, ▶ **More** ▶ **Add Item**.
- 3 ▶ **Continue**. (To save the message for later, press  and ▶ **Yes** to save in **Drafts**.)
- 4 Select **Enter Phone No.** to enter the recipient's number, or **Contacts Lookup** to retrieve a number or group from **Contacts**. You can also select from the last used recipients list.
- 5 To change the default options for your message, for example request a read report, ▶ **More** ▶ **Advanced** select an option ▶ **Edit** and select a setting ▶ **Done** ▶ **Send**.



*You can convert your text message to a picture message. While writing ▶ **More** ▶ **To Picture Msg**.*

To check the delivery status of a sent message

- ▶ **Messaging** ▶ **Sent Messages** and select a message
- ▶ **View** ▶ **More** ▶ **Details**.

To call a number in a message

- Select the phone number displayed in the message,
- ▶ **Call**.

To save an item in a text message

- 1** While reading a message, select the item ▶ **More**.
- 2** Select **Use** (the phone number you have selected appears) to save a phone number, or **Save Picture** to save a picture, or **Save Bookmark** to save a Web address.

To save messages

- To save a selected message, ▶ **More**
 - ▶ **Save Message** ▶ **Saved Messages** (SIM card) or ▶ **Templates** (phone).
- To save several messages in a folder, select a message ▶ **More** ▶ **Mark Several**. Scroll and
 - ▶ **Mark** to select messages. ▶ **More**
 - ▶ **Save Messages**.

To delete messages

- To delete a selected message, press **(C)**.
- To delete several messages in a folder, select a message ▶ **More** select **Delete all Msgs** or **Mark Several**. When marking several messages, scroll and ▶ **Mark** to select messages. ▶ **More**
 - ▶ **Delete Messages**.

Long messages

The number of characters allowed in a text message depends the writing language. You can send a longer message by linking two or more messages. You are charged for each of the messages linked in a long message. You may not receive all parts of a long message at the same time.



Check with your service provider for the maximum number of messages that can be linked.

To turn on long messages

- ▶ **Messaging** ▶ **Settings** ▶ **Text Message**
- ▶ **Max. Msg. Length** ▶ **Max. Available**.

Messaging

Picture messaging (MMS)

Picture messages can contain text, pictures, video clips, camera pictures, sound recordings, and signatures. They are sent via MMS (Multimedia Messaging Service) to a mobile phone or via email.



Sending and receiving phones must have subscriptions that support picture messaging.

Before you start

If settings are not already in your phone
➡ 46 Settings.

Creating and sending picture messages

Select to write text and add pictures, sounds, videos, more pages, a signature and attachments.

To create and send a picture message

- 1 ▶ Messaging ▶ Write New ▶ Picture Msg.
- 2 ▶ More to add an item to the message. When writing, ▶ OK ▶ More to insert an item.
- 3 ▶ More to add more items to the message.

When you are ready to send, continue as when sending a text message ➡ 30 To write and send a text message.



You have the same options for picture messages as for text messages ➡ 30 Text messaging (SMS).

To create your own signature for picture messages

- 1 ▶ Messaging ▶ Settings ▶ Picture Message.
- 2 ▶ Signature ▶ New Signature and create your signature as a picture message.

To save an item in a picture message

- 1 While reading a message, select the item ▶ More.
- 2 Select Use to save a phone number, or Save Bookmark to save a Web address, or Save Items to save, for example, a picture or sound.

Automatic download

Select how to download your picture messages.

- ▶ Messaging ▶ Settings ▶ Picture Message
▶ Auto Download to select one of the following:
- Always – automatically download messages.
 - Ask in roaming – ask to download other network messages.

- **Not in Roaming** – do not download other network messages.
- **Always Ask** – ask to download messages.
- **Off** – new messages appear in the inbox as icons. Select the message ► **View** to download.

Voice messages

Send and receive a sound recording as a voice message.



Sending and receiving phones must have subscriptions that support picture messaging.

To record and send a voice message

- 1 ► **Messaging** ► **Write New** ► **Voice Message**.
- 2 Record your message ► **Stop**.
- 3 ► **Send** to send the message.
- 4 Select **Enter Email Addr.** to enter an email address, or **Enter Phone No.** to enter the recipient's number, or **Contacts Lookup** to retrieve a number or group from Contacts, or select from the last used recipients list. ► **Send**.

Email

Connect to a POP3 or IMAP4 mail server to send and receive email messages with your phone. You can use the same email settings in your phone as in your computer email program.



With a POP3 email account, messages are downloaded to each computer or device used for access. With an IMAP4 email account, messages can be kept on the server.

Before you start

If settings are not already in your phone

► **46 Settings**.

To write and send an email message

- 1 ► **Messaging** ► **Email** ► **Write New**.
- 2 ► **Add** to enter the **To:** field. Select **Enter Email Addr.** to enter an email address, or **Contacts Lookup** to find an address in Contacts. You can also select from the last used recipients list.
- 3 To add more recipients, select **To**, **Cc** or **Bcc**.
- 4 When finished selecting recipients ► **Done**.
- 5 Write the subject ► **OK**. Write the text ► **OK**.

Messaging

- To add an attachment, ► **Add** and select the attachment ► **Done**.
- **Continue**. Select **Send** or **More** to view options.

To receive and read email messages

- **Messaging** ► **Email** ► **Inbox**.
- If the inbox is empty ► **Send&Rec**. If the inbox not is empty ► **More** ► **Send & Receive**.
- Select a message ► **View** to read it.

To reply to an email message

- Open the email message ► **Reply**.
- Select **Write New** or **Include Message**.
- Write your message ► **OK** ► **Continue** ► **Send**.

To save an item or attachment in an email message

- To save an email address, a phone number or a Web address, select the item ► **More** and select to save the item.
- To save an attachment, select the message ► **More** ► **Attachments**. Select the attachment ► **More** and select an option.

To delete email messages

- To delete a selected message, press **C**.
- To delete several messages in a folder, select a message ► **More** ► **Mark Several**. Scroll and ► **Mark** to select messages. ► **More** ► **Delete Messages**. The marked messages are deleted the next time you connect to your email server.



*For IMAP4 users, ► **More** ► **Clear Inbox** and select **With Send & Rec.** or **No Send & Rec.** to delete messages the next time you connect to the server.*

My friends

For more information, contact your service provider or see www.sonyericsson.com/support.

Imaging

Camera, video recorder, pictures.

Camera and video recorder

Your phone has a digital camera which also works as a digital video recorder. Take pictures and record video clips to save, send or use. Use a picture as a screen saver, wallpaper or for a contact.

To take pictures and record video clips

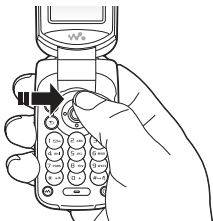

- 1 Press from standby to start the camera.
- 2 Press or to switch between video and photo.
- 3 ▶ **Capture** to take a picture
▶ **Record** to start a video recording.

If you try to record a strong light source such as direct sunlight or a lamp, the screen may black out or the picture may be distorted.

To use the zoom

Press and to zoom in and zoom out.

Zoom is not possible when picture size is set to Large (1280x1024).

To adjust brightness

Use the volume button to increase or decrease brightness.

Camera options

When the camera is activated ▶ **More** to view options:

- **View All Clips** (video).
- **Shoot Mode** (video) – select **For Picture Msg** or **High-Quality Video**.
- **Video Size** – select **Large 176x144** or **Small 128x96**.
- **Night Mode** – enhance picture or video quality in poor lighting conditions with longer exposure time.
- **Effects** – select different effects for your picture or video.
- **View All Pictures** (pictures).

Imaging

- **Shoot Mode** (pictures) – select **Normal** for no frame, **Panorama** to combine a few pictures into one wide picture, **Frames** to add a frame to your picture, or **Burst** to take a few pictures in rapid succession.
- **Picture Size** – select **Large 640x480**, **Medium 320x240**, **Small 160x120** or **Extended** (for a digitally enlarged picture).
- **Self-Timer** (pictures) – the picture is taken a few seconds after you press the camera button.
- **Picture Quality** – select **Normal** or **Fine** picture quality.
- **Shutter Sound** (pictures) – select different shutter sounds.
- **Reset File Number** (pictures) – reset the file number counter for pictures stored on the memory card.
- **Save to** – select **Memory Stick** or **Phone Memory**.

Saving and sending pictures and video clips

When you have taken a picture or recorded a video clip, it is saved in the phone memory or on the memory card. You can send the picture or video clip instantly in a picture message. To exchange pictures and video clips using other transfer methods
➡ *37 Exchanging pictures and video clips.*

Pictures and video clips

Your phone comes with one or more pictures and video clips, which you can delete to free memory. All pictures and videos are saved in **File Manager**. You can use a picture as a screen saver, wallpaper, or for a phone contact ➡ *20 To add a picture or a ringtone to a contact.* You can send and receive pictures and video clips using a transfer method. The number of pictures or video clips that you can save depends on the size of the files. There is support for GIF, JPEG, WBMP, BMP, PNG, SVG-Tiny, MP4 and 3GP.



Animations are handled like pictures.

To view your pictures and video clips

- 1 ▶ **File Manager** and select **Pictures** or **Videos**. Pictures are shown in thumbnail.
- 2 Select a picture or video clip ▶ **View**.
- 3 For video clips, ▶ **Play** to start the video clip.

To search camera pictures by time line

- 1 ▶ **File Manager** ▶ **Pictures** ▶ **Camera Pictures**.
- 2 ▶ **More** ▶ **Time Line Search**. Now you can browse the camera pictures, sorted by date in a time line.

Exchanging pictures and video clips

Exchange pictures and video clips with friends using one of the available transfer methods. You may not be allowed to exchange copyright-protected material.

You can also transfer pictures and video clips to a computer ➡ *50 Transferring files*.

To send a picture or video clip

- 1 ▶ File Manager and select Pictures or Videos.
- 2 Select a picture or video clip ▶ More ▶ Send.
Select a transfer method.

To receive and save a picture or video clip

- From a message containing the file,
➡ *30 Messaging*.
- Via another transfer method, make sure the transfer method is activated and follow the instructions that appear.

Screen saver and wallpaper

The screen saver activates automatically when the phone is idle for a few seconds. After a few more seconds sleep mode activates, to save power. If you have a picture as wallpaper, this picture is shown in standby mode.

To use a picture

- 1 ▶ File Manager ▶ Pictures and select a picture.
- 2 ▶ More ▶ Use As and select an option.

PhotoDJ™ and VideoDJ™

Visit www.sonyericsson.com/support for information on how to use PhotoDJ and VideoDJ in your phone.

Entertainment

Walkman®, radio, *PlayNow™*, ringtones, *MusicDJ™*, *VideoDJ™*, games and more.

Walkman® player

Play music and video clips that you download or receive in a picture message or transfer from your computer. The following file types are supported: MP3, MP4, 3GP, AAC, AMR, MIDI, IMY, EMY and WAV (16 kHz maximum sample rate). You can also use streamed files that are 3GPP compatible.



AMR and MIDI files are only visible and possible to play with the Walkman player if they are DRM-protected. You can, however, listen to other AMR and MIDI files using the file manager.

Install, transfer and play music

Your phone works with the Disc2Phone computer software, included on the CD that comes with the phone. Use Disc2Phone to transfer music from CDs or your computer. This way the music files are transferred in an automatic Artist-Album-Title order. Follow the procedures below to start using the Walkman player.

To install the USB drivers

- 1 Turn on your computer and insert the CD that came with your phone into the CD drive of your computer. If the PC Suite installation window opens, simply close it as it is not needed here.
- 2 Turn on your phone and connect the USB cable to a USB port on the computer and to the phone. The “Found New Hardware Wizards” starts on the computer.
- 3 **Computer:** Click *Install the software automatically* and click *Next*.
- 4 The wizard should find the USB software drivers automatically. Click *Finish*.
- 5 Repeat steps 3 and 4 until all five drivers are installed.

To install Disc2Phone

- 1 Turn on your computer and insert the CD that came with your phone into the CD drive of your computer. The CD starts automatically and the installation window opens.
- 2 **Computer:** Select a language and click *OK*.
- 3 **Computer:** Click *Install Disc2Phone* and follow the instructions on the screen. When the installation is complete, the Disc2Phone icon appears on the desktop of your computer.

To transfer music

- 1 Make sure your phone is turned on and connected to the computer with the USB cable.
- 2 **Computer:** Double-click the Disc2Phone icon on the computer desktop to open Disc2Phone.
- 3 **Computer:** For details on transferring music, please refer to Disc2Phone Help. Click  in the top right corner of Disc2Phone window.
- 4 **Computer:** You can obtain CD information (artist, track, etc.) via Disc2Phone if you are connected to the Internet while extracting music from a CD. You must also complete registration before you start.



You cannot view the transferred files in your phone until you have removed the USB cable from the phone.









Music and video clips

Play music and video clips saved in your phone. Information such as artist and songtitle will show in the external display when the phone is closed.



To play music and videos

- 1 ▶ **WALKMAN** or . The Walkman player opens.
- 2 Browse for songs by artist or track, or in playlists. You can also browse for video clips. Select a list ▶ **Open**.
- 3 Highlight a title ▶ **Play**.

Walkman player controls

- Press  to open the Walkman player or to minimize the Walkman player during playback.
- Press  to pause the playback. Press again to resume playing.
- Press  to go forward to the next music track or video clip.
- Press  to go back to the previous music track or video clip.
- Press and hold  or  to fast forward or rewind when playing music tracks or video clips.
- Press  or  to scroll through the playlist during playback. Files that are highlighted will not be selected until you press **Play**.
- When a video clip is playing, press  to play the video in slow motion. To resume normal playback, ▶ **Play**.

Entertainment

- When a video clip is paused, press  to play the video one frame at a time.
- Press  to go to the Walkman player when in the **Now Playing** view.
- Press and hold  to exit the Walkman player when in the **Now Playing** view.

Play/pause button

Press  to start or pause music. Choose between using this button for the Walkman player or the Radio, or the most recently used of these.

To change the play/pause button setting

► Settings ► General ► Play/Pause Button

Browsing files

In the Walkman player, you can browse for music and video content in lists:

- **Artists** – lists of all available artists.
- **Tracks** – lists all music files (not ringtones) in your phone.
- **Playlists** – create or play your own lists of sound files.
- **Videos** – lists all video clips in your phone.

Playlists

To organize the media files that are stored in the **File Manager**, you can create playlists. Files in a playlist can be sorted by artist, title or by the order in which the files were added to the playlist. You can add a file to more than one playlist.

When you delete a playlist or a file from the playlist, it is not deleted permanently from the phone memory. You can add the file to another playlist.

To create a playlist

- 1 ► WALKMAN ► Playlists ► New Playlist ► Add enter the name of the playlist ► OK.
- 2 Select among the files that are available in the **File Manager**. You can add several files at a time and you can also add folders. All music files in the selected folders will be added to the playlist.

To add files to a playlist

- 1 ► WALKMAN ► Playlists select a playlist ► Open ► More ► Add Media.
- 2 Select among the files that are available in the **File Manager**.

To remove files from a playlist

- 1 ▶ **WALKMAN** ▶ **Playlists** select a playlist
 - ▶ **Open**.
- 2 Select the file and press **(C)**.

To delete playlists

- ▶ **WALKMAN** ▶ **Playlists** select a playlist and press **(C)**.

Walkman player options

- ▶ **More** for options:
- **Now Playing** – go to the **Now Playing** view.
 - **Add Media** – add files or folders to the playlist.
 - **Sort** – sort the playlist by artist, title or by the order in which files were added to the playlist.
 - **Delete** – remove a file from the playlist. In playlists you have created, the file is only removed from the playlist. In the **Tracks** list, the file is permanently deleted from the memory.
 - **Rename** – rename the playlist. You can only rename user-created playlists.
 - **Delete Playlist** – delete the playlist. Only the playlist is deleted; the files are still listed in the **File Manager**. You can only delete user-created playlists.

- **Information** – view information about the current track or video.
- **Play Mode** – change the playback order of songs and videos. Select **Shuffle** to play the playlist files in random order, or **Loop** to restart the playlist when the last file has been played.
- **Equalizer** – change settings for treble and bass when playing music in the Walkman player.
- **Send** – send a sound or video clip.
- **Capture Frame** – when a video clip is paused, capture a picture from the video clip.

Online music and videos

View videos and listen to music by streaming them to your phone from the Internet. If settings are not already in your phone ➡ *46 Settings*. For more information, contact your network operator or visit www.sonyericsson.com/support.

To select a data account for streaming

- ▶ **Settings** ▶ **Connectivity** ▶ **Streaming Settings** and select the data account to use.

Entertainment

To stream video and audio

- 1 ▶ **Internet Services** ▶ **More** ▶ **Enter Address**.
- 2 Enter or choose the address to a Web page and select a link to stream from. The Walkman player opens automatically when a link is selected.

To stream saved music and videos

- 1 ▶ **Internet Services** ▶ **More** ▶ **Bookmarks**.
- 2 Select a link to stream. The Walkman player opens and plays the music or video.





Radio

Listen to FM radio with RDS (Radio Data System) functionality. You must connect the handsfree to your phone as it works as an antenna. The radio can also be used as an alarm signal ➡ *52 Alarm clock*.

To listen to the radio

Connect the handsfree to your phone ▶ **Radio**.



Radio control

- **Radio** ▶ **Search** to find a broadcasting frequency.
- Press  or  to move 0.1 MHz.
- Press  or  to select preset channels.
- ▶ **More** to view options.



Saving radio channels

Save up to 20 preset channels.

To save radio channels

▶ **Radio** set frequency ▶ **More** ▶ **Save** or press and hold  -  to save in positions 1 to 10.

To select radio channels

Use the navigation key or press  -  to select a saved channel in positions 1 to 10.

Radio options

▶ **More** for the following options:

- **Turn Off** – turn off the radio.
- **Minimize** – return to standby to use other functions while listening.
- **Save** – save the current frequency in a position.
- **Channels** – select, rename, replace or delete a preset channel.
- **Turn On Speaker** – use the loudspeakers.
- **Auto Save** – save tuned channels in positions 1 to 20. Previously saved channels are replaced.
- **Set Frequency** – enter a frequency manually. Press  to go directly to **Set Frequency**.
- **RDS** – set options for alternative frequency (AF) and station information.
- **Turn On Mono** – turn on mono sound.

PlayNow™

Listen to music before you purchase and download to your phone.



This function is network- or operator-dependent. Contact your network operator for information about your subscription and PlayNow™. In some countries you may be able to purchase music tones from some of the world's top musical artists.



This service is not available in all countries.

Before you start

If settings are not in your phone ➔ 46 Settings.

To listen to PlayNow™ music

► PlayNow™ and select music from a list.

Downloading from PlayNow™

The total price appears when you select to download and save a music file. Your phone bill or prepay card is debited when a purchase is accepted. Terms and conditions are also provided in the phone kit.

To download a music file

- 1 When you have listened to a music file and agreed to accept the conditions ► Yes to download.
- 2 A text message is sent out to confirm payment and the file is made available to download. Music is saved in File Manager ► Sounds.

Ringtones, melodies, sounds and alerts

Your phone comes with melodies that can be used as ringtones. You can exchange melodies by selecting a transfer method. A sound file that cannot be set as a ringtone is not supported or prohibited. You may not be allowed to exchange copyright-protected material.

To select a ringtone



► Settings ► Sounds & Alerts ► Ringtone.

To turn the ringtone on or off

Press and hold  from standby. All signals except the alarm signal are turned on or off.

Entertainment

To set the ringtone volume

► Settings ► Sounds & Alerts ► Ring Volume and press  or  to decrease or increase ► Save.

To set the vibrating alert

- 1 ► Settings ► Sounds & Alerts ► Vibrating Alert.
- 2 Set this alert to On, On if in Silent or Off.

To set sounds and alerts options





► Settings ► Sounds & Alerts, you can set:

- **Message Alert** – select message notification.
- **Key Sound** – select the key press sound.

Composing ringtone melodies

Compose and edit melodies to use as ringtones using the MusicDJ™.

To compose a melody

► Entertainment ► MusicDJ™ Choose to Insert, Copy and Paste blocks to compose. Use , ,  or  to move between the blocks. Press  to delete a block. ► More to view more options.

To edit a previously created melody

► File Manager ► Sounds and select a melody
► More ► Edit.

To send and receive a melody

► File Manager ► Sounds and select a melody.
► More ► Send and select a transfer method. When you receive the melody, follow the instructions that appear.



You cannot send a polyphonic melody or an MP3 file in a text message.

Sound recorder

Record your own memos or calls which can be set as ringtones.





In some countries or states it is required by law that you inform the other person before recording the call.

To start a sound recording

► Entertainment ► Record Sound.

To listen to your recordings

- 1 ► File Manager ► Sounds and select a recording.
- 2 ► Play to listen to the recording. Press  and  to go to the previous or next recording. ► Stop to stop playback. ► More to view options.

Themes, games and applications

Your phone comes with predefined themes, games and applications. You can download new content to your phone. For more information, see www.sonyericsson.com/support.

To set a theme

► File Manager ► Themes, select a theme ► Set.

To send a theme

► File Manager ► Themes, select a theme ► More
► Send. Select a transfer method.

To receive and save a theme

When you receive the theme, follow the instructions that appear.

To start and end a game

► Entertainment ► Games, select a game ► Select.
Press and hold  to end the game.

To start and end an application

► File Manager ► Applications, select an application
► Select. Press and hold  to end the application.



Unrecognized formats are saved in the Other folder.

To download a theme

► File Manager ► Themes and scroll to a direct link ► Go To.

If settings are not already in your phone
➡ 46 Settings.

To download a game

► Entertainment ► Games and scroll to a direct link ► Go To.

If settings are not already in your phone
➡ 46 Settings.

To download an application

► Internet Services ► More ► Go to ► Bookmarks
and scroll to a direct link ► Go To.

If settings are not already in your phone
➡ 46 Settings.

Connectivity

Internet and email settings, synchronizing, Bluetooth, infrared, USB cable, update service.

Settings

 *Before you start using the Internet, Messaging, My Friends or PlayNow™, settings are required in your phone.*

Settings may already be entered when you buy your phone. If not, contact your network operator, service provider or visit www.sonyericsson.com/support for more information.

In order to use the Internet, and send and receive picture and email messages, you need the following:

- A phone subscription that supports data transmission.
- Settings entered in your phone.
- You may also have to register as an Internet and email user with your service provider or network operator.

Entering settings

If the settings are not already entered in your phone, you can:

- Receive settings in a message from your network operator, service provider or visit www.sonyericsson.com/support.
- Enter or edit settings yourself.

Using Internet

Browse the Internet using HTTP (Hyper Text Transfer Protocol).

To select an Internet profile

- ▶ **Settings** ▶ **Connectivity** ▶ **Internet Settings**
- ▶ **Internet Profiles** and select a profile to use.

To start browsing

- ▶ **Internet Services**, select a service or ▶ **More** for options.

To stop browsing

- ▶ **More** ▶ **Exit Browser**.

Options when browsing

- ▶ **More** to view options. The menu contains the following options but it may depend on the Web page you are visiting.

 *If you select an email address when browsing a Web page, you can send a message to that address.*

► **Go To** for options:

- **Sony Ericsson** – go to the pre-defined homepage.
- **Bookmarks** – create, use or edit bookmarks.
- **Enter Address** – enter the address to a Web page.
- **History** – list of previously visited Web pages.

► **Tools** for options:

- **Add Bookmark** – add a new bookmark.
- **Save Picture** – save a picture.
- **Save Page** – save the current Web page.
- **Refresh Page** – refresh the current Web page.
- **Send Link** – send a link to the current Web page.
- **Make a Call** – make a call while browsing. ► **More**
► **End Call** to end the call and continue browsing.

► **View** for options:

- **Full Screen** – select normal or full screen.
- **Text Only** – select full content or text only.
- **Zoom** – zoom in or out on the Web page.
► **Zoom to Normal** – set zoom to default.
- **Advanced** to enter settings for the browser.
- **Exit Browser** to disconnect and go to standby.

To work with bookmarks

- **Internet Services** ► **More** ► **Go To** ► **Bookmarks** and select a bookmark ► **More**. Select an option.

Internet security

Secure browsing is supported. When using an Internet profile you can turn on security in the phone.

Trusted certificates

Certain Internet services, such as banking, require certificates in your phone. Your phone may already contain certificates when you buy it, or you can download new certificates.

To check the certificates in your phone

- **Settings** ► **Connectivity** ► **Internet Settings**
► **Security** ► **TrustedCertificates**.

Synchronizing

Synchronize contacts, appointments, tasks and notes via Bluetooth, the infrared port, Internet services or a USB cable.

Visit www.sonyericsson.com/support to download the software or Getting started guides for synchronization.

Connectivity

Synchronization with nearby devices

Install the computer synchronization by downloading it from www.sonyericsson.com/support. The software includes help information.

Remote synchronization via Internet

Synchronize online via an Internet service.

To enter the remote synchronization settings

- ▶ Organizer ▶ Synchronization and ▶ Yes or New Account. Enter a name for the new account ▶ Continue.
- Enter the following settings:
 - **Server Address** – server URL.
 - **Username** – account username.
 - **Password** – account password.
 - **Connection** – select an Internet profile.
 - **Applications** – mark applications to synchronize.
 - **App. Settings** – select an application and enter a database name, and if required, username and password.
 - **Sync. Interval** – set how often to synchronize.

- **Remote Initiation** – select to always accept, never accept or always ask when starting from a service.
- **Remote Security** – enter server ID and password.

- 3 ▶ Save to save your new account.

To start the remote synchronization

- ▶ Organizer ▶ Synchronization, select an account
▶ Start.

Bluetooth™ wireless technology

Bluetooth makes it possible to connect wirelessly to other Bluetooth devices. You can:

- connect to several devices at the same time.
- synchronize information with other devices.
- use the remote control functionality.
- use a remote screen.
- exchange items and play multiplayer games.



The recommended maximum distance between two Bluetooth devices is 33 feet (10 meters), with no solid objects in between.

Before you start

- Turn on Bluetooth to communicate with other devices.
- Pair your phone with the Bluetooth devices that you want to communicate with.

 Please check if local laws or regulations restrict the use of Bluetooth. If Bluetooth is not allowed, you must ensure that the Bluetooth function is turned off. The maximum allowed Bluetooth radio output power in the phone may be configured according to possible local restrictions. This means that the maximum distance may vary.

To turn on Bluetooth in your phone

▶ Settings ▶ Connectivity ▶ Bluetooth ▶ Turn On.

To show or hide your phone

▶ Settings ▶ Connectivity ▶ Bluetooth ▶ Visibility
▶ Show Phone or Hide Phone.

 If set to hide, other devices will not be able to discover your phone via Bluetooth.

To add a device to your phone

▶ Settings ▶ Connectivity ▶ Bluetooth ▶ My Devices
▶ New Device to search for available devices. Select a device from the list. Enter a passcode (provided with the headset), if required.

To save power

▶ Settings ▶ Connectivity ▶ Bluetooth ▶ Powersave ▶ On.

 This reduces power consumption when using a single Bluetooth device. Turn it off when using several Bluetooth devices.

To add a Bluetooth headset

1 ▶ Settings ▶ Connectivity ▶ Bluetooth
▶ Handsfree.

2 ▶ Yes if you are adding a Bluetooth handsfree for the first time or ▶ My Handsfree
▶ New Handsfree ▶ Add if you are adding another Bluetooth handsfree. Ensure that your handsfree is prepared to be added.

Infrared port

The infrared port in your phone can be used to exchange information with another device equipped with infrared.

To turn on the infrared port in your phone

▶ Settings ▶ Connectivity ▶ Infrared Port ▶ On or
▶ 10 Minutes to turn on for 10 minutes.

Connectivity

To connect two devices

Turn on infrared in both devices. Make sure the infrared port on your phone is facing the infrared port on the other device with a maximum distance of 8 inches (20 cm).

USB cable

Use a USB cable and exchange information between your phone and a computer.

To start a USB connection

Turn on your phone and connect the USB cable to your phone and computer:

- **File Transfer** to browse files on the memory card and on the phone memory. The phone will turn off in this mode.
- **Phone Mode** to synchronize information with other devices or use the phone as a modem. The phone will remain on in this mode.

 *Do not remove the USB cable from the phone or computer during file transfer as this may corrupt the memory card and the phone memory.*

To end a USB connection

- When in **File Transfer** mode, exit the USB connection on your computer by right-clicking on the Removable disk icon in Windows Explorer and select Eject. Then remove the USB cable from your phone and computer.
- When in **Phone Mode**, remove the USB cable from your phone and computer.

Transferring files

You can transfer pictures, videos, sounds, and themes by using one of the following transfer methods:

- Bluetooth ➡ [48 Bluetooth™ wireless technology](#)
- Infrared ➡ [49 Infrared port](#)
- USB cable ➡ [50 USB cable](#)

 *You can also send files via email ➡ [33 Email or picture messages](#) ➡ [32 Picture messaging \(MMS\)](#).*

To transfer files using Bluetooth or infrared

- 1 Select a file to transfer.
- 2 ▶ **More** ▶ **Send** and select **Via Bluetooth** or **Via Infrared**.

To transfer files using the USB cable

- 1 Prepare your phone for file transfer
 ▶ 50 To start a USB connection.
- 2 Use drag-and-drop functionality in your computer to transfer files between your phone and the computer.
- 3 End USB connection ▶ 50 To end a USB connection.

Update service

Download and install new software without affecting the user data in your phone. Update your phone over the air via your phone or online via USB cable and an Internet-connected computer.



The Update service requires data access (GPRS). Your operator will provide you with a subscription with data access and with price information.

To use Update service over the air

- 1 ▶ Settings ▶ General ▶ Update Service.
- 2 ▶ Search For Update to search for the latest available software. Start the update process by following the installation instructions, or ▶ Software Version to display the current software installed in your mobile phone, or ▶ Reminder to set when to search for new software.

To use Update service online

- 1 Visit www.sonyericsson.com/support.
- 2 Select a region and country.
- 3 Enter the product name.
- 4 Select Sony Ericsson Update Service and follow the instructions that appear.

More features

Alarm clock, calendar, tasks, profiles, time and date, SIM card lock, etc.

Time and date

Time and date are always displayed in standby.

To set the time and date

► **Settings** ► **General** ► **Time & Date**:

- To set time and time format, ► **Time** enter the time ► **Format** select a format ► **Save**.
- To set date and date format, ► **Date** enter the date ► **Format** select a format ► **Save**.
- To edit time zone, ► **Time Zone** select an option.
- To set daylight saving on or off, ► **Daylight Saving** select an option.
- To set auto time zone, ► **Auto Time Zone** select and option.

Alarm clock

The alarm rings even if the phone is set to silent or turned off.

To set and use an alarm

► **Organizer** ► **Alarms** and select an option:

- To set an alarm, ► **Alarm** set a time ► **Save**.
- To set a recurrent alarm, ► **Recurrent Alarm** set a time ► **Continue** select days **Mark** ► **Done**.
- To select a signal, ► **Alarm Signal** select a sound.
- To turn the alarm signal off when it rings, press any key.
- To cancel an alarm, ► **Organizer** ► **Alarm** or ► **Recurrent Alarm** ► **Turn Off**.

Profiles

Your phone has predefined profiles that are set to suit a certain environment. You can reset all profile settings to the way they were set when you bought your phone.

To use profiles



► **Settings** ► **General** ► **Profiles**:

- Select a profile to use.
- To view and edit a profile, ► **More** ► **View And Edit**.
- To reset profiles, ► **More** ► **Reset Profiles**.



You can also activate a profile from the shut down menu ► 15 Shut down menu.

Brightness

Adjust the brightness of the screen. ▶ **Settings**
▶ **Display** ▶ **Brightness** and press  or  to set
brightness level ▶ **Save**.

Calendar

Add, save, edit and set reminders for appointments.
Synchronize the calendar with a web calendar
or a computer calendar. ➡ 47 *Synchronizing*.

To add a new appointment

▶ **Organizer** ▶ **Calendar** select a date
▶ **New Appointment**. ▶ **Add**. Enter details
▶ **Continue** to confirm each entry. ▶ **Select**
to confirm the appointment.

To view an appointment

▶ **Organizer** ▶ **Calendar** and select a day.
Select an appointment ▶ **View**.

To view a calendar week

▶ **Organizer** ▶ **Calendar** ▶ **More** ▶ **View Week**.

To set reminders options

- ▶ **Organizer** ▶ **Calendar** ▶ **More** ▶ **Advanced**
▶ **Reminders**.
- Select an option. Select **Always** for a reminder
to sound even though the phone is turned off or
set to silent.



*A reminder option set in the calendar affects
a reminder option set in tasks.*

Navigating in your calendar

Use the navigation key to move between days
or weeks.

Calendar settings

▶ **Organizer** ▶ **Calendar** ▶ **More** and select an
option:

- **View Week** – view appointments of the week.
- **New Appointment** – add a new appointment.
- **Change Date** – go to another date in the calendar.
- **Advanced** – for options to find and set reminders
or select a start day for the week.
- **Delete** – delete appointments.
- **Help** – view help text for more calendar
information.

More features

To send an appointment

► **Organizer** ► **Calendar** and select an appointment for a certain day ► **More** ► **Send** and select a transfer method.

Tasks

Add new tasks or use existing tasks as templates. You can also set reminders for tasks.

To add a new task

► **Organizer** ► **Tasks** ► **New Task** ► **Add**. Select **Task** or **Phone Call**. Enter details and confirm each entry.

To view a task

► **Organizer** ► **Tasks** and select a task ► **View**.

To set reminders

- **Organizer** ► **Tasks** and select a task ► **More** ► **Reminders**.
- Follow step 2 and 3 ➔ 53 *To set reminders options*.



A reminder option set in tasks affects a reminder option set in the calendar.

To send a task

► **Organizer** ► **Tasks** and select a task for a certain day ► **More** ► **Send** and select a transfer method.

Notes

Make notes and save them in a list. You can also show a note in standby.

To add a note

► **Organizer** ► **Notes** ► **New Note** ► **Add** and enter the note ► **Save**.

To edit notes

► **Organizer** ► **Notes** select a note ► **More** and edit the note ► **Save**.

To send a note

► **Organizer** ► **Notes** ► and select a note ► **More** ► **Send** and select a transfer method.

Calculator

Use the calculator to add, subtract, divide and multiply.

► **Organizer** ► **Calculator**:

- To select \div \times $+$ $-$ $\%$ $=$, press \odot or \odot .
- To delete a figure, press C .

SIM card lock

The SIM card lock protects your subscription from unauthorized use. Most SIM cards are locked at the time of purchase. If the SIM card lock is on, you have to enter a PIN (Personal Identity Number) every time you turn on your phone. If you enter your PIN incorrectly three times in a row, the SIM card is blocked and the message **PIN Blocked** is displayed. To unblock it, you need to enter your PUK (Personal Unblocking Key). Your PIN and PUK are supplied by your network operator. You can edit your PIN and select a new four- to eight-digit PIN.

To unblock your SIM card

- 1 When **PIN Blocked** is displayed, enter your PUK
▶ OK.
- 2 Enter a new four- to eight-digit PIN ▶ OK.
Re-enter the new PIN to confirm ▶ OK.

To edit your PIN

- 1 ▶ Settings ▶ General ▶ Locks ▶ SIM Lock
▶ Change PIN.
- 2 Enter your PIN ▶ OK.

- 3 Enter a new four- to eight-digit PIN ▶ OK.
Re-enter the new PIN to confirm ▶ OK.

 *If the message **Codes do not match** appears when you edit your PIN, the new PIN is entered incorrectly. If the message **Wrong PIN** appears, followed by **Old PIN: you entered your old PIN incorrectly**.*

To turn the SIM card lock on or off

- ▶ Settings ▶ General ▶ Locks ▶ SIM Lock
- ▶ Protection and select **On** or **Off**. Enter your PIN
- ▶ OK.

Phone lock

The phone lock protects the phone against unauthorized use. You can change the phone lock code (0000) to any four- to eight-digit personal code.

To unlock the phone

If the phone lock is on, enter your code ▶ OK.

Automatic phone lock

If the phone lock is set to automatic, you only need to enter your phone lock code when you insert a different SIM card.

More features

To set the phone lock

- ▶ Settings ▶ General ▶ Locks ▶ Phone Lock
- ▶ Protection and select an option. Enter the phone lock code ▶ OK.

To edit your phone lock code

- ▶ Settings ▶ General ▶ Locks ▶ Phone Lock
- ▶ Change Code.



It is important that you remember your new code. If you forget it, you have to hand in your phone to your local Sony Ericsson retailer.

Code memo

Save security codes, such as for credit cards, in the code memo. Set a passcode to open the code memo. To confirm that you have entered the correct passcode for the code memo, enter a checkword. When you enter your passcode to open the code memo, the checkword is shown for a short time. If the passcode is correct, the correct codes are shown. If you enter the incorrect passcode, the checkword and the codes that are shown are also incorrect. If you forgot your passcode you must reset the code memo.

To open code memo for the first time

- ▶ Organizer ▶ Code Memo. Instructions appear
- ▶ Continue. Enter a four-digit passcode ▶ Continue. Re-enter the new passcode ▶ Continue. Enter a checkword (maximum 15 characters) ▶ Done.

To add a new code

- ▶ Organizer ▶ Code Memo and enter your passcode
- ▶ Continue ▶ New Code ▶ Add. Enter a name associated with the code, for example, the name of the credit card company ▶ Continue. Enter the code ▶ Done.

To change the passcode

- ▶ Organizer ▶ Code Memo and enter your passcode
- ▶ Continue ▶ More ▶ Change Passcode. Enter your new passcode ▶ Continue. Re-enter the new passcode ▶ Continue. Enter a checkword ▶ Done.

To reset code memo

- ▶ Organizer ▶ Code Memo and enter your passcode
- ▶ Continue ▶ More ▶ Reset. Reset Code Memo? appears ▶ Yes. The code memo is reset and all entries are cleared. The next time you enter the code memo, you must start at
- ▶ 56 To open code memo for the first time.

Troubleshooting

Why doesn't the phone work the way I want?

Some problems require that you call your service provider, but most problems you can correct yourself. Before handing your phone in for repair, copy your saved content and information to another device as it may be lost during repair. For more support go to www.sonyericsson.com/support.

Grey menu options

The service may not be activated or your subscription does not support the function. Contact your network operator.

The phone is working slowly

Delete unwanted content and then restart the phone.

No indication of charging

The battery is empty or has not been used for a long time. It may take up to 30 minutes before the battery icon appears.

The phone cannot be turned on

The battery is discharged ➔ [5 To charge the battery](#).

Charging a non Sony Ericsson battery

➔ [63 Battery](#).

The wrong menu language is shown

➔ [16 To change the phone language](#).

Master reset

Delete your settings and the content you have added/edited.

To reset your phone

► [Settings](#) ► [General](#) ► [Master Reset](#). Select [Reset Settings](#) to delete your changes to settings or [Reset all](#) to delete your changes to settings, all contacts, messages, personal data, and content you have downloaded, received or edited. ► [Continue](#).

Error messages

Insert SIM

Is the SIM card correctly inserted? ➔ [5 To insert the SIM card](#).

Insert correct SIM card

Are you using the correct operator SIM card for your phone?

Troubleshooting

Emerg. calls only

You are within range of a network but not allowed to use it, except for emergency calls. Contact your network operator to ensure your subscription is correct.

No netw. coverage

There is no network within range. Contact your network operator to ensure that the network has coverage.

Wrong PIN/Wrong PIN2

You have entered your PIN or PIN2 incorrectly. Enter the correct PIN or PIN2 ► **Yes**
► *55 SIM card lock.*

Codes do not match

To change a security code you have to confirm the new code by entering exactly the same code twice.

PIN blocked/PIN2 blocked

To unblock ► *55 SIM card lock.*

PUK blocked

Contact your network operator.

Phone locked

The phone is locked. To unlock the phone
► *55 Phone lock.*

Phone lock code

The phone lock code is required ► *55 Phone lock.*

Important information

Sony Ericsson Consumer Web site, service and support, safe and efficient use, warranty, declaration of conformity.

Sony Ericsson Consumer Web site

On www.sonyericsson.com/support there is a support section where help and tips are only a few clicks away. Here you find the latest computer software updates and tips on how to use your product more efficiently.

Service and support

From now on you will have access to a portfolio of exclusive service advantages such as:

- Global and local websites providing support.
- A global network of Call Centers.
- An extensive network of Sony Ericsson service partners.
- A warranty period. Learn more about the warranty conditions in this user guide.

On www.sonyericsson.com, under the support section in the language of your choice, you will find the latest support tools and information, such as software updates, Knowledgebase, Phone setup and additional help when you require it.

For operator-specific services and features, please contact your network operator for more information.

You can also contact our Call Centers. See the phone number for the nearest Call Center in the list below. If your country/region is not represented in the list, please contact your local dealer. (The phone numbers below were correct at the time of going to print. On www.sonyericsson.com you can always find the latest updates.)

In the unlikely event that your product needs service, please contact the dealer from whom it was purchased or one of our service partners. Save your original proof of purchase, you will need it if you need to claim warranty.

For a call to one of our Call Centers you will be charged according to national rates, including local taxes, unless the phone number is a toll-free number.

Australia	1-300 650 050 questions.AU@support.sonyericsson.com
Argentina	800-333-7427 questions.AR@support.sonyericsson.com
Austria	0810 200245 questions.AT@support.sonyericsson.com
Belgium	02-7451611 questions.BE@support.sonyericsson.com
Brazil	4001-0444 questions.BR@support.sonyericsson.com
Canada	1-866-766-9374 questions.CA@support.sonyericsson.com

Important information

Central Africa +27 112589023
questions.CF@support.sonyericsson.com

Chile 123-0020-0656
questions.CL@support.sonyericsson.com

China 4008100000
questions.CN@support.sonyericsson.com

Colombia 18009122135
questions.CO@support.sonyericsson.com

Croatia 062 000 000
questions.HR@support.sonyericsson.com

Czech Republic 844 550 055
questions.CZ@support.sonyericsson.com

Denmark 33 31 28 28
questions.DK@support.sonyericsson.com

Finland 09-299 2000
questions.FI@support.sonyericsson.com

France 0 825 383 383
questions.FR@support.sonyericsson.com

Germany 0180 534 2020
questions.DE@support.sonyericsson.com

Greece 801-11-810-810
210-89 91919 (from mobile)
questions.GR@support.sonyericsson.com

Hong Kong 8203 8863
questions.HK@support.sonyericsson.com

Hungary 06 1 437 7300
questions.HU@support.sonyericsson.com

India 39011111
(Add STD code from a GSM connection)
questions.IN@support.sonyericsson.com

Indonesia 021-2701388
questions.ID@support.sonyericsson.com

Ireland 1850 545 888
questions.IE@support.sonyericsson.com

Italy 06 48895206
questions.IT@support.sonyericsson.com

Malaysia 1-800-889900
questions.MY@support.sonyericsson.com

Mexico 01 800 000 4722
(national toll-free number)
questions.MX@support.sonyericsson.com

Netherlands 0900 899 8318
questions.NL@support.sonyericsson.com

New Zealand 0800-100150
questions.NZ@support.sonyericsson.com

Norway 815 00 840
questions.NO@support.sonyericsson.com

Philippines 02-6351860
questions.PH@support.sonyericsson.com

Poland 0 (prefix) 22 6916200
questions.PL@support.sonyericsson.com

Portugal 808 204 466
questions.PT@support.sonyericsson.com

Romania	(+4021) 401 0401
	questions.RO@support.sonyericsson.com
Russia	8(495) 787 0986
	questions.RU@support.sonyericsson.com
Singapore	67440733
	questions.SG@support.sonyericsson.com
Slovakia	02-5443 6443
	questions.SK@support.sonyericsson.com
South Africa	0861 632222
	questions.ZA@support.sonyericsson.com
Spain	902 180 576
	questions.ES@support.sonyericsson.com
Sweden	013-24 45 00
	questions.SE@support.sonyericsson.com
Switzerland	0848 824 040
	questions.CH@support.sonyericsson.com
Taiwan	02-25625511
	questions.TW@support.sonyericsson.com
Thailand	02-2483030
	questions.TH@support.sonyericsson.com
Turkey	0212 47 37 777
	questions.TR@support.sonyericsson.com
Ukraine	(+380) 44 590 1515
	questions.UA@support.sonyericsson.com
United Arab Emirates	43 919880
	questions.AE@support.sonyericsson.com

United Kingdom	08705 23 7237
	questions.GB@support.sonyericsson.com
United States	1-866-766-9374
	questions.US@support.sonyericsson.com
Venezuela	0-800-100-2250
	questions.VE@support.sonyericsson.com

Guidelines for Safe and Efficient Use

Please read this information before using your mobile phone.

These instructions are intended for your safety. Please follow these guidelines.

If the product has been subject to any of the conditions listed below or you have any doubt of the proper function make sure to have the product checked by certified service partner before charging or using it. Failure to do so might lead to risk for product malfunction or even a potential hazard to your health.



Recommendations for safe use of product (mobile phone, battery, charger and other accessories)

- Always treat your product with care and keep it in a clean and dust-free place.
- **Warning!** May explode if disposed of in fire.

Important information

- Do not expose your product to liquid or moisture or humidity.
- Do not expose your product to extreme high or low temperatures. Do not expose the battery to temperatures above +60°C (+140°F).
- Do not expose your product to open flames or lit tobacco products.
- Do not drop, throw or try to bend your product.
- Do not paint your product.
- Do not attempt to disassemble your product. Only Sony Ericsson authorised personnel should perform service.
- Do not close your product with an object inserted between keypad and display; this may damage your product
- Do not use your product near medical equipment without requesting permission.
- Do not use your product when in, or around aircraft, or areas posted "turn off two-way radio".
- Do not use your product in an area where a potentially explosive atmosphere exists.
- Do not place your product or install wireless equipment in the area above your car's air bag.



CHILDREN

KEEP OUT OF CHILDRENS REACH. DO NOT ALLOW CHILDREN TO PLAY WITH YOUR MOBILE PHONE OR ITS ACCESSORIES. THEY COULD HURT THEMSELVES OR OTHERS, OR COULD ACCIDENTALLY DAMAGE THE MOBILE PHONE OR ACCESSORY. YOUR MOBILE PHONE OR ITS ACCESSORY MAY CONTAIN SMALL PARTS THAT COULD BE DETACHED AND CREATE A CHOKING HAZARD.



Power supply (Charger)

Connect the AC power adapter only to designated power sources as marked on the product. Make sure the cord is positioned so that it will not be subjected to damage or stress. To reduce risk of electric shock, unplug the unit from any power source before attempting to clean it. The AC power adapter must not be used outdoors or in damp areas. Never alter the cord or plug. If the plug will not fit into the outlet, have a proper outlet installed by a qualified electrician. Use only Sony Ericsson branded original chargers intended for use with your mobile phone. Other chargers may not be designed to the same safety and performance standards.

Battery

We recommend that you fully charge the battery before you use your mobile phone for the first time. A new battery or one that has not been used for a long time could have reduced capacity the first few times it is used. The battery should only be charged in temperatures between +5°C (+41°F) and +45°C (+113°F).

Use only Sony Ericsson branded original batteries intended for use with your mobile phone. Using other batteries and chargers could be dangerous.

The talk and standby times depend on several different conditions such as signal strength, operating temperature, application usage patterns, features selected and voice or data transmissions when using the mobile phone.

Turn off your mobile phone before removing the battery. Do not allow the battery to be put into the mouth. Battery electrolytes may be toxic if swallowed. Do not let the metal contacts on the battery touch another metal object. This could short-circuit and damage the battery. Use the battery for the intended purpose only.

Personal medical devices

Mobile phones may affect the operation of cardiac pacemakers and other implanted equipment. Please avoid placing the mobile phone over the pacemaker,

e.g. in your breast pocket. When using the mobile phone, place it at the ear opposite the pacemaker. If a minimum distance of 15 cm (6 inches) is kept between the mobile phone and the pacemaker, the risk of interference is limited. If you have any reason to suspect that interference is taking place, immediately turn off your mobile phone. Contact your cardiologist for more information.

For other medical devices, please consult your physician and the manufacturer of the device.

Driving

Please check if local laws and regulations restrict the use of mobile phones while driving or require drivers to use handsfree solutions. We recommend that you use only Sony Ericsson handsfree solutions intended for use with your product.

Please note that because of possible interference to electronic equipment, some vehicle manufacturers forbid the use of mobile phones in their vehicles unless a handsfree kit with an external antenna supports the installation.

Always give full attention to driving and pull off the road and park before making or answering a call if driving conditions so require.

Important information

Emergency calls

Mobile phones operate using radio signals, which cannot guarantee connection under all conditions. Therefore you should never rely solely upon any mobile phone for essential communications (e.g. medical emergencies).

Emergency calls may not be possible in all areas, on all cellular networks, or when certain network services and/or mobile phone features are in use. Check with your local service provider.

Antenna

This phone contains a built in antenna. Use of antenna devices not marketed by Sony Ericsson specifically for this model could damage your mobile phone, reduce performance, and produce SAR levels above the established limits (see below).

Efficient use

Hold your mobile phone as you would any other phone. Do not cover the top of the phone when in use, as this affects call quality and may cause the phone to operate at a higher power level than needed, thus shortening talk and standby times.

Radio frequency (RF) exposure and SAR

Your mobile phone is a low-power radio transmitter and receiver. When it is turned on, it emits low levels of radio frequency energy (also known as radio waves or radio frequency fields).

Governments around the world have adopted comprehensive international safety guidelines, developed by scientific organizations, e.g. ICNIRP (International Commission on Non-Ionizing Radiation Protection) and IEEE (The Institute of Electrical and Electronics Engineers Inc.), through periodic and thorough evaluation of scientific studies. These guidelines establish permitted levels of radio wave exposure for the general population. The levels include a safety margin designed to assure the safety of all persons, regardless of age and health, and to account for any variations in measurements.

Specific Absorption Rate (SAR) is the unit of measurement for the amount of radio frequency energy absorbed by the body when using a mobile phone. The SAR value is determined at the highest certified power level in laboratory conditions, but the actual SAR level of the mobile phone while operating can be well below this value. This is because the mobile phone is designed to use the minimum power required to reach the network.

Variations in SAR below the radio frequency exposure guidelines do not mean that there are variations in safety. While there may be differences in SAR levels among mobile phones, all Sony Ericsson mobile phone models are designed to meet radio frequency exposure guidelines.

For phones sold in the U.S., before a phone model is available for sale to the public, it must be tested and certified to the FCC that it does not exceed the limit established by the government-adopted requirement for safe exposure. The tests are performed in positions and locations (that is, at the ear and worn on the body) as required by the FCC for each model. For body worn operation, this phone has been tested and meets FCC RF exposure guidelines when the handset is positioned a minimum of 15 mm from the body without any metal parts in the vicinity of the phone or when used with the original Sony Ericsson body worn accessory intended for this phone. Use of other accessories may not ensure compliance with FCC RF exposure guidelines.

A separate leaflet with SAR information for this mobile phone model is included with the material that comes with this mobile phone. This information can also be found, together with more information on radio frequency exposure and SAR, on:
www.sonyericsson.com.

Accessible Solutions/Special Needs

For phones sold in the U.S., you can use your TTY terminal with your Sony Ericsson mobile phone (with the necessary accessory). For information on Accessible Solutions for individuals with special needs call the Sony Ericsson Special Needs Center at 877 878 1996 (TTY) or 877 207 2056 (voice), or visit the Sony Ericsson Special Needs Center at www.SonyEricsson-snc.com.

Disposal of old electrical & electronic equipment

This symbol on the product or on its packaging indicates that this product shall not be treated as household waste. Instead it shall be handed over to the applicable collection point for the recycling of electrical and electronic equipment. By ensuring this product is disposed of correctly, you will help prevent potential negative consequences for the environment and human health, which could otherwise be caused by inappropriate waste handling of this product. The recycling of materials will help to conserve natural resources. For more detailed information about recycling of this product, please contact your local city office, your household waste disposal service or the shop where you purchased the product.



Important information

Disposing of the battery

Please check local regulations for disposal of batteries or call your local Sony Ericsson Call Center for information.

The battery should never be placed in municipal waste. Use a battery disposal facility if available.



End User Licence Agreement

This wireless device, including without limitation any media delivered with the device, (“Device”) contains software owned by Sony Ericsson Mobile Communications AB and its affiliated companies (“Sony Ericsson”) and its third party suppliers and licensors (“Software”).

As user of this Device, Sony Ericsson grants you a non-exclusive, non-transferable, non-assignable license to use the Software solely in conjunction with the Device on which it is installed and/or delivered with. Nothing herein shall be construed as a sale of the Software to a user of this Device.

You shall not reproduce, modify, distribute, reverse engineer, decompile, otherwise alter or use any other means to discover the source code of the Software or any component of the Software. For avoidance of doubt, you are at all times entitled to transfer all rights and obligations to the Software to a third party, solely together with the Device with which you received the Software, provided always that such third party agrees in writing to be bound by these rules.

You are granted this license for a term of the useful life of this Device. You can terminate this license by transferring all your rights to the Device on which you have received the Software to a third party in writing. If you fail to comply with any of the terms and conditions set out in this license, it will terminate with immediate effect.

Sony Ericsson and its third party suppliers and licensors are the sole and exclusive owner of and retain all rights, title and interest in and to the Software. Sony Ericsson, and, to the extent that the Software contains material or code of a third party, such third party, shall be entitled third party beneficiaries of these terms.

The validity, construction and performance of this license shall be governed by the laws of Sweden. The foregoing shall apply to the full extent permitted by, when applicable, statutory consumer rights

Limited Warranty

Sony Ericsson, provides this Limited Warranty for your mobile phone and original accessory delivered with your mobile phone (hereinafter referred to as “Product”).

Should your Product need warranty service, please return it to the dealer from whom it was purchased, or contact your local Sony Ericsson Call Center (national rates may apply) or visit www.sonyericsson.com to get further information.

Our warranty

Subject to the conditions of this Limited Warranty, Sony Ericsson warrants this Product to be free from defects in design, material and workmanship at the time of its original purchase by a consumer, and for a subsequent period of one (1) year.

What we will do

If, during the warranty period, this Product fails to operate under normal use and service, due to defects in design, materials or workmanship, Sony Ericsson authorised distributors or service partners, in the country/region* where you purchased the Product, will, at their option, either repair or replace the Product in accordance with the terms and conditions stipulated herein.

Sony Ericsson and its service partners reserve the right to charge a handling fee if a returned Product is found not to be under warranty according to the conditions below.

Please note that some of your personal settings, downloads or other information may be lost when your Sony Ericsson Product is repaired or replaced. At present Sony Ericsson may be prevented by applicable law, other regulation or technical restrictions from making a backup copy of certain downloads. Sony Ericsson does not take any responsibility for any lost information of any kind and will not reimburse

you for any such loss. You should always make backup copies of all the information stored on your Sony Ericsson Product such as downloads, calendar and contacts before handing in your Sony Ericsson Product for repair or replacement.

Conditions

- 1 The warranty is valid only if the original proof of purchase issued to the original purchaser by a Sony Ericsson authorised dealer, specifying the date of purchase and serial number**, for this Product, is presented with the Product to be repaired or replaced. Sony Ericsson reserves the right to refuse warranty service if this information has been removed or changed after the original purchase of the Product from the dealer.
- 2 If Sony Ericsson repairs or replaces the Product, the repaired or replaced Product shall be warranted for the remaining time of the original warranty period or for ninety (90) days from the date of repair, whichever is longer. Repair or replacement may involve the use of functionally equivalent reconditioned units. Replaced parts or components will become the property of Sony Ericsson.
- 3 This warranty does not cover any failure of the Product due to normal wear and tear, or due to misuse, including but not limited to use in other than the normal and customary manner, in

Important information

accordance with the Sony Ericsson instructions for use and maintenance of the Product. Nor does this warranty cover any failure of the Product due to accident, software or hardware modification or adjustment, acts of God or damage resulting from liquid.

A rechargeable battery can be charged and discharged hundreds of times. However, it will eventually wear out - this is not a defect. When the talk-time or standby time is noticeably shorter, it is time to replace your battery. Sony Ericsson recommends that you use only batteries and chargers approved by Sony Ericsson.

Minor variations in display brightness and color may occur between phones. There may be tiny bright or dark dots on the display. These are called defective pixels and occur when individual dots have malfunctioned and can not be adjusted. Two defective pixels are deemed acceptable.

Minor variations in camera image appearance may occur between phones. This is nothing uncommon and is not regarded as a defective camera module.

- 4 Since the cellular system on which the Product is to operate is provided by a carrier independent from Sony Ericsson, Sony Ericsson will not be responsible for the operation, availability, coverage, services or range of that system.

- 5 This warranty does not cover Product failures caused by installations, modifications, or repair or opening of the Product performed by a non-Sony Ericsson authorised person.
- 6 The warranty does not cover Product failures which have been caused by use of accessories or other peripheral devices which are not Sony Ericsson branded original accessories intended for use with the Product.
- 7 Tampering with any of the seals on the Product will void the warranty.
- 8 THERE ARE NO EXPRESS WARRANTIES, WHETHER WRITTEN OR ORAL, OTHER THAN THIS PRINTED LIMITED WARRANTY. ALL IMPLIED WARRANTIES, INCLUDING WITHOUT LIMITATION THE IMPLIED WARRANTIES OF MERCHANTABILITY OR FITNESS FOR A PARTICULAR PURPOSE, ARE LIMITED TO THE DURATION OF THIS LIMITED WARRANTY. IN NO EVENT SHALL SONY ERICSSON OR ITS LICENSORS BE LIABLE FOR INCIDENTAL OR CONSEQUENTIAL DAMAGES OF ANY NATURE WHATSOEVER, INCLUDING BUT NOT LIMITED TO LOST PROFITS OR COMMERCIAL LOSS; TO THE FULL EXTENT THOSE DAMAGES CAN BE DISCLAIMED BY LAW.

Some countries/states do not allow the exclusion or limitation of incidental or consequential damages, or limitation of the duration of implied warranties, so the preceding limitations or exclusions may not apply to you.

The warranty provided does not affect the consumer's statutory rights under applicable legislation in force, nor the consumer's rights against the dealer arising from their sales / purchase contract.

***EUROPEAN UNION (EU)**

If you have purchased your Product in an EU country you can have your Product serviced, under the conditions set out above, within the warranty period in any EU country where an identical Product is sold by an authorised Sony Ericsson distributor. To find out if your Product is sold in the EU country you are in, please call the local Sony Ericsson Call Center. Please observe that certain services may not be possible elsewhere than in the country of original purchase, for example due to the fact that your Product may have an interior or exterior which is different from equivalent models sold in other EU countries. It may not be possible to repair SIM-locked Products.

** In some countries/regions additional information is requested. If so, this is clearly shown on the valid proof of purchase.

FCC Statement

This device complies with Part 15 of the FCC rules. Operation is subject to the following two conditions: (1) This device may not cause harmful interference, and (2) This device must accept any interference received, including interference that may cause undesired operation.



Important information

Declaration of Conformity

We, **Sony Ericsson Mobile Communications AB** of
Nya Vattentornet

S-221 88 Lund, Sweden

declare under our sole responsibility that our product

Sony Ericsson type AAF-1052033-BV

and in combination with our accessories, to which this
declaration relates is in conformity with the appropriate
standards 3GPP TS 51.010-1, EN 301489-7,
EN 300328, EN 301489-17, and EN 60950

following the provisions of, Radio Equipment and
Telecommunication Terminal Equipment directive
99/5/EC with requirements covering EMC directive
89/336/EEC, and Low Voltage directive **73/23/EEC**

We fulfil the requirements of the R&TTE Directive
(**99/5/EC**).

Lund, May 2006

CE 0682

Shoji Nemoto,
Head of Product Business Unit GSM/UMTS

Index

A

- adding
 - personal ringtones 20
 - pictures to contacts 20
- alarm clock 52
- answering service 22
- applications 45
- appointments 53

B

- battery
 - charging 5
 - inserting 5
- Bluetooth™ 48–49
- buttons 10

C

- calculator 54
- call forward 25
- call time 28
- call waiting 25

calls

- accept 27
 - answering and rejecting 18
 - emergency 19
 - hold 25
 - list 18
 - making 8, 18
 - receiving 8
 - recording 44
 - redial 18
 - restricting 27
 - two calls 26
- camera 35–36
 - certificates 47
 - closed user groups 28
 - code memo 56
 - conference calls 26
 - contacts 19
 - edit 21
 - synchronizing 47

D

- date 52
- declaration of conformity 70
- Disc2Phone 38

E

- email 33
- entering letters 16

F

- file manager 15
- fixed dialing 28
- FM radio 42

G

- games 45
- groups 22

H

- handsfree 49
- hiding number 29

Index

I

icons 14
infrared port 49
instant messaging 30
Internet 46

K

keys and buttons 10

L

language 16, 57
locks
 phone 55
 SIM card 55

M

magic word 24
melodies 43
memory status
 contacts 21
 file manager 15
Memory Stick
 formatting 15
 insert and remove 6
menus 10, 12

messages
 deleting 31
 picture (MMS) 32
 text 30
 voice 33
microphone 18
music 39
MusicDJ 38
My friends 34
my numbers 27

N

navigation key 10
networks 18
notes 54

P

phone
 assembly 4
 language 16
 overview 9
phone lock 55
PhotoDJ 37
picture messaging 32

pictures 20, 36–37
PIN code 7
 entering 7
PlayNow™ 43
profiles 52
PUK 55

R

radio 42
recording
 calls 44
 sounds 44
 video clips 35
reject a call 18
restricted dialing 27
ringtones 20

S

safety guidelines 61
screen saver 37
security
 code memo 56
 Internet 47

- sending
 - appointments 54
 - melodies 44
 - notes 54
 - pictures and video clips 36
 - ringtones 44
 - tasks 54

- settings
 - connectivity 46
 - display brightness 53
 - email 33
 - remote synchronization 48

- shortcuts 14

- showing number 29

- SIM card

- copying to/from 20
 - save automatically 21
 - unblocking 55

- sound recorder 44

T

- T9™ Text Input 17

- tasks 54

- text input 16

- themes 45

- transferring files 50–51

- TTY 65

- turning on/off

- phone 7

- phone lock 55

- ringtones 43

- two voice lines 26, 27

U

- unblock SIM card 55

- USB cable 50

- USB drivers 38

V

- vibrating alert 44

- video clips 36–37, 39

- video recorder 35

- VideoDJ 37

- voice answering 24

- voice control 22–25

- voice dialing 23

- voicemail 22

- volume

- ringtone 44

W

- Walkman® 38

- wallpaper 37

- warranty 66

Z

- zoom 35