



Sony Ericsson

Z502a

Contents

Getting started	4	Connectivity	69
Assemble the phone, SIM card, battery, make a call.		Internet and email settings, synchronizing, PC applications.	
Getting to know your phone	10	More features	74
Phone overview, use the menus, enter letters, file manager.		Time and date, alarm clock, calendar, tasks, SIM card lock, etc.	
Calling	21	Troubleshooting	84
Calls, phonebook, voice control, call options.		Why doesn't the phone work the way I want?	
Messages	42	Additional Information	87
Text messaging, picture messaging, email, My friends, messaging glossary.		Sony Ericsson web site, technical assistance, safe and efficient use, warranty, declaration of conformity.	
Imaging	58	Icons	96
Camera, video recorder, pictures, screen saver.		Icon descriptions.	
Entertainment	64	Index	99
Media player, sounds, themes, games.		Important Information	105

Sony Ericsson

This manual is published by Sony Ericsson Mobile Communications AB, without any warranty. Improvements and changes to this manual necessitated by typographical errors, inaccuracies of current information, or improvements to programs and/or equipment, may be made by Sony Ericsson Mobile Communications AB at any time and without notice. Such changes will, however, be incorporated into new editions of this manual. All rights reserved.

©**Sony Ericsson Mobile Communications AB, 2005**

Publication number: AELZT 123 1784 R1A

Please note:

Some of the services in this manual are not supported by all networks. *This also applies to the GSM International Emergency Number 112.*

Please contact your network operator or service provider if you are in doubt whether you can use a particular service or not.

Please read the *Guidelines for safe and efficient use* and the *Limited warranty* chapters before you use your mobile phone.

The Bluetooth word mark and logos are owned by the Bluetooth SIG, Inc. and any use of such marks by Sony Ericsson is under license.

T9™ Text Input is a trademark or a registered trademark of Tegic Communications.

T9™ Text Input is licensed under one or more of the following: U.S. Pat. Nos. 5,818,437, 5,953,541, 5,187,480, 5,945,928, and 6,011,554; Canadian Pat. No. 1,331,057; United Kingdom Pat. No. 2238414B; Hong Kong Standard Pat. No. HK0940329; Republic of Singapore Pat. No. 51383; Euro Pat. No. 0 684 463(96927260.8) DE/DK, FI, FR, IT, NL, PT, ES, SE, GB; and additional patents are pending worldwide.

PlayNow™ is a trademark or a registered trademark of Sony Ericsson Mobile Communications AB.

MusicDJ™ is a trademark or a registered trademark of Sony Ericsson Mobile Communications AB.

Java and all Java based trademarks and logos are trademarks or registered trademarks of Sun

Microsystems, Inc. in the U.S. and other countries. End-user license agreement for Sun™, Java™, J2ME™.

1 Restrictions: Software is confidential copyrighted information of Sun and title to all copies is retained by Sun and/or its licensors. Customer shall not modify, decompile, disassemble, decrypt, extract, or otherwise reverse engineer Software. Software

may not be leased, assigned, or sublicensed, in whole or in part.

2 **Export Regulations:** Software, including technical data, is subject to U.S. export control laws, including the U.S. Export Administration Act and its associated regulations, and may be subject to export or import regulations in other countries. Customer agrees to comply strictly with all such regulations and acknowledges that it has the responsibility to obtain licenses to export, re-export, or import Software. Software may not be downloaded, or otherwise exported or re-exported (i) into, or to a national or resident of, Cuba, Iraq, Iran, North Korea, Libya, Sudan, Syria (as such listing may be revised from time to time) or any country to which the U.S. has embargoed goods; or (ii) to anyone on the U.S. Treasury

Department's list of Specially Designated Nations or the U.S. Commerce Department's Table of Denial Orders.

3 **Restricted Rights:** Use, duplication or disclosure by the United States government is subject to the restrictions as set forth in the Rights in Technical Data and Computer Software Clauses in DFARS 252.227-7013(c) (1) (ii) and FAR 52.227-19(c) (2) as applicable.

Part of the software in this product is copyright © SyncML initiative Ltd. (1998-2002). All rights reserved.

Other product and company names mentioned herein may be the trademarks of their respective owners.

Any rights not expressly granted herein are reserved.

Getting started

Getting started

Assemble the phone, SIM card, battery, make a call.

More information and downloads are available at www.SonyEricsson.com/support.

Instruction icons

The following instruction icons appear in this user guide:

- ▶ Use the selection keys or the navigation key to scroll and select.
- ➡ 13 *Navigating the menus.*
- ➡ See also page ...
- ! Important
- 🗒 Note
- 📞 Contact your service provider for details.

Assembly

Before you can use your phone you need to:

- Insert the SIM card.
- Attach and charge the battery.

SIM card

When you register as a subscriber with a service provider, you get a SIM (Subscriber Identity Module) card. The SIM card contains a computer chip that keeps track of your phone number, the services included in your subscription, and your phonebook information, among other things.

 *If you have been using a SIM card in another phone, make sure that your information is saved to the SIM card before you remove it from the other phone. For example, contacts may have been saved in the phone memory ➡ 24 Phonebook.*

SIM card and battery information

Always turn off the phone and detach the charger before you insert or remove a SIM card.

Getting started

- 1 Insert the SIM card.
- 2 Make sure the SIM card is aligned and then slide it under the metal holder.
- 3 Place the battery on the back of the phone with the label side up and the connectors facing each other.
- 4 Place the back cover as shown in the picture and slide it into place.
- 5 Connect the charger to the phone at the flash symbol. The flash symbol on the charger plug must face upwards.
- 6 It may take up to 30 minutes before the battery icon appears on the screen.
- 7 Wait approximately 4 hours or until the battery icon indicates that the battery is fully charged. If you do not see the battery icon after this time, press any key or the navigation key (⌂) to activate the screen.
- 8 Remove the charger by tilting the plug upwards.

 It may take up to 30 minutes before the battery icon appears when charging.

To insert the SIM card and charge the battery

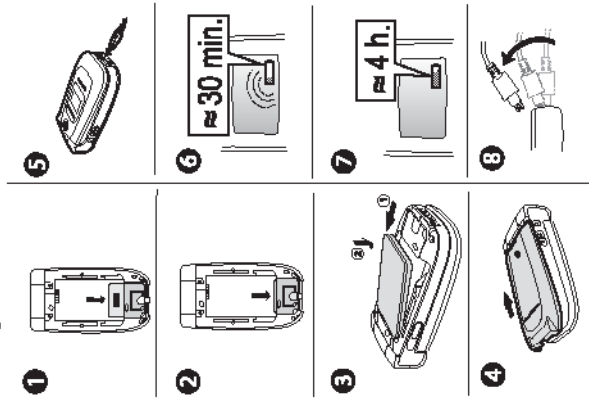



Getting started

PIN (Personal Identity Number)

You may need a PIN (Personal Identity Number) to activate the services in your phone. Your PIN is supplied by your service provider. When you enter your PIN, the digits are hidden with an *, unless your PIN starts with the same digits as an emergency number, for example 112. This is so that you can see and call an emergency number without entering a PIN ➔ *24 Emergency calls*.

If you make a mistake while entering your PIN, delete the number by pressing .

 *If you enter the wrong PIN three times in a row, the SIM card is blocked and the message PIN blocked appears. To unblock it, you need to enter your FUK (Personal Unblocking Key), ➔ 80 SIM card lock.*

 *Your FUK is supplied by your service provider.*

Available services

Some services and functions described in this user guide are network- or subscription-dependent.

Because of this, all menus may not be available in your phone.

 *This symbol indicates that a service or function is network- or subscription-dependent.*

Please consult your service provider for more information about your subscription.

Getting started

First-time use

Make sure that the phone is charged before you turn it on.

To turn on the phone

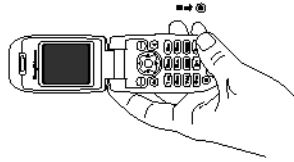

- 1 Press and hold **(P)** until the phone vibrates. This indicates that it is powering up.
- 2 Enter your PIN, if you have one for your SIM card.

- 3 At first start-up, select the language you want for your phone, that is, the language for the menus.
- 4 ► Yes if you want the setup wizard to help you get started. Follow the instructions that appear.

When you have turned the phone on, you can use a setup wizard to quickly and easily prepare your phone for use.

Setup wizard

This feature is operator dependent.

You can use the setup wizard to help you get started with the basic settings in your phone. If you do not want help the first time you turn on your phone, you can select to use the wizard later. You can also select to start the wizard from the menu system at any time. The wizard gives you tips on how to use the keypad and guides you through the settings.

Getting started

To start the setup wizard from the menu system

- 1 ▶ Settings ▶ the General tab ▶ Setup Wizard.
- 2 Select language for your phone.
- 3 Follow the instructions that appear to complete the setup.

To make and receive calls

- Enter the area code and phone number ▶ Call to make the call. ▶ End Call to end the call.
- When the phone rings ▶ Yes.

To enter the desktop

- Press the center select key .

Getting started

- 1 Hold the phone as shown in Illustration 1.
- 2 Apply pressure with the heel of one hand while pushing away with the thumb of your other hand. You may need to apply significant pressure the first time you remove the cover.
- 3 Slide the cover away from the hinge.
- 4 Remove the cover.
- 5 Locate the notches along each side of the phone. Using the notches as a guide, slide the back cover upward applying pressure with the heel of your hand.
- 6 Click the flip cover into place.

Use these instructions to replace the other outer cover.

To replace the outer covers

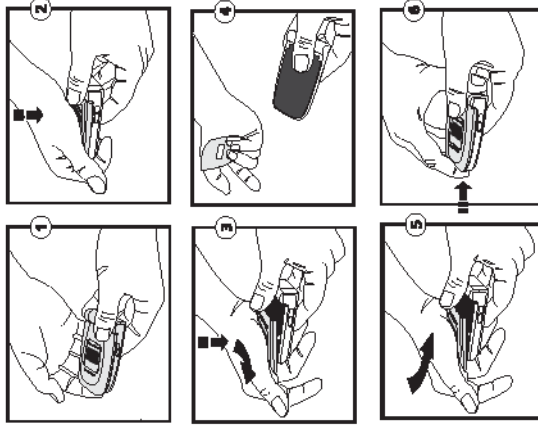

Getting to know your phone

Getting to know your phone

Phone overview, use the menus, enter letters, file manager.

Flip open view

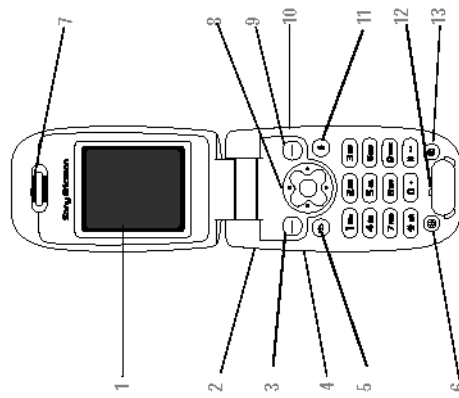

- 1 Internal display
- 2 Press and hold to activate the camera and video recorder
- 3, 9 Selection key for menu items shown at the bottom of the screen.
- 4 Side volume buttons (see "Flip closed views" on page 10)
- 5 Press once to go back one level in the menus. Press and hold to return to standby.
- 6 Internet button
- 7 Speaker
- 8 5-way navigation key. Press the center select to enter the desktop menu. Move through menus, lists and text by pressing right, left, up or down.
- 10 Right side key (may be customized)
- 11 Delete numbers, letters or an item from a list.
- 12 Microphone
- 13 Press and hold to turn the phone on/off

Getting to know your phone

Flip closed views

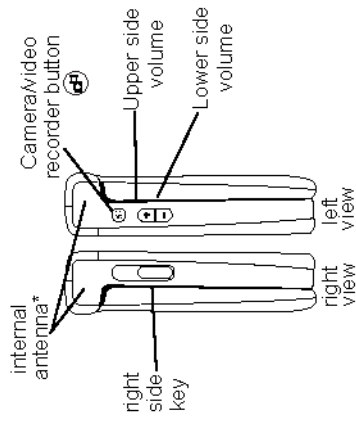
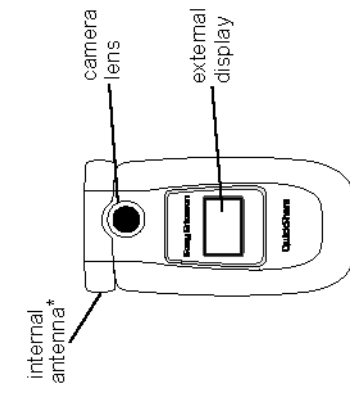

* Your phone is equipped with an internal antenna. For best reception, try to hold your phone so your hand does not cover the internal antenna. See the diagram above for the location of the antenna.

Getting to know your phone

Overview, menu

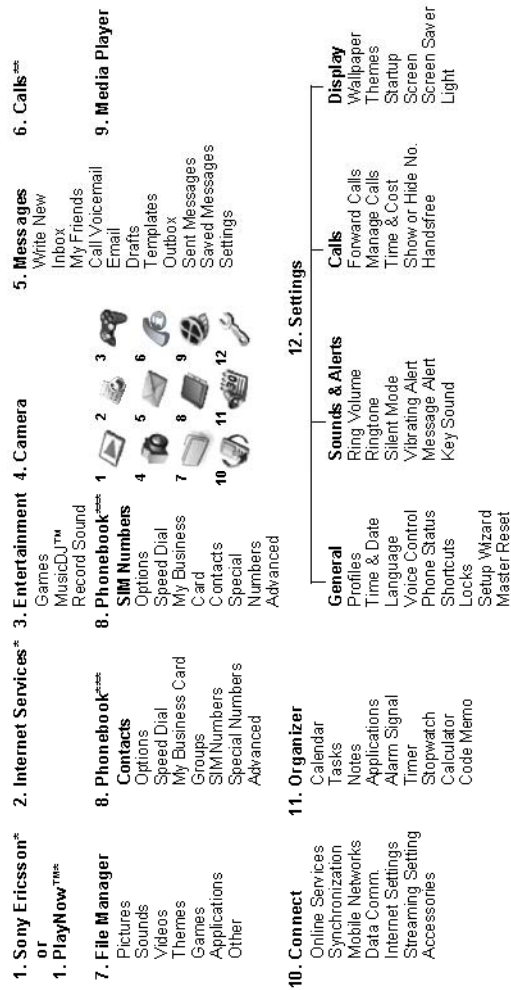

* Please note that some menus are operator, network and subscription dependent.

** Some operators may have enabled an Instant Messaging client (Sony Ericsson refers to this as My Friends)

*** The menu depends on which phonebook is selected as default.

Navigating the menus

The main menus are shown as icons on the desktop. Some submenus include tabs that appear on the screen. Scroll to a tab with the navigation key and select an option.

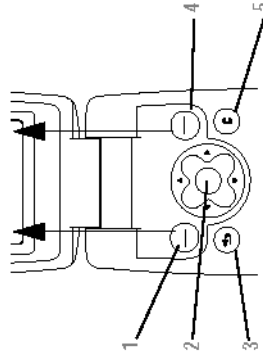

- 1 Left selection key. Press to select the option displayed on the bottom left of the screen.

Getting to know your phone

- 2 4-way navigation with center select.
Press to go to the desktop.
Press to select highlighted items.
Move , , , through menus and tabs.
Press to go back one level in the menus.
Press and hold to return to standby.
- 4 Right selection key. Press to select the option displayed on the bottom right of the screen.
- 5 Press to delete an item or character of text.
Press and hold to delete more than one character of text.

External display



Your phone's external display shows the service provider, time, date, signal strength, and the battery charge level.

Relevant status information is shown on the external display. When the camera button is pressed and held with the flip closed, the external display functions as a view finder. Zoom is controlled with the upper and lower side volume keys.

Getting to know your phone

Phone language

Most SIM cards automatically set the language used in the menu to the language of the country where you bought your SIM card. If this is not the case, the predefined language is English. If you use the setup wizard to help you get started with your phone, you will be asked to select phone language, ➔ 7 Setup wizard.

 You can always choose Automatic language by pressing **8888**  in standby.

You can always choose English by pressing **0000**  in standby.

To change the phone language

- 1 ▶ Settings ▶ the Settings tab ▶ Language ▶ Phone Language.
- 2 Select a language.

Help texts

More information, explanations or tips about selected features, menus or functions are available in your phone.







To get help

Scroll to the menu item ▶ Info.

Shortcuts

A quicker way to move through the menus is to use shortcuts. You can use keypad shortcuts, or you can create your own shortcuts from standby.

Using keypad shortcuts

Enter the menu by pressing  and then enter the number of the menu to which you want to go. For example, to reach the fifth menu item, press **5** . To reach the tenth menu item, press **0** ; to reach the eleventh menu item, press **0** ; and to reach the twelfth menu item, press **0** . To get back to standby, press and hold .

Creating standby shortcuts

You can create your own shortcuts and use  to go directly to that function.

To create a standby shortcut

- 1 Press  in a direction for which there is no predefined shortcut ▶ Yes when you are asked if you want to create a shortcut.
- 2 Scroll to a function that you want to create a shortcut to ▶ Shortcut

To edit a standby shortcut

- 1 ▶ Settings ▶ the General tab ▶ Shortcuts and select which shortcut you want to edit ▶ Edit.
- 2 Scroll to a function that you want to create a new shortcut to ▶ Shortcut.

More options

- ▶ More to enter a list of options. There are different alternatives in the list of options depending on where you are in the menus.

Entering letters

There are two ways of entering letters, for example, when writing a message or writing a name in the phonebook:

- Multitap text input
You press each key as many times as needed to show the letter you want.
- T9™ Text Input

The T9 Text Input method uses a built-in dictionary to recognize the most commonly used word for each sequence of key presses. This way, you press each key only once, even if the letter you want is not the first letter on the key.





Writing languages

Before you start entering letters, you need to select the languages that you want to use when writing. When writing, you can switch to one of your selected languages by pressing and holding .



To select writing language

- 1 ▶ Settings ▶ the General tab ▶ Language ▶ Writing Language.
- 2 Scroll to the language that you want to use for entering letters and mark each language you want. ▶ Save to exit the menu.

To enter letters using multitap text input

- 1 To enter text, you have to be in a function where text input is possible, for example ▶ Messages ▶ Write New ▶ Text Message.
- 2 Press the appropriate key,  - ,  or , repeatedly until the character you want appears on the screen.

Press... to get...

	., ' ? ! ' @ : ; / () 1
	A B C A A A E a Ç 2 Γ

Getting to know your phone

Press...	to get...
	DEF e f 3 Δ Φ
	GHI i 4
	JKL j k l 5 A
	MNO n o 6 6
	PQRS p q r s 7 Π Σ
	TUV t u v 8
	WXYZ 9
	+ 0 @ E Ψ Ω
	space ↵ ¶
	to delete letters and numbers
	to shift between capital and lower-case letters
	press and hold to enter numbers

Example:





- To enter an 'A', press once.
- To enter a 'B', quickly press twice.
- To shift between capital and lower-case letters, press , then enter the letter.

- You can use the volume buttons as a shortcut to certain letters: To enter a 'B', press and hold and press . To enter a 'C', press and hold and press .

To enter letters using T9 Text Input

- 1 **Messages** ▶ **Write New** ▶ **Text Message**.
- 2 For example, if you want to write the word "Jane", press , , , .
- 3 If the word shown is the one you want, press to accept and add a space. To accept a word without adding a space, press . If the word shown is not the one you want, press or repeatedly to view alternative words. Accept a word and add a space by pressing .
- 4 Continue writing your message. To enter a period or other punctuation marks, press and then or repeatedly. Accept by pressing .



Getting to know your phone

- To add words to the T9 dictionary**
- 1 While entering letters ► More ► Spell Word.
 - 2 Edit the word by using multitap input. Navigate between the letters with  and . To delete a character, press . To delete the entire word, press and hold .
 - 3 When you have edited the word ► Insert. The word is added to the T9 dictionary. Next time you enter this word using T9, it will appear as one of the alternative words.

To select another writing method

Before, or while entering letters, press and hold  to select another writing method.

Options when entering letters

- More to view a list of options. The list may contain some or all of the following:
- Add Symbol – symbols and punctuation marks such as ? and , are shown. Move between the symbols by using , , and .
 - Add Item – pictures, melodies and sounds.
 - Spell Word – for T9 Text Input only. Edit the suggested word by using multitap text input.
 - Text Format – change style, size and alignment.

- Writing Language – a list of available languages is shown.
- Dictionary (T9) – turn T9 Text Input on or off.
- Word Suggestions – select to view, or not, word suggestions when writing a word.
- My Words – manage the words that you have added to the dictionary.
- Help – assistance with how to use T9 and Multitap text input.

File manager

Items such as pictures, videos, sounds, themes, applications, and games are saved as files in folders. All files that the phone cannot recognize are saved in the Other folder. The phone has several predefined folders. Items such as pictures, sounds, videos, themes, games and applications are saved as files in folders.

When handling files, you can select several files at the same time to delete, send or move to a folder.

To move a file to a folder

- 1 ► File Manager and select a folder.
- 2 Scroll to a file, for example, a picture that you want to move ► More ► Manage Files ► Move to Folder.

Getting to know your phone

- 3 Select the folder you want to move the file to, or select **New Folder** and name the folder ▶ **OK**.

To create a subfolder

- 1 ▶ **File Manager** and select a folder.
- 2 ▶ **More** ▶ **Manage Files** ▶ **New Folder** and enter a name for the folder.
- 3 ▶ **OK** to save the folder.

To select several files

- 1 ▶ **File Manager** and select a file ▶ **More** ▶ **Mark Several**.
- 2 Scroll and select more files by pressing **Mark** or **Unmark**.

File information

Items that are downloaded, text or picture messages may be copyright-protected. If a file is protected, you may not be able to copy or send that file – a message will appear to inform you about this. You can also select to view information for the file.















Your mobile phone has the capability to download, store and forward additional content, e.g. ringtones. The use of such content may be restricted or prohibited by rights of third parties, including but not limited to restriction under applicable copyright laws. You, and not Sony Ericsson, are entirely responsible for additional content that you download to or forward from your mobile phone. Prior to your use of any additional content, please verify that your intended use is properly licensed or is otherwise authorized. Sony Ericsson does not guarantee the accuracy, integrity or quality of any additional content or any other third party content. Under no circumstances will Sony Ericsson be liable in any way for your improper use of additional content or other third party content.















Quick keys

Useful key combinations are described below.

Navigating menus

- Enter the main menu and select menu items. 
- Navigate in the menu and lists.   
- Delete an item press  when in lists 
- Enter a list of options 
- Enter the status menu to see, for example, date, profile, free memory and model name. press a volume button once 
- Change the language to Automatic.  8888
- Change the language to Go back to standby or end a function.  0000  press and hold 









Making and receiving calls

- Make an emergency call. enter the international emergency number  Call
- Set the phone to silent. press and hold  or press More  Turn On Silent
- Mute the ringer. press the  or  key
- Send the call directly to voicemail. double-press the  or  key or  No
- Call your voicemail. press and hold  
- Enter call list.  Calls
- Voice dial. press and hold a volume button or say your magic word (voice dial must be set up first)
- Reach a contact beginning with a specific letter. press and hold any of the keys  -  

Getting to know your phone

Speed dial	press any of the number keys (1-9) and ► Call	Shift between multitap or T9 Text Input methods	press and hold (*#)
Reject a call	quickly press a volume button twice when receiving a call or ► No	Shift between writing languages Enter numbers	press and hold (#=)
Turn off the ringtone when receiving a call	press a volume button once or press (e)	Enter the + sign Enter a <i>p</i> (pause)	press and hold (0+) press and hold (7##) when entering numbers or saving codes
Put a call on hold	► Hold		
Retrieve a call	► Retrieve		
Turn off the microphone	press and hold (e)		
Enter a list of options	► More		
Entering letters		Using multitap text input	
Shift between capital and lower-case letters	press (*#), then the letter	Reach the second letter or character of a key	press and hold (+) and press any of the number keys
Delete letters and numbers	press (e)	Reach the third letter or character of a key	press and hold (=) and press any of the number keys
		Enter a space	press (#=)

Using T9 Text Input

- View alternative words  or 
- Accept a word and add a space press  or 
- Enter a period press 
- View alternative punctuation marks press , then  or  repeatedly

Calling

Calls, phonebook, voice control, call options.

Making calls

Before you can make or receive any calls, you must turn on the phone and be within range of a network. [▶ 7 First-time use.](#)

Networks

When you turn on the phone, it automatically selects your home network if this is within range. If it is not within range, you may use another network, provided your service provider has an agreement that allows you to do so. This is called roaming.

You can select the network you want to use, or you can add a network to your list of preferred networks. You can also change the order in which networks are selected during an automatic search. For all such options [▶ Connect ▶ Mobile Networks.](#)

 *You can call numbers from the call list and the phonebook. [▶ 28 Call list, and ▶ 24 Phonebook.](#) You can also use your voice to make calls. [▶ 30 Voice control.](#)*

Calling

To make a call



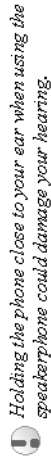

- 1 Enter the area code (if outside your local area) and the phone number.
- 2 ► Call to make the call.
- 3 ► End Call to end the call.

To change the speaker volume during a call

Use the volume buttons on the side of the phone to increase or decrease the speaker volume during a call.



To turn off the microphone during a call

- 1 Press  Mute Microphone, or press and hold  until the icon for muted microphone is displayed.
- 2 Press , or press and hold  again, to resume the conversation.

To turn on speakerphone during a call

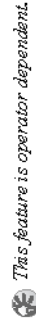

- 1 Enter the area code and the phone number.
- 2 ► Call to make the call.
- 3 Press .
- 4 ► Turn On Speaker.

To turn off speakerphone during a call

- 5 Press .
- 6 ► Turn Off Speaker.

Receiving calls

When you receive a call, the phone rings and Answer? is displayed.

If your subscription includes the Caller ID service and the caller's number is identified, the number is displayed.

If you have saved the number in the phonebook, the name and number are displayed. If you have assigned a picture to a contact, the picture is also

displayed. If the number is a restricted number, Withheld is displayed.

To answer a call





- Open your phone.
- Press the portable handsfree button, if applicable.

To reject a call

- Close your phone.
- ▶ No or quickly press either the upper or lower side volume key twice.

Missed calls

If you have missed a call, Missed Calls; appears in standby indicating the number of missed calls.

▶ Yes to view the missed calls in the call list. If you want to view the missed calls later ▶ No. Use  or  to scroll between the tabs. Use  and  to scroll up and down in each list.

To check your missed calls

- 1 From standby ▶ Calls and scroll right to the missed calls tab.
- 2 To call a number from the list, scroll to the number ▶ Call.

Automatic redialing

The phone redials the number up to ten times or until:

- The call is connected
- You press Cancel
- You receive a call

Automatic redialing is not available for data calls.

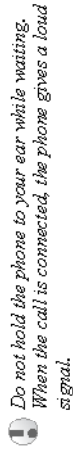

To redial a number

If the connection of the call failed and Retry? is displayed ▶ Yes.

Making international calls

When you make an international call, the + replaces the international prefix number of the country from which you are calling.

Calling

To make international calls

- 1 Press and hold **(0+)** until a + sign appears on the screen.
- 2 Enter the country code, area code (without the leading zero) and phone number ► Call.

Emergency calls

Your phone supports the international emergency numbers, 112, 911, 060, and 08. This means that these numbers can normally be used to make an emergency call in any country, with or without a SIM card inserted, if a GSM network is within range.



In some countries, other emergency numbers may also be promoted. Your service provider may therefore have saved additional local emergency numbers on the SIM card. To view these, ► Phonebook ► Options ► Special Numbers ► Emergency nos..

To make an emergency call

Enter 911, for example, ► Call.

Phonebook



You can save your phonebook information in the phone memory, as contacts, or on the SIM card, as

names and numbers. You can choose which phonebook – contacts or SIM numbers – is shown as default.

For useful information and settings in either of these phonebooks ► Options.

Contacts

You can save up to 510 numbers in your contacts. You can also add pictures, ringtones and personal information, such as email, Web and street addresses, to the contacts.

When you add information to a contact, the information is organized under five tabs. Use , , and  to scroll between the tabs and their information fields.

SIM numbers

On your SIM card, you can save entries as a name with a single number. The number of entries you can save depends on the amount of memory available on the SIM card, see Phonebook ► Options ► Advanced ► Memory Status.



Contact your network operator or service provider for more information.

Contacts or SIM numbers as default phonebook

If you select to use contacts as default, your phonebook will show all information saved in contacts. If you select SIM numbers as default, the phonebook will only show names and numbers saved on the SIM card.

To select contacts or SIM numbers as your phonebook

- 1 ▶ Phonebook ▶ Options ▶ Advanced ▶ My Phonebook
 - 2 Select Contacts or SIM Numbers.
- #### To add a contact
- 1 ▶ Phonebook ▶ New Contact ▶ Add
 - 2 Enter the name directly or press Add and enter the name ▶ OK.
 - 3 Enter the number directly or press Add and enter the number ▶ OK.
 - 4 Select a number type.
 - 5 Scroll between the tabs and select fields to enter more information. To enter symbols, for example, @ in an email address ▶ Symbols and select a symbol ▶ Insert.

- 6 When you have entered the information you want for your contact ▶ Save.

To add a SIM number

If SIM numbers are the default for your phonebook, follow the same steps as adding a contact. You can only add a name and number for SIM numbers in the phonebook.

Pictures and personal ringtones

You can add a picture and a personal ringtone to a phonebook contact. When that person calls, the picture is displayed (provided your subscription supports the Caller ID service) and the ringtone is played.

To add a picture or a personal ringtone to a contact

- 1 ▶ Phonebook then select the contact you want to add a picture or ringtone to ▶ Select ▶ More ▶ View & edit.
- 2 Scroll right to the Picture: tab ▶ Edit. This takes you to Pictures or Sound in the File Manager menu.
- 3 Select a picture or sound. ▶ Save to save the picture or sound.



Calling

Calling from the phonebook

You can call one of the numbers saved for one of your contacts, or a number on your SIM card.

If contacts is the default phonebook, you can choose to call from contacts or from the SIM card. If SIM numbers is the default phonebook, you can only call the numbers on the SIM card.

To call a contact

- 1 ▶ Phonebook. Scroll to, or enter the first letters of the contact you want to call.
- 2 When the contact you want to call is highlighted, press  or  to select a number ▶ Call.

To call a SIM number

- 1 ▶ Phonebook. If SIM numbers is the default phonebook, select the name and number you want to call from the list ▶ Call.
- 2 If Contacts is the default phonebook ▶ Phonebook ▶ Options ▶ SIM Numbers and select the name and number you want to call from the list ▶ Call.

Ask to save

When you end a call, the phone can prompt you to add a phone number or email address to your contacts.

To activate ask to save in contacts

- ▶ Phonebook ▶ Options ▶ Advanced ▶ Ask To Save ▶ On.

Updating the phonebook

When needed, you can easily update and edit any information in your phonebook.

To edit a contact

- 1 ▶ Phonebook and select a contact ▶ More ▶ View & edit.
- 2 Scroll to the relevant tab and edit the information you want to edit ▶ Save.

To edit SIM numbers

- 1 If SIM numbers are your default phonebook
 - ▶ Phonebook and the number you want to edit.
 - If contacts are your default phonebook
 - ▶ Phonebook ▶ Options ▶ SIM Numbers. Select the name and number you want to edit.
- 2 ▶ More ▶ Edit and edit the name and number.

To delete a contact or a SIM number

- ▶ Phonebook and scroll to the contact or SIM number you want to delete, press .

To delete all contacts

- 1 ▶ Phonebook ▶ Options ▶ Advanced ▶ Delete All Contacts.
- 2 ▶ Yes and enter the phone lock code ▶ OK. The default phone lock code is 0000. Names and numbers that are saved on the SIM card are not deleted.

Default items for contacts

You can choose which item – a phone number, email address or a Web address – is displayed first for each contact.

To set the default item for a contact

- 1 ▶ Phonebook and scroll to a contact ▶ More ▶ Default.
- 2 Select the phone number, email address or Web address that you want as the default item.

Copying contacts

You can copy SIM numbers to and from your contacts and the SIM card. Choose if you want to copy all SIM numbers, or a SIM number.

 *When you copy all contacts from the phone, all existing information on the SIM card will be replaced.*

To copy names and numbers to the SIM card

- 1 ▶ Phonebook ▶ Options ▶ Advanced ▶ Copy to SIM.
- 2 Select Copy All or Copy a Number.

To copy SIM numbers to contacts

- 1 ▶ Phonebook ▶ Options ▶ Advanced ▶ Copy from SIM.
- 2 Select Copy All or Copy a Number.

Calling

Sending contacts

You can send contacts using a text or picture message.

To send a contact

- 1 ▶ Phonebook and select a contact ▶ More ▶ Send Contact.
- 2 Select a transfer method.

Checking the memory

With the memory status function in your phonebook, you can check how many positions you have left in the phone memory and SIM memory.

To check the memory

- ▶ Phonebook ▶ Options ▶ Advanced ▶ Memory Status.

Synchronizing contacts

You can back up and synchronize your contacts with a phonebook on the Web. For more information about a phonebook on the web, please contact your service provider.

- 1 ▶ Phonebook ▶ Options ▶ Advanced ▶ Sync. Order ▶ scroll to By first name or By last name ▶ Select.

- 2 If you have more than one account, select which account to use ▶ Select. If you do not have an account in the phone, ▶ 73 To enter the remote synchronization settings.

 *In order to synchronize your contact, you must create a remote synchronization account under Connect ▶ Synchronization.*

Call list

The numbers of the last 30 calls that you have made are saved in the call list. If your subscription includes the Caller ID service and the caller's number is identified, the call list also shows the numbers of answered and missed calls.

In addition to the call list with all numbers, there are also separate lists for dialed, answered and missed calls, organized under tabs.

To call a number from the call list

- 1 ▶ Calls from standby and select a tab.
- 2 Scroll to the name or number you want to call ▶ Call.

To clear the call list

- ▶ Calls and scroll to the tab with all calls ▶ More
- ▶ Delete All.

Speed dialing

You can save the phone numbers that you want to reach easily in positions 1-9 in your phone and on your SIM card. To speed dial with contacts as default phonebook, numbers have to be saved as contacts, and to speed dial with SIM numbers as default phonebook, numbers have to be saved on your SIM card.

To speed dial

- From standby, enter the position number and
- ▶ Call.

To set the position number for speed dialing

- 1 ▶ Phonebook ▶ Options ▶ Speed Dial and scroll to the position to which you want to add a phone number ▶ Add.
- 2 Select a number.

To replace a number in the speed dial list

- 1 ▶ Phonebook ▶ Options ▶ Speed Dial.
- 2 Scroll to the number ▶ Replace. Select a new number for the position.

Voicemail

If your subscription includes an answering service, callers can leave a voicemail message when you cannot answer a call.

Receiving a voicemail message

Depending on your service provider, you are informed that someone has left a message by a text message or by a voicemail icon. Press Yes to read the text message and call the voicemail service to listen to the message.

Calling your voicemail service

You can easily call your voicemail service by pressing and holding **(123)**. If your voicemail number has not already been set, you will be asked if you want to enter the number. ▶ Yes to enter the number. You get the number from your service provider.

Calling

To enter the number to your voicemail service

▶ Messages ▶ Settings ▶ Voicemail Number.

Voice control

With your phone, you can use your voice to:



- Voice dial – call someone by saying the name.
- Activate voice control by saying a “magic word”.
- Answer and reject calls when using a handsfree kit.

You can save approximately 30 recorded words as voice commands in the phone. Each voice command is limited to maximum of five seconds. There is a total of 25 seconds available for voice commands. Voice commands are saved in the phone’s internal memory and cannot be saved on the SIM card. When recording, make sure that you are in a quiet environment and try to use names that are distinct from each other ➤ *3 Tips when recording and using voice commands.*

Before voice dialing

You must first activate the voice dialing function and record your voice commands. An icon appears next to a phone number that has a voice command.

To activate voice dialing and record names

- ▶ Settings ▶ the General tab ▶ Voice Control ▶ Voice Dialing ▶ Activate ▶ Yes and select a contact.
- If the contact has more than one number, use  and  to view the numbers. Select the phone number to which you want to add the voice command. Now you are going to record a voice command such as “John mobile” for the phone number you selected.
- Instructions appear. Lift the phone to your ear, wait for the tone and say the command that you want to record. The voice command is played back to you.
- If the recording sounds ok ▶ Yes. If not ▶ No and repeat step 3.
- To record another voice command for a contact Edit Names ▶ New Voice Cmd. again and repeat steps 2-5 above.

Calling

Caller name

You can choose whether you want to hear the recorded contact name when you receive a call from that contact.

To turn the caller name On or Off

▶ Settings ▶ the General tab ▶ Voice Control ▶ Play Caller Name.

Voice dialing

You can voice dial by saying a pre-recorded voice command. Start voice dialing from standby using the phone, a portable handsfree, or by saying your magic word.

To make a call from the phone

- 1 From standby, press and hold one of the volume buttons.
- 2 Lift the phone to your ear, wait for the tone and say the name you recorded earlier, for example "John mobile". The name is played back to you and the call is connected.

To make a call with a handsfree

From standby, press the handsfree button.

The magic word

You can record a magic word and use it as a voice command to allow totally handsfree access to voice dialing. Instead of pressing and holding a volume button to voice dial, you say the magic word and then one of your recorded voice commands. The magic word is useful when using a car handsfree kit.

 *Choose a long, unusual word or phrase that can easily be distinguished from ordinary background speech.*

 *Using Magic Word may affect battery life.*

To activate and record the magic word

- 1 ▶ Settings ▶ the General tab ▶ Voice Control ▶ Magic Word ▶ Activate.
- 2 Instructions appear ▶ Continue and lift the phone to your ear. Wait for the tone and say the magic word.
- 3 Instructions appear ▶ Continue and select the environments in which you want your magic word to be activated. You can select several alternatives.

Calling

Voice answering

You can answer or reject incoming calls by using your voice, when using a portable handsfree or a car handsfree kit.

 *You cannot use voice answering if you have selected an MP3 file as ringtone.*

To activate voice answering and record voice answer commands

- 1 ▶ Settings ▶ the General tab ▶ Voice Control ▶ Voice Answer ▶ Activate.
- 2 Instructions appear. ▶ Continue and lift the phone to your ear. Wait for the tone and say “Answer”, or another word. If the recording sounds ok ▶ Yes. If not ▶ No and repeat step 2.
- 3 Say “Busy”, or another word ▶ Yes.
- 4 Instructions appear. ▶ Continue and select the environments in which you want voice answering to be activated. You can select several alternatives.

To answer a call using voice commands

When the phone rings, say “Answer” and the call is connected.

To reject a call using voice commands

When the phone rings, say “Busy”.

The call is rejected. The caller is forwarded to voicemail, if activated, or hears a busy tone.

Editing your voice commands

You can keep all your voice commands up to date by re-recording them or deleting the ones you do not use. You can also edit a voice command for a phone number in the phonebook. Select the contact you want to edit a voice command for ▶ More ▶ View & edit. Scroll to the relevant tab and edit your voice command.

To re-record a voice command

- 1 ▶ Settings ▶ the General tab ▶ Voice Control ▶ Voice Dialing ▶ Edit Names.
- 2 Select a voice command ▶ More ▶ Replace Voice.
- 3 Lift the phone to your ear, wait for the tone and say the command.

Tips when recording and using voice commands

If your phone cannot detect speech, one of the following might have happened:

- You spoke too softly – try speaking louder.
- You held the phone too far away – hold it as you do during a call.
- The voice command was too short – it should be around one second long and more than one syllable.
- You spoke too late or too soon – speak immediately after the tone.
- You did not record the voice command when the handsfree was attached – for voice control with a handsfree kit, record when the handsfree is attached.
- You used another intonation – use the same intonation as you did when recording the voice command.

Forwarding calls

If you cannot answer incoming calls, you can forward them to another number, for example, your answering service.



When the Restrict Calls function is activated, some Forward Calls options are not available.

You can choose between the following forward options:

- **Always Forward** – forward all calls.
- **When Busy** – forward calls if you are already on the phone.
- **Not Reachable** – forward calls if your phone is turned off or if you are unreachable.
- **No Reply** – forward calls that you do not answer within a specified time limit (operator-dependent).

To activate call forwarding

- 1 ▶ Settings ▶ the Calls tab ▶ Forward Calls.
- 2 Select a call type and then one of the forward options ▶ Activate.
- 3 Enter the phone number to which you want your calls to be forwarded, or ▶ Lookup to find the contact in your phonebook ▶ OK.

Calling

To deactivate call forwarding

Scroll to the forward option ► Deactivate.

To check all forward options

► Settings ► the Calls tab ► Forward Calls ► Check All.

More than one call

You can handle more than one call simultaneously. For example, you can put an ongoing call on hold, while you make or answer a second call, and then switch between the two calls.

Call waiting service

If the call waiting service is activated, you hear a beep if you receive a second call during an ongoing call.

To activate or deactivate the call waiting service

► Settings ► the Calls tab ► Manage Calls ► Call Waiting.

To make a second call

- 1 ► Hold to put the ongoing call on hold.
- 2 Enter the number you want to call ► Call.



Receiving a second call

When you receive a second call, you can do the following:

- ► Answer to answer the second call and put the ongoing call on hold
- ► Busy to reject the second call and continue the ongoing call
- ► Replace Active Call to answer the second call and to end the ongoing call.

Handling two calls

When you have one ongoing call and one call on hold, you can do the following:

- ► Switch to switch between the two calls.
- Press  ► Join Calls to join the two calls into a conference call.
- Press  ► Transfer Call, to connect the two calls. You are disconnected from both calls.
- ► End Call to end the ongoing call, then press Yes to retrieve the held call.
- ► End Call twice to end both calls.

- You cannot answer a third call without ending one of the first two calls or joining them into a conference call.

Conference calls

In a conference call, you can have a joint conversation with up to five other people. You can also put a conference call on hold and make another call.



There may be additional charges for calls involving multiple parties; contact your service provider for more information.

Creating a conference call

To create a conference call, you must first have one ongoing call and one call on hold. In a conference call you can have a private conversation with one of the participants or release a participant.

To join the two calls into a conference call

Press **Ⓜ** ▶ Join Calls.

To add a new participant

- 1 ▶ Hold to put the joined calls on hold.
- 2 Press **Ⓜ** ▶ Add Call and call the next person you want to include in the conference call.
- 3 Press **Ⓜ** ▶ Join Calls.
- 4 Repeat steps 1-3 to include more participants.

To release a participant

Press **Ⓜ** ▶ Release Part. and select the participant that you want to release from the conference call.

To have a private conversation

- 1 Press **Ⓜ** ▶ Talk To and select the participant that you want to talk to.
- 2 ▶ Join Calls to resume the conference call.

Two voice lines

If you have a subscription that supports alternate line service, your phone may have two voice lines with different phone numbers.



This may be useful if, for example, you want to keep business calls and private calls on separate lines. You select which line you want to use for

Calling

outgoing calls. All outgoing calls are made on this line until you change it. Incoming calls can still be received on either line.

You can change the names of the lines, and have different settings for each line, for example, different ringtones.

To select a line

▶ Settings ▶ the Calls tab and select line 1 or 2.

To change the name of a line

▶ Settings ▶ the Display tab ▶ Edit Line Names and select one of the lines to edit the name.

My numbers

You can view, add and edit your own phone numbers.

To check your phone numbers

▶ Phonebook ▶ Options ▶ Special Numbers ▶ My Numbers and select one of the options.

Accept calls

With the accept calls service, you can choose to receive calls only from certain phone numbers.

Other calls are automatically rejected by a busy tone. If the call forward option When Busy is activated, calls are forwarded instead of rejected by a busy tone. The phone numbers of calls you have rejected are saved in the call list.

To add numbers to the accepted callers list

1 ▶ Settings ▶ the Calls tab ▶ Manage Calls

▶ Accept Calls ▶ Only From List.

2 ▶ New ▶ Add. This takes you to phonebook look up. Select contacts from your phonebook.

To accept all calls

▶ Settings ▶ the Calls tab ▶ Manage Calls ▶ Accept Calls ▶ From All.

Restricted dialing

 You can use the restrict calls service to restrict outgoing and incoming calls. This may be useful, for example, when you are abroad. To use this service, you need a password which you get from your service provider

 *If you forward incoming calls, you cannot activate some Restrict Calls options.*

 *This feature is operator dependent.*

The following calls can be restricted:

- All outgoing calls – All Outgoing
- All outgoing international calls – Outgoing Intl.
- All outgoing international calls except to your home country – Outgoing Intl Roam
- All incoming calls – All Incoming
- All incoming calls when you are abroad (when roaming) – Inc. When Roaming.

To activate or deactivate a call restriction

- 1 ▶ Settings ▶ the Calls tab ▶ Manage Calls ▶ Restrict Calls and select an option.
- 2 Select Activate or Deactivate.

- 3 Enter your password ▶ OK.

Fixed dialing

 The fixed dialing function allows calls to be made only to certain numbers saved on the SIM card. Fixed dialing requires a SIM card that allows fixed numbers to be saved. The fixed numbers are protected by your PIN2.

 *Calls to international Emergency nos. can still be made, even when the fixed dialing function is activated.*

 When fixed dialing is activated, you cannot view or manage any phone numbers that are stored on the SIM card.

Partial numbers can be saved. For example, saving 0123456 allows calls to be made to all numbers starting with 0123456.

Calling

To activate or deactivate fixed dialing

- 1 ▶ Phonebook ▶ Options ▶ Special Numbers ▶ Fixed Dialing and select Activate or Deactivate.
- 2 Enter your PIN2 ▶ OK and then ▶ OK again to confirm.

To save a fixed number

- ▶ Phonebook ▶ Options ▶ Special Numbers ▶ Fixed Dialing ▶ Fixed Numbers ▶ New Number ▶ Enter PIN2 ▶ enter the information.

Call time and cost

 During a call, the duration of the call is shown on the screen. If you subscribe to cost information, you can check the duration of your last call, outgoing calls and the total time. You can also check the cost of your last call and the total cost of your calls.

 *If you subscribe to cost information, you must enter your PIN2 to reset the cost or time counter.*

 *This feature is operator dependent.*

To check the call time

- ▶ Settings ▶ the Calls tab ▶ Time & Cost ▶ Call Timers.

To reset the call time meter

- ▶ Settings ▶ the Calls tab ▶ Time & Cost ▶ Call Timers ▶ More and select Reset total or Reset Outgoing.

To check the call cost

- ▶ Settings ▶ the Calls tab ▶ Time & Cost ▶ Call Costs.

To reset the call cost meter

- ▶ Settings ▶ the Calls tab ▶ Time & Cost ▶ Call Costs ▶ More ▶ Clear Total Cost.

Setting the call cost

You can use the tariff function to specify the price per call unit. If you do not specify a price per call unit, the number of call units appears.

To enter the price per call unit

- 1 ▶ Settings ▶ the Calls tab ▶ Time & Cost ▶ Call Costs ▶ More ▶ Set Rate.
- 2 Enter your PIN2 ▶ OK.
- 3 ▶ Currency and enter the code for the currency you want, (for example GBP for Pounds Sterling) ▶ OK.
- 4 ▶ Units and enter the price per call unit ▶ OK. To enter a decimal point, press **(.)**.

Credit limit for calls

You can enter a total amount of money that can be used for making calls. When the amount reaches zero, no more calls can be made. Please note that the credit limit is only an estimated value.

To set a credit limit

- 1 ▶ Settings ▶ the Calls tab ▶ Time & Cost ▶ Call Costs ▶ More ▶ Set Credit and enter your PIN2 ▶ OK.
- 2 Select Limited or Unlimited. If you select Limited, enter an amount ▶ OK.

Call priority service

You can request a certain priority when you make a call, if your subscription supports the call priority service.



The priority levels are defined by your service provider and are normally within the range of 0-4, where 0 is the highest priority.

To check or change your standard priority level

- 1 ▶ Settings ▶ the Calls tab ▶ Manage Calls ▶ Default Priority.
- 2 The network sends available priority levels. Select a priority level.

Calling

To change the priority for one call

- 1 Enter the phone number you want to call.
- 2 ▶ More ▶ Call Priority and select a priority. The number is called.

Closed user groups

 The closed user group function is a way of lowering call costs. If you subscribe to closed user groups it is cheaper, on some networks, to make calls within a call group. You can save ten groups.

 *This feature is operator dependent.*

To add a group

- 1 ▶ Settings ▶ the Calls tab ▶ Manage Calls ▶ Closed Groups ▶ Edit List ▶ New Group ▶ Add
- 2 Enter the name of the user group ▶ Continue.
- 3 Enter the index number ▶ Save. You get the index number from your service provider.

To call outside a closed user group

▶ Settings ▶ the Calls tab ▶ Manage Calls ▶ Closed Groups ▶ Open Calls ▶ On. When Off is selected, it is only possible to call within the group.

Additional calling functions

Tone signals

You can use telephone banking services or control an answering machine by sending tone signals (also known as DTMF tones or touch tones) during a call.

- To send the tones, press the keys **(1-9*)** - **(0**)**, **(*)** or **(#)**.
- To clear the screen after the call is finished, press **(C)**.
- To turn the tones on or off during a call, press **(T)** and select **Turn Off Tones** or **Turn On Tones**.

Notepad

You can use the phone to make a note of a phone number during a call. When you end the call, the number remains on the screen. ▶ Call to call the number. ▶ More ▶ Save Number and select a contact to save the number. If you want to create a new contact and save the number ▶ New Contact.

Showing or hiding your number

If your subscription supports the Calling Line Identification Restriction (CLIR) service, you can hide your phone number when making a call. You

can do this per call, or select this as a default setting. ▶ More in standby to quickly change this default setting.

To show or hide your phone number

- 1 Enter the phone number you want to call.
- 2 ▶ More and select Hide Number or Show Number.

To always show or hide your phone number

- 1 ▶ Settings ▶ the Calls tab ▶ Show or Hide No.
- 2 Select Show Number, Hide Number or Network Default.

Groups

You can create a group of numbers. By doing so, you can send text messages and picture messages to several recipients at the same time
 ➔ 42 Messages.

To create a group of numbers

- 1 ▶ Phonebook ▶ Options ▶ Groups ▶ New Group ▶ Add.
- 2 Enter a name for the group ▶ Continue.

- 3 ▶ New Number ▶ Add to find the contact in your phonebook.
- 4 Select a number from the contact.
- 5 Repeat steps 3-4 to add more numbers to the group. ▶ Done to save the group.

Business cards

You can add your own business card to the phonebook. You can exchange business cards between your phone and another similar phone, or a PC. You can exchange business cards using a cable or a text/picture message.

To add your own business card

- ▶ Phonebook ▶ Options ▶ My Business Card and enter the information for your business card
- ▶ Save.

To send your business card

- ▶ Phonebook ▶ Options ▶ My Business Card
- ▶ Send My Card and select a transfer method.

To receive a business card

When you receive the business card ▶ Yes ▶ Save to save the business card in the phonebook.

Messages

Messages

Text messaging, picture messaging, email, My friends, messaging glossary.



Your phone supports various messaging services – text messaging, picture messaging, email and My Friends. Please contact your service provider for details on which services you can use. On www.SonyEricsson.com/support you will find Getting Started Guides that will help you to get started with all the various messaging services.

Text messaging

Text messages are sent via SMS (Short Message Service). Text messages can contain pictures, animations, melodies and sound effects. Text messages can be sent to one person, several recipients or to a group of recipients that you have saved in the phonebook ➤ 41 Groups.



If you send a text message to a group, you are charged for each member of that group.

Before you start

First make sure that the number of your service center is set. The number is supplied by your

service provider and is usually saved on the SIM card.

To set the service center number

- 1 ▶ Messages ▶ Settings ▶ Text Message ▶ Service Center. If the service center number is saved on the SIM card, it is shown in the list.
- 2 If there is no number in the list ▶ Add and enter the number, including the international “+” sign, and country code (by pressing and holding **(0*)**) ▶ Save.

Sending text messages

For information about entering letters

- 15 Entering letters.



Some languages-specific characters use more space. For some languages you can deactivate National Chars. to save space. ➤ 17 Options when entering letters.

To write and send a text message

- 1 ▶ Messages ▶ Write New ▶ Text Message.
- 2 Write your message ▶ Continue. If you want to save the message for later, press **(S)** ▶ Yes to save it in Drafts.

Messages

- ▶ Enter Phone No. and enter the recipient's phone number, or ▶ Phonebook LookUp to retrieve a number or a group from the phonebook. To enter an email address ▶ Enter Email Addr.. A list below the send options shows the last 10 recipients. You can also select a recipient from this list ▶ Send.

To insert an item in a text message

- ▶ Messages ▶ Write New ▶ Text Message.
- ▶ While writing your message ▶ More ▶ Add Item.
- Select: Picture, Sound Effect, Melody, Animation, Templates or Picture (other).
- Select an item.

To insert a symbol in a text message

- ▶ Messages ▶ Write New ▶ Text Message.
- ▶ While writing your message ▶ More ▶ Add Symbol.
- Select an item.

Formatting text

You can change the style, size and alignment of the text, and create new paragraphs.

To format the text in a text message

- ▶ Messages ▶ Write New ▶ Text Message.
- ▶ While writing your message ▶ More ▶ Text Format. Then select Text Size, Text Style, Alignment or New Paragraph.
- Select a text format.

Receiving text messages

When you receive a text message, a message alert sounds and a text is displayed that informs you that a text message has been received.

- Open the phone ▶ Yes to read the text message or ▶ No if you want to read the message later.

While reading the text message you can, for example, go to a Web address found in the text message, save a picture found in the text message or listen to a sound inserted in the text message.

When you have read the text message ▶ More to view a list of options. Press  to close the text message.

Calling a number in a text message

You can call a phone number that appears in a text message.

Messages

To call a number in a text message

Select the phone number ► Call.

Saving and deleting text messages

Text messages are saved in the phone memory. When the phone memory is full, you must delete messages or move them to the SIM card to be able to receive new messages. Messages that you have saved on the SIM card remain there until you delete them.

To save a message to the SIM card

► Messages ► Inbox ► More ► Save Message
► Saved Items.

To save an item from a text message

- 1 Select the phone number, Web address, picture or sound that you want to save in the message ► More.
- 2 If you have selected to save a phone number ► Use ► Save Number. If you have selected a Web address ► Save Bookmark, a picture ► Save Picture, a sound ► Save Sound.

Long messages

The number of characters that a text message can contain depends on the language you are writing in. You can send a longer message by linking two or more messages. Please note that you are charged for each of the messages linked in a long message. You may not receive all parts of a long message at the same time.

 *Check with your service provider for the maximum number of messages that can be linked.*

To turn long messages on

► Messages ► Settings ► Text Message ► Max. Msg Length ► Max. Available.

Templates

If you have one or more messages that you send often, you can save these as templates. There are predefined templates in your phone, but you can also create your own templates.

To create a template

- 1 ► Messages ► Templates ► New Template
► Add ► Text
- 2 Write the message ► OK.

- 3 Enter a title for the message ► OK.

Message options

You can set a default value for several message options or choose the settings each time you send a message. You can, for example, select to request a reply to a sent message, select what type of text message you want to send or set how long a message should be valid. For details about the message options ► *56 Messaging glossary*.

To set a default text message option

► Messages ► Settings ► Text Message and select an option.

To set a message option for a specific message

- 1 When you have selected a recipient to send your text message to ► More ► Advanced.
 - Edit and select a new setting.
- 2 Select the option that you want to change.
 - Done when you have changed the options.

To check the status of a sent message

► Messages ► Sent Messages and select a text message ► View ► More ► View Details.

Picture messages

Picture messages can contain text, pictures, video clips, camera pictures, and sound recordings and are sent via MMS (Multimedia Messaging Service). You must have a subscription that supports MMS, and the receiver of the picture message must also have support for MMS. Picture messages can be sent to a mobile phone and an email account. You can send your business card as an attachment in a picture message.

Before you start

Before sending a picture message, make sure that:

Messages

- 1 The address to your message server is set
▶ Messages ▶ Settings ▶ MMS ▶ Message Server.
- 2 You have entered the correct settings
▶ Messages ▶ Settings ▶ MMS ▶ Internet Profile. Select a profile or New Profile. To create an Internet profile, ▶ *Go Setting up Internet and email*. You can also download all the settings you need automatically from your service provider or from www.SonyEricsson.com/support.

Writing and sending picture messages

When composing a picture message, you select from different items to format your message. The different items are: Picture, Text, Sound, Video, Camera Picture, Video Clip and Sound Recording.

Before sending a picture message, you can select from different options to adjust and enhance your message. You can, for example, preview the entire message or a single page in the message, change the timing for items in the message and add or replace items to be sent in the message. For details about options ▶ *5.6 Messaging glossary*.

To write and send a picture message

- 1 ▶ Messages ▶ Write New ▶ MMS ▶ Add to view a list of items to add to your message. Select an item.
- 2 ▶ Add to add more items to the message. You can view and select options to enhance the message by highlighting items in the message and pressing the left selection key.
- 3 When you have finished writing your message ▶ More ▶ Send.
- 4 ▶ Enter Phone No. and enter the recipient's phone number, or ▶ Phonebook LookUp to retrieve a number or a group from the phonebook. To enter an email address ▶ Enter Email Addr.. A list below the send options shows the last 10 recipients. You can also select a recipient from this list. ▶ Send.

To make a call while writing a picture message

- 1 While writing your message ▶ More.
- 2 ▶ Make a Call and enter or retrieve a phone number ▶ Call. You return to the message.
- 3 To end the call ▶ More ▶ End Call.

Messages

To set a default message option
▶ Messages ▶ Settings ▶ MMS and select one of the options.

Additional send options

You can request a read receipt, a delivery report and set a priority for a specific message. You can also add more recipients to the message. For details about the additional send options ➔ *5.6 Messaging Glossary*.



Some sending options are operator dependent.

To select additional send options

- 1 When you have entered the recipient's phone number ▶ More.
- 2 Select Add Recipient or Recipients to add more recipients, or Advanced to select an additional send option, or Add Attachment to attach a picture.

Receiving picture messages

When you receive a picture message, a message alert sounds and a text is displayed that informs you that a message has been received.

- ▶ Yes to read or play the message. Press Stop to stop. When you have read the message ▶ Reply to reply immediately or ▶ More to view a list of options. Press (⏏) to close the message.



You can select a message from the list of messages and press (⏏) to delete the entire message.

Save items from a picture message

When you have viewed a picture message, you can save items from the message. ▶ More ▶ Save Items and select an item from the list that appears.

Delete picture messages

Picture messages are saved in the phone memory. When the phone memory is full, you must delete messages to be able to receive new messages.

To delete a message

- 1 ▶ Messages and select a folder.
- 2 Select the message ▶ More ▶ Delete.

To delete several messages

- 1 ▶ Messages and select a folder.
- 2 Select a message ▶ More ▶ Mark Several.

Messages

- 3 Scroll and select more messages by pressing Mark or Unmark.

To delete all messages

- 1 ▶ Messages and select a folder.
- 2 ▶ More ▶ Delete All Msgs.

Templates

You can base your message on one of the predefined templates. You can also add new templates.

To use a predefined template for a picture message

- 1 ▶ Messages ▶ Templates and select a template
- 2 ▶ Use ▶ MMS. ▶ Add to make changes or add new items.
- 3 ▶ More ▶ Send to send the message.

Automatic download

You can select how you want your picture messages to be downloaded.

- ▶ Messages ▶ Settings ▶ MMS ▶ Auto Download to view the following:

- Always – your phone automatically downloads messages to your phone as soon as they come to your service provider's server. This is default.
- Ask in Roaming – you will be asked if you want to download messages when you are using another network than your service provider's.
- Never in Roam – the messages are never downloaded when you are using another network than your service provider's.
- Always Ask – You will always be asked if you want to download messages, regardless of used network.
- Off – New messages appear in the inbox as icons. Select the message ▶ View ▶ Yes to download.

Email

You can use your phone to send and receive email messages. Please note that you need a subscription that supports data transmission. For more information, contact your service provider.

Before you start

First make sure that:

- You have set up a data account, ▶ *69 Entering Internet and email settings.*

Messages

- You have set up and selected an email account.

Email account settings

An email account specifies, for example, the server that is used for your email messages. There are three ways to create an email account:

- Download settings from Internet.
- Send a request in a text message
- Create an email account manually

Receiving settings

At www.SonyEricsson.com/support you can get support on how to enter your email settings. Some service providers provide configurator services and also a service with which you can request settings in a text message. Contact your service provider for information about your settings.

To create an email account manually

- 1 ▶ Messages ▶ Email ▶ Settings ▶ New Account.
- 2 Enter a name for the account, for example "Home" or "Office" ▶ Connect Using.
- 3 Select the data account that you want to use with this email account.

- 4 Enter the rest of the settings, some of which are optional. To enter the settings, scroll to the setting ▶ Select. Enter the information ▶ OK to confirm. Repeat this for each required setting. You use the same email settings in your phone as in your PC email program. If you do not have an email service, contact your service provider to get all the necessary settings. For details about the settings ▶ *36 Messaging glossary*.

Default email account

If you have both an office and a home email account, you can set one of them as default:

- ▶ Messages ▶ Email ▶ Settings and select an account.

Writing and sending email messages

When writing and sending your email message, you can select from several options to accompany your message. For details about the options

- ▶ *36 Messaging glossary*.
- ▶ Messages ▶ Email ▶ Inbox ▶ Send & Receive (when Inbox is empty) or ▶ Messages ▶ Email

Messages

- ▶ Inbox ▶ More ▶ Send & Receive to download new messages.



The number of email messages that can be saved depends on memory left in the phone. All email messages are also saved on your email server, and you can view both older and newer messages on the server.

To write and send an email message

- 1 ▶ Messages ▶ Email ▶ Write New.
- 2 Write the subject for your message ▶ OK and then the text ▶ OK.
- 3 ▶ Enter Email Addr. to enter an email address or ▶ Phonebook Lookup to retrieve an address from your phonebook.
- 4 ▶ Send to send your email message or ▶ More to view a list of options for your message.

To receive and read email messages

- 1 ▶ Messages ▶ Email ▶ Inbox ▶ More ▶ Send & Receive to download new messages.
- 2 Select a message to read it.

To reply to an email message

- 1 Open the email message ▶ Reply.
- 2 Write your message ▶ More to view options for the message.

- 3 ▶ Send to send the message.

To save an email address or a phone number in an email message

- 1 Select the email address or phone number that you want to save ▶ More.
- 2 If you have selected to save an email address ▶ Use ▶ Save Email. If you have selected to save a phone number ▶ Save Number.

To save an email message

- 1 Open the email message ▶ More ▶ Save Message.
- 2 The message is saved in Saved Messages in the Email menu.

To save several email messages

- 1 ▶ Messages ▶ Email.
- 2 Select a message ▶ More ▶ Mark Several.
- 3 Scroll and select more messages by pressing Mark or Unmark.
- 4 ▶ More ▶ Save Messages.

To delete an email message (POP3 users)

- 1 ▶ Messages ▶ Email ▶ Inbox and select the message ▶ More.
- 2 Select Mark for Deletion. The message is deleted the next time you connect to your email server.
- 3 If you want to delete several messages ▶ Mark Several. Scroll and select more messages by pressing Mark or Unmark. ▶ More ▶ Mark for Deletion.

 POP3 (Post Office Protocol 3) is the most recent version of a standard protocol for receiving email in which email is received and held for you by your Internet server. Periodically, you check your mailbox on the server and download any mail.

To delete an email message (IMAP4 users)

- 1 ▶ Messages ▶ Email ▶ Inbox and select the message ▶ More.
- 2 ▶ Mark for Deletion. The message is marked for deletion on the server. If you want to delete several messages ▶ Mark Several. Scroll and select more messages by pressing Mark or Unmark. ▶ More ▶ Mark for Deletion.

- 3 ▶ More ▶ Clear Inbox. The messages are deleted the next time you connect to your email server.

 IMAP 4 (Internet Message Access Protocol Version 4) is a standard protocol for accessing email from your local server. Email is received and held for you by your Internet server. You can view just the heading and the sender of the letter and then decide whether to download the mail.

Messages



My Friends

The My Friends function gives you more options when messaging. You can create a list of favorite contacts, either from the phonebook or from the My Friends server. You can see which of your contacts are online and what mood they are in. To see contacts online, they have to be connected to the My Friends server. You can also send and receive instant messages and join community chats. Please contact your service provider for information about your subscription and My Friends settings.

My Friends contacts

You can add contacts from the phonebook to a list of contacts in My Friends, even if you do not have a My Friends account and are not connected to the My Friends server. You can then quickly access your favorite contacts and choose how you want to communicate with them.

Log in to the My Friends server

You can select to log in to your My Friends server each time you want to send or receive instant messages, or you can be logged in automatically

when you turn on your phone. You can edit the settings for your My Friends account. To set automatic log in and edit your account settings you have to be logged out from the My Friends server.

To log in to your My Friends server

▶ Messages ▶ My Friends ▶ Myself ▶ Log In.

To set automatic log in

▶ Messages ▶ My Friends ▶ Myself ▶ More
▶ Accounts ▶ Edit ▶ Auto-Login ▶ On.

To edit the My Friends account

▶ Messages ▶ My Friends ▶ Myself ▶ More
▶ Accounts and edit your settings. If you have more than one account, you will first have to select the account before you edit the settings.

List of contacts

You can create a list of contacts - people you want to send messages to on a regular basis. You can add contacts from your phonebook or from your My Friends server.

Messages

To add a contact from the *phonebook*

- 1 ▶ Messages ▶ My Friends ▶ More ▶ Add Contact ▶ From Contacts.
Enter the first letter of the contact and then select a contact.
- 3 When you have selected a contact, you can choose to subscribe to status information for that contact. To subscribe ▶ Yes and follow the instructions that appear. ▶ No if you do not want to subscribe.

To add a contact from a *network server*

- ▶ Messages ▶ My Friends ▶ More ▶ Add Contact
- ▶ From Server and follow the instructions that appear.

Status

You can view the status of your contacts and choose to show your own status to others. You can also change your own status with the help of the following options:

- **Picture** – Select a picture from Pictures or take a picture with the camera. You can change or remove pictures.
- **About Me** – Write a short text about yourself.

- **Availability** – Select what to show others when you are online, Available, Busy, Away, or invisible. If you select invisible, you will appear as offline to others.
- **Mood** – Select a mood from the list.
- **Show My Status** – ▶ To All if you want to show full status to friends but limited status to others, and ▶ Only To contacts if you want to show full status to friends but nothing to others.
- **Username:** – view your username.

To view the status of a contact

- ▶ Messages ▶ My Friends and select a contact
- ▶ More ▶ View Status.

To change your own status

- ▶ Messages ▶ My Friends ▶ Myself ▶ More
- ▶ Change Status and edit your status according to the options.

To send a message to My friends

- 1 ▶ Messages ▶ My Friends and select a contact.
- 2 If the contact is linked to your phonebook ▶ More ▶ Send Instant Msg. ▶ Send. If not, select the contact ▶ Send IM.

Messages

Receiving a message

When you receive a message, a message alert sounds or an icon appears in the status bar.

Contact list

You can create nicknames for the contacts in your list that are connected to the My Friends server. You can also link a contact to the phonebook, and get access to information saved in the phonebook.

To enter a nickname

- 1 ▶ Messages ▶ My Friends, and select a contact.
- 2 ▶ More ▶ Manage Contact ▶ Edit Nickname.
- 3 Enter the nickname for that contact ▶ Save.

To link a contact to the phonebook

- 1 ▶ Messages ▶ My Friends and select a contact.
- 2 ▶ More ▶ Manage Contact ▶ Link to Contacts and select the contact in phonebook that you want to create a link to.

Strangers

A stranger is someone that is not in your list of contacts. An icon indicates a message from a stranger. You can add the stranger to your list of contacts, or you can block the stranger. If you do

not perform any action, the stranger disappears when you log out from the My Friends server.

To add a stranger to the list of contacts

- ▶ Messages ▶ My Friends and select the stranger
- ▶ More ▶ Add As Contact

Blocking contacts and strangers

You can block a contact or stranger so that they cannot view your status or send you messages.

To block or unblock a contact

- 1 ▶ Messages ▶ My Friends and select a contact
- 2 ▶ More ▶ Manage Contact. Select Block Contact or Unblock Contact

To block a stranger

- ▶ Messages ▶ My Friends and select the stranger
- ▶ More ▶ Block User.

Chatroom

A chatroom can be started by your service provider, by an individual My Friends user or by yourself. You can save chatrooms either by saving

Messages

a chat invitation or by searching for a specific chatroom.

To receive a chat invitation

- 1 When a message alert sounds and the message New chat invitation received. is displayed select View to view the invitation or Discard to discard the invitation.
- 2 If you have selected to view the invitation, and want to join the chat ► Join Chat. If you want to discard the invitation now ► More ► Discard Invitation. If you want to save the chat invitation ► View ► More ► Save Chatroom.

To search for a chatroom

- 1 ► Messages ► My Friends ► More ► Add Chatroom ► No.
- 2 Enter your search criteria in one or several of the fields ► Search.
- 3 When you have found the chatroom you want to save ► Add.

To join a chatroom

- Messages ► My Friends and select a chatroom
- Join Chat.

To start a chatroom

- 1 ► Messages ► My Friends ► More ► Start chatroom..
- 2 Select contacts to invite to the chatroom from your list of contacts ► Continue.
- 3 Enter a short invitation text to the chatroom ► Continue ► Send.

Online contact alert

You can select to be notified when a contact comes online. The notification is indicated by an icon. When you log off, or when the contact has come online, the notification is cleared.

To set an online contact alert

- Messages ► My Friends and select a contact
- More ► Manage Contact ► Alert Me.

Area information

Area information is a type of text message (for example, a local traffic report) that is sent to all subscribers within a certain network area. When you receive an area information message, the message automatically appears on the screen. Press

Messages

Save to save the message in your inbox, or Discard to delete the message.



Please consult your service provider for more information about area information.

To turn area information on or off

► Messages ► Settings ► Area Info ► Reception.

Cell information

The cell information channel is used by some service providers to send messages about a certain network area to their subscribers within that area.

To turn on the cell information channel

► Messages ► Settings ► Area Info ► Cell Information.

Messaging glossary

Options and settings for text, picture and email messages are listed below:

- **Accept Messages** – select which messages you want to accept and download.

- **Add Attachment** – add, for example, pictures, sounds, themes, video clips, business cards or recordings to a message.
- **Check Interval** – select how often you want the phone to connect to your email server and check for incoming email messages.
- **Connect Using** – select which data account to use when connecting to a specific email account.
- **Copy Outgoing** – select if you want email messages sent from your phone also to be sent to an email address of your choice. This way, your sent messages are copied and can be saved for future reference.
- **Creation Mode** – select settings for allowable content in picture messages. Some content in picture messages might be difficult for the recipient to view.
- **Delivery Report** – request a status report to check if a message has been delivered.
- **Download** – select whether to receive headers and text or headers only in email messages.
- **Incoming Port** – if needed, change the number of the port used by the protocol you are using.

Messages

- **Incoming Server** – enter the name or IP address of the service provider for incoming email messages. For example, mail.server.com or 10.1.1.1.
- **Mailbox** – enter a username for your email account.
- **Outgoing Port** – if needed, change the number of the port used by the SMTP protocol.
- **Outgoing Server** – enter the name or IP address of the SMTP server to be able to send email messages.
- **Password** – enter a password for your email account. Your service provider may alternatively request a password on connection.
- **Picture** – add or replace a picture from your Pictures folder.
- **Preview** – view the entire picture message before sending it.
- **Preview Page** – view a specific page in the picture message, without having to play the entire message.
- **Protocol** – select POP3 or IMAP4.
- **Request Reply** – include a reply request if you want the recipient of your message to reply.
- **Saved in Drafts** – save the email message in the Drafts folder.
- **Save in Outbox** – save the email message in the Outbox folder.
- **Set Priority** – set the message priority, select High, Normal or Low.
- **Signature** – select if you want to add your business card to your email messages.
- **SMS Type** – the phone supports different types of messages. Your service provider may offer the facility of converting a text message into a format (email or fax, for example) that suits the equipment that is going to receive the message.
- **Sound** – add or replace a sound from your Sounds folder.
- **Status Request** – request a status report to check if a message has been delivered.
- **Subject** – write a title for your message.
- **Timing** – set how many seconds you want an item in a message to be displayed.
- **Validity Period** – if your message cannot be delivered, for example, if the recipient has turned off the phone, your service center can save the message to send it later.
- **Video** – add or replace a video clip from your Videos folder.

Imaging

Imaging

Camera, video recorder, pictures, screen saver.

Camera and video recorder

Your phone has a digital camera and a digital video recorder. You can easily switch between the camera and the video recorder by pressing  or . You can also press More and select Switch to Video or Switch to Photo.



You can take pictures, record video clips, view them and send them as email attachments or in picture messages via MMS (Multimedia Messaging Service). To do this, you need a subscription that supports these services. Please check with your service provider.



You can also use a picture as a screen saver or as wallpaper, or save it together with a contact in your phonebook so that the picture appears when that person calls  25 To add a picture or a personal ringtone to a contact.

Before you start

The phone that you are sending the picture or video clip to needs to support data transmission and

picture messaging in order to receive and show the picture or video clip.

Before you send a picture or video clip using MMS make sure that:

- The Internet settings are entered in your phone,  *29 Setting up Internet and email.*
-  These settings may have been already pre-loaded in your phone. Contact your service provider for more information.

Before you send a picture or video clip using email make sure that:

- You have entered settings for a data account and for an email account in your phone.

To take pictures

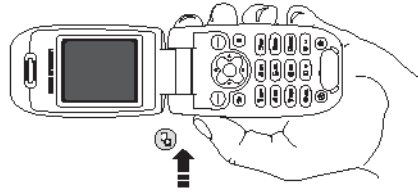

- 1 Press and hold to activate the camera or Camera.
- 2 Press to switch to camera if video recorder is activated. Capture to take a picture.

To record video clips

- 1 Press and hold to activate the video recorder or Camera. You record video clips with the phone held in a vertical position.
- 2 Press to switch to video recorder if the camera is activated. Record to start the recording.

To use the zoom

Press to zoom in on the subject if the Picture Size is set to Small or Medium. Check your Picture Size setting by More Picture Size.

To adjust brightness

Use the volume buttons on the side of the phone to increase or decrease brightness.

Rotate pictures

If a picture is taken in landscape format, it can be rotated. To send pictures in a picture message, the picture must be in portrait format.

To rotate a picture

When the picture is taken Rotate and repeat if necessary.

Imaging

Camera options

When the camera is activated press ► More to view more options.

 *All phones that support pictures can receive the picture size 160x120. Some phones that support pictures cannot receive picture sizes larger than 160x120.*

Options before you take a picture:

- View All – view all your pictures.
- Switch to Video – switch to video recorder to record video clips.
- Picture Size – choose between Large (640x480), Medium (320x240) and Small (160x120).
- Night Mode – enhance picture quality with longer exposure time.
- Effects – select different effects for your picture.
- Frames – add a frame to your picture.
- Picture Quality – select quality for your picture.
- Self-Timer – the picture is taken a few seconds later.
- Default Name – Change the default name for your pictures. When changed, all pictures taken will have the new default name.

Video options

When the video recorder is activated ► More to view more options.

- View All – view all your video clips.
- Switch to Photo – switch to the camera to take pictures.
- Video Size
- Night Mode – enhance picture quality with longer exposure time.
- Effects – select different effects for your video clip.
- Video Length – Set the length for your video clip.
- Default Name – Change the default name for your video clips. When changed, all video clips recorded will get the new default name.

Take a self-portrait

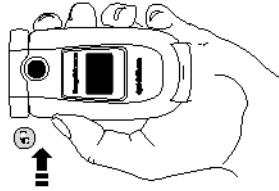

- 1 Hold the phone as shown in the illustration.
- 2 Press and hold **[C]** on the side of the phone to activate the camera. Press **[C]** again to take the picture.

Saving pictures and video clips

When you have taken a picture or recorded a video clip, the phone automatically saves it in File Manager.

Sending pictures and video clips

When you have taken a picture or recorded a video clip, you can send them instantly in a picture message. To exchange pictures and video clips using other transfer methods ➔ *62 Exchanging pictures*.

To take and send a picture

- 1 Activate the camera. Press **[C]** to switch to camera if the video recorder is activated.
- 2 ▶ Capture ▶ Send and create your picture message.

To record and send video clips

- 1 Activate the camera. Press **[C]** to switch to video recorder if the camera is activated.
- 2 ▶ Record to start the video recording ▶ Stop to end the recording.
- 3 When you have finished your recording, select Play to view the video clip or Send and create your picture message to send the video clip.

Pictures

Your phone comes with a number of pictures. You can delete the pictures that come with your phone if

Imaging

you, for example, want to free memory. All pictures are saved in File Manager ▶ Pictures. You can:

- Have a picture as wallpaper and as screen saver.
- Assign a picture to a contact in the phonebook.
▶ *25 To add a picture or a personal ringtone to a contact.*
- Exchange pictures using picture messages or email.

Animations

You can save animations in your phone. Animations are handled like pictures.



Handling pictures











You can add, edit, or delete pictures in File Manager. The number of pictures that you can save depends on the size of the pictures. File types supported are GIF, JPEG, WBMP, PNG and BMP.

To view your pictures

- 1 ▶ File Manager ▶ Pictures.
- 2 The pictures are shown in thumbnail view. To get a full view ▶ View.

Editing pictures

When editing pictures press , , , or use the keys as follows:

- | | | | |
|---|-------------------------|---|--------------|
|  | exit the picture editor |  | undo |
|  | left up |  | right up |
|  | left |  | rotate tool |
|  | right down |  | right down |
|  | select tool |  | select color |

To edit and save a picture

- 1 ▶ File Manager ▶ Pictures and scroll to the picture you want ▶ More.
- 2 ▶ Use ▶ Edit. You can now start to edit the picture. To edit pictures taken with the camera, you must select 160x120 or 320x 240 as picture size ▶ More ▶ Save Picture to save the picture.

Exchanging pictures

You can exchange pictures using a cable, picture messages or email. Please note that you are not

allowed to exchange copyright-protected material.
For more information on sending pictures in messages ➤ 42 Messages.

To send a picture

- 1 ▶ File Manager ▶ Pictures and scroll to the picture you want ▶ More ▶ Send.
- 2 Select a transfer method.

To receive and save a picture

- 1 Open the message in which you received the picture.
- 2 ▶ More ▶ Save Picture.

Screen saver and wallpaper

The phone has a screen saver, which is activated automatically when the phone has been in idle mode for a few seconds. After a few more seconds, the screen saver changes to sleep mode, to save power. If you have a picture as wallpaper, this picture is shown in standby mode.

To use a picture as a screen saver

- 1 ▶ Settings ▶ the Display tab ▶ Screen Saver ▶ Picture.
- 2 Select the picture you want to use as screen saver.

To set a picture as wallpaper

- ▶ Settings ▶ the Display tab ▶ Wallpaper ▶ Picture and select the picture you want to use as wallpaper.

Entertainment

Entertainment

Media player, sounds, themes, games.

Media player

The media player works as a music player and video player all in one. You can play music and video clips that you receive in a picture message, or that you download to your phone. The following are supported by the media player: MP3, MP4, 3GP and WAV (with 16 kHz as maximum sample rate).

You can also stream music and videos from Web sites. When streaming, links have to be 3GPP compatible.

 *Holding the phone close to your ear when listening to music and video clips could damage your hearing.*

Music and video clips

You can listen to music and view video clips that you have saved in your phone. The music list keeps on playing until you press Pause, even if you close the flip.









To play music

- ▶ Media Player and select a file ▶ Play.

To view a video clip

- ▶ Media Player ▶ More ▶ Play Video and select the video clip you want to view.

Media player control

- ▶ Pause to pause the playback
- Press and hold  and  to rewind and fast forward when playing music tracks
- Press  and  to move between music tracks.
- Press  or  to move up in the music list
- Press  or  to move down in the music list.

Media player options

- ▶ More to view the following options:
- Play Video – play videos.
- Information – view information about the current track or video.
- Delete Song/Delete Video – delete the file from the phone.
- Equalizer – change the settings of the treble and bass when playing music.

- **Minimize** – minimize the media player and return to standby. The music continues to play and you can use other applications and functions in the phone.
- **Random** – change the playback order of songs, in order or randomized.
- **Send Song/Send Video** – send a sound or video file using text or picture messages or email.

Online music and videos

You can view videos and listen to music that you find on a Web site by streaming them to your phone. When browsing, and when you have found a link for streaming, the media player will open automatically when the link is selected. Links for streaming can be saved as bookmarks in the phone.

To stream saved music and videos

- 1 ▶ Internet Services ▶ More ▶ Bookmarks.
 - 2 Select a link to stream. The media player will open and play the streaming music or video.
- In order to stream, you must create a data account. Contact your service provider for the correct settings.

To select data account

- 1 ▶ Connect ▶ Streaming Setting.
- 2 Select the data account you want to use.

Ringtones and melodies

Your phone comes with a number of standard and polyphonic melodies which can be used as ringtones. You can exchange melodies via cable. Please note that you are not allowed to exchange copyright-protected material.

 *If you select an MP3 file as ringtone, you cannot use voice answering ▶ 32 Voice answering. Select a file type other than MP3 to be able to use voice answering.*

To select a ringtone



- ▶ Settings ▶ the Sounds & Alerts tab ▶ Ringtone.

To turn the ringtone on or off

Press and hold (**#**-) from standby. All signals except the alarm signal are turned on or off.

Entertainment

To set the ringtone volume

- 1 ▶ Settings ▶ the Sounds & Alerts tab ▶ Ring Volume and press  or  to decrease or increase the volume
- 2 ▶ Save to save the setting.

Specific ringtones for personal calls

If your subscription includes the Calling Line Identification (CLI) service, you can assign a personal ringtone to up to ten callers, ▶ 25 To add a picture or a personal ringtone to a contact.

Vibrating alert

You can choose to be notified of an incoming call by the buzzing of the vibrating alert. You can set:

- On – all the time.
- On if in Silent – on when the ring volume is turned off or when you have set the phone to silent.
- Off – all the time.

To set the vibrating alert

▶ Settings ▶ the Sounds & Alerts tab ▶ Vibrating Alert and select the setting you want.

Sounds and alerts options





From Settings ▶ the Sounds & Alerts tab, you can set:

- Message Alert – select how you want to be notified of an incoming message.
- Key Sound – select what sound you want the keys to make when pressed.

Composing

You can compose and edit melodies to use as ringtones using the MusicDJ™. A melody consists of four tracks – Drums, Bases, Chords and Accents. A track contains a number of music blocks. The blocks consist of pre-arranged sounds with different characteristics. The blocks are grouped into Intro, Verse, Chorus, and Break. You compose a melody by adding music blocks to the tracks.

To compose a melody

- 1 ▶ Entertainment ▶ MusicDJ™.
- 2 Choose to Insert, Copy and Paste blocks to compose your melody. Use , , or  to move between the blocks. Press  to delete a block. ▶ More to view more options.

Entertainment

To edit a previously created melody

- ▶ File Manager ▶ Sounds and select the melody
- ▶ More ▶ Use ▶ Edit.

Sending and receiving

You can send and receive melodies in email, text or picture messages..

 You cannot send a polyphonic melody or an MP3 file in a text message.

To send a melody

- 1 ▶ File Manager ▶ Sounds and select a melody.
- 2 ▶ More ▶ Send and select a transfer method.

To receive a melody

- 1 Open the message in which you received the melody.
- 2 When you receive the melody, follow the instructions that appear on the screen.

Sound recorder

With the sound recorder, you can record either your own memos or calls. Recorded sounds can also be set as ringtones. When recording a call conversation, the recording is stopped if any

participant ends the call. When recording a sound, the recording stops automatically if you receive a call. Recordings are automatically saved in the phone.

 In some countries or states it is required by law that you inform the other person before recording the call.

Recording options

- ▶ More to view the following options:

Record New, Send, Rename, Delete, Recorded Sounds.

To start a sound recording



- 1 ▶ Entertainment ▶ Record Sound.
- 2 Wait until you hear a tone. When the recording starts, Recording is displayed together with the time of the current recording (increasing).

To end and play a sound recording

- ▶ Save to end the recording, and ▶ Play to listen to the recording.

Entertainment

To listen to your recordings

- 1 ▶ File Manager ▶ Sounds and select the recording you want to hear.
- 2 ▶ Play to listen to the recording. Press  and  to go to the previous or next recording.
▶ Stop to stop playback.

Themes

You can change the appearance of the screen, for example, the colors and wallpaper, by using themes. Your phone comes with some predefined themes. You cannot delete these, but you can create new themes and download them to your phone. For more information, visit www.SonyEricsson.com/support.

To select or change a theme

- ▶ File Manager ▶ Themes and select a theme.

Exchanging themes

You can exchange themes using email. Please note that you are not allowed to exchange copyrighted material.

To send a theme

- 1 ▶ File Manager ▶ Themes and select a theme
▶ More ▶ Send.
- 2 Select a transfer method.

To receive and save a theme

- 1 Open the message in which you received the theme.
- 2 When you receive the item, follow the instructions that appear on the screen.

To download a theme

- ▶ File Manager ▶ Themes and scroll to a direct link
- ▶ Go To.

Games

Your phone has several entertaining games. You can also download games and applications directly to the folders in your phone. Help texts are available for most games.

To start and end a game

- 1 ▶ Entertainment ▶ Games and select a game
▶ Start.
- 2 ▶ More to read help texts. Press and hold  to end the game.

To download a game

- ▶ Entertainment ▶ Games and scroll to a direct link
- ▶ Go To.

Connectivity

Internet and email settings, synchronizing, PC applications.

Internet

Setting up Internet and email

In order to use the Internet, and send and receive picture and email messages, you need the following:

- A phone subscription that supports data transmission.
- Settings entered in your phone.
- You may also have to register as an Internet and email user with your network operator or service provider.

Entering Internet and email settings

Settings may already be entered when you buy your phone. If not, you can enter the settings in three different ways:

Connectivity

- You can receive settings in a text message from your network operator or service provider. On www.SonyEricsson.com/support you will find Getting Started Guides that will help you to get started with all the various messaging services.
- You can enter settings by using the setup wizard.
- You can enter or edit settings manually.



Some settings are not mandatory. Please consult your network operator or service provider for more information.

Receiving settings in a text message

Your network operator or Internet service provider may be able to send the required data account, Internet and email settings direct to your phone in a text message.

Requesting settings from Sony Ericsson

Use a PC to go to www.SonyEricsson.com/support to request that a text message be sent to your phone with the settings you need.

Setting up with the wizard

If your phone is not set up for Internet, you can ask your network operator or service provider to

provide you with Internet settings information. Then you can simply use the wizard in your phone to help guide you through the relevant settings.



The wizard is automatically turned on if no Internet settings exist in your phone and you start the browser.

Using Internet

Your phone has a browser that uses WAP (Wireless Application Protocol) or HTTP (Hypertext Transfer Protocol) to bring Internet to your mobile phone.

To select an Internet profile

▶ Connect ▶ Internet Settings ▶ Internet Profiles and select the profile you want to use.

To start browsing

Scroll to your online service or operator menu, and select a service.

To stop browsing

▶ More ▶ Exit Browser.

Options when browsing

- ▶ More to view different browsing options. The options may vary depending on which site you are visiting.



If you select an email address when browsing a Web site, you can send a text message to that address.

The options menu always contains the following:

- Exit Browser – disconnect and go to standby.
- Go to the homepage set for the current Internet profile, for example, Sony Ericsson.
- Bookmarks – add the site you are currently browsing to your list of bookmarks or view the list of bookmarks.
- Enter Address – enter the Web page address of a site you want to visit. ▶ New Address to enter a new Web page address or select one of the 10 latest entered addresses. When you enter a Web page address, the normal http:// prefix is not needed.
- History – list of previously visited sites.
- Refresh Page – refresh the contents of the Web page.
- Save Picture – save a picture from the site.
- Send Link – send a link to the current site to another phone.

- Status – display current status information, for example, profile, access type, connection time, data rate, security, address.
- Make a Call/End Call – if your subscription supports it, you can make a call while browsing the Internet by selecting Make a Call. ▶ End Call to end the call and continue browsing.

Using bookmarks

You use bookmarks in your mobile phone just as you do with a PC Internet browser. You can create and edit bookmarks.

To work with bookmarks

- 1 ▶ Internet Services ▶ More ▶ Bookmarks and select a bookmark ▶ More.
- 2 Select an option.

Downloading

You can download, for example, pictures, themes, games and ringtones, from Web sites directly to your phone.



Contact your network operator or service provider for more information if menu options are not available.

Connectivity

To download from

www.sonyericsson.com/support

- 1 ▶ Internet Services ▶ More ▶ Bookmarks
▶ Sony Ericsson.
- 2 Select what you want to download and follow the instructions that appear.

Stored information

When browsing, you can save information in your phone.



It is advisable to clear any sensitive information about previously visited Internet services. This is to avoid a security risk if your phone is misplaced, lost or stolen.

The following information can be saved:

- Cookies – improve site access efficiency
- Passwords – improve server access efficiency.

To allow or clear cookies in your phone

▶ Connect ▶ Internet Settings ▶ Cookies and select an option and confirm.

To clear the password list

▶ Connect ▶ Internet Settings ▶ Clear Passwords and ▶ Yes to confirm.

Internet security

Your phone has support for both WAP and HTTP secure browsing. To activate a secure connection to the WAP gateway using a WAP profile, you need to turn on security in your Internet profile per the instructions below. If your Internet profile is an HTTP profile, the connection will automatically be secure if the URL starts with https://. The  icon indicates that a secure Internet connection has been established.



Security for a connection between a WAP gateway and a WAP service provider is the responsibility of the WAP service provider.

To turn on a secure connection (WAP)

- 1 ▶ Connect ▶ Internet Settings ▶ Internet Profiles and select a profile ▶ More ▶ Settings.
- 2 Turn on security.

Trusted certificates

To establish a secure connection when using certain Internet services, for example, banking, you need certificates in your phone.

Trusted certificates are used to verify the WAP gateway or the HTTP server that you are trying to

connect to. Your phone may already contain trusted certificates when you buy it. You can also download new certificates using the browser.

To check the certificates in your phone

► Connect ► Internet Settings ► Security ► Trusted Cert.

Synchronizing

You can synchronize your mobile phone contacts, appointments, tasks and notes with similar programs in, for example, a PC or mobile phone using a cable, and with similar programs on the Internet using WAP or HTTP.

To select sync order for names

► Phonebook ► Options ► Advanced ► Sync. Order to select which order first and last name appear in the phone when you synchronize contacts.

Synchronization with nearby devices

Install the synchronization program from the CD that comes with your phone or download it from www.SonyEricsson.com/support using a Sony Ericsson data cable.

For more information, please refer to the synchronization software online help.

Remote synchronization with Internet programs

Contact your service provider for more information about the programs on the Internet with which you can synchronize, and to receive username, password and addresses for the different programs. You must also have a Internet profile set in your mobile phone ► *Setting up Internet and email.*

To enter the remote synchronization settings

- 1 ► Connect ► Synchronization ► New Account.
If you do not have an account, you will be asked if you want to create an account. ► Yes to create a new account.
- 2 Enter a name for the new account ► Continue.
A list of options to enter will appear. Add the server address of the synchronization server, a server username and a server password. ► OK when you have entered each setting.
- 3 Select New Account and select the WAP or HTTP profile that you want to use for the synchronization.

More features

- 4 Select Applications and select the applications that you want to synchronize, for example, Phonebook ▶ OK.
- 5 Select Application Settings and select application. Enter the name of the database and, if required, your username and password ▶ OK.
- 6 Press  ▶ Save to save your new account.

To start the remote synchronization

- ▶ Connect ▶ Synchronization and select a remote account ▶ Start



On www.SonyEricsson.com/support, you will find Getting Started Guides that will help you to get started with synchronization.

PC Applications

Sony Ericsson makes it easy to connect your phone to a PC and to personalize your phone. You can download pictures, ringtones, or video clips, or you can synchronize your phone to the calendar on your PC. Go to www.SonyEricsson.com/support and click on Support to download the software necessary to synchronize your contacts, calendar, and tasks.

More features

Time and date, alarm clock, calendar, tasks, SIM card lock, etc.

Time and date

The time is always displayed in standby.

- To set the time ▶ Settings ▶ the General tab ▶ Time & Date ▶ Time. Enter the time ▶ Save.
- To set the time format ▶ Settings ▶ the General tab ▶ Time & Date ▶ Time ▶ Format. You have two options (12-hour or 24-hour clock).

Date

You can set the date and date format in Settings ▶ the General tab ▶ Time & Date ▶ Date.

Advanced time settings

In Settings ▶ the General tab ▶ Time & Date you can set time zone and daylight saving time.

If you have activated Auto Time Update, time and date information will update automatically without any user input. If Auto Time Update is set to Prompt, you will see a message asking if you want to update

More features

the time and date. If you press Yes, the time is updated automatically.

Alarm clock

The alarm can be set to ring at a specific time within 24 hours, or recurrently at a specific time on several days. You can have both these alarms set at the same time. The alarm signal rings even if the phone is set to silent or turned off.

To set an alarm

► Organizer ► Alarm Signal ► Alarm and enter the time ► Save.

Using the alarm

- To change the alarm time, ► Organizer ► Alarm Signal ► Alarm and enter a new time.
- To turn the alarm signal off when it rings, press any key if you do not want the alarm to be repeated ► Turn Off.
- To cancel the alarm ► Organizer ► Alarm Signal ► Alarm ► Turn Off.

- To set a recurrent alarm ► Organizer ► Alarm Signal ► Recurrent Alarm. Enter the time and select the days that you want the alarm to recur by scrolling and pressing Mark. ► Done to exit the menu.
- To select an alarm signal ► Organizer ► Alarm Signal ► Alarm Signal.

Calendar

You can use the calendar to keep track of important meetings that you need to attend. The calendar can be synchronized with a PC calendar or with a calendar on the Web ► 73 *Synchronizing*.

Appointments

You can save up to 300 appointments depending on the size of each item. You can choose to add a new appointment or use an old one as a template by copying and editing it. You can also set a reminder for an appointment.

To add a new appointment

- 1 ► Organizer ► Calendar and select the date for the appointment ► New Appointment ► Add.
- 2 Enter date, subject, location and reminder. Confirm each entry.

More features

To set reminders options

- ▶ Organizer ▶ Calendar ▶ More ▶ Advanced
- ▶ Reminders.

Reminders options

- ▶ Always if you want the reminder to sound even though the phone is turned off. When the reminder sounds press Yes to read the appointment ▶ No to turn off the reminder.

 *A reminder option set in the calendar affects a reminder option set in tasks.*

To view an appointment

- 1 Organizer ▶ Calendar and select a day on which you have an appointment (marked in bold).
- 2 Scroll to the appointment ▶ View.

Viewing your calendar

- To view your calendar content ▶ Organizer
- ▶ Calendar. Days on which you have appointments are marked in bold. ▶ More ▶ View Week to view a certain week.

Navigating in your calendar

Use the navigation key to move between days or weeks. In the monthly and weekly views, you can also use the keypad as follows:

-  Back a week
-  Back a month
-  Back a year
-  Today's date
-  Next week
-  Next month
-  Next year

Calendar settings

- ▶ Organizer ▶ Calendar ▶ More and select one of the options:
 - View Week – select, add, edit or delete appointments.
 - New Appointment – add a new appointment.
 - Change Date – change the date of your calendar.
 - Advanced – for options to find, delete all, set reminders or select a start day for the week.

Find an appointment

You can search for appointments that contain a specific text.

More features

To search for appointments

- 1 ▶ Organizer ▶ Calendar ▶ More ▶ Advanced ▶ Find.
- 2 Enter the text you want to search for ▶ OK. Appointments that match your search are shown. ▶ View to view your appointments or ▶ More for options to reschedule, edit, send, copy or delete.

Exchanging appointments

You can send and receive appointments using picture messaging.

To send an appointment

In the list of appointments for a certain day, select the item you want to send ▶ More ▶ Send and select a transfer method.

Receiving an appointment

When Add appointment? is displayed ▶ Yes to save the appointment.

Tasks

You can keep track of phone calls you need to make or tasks that you need to do. You can save up

to 80 tasks depending on the size of each item. You can choose to add a new task or use an old one as a template by copying and editing it. You can also set a reminder for a task.

To add a new task

- 1 ▶ Organizer ▶ Tasks ▶ New Task ▶ Add.
- 2 Select a category. If the category is a phone call, enter the phone number ▶ Continue.
- 3 Enter a subject ▶ Continue.
- 4 If you want to set a reminder for your task ▶ Yes.

To set reminders

- ▶ Organizer ▶ Tasks and select a task ▶ More ▶ Reminders.

Reminders options

- ▶ Always if you want the reminder to sound even though the phone is turned off. When the reminder sounds press Yes to read the task, or to call the phone number in a phone task. ▶ No to turn off the reminder.

 A reminder option set in tasks affects a reminder option set in the calendar.

More features

To view a task

- ▶ Organizer ▶ Tasks and select a task ▶ View.

Exchanging tasks

You can send and receive tasks using picture messaging.

To send a task

- 1 In the list of tasks for a certain day, select the item you want to send ▶ More ▶ Send.
- 2 Select a transfer method.

Receiving a task

When Add task? is displayed ▶ Yes to save the appointment or task.

Notes

If you need to remember something, you can make a note of it in your phone. You can save up to 10 notes.

To add a note

- ▶ Organizer ▶ Notes ▶ New Note ▶ Add and enter the note ▶ Save.

To handle the notes

- 1 ▶ Organizer ▶ Notes and a list of notes appears.
- 2 Select the note that you want to handle. ▶ More to edit, show a note in standby (or hide it), send or delete a note.

Exchanging notes

You can send and receive notes using picture messaging. You can also synchronize notes with a PC ▶ 73 *Synchronizing*.

To send a note

- ▶ Organizer ▶ Notes and select the note that you want to send ▶ More ▶ Send and select a transfer method.

To receive a note

Add note? appears ▶ Yes to save the note among your other notes.

Profiles

Your phone has a number of predefined profiles which are set to suit a certain environment. You can add accessories to, rename or change these profiles. For example, when you go to a meeting,

you can simply choose the Meeting profile and a number of settings are changed, for example, the ringtone is turned off.

You can reset all profile settings to the way they were set when you bought your phone.

Automatic activation

Some profiles, for example In Car, are automatically activated when used with a specific accessory. When the accessory is disconnected, the profile is changed back.

To select a profile

▶ Settings ▶ the General tab ▶ Profiles ▶ Select Profile.

To change a profile setting

- 1 ▶ Settings ▶ the General tab ▶ Profiles ▶ Edit Profile.
- 2 Select a setting that you want to change.
- 3 Change the profile settings.

To rename a profile

▶ Settings ▶ the General tab ▶ Profiles ▶ Edit Profile ▶ Profile Name:

To reset all profile settings

▶ Settings ▶ the General tab ▶ Profiles ▶ Reset Profiles.

Stopwatch

Your phone has a stopwatch that can save several laps. The stopwatch continues to run when you answer an incoming call.

To use the stopwatch with the flip open

- 1 ▶ Organizer ▶ Stopwatch ▶ Start.
- 2 ▶ Stop or ▶ New Lap if you want a lap time.
- 3 To reset the stopwatch, ▶ Reset.

To use the stopwatch with the flip closed

- 1 ▶ Organizer ▶ Stopwatch ▶ Start.
- 2 Close the flip.
- 3 Press the upper side volume key to start the stopwatch. Press the upper side volume key again to stop the stopwatch. Press the upper side volume key a third time to restart the stopwatch.

More features

- 4 Press the lower side volume key to reset the stopwatch to zero.

Timer

Your phone has a built-in timer. When the signal rings, press any key to turn it off.

To set the timer

► Organizer ► Timer and enter the hours, minutes and seconds after which you want the timer to go off.

Display light

The display light can be set to On, Off, Automatic or Power save. Power save is the default setting for the display light and is designed to optimize standby time. Your screen is turned off completely a few seconds after you last press a key. Press any key and the screen turns on again. In automatic mode, the display light is turned off a few seconds after you last press a key.

To set the display light

► Settings ► the Display tab ► Light.

Start-up screen

When you turn your phone on or off, the Sony Ericsson start-up screen appears. Your service provider's own start-up screen may appear instead. You can also set your own start-up screen.

To select a start-up screen

► Settings ► the Display tab ► Startup Screen and select a file for the start-up screen.

Calculator

The phone has a calculator, which can add, subtract, divide and multiply.

To use the calculator

- Organizer ► Calculator
- Press **☞** or **☛** to select \div \times $+$ $-$ $\%$ $=$
 - Press **☒** to delete the figure.
 - Press **☒.** to enter a decimal point.

SIM card lock

The SIM card lock protects your subscription, but not your phone itself, from unauthorized use. If you change SIM cards, the phone still works with the new SIM card.

More features

Some SIM cards are locked at the time of purchase. If the SIM card lock is on, you have to enter a PIN (Personal Identity Number) every time you turn on your phone.

If you enter your PIN incorrectly three times in a row, the SIM card is blocked. This is indicated by the message PIN blocked. To unblock it, you need to enter your PUK (Personal Unblocking Key). Your PIN and PUK are supplied by your service provider.

To unblock your SIM card

- 1 When PIN blocked, is displayed, enter your PUK ► OK.
- 2 Enter a new four- to eight-digit PIN ► OK.
- 3 Re-enter the new PIN to confirm ► OK.

To edit your PIN

- Settings ► the General tab ► Locks ► SIM Lock ► Change PIN.

To turn the SIM card lock on or off

- 1 ► Settings ► the General tab ► Locks ► SIM Lock ► Protection and select On or Off.
- 2 Enter your PIN ► OK.



If the message Codes do not match, appears, you entered the new PIN incorrectly. If the message Wrong PIN, appears, followed by Old PIN:, you entered your old PIN incorrectly.

Phone lock

The phone lock protects the phone against unauthorized use if it is stolen and the SIM card is exchanged. It is not on when you buy the phone. You can change the phone lock code (0000) to any four- to eight-digit personal code.

Phone lock on

If the phone lock is on, the message Phone locked, appears each time you turn on the phone. You have to enter your code followed by Yes to use your phone.

More features

Automatic phone lock

If the phone lock is set to automatic, you do not need to enter your phone lock code until a different SIM card is inserted in the phone.

 *It is important that you remember your new code. If you should forget it, you have to hand in your phone to your local Sony Ericsson retailer.*

To set the phone lock

- 1 ▶ Settings ▶ the General tab ▶ Locks ▶ Phone lock ▶ Protection and select an alternative.
- 2 Enter the phone lock code ▶ OK.

To edit your phone lock code

- ▶ Settings ▶ the General tab ▶ Locks ▶ Phone lock ▶ Change Code.

Code memo

Instead of having to remember all the different security codes for credit cards, for example, you can save them in the code memo in your phone. Then all you need to remember is the passcode to open the code memo. You can save a maximum of 10 codes in the code memo.

Checkword and security

To confirm that you have entered the correct passcode for the code memo and to prevent unauthorized access to your codes, you must enter a checkword.

When you enter your passcode to open the code memo, the checkword is shown for a short time. If the passcode is correct, the correct codes are shown. If you enter the incorrect passcode, the checkword and the codes that are shown are also incorrect.

Factors strengthening the security of the code memo function are:

- You get no feedback about whether the passcode is correct, except for the checkword, and only you know the checkword.
- All codes are encrypted in the phone.
- When you access your codes, they are shown for a limited time only.

To open code memo for the first time

- 1 ▶ Organizer ▶ Code Memo. A message with instructions is displayed ▶ Continue.
- 2 Enter a four-digit passcode to open code memo ▶ Continue.

More features

- 3 Re-enter the new passcode to confirm.
- 4 Enter a checkword (maximum 15 characters)
 - ▶ Done. The checkword can consist of both letters and numbers. The next time you open the code memo, your checkword appears after you enter the passcode, and then your added codes are shown.

To add a new code

- 1 ▶ Organizer ▶ Code Memo and enter your passcode ▶ New Code ▶ Add.
- 2 Enter a name associated with the code, for example, the name of the credit card company ▶ Continue.
- 3 Enter the code ▶ Done.

To change the passcode

- 1 Open code memo as described above ▶ More ▶ Change Passcode.
- 2 Enter your new passcode ▶ Continue.
- 3 Re-enter the new passcode ▶ Continue.
- 4 Enter a checkword ▶ Done.

Forgot your passcode?

If you forget your passcode, just enter any passcode to access the code memo function. The checkword

and codes that are then shown are incorrect. You must now reset the code memo.

To reset code memo

- 1 ▶ More ▶ Reset.
- 2 Reset code memo? is displayed ▶ Yes. The code memo is reset and all entries are cleared. The next time you enter the code memo, you must start at **82 To open code memo for the first time.**

Online services

Online services are customized services offered by service providers, independently of mobile phones and mobile phone manufacturers.

A SIM card which supports online services works in the same way as a normal SIM card. When you have inserted your SIM card and turned on your phone, your service provider can download data to your SIM card. When you restart your phone after

Troubleshooting

the first data download, a new submenu appears under the menu.



This menu only appears if your SIM card supports this service. Your phone may not support all of the services offered. Some operators may not use the name Online Services.

To enter your new menu system

▶ Connect ▶ Online Services.

Troubleshooting

Why doesn't the phone work the way I want?

This chapter lists some problems that you might encounter while using your phone. Some problems require that you call your service provider, but most of the problems you can easily correct yourself.

However, if you need to hand in your phone for repair, please note that you may lose information and content that you have saved in your phone. You are advised to make a copy of such information before handing your phone in for repair.

Master reset

You can return the phone to its original state by deleting the changes that you have made to settings, and the content that you have added or edited.

- If you select **Reset Settings**, the changes that you have made to settings will be deleted.

- If you select Reset All, in addition to your changes to settings, all contacts, messages, personal data, and content that you have downloaded, received or edited will also be deleted.

To reset the phone

- 1 ▶ Settings ▶ the General tab ▶ Master Reset.
- 2 ▶ Reset Settings or Reset All.
- 3 Enter the phone lock code (0000 or the new code if you have changed it) ▶ OK.

 If you select Reset All, content such as melodies and pictures that you have downloaded, received or edited are also deleted.





The phone cannot be switched on

Recharge or replace the battery. ➡ 5 To insert the SIM card and charge the battery.

No indication of charging

When you start charging a battery that is empty or a battery that has not been used for a long time, it may take up to 30 minutes before the battery icon appears in the screen.

Menu language

If the screen shows a language that you do not understand, you can always choose Automatic (determined by your SIM card) by pressing  8888  in standby. You can always choose English by pressing  0000  in standby.

Grey menu options

Grey text indicates a function that is temporarily unavailable, for example, if a service is not activated, or if your subscription does not support the function. Since you cannot send themes, pictures and sounds that are copyright-protected, the Send menu is sometimes unavailable.

Insert SIM

There is no SIM card in the phone or you may have inserted it incorrectly. Insert a SIM card. ➡ 5 To insert the SIM card and charge the battery.

Insert correct SIM card

The phone is set to work only with certain SIM cards. Insert the correct SIM card.

Troubleshooting

Emergency calls only

You are within range of a network, but you are not allowed to use it. However, in an emergency, some service providers allow you to call the international emergency number 112. ➔ *24 Emergency calls*.

No network

There is no network within range or the received signal is too weak. Moving to a new location may increase signal strength.

Wrong PIN/Wrong PIN2

You have entered your PIN or PIN2 incorrectly.

Enter the correct PIN or PIN2 ▶ Yes. ➔ *80 SIM card lock*.

Codes do not match

When you want to change a security code (for example your PIN) you have to confirm the new code by entering it again. The two codes that you have entered do not match. ➔ *80 SIM card lock*.

PIN blocked/PIN2 blocked

You have entered your PIN or PIN2 incorrectly three times in a row. To unblock, ➔ *80 SIM card lock*.

PUK blocked

You entered your personal unblocking key code (PUK) incorrectly 10 times in a row. Contact your network operator or service provider.

Phone locked

The phone is locked. To unlock the phone,

➔ *81 Phone lock*.

Phone lock code

Your phone comes with the phone lock code, 0000.

You can change it to any four- to eight-digit code.

➔ *81 Phone lock*.

Number not permitted

The fixed dialing function is activated and the number you have dialed is not on your fixed numbers list. ➔ *37 Fixed dialing*.

Additional Information

Charging, alien battery

The battery you are using is not a Sony Ericsson-approved battery, ➡ *91 Battery use and care*.

Additional Information

Sony Ericsson web site, technical assistance, safe and efficient use, warranty, declaration of conformity.

Sony Ericsson consumer web site

On www.SonyEricsson.com there is a support section where help and tips are only a few clicks away. Here you find the latest PC software updates and tips on how to use your product more efficiently.

Accessible Solutions/Special Needs

You can use your TTY terminal with your Sony Ericsson mobile phone (with the necessary accessory). For information on Accessible Solutions for individuals with special needs call the Sony Ericsson Special Needs Center at 877-878-1996 (TTY) or 877-207-2056 (voice), or visit the Sony Ericsson Special Needs Center at www.SonyEricsson-SNC.COM.

Hearing Aid Compatibility Rating

This model handset was designed to comply with the requirements set forth in Section 68.4 of the Federal Communication Commission's rules governing hearing aid

Additional Information

compatibility (HAC), for the reduction of RF interference to hearing aids. The Microphone (M) rating is defined and labeled on the handset box. Devices meeting HAC compliance must have a minimum M3 rating or above as defined in the ANSI Standard PC63.19-2005. The (M) rating refers to lower RF emissions levels of the handset. Some hearing aids are also provided an (M) rating, and are more immune than others to interference. To determine the (M) rating of your hearing aid, please contact your hearing health professional. More information about digital wireless devices and hearing aid compatibility can be found at www.sonyericsson-spc.com.

Guidelines for Safe and Efficient Use

Please read this information before using your mobile phone.



Recommendations

- Always treat your product with care and keep it in a clean and dust-free place.
- Do not expose your product to liquid or moisture or humidity.
- Do not expose your product to extreme high or low temperatures.
- Do not expose your product to open flames or lit tobacco products.
- Do not drop, throw or try to bend your product.
- Do not close your product with an object inserted between keypad and display, this may damage your product.
- Do not paint your product.
- Do not use your product near medical equipment without requesting permission.
- Do not use your product when in, or around aircraft, or areas posted "turn off two-way radio".
- Do not use your product in an area where a potentially explosive atmosphere exists.
- Do not place your product or install wireless equipment in the area above your car's air bag.



- Do not attempt to disassemble your product. Only Sony Ericsson authorized personnel should perform service.



Antenna

Only use an antenna that has been specifically designed by Sony Ericsson for your mobile phone. Use of unauthorized or modified antennas could damage your mobile phone and may violate regulations, causing loss of performance and SAR levels above the recommended limits (see below).

Efficient use

Hold your mobile phone as you would any other phone. Do not cover the top of the phone when in use, as this affects call quality and may cause the phone to operate at a higher power level than needed, thus shortening talk and standby times.

Radio frequency (RF) exposure and SAR

Your mobile phone is a low-power radio transmitter and receiver. When it is turned on, it emits low levels of radio frequency energy (also known as radio waves or radio frequency fields).

Governments around the world have adopted comprehensive international safety guidelines, developed

Additional Information

by scientific organizations, e.g. ICNIRP (International Commission on Non-Ionizing Radiation Protection) and IEEE (The Institute of Electrical and Electronics Engineers Inc.), through periodic and thorough evaluation of scientific studies. These guidelines establish permitted levels of radio wave exposure for the general population. The levels include a safety margin designed to assure the safety of all persons, regardless of age and health, and to account for any variations in measurements.

Specific Absorption Rate (SAR) is the unit of measurement for the amount of radio frequency energy absorbed by the body when using a mobile phone. The SAR value is determined at the highest certified power level in laboratory conditions, but the actual SAR level of the mobile phone while operating can be well below this value. This is because the mobile phone is designed to use the minimum power required to reach the network.

Variations in SAR below the radio frequency exposure guidelines do not mean that there are variations in safety. While there may be differences in SAR levels among mobile phones, all Sony Ericsson mobile phone models are designed to meet radio frequency exposure guidelines.

Before a phone model is available for sale to the public, it must be tested and certified to the FCC that it does not exceed the limit established by the government-adopted requirement for safe exposure. The tests are performed in positions and locations (that is, at the ear and worn on the body) as required by the FCC for each model. For body worn operation, this phone has been tested and meets FCC

Additional Information

RF exposure guidelines when the handset is positioned a minimum of 15 mm from the body without any metal parts in the vicinity of the phone or when used with the original Sony Ericsson body worn accessory intended for this phone. Use of other accessories may not ensure compliance with FCC RF exposure guidelines.

Additional SAR information for this mobile phone model is included at the back of this user's guide. This information can also be found, together with more information on radio frequency exposure and SAR, on: WWW.SONYERICSSON.COM.

Driving

Please check if local laws and regulations restrict the use of mobile phones while driving or require drivers to use handsfree solutions. We recommend that you use only Sony Ericsson handsfree solutions intended for use with your product. Please note that because of possible interference to electronic equipment, some vehicle manufacturers forbid the use of mobile phones in their vehicles unless a handsfree kit with an external antenna supports the installation.

Always give full attention to driving and pull off the road and park before making or answering a call if driving conditions so require.

Personal medical devices

Mobile phones may affect the operation of cardiac pacemakers and other implanted equipment. Please avoid placing the mobile phone over the pacemaker, e.g. in your breast pocket. When using the mobile phone, place it at the ear opposite the pacemaker. If a minimum distance of 6 inches (15 cm) is kept between the mobile phone and the pacemaker, the risk of interference is limited. If you have any reason to suspect that interference is taking place, immediately turn off your mobile phone. Contact your cardiologist for more information.

For other medical devices, please consult the manufacturer of the device.

CHILDREN

DO NOT ALLOW CHILDREN TO PLAY WITH YOUR MOBILE PHONE OR ITS ACCESSORIES. THEY COULD HURT THEMSELVES OR OTHERS, OR COULD ACCIDENTALLY DAMAGE THE MOBILE PHONE OR ACCESSORY. YOUR MOBILE PHONE OR ITS ACCESSORY MAY CONTAIN SMALL PARTS THAT COULD BE DETACHED AND CREATE A CHOKING HAZARD.



Additional Information

Disposal of old electrical & electronic equipment



This symbol on the product or on its packaging indicates that this product shall not be treated as household waste. Instead it shall be handed over to the applicable collection point for the recycling of electrical and electronic equipment. By ensuring this product is disposed of correctly, you will help prevent potential negative consequences for the environment and human health, which could otherwise be caused by inappropriate waste handling of this product. The recycling of materials will help to conserve natural resources. For more detailed information about recycling of this product, please contact your local city office, your household waste disposal service or the shop where you purchased the product.

Power supply

Connect the AC power adapter only to designated power sources as marked on the product. Make sure the cord is positioned so that it will not be subjected to damage or stress. To reduce risk of electric shock, unplug the unit from any power source before attempting to clean it. The AC power adapter must not be used outdoors or in damp areas. Never alter the cord or plug. If the plug will not fit into the outlet, have a proper outlet installed by a qualified electrician.

Emergency calls

Mobile phones operate using radio signals, which cannot guarantee connection under all conditions. Therefore you should never rely solely upon any mobile phone for essential communications (e.g. medical emergencies).

Emergency calls may not be possible on all cellular networks or when certain network services and/or mobile phone features are in use. Check with your local service provider.

Battery use and care

We recommend that you fully charge the battery before you use your mobile phone for the first time. The battery should only be charged in temperatures between +41°F (+5°C) and +113°F (+45°C).

A new battery or one that has not been used for a long time could have reduced capacity the first few times it is used.

The talk and standby times depend on the actual transmission conditions when using the mobile phone. If the mobile phone is used near a base station, less power is required and talk and standby times are prolonged.

- **Warning!** May explode if disposed of in fire.
- Use only Sony Ericsson branded original batteries and chargers intended for use with your mobile phone. Other chargers may not charge sufficiently or may produce excessive heat. Using other batteries and chargers could be dangerous.

Additional Information

- Do not expose the battery to liquid.
- Do not let the metal contacts on the battery touch another metal object. This could short-circuit and damage the battery.
- Do not disassemble or modify the battery.
- Do not expose the battery to extreme temperatures, never above +140°F (+60°C). For maximum battery capacity, use the battery in room temperature.
- Turn off your mobile phone before removing the battery.
- Keep out of children's reach.
- Use the battery for the intended purpose only.
- Do not allow the battery to be put into the mouth. Battery electrolytes may be toxic if swallowed.
- Do not close your phone with an object inserted between keypad and display, this may cause damage to the phone.



Disposing of the battery

Please check local regulations for disposal of batteries or call your local Sony Ericsson Call Center for information.

The battery should never be placed in municipal waste. Use a battery disposal facility if available.



Limited Warranty

Sony Ericsson Mobile Communications AB, S-221 88 Lund, Sweden, (Sony Ericsson), provides this Limited Warranty for your mobile phone and original accessory delivered with your mobile phone (hereinafter referred to as "Product").

Should your Product need warranty service, please return it to the dealer from whom it was purchased, or contact your local Sony Ericsson Call Center (national rates may apply) or visit www.SonyEricsson.com to get further information.

Our warranty

Subject to the conditions of this Limited Warranty, Sony Ericsson warrants this Product to be free from defects in design, material and workmanship at the time of its original purchase by a consumer, and for a subsequent period of one (1) year.

What we will do

If, during the warranty period, this Product fails to operate under normal use and service, due to defects in design, materials or workmanship, Sony Ericsson authorized distributors or service partners, in the country/region* where you purchased the Product, will, at their option, either repair or replace the Product in accordance with the terms and conditions stipulated herein.

Additional Information

Sony Ericsson and its service partners reserve the right to charge a handling fee if a returned Product is found not to be under warranty according to the conditions below.

Please note that some of your personal settings, downloads or other information may be lost when your Sony Ericsson Product is repaired or replaced. At present Sony Ericsson may be prevented by applicable law, other regulation or technical restrictions from making a backup copy of certain downloads. Sony Ericsson does not take any responsibility for any lost information of any kind and will not reimburse you for any such loss. You should always make backup copies of all the information stored on your Sony Ericsson Product such as downloads, calendar and contacts before handing in your Sony Ericsson Product for repair or replacement.

Conditions

- 1 The warranty is valid only if the original proof of purchase issued to the original purchaser by an, for this Product, Sony Ericsson authorized dealer, specifying the date of purchase and serial number**, is presented with the Product to be repaired or replaced. Sony Ericsson reserves the right to refuse warranty service if this information has been removed or changed after the original purchase of the Product from the dealer.
- 2 If Sony Ericsson repairs or replaces the Product, the repaired or replaced Product shall be warranted for the remaining time of the original warranty period or for ninety (90) days from the date of repair, whichever is

longer. Repair or replacement may involve the use of functionally equivalent reconditioned units. Replaced parts or components will become the property of Sony Ericsson.

- 3 This warranty does not cover any failure of the Product due to normal wear and tear, or due to misuse, including but not limited to use in other than the normal and customary manner, in accordance with the Sony Ericsson instructions for use and maintenance of the Product. Nor does this warranty cover any failure of the Product due to accident, software or hardware modification or adjustment, acts of God or damage resulting from liquid.

A rechargeable battery can be charged and discharged hundreds of times. However, it will eventually wear out — this is not a defect. When the talk-time or standby time is noticeably shorter, it is time to replace your battery. Sony Ericsson recommends that you use only batteries and chargers approved by Sony Ericsson.

Minor variations in display brightness and color may occur between phones. There may be tiny bright or dark dots on the display. These are called defective pixels and occur when individual dots have malfunctioned and can not be adjusted. Two defective pixels are deemed acceptable.

Minor variations in camera image appearance may occur between phones. This is nothing uncommon and is not regarded as a defective camera module.

Additional Information

- 4 Since the cellular system on which the Product is to operate is provided by a carrier independent from Sony Ericsson, Sony Ericsson will not be responsible for the operation, availability, coverage, services or range of that system.
- 5 This warranty does not cover Product failures caused by installations, modifications, or repair or opening of the Product performed by a non-Sony Ericsson authorized person.
- 6 The warranty does not cover Product failures which have been caused by use of accessories or other peripheral devices which are not Sony Ericsson branded original accessories intended for use with the Product.
- 7 Tampering with any of the seals on the Product will void the warranty.

THERE ARE NO EXPRESS WARRANTIES, WHETHER WRITTEN OR ORAL, OTHER THAN THIS PRINTED LIMITED WARRANTY. ALL IMPLIED WARRANTIES, INCLUDING WITHOUT LIMITATION THE IMPLIED WARRANTIES OF MERCHANTABILITY OR FITNESS FOR A PARTICULAR PURPOSE, ARE LIMITED TO THE DURATION OF THIS LIMITED WARRANTY. IN NO EVENT SHALL SONY ERICSSON OR ITS LICENSORS BE LIABLE FOR INCIDENTAL OR CONSEQUENTIAL DAMAGES OF ANY NATURE WHATSOEVER, INCLUDING BUT NOT LIMITED TO LOST PROFITS OR COMMERCIAL LOSS; TO THE

FULL EXTENT THOSE DAMAGES CAN BE DISCLAIMED BY LAW.

Some countries/states do not allow the exclusion or limitation of incidental or consequential damages, or limitation of the duration of implied warranties, so the preceding limitations or exclusions may not apply to you. The warranty provided does not affect the consumer's statutory rights under applicable legislation in force, nor the consumer's rights against the dealer arising from their sales / purchase contract.

*EUROPEAN UNION (EU)

If you have purchased your Product in an EU country you can have your Product serviced, under the conditions set out above, within the warranty period in any EU country where an identical Product is sold by an authorized Sony Ericsson distributor. To find out if your Product is sold in the EU country you are in, please call the local Sony Ericsson Call Center. Please observe that certain services may not be possible elsewhere than in the country of original purchase, for example due to the fact that your Product may have an interior or exterior which is different from equivalent models sold in other EU countries. It may not be possible to repair SIM-locked Products.

** In some countries/regions additional information is requested. If so, this is clearly shown on the valid proof of purchase.

FCC Statement

This device complies with Part 15 of the FCC rules. Operation is subject to the following two conditions: (1) This device may not cause harmful interference, and (2) This device must accept any interference received, including interference that may cause undesired operation.



Icons







Icons

Icon descriptions.









The table below describes the icons which appear on the desktop and in standby.

Icon Description























Desktop

	Your personal phonebook
	Handling of text, picture, email, instant and voice messages
	Camera and video recorder functions
	Handling of pictures, sounds, video and themes
	Personal settings, including display, time and date, language, sounds, alerts and specific settings for calls
	Gives you access to Internet services
	Calendar, alarm clock and other extras

Icon Description

	Settings for networks, Internet, streaming, accessories
	Operator services
	Games, MusicDJ™, sound recorder
	Audio and video player, streaming
<i>Standby</i>	
	Desktop icon
	Tells you the strength of the GSM network signal
	GPRS is within range
	GPRS is within range and can be used
	Tells you are in a premium charge zone
	Tells you the status of the battery

Icons

Icon	Description	Icon	Description
	You cannot receive any incoming calls		You have received a picture message
	You have missed an incoming call		You have received a voice message
	All incoming calls are forwarded to a defined number		You have received a WAP push message
	No calls or only certain calls from numbers in a list are received		You have received a message via cell broadcast
	All signals are off, except the alarm and timer		A GPRS session is in progress
	The alarm clock has been set and is on		Line 1 is in use for outgoing calls
	The timer has been set and is on		Line 2 is in use for outgoing calls
	A profile other than Normal has been chosen		Ciphering is currently not being provided by the network
	The card lock or phone lock is on		An ongoing call
	A secure Internet connection is established		A chat session is in progress
	You have received a text message		My friends status icon

Icons

Icon Description



The media player is running



Data is being downloaded to the phone



A Java™ application is running

Index

A

- accept calls 36
- account settings, email 49
- adding
 - personal ringtones 25
 - pictures to contacts 25
- alarm clock 75
- alerts 66
- animations 62
- answering
 - calls 22
 - using voice control 32
 - answering service 29
- antenna, internal 11
- appointments 75–77
- area information 55
- ask to save 26
- assembling, phone 5
- automatic redialing 23

B

- battery

- alien 87
- charging 5
- inserting 5
- block
 - contacts 54
 - strangers 54
- bookmarks, Internet 71
- business cards 41
- buttons 10

C

- calculator 80
- calendar 75–77
- call costs 38–39
- call list 28
- call priority 39
- call time 38
- call waiting 34
- calling
 - from call list 28
 - from phonebook 26
 - numbers in message 44
 - using voice dialing 31
- calls

Index

- accepting 36
- answering 23
- automatic redialing 23
- emergency 24
- fixed dialing 37
- handling two calls 34
- international 23
- making 8, 22
- making notes during 40
- missed 23
- putting on hold 34
- receiving 8, 22
- recording 67
- rejecting 23
- restricting 37
- speed dialing 29
- camera 58–61
- cell information 56
- certificates, Internet security 72
- charging, battery 5
- closed user groups 40
- code memo 82
- codes
 - PIN 6

Index

- PUK 6, 86
 - conference calls 35
 - connectors 10
 - contacts 24
 - as default phonebook 25
 - groups of 41
 - My friends 52
 - synchronizing 73
 - cookies 72
 - copying
 - to/from SIM card 27
 - cost information 38
 - credit limit 39
 - D**
 - date, setting 74
 - declaration of conformity 95
 - display
 - icons 96
 - light 78
 - E**
 - email
 - receiving settings 70
 - bookmarks 71
 - cookies 72
 - security 72–73
 - settings 69–70
 - wizard 70
- using 48–??
 - wizard 70
 - emergency calls 24
 - Emergency numbers 24
- F**
 - file manager 17
 - fixed dialing 37
 - formatting text, in messages 43
- G**
 - games 68
 - glossary, messaging 56
 - groups 41
- H**
 - help texts, in phone 14
 - hiding number 40
- I**
 - icons, in display 96
 - instant messaging *See My friends* 52
 - internal antenna 11
 - international calls 23
 - Internet
- file manager 17
 - fixed dialing 37
 - formatting text, in messages 43
- K**
 - key sound 66
 - keys 10
- L**
 - language
 - changing 14
 - in phone 14, 85
 - letters
 - entering 15–17
 - quick keys 20
 - light, display 78
 - locks
 - phone lock 86
 - SIM card 80
 - long messages 44
- M**
 - magic word 31

Index

- making calls 19
 - media player 64–65
 - melodies 65–66
 - menu language 85
 - menus 13, 19
 - using shortcuts 14
 - message alert 66
 - messages
 - area information 55
 - cell information 56
 - email 48
 - glossary 56
 - instant 52
 - picture 45
 - text 42
 - microphone, turning off/on 22
 - missed calls 23
 - MMS *See* picture messages 45
 - model name 19
 - multitap text input
 - entering 15
 - quick keys 20
 - music, playing 64
 - MusicDJ™ 66
 - My friends 52–54
 - N**
 - network operator services 83
 - networks, selecting 21
 - notepad 40
 - notes 78
 - number
 - hiding 40
 - my own 36
 - O**
 - on if silent 66
 - online services 83
 - P**
 - passcodes, code memc 82
 - passwords, Internet 72
 - pause 20
 - PC Applications 74
 - personal ringtones 66
 - phone language 14
 - phone lock 81, 86
 - phone overview 10
 - phonebook
 - adding contacts 25
 - checking memory 28
 - synchronizing 73
 - picture messages 45–48
 - picture sizes 60
 - pictures 61–63
 - adding to contacts 25
 - PTN code
 - changing 81
 - entering 7
 - priority, when calling 39
 - profiles 78–79
 - PUK 81, 86
- Q**
 - quick keys 19
 - R**
 - recording
 - calls 67
 - sounds 67
 - video clips 59
 - voice commands 30–32
 - redialing 23

Index

- using call list 28
- resetting phone 84
- restricted dialing 37
- ringtones 65–66
 - adding to contacts 25
 - roaming 21
- S**
 - safety guidelines 95
 - saving
 - from picture messages 47
 - from text messages 44
 - screen 78
 - screen saver 63
 - security
 - code memo 82
 - Internet 72–73
 - SIM card lock 80
 - self-portrait 61
 - sending
 - appointments 77, 78
 - business cards 41
 - contacts 28
 - melodies and ringtones 67
 - notes 78
 - pictures 62–63
 - tasks 77, 78
 - themes 68
 - setup wizard 7
 - shortcuts 14, 19–21
 - SIM card
 - copying to/from 27
 - inserting 5
 - lock 80
 - phonebook 24
 - saving numbers on 24
 - unblocking 81
 - SIM numbers 24–26
 - SMS See text messages 42
 - sound recorder 67
 - speaker volume 22
 - speak-ephone 22
 - special Needs 87
 - speed dialing 29
 - start-up screen 80
 - stopwatch 79
 - strangers 54
 - streaming media 65
- synchronizing 73–74
- T**
 - T9 text input
 - entering letters 16
 - quick keys 21
 - tasks 77–78
 - templates
 - for picture messages 48
 - for text messages 44
 - text input, quick keys 20
 - text messages 42–45
 - themes 68
 - time, setting 74
 - timer 80
 - TTY 87
 - Phone Number 87
 - turning on/off
 - key sound 66
 - phone 8
 - phone lock 82
 - ringtones, melodies 65
 - SIM lock protection 81
 - two voice lines 35

- U**
 - unblocking
 - contacts 54
 - PIN 6
 - SIM card 81
- V**
 - vibrating alert 66
 - video clips 64
 - video recorder 58–61
 - voice answering 32
 - voice control 30–33
 - voice dialing 31
 - voicemail 29
 - volume
 - changing 22
 - setting ringtone 66
 - vibrating alert 66
- W**
 - WAP *See* Internet 69
 - wizard
 - for Internet or email settings 70
 - setup 7
- writing
 - using multitap input 15
 - using T9 text input 16
 - writing languages 15
- Z**
 - zoom 59

Important Information

United States

THIS PHONE MODEL HAS BEEN CERTIFIED IN COMPLIANCE WITH THE GOVERNMENT'S REQUIREMENTS FOR EXPOSURE TO RADIO WAVES.

The Z500 Series mobile phones have been designed to comply with applicable safety requirements for exposure to radio waves. Your wireless phone is a radio transmitter and receiver. It is designed to not exceed the limits for exposure to radio frequency (RF) energy set by the Federal Communications Commission (FCC) of the U.S. Government. These limits establish permitted levels of RF energy for the general population. The guidelines are based on standards that were developed by international scientific organizations through periodic and thorough evaluation of scientific studies. The standards include a safety margin designed to assure the safety of all persons, regardless of age and health.

The exposure standard for wireless mobile phones employs a unit of measurement known as the Specific Absorption Rate, or SAR. The SAR limit set by the FCC is 1.6W/kg.* Tests for SAR are conducted using standard operating positions accepted by the FCC with the phone transmitting at its highest certified power level in all tested frequency bands. Although the SAR is determined at the highest certified power level, the actual SAR level of the phone while operating can be well below the maximum value. This is because the phone is designed to operate at multiple power levels so as to use only the power required to reach the network. In general, the closer you are to a wireless base station antenna, the lower the power output. Before a phone model is available for sale to the public, it must be tested and certified to the FCC that it does not exceed the limit established by the government-adopted requirement for safe

exposure. The tests are performed in positions and locations (i.e., at the ear and worn on the body) as required by the FCC for each model. The highest SAR value as reported to the FCC for this model phone when tested for use at the ear is 1.45 W/kg and when worn on the body is 0.97 W/kg. Body worn measurements are made while the phone is in use and worn on the body with an Ericsson or Sony Ericsson accessory supplied with or designated for use with this phone. It is therefore recommended that only Ericsson and Sony Ericsson original accessories be used in conjunction with Sony Ericsson phones. The FCC has granted an Equipment Authorization for this model phone with all reported SAR levels evaluated as in compliance with the FCC RF exposure guidelines. While there may be differences between the SAR levels of various phones, all mobile phones granted an FCC equipment authorization meet the government requirement for safe exposure.

SAR information on this model phone is on file with the FCC and can be found under the Display Grant section of <http://www.fcc.gov/etfccid> after searching on FCC ID PY7AF61011. Additional information on Specific Absorption Rates (SAR) can be found on the Cellular Telecommunications & Internet Association (CTIA) website at <http://phonedata.net/>.

** In the United States and Canada, the SAR limit for mobile phones used by the public is 1.6 watts/kg (W/kg) averaged over one gram of tissue. The standard incorporates a margin of safety to give additional protection for the public and to account for any variations in measurements.*

Important Information - Canada

Radio wave exposure and Specific Absorption Rate (SAR) information

The Z500 Series mobile phones have been designed to comply with applicable safety requirements for exposure to radio waves. These requirements are based on scientific guidelines that include safety margins designed to assure the safety of all persons, regardless of age and health.

The radio wave exposure guidelines employ a unit of measurement known as the Specific Absorption Rate, or SAR. Tests for SAR are conducted using standardized methods with the phone transmitting at its highest certified power level in all used frequency bands.

While there may be differences between the SAR levels of various phone models, they are all designed to meet the relevant guidelines for exposure to radio waves.

For more information on SAR, please refer to the safety chapter in the User's Guide.

SAR data information for residents in countries that have adopted the SAR limit recommended by the International Commission on Non-Ionizing Radiation Protection (ICNIRP), which is 2 W/kg averaged over ten (10) grams of tissue (for example, European Union, Japan, Brazil and New Zealand).

The highest SAR value for this model phone when tested by Sony Ericsson for use at the ear is 0.85 W/kg (10g).

SAR data information for residents in countries/regions that have adopted the SAR limit recommended by the Institute of Electrical and Electronics Engineers (IEEE), which is 1.6 W/kg averages over one (1) gram of tissue (for example USA, Canada, Australia and Taiwan):

The highest SAR value for this model phone when tested by Sony Ericsson for use at the ear is 1.45 W/kg (1g).

Renseignements sur le débit d'absorption spécifique (DAS) et l'exposition aux ondes radio

Les téléphones mobiles appartenants à la série Z500 ont été conçus conformément aux exigences de sécurité applicables quant à l'exposition aux ondes radio. Ces exigences sont fondées sur des directives scientifiques qui comprennent des marges de sécurité visant à assurer la sécurité de tous les individus, quels que soient leur âge et leur état de santé.

Le taux d'absorption spécifique, ou SAR, est une unité de mesure utilisée dans les directives d'exposition aux ondes radio. Les tests relatifs au SAR sont menés à l'aide de méthodes normalisées, avec une transmission à la plus haute puissance certifiée du téléphone dans toutes les bandes de fréquences utilisées.

Bien qu'il y ait des différences entre les niveaux de SAR des divers modèles des téléphones, ils sont tous conçus conformément aux directives applicables en matière d'exposition aux ondes radio.

Pour obtenir de plus amples renseignements sur le SAR, veuillez consulter le chapitre sur la sécurité du guide de l'utilisateur.

Valeur SAR pour les résidents des pays ayant adopté la limite SAR recommandée par l'International Commission on Non-Ionizing Radiation Protection (ICNIRP), soit 2 watts/kg en moyenne pour dix (10) grammes de tissus (par exemple l'Union européenne, le Japon, le Brésil et la Nouvelle-Zélande).

La valeur SAR la plus élevée pour ce modèle de téléphone lorsque testé à l'oreille par Sony Ericsson est de 0,85 watts/kg (10 grammes).

Valeur SAR pour les résidents des pays/regions ayant adopté la limite SAR recommandée par l'Institute of Electrical and Electronics Engineers (IEEE), soit de 1,6 watts/kg en moyenne pour un (1) gramme de tissus (par exemple les Etats-Unis, le Canada, l'Australie et Taiwan): la valeur SAR la plus élevée pour ce modèle de téléphone lorsque testé à l'oreille par Sony Ericsson est de 1,41 watts/kg (1 gramme).

Important Information - Rest of the World

Radio wave exposure and Specific Absorption Rate (SAR) information

The Z500 Series mobile phones have been designed to comply with applicable safety requirements for exposure to radio waves. These requirements are based on scientific guidelines that include safety margins designed to assure the safety of all persons, regardless of age and health.

The radio wave exposure guidelines employ a unit of measurement known as the Specific Absorption Rate, or SAR. Tests for SAR are conducted using standardised methods with the phone transmitting at its highest certified power level in all used frequency bands.

While there may be differences between the SAR levels of various phone models, they are all designed to meet the relevant guidelines for exposure to radio waves.

For more information on SAR, please refer to the safety chapter in the User's Guide.

SAR data information for residents in countries that have adopted the SAR limit recommended by the International Commission on Non-Ionizing Radiation Protection (ICNIRP), which is 2 W/kg averaged over ten (10) gram of tissue (for example European Union, Japan, Brazil and New Zealand):

The highest SAR value for this model phone when tested by Sony Ericsson for use at the ear is 0.85 W/kg (10g).

Información acerca de la exposición a ondas de radio y la Tasa específica de absorción (SAR)

Los teléfonos móviles pertenecientes a la serie Z500 ont été conçus conformément aux exigences de sécurité applicables quant à l'exposition aux ondes radio. Dichos requisitos se basan en directrices científicas que establecen márgenes de seguridad con el fin de evitar perjuicios a todas las personas, independientemente de su edad o estado de salud.

Las directrices de exposición a ondas de radio utilizan una unidad de medida denominada coeficiente de absorción específica o SAR. Las pruebas de SAR se llevan a cabo utilizando métodos normalizados, con el teléfono transmitiendo en el nivel más elevado de potencia autorizado en todas las bandas de frecuencia utilizadas.

Aunque puede existir diferencias entre los niveles de SAR de diferentes modelos de teléfono, todos han sido diseñados para cumplir las directrices pertinentes sobre exposición a ondas de radio. Para obtener más información sobre el SAR, consulte el capítulo sobre seguridad en la guía del usuario.

Información sobre datos de SAR para residentes de países en los que se haya adoptado el límite de SAR recomendado por la International Commission on Non-Ionizing Radiation Protection (ICNIRP, Comisión internacional de protección contra la radiación no ionizante (ICNIRP, International Commission on Non-Ionizing Radiation Protection), es 2 W/kg promedio por cada diez (10) gramos de tejido (por ejemplo, la Unión Europea, Japón, Brasil y Nueva Zelanda):

El valor de SAR más elevado para este modelo de teléfono cuando Sony Ericsson realizó la prueba para su uso en la oreja era de 0.85 W/kg (10g).

www.SonyEricsson.com



Sony Ericsson Mobile Communications AB, SE-221 88 Lund, Sweden
AELZT 123 1784 R1A