

Thank you for purchasing a Sony Ericsson G700. For additional phone content, go to [www.sonyericsson.com/fun](http://www.sonyericsson.com/fun).

Register now to get free online storage and special offers at [www.sonyericsson.com/myphone](http://www.sonyericsson.com/myphone).

For product support, go to [www.sonyericsson.com/support](http://www.sonyericsson.com/support).

# Accessories – More for your phone

## Bluetooth™ Headset HBH-PV703

Go wireless with a powerful headset



## GPS Enabler HGE-100

Get more from your phone  
- add GPS technology. Know where  
you are, where you're going and how  
to get there.



## Bluetooth™ Car Speakerphone HCB-150

High performance car handsfree with  
text to speech for convenient calls on  
the road



These accessories can be purchased separately but may not be available in every market. To view the full range, go to [www.sonyericsson.com/accessories](http://www.sonyericsson.com/accessories).

# Contents

<b>Getting started</b> .....	<b>5</b>	Memory card .....	19
Welcome .....	5	Notes .....	20
Instruction symbols .....	5	Torch .....	21
Additional help .....	5	Text entry .....	21
Package .....	6	<b>Calling</b> .....	<b>25</b>
Overview .....	7	Networks .....	25
Before using your phone .....	9	Making a call .....	25
First time start-up .....	11	Receiving a call .....	26
<b>Getting to know the phone</b> ...	<b>13</b>	Handling two or more calls ...	26
Turning the phone on and off	13	Video calls .....	27
The screen .....	13	Call log .....	28
Navigation .....	14	Handsfree .....	28
Finding the applications .....	14	More features .....	28
Using the applications .....	15	Using contacts .....	29
Task manager .....	15	Creating contacts .....	29
Connecting accessories .....	16	Editing contacts .....	30
Updating software .....	16	Managing contacts .....	30
Main menu overview* .....	17	<b>Internet</b> .....	<b>32</b>
.....	17	Internet browser .....	32
.....	17	RSS feeds .....	33
Status bar .....	18	Blog .....	33
Importing contact entries .....	19		
Sound .....	19		

<b>Messaging</b> .....	<b>34</b>	<b>Connectivity</b> .....	<b>51</b>
Before you use Messaging ....	34	PC Suite .....	51
Shortcut to Messaging .....	34	USB connection .....	51
Messages .....	34	Synchronization .....	52
Folders .....	34	Bluetooth connection .....	53
SMS .....	35	Connections manager .....	53
MMS .....	35	Wap push .....	53
Email .....	37	Certificate manager and Java cer-	
More about Messaging .....	38	tificates .....	53
<b>Media</b> .....	<b>41</b>	<b>More features</b> .....	<b>55</b>
Transferring media files .....	41	Managing files and applications	
Updating media files .....	41	55	
Photos and pictures .....	41	Master reset .....	56
Music and audio tracks .....	43	Power save .....	56
Video .....	44	Screen saver .....	57
<b>Camera</b> .....	<b>45</b>	<b>Important information</b> .....	<b>58</b>
Taking pictures and video clips .		FCC Statement .....	66
45		Declaration of Conformity for	
Changing the camera settings	46	G700 .....	67
Viewer .....	47	<b>Index</b> .....	<b>68</b>
<b>Entertainment</b> .....	<b>48</b>	<b>Sony Ericsson G700</b>	
PlayNow™ .....	48	UMTS 2100 GSM 900/1800/1900	
FM radio .....	48	This User guide is published by Sony Ericsson	
TrackID™ .....	50	Mobile Communications AB or its local affiliated	
		company, without any warranty. Improvements and	
		changes to this User guide necessitated by	

typographical errors, inaccuracies of current information, or improvements to programs and/or equipment, may be made by Sony Ericsson Mobile Communications AB or its local affiliated company at any time and without notice. Such changes will, however, be incorporated into new editions of this User guide.

All rights reserved.

©Sony Ericsson Mobile Communications AB,  
2008

Publication number: 1209-0959.1

Please note:

Some of the services in this User guide are not supported by all networks. *This also applies to the GSM International Emergency Number 112.*

Please contact your network operator or service provider if you are in doubt whether you can use a particular service.

Please read the *Guidelines for safe and efficient use* and the *Limited warranty* chapters before you use your mobile phone.

Your mobile phone has the capability to download, store and forward additional content, for example, ringtones. The use of such content may be restricted or prohibited by rights of third parties, including but not limited to restriction under applicable copyright laws. You, and not Sony Ericsson, are entirely responsible for additional content that you download to or forward from your mobile phone. Prior to your use of any additional content, please verify that your intended use is properly licensed or is otherwise authorized. Sony Ericsson does not guarantee the accuracy, integrity or quality of any additional content or any other third party content. Under no circumstances will Sony Ericsson be liable in any way for your improper use of additional content or other third party content.

The Liquid Identity logo, PlayNow, TrackID and MusicDJ are trademarks or registered trademarks of Sony Ericsson Mobile Communications AB.

Sony, Memory Stick Micro and M2 are trademarks or registered trademarks of Sony Corporation.

Ericsson is a trademark or registered trademark of Telefonaktiebolaget LM Ericsson.

TrackID™ is powered by Gracenote Mobile MusicID™. Gracenote and Gracenote Mobile MusicID are trademarks or registered trademarks of Gracenote, Inc.

Bluetooth is a trademark or a registered trademark of Bluetooth SIG Inc. and any use of such mark by Sony Ericsson is under license.

Real is a trademark or a registered trademark of RealNetworks, Inc. Copyright 1995-2008, RealNetworks, Inc. All rights reserved.

Adobe and Acrobat are trademarks or registered trademarks of Adobe Systems Incorporated in the United States and/or other countries.

Microsoft, Microsoft Excel, Microsoft Word, Microsoft PowerPoint, Microsoft Outlook and Windows are either registered trademarks or trademarks of Microsoft Corporation in the United States and/or other countries.

Java and all Java based trademarks and logos are trademarks or registered trademarks of Sun Microsystems, Inc. in the U.S. and other countries. End-user license agreement for Sun™ Java™ J2ME™.

Restrictions:

- 1 Software is confidential copyrighted information of Sun and title to all copies is retained by Sun and/or its licensors. Customer shall not modify, decompile, disassemble, decrypt, extract, or otherwise reverse engineer Software. Software may not be leased, assigned, or sublicensed, in whole or in part.
- 2 Export Regulations: Software, including technical data, is subject to U.S. export control laws, including the U.S. Export Administration Act and its associated regulations, and may be subject to export or import regulations in other countries. Customers agree to comply strictly with all such

regulations and acknowledges that it has the responsibility to obtain licenses to export, re-export, or import Software. Software may not be downloaded, or otherwise exported or re-exported (i) into, or to a national or resident of, Cuba, Iraq, Iran, North Korea, Libya, Sudan, Syria (as such listing may be revised from time to time) or any country to which the U.S. has embargoed goods; or (ii) to anyone on the U.S. Treasury Department's list of Specially Designated Nations or the U.S. Commerce Department's Table of Denial Orders.

- 3 Restricted Rights: Use, duplication or disclosure by the United States government is subject to the restrictions as set forth in the Rights in Technical Data and Computer Software Clauses in DFARS 252.227-7013(c) (1) (ii) and FAR 52.227-19(c) (2) as applicable.

Other product and company names mentioned herein may be the trademarks of their respective owners.

Any rights not expressly granted herein are reserved.

All illustrations are for guidance only and may not accurately depict the actual phone.

# Getting started

## Welcome

Welcome as a G700 user.

This User guide will help you get started using your new phone. To get most out of your phone, please read this chapter first.

## Instruction symbols

The following symbols appear in the User guide:

 Note

 Tip



A service or function is network- or subscription-dependent. Contact your network operator for details.



## Additional help

The complete user documentation for your phone consists of:

- **User guide** – an overview of your phone.
- **Help in the phone** – in most applications **Help** is available in the **More** menu.
- **Web guide** – an up-to-date user guide with step-by-step instructions and additional information on features available in your phone. You can access the Web guide at [www.sonyericsson.com/support](http://www.sonyericsson.com/support).

### *To access the Web guide from your phone*

- 1 From Standby select **Main menu > Internet**.
- 2 Select **More > View > Bookmarks > Web Guide**.

### **Care instructions**

- Use a moist cloth when you clean the screen.
- Only use the stylus provided, or your fingertips, when selecting items on the screen.

For detailed care instructions, see *Recommendations for care and safe use of our products* on page 60.

## Package



---

1 Phone G700

---

2 Charger CST-70

---

3 Stylus

---

4 USB cable DCU-65

---

5 Battery BST-33

---

6 User guide

---

7 CD with PC suite and Media manager software

---

**!** *If your package does not include all the listed items please contact your retailer.*



## Overview

- 
- 1 Video telephony camera
  - 2 Earspeaker
  - 3 Screen
  - 4 Menu selection key
  - 5 Note key (for Note application)
  - 6 Back key
  - 7 5-way navigation key
  - 8 Silent key
  - 9 C key (Clear)
  - 10 Camera key
  - 11 Messaging key
  - 12 Volume down key
  - 13 Volume up key
  - 14 On/off button
- 

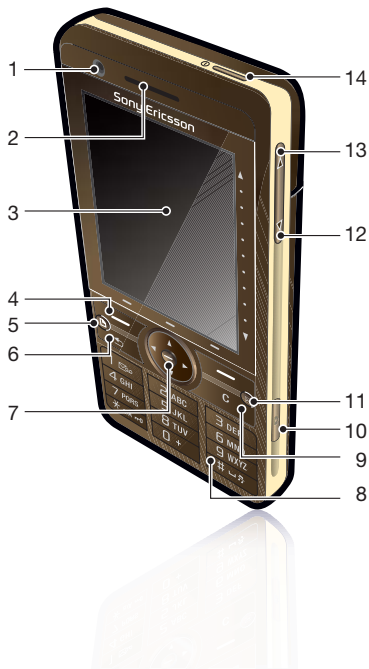

---

15 Camera light and Torch

---

16 3.2 megapixel camera

---

17 Battery cover

---

18 Loudspeaker

---

19 Microphone

---

20 Strap holder

---

21 Indicator light

---

22 Connector for charger and accessories

---

23 Memory card slot

---

24 Lock key

---

25 Stylus

---

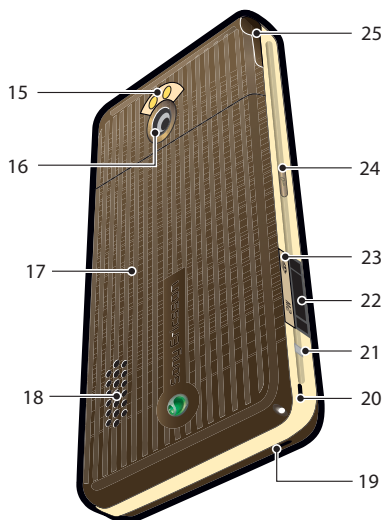

## Before using your phone



### SIM card

You receive a SIM (Subscriber Identity Module) card when you register with a network operator. The SIM card keeps track of your phone number, the services included in your subscription and contacts. A PIN code is supplied with the SIM card and must be entered, if requested, when you turn your phone on for the first time.

#### *To insert the SIM card*

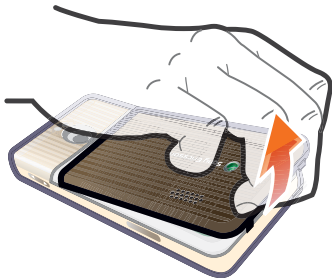

- 1 Open the battery cover by pressing and pulling the lower part of the cover at the bottom of the phone.

- 2 Remove the battery.

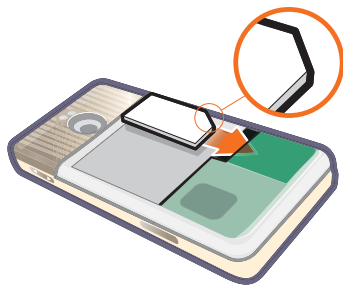

- 3 Insert the SIM card into the SIM card holder. Make sure you insert it as shown in the image.

### Battery

#### *To insert the battery*

- 1 Detach the charger (if connected).
- 2 Open the battery cover by pressing and pulling the lower part of the cover at the bottom of the phone.

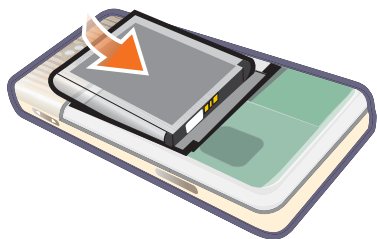

**3** Insert the battery.

The battery needs to be charged if the indicator light flashes red, or the low battery message appears on the screen. To fully charge the battery could take up to 2.5 hours.

**To charge the battery**

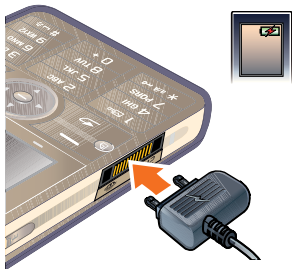

- 1 Connect the charger to the mains.
- 2 Connect the charger to the phone.

**To disconnect the charger**

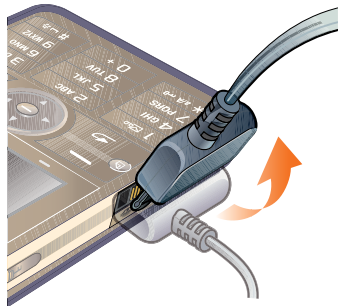

- Remove the charger by tilting the plug upwards.

## First time start-up

- ! *Before you can use your phone you need to insert the SIM card, and insert and charge the battery.*

### To turn on the phone

- 1 Press and hold down the On/off button.
- 2 Select **Phone on**.
- 3 Select a language.

- 💡 *All languages except UK English will be deleted once you have selected a language. You can download additional languages from [www.sonyericsson.com/support](http://www.sonyericsson.com/support).*

- 4 Enter your PIN, if requested.
- 5 Select **Done**.

- 💡 *If you make a mistake when you enter your PIN code, you can delete the number by pressing . If you enter the wrong PIN code three times in a row, the SIM card is blocked. To unblock it, you need to enter the PUK code supplied with your SIM card.*

The start-up screen is referred to as Standby in this User guide.



### IMEI number

IMEI (International Mobile Equipment Identifier) is a 15-digit number. Your operator can use

the IMEI number to enable a complete barring of your phone if it is stolen. The number is printed underneath the battery compartment. You can also view the number on the phone display.

### To view the IMEI number in your phone

From Standby enter **\*#06#**.

### Keylock

Your phone has a dedicated lock key making it easy to lock and unlock the keypad on your phone. The automatic keylock on your phone is turned on as default.

### To turn off automatic keylock

- 1 From Standby select **Main menu > Settings > Security > Locks**.
- 2 Unmark the **Automatic keylock** check box.

### To lock and unlock the keypad using the lock key

- Press the lock key .



### Wizards

There are three wizards available to help you set up your phone. The Setup wizard, the Internet wizard and the Email wizard. The Setup wizard and the Internet

wizard are launched the first time you start the phone. The Email wizard is launched when first launching Email accounts. It is possible to launch all wizards from the Main menu at any time. For more information about the wizards see the Web guide.

# Getting to know the phone

## Turning the phone on and off

### *To turn on the phone*

- 1 Press and hold down the On/off button.
- 2 Select **Phone On**.

### *To turn off the phone*

- 1 Press and hold down the On/off button.
- 2 Select **Power Off**.

## The screen

The screen is touch-sensitive. You can use the stylus or your fingertips to select items.

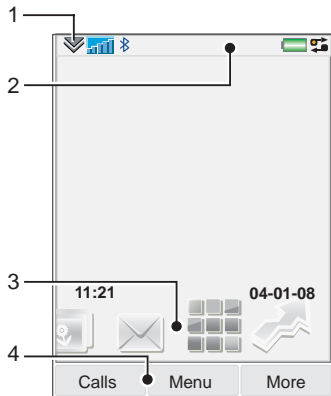





- 
- |   |                       |
|---|-----------------------|
| 1 | Status bar menu       |
| 2 | Status bar with icons |
| 3 | Panels                |
| 4 | Selection keys        |
-

## Navigation



There are several ways to navigate menus and select items in your phone. You can use the 5-way navigation key, back button, stylus, keyboard navigation keys, touch options or your fingertips.

### 5-way navigation

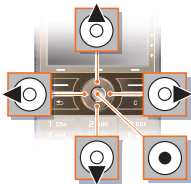
The navigation key consists of a ring and a center key. The ring is used for going up  and down , left  and right . The center key  is used for selection.



### Back key

You can press  to return to the previous screen or menu. You can press and hold down  to return to Standby.

### Stylus

Use the stylus to select items on the screen and to navigate menus or to pan multimedia pictures.

## Finding the applications



### Standby

The Standby application is displayed when you turn on your phone.

#### *To change view in Standby*

- 1 Select **Main menu > Settings > Display > Standby application.**
- 2 Select:
  - **Business** to show the Today view.
  - **None** to show an enlarged clock. No panels or shortcuts will be shown.
  - **Default** to show the panels.

### Panels

Using panels you get quick access to applications and tasks. By default four panels are always shown. These four are **My shortcuts**, **Favourite contacts**, **Calendar** and **New messages**.

There are several other panels you can add and remove. For more information about panels, see the *Web guide at [www.sonyericsson.com/support](http://www.sonyericsson.com/support).*