

SONY

Model: KDL-46EX700

Description: LCD TV

Dimensions: 44 $\frac{1}{8}$ " 28 $\frac{3}{4}$ " 11"

(WHD): 44 $\frac{1}{8}$ " 27 $\frac{1}{2}$ " 2 $\frac{1}{2}$ " w/o stand

Weight: TBD

Carton Dimensions: tbd
(WHD):

Power 120V AC
requirements: 60HZ

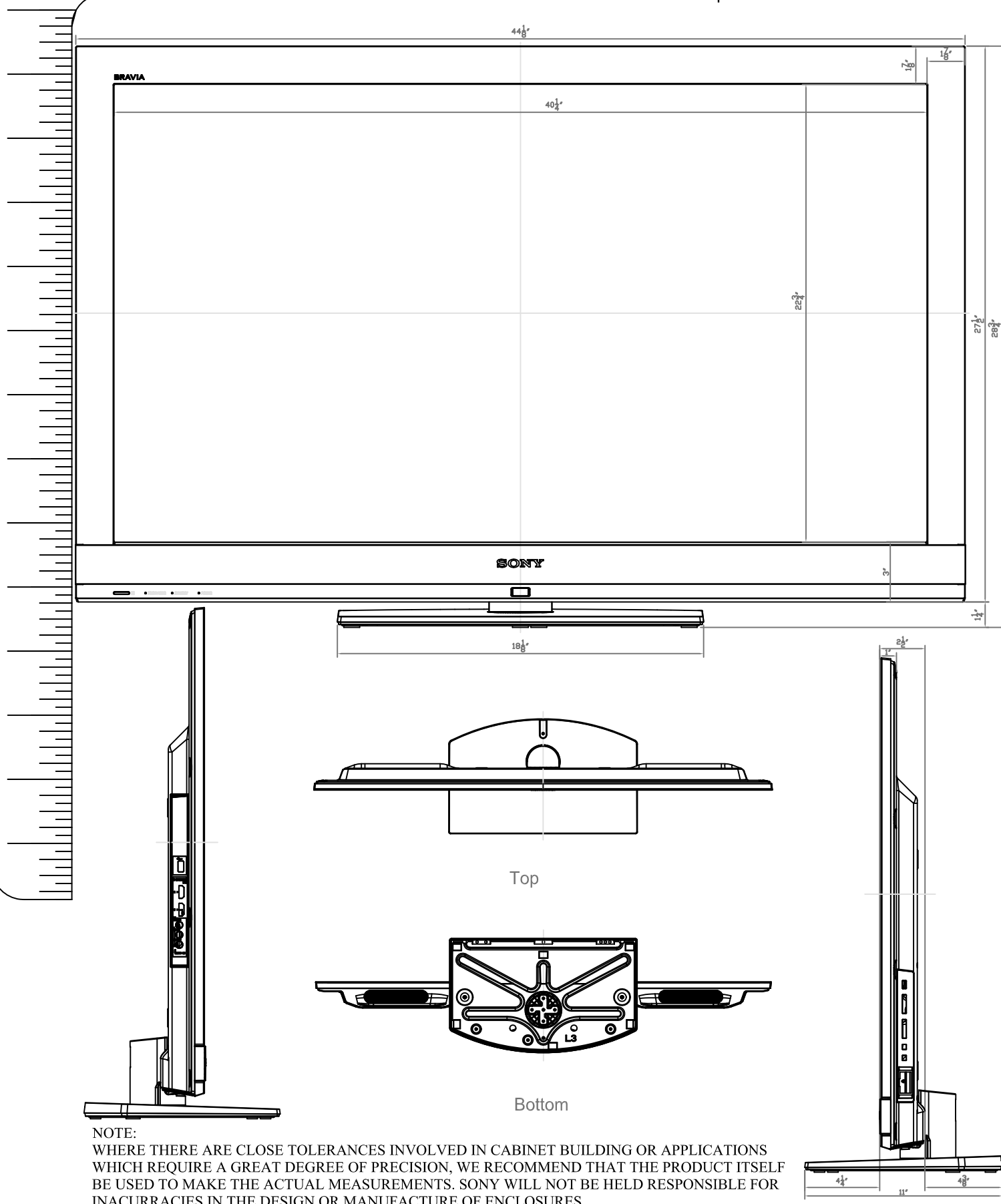

NOTE:
WHERE THERE ARE CLOSE TOLERANCES INVOLVED IN CABINET BUILDING OR APPLICATIONS WHICH REQUIRE A GREAT DEGREE OF PRECISION, WE RECOMMEND THAT THE PRODUCT ITSELF BE USED TO MAKE THE ACTUAL MEASUREMENTS. SONY WILL NOT BE HELD RESPONSIBLE FOR INACCURACIES IN THE DESIGN OR MANUFACTURE OF ENCLOSURES.

SONY

Model:KDL-46EX700

Description: LCD TV

Dimensions: 44 $\frac{1}{8}$ " 28 $\frac{3}{4}$ " 11"

(WHD): 44 $\frac{1}{8}$ " 27 $\frac{1}{2}$ " 2 $\frac{1}{2}$ " w/o stand

Weight: TBD

Carton Dimensions: tbd (WHD):

Power requirements: 120V AC 60HZ

M6x(8 to 12+t)
(t=VESA PLATE THICKNESS)
or PSW6x16(for SONY wall mount)

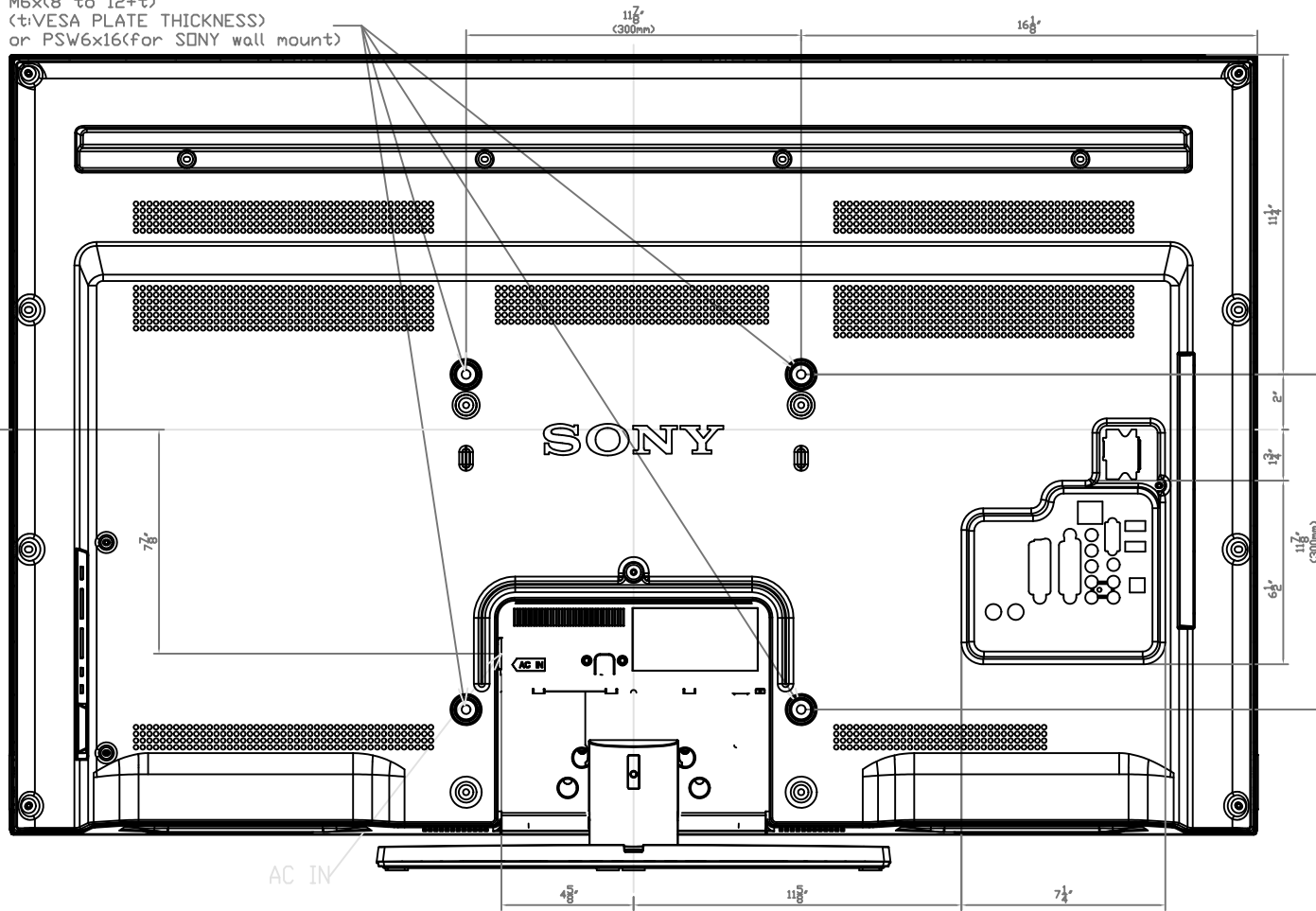

SU-WL50B

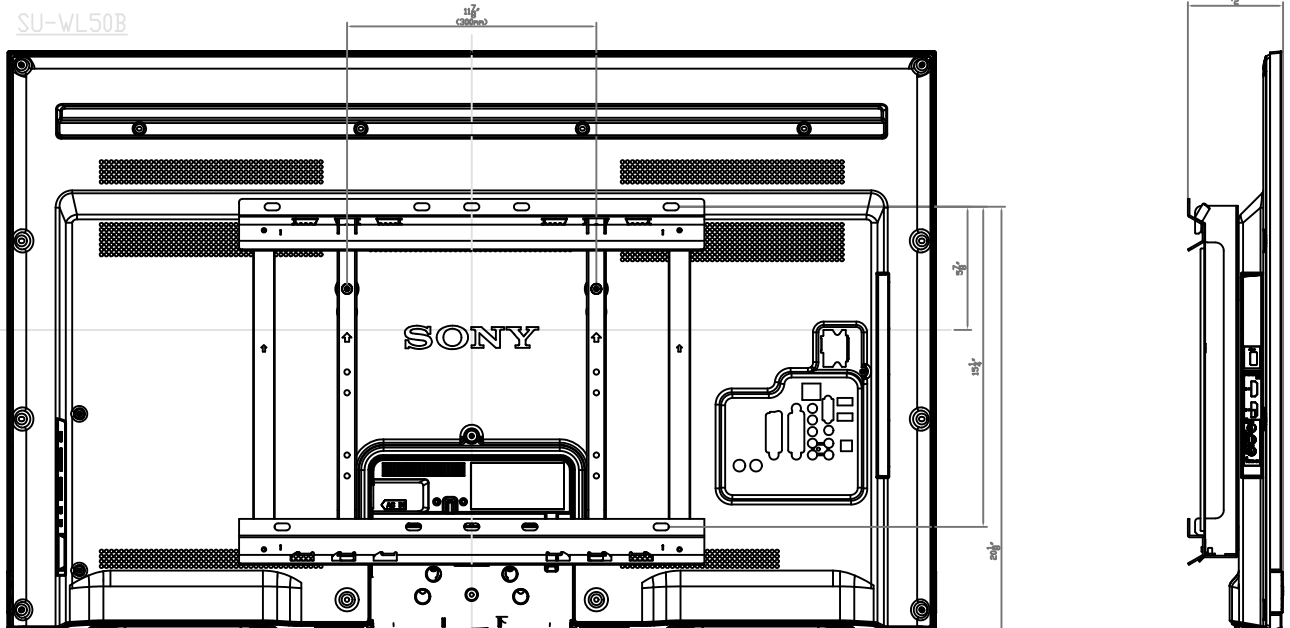

NOTE:

WHERE THERE ARE CLOSE TOLERANCES INVOLVED IN CABINET BUILDING OR APPLICATIONS WHICH REQUIRE A GREAT DEGREE OF PRECISION, WE RECOMMEND THAT THE PRODUCT ITSELF BE USED TO MAKE THE ACTUAL MEASUREMENTS. SONY WILL NOT BE HELD RESPONSIBLE FOR INACCURACIES IN THE DESIGN OR MANUFACTURE OF ENCLOSURES.

SONY

Model: KDL-46EX700

Description: LCD TV

Dimensions: 44 $\frac{1}{8}$ " 28 $\frac{3}{4}$ " 11"

(WHD): 44 $\frac{1}{8}$ " 27 $\frac{1}{2}$ " 2 $\frac{1}{2}$ " w/o stand

Weight: TBD

Carton Dimensions: tbd

(WHD):

Power 120V AC

requirements: 60HZ

SU-WL500

11 $\frac{1}{2}$ "
(300mm)

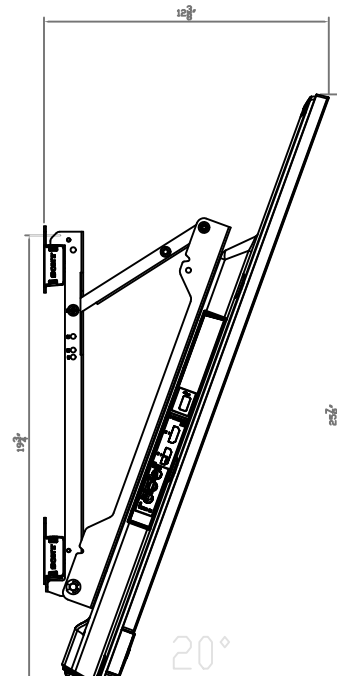
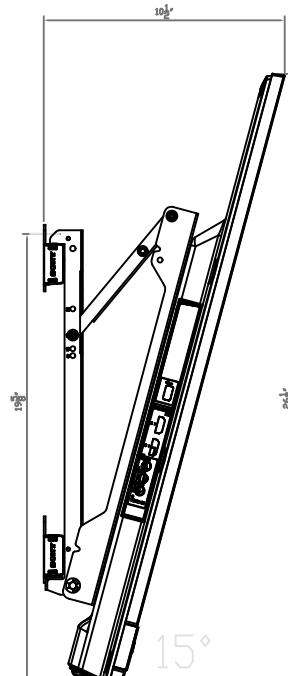
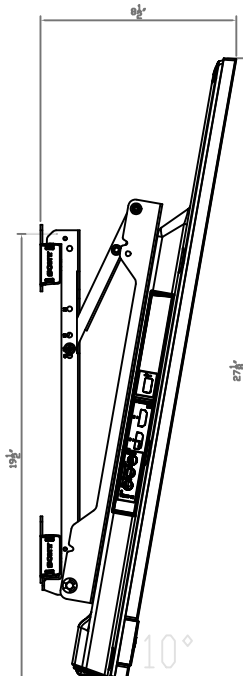
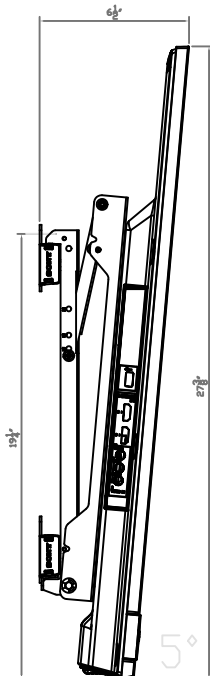
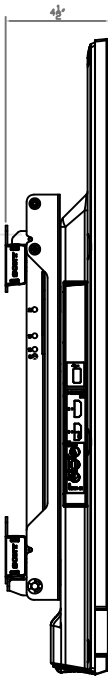
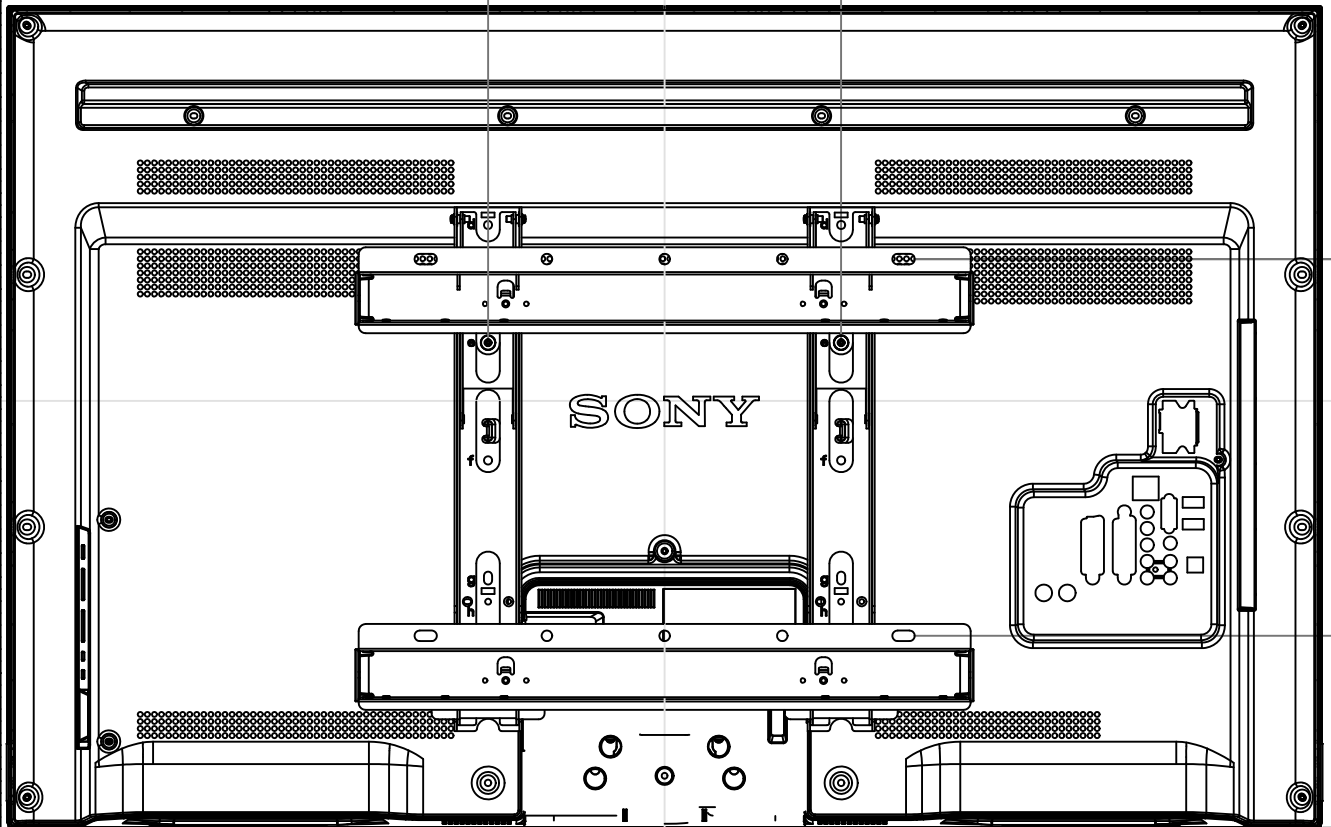

NOTE:

WHERE THERE ARE CLOSE TOLERANCES INVOLVED IN CABINET BUILDING OR APPLICATIONS WHICH REQUIRE A GREAT DEGREE OF PRECISION, WE RECOMMEND THAT THE PRODUCT ITSELF BE USED TO MAKE THE ACTUAL MEASUREMENTS. SONY WILL NOT BE HELD RESPONSIBLE FOR INACCURACIES IN THE DESIGN OR MANUFACTURE OF ENCLOSURES.