

Area	JAPAN	NORTH AMERICA	LATIN AMERICA	EUROPE	GENERAL AREA	CHINA
Model Name	KDL-55W800A	KDL-55W800A	KDL-55W801A	KDL-55W800A	KDL-55W800A	KDL-55W800A
SV. No	SV-24046	SV-24023	SV-24328	SV-24007	SV-24207	SV-24246
TV only (WxHxD)	125.3x73.5x6.4(4.64) cm	1253x735x64(46.4) mm / 49 3/8 x 29 x 2 5/8(1 7/8) inch	1253x735x64(46.4) mm	Approx. 125.3x73.5x6.4(4.64) cm	Approx. 1253x735x64(46.4) mm	Approx. 1253x735x64(46.4) mm
TV with Stand (WxHxD)	125.3x76.8x29.8 cm	1253x768x298 mm / 49 3/8 x 30 1/4 x 11 3/4 inch	1253x768x298 mm	Approx. 125.3x76.8x29.8 cm	Approx. 1253x768x298 mm	Approx. 1253x768x298 mm
Media Receiver (WxHxD)	-	-	-	-	-	-
Monitor only (WxHxD)	-	-	-	-	-	-
Monitor with Stand (WxHxD)	-	-	-	-	-	-
Media Receiver with Stand (WxHxD)	-	-	-	-	-	-
Satellite Speaker (WxHxD)	-	-	-	-	-	-
Stand Width	46.1 cm	461 mm / 18 1/4 inch	461 mm	Approx. 46.1 cm	Approx. 461 mm	Approx. 461 mm
VESA Hole Pitch	30.0x30.0 cm	300x300 mm / 11 7/8 x 11 7/8 inch	300x300 mm	30.0x30.0 cm	300x300 mm	300x300 mm
TV Only	18.4 Kg	18.4 Kg / 40.6 lb	18.4 Kg	Approx. 18.4 Kg	Approx. 18.4 Kg	Approx. 18.4 Kg
TV With Stand	20.7 Kg	20.7 Kg / 45.6 lb	20.7 Kg	Approx. 20.7 Kg	Approx. 20.7 Kg	Approx. 20.7 Kg
Media Receiver	-	-	-	-	-	-
Monitor Only	-	-	-	-	-	-
Monitor With Stand	-	-	-	-	-	-
Media Receiver with Stand	-	-	-	-	-	-
Satellite Speaker	-	-	-	-	-	-
Remarks						

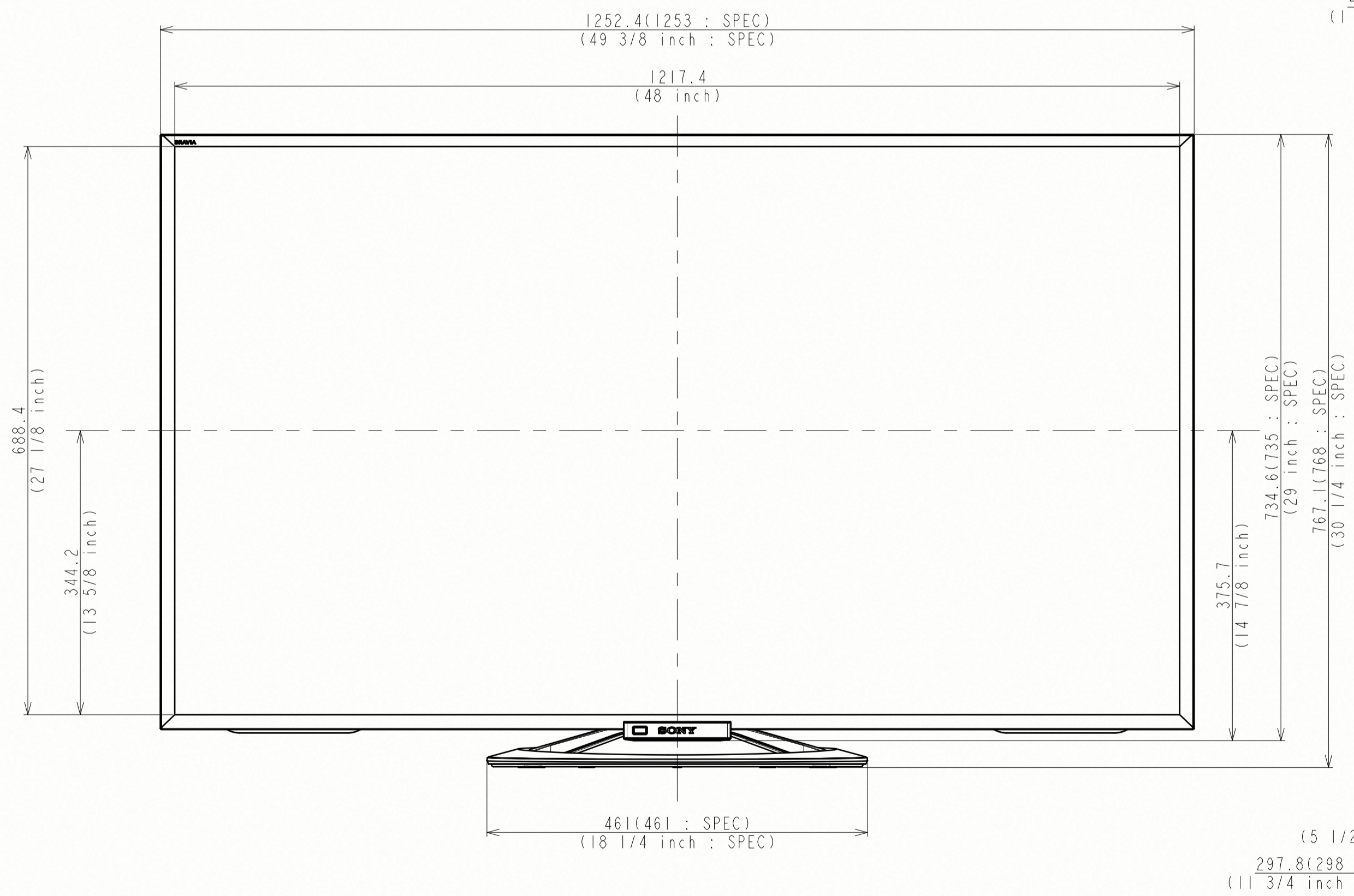

M6 Holes for wall mount bracket
* Refer instruction manual for screw length information

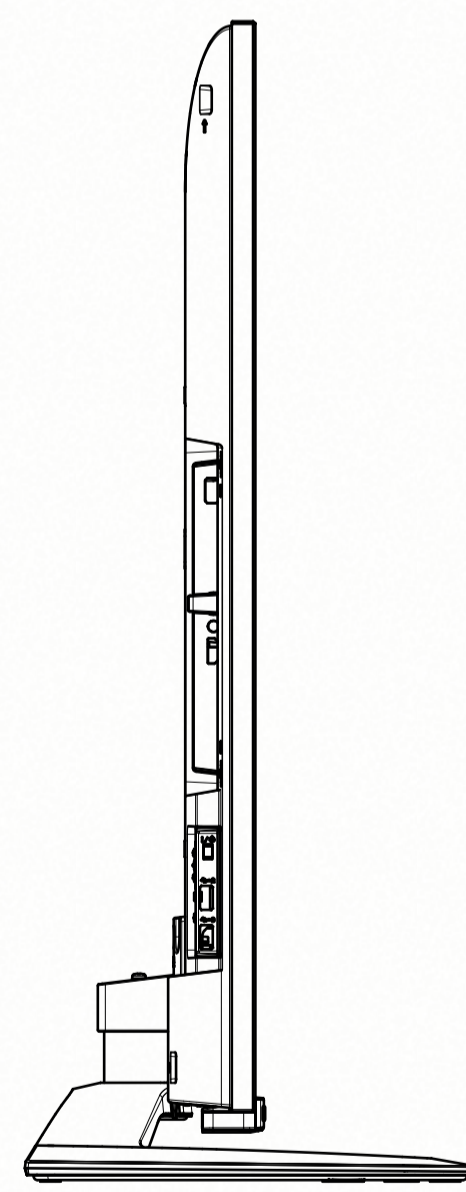
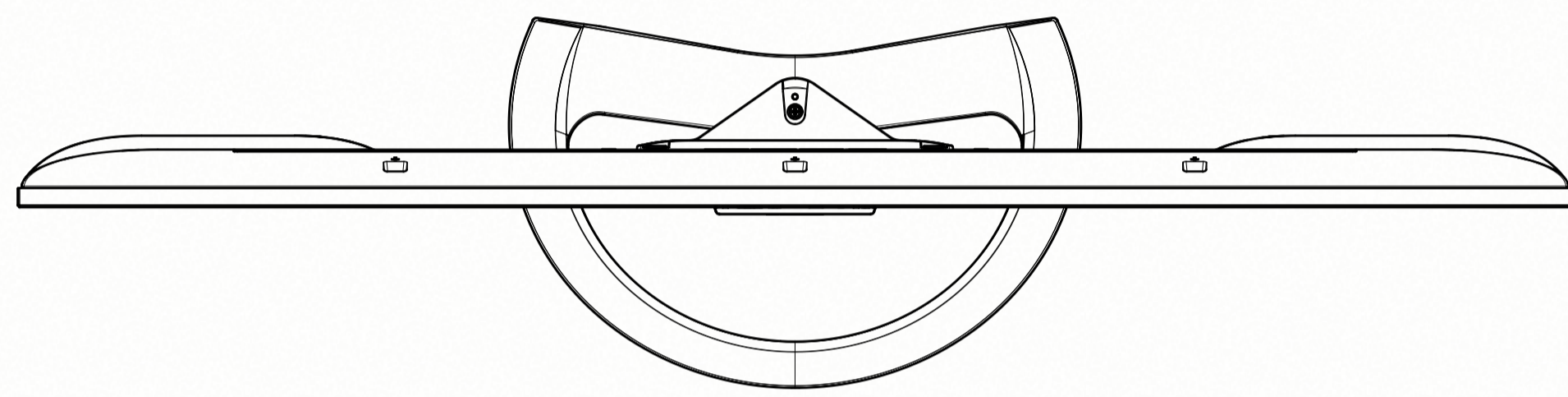
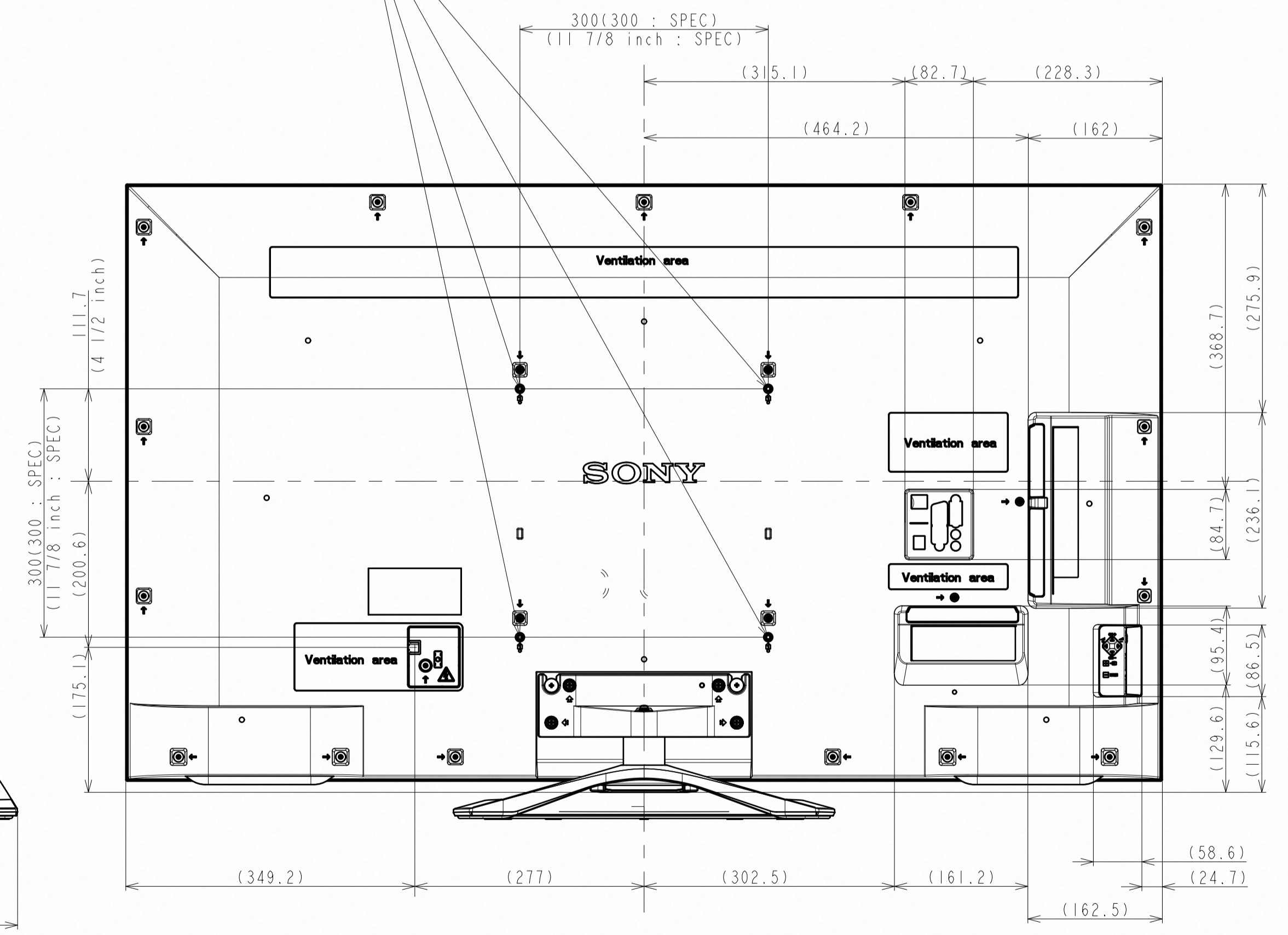

UNIT	mm	TOLERANCE	USED ON	RANK
ANGLE				FAMILY
SCALE	1:5			ORIGINAL MODEL
				FINISH COLOR
TITLE/DESCRIPTION				
#1 55 (W800) EXTERIOR VIEW				
#2 55 (W800) EXTERIOR VIEW				
HISTORY SHEET		ECS-NO.		REVISION
1	COUNT	REV.	DATE	SIGN.
DRAWN BY		PLANNED BY	CHECKED BY	APPROVED BY
DRAWING NO.		PART NO.		PART NO.

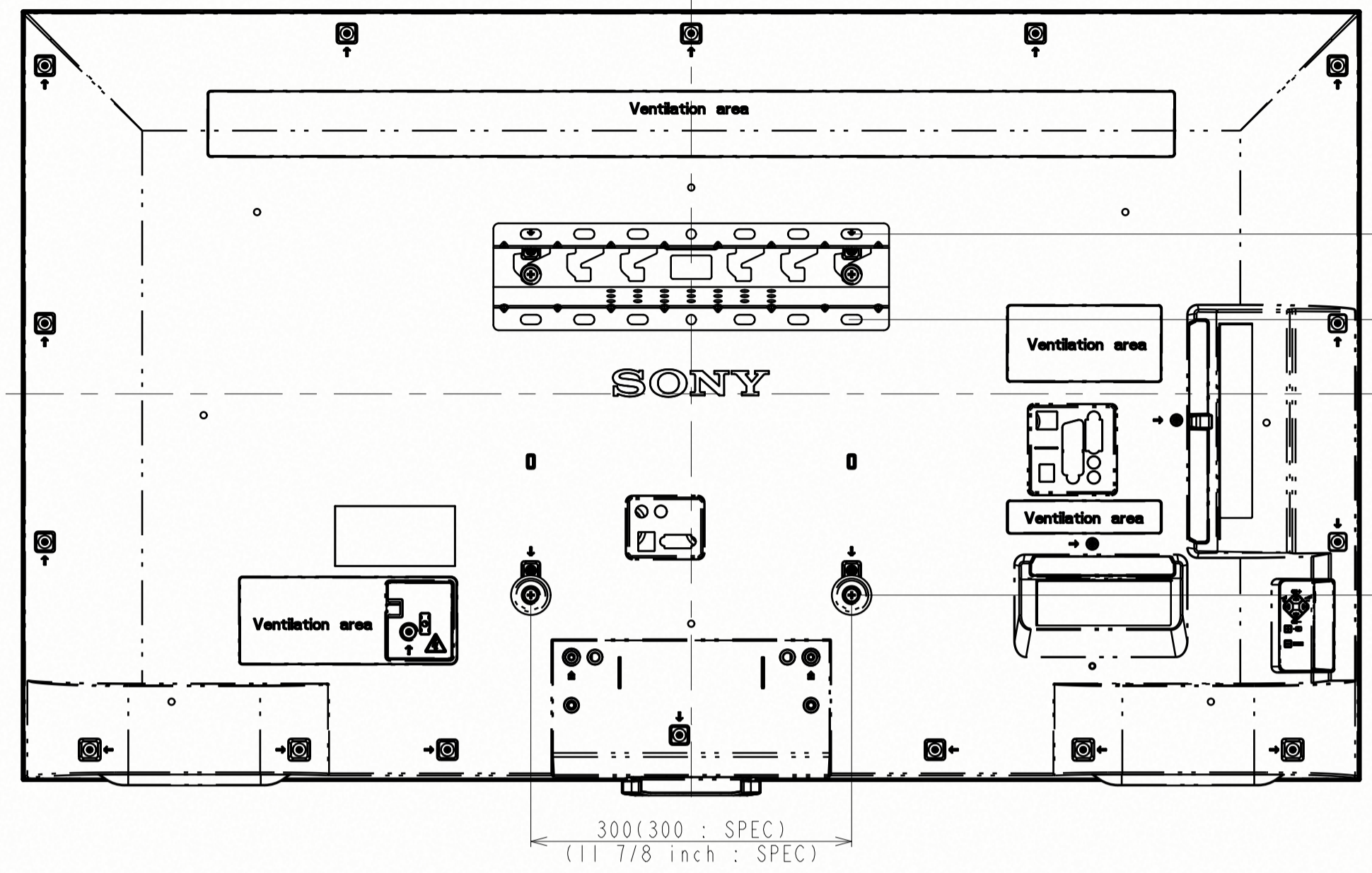

SU-WL400

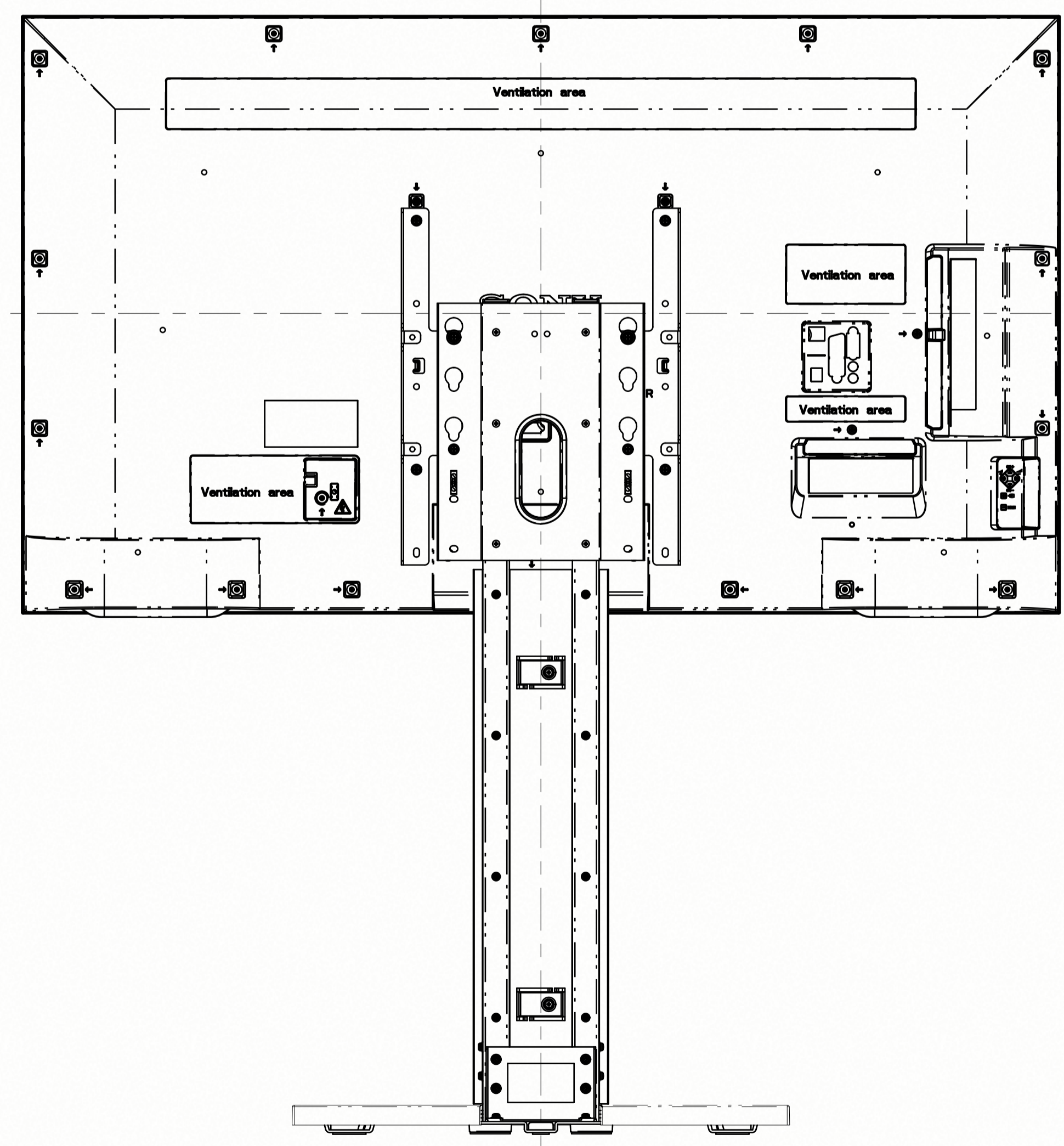
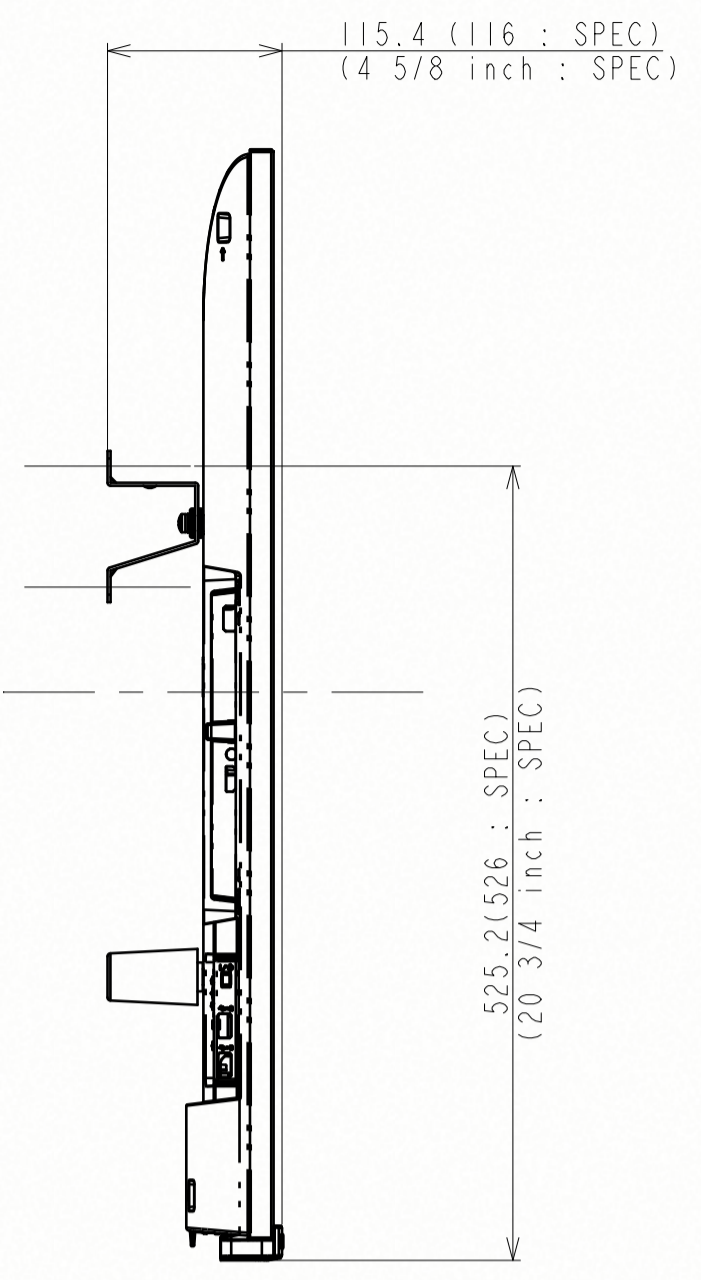

SU-FL75
<J Model Only>

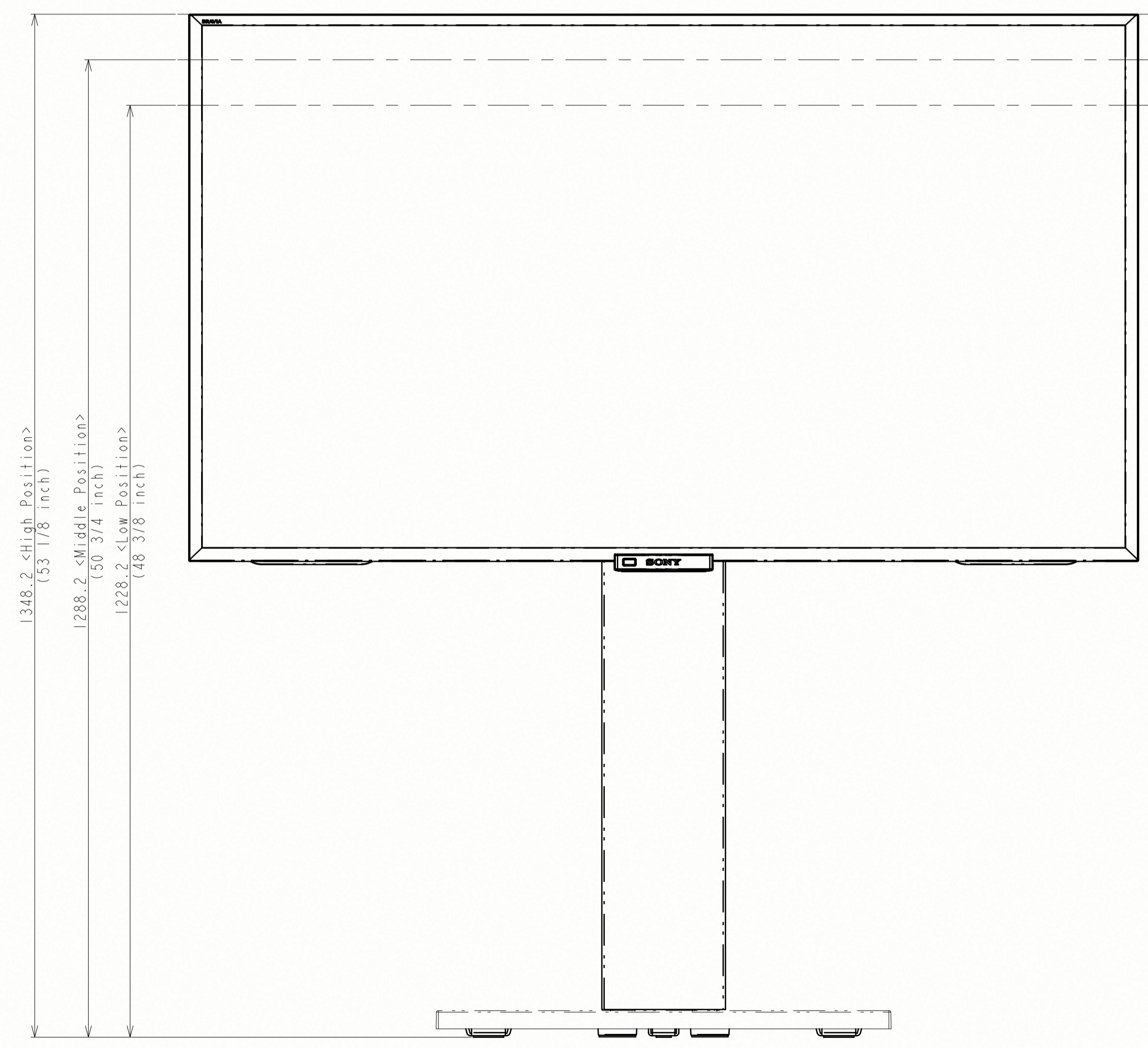
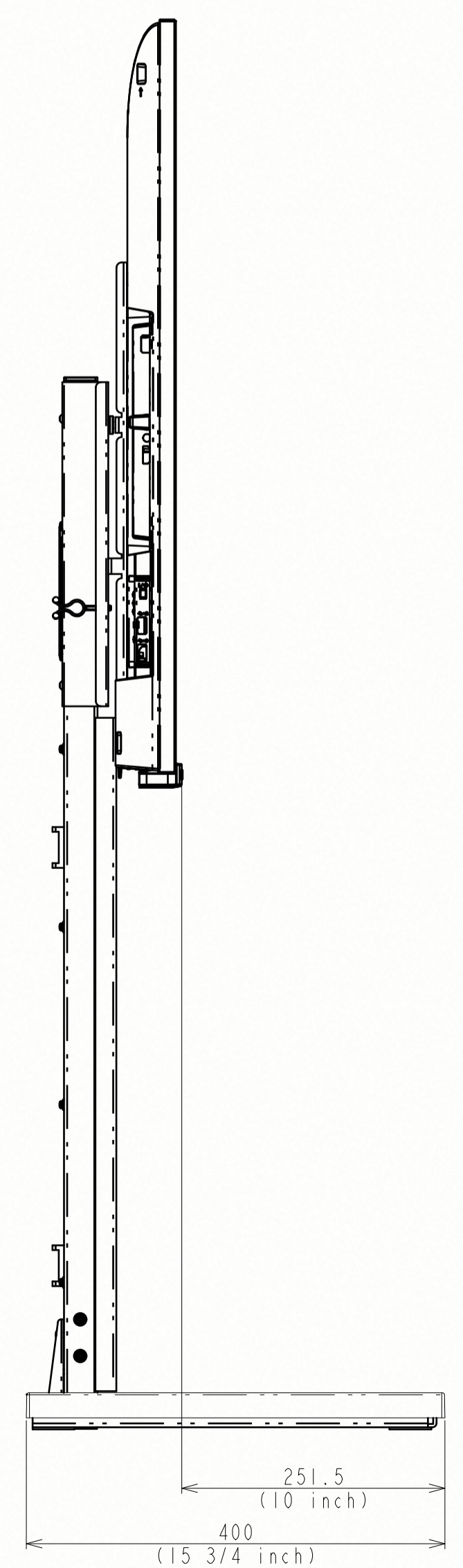

SCALE	1:5	TITLE/DESCRIPTION	55 (W800) EXTERIOR VIEW	PART NO.	
REV			55 (W800) EXTERIOR VIEW		
REV					

SONY STANDARD DRAWING