

FD Trinitron
WEGA

KV-27HS420 | KV-30HS420 | KV-32HS420 | KV-34HS420 | KV-36HS420

Operating Instructions

WARNING

To reduce the risk of fire or shock hazard, do not expose the TV to rain or moisture.



This symbol is intended to alert the user to the presence of uninsulated "dangerous voltage" within the product's enclosure that may be of sufficient magnitude to constitute a risk of electric shock to persons.



This symbol is intended to alert the user to the presence of important operating and maintenance (servicing) instructions in the literature accompanying the appliance.

CAUTION

TO PREVENT ELECTRIC SHOCK, MATCH WIDE BLADE OF PLUG TO WIDE SLOT, FULLY INSERT.

CAUTION

When using TV games, computers, and similar products with your TV, keep the brightness and contrast functions at low settings. If a fixed (non-moving) pattern is left on the screen for long periods of time at a high brightness or contrast setting, the image can be permanently imprinted onto the screen. Continuously watching the same program can cause the imprint of station logos onto the TV screen. These types of imprints are not covered by your warranty because they are the result of misuse.

Note on Caption Vision

This television receiver provides display of television closed captioning in accordance with §15.119 of the FCC rules.

Note on Cleaning the TV

Clean the TV with a soft, dry cloth. Never use strong solvents such as thinner or benzene, which might damage the finish of the cabinet.

Note to CATV System Installer

This reminder is provided to call the CATV system installer's attention to Article 820-40 of the National Electrical Code (NEC) that provides guidelines for proper grounding and, in particular, specifies that the cable ground shall be connected to the grounding system of the building, as close to the point of cable entry as practical.

Use of this television receiver for other than private viewing of programs broadcast on UHF or VHF or transmitted by cable companies for the use of the general public may require authorization from the broadcaster/cable company and/or program owner.

NOTIFICATION

This equipment has been tested and found to comply with the limits for a Class B digital device pursuant to Part 15 of the FCC Rules. These limits are designed to provide reasonable protection against harmful interference in a residential installation. This equipment generates, uses, and can radiate radio frequency energy and, if not installed and used in accordance with the instructions, may cause harmful interference with radio communications. However, there is no guarantee that interference will not occur in a particular installation. If this equipment does cause harmful interference to radio or television reception, which can be determined by turning the equipment off and on, the user is encouraged to try to correct the interference by one or more of the following measures:

- Reorient or relocate the receiving antennas.
 - Increase the separation between the equipment and receiver.
 - Connect the equipment into an outlet on a circuit different from that to which the receiver is connected.
 - Consult the dealer or an experienced radio/TV technician for help.
- You are cautioned that any changes or modifications not expressly approved in this manual could void your authority to operate this equipment.

Installing

- To prevent internal heat buildup, do not block the ventilation openings.
- Do not install the TV in a hot or humid place, or in a place subject to excessive dust or mechanical vibration.
- The AC power cord is attached to the rear of the TV with hooks. Do not attempt to remove the cord from these hooks. Doing so could cause damage to the TV.



As an ENERGY STAR Partner, Sony has determined that this product or product models meets the ENERGY STAR guidelines for energy efficiency. ENERGY STAR is a U.S. registered mark.

Owner's Record

The model and serial numbers are provided on the front of this instruction manual and at the rear of the TV. Refer to them whenever you call upon your Sony dealer regarding this product.

Trademark Information

WOW, TruSurround and the  symbol are trademarks of SRS Labs, Inc. WOW and TruSurround technology are incorporated under license from SRS Labs, Inc.

Manufactured under license from BBE Sound, Inc. Licensed by BBE Sound, Inc. under USP4638258, 5510752 and 5736897. BBE and BBE symbol are registered trademarks of BBE Sound, Inc.



This TV incorporates High-Definition Multimedia Interface (HDMI™) technology. HDMI, the HDMI logo and

High-Definition Multimedia Interface are trademarks or registered trademarks of HDMI Licensing LLC.

Wega, FD Trinitron, Steady Sound, Digital Reality Creation, Caption Vision, and CineMotion are registered trademarks of Sony Corporation. ClearEdge VM and HD Detailer are trademarks of Sony Corporation.

IMPORTANT SAFEGUARDS

For your protection, please read these instructions completely, and keep this manual for future reference.

Carefully observe and comply with all warnings, cautions and instructions placed on the set, or described in the operating instructions or service manual.

WARNING

To guard against injury, the following basic safety precautions should be observed in the installation, use, and servicing of the set.

Use

Power Sources

This set should be operated only from the type of power source indicated on the serial/model plate. If you are not sure of the type of electrical power supplied to your home, consult your dealer or local power company. For those sets designed to operate from battery power, refer to the operating instructions.



Grounding or Polarization

This set is equipped with a polarized AC power cord plug (a plug having one blade wider than the other), or with a three-wire grounding type plug (a plug having a third pin for grounding). Follow the instructions below:

For the set with a polarized AC power cord plug

This plug will fit into the power outlet only one way. This is a safety feature. If you are unable to insert the plug fully into the outlet, try reversing the plug. If the plug should still fail to fit, contact your electrician to have a suitable outlet installed. Do not defeat the safety purpose of the polarized plug by forcing it in.



Alternate Warning

For the set with a three-wire grounding type AC plug

This plug will only fit into a grounding-type power outlet. This is a safety feature. If you are unable to insert the plug into the outlet, contact your electrician to have a suitable outlet installed. Do not defeat the safety purpose of the grounding plug.



Overloading

Do not overload wall outlets, extension cords or convenience receptacles beyond their capacity, since this can result in fire or electric shock.



Always turn the set off when it is not to be used. When the set is left unattended and unused for long periods of time, unplug it from the wall outlet as a precaution against the possibility of an internal malfunction that could create a fire hazard.



Do not disconnect the antenna or the power cord during a heavy storm. Lightning may strike while you are holding the cable or cord, causing serious injury. Turn off your TV and wait for the weather to improve.

Object and Liquid Entry

Never push objects of any kind into the set through the cabinet slots as they may touch dangerous voltage points or short out parts that could result in a fire or electric shock. Never spill liquid of any kind on the set.

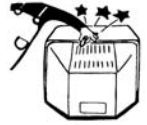

Attachments

Do not use attachments not recommended by the manufacturer, as they may cause hazards.



Do not place any objects, especially heavy objects, on top of the set. The object may fall from the set, causing injury.

Cleaning

Unplug the set from the wall outlet before cleaning or polishing it. Do not use liquid cleaners or aerosol cleaners. Use a cloth lightly dampened with water for cleaning the exterior of the set.



If a snapping or popping sound from a TV set is continuous or frequent while the TV is operating, unplug the TV and consult your dealer or service technician. It is normal for some TV sets to make occasional snapping or popping sounds, particularly when being turned on or off.



Installation

Always use two or more people to lift or move the set. The set is heavy and the bottom surface is flat. Serious injury can result from trying to move the set by yourself alone, or from unsteady handling. Install the set on a stable, level surface.

Water and Moisture

Do not use power-line operated sets near water — for example, near a bathtub, washbowl, kitchen sink, or laundry tub, in a wet basement, or near a swimming pool, etc.



Accessories

Do not place the set on an unstable cart, stand, tripod, bracket, table or shelf. The set may fall, causing serious injury to a child or an adult, and serious damage to the set. Use only a cart or stand recommended by the manufacturer for the specific model of TV. Any mounting of the product should follow the manufacturer's instructions, and should use a mounting accessory recommended by the manufacturer. An appliance and cart combination should be moved with care. Quick stops, excessive force, and uneven surfaces may cause the appliance and cart combination to overturn.



Disconnect all cables and cords from the set before attempting to move the set.

Do not allow children or pets to climb up onto, or push against, the set. The set may fall, causing serious injury.

Ventilation

The slots and openings in the cabinet and in the back or bottom are provided for necessary ventilation. To ensure reliable operation of the set, and to protect it from overheating, these slots and openings must never be blocked or covered.

- ❑ Never cover the slots and openings with a cloth or other materials.
- ❑ Never block the slots and openings by placing the set on a bed, sofa, rug or other similar surface.
- ❑ Never place the set in a confined space, such as a bookcase, or built-in cabinet, unless proper ventilation is provided.
- ❑ Do not place the set near or over a radiator or heat register, or where it is exposed to direct sunlight.



Power Cord Protection

Do not allow anything to rest on or roll over the power cord, and do not place the set where the power cord is subject to wear or abuse.

Antennas

Outdoor Antenna Grounding

If an outdoor antenna is installed, follow the precautions below. An outdoor antenna system should not be located in the vicinity of overhead power lines or other electric light or power circuits, or where it can come in contact with such power lines or circuits.

WHEN INSTALLING AN OUTDOOR ANTENNA SYSTEM, EXTREME CARE SHOULD BE TAKEN TO KEEP FROM CONTACTING SUCH POWER LINES OR CIRCUITS AS CONTACT WITH THEM IS ALMOST INVARIABLY FATAL.

Be sure the antenna system is grounded so as to provide some protection against voltage surges and built-up static charges. Section 810 of the National Electrical Code (NEC) in USA and Section 54 of the Canadian Electrical Code in Canada provide information with respect to proper grounding of the mast and supporting structure, grounding of the lead-in wire to an antenna discharge unit, size of grounding conductors, location of antenna discharge unit, connection to grounding electrodes, and requirements for the grounding electrode.

Antenna Grounding According to the National Electrical Code, ANSI/NFPA 70

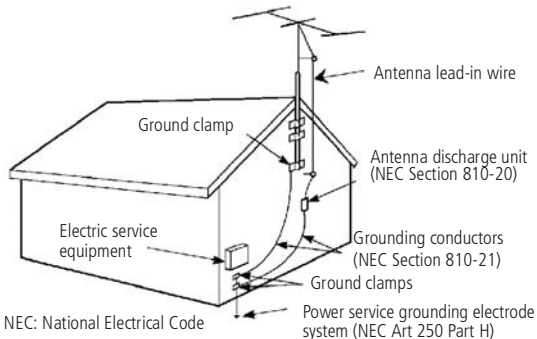





Lightning

For added protection for this television receiver during a lightning storm, or when it is left unattended and unused for long periods of time, unplug it from the wall outlet and disconnect the antenna. This will prevent damage to the receiver due to lightning and power line surges.

Service

Damage Requiring Service

Unplug the set from the wall outlet and refer servicing to qualified service personnel under the following conditions:

- ❑ When the power cord or plug is damaged or frayed.
- ❑ If liquid has been spilled into the set or objects have fallen into the product.
- ❑ If the set has been exposed to rain or water.
- ❑ If the set has been subject to excessive shock by being dropped, or the cabinet has been damaged.
- ❑ If the set does not operate normally when following the operating instructions. Adjust only those controls that are specified in the operating instructions. Improper adjustment of other controls may result in damage and will often require extensive work by a qualified technician to restore the set to normal operation.
- ❑ When the set exhibits a distinct change in performance, it indicates a need for service.

Servicing

Do not attempt to service the set yourself since opening the cabinet may expose you to dangerous voltage or other hazards. Refer all servicing to qualified service personnel.



Replacement Parts

When replacement parts are required, be sure the service technician certifies in writing that he has used replacement parts specified by the manufacturer that have the same characteristics as the original parts.



Unauthorized substitutions may result in fire, electric shock or other hazards.

Safety Check

Upon completion of any service or repairs to the set, ask the service technician to perform routine safety checks (as specified by the manufacturer) to determine that the set is in safe operating condition, and to so certify. When the set reaches the end of its useful life, improper disposal could result in a picture tube implosion. Ask a qualified service technician to dispose of the set.



Contents

Introducing the FD Trinitron Wega

Overview	7
Presenting the FD Trinitron Wega	7
Package Contents.....	7
Features	7

Setting Up the TV

Overview	9
About the AC Power Cord.....	9
TV Controls and Connectors	10
Front Panel	10
Rear Panel	11
Basic Connections: Connecting a Cable or Antenna	12
Cable, Cable Box, or Antenna Only.....	12
Connecting Optional Equipment	14
Making Video Connections.....	15
About Using S VIDEO	15
VCR and Cable	16
VCR and Cable Box	18
Two VCRs for Tape Editing	20
Satellite Receiver.....	21
Satellite Receiver and VCR	22
DVD Player with Component Video Connectors.....	24
DVD Player with S VIDEO and Audio Connectors	26
DVI-Equipped Device	27
HDMI-Equipped Device.....	28
Camcorder	29
Audio Receiver	30
Using the CONTROL S Feature	31
Setting Up the Channel List	32
Using Auto Program	32

Using the Remote Control

Overview	33
Inserting Batteries	33
Button Descriptions	34
Programming the Remote Control	37

Using the Features

Overview	39
Watching TV	39
Using Screen Mode	40
Models KV-30/34HS420 Only	40
Models KV-27/32/36HS420 Only	41
Using Favorite Channels	42
Creating a List of Favorite Channels	42
Displaying a List of Favorite Channels	42
Using Other Equipment with Your TV Remote Control	43
All Equipment	43
Operating a VCR	43
Operating a Satellite Receiver	43
Operating a Cable Box	44
Operating a DVD Player	44
Operating a DVD/VCR Combination Unit	44

Using the Menus

Overview	45
Navigating Through Menus	45
Using the Video Menu	46
Using the Audio Menu	48
Using the Screen Menu	50
Using the Channel Menu	52
Using the Parent Menu	54
Using the Parent Menu	54
US Models: Selecting Custom Rating Options	55
Viewing Blocked Programs	55
Canadian Models: Selecting Custom Rating Options	56
Viewing Blocked Programs	56
Using the Timer Menu	57
Using the Setup Menu	58

Other Information

Overview	61
Glossary	62
Contacting Sony	63
Troubleshooting	63
Remote Control	63
Channels	64
Video	64
Audio	65
General	65
Specifications	66
Optional Accessories	67
Index	69

Introducing the *FD Trinitron Wega*

Overview

This chapter describes the contents of the package in which the TV is shipped and provides an overview of the features of your Wega TV.

Presenting the *FD Trinitron Wega*

The FD Trinitron Wega (pronounced VAY-GAH) is characterized by outstanding contrast, uncompromising accuracy, and corner-to-corner detail.

You will recognize the superiority of Wega technology almost immediately. The first thing you will probably notice is minimal glare from the flat picture tube. This flat-screen technology improves picture detail without distortion, unlike conventional curved screens. The FD Trinitron delivers outstanding image detail not only at the screen center, but also at the corners — so you can enjoy a bright, clear picture from any location in a room.

Package Contents

Along with your new Trinitron TV, the packing box contains a remote control and two AA (R6) batteries. These items are all you need to set up and use the TV.

Features

Some of the features that you will enjoy with your new TV include:

- ❑ **DRC® (Digital Reality Creation) Multifunction:** Unlike conventional line doublers, the DRC Multifunction feature replaces the signal's NTSC waveform with the HD equivalent, while doubling the number of vertical and horizontal lines. This results in four times the density for quality sources, such as DVD, satellite, and digital camcorders. The Video Menu allows you to select interlaced, progressive, or CineMotion™ output.
- ❑ **Screen Mode:** Enables you to resize the picture, depending on the signal source.
- ❑ **16:9 Enhancement** **KV-27/32/36HS420 Only:** Vertical Compression technology that maximizes picture resolution when playing “anamorphic” or “enhanced for widescreen” sources, including many DVDs.

- ❑ **Favorite Channels:** Allows you to set up and select from eight of your favorite channels.
- ❑ **ClearEdge VM™ Velocity Modulation:** Sharpens picture definition by enhancing vertical lines.
- ❑ **Steady Sound®:** Equalizes volume levels so there is consistent output between programs and commercials.
- ❑ **Component Video Inputs:** Offers the best video quality for DVD (480p, 480i), and digital set-top box (HD1080i, 720p) connections.
- ❑ **CineMotion™:** Reverse 3-2 pulldown processing provides optimal picture quality for film-based sources (media originally shot in 24 frames-per-second format).
- ❑ **HD Detailer™:** Wideband video amplifier has a high bandwidth frequency rating, which allows it to send more video information to the screen, resulting in finer picture quality, especially for HD sources.
- ❑ **Parental Control:** V-Chip technology allows parents to block unsuitable programming from younger viewers.
- ❑ **HDMI (High-Definition Multimedia Interface):** Provides an uncompressed, all-digital audio/video interface between this TV and any HDMI-equipped audio/video component, such as a set-top box, DVD player, and A/V receiver. HDMI supports enhanced, or high-definition video, plus two-channel digital audio.

Setting Up the TV

Overview

This chapter includes illustrated instructions for setting up your TV.

Topic	Page(s)
TV Controls and Connectors	10-11
Basic Connections: Connecting a Cable or Antenna	12
Connecting Optional Equipment	
VCR and Cable	16
VCR and Cable Box	18
Two VCRs for Tape Editing	20
Satellite Receiver	21
Satellite Receiver and VCR	22
DVD Player with Component Video Connectors	24
DVD Player with S VIDEO and Audio Connectors	26
DVI-Equipped Device	27
HDMI-Equipped Device	28
Camcorder	29
Audio Receiver	30
Using the CONTROL S Feature	31
Setting Up the Channel List	32

About the AC Power Cord

The AC power cord is attached to the rear of the TV with a hook. Use caution when removing the AC plug from its holder. Gently slide the plug upward to remove it from the hook. Once removed, the AC power plug should automatically disengage from its stored location.

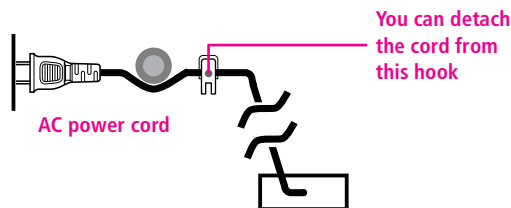

 Do not plug in the AC power cord until you have made all other connections.

TV Controls and Connectors

Front Panel

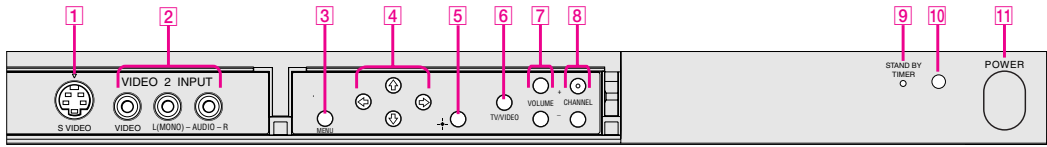

Item	Description
1	S VIDEO VIDEO 2 INPUT Connects to the S VIDEO OUT jack on your camcorder or other video equipment that has S VIDEO. Provides better picture quality than composite video (2).
2	VIDEO/L(MONO)-AUDIO-R VIDEO 2 INPUT Connects to the composite A/V output jacks on your camcorder or other video equipment.
3	MENU Press to display the Menu. Press again to exit from the Menu. For details, see "Using the Menus" on page 45.
4	↑ ↓ ← → Press ↑ ↓ ← → to move the on-screen cursor.
5	+ Press to select the on-screen highlighted item.
6	TV/VIDEO Press repeatedly to cycle through the video equipment connected to the TV's video inputs.
7	-VOLUME + Press to adjust the volume.
8	-CHANNEL+ Press to scan through channels. To scan quickly through channels, press and hold down either CHANNEL button.
9	STAND BY/TIMER LED Blinks when the TV is turned on, then shuts off when the picture is displayed. If the LED blinks continuously, this may indicate the TV needs service (see "Contacting Sony" on page 63). When lit, indicates one of the timers is set. When the timer is set, this LED will remain lit even if the TV is turned off.
10	Infrared Receiver (IR) Receives IR signals from the TV's remote control.
11	POWER Press to turn on and off the TV.

Rear Panel

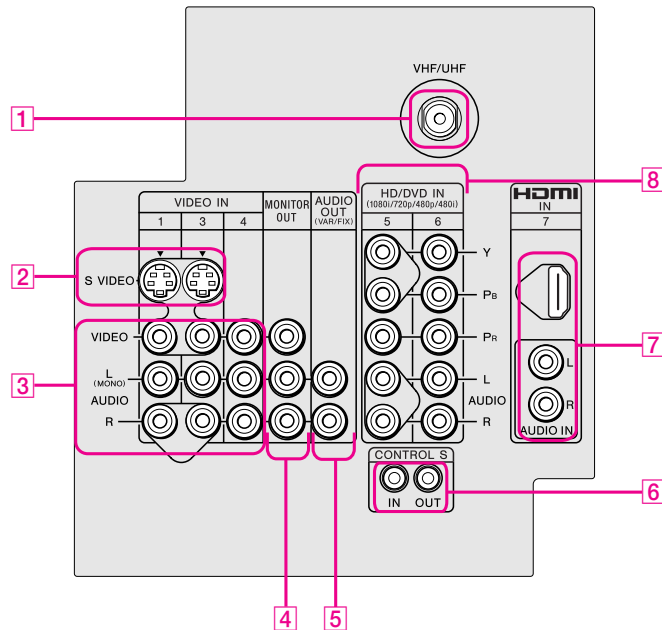

Jack	Description
1 VHF/UHF	RF input that connects to your VHF/UHF antenna or cable.
2 S VIDEO IN 1/3	Connects to the S VIDEO OUT jack of your VCR or other video equipment that has S VIDEO. S VIDEO provides better picture quality than either VHF/UHF (1) or composite video (3) connections.
3 VIDEO IN 1/3/4 VIDEO/L(MONO) -AUDIO-R	Connect to the composite A/V output jacks on your VCR or other video component. A fourth component A/V input jack (VIDEO 2) is located on the front panel of the TV. This video connection provides better picture quality than the VHF/UHF (1) connection.
4 MONITOR OUT	Lets you record the program you are watching to a VCR. When two VCRs are connected, you can use the TV as a monitor for tape-to-tape editing (not available with 480p, 720p, or 1080i when the input is set to VIDEO 5-7).
5 AUDIO OUT (VAR/FIX) L (MONO)/R	Connects to the left and right audio input jacks of your audio or video equipment. You can use these outputs to listen to your TV's audio through your stereo system.
6 CONTROL S IN/OUT	Allows the TV to receive (IN) and send (OUT) remote control signals to other Sony infrared-controlled audio or video equipment that has the CONTROL S function.
7 HDMI (VIDEO 7 IN)	HDMI (High-Definition Multimedia Interface) provides an uncompressed, all-digital audio/video interface between this TV and any HDMI-equipped audio/video component, such as a set-top box, DVD player, and A/V receiver. HDMI supports enhanced, or high-definition video, plus two-channel digital audio.
8 HD/DVD IN 5/6 (1080i/720p/480p/480i)	Connect to your DVD player's or digital set-top box's component video (Y, Pb, Pr) and audio (L/R) jacks. Component video provides the best picture quality (better than 1 , 2 , or 3).

Basic Connections: Connecting a Cable or Antenna

The way in which you will connect your TV varies, depending on how your home receives a signal (cable, cable box, antenna) and whether or not you plan to connect a VCR.

If you are connecting a VCR

- See the connections described on pages 16 and 18.

Cable, Cable Box, or Antenna Only

The connection you choose depends on the cable type you have in your home, as described below.

75-ohm coaxial cable (usually found in newer homes)

Cable Type	Connect As Shown
------------	------------------

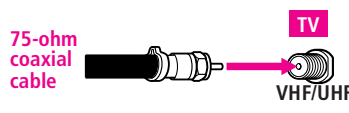
VHF Only or combined VHF/UHF or Cable	 <p>75-ohm coaxial cable</p>
---------------------------------------	---

TV
VHF/UHF

300-ohm twin lead cable (usually found in older homes)

Cable Type	Connect As Shown
------------	------------------

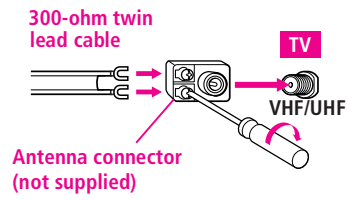
VHF Only or UHF Only or combined VHF/UHF	 <p>300-ohm twin lead cable</p>
--	--

TV
VHF/UHF

Antenna connector (not supplied)

75-ohm coaxial and 300-ohm twin lead cable (found in some homes)

Cable Type	Connect As Shown
------------	------------------

VHF and UHF	 <p>75-ohm coaxial cable</p>
-------------	--

TV
VHF/UHF

300-ohm twin lead cable

U/V mixer (not supplied)

Notes on Using a Cable Box Connection

<i>To Do This ...</i>	<i>Do This ...</i>
Use the cable box	Tune the TV to the channel the cable box is set to (usually channel 3 or 4) and then use the cable box to switch channels.
Set up the TV remote control to operate the cable box	Program the remote control. See “Programming the Remote Control” on pages 37-38.
Activate the remote control to operate the cable box	Press SAT/CABLE FUNCTION .
Prevent the accidental switching of TV channels	When using the cable box, you need the TV to stay on the channel the cable box is set to (usually channel 3 or 4). You can use the TV’s Channel Fix feature to lock in a specific channel. For details, see “Using the Channel Menu” on page 52.

Connecting Optional Equipment

Use the directions in this section to connect the following optional equipment:

<i>If You Are Connecting</i>	<i>See Page</i>
VCR and Cable	16
VCR and Cable Box	18
Two VCRs for Tape Editing	20
Satellite Receiver	21
Satellite Receiver and VCR	22
DVD Player with Component Video Connectors	24
DVD Player with S VIDEO and Audio Connectors	26
DVI-Equipped Device	27
HDMI-Equipped Device	28
Camcorder	29
Audio Receiver	30

Making Video Connections

Your TV includes several types of video inputs. When connecting your TV, use the inputs that are available on your components that provide the best video performance, as described below.

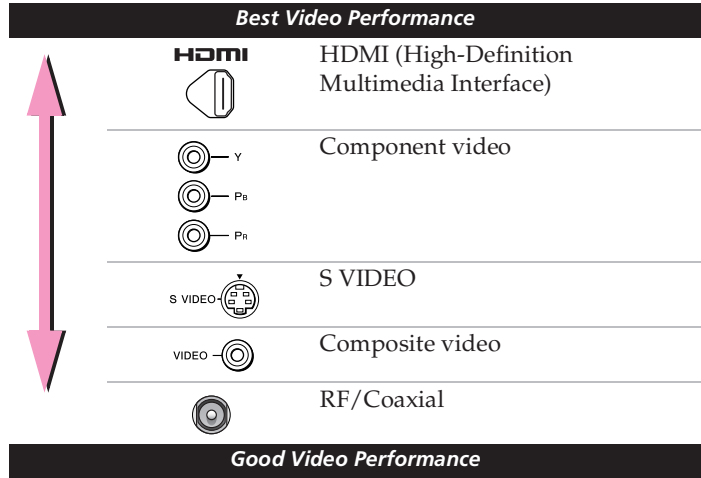

About Using S VIDEO



If the optional equipment you are connecting has an S VIDEO jack (shown at left), you can use an S VIDEO cable for improved picture quality (compared to an A/V cable). Because S VIDEO carries only the video signal, you also need to connect audio cables for sound, as shown below.

Example of an S VIDEO Connection

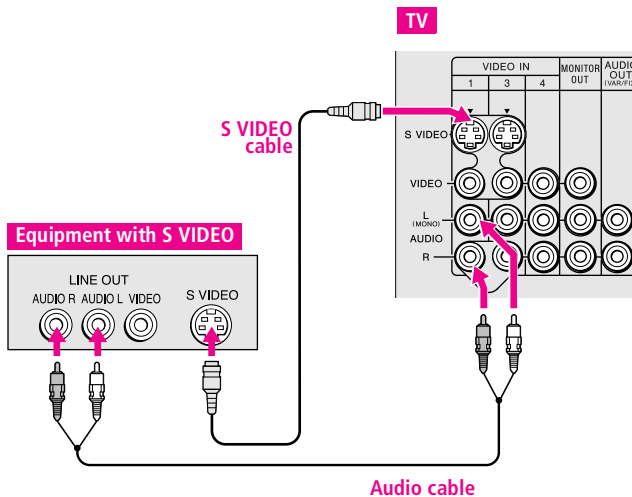

Cables are often color-coded to connectors. Connect red to red, white to white, etc.

VCR and Cable



Using
S VIDEO jacks?
See page 15.

For best results, use this connection if:

- ❑ Your cable company does not require you to use a cable box.

To connect the VCR and cable

- 1 Connect the CATV cable to the VCR's VHF/UHF input jack.
- 2 Use a coaxial cable to connect the VCR's VHF/UHF output jack to the TV's VHF/UHF jack.
- 3 Use an A/V cable to connect the VCR's A/V output jacks to the TV's A/V input jacks.
- 4 Run the Auto Setup program, as described in "Setting Up the Channel List" on page 32.

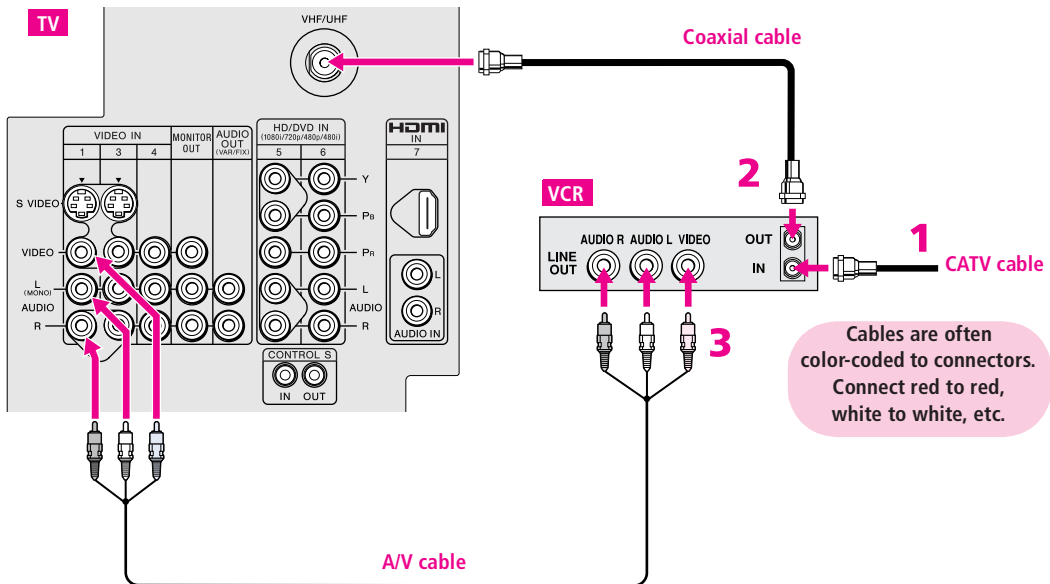

Notes on Using This Connection

<i>To Do This ...</i>	<i>Do This ...</i>
Watch the VCR	Press TV/VIDEO repeatedly to select the VCR input (VIDEO 1 in the illustration).
Watch cable channels	Press TV/VIDEO repeatedly to select the cable input (VHF/UHF in the illustration).
Set up the TV remote control to operate the VCR	If you have a non-Sony VCR, you must program the remote control. See "Programming the Remote Control" on pages 37-38.
Activate the TV remote control to operate the VCR	Press VCR/DVD FUNCTION .
Control VCR functions with the TV remote control	See "Operating a VCR" on page 43.
Label video inputs to easily identify equipment connected to the TV	See the instructions for setting up Video Labels on pages 58-59.

VCR and Cable Box

For best results, use this connection if:

- ❑ Your cable company scrambles some channels, such as premium channels (which requires you to use a cable box), but does not scramble all channels.

With this connection you can:

- ❑ Use the TV remote control to change channels coming through the cable box. (You must first program the remote control for your specific cable box; see “Programming the Remote Control” on page 37.)
- ❑ Use the TV remote control to change channels coming directly into the TV’s VHF/UHF jack. (The TV’s tuner provides a better signal than the cable box.)
- ❑ Record channels coming through the cable box and channels coming directly into the TV.

To connect a VCR and cable box, you need:

- ❑ A splitter, which is a small, inexpensive device that you can purchase at your local electronics store.

 **DIGITAL CABLE BOX USERS:** If you are connecting a digital cable box, you will need a special bi-directional splitter that is designed to work with your digital cable box. Contact your cable provider for details.

- ❑ Three coaxial cables.
- ❑ Two A/V or S VIDEO cables with audio cables.

To connect the VCR and cable box

- 1 Connect the CATV cable to the single (input) jack of the splitter.
- 2 Use a coaxial cable to connect one of the splitter’s two output jacks to the TV’s VHF/UHF jack.
- 3 Use a coaxial cable to connect the splitter’s other output jack to the cable box’s input jack.
- 4 Use a coaxial cable to connect the cable box’s output jack to the VCR’s RF input jack.
- 5 Use an A/V cable to connect the cable box’s A/V output jacks to the TV’s A/V input jacks.
- 6 Use an A/V cable to connect the VCR’s A/V output jacks to the TV’s A/V input jacks.
- 7 Run the Auto Setup program, as described in “Setting Up the Channel List” on page 32.



Using
S VIDEO jacks?
See page 15.

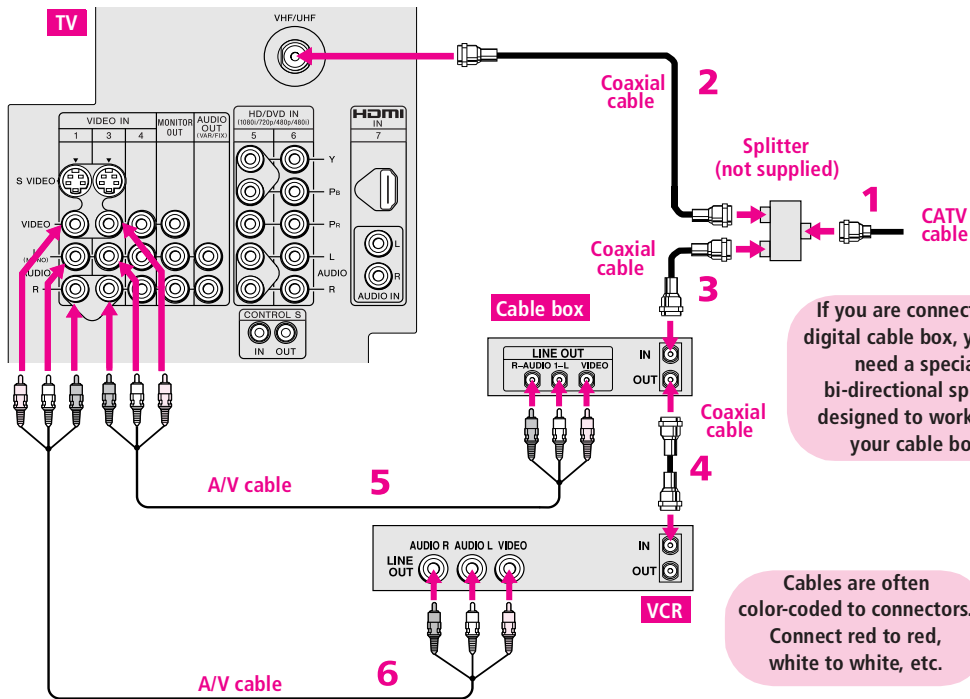

If you are connecting a digital cable box, you will need a special bi-directional splitter designed to work with your cable box.

Cables are often color-coded to connectors. Connect red to red, white to white, etc.

Notes on Using This Connection

To Do This ...	Do This ...
Watch cable (unscrambled) channels	Press TV/VIDEO repeatedly to select the cable input (UHF/VHF in the illustration).
Watch cable box (scrambled) channels	Press TV/VIDEO repeatedly to select the cable box input (VIDEO 3 in the illustration). Use the cable box to change channels.
Watch the VCR	Press TV/VIDEO repeatedly to select the VCR input (VIDEO 1 in the illustration). Use the VCR to change channels.
Set up the TV remote control to operate the cable box or VCR	If you have a non-Sony VCR, you must program the remote control. See "Programming the Remote Control" on pages 37-38.
Activate the TV remote control to operate the cable box or VCR	For the cable box, press SAT/CABLE FUNCTION . For the VCR, press VCR/DVD FUNCTION .
Control specific cable box and VCR functions with the TV remote control	See "Operating a Cable Box" on page 44 and "Operating a VCR" on page 43.
Label video inputs to easily identify equipment connected to the TV	See the instructions for setting up Video Labels on pages 58-59.

Two VCRs for Tape Editing



Using
S VIDEO jacks?
See page 15.

Connecting two VCRs lets you record from one VCR to the other. By connecting them as shown below, you can view (monitor) what is being recorded.

To connect two VCRs for tape editing

- 1 Use an A/V cable to connect the playback VCR's A/V output jacks to the TV's A/V input jacks.
- 2 Use an A/V cable to connect the recording VCR's A/V input jacks to the TV's MONITOR OUT jacks.

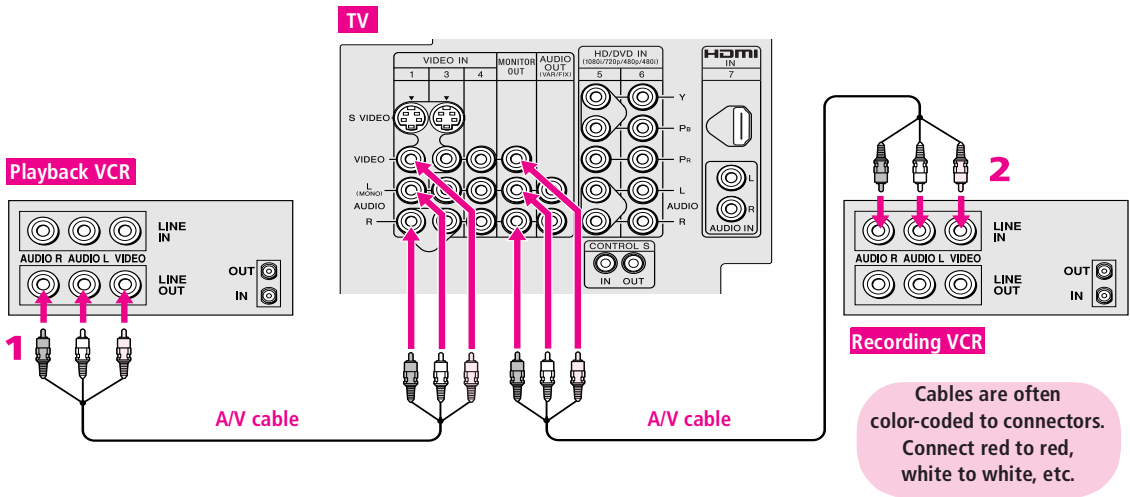

Notes on Using This Connection

To Do This ...	Do This ...
View (monitor) what is being recorded	Press TV/VIDEO repeatedly to select the VCR input (VIDEO 1 in the illustration above).
Set up the TV remote control to operate the VCR(s)	If you have a non-Sony VCR, you must program the remote control. See "Programming the Remote Control" on pages 37-38.
Activate the TV remote control to operate the VCR(s)	Press VCR/DVD FUNCTION .
Control VCR functions with the TV remote control	See "Operating a VCR" on page 43.
Label video inputs to easily identify equipment connected to the TV	See the instructions for setting up Video Labels on pages 58-59.

Satellite Receiver



Using S VIDEO jacks? See page 15.

To connect a satellite receiver

- 1 Connect the satellite antenna cable to the satellite receiver's satellite input jack.
- 2 Use an A/V cable to connect the satellite receiver's A/V output jacks to the TV's A/V input jacks.
- 3 Connect a CATV cable from your cable or antenna to the satellite receiver's VHF/UHF input jack.
- 4 Use a coaxial cable to connect the satellite receiver's VHF/UHF output jack to the TV's VHF/UHF input jack.
- 5 Run the satellite receiver's setup program (see the satellite receiver's manual for details).

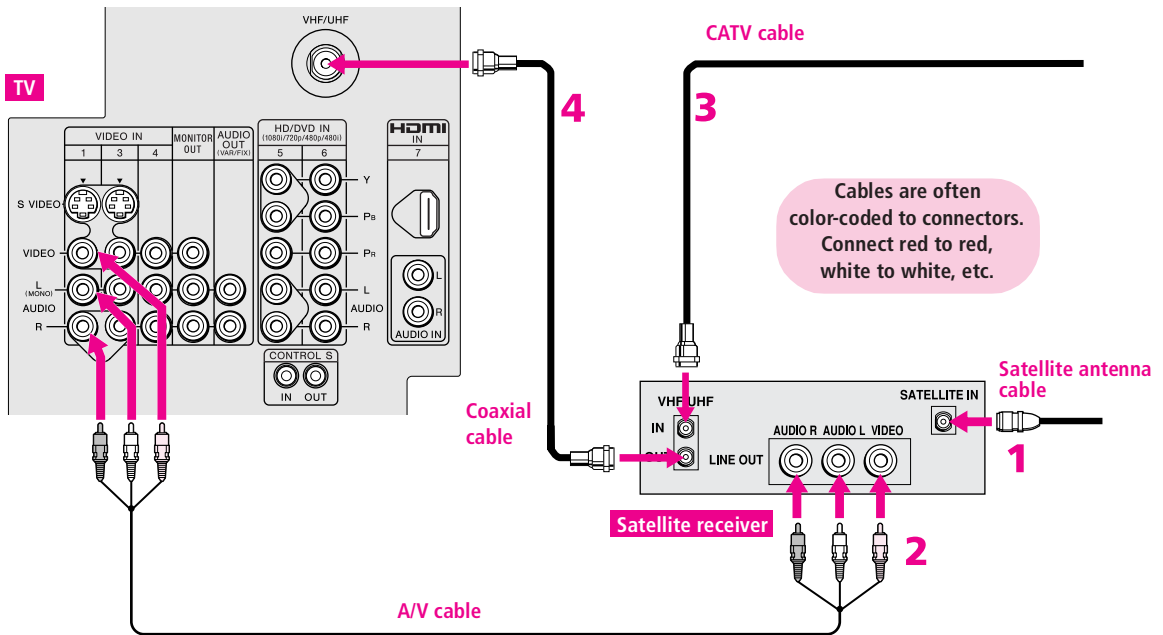

Notes on Using This Connection

To Do This ...	Do This ...
Watch the satellite receiver	Press TV/VIDEO repeatedly to select the satellite receiver input (VIDEO 1 in the illustration).
Set up the TV remote control to operate the satellite receiver	If you have a non-Sony satellite receiver, you must program the remote control. See "Programming the Remote Control" on pages 37-38.
Activate the TV remote control to operate the satellite receiver	Press SAT/CABLE FUNCTION .
Control satellite receiver functions with the TV remote control	See "Operating a Satellite Receiver" on page 43.
Label video inputs to easily identify equipment connected to the TV	See the instructions for setting up Video Labels on pages 58-59.

Satellite Receiver and VCR



Using
S VIDEO jacks?
See page 15.

To connect a satellite receiver and VCR

- 1 Connect the CATV cable to the single (input) jack of the splitter.
- 2 Use a coaxial cable to connect one of the splitter's two output jacks to the TV's VHF/UHF jack.
- 3 Use a coaxial cable to connect the splitter's other output jack to the satellite receiver's VHF/UHF input jack.
- 4 Connect the satellite antenna cable to the satellite receiver's satellite input jack.
- 5 Use a coaxial cable to connect the satellite receiver's VHF/UHF output jack to the VCR's VHF/UHF input jack.
- 6 Use an A/V cable to connect the satellite receiver's A/V output jacks to the TV's A/V input jacks.
- 7 Use an A/V cable to connect the VCR's A/V output jacks to the TV's A/V input jacks.
- 8 Run the Auto Setup program, as described in "Setting Up the Channel List" on page 32.

Notes on Using This Connection

To Do This ...	Do This ...
Watch the satellite receiver	Press TV/VIDEO repeatedly to select the satellite receiver input (VIDEO 3 in the illustration).
Watch the VCR	Press TV/VIDEO repeatedly to select the VCR input (VIDEO 1 in the illustration).
Set up the TV remote control to operate the satellite receiver or VCR	If you have a non-Sony VCR or satellite receiver, you must program the remote control. See "Programming the Remote Control" on pages 37-38.
Activate the TV remote control to operate the satellite receiver or VCR	For the satellite receiver, press SAT/CABLE FUNCTION . For the VCR, press VCR/DVD FUNCTION .
Control satellite receiver and VCR functions with the TV remote control	See "Operating a Satellite Receiver" on page 43 and "Operating a VCR" on page 43.
Label video inputs to easily identify equipment connected to the TV	See the instructions for setting up Video Labels on pages 58-59.

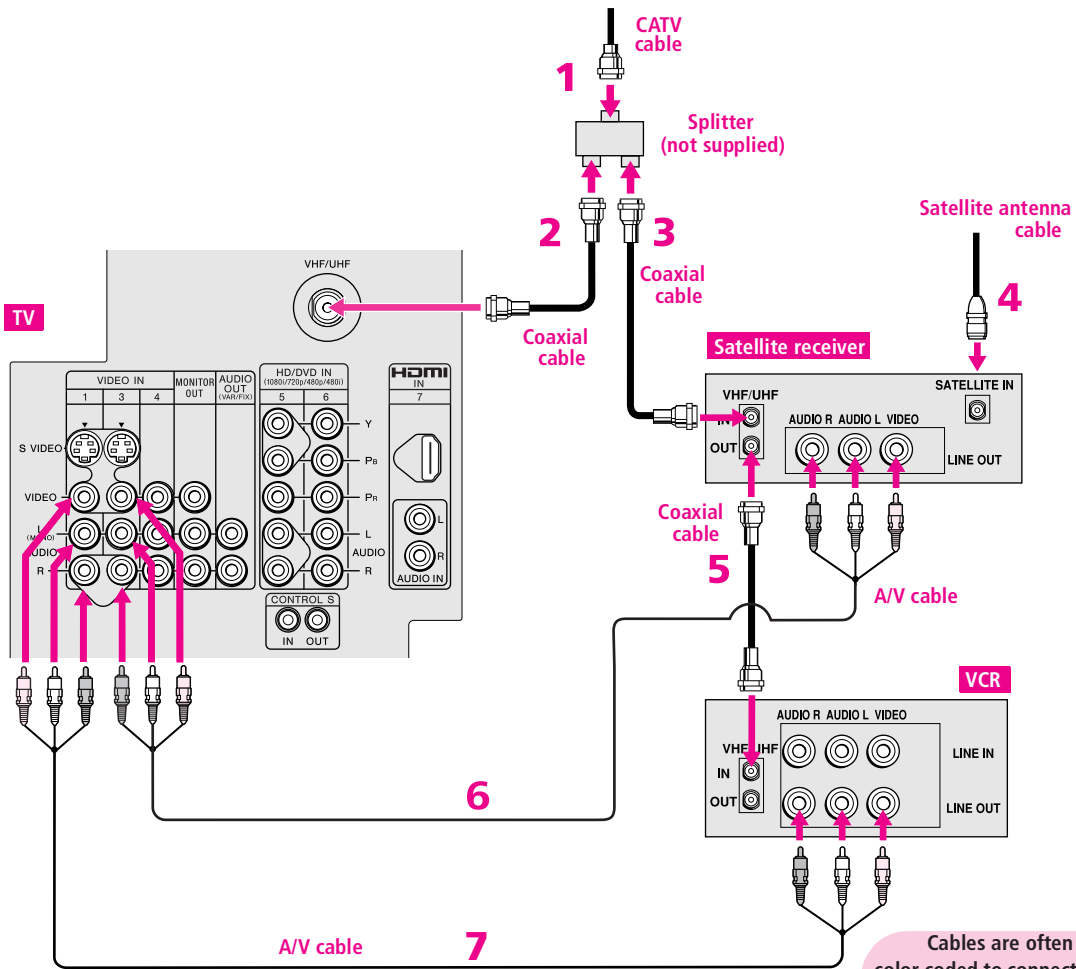

Cables are often color-coded to connectors. Connect red to red, white to white, etc.

DVD Player with Component Video Connectors

For best results, use this connection if your DVD player has component video (Y, P_B, P_R) jacks.

To connect a DVD player with component video connectors

- 1 Use three separate component video cables to connect the DVD player's Y, P_B and P_R jacks to the Y, P_B and P_R jacks (VIDEO 5) on the TV.

 The Y, P_B and P_R jacks on your DVD player are sometimes labeled Y, C_B and C_R, or Y, B-Y and R-Y. If so, connect the cables to like colors.

- 2 Use an audio cable to connect the DVD player's audio output jacks to the TV's VIDEO 5 audio input jacks.

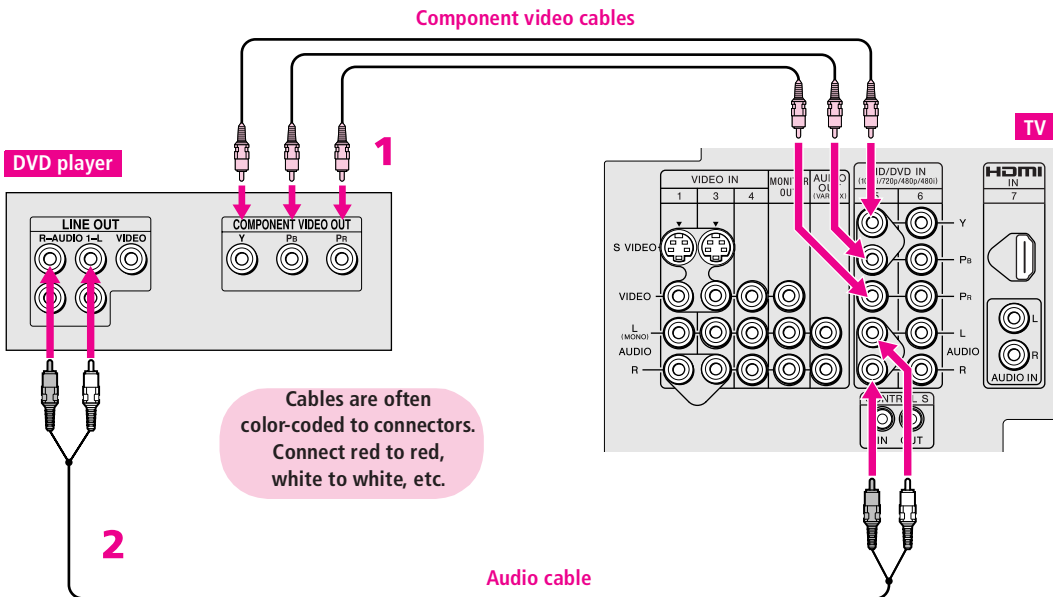

Notes on Using This Connection

To Do This ...	Do This ...
Watch the DVD player	Press TV/VIDEO repeatedly to select the DVD input (VIDEO 5 in the illustration).
Set up the TV remote control to operate the DVD player	If you have a non-Sony DVD player, you must program the remote control. See "Programming the Remote Control" on pages 37-38.
Activate the TV remote control to operate the DVD player	Press VCR/DVD FUNCTION .
Control DVD functions with the TV remote control	See "Operating a DVD Player" on page 44.
Label video inputs to easily identify equipment connected to the TV	See the instructions for setting up Video Labels on pages 58-59.

 You cannot record the signal from any equipment connected into the Y, PB, PR jacks.

DVD Player with S VIDEO and Audio Connectors

Use this connection if your DVD player does not have component video (Y, Pb, Pr) jacks.

To connect a DVD player with A/V connectors

- 1 Use an audio cable to connect the DVD player's audio output jacks to the TV's audio input jacks.
- 2 Use an S VIDEO cable to connect the DVD player's S VIDEO jack to the TV's S VIDEO jack.

Cables are often color-coded to connectors. Connect red to red, white to white, etc.

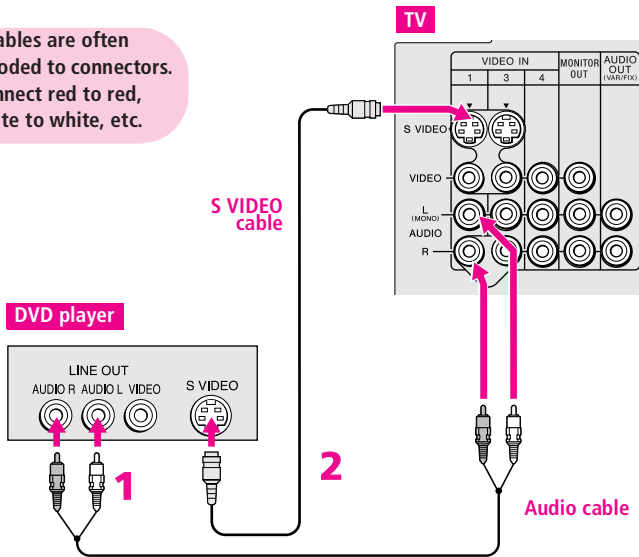

Notes on Using This Connection

To Do This ...	Do This ...
Watch the DVD player	Press TV/VIDEO repeatedly to select the DVD input (VIDEO 1 in the illustration).
Set up the TV remote control to operate the DVD player	If you have a non-Sony DVD player, you must program the remote control. See "Programming the Remote Control" on pages 37-38.
Activate the TV remote control to operate the DVD player	Press VCR/DVD FUNCTION .
Control DVD functions with the TV remote control	See "Operating a DVD Player" on page 44.
Label video inputs to easily identify equipment connected to the TV	See the instructions for setting up Video Labels on pages 58-59.

DVI-Equipped Device

If you have a device, such as an HDTV receiver, that has DVI (Digital Video Interface) output, use the following connection.

To connect a device that has DVI OUT:

- 1 Use an HDMI-to-DVI cable to connect the device's DVI OUT jack to the TV's HDMI IN jack.

 You can purchase HDMI cables (or cable adapters) at your local electronics store.

- 2 Use an audio cable to connect the device's audio output jacks to the TV's HDMI analog audio input jacks.

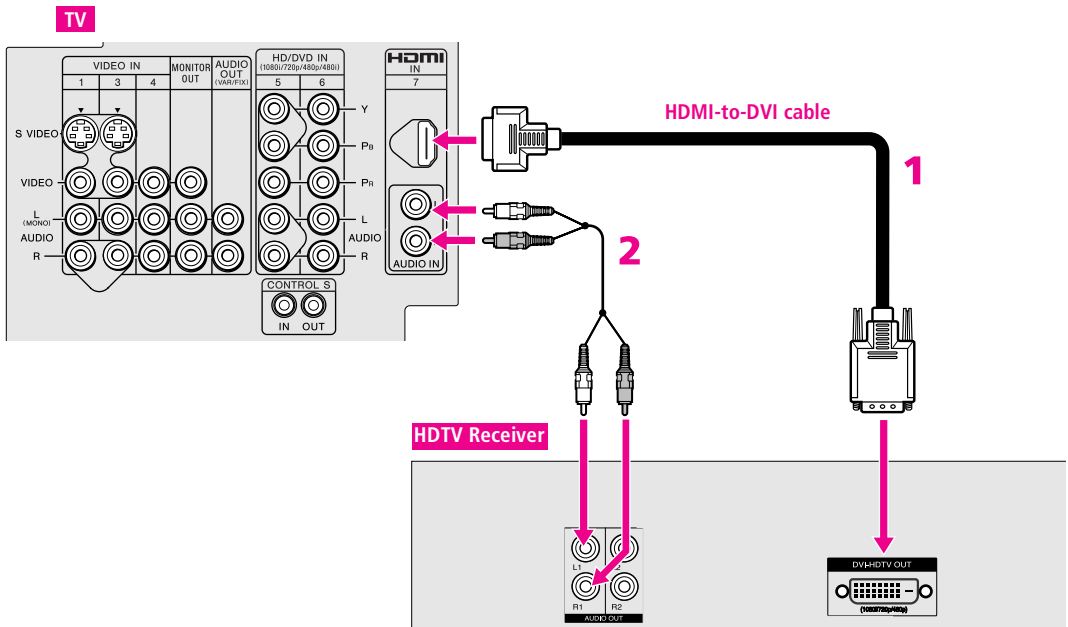

Note on Using This Connection

To Do This ...

Watch the DVI device

Label video inputs to easily identify equipment connected to the TV

Do This ...

Press **TV/VIDEO** repeatedly to select the VIDEO 7 input.

See the instructions for setting up Video Labels on pages 58-59.

HDMI-Equipped Device

If you have a device, such as an HDTV receiver, that has a High-Definition Multimedia Interface (HDMI), use the following connection.

To connect a device that has HDMI OUT:

- 1 Use the HDMI cable that came with your device to connect the device's HDMI OUT jack to the TV's HDMI IN jack.

 HDMI cables transmit both audio and video signals. (Separate audio cables are not necessary.) You can purchase HDMI cables at your local electronics store.

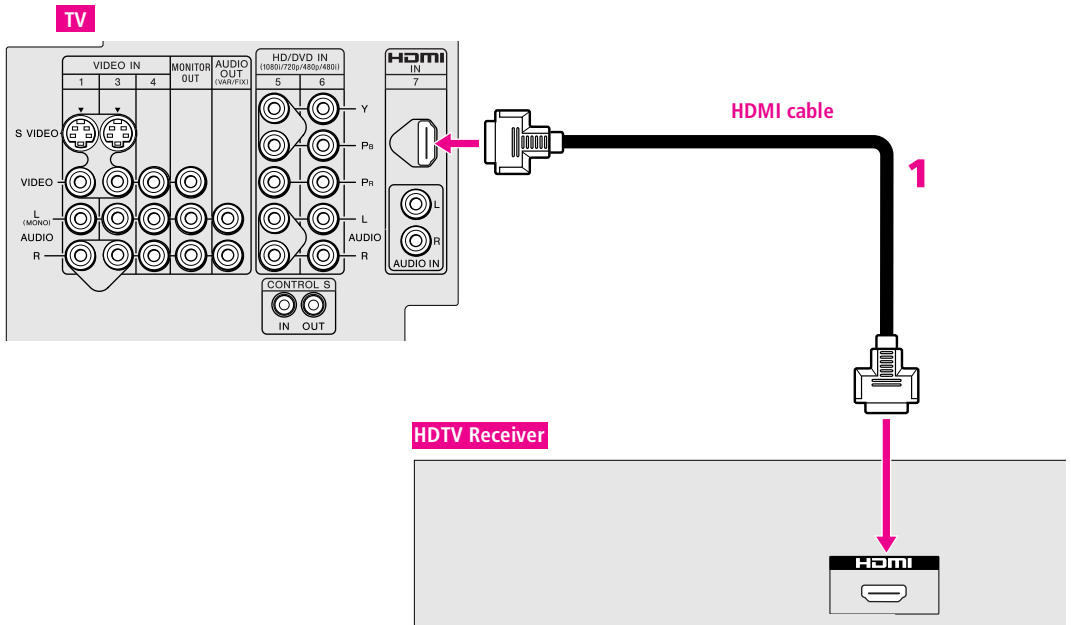

Note on Using This Connection

To Do This ...

Watch the HDMI device
Label video inputs to easily
identify equipment connected
to the TV

Do This ...

Press **TV/VIDEO** repeatedly to select the VIDEO 7 input.
See the instructions for setting up Video Labels on pages 58-59.

Camcorder



Using
S VIDEO jacks?
See page 15.

For easy connection of a camcorder, the TV has front A/V input jacks. If you prefer, however, you can connect the camcorder to the TV's rear A/V input jacks.

To connect a camcorder

- 1 Use A/V cables to connect the camcorder's A/V output jacks to the TV's A/V input jacks.

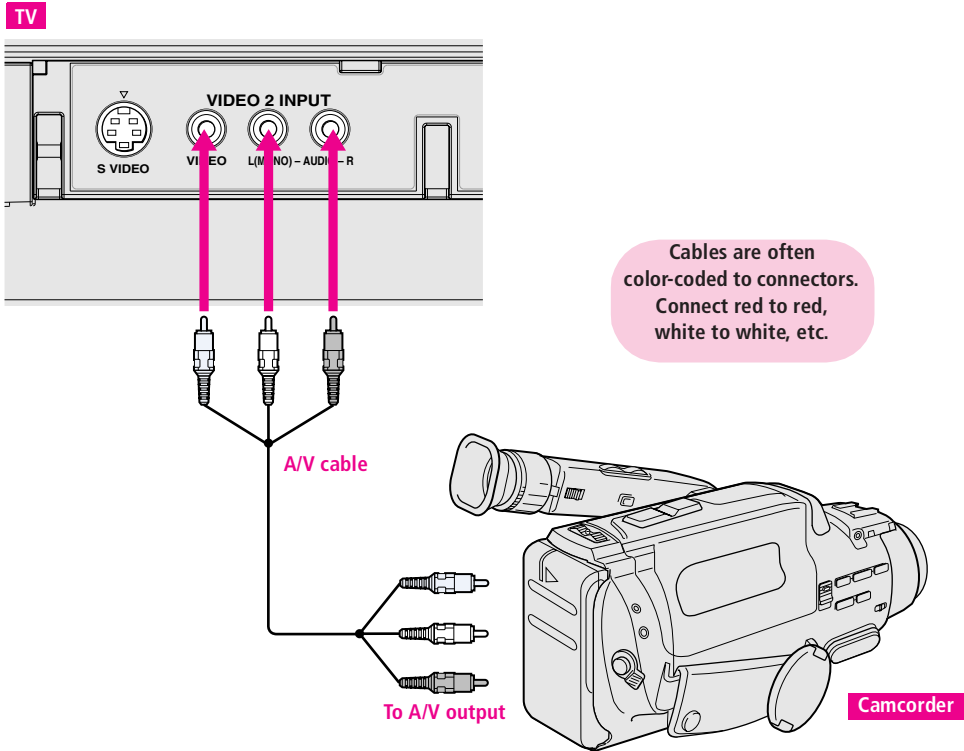

If you have a mono camcorder, connect its audio output jack to the TV's L MONO audio jack.

Note on Using This Connection

To Do This ...

Watch the camcorder

Label video inputs to easily identify equipment connected to the TV

Do This ...

Press **TV/VIDEO** repeatedly to select the camcorder input (VIDEO 2 in the illustration).

See the instructions for setting up Video Labels on pages 58-59.

Audio Receiver

For improved sound quality, you may want to play the TV's audio through your stereo system.

To connect an audio system

- 1 Use an audio cable to connect the TV's audio output jacks to the audio receiver's line input jacks.

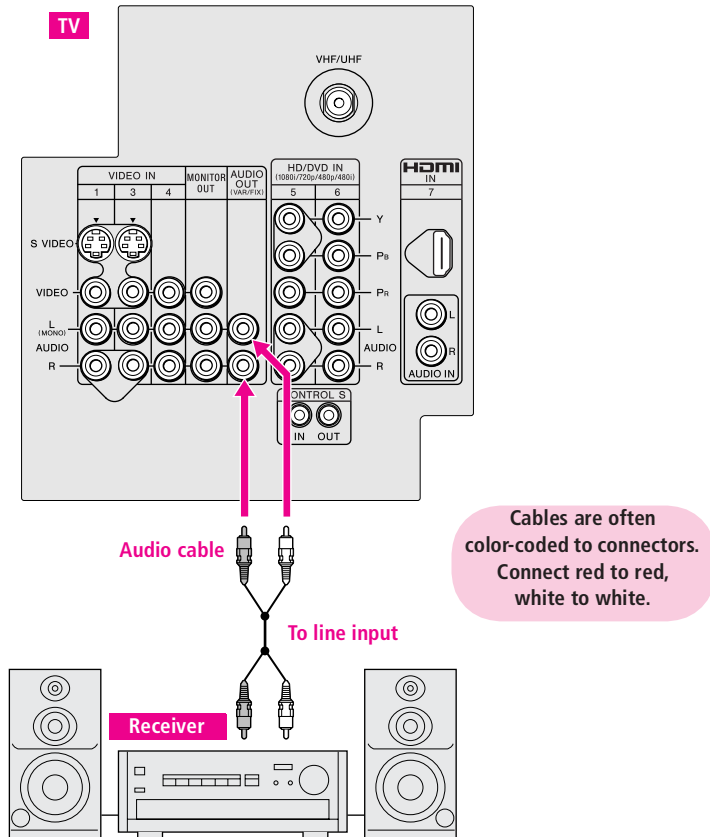

- 2 Using the TV's Audio Menu, set the **Speaker** option to **Off**. Then set the **Audio Out** option to **Fixed** or **Variable**, depending on how you want to control the volume. For details, see "Using the Audio Menu" on page 48.
- 3 Turn on the audio receiver, and then set the receiver's line input to the jack into which you connected the TV.

Using the CONTROL S Feature

CONTROL S allows you to control your system and other Sony equipment with one remote control. In addition to allowing you to control multiple devices with one remote control, the CONTROL S feature allows you to always point your remote control at your TV, instead of having to point it at the other equipment, which might be hidden or out of direct line of sight.

Use CONTROL S IN to send signals to the TV.

Use CONTROL S OUT to send signals to connected equipment.

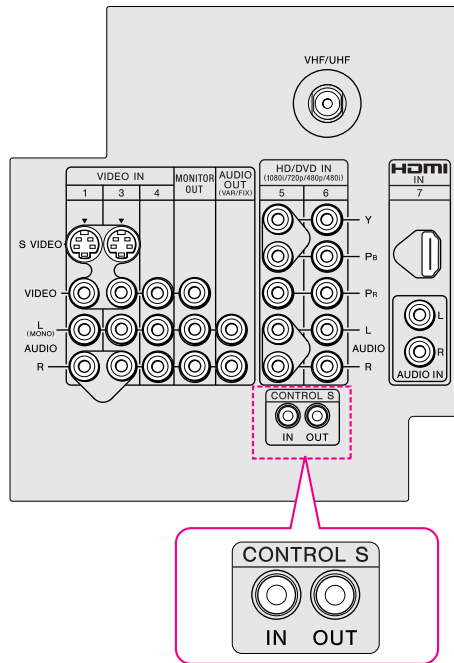

Setting Up the Channel List

After you finish connecting your TV, you need to run Auto Setup to set up your channels. The Auto Program screens appear when you turn on your TV for the first time after hooking it up.

Using Auto Program

 To exit the Tilt Correction and Vertical Correction screens, press the **MENU** button.

 For more details on using Auto Program, see page 52. For more details on using Tilt Correction and Vertical Correction, see page 59.

To run Auto Program the first time you turn on your TV

- 1 Press **POWER** to turn on the TV.
The Initial Setup screen appears.
- 2 Press **▲▼** to move the highlight to the desired language, then press **(←→)** to select that language.
- 3 The next screen instructs you to connect your cable/antenna. Check that you've connected your signal source properly.
To start Auto Program, highlight **Yes** and then press **(←→)**.
Auto Program automatically creates a list of receivable channels.
When Auto Program is finished, the Tilt Correction screen appears.
- 4 Press **←→** to correct any tilt of the picture. You can choose a correction between +7 and -7.
When finished, press **(←→)**.
- 5 **KV-30/34HS420 Only** The Vertical Correction screen appears. Press **▲▼** to make a vertical correction to the picture. You can choose a correction between +5 and -5. When finished, press **(←→)**.
When completed, the lowest numbered channel is displayed.

To reset the TV to factory settings

- 1 Press **POWER** to turn on the TV.
- 2 Hold down **RESET** on the remote control.
- 3 Press **TV POWER** on the TV. (The TV will turn itself off, then back on.)
- 4 Release **RESET**.

Using the Remote Control

Overview

This chapter describes how to set up, program, and use the TV's remote control.

Topic	Page
Inserting Batteries	33
Button Descriptions	34
Programming the Remote Control	37

Inserting Batteries

- 1 Remove the battery cover from the remote control.
- 2 Insert two size AA (R6) batteries (supplied) by matching the **+** and **-** terminals on the batteries to the diagram inside the battery compartment.
- 3 Replace the battery cover.

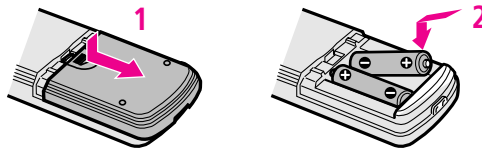

 Remove the batteries to avoid damage from possible battery leakage whenever you anticipate that the remote control will not be used for an extended period. Handle the remote control with care. Avoid dropping it, getting it wet, placing it in direct sunlight, near a heater, or where the humidity is high.

Button Descriptions

Remote Control

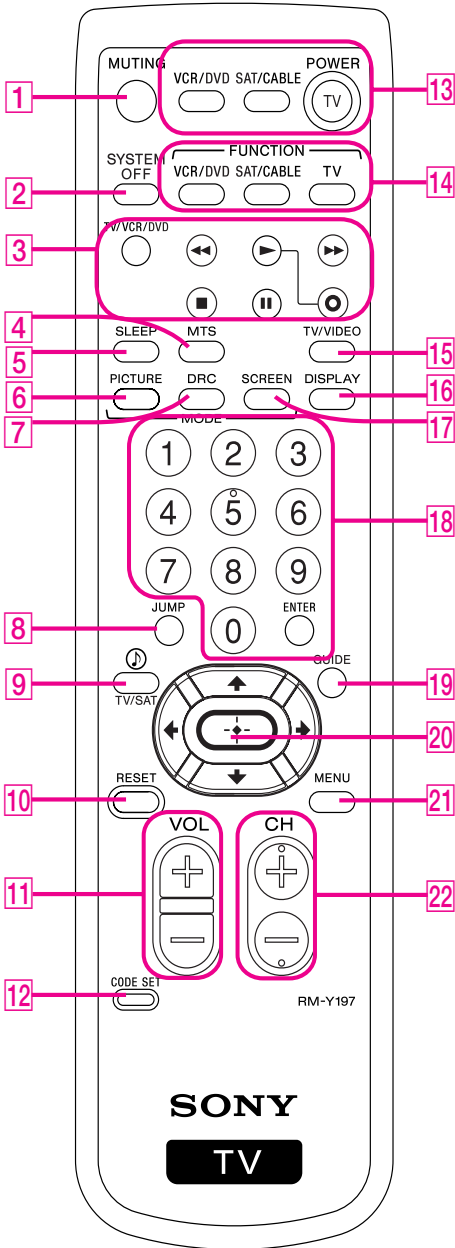

Button	Description
1	MUTING Press to mute the sound. Press again or press VOL+ to restore the sound.
2	SYSTEM OFF Press to turn off all Sony brand audio/video equipment at once. (May not function with older Sony equipment. Does not function with DVD/VCR combination unit.)
3	TV/VCR/DVD Press to change the VHF/UHF output of the VCR (or DVD/VCR combination unit). Transport Buttons ◀◀ Rewind ▶ Play ● Record (press together with ▶) ■ Stop ▶▶ Fast forward Pause
4	MTS Press repeatedly to cycle through the Multi-channel TV Sound (MTS) options: Stereo , Auto SAP (Second Audio Program), and Mono . Also available in the Audio Menu. For details, see “Using the Audio Menu” on page 48.
5	SLEEP Press repeatedly until the TV displays the time in minutes (15, 30, 45, 60, or 90) that you want the TV to remain on before shutting off automatically. To cancel press until Sleep Off appears. While the Sleep feature is set, press once to display the remaining time.
6	PICTURE MODE Press repeatedly to cycle through the available video picture modes: Vivid , Standard , Movie , Pro . Also available in the Video Menu. For details, see “Selecting Video Options” on pages 46-47.
7	DRC MODE Press repeatedly to cycle through the available Digital Reality Creation modes: Interlaced , Progressive , CineMotion . Also available in the Video Menu. For details, see “Selecting Video Options” on pages 46-47.
8	JUMP Press to jump back and forth between two channels. The TV alternates between the current channel and the last channel that was selected.
9	TV/SAT When the remote control is set to operate the satellite receiver, press to switch between the satellite receiver’s TV and SAT (satellite) inputs. Ⓧ When the remote control is set to operate the TV, press repeatedly to step through the Audio Effect options. Also available in the Audio Menu. For details, see page 48.
10	RESET Press to reset the settings to the factory defaults. See pages 47, 49, and 57. Also used to clear Favorite Channels (see page 42).
11	VOL +/- Press to adjust the volume.
12	CODE SET Press to program the remote control to operate non-Sony video equipment. For details, see “Programming the Remote Control” on page 37.
13	POWER Buttons VCR/DVD: Press to turn on and off the VCR or DVD player. SAT/CABLE: Press to turn on and off the satellite receiver or cable box. TV: Press to turn on and off the TV.
14	FUNCTION Buttons The indicator lights up momentarily when pressed to show which equipment the remote control is operating: VCR/DVD: Press to have the remote control operate the VCR or DVD player. SAT/CABLE: Press to have the remote control operate the satellite receiver or cable box. TV: Press to have the remote control operate the TV.
15	TV/VIDEO Press repeatedly to cycle through the TV’s video inputs.

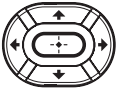
Button	Description
16 DISPLAY	Press once to display the current channel number, current time, and channel label (if set) and other information. Press again to turn Display off.
17 SCREEN MODE	<p>KV-27/32/36HS420 Only Press to toggle between the Screen Mode options: Normal and Zoom. Also available in the Setup menu (page 60). For details on using Screen Mode, see page 41.</p> <p>KV-30/34HS420 Only Press repeatedly to step through the Screen Mode settings: Wide Zoom, Normal, Full, Zoom. Also available in the Screen menu (page 50). For details on using Screen Mode, see page 40.</p>
18 0 - 9 ENTER	Press 0 - 9 to select a channel; the channel changes after 3 seconds. Press ENTER to change channels immediately.
19 GUIDE	Press to display the program guide of your satellite program provider.
20 	Press ↑ ↓ ← → to move the on-screen cursor. To select an item, press ⊕ ⊖ . When no menus are displayed, pressing ⊕ ⊖ displays the Favorite Channels screen. (For more information about Favorite Channels, see page 42.)
21 MENU	Press to display the Menu. Press again to exit from the Menu. For details, see "Using the Menus" on page 45.
22 CH +/-	Press to scan through channels. To scan quickly through channels, press and hold down either CH button.

Programming the Remote Control

If you have video equipment other than Sony brand (or if you have a Sony DVD/VCR combination unit) that you want to control with the TV's remote control, use the following procedure to program the remote control.

 The equipment must have infrared (IR) remote capability in order to be used with the remote control.

- 1 Turn to the list of "Manufacturer's Codes" on page 38, and find the three-digit code number for the manufacturer of your equipment. (If more than one code number is listed, use the number listed first.)
- 2 Press **CODE SET**.
- 3 Press the **VCR/DVD FUNCTION** or **SAT/CABLE FUNCTION** button.
- 4 Using the **0-9** buttons, enter the three-digit manufacturer's code number.
- 5 Press the **ENTER** button.

 You must do step 5 within 10 seconds of step 4, or you must redo steps 2 through 5.

- 6 To check if the code number works, aim the TV's remote control at the equipment and press the **POWER** button that corresponds with that equipment. If it responds, you are done. If not, try using another code listed for that manufacturer.

Notes

- ❑ If more than one code number is listed, try entering them one by one until you come to the correct code for your equipment.
- ❑ If you enter a new code number, the code number you previously entered at that setting is erased.
- ❑ In some cases, you may not be able to operate your equipment with the supplied remote control. In such cases, use the equipment's own remote control.
- ❑ Whenever you remove the batteries to replace them, the code numbers may revert to the factory setting and must be reprogrammed.

Manufacturer's Codes

VCRs

<i>Manufacturer</i>	<i>Code</i>
Sony	301, 302, 303
Admiral (M. Ward)	327
Aiwa	338, 344
Audio Dynamic	314, 337
Broksonic	319, 317
Canon	309, 308
Citizen	332
Craig	302, 332
Criterion	315
Curtis Mathes	304, 338, 309
Daewoo	341, 312, 309
DBX	314, 336, 337
Dimensia	304
Emerson	319, 320, 316, 317, 318, 341
Fisher	330, 335
Funai	338
General Electric	329, 304, 309
Go Video	322, 339, 340
Goldstar	332
Hitachi	306, 304, 305, 338
Instant Replay	309, 308
JC Penney	309, 305, 304, 330, 314, 336, 337
JVC	314, 336, 337, 345, 346, 347
Kenwood	314, 336, 332, 337
LXI (Sears)	332, 305, 330, 335, 338
Magnavox	308, 309, 310
Marantz	314, 336, 337
Marta	332
Memorex	309, 335
Minolta	305, 304
Mitsubishi/ MGA	323, 324, 325, 326
Multitech	325, 338, 321
NEC	314, 336, 337
Olympic	309, 308
Optimus	327
Orion	317
Panasonic	308, 309, 306, 307
Pentax	305, 304
Philco	308, 309
Philips	308, 309, 310
Pioneer	308

<i>Manufacturer</i>	<i>Code</i>
Quasar	308, 309, 306
RCA/ PROSCAN	304, 305, 308, 309, 311, 312, 313, 310, 329
Realistic	309, 330, 328, 335, 324, 338
Sansui	314
Samsung	322, 313, 321
Sanyo	330, 335
Scott	312, 313, 321, 335, 323, 324, 325, 326
Sharp	327, 328
Signature 2000 (M. Ward)	338, 327
SV2000	338
Sylvania	308, 309, 338, 310
Symphonic	338
Tashiro	332
Tatung	314, 336, 337
Teac	314, 336, 338, 337
Technics	309, 308
Toshiba	312, 311
Wards	327, 328, 335, 331, 332
Yamaha	314, 330, 336, 337
Zenith	331

Laserdisc Players

<i>Manufacturer</i>	<i>Code</i>
Sony	701
Panasonic	704, 710
Pioneer	702

DVD/VCR Combination Units

<i>Manufacturer</i>	<i>Code</i>
Sony	601
Broksonic	605
JVC	604
Panasonic	609
Samsung	603
Toshiba	602

DVD Players

<i>Manufacturer</i>	<i>Code</i>
Sony	751
General Electric	755
Hitachi	758
JVC	756
Magnavox	757
Mitsubishi	761
Oritron	759
Panasonic	753
Philips	757
Pioneer	752
RCA/Proscan	755
Samsung	758
Toshiba	754
Zenith	760

Cable Boxes

<i>Manufacturer</i>	<i>Code</i>
Sony	230
Hamlin/Regal	222, 223, 224, 225, 226
Jerrold/G.I./ Motorola	201, 202, 203, 204, 205, 206, 207, 208, 218
Oak	227, 228, 229
Panasonic	219, 220, 221
Pioneer	211, 214, 215
Scientific Atlanta	209, 210, 211
Tocom	216, 217
Zenith	212, 213

Satellite Receivers

<i>Manufacturer</i>	<i>Code</i>
Sony	801
Dish Network	810
Echostar	810
General Electric	802
Hitachi	805
Hughes	804
Mitsubishi	809
Panasonic	803
RCA/ PROSCAN	802, 808
Toshiba	806, 807

Using the Features

Overview

This chapter describes how to use the features of your TV.

Topic	Page
Watching TV	39
Using Screen Mode	KV-30/34HS420 Only 40
	KV-27/32/36HS420 Only 41
Using Favorite Channels	42
Using Other Equipment with Your TV Remote Control	43

Watching TV

 For a complete list of all the functions of the remote control, see pages 33-38.

To Do This ...	Do This ...
Activate the remote control to operate the TV	Press TV FUNCTION
Turn on/off the TV	Press TV POWER
Tune directly to a channel	Press 0-9 and then ENTER (or wait 3 seconds) or Press CH+/-
Adjust the volume	Press VOL +/-
Mute the sound	Press MUTING (press again to unmute)
Alternate back and forth between two channels	Press JUMP The TV alternates between the current channel and the last channel tuned.
Display the current channel number (and other information)	Press DISPLAY once to display the channel number and current time and channel label (if set). Press DISPLAY again to turn Display off.
Switch the TV's input to the VCR, DVD player, or other connected equipment	Press TV/VIDEO repeatedly to cycle through the video equipment connected to the TV's video inputs.
Change video and audio options, customize the TV's setup, set parental controls, and more	Press MENU to display the Menu. For details, see "Using the Menus" on page 45.

Using Screen Mode







Models KV-30/34HS420 Only

 You can also change the Screen Mode settings in the Screen menu. For details, see page 50.

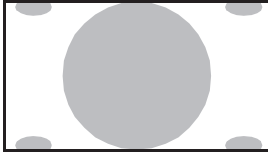
The Screen Mode feature lets you watch 4:3 normal broadcasts in several wide screen modes (16:9 aspect ratio).

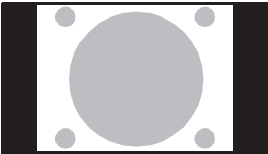
 When viewing high-definition programs broadcast in 720p/1080i, it is not possible to change Screen Modes because those video formats are already widescreen.

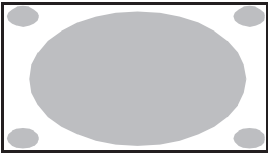
- Press **SCREEN MODE** repeatedly to toggle through the following settings.

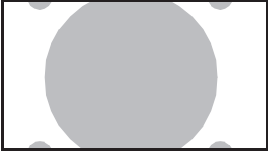
Example	Description
 <p>Wide Zoom</p> <p>↓</p>	<p>Wide Zoom enlarges the center portion of the 4:3 picture proportionately; however, only the left and right edges of the screen are stretched to fill the 16:9 screen. The picture has a normal appearance, as much as possible.</p> 
 <p>Normal</p> <p>↓</p>	<p>Normal returns the 4:3 picture to its original size. Black bars are visible at left and right sides to fill the 16:9 screen.</p> 
 <p>Full</p> <p>↓</p>	<p>Full Mode stretches the entire 4:3 picture horizontally only, to fill the 16:9 screen. The picture has an elongated appearance.</p> 
 <p>Zoom</p>	<p>Zoom Mode enlarges the entire 4:3 picture proportionately to fill the 16:9 screen. Useful for watching Letterbox movies.</p> 

When you change channels or inputs, the Screen Mode settings revert to the **4:3 Default** setting in the Screen menu. To retain the current Screen Mode setting as channels and inputs are changed, set **4:3 Default** to **Off**. For details, see page 51.

Features

Models KV-27/32/36HS420 Only

 You can also change the Screen Mode in the Setup menu. For details, see page 60.

The Screen Mode feature is useful when a 480i signal has been upconverted to a 720p or 1080i signal, which results in undesirable “black bars” appearing on all four sides of the picture. Using the Screen Mode feature, you can enlarge these pictures, minimizing the size of the black bars.

- ❑ Press **SCREEN MODE** to toggle between Normal and Zoom modes.

Example

Description

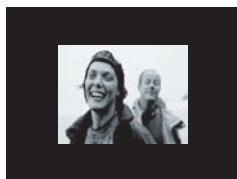

Normal



Zoom

Normal displays a 480i signal that has been upconverted to 720p or 1080i with black bars visible at left, right, top, and bottom sides.

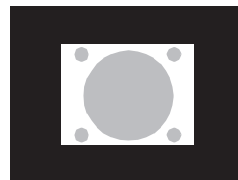

Zoom enlarges the picture, minimizing the size of the black bars.

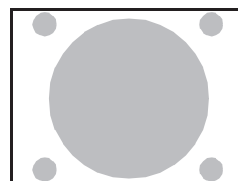





Using Favorite Channels



The Favorite Channels feature lets you select programs from a list of up to eight favorite channels that you specify.

Creating a List of Favorite Channels

 For details on using the Channel Menu, see page 52.

- 1 Press **MENU** to display the Menu.
- 2 Press **←** or **→** to highlight the Channel icon and press .
- 3 Press  to select **Favorite Channels**.
- 4 Press **↑** or **↓** to highlight a Favorite Channel number (1-8) and press .
- 5 Press **↑** or **↓** to highlight a channel you want to assign to the Favorite Channel number.
- 6 Press  to select that channel as a Favorite Channel.
- 7 To add more channels to your favorites list, repeat steps 4-6.
To clear a Favorite Channel, press **↑** or **↓** to highlight the channel you want to clear. Press  and then press **RESET**.
- 8 Press **MENU** to exit the Menu.

Displaying a List of Favorite Channels









- 1 During normal viewing (with no menus on screen), press . The Favorite Channels list appears.
- 2 Press **↑** or **↓** to highlight the channel you want to watch.
- 3 Press  to select the channel you want to watch.

Using Other Equipment with Your TV Remote Control





All Equipment

To Do This ...	Do This ...
Switch the TV's input to the VCR, DVD player, or other connected equipment	Press TV/VIDEO repeatedly to cycle through the video equipment connected to the TV's video inputs.
Set up the TV remote control to operate non-Sony equipment (and Sony DVD/VCR combination unit)	You must program the remote control the first time you use it. See "Programming the Remote Control" on pages 37 to 38.

Operating a VCR

To Do This ...	Press
Activate the remote control to operate the VCR	VCR/DVD FUNCTION
Turn on/off	VCR/DVD POWER
Change channels	CH +/- (using tuner)
Adjust tracking	CH +/- (during tape playback)
Record	 and  simultaneously
Play	
Stop	
Fast forward	
Rewind the tape	
Pause	
Search the picture forward or backward	 or  during playback (release to resume normal playback)

Operating a Satellite Receiver

To Do This ...	Press
Activate the remote control to operate the satellite receiver	SAT/CABLE FUNCTION
Turn on/off	SAT/CABLE POWER
Select a channel	0-9, ENTER
Change channels	CH +/-
Back to previous channel	JUMP
Display channel number	DISPLAY
Display SAT Guide	GUIDE
Display SAT Menu	MENU
Move highlight (cursor)	   
Select item	

Operating a Cable Box

To Do This ...	Press
Activate the remote control to operate the cable box	SAT/CABLE FUNCTION
Turn on/off	SAT/CABLE POWER
Select a channel	0-9, ENTER
Change channels	CH +/-
Back to previous channel	JUMP

Operating a DVD Player

To Do This ...	Press
Activate the remote control to operate the DVD	VCR/DVD FUNCTION
Turn on/off	VCR/DVD POWER
Play	▶
Stop	■
Pause	⏸
Step through different tracks of the disc	▶▶ to step forward or ◀◀ to step backward
Step through different chapters of a video disc	CH+ to step forward or CH- to step backward
Select tracks directly	0-9, ◀ ▶ (to move cursor), ENTER
Display the DVD menu	MENU
Move highlight (cursor)	↑ ↓ ◀ ▶
Select item	SELECT

Operating a DVD/VCR Combination Unit

 When the VCR is not playing, TV/VCR/DVD switches between the DVD player and the VCR's tuner.







To Do This ...	Press
Activate the remote control to operate the DVD/VCR	VCR/DVD FUNCTION
Turn on/off	VCR/DVD POWER
Switch between the DVD player and VCR	TV/VCR/DVD
Display the DVD menu	MENU
Play	▶
Stop	■
Pause	⏸
Search the picture forward or backward	▶▶ or ◀◀ during playback
Move highlight (cursor) and select (DVD)	↑ ↓ ◀ ▶ ⊕
Record (VCR)	▶ and ● simultaneously
Change channels (VCR)	CH +/- or 0-9, ENTER (using tuner)
Adjust tracking (VCR)	CH +/- (during tape playback)

Using the Menus

Overview

 Press **MENU** to enter and exit Menus.



The Menu gives you access to the following features:

Menu Icon	Description	Page
	Allows you to make adjustments to your picture settings. It also allows you to customize the Picture Mode based on the type of program you are viewing, select DCR Mode options, and more.	46
	Offers enhanced audio options such as listening to second audio programming (SAP) or customizing the Effect of the sound on your TV.	48
	KV-30/34HS420 Only Allows you to make Screen Mode adjustments and make changes to the screen's vertical center and size.	50
	Allows you to set up a Favorite Channels list, run the Auto Program function, and more.	52
	Lets you control the viewing of programs based on their ratings.	54
	KV-27/32/36HS420 Only Lets you set the clock on your TV and allows you to program your TV for scheduled viewing using the Timers.	57
	Provides several options for setting up your channels, labeling your video inputs, and selecting the language of the on-screen Menus.	58

KV-30/34HS420 Only
Timer functions are included in the Setup menu.

Navigating Through Menus

 Menus include navigation help text that appears at the bottom of each screen.

To Do This ...	Press
Display the Menu	MENU
Move through the Menu	← →
Move through the Menu options	↑ ↓
Select an option to change	
Change an option's settings	↑ ↓ ← →
Select (confirm) changed setting	 or ←
Exit the Menu	MENU

Using the Video Menu



To access the Video Menu, follow these steps:

1. Display menu



2. Highlight

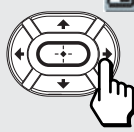

3. Select

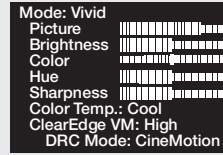

To change settings, press **↑ ↓ ← →**.
Press **⊕** to confirm the selection.

To exit the Menu, press **MENU**.

Selecting Video Options



You can also change the Mode setting using the **PICTURE MODE** button on the remote control.



You can alter the Video Menu settings (**Picture**, **Brightness**, **Color**, etc.) for each Mode.

The Video Menu includes the following options:

Option	Description
Mode	Vivid Select for enhanced picture contrast and sharpness.
<i>Customized picture viewing</i>	Standard Select for standard picture settings.
	Movie Select to display a softer picture.
	Pro Select to display a picture with minimum enhancements.
Picture	Adjust to increase picture contrast and deepen the color, or decrease picture contrast and soften the color.
Brightness	Adjust to brighten or darken the picture.
Color	Adjust to increase or decrease color intensity.
Hue	Adjust to increase or decrease the green tones.
Sharpness	Adjust to sharpen or soften the picture.
Color Temp.	Cool Select to give the white colors a blue tint.
<i>White intensity adjustment</i>	Neutral Select to give the white colors a neutral tint.
	Warm Select to give the white colors a red tint (NTSC-Standard).



You can also change the DRC Mode setting using the **DRC MODE** button on the remote control.

<i>Option</i>	<i>Description</i>
ClearEdge VM <i>Velocity</i> <i>Modulation</i>	Sharpens picture definition to give every object a sharp, clean edge. Select from High, Medium, Low, Off .
DRC Mode <i>Digital</i> <i>Reality</i> <i>Creation</i>	Creates a high-resolution picture with 4x density, for high quality sources (i.e., DVD player, satellite receiver).
Interlaced	Recommended for moving pictures.
Progressive	Recommended for still images and text.
CineMotion	Provides an optimized display by automatically detecting film content and applying a reverse 3-2 pulldown process. Moving pictures will appear clearer and more natural-looking.

To restore the factory default settings for Picture, Brightness, Color, Hue, Sharpness, Color Temp and ClearEdge VM.

- Press **RESET** on the remote control when in the Video Menu.

Using the Audio Menu



To access the Audio Menu, follow these steps:

1. Display menu



2. Highlight

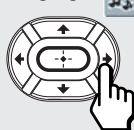

3. Select

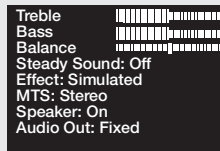

To change settings, press **↑ ↓ ← →**.
Press **⊕** to confirm the selection.

To exit the Menu, press **MENU**.

Selecting Audio Options

The Audio Menu includes the following options:

Option	Description
Treble	Adjust to decrease or increase higher-pitched sounds.
Bass	Adjust to decrease or increase lower-pitched sounds.
Balance	Adjust to emphasize left or right speaker balance.
Steady Sound	Auto Select to stabilize the volume.
	Off Select to turn off Steady Sound.
ⓘ The Steady Sound option is not available (it is grayed out) if the Effect option is set to TruSurround, Simulated, or WOW. To use Steady Sound, set Effect to Off.	
Effect	TruSurround Select for surround sound (for stereo programs only).
	Simulated Adds a surround-like effect to mono programs.
	WOW Provides a dramatic presence with a full, deep bass sound. When WOW is enabled, BBE is activated to further enhance the audio performance.
MTS <i>Enjoy stereo, bilingual and mono programs</i>	Off Normal stereo or mono reception.
	Stereo Select for stereo reception when viewing a program broadcast in stereo.
	Auto SAP Select to automatically switch the TV to second audio programs when a signal is received. (If no SAP signal is present, the TV remains in Stereo mode.)
Mono	Select for mono reception. (Use to reduce noise during weak stereo broadcasts.)

You can also change the Effect setting using the **Ⓢ** button on the remote control.

BBE is audio technology that compensates for phase effects in speakers, giving sound more impact.

You can also change the MTS setting using the **MTS** button on the remote control.

<i>Option</i>	<i>Description</i>
Speaker	On Select to turn on the TV speakers.
	Off Select to turn off the TV speakers and listen to the TV's sound only through your external audio system speakers.
Audio Out <i>Easy control of volume adjustments</i>	This option can be set only when the Speaker option is set to Off .
	Variable The TV's speakers are turned off, but the volume output from your audio system can still be controlled by the TV's remote control.
	Fixed The TV's speakers are turned off and the volume output of the TV is fixed. Use your audio receiver's remote control to adjust the volume through your audio system.

To restore the factory default settings for Treble, Bass, and Balance

- Press **RESET** on the remote control when in the Audio Menu.



To access the Screen Menu, follow these steps:

1. Display menu



2. Highlight

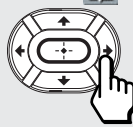

3. Select



Screen Mode: Wide Zoom
4:3 Default: Wide Zoom
Vertical Center
Vertical Size

To change settings, press **↑ ↓ ← →**.
Press **↵** to confirm the selection.

Press **MENU** to exit the Menu.

Selecting Screen Mode Options

 You can also change the Screen Mode setting using the **SCREEN MODE** button on the remote control.

The Screen menu includes the following options:

Option	Description
Screen Mode <i>Select a Screen Mode to use for 4:3 sources.</i>	The Screen Mode feature lets you watch 4:3 normal broadcasts in several wide screen modes (16:9 aspect ratio). For details, see page 40.
Wide Zoom	Select to enlarge the 4:3 size picture, while the upper and lower parts of the picture are condensed to fit the wide screen.
Normal	Select to return the 4:3 picture to normal mode.
Full	Select to enlarge the 4:3 picture horizontally only, to fill the wide screen.
Zoom	Select to enlarge the 4:3 picture horizontally and vertically to an equal aspect ratio that fills the wide screen.

Screen Mode is unavailable when viewing HD (1080i, 720p) sources because those sources are already widescreen.

 In some cases, wide-screen programs will be shown in aspect ratios that require the display of black bands at the top and bottom of your 16:9 screen. For more details, see page 64.

 If 4:3 Default is set to anything but **Off**, the Screen Mode setting changes only for the current channel. When you change channels (or inputs), Screen Mode is automatically replaced with the 4:3 Default setting. To retain the current Screen Mode setting as channels and inputs are changed, set **4:3 Default** to **Off**.

Option	Description	
4:3 Default <i>Select the default Screen Mode to use for 4:3 sources</i>	Wide Zoom	Select to enlarge the 4:3 size picture, while the upper and lower parts of the picture are condensed to fit the wide screen.
	Normal	Select to return the 4:3 picture to normal mode.
	Full	Select to enlarge the 4:3 picture horizontally only, to fill the wide screen.
	Zoom	Select to enlarge the 4:3 picture horizontally and vertically to an equal aspect ratio that fills the wide screen.
	Off	Select to continue using the current Screen Mode setting when the channel or input is changed.
Vertical Center	Allows you to move the position of the picture up and down in the window. (Available only in Wide Zoom and Zoom modes.) Press ▲ or ▼ and press (-+) to choose a correction between +15 and -15 (Zoom mode), and +5 and -5 (Wide Zoom mode).	
Vertical Size	Allows you to adjust the vertical size of the picture. (Available only in Wide Zoom and Zoom modes.) Press ▲ or ▼ and press (-+) to choose a correction between +7 and -7.	

Using the Channel Menu



To access the Channel Menu, follow these steps:

1. Display menu



2. Highlight

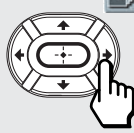

3. Select



Favorite Channels
Cable: On
Channel Fix: Off
Auto Program
Channel Skip/Add
Channel Label

To change settings, press **▲ ▼ ◀ ▶**.
Press **⏏** to confirm the selection.









To exit the Menu, press **MENU**.

Selecting Channel Options

The Channel Menu includes the following options:

Option	Description
Favorite Channels	Lets you set up a list of your favorite channels. For details, see “Displaying a List of Favorite Channels” on page 42.
Cable	<p>On Select if you are receiving cable channels with a CATV cable.</p> <p>Off Select if you are using an antenna.</p>
 You should run Auto Program after changing this option.	
Channel Fix <i>Useful when you have a cable box or satellite receiver connected</i>	<p>Off Turns off Channel Fix.</p> <p>2-6 “Fix” your TV’s channel setting to 2-6 and use the cable box or satellite receiver to change channels. Select one of these settings if you connected the equipment to the VHF/UHF jack.</p>
Video 1	Use this setting if you have connected the equipment to the A/V input jacks.
Auto Program	Automatically sets up the channel list on the TV for all receivable channels.
Channel Skip/Add	<p>Allows you to customize the channel list that appears when you use the CH+/- buttons.</p> <ol style="list-style-type: none"> Press ▲ or ▼ to scroll through the channels until you find the channel you want to skip or add. Then press ⏏ to select it. Press ▲ or ▼ to toggle between Add or Skip. Then press ⏏ to select. To add or skip more channels, repeat steps 1 and 2. Press ◀ to return to the Channel Setup Menu, or press MENU to exit the Menus.

 Channels that you set to be skipped can be accessed only with the **0-9** buttons.

<i>Option</i>	<i>Description</i>
Channel Label	<p>Allows you to assign labels (such as station call letters) to channel numbers. You can label up to 20 channels.</p> <ol style="list-style-type: none">1 Highlight Channel and press .2 Press   to scroll through the channel numbers (1-125). Then press  to select the channel number that you want to assign a label.3 Highlight Label and press .4 Press   to scroll through the label characters (A-Z, 0-9, etc). Then press  to select the highlighted character. Repeat to add up to 5 characters to the label.5 To assign labels to more channels, repeat steps 1-4.6 Press  to return to the Channel Menu, or press MENU to exit the Menus.

Using the Parent Menu



The Parent Menu allows you to set up the TV to block programs according to their content and rating levels.

To access the Parent Menu, follow these steps:

1. Display menu



2. Highlight

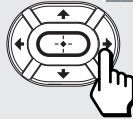

3. Select

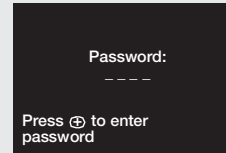

Use the 0-9 buttons on the remote control to enter a four-digit password.

If this is the first time you are creating this password, confirm the password by entering it again. (The Parent Menu options appear.)

To change settings, press **↑ ↓ ← →**. Press **[Enter]** to confirm the selection.

To exit the Menu, press **MENU**.

You need your password for any future access into the Parent Menu. If you lose your password, see "Lost password" on page 65.

Selecting Parent Menu Options

If you are not familiar with the Parental Guideline rating system, you should select **Child**, **Youth**, or **Young Adult** to help simplify the rating selection. To set more specific ratings, select **Custom**.

For descriptions of **Child**, **Youth**, and **Young Adult** ratings, see page 55.

The Parent Menu includes the following options:

Option	Description
Parental Lock	Off Parental lock is off. No programs are blocked from viewing.
<i>Turn ratings on/off and select a rating system</i>	<p>Child Maximum ratings permitted are:</p> <ul style="list-style-type: none"> <input type="checkbox"/> US: TV-Y, TV-G, G <input type="checkbox"/> Canada: C, G, TV-Y <p>Youth Maximum ratings permitted are:</p> <ul style="list-style-type: none"> <input type="checkbox"/> US: TV-PG, PG <input type="checkbox"/> Canada: C8+, PG, 8 ans+, TV-PG <p>Y. Adult Maximum ratings permitted are:</p> <ul style="list-style-type: none"> <input type="checkbox"/> US: TV-14, PG-13 <input type="checkbox"/> Canada: 14+, 13 ans+, TV-14 <p>Custom Select to set ratings manually.</p> <ul style="list-style-type: none"> <input type="checkbox"/> US: See page 55 for details. <input type="checkbox"/> Canada: See page 56 for details.
Change Password	For changing your password.
Select Country	<p>U.S.A. Select to use USA ratings (see page 55).</p> <p>Canada Select to use Canadian ratings (see page 56).</p>

US Models: Selecting Custom Rating Options

 The Content-Based Ratings are linked to the level of the Age-Based Rating. For example, a program with an Age-Based Rating of TV-PG V (Violence) rating may contain moderate violence, while a TV-14 V (Violence) rating may contain more intense violence.

 To ensure maximum blocking capability, set the Age-Based Ratings.

 If you block unrated TV programs, be aware that the following types of programs may be blocked: emergency broadcasts, political programs, sports, news, public service announcements, religious programs and weather.

Viewing Blocked Programs

For US models, the Custom Rating Menu includes the following options. (For Canadian models, see page 56.)

Option	Description	
Movie Rating	G All children and General Audience.	
	PG Parental Guidance suggested.	
	PG-13 Parental Guidance for children under 13.	
	R Restricted viewing, parental guidance is suggested for children under 17.	
	NC-17 and X No one 17 or under allowed.	
TV Rating <i>Block programs by their rating, content or both</i>	Age-Based Ratings	
	TV-Y All children.	
	TV-Y7 Directed to children age 7 and older.	
	TV-G General Audience.	
	TV-PG Parental Guidance suggested.	
	TV-14 Parents Strongly cautioned.	
	TV-MA Mature Audience only.	
	Content-Based Ratings	
	FV Fantasy Violence.	
	D Suggestive Dialogue.	
L Strong Language.		
S Sexual situations.		
V Violence.		
Unrated <i>Block programs or movies that are broadcast without a rating</i>	Block Blocks all programs and movies that are broadcast without a rating.	
	Allow Allows programs and movies that are broadcast without a rating.	

You can view blocked programs by entering the password. Press the **ENTER** button when tuned to a blocked program, then enter the password. This temporarily switches off the Parental Lock. To reactivate the Parental Lock settings, turn off the TV. When the TV is turned on again, your Parental Lock settings are reactivated.

Canadian Models: Selecting Custom Rating Options

For Canadian models, the Custom Rating Menu includes the following options. (For US models, see page 55.)

Option	Description	
English Rating	C	All children.
	C8+	Children 8 years and older.
	G	General programming.
	PG	Parental Guidance.
	14+	Viewers 14 and older.
	18+	Adult programming.
French Rating	G	General programming.
	8 ans+	Not recommended for young children.
	13 ans+	Not recommended for ages under 13.
	16 ans+	Not recommended for ages under 16.
	18 ans+	Programming restricted to adults.
U.S.A. Rating	See "US Models" on page 55 for details.	

Viewing Blocked Programs

You can view blocked programs by entering the password. Press the **ENTER** button when tuned to a blocked program, then enter the password. This temporarily switches off the Parental Lock. To reactivate the Parental Lock settings, turn off the TV. When the TV is turned on again, your Parental Lock settings are reactivated.

Using the Timer Menu KV-27/32/36HS420 Only

To access the Timer Menu, follow these steps:



1. Display menu



2. Highlight

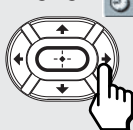

3. Select



Timer 1: Off
Timer 2: Off
Current Time

To exit the Menu, press **MENU**.

Selecting Timer Options

The Timer Menu includes the following options:

Option	Description
Timer 1	You can use the Timer to program the TV to turn on and off and tune to a specific channel at two scheduled viewing times. Timer 1 and Timer 2 are not available to be set until you set the Current Time.
Timer 2	
	<ol style="list-style-type: none"> Press ▲ or ▼ to highlight Timer 1 or Timer 2. To set the timer, press ▶. Press ▲ or ▼ to highlight one of the following options, then press ⏏. <ul style="list-style-type: none"> Program Select to set the Timer by day, time, duration, and channel. Off Select to turn off the Timer. (Your previous settings are saved.) Press ▲ and ▼ to set the day(s), hour, minute, duration, and channel number. Press ⏏ or ▶ to confirm each setting and move to the next setting. Press ◀ to go back to the previous setting. Press MENU to exit the Menu. An LED on the front panel will light, indicating the timer has been set.
Current Time	<ol style="list-style-type: none"> Press ▲ and ▼ to set the current time (day, hour, and minute). Press ⏏ (or press ▶) to confirm each setting and move to the next setting. Press ◀ to go back to the previous setting. Press MENU to exit the Menu.

To go directly to programming Timer 1 or 2 in step 1, press **⏏** instead of pressing **▶**.

To return to the Timer Menu after programming one of the Timers, press **⏏** when the highlight is in the channel number field.

To return to the Timer Menu after setting the Current Time, press **⏏** when the highlight is in the minute field.



To reset the Clock or Timers

- ❑ Press **RESET** on the remote control, when in the Timer Menu, to reset to the factory defaults.

Using the Setup Menu

Setup

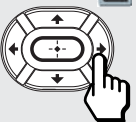
To access the Setup Menu, follow these steps:

1. Display menu

2. Highlight

3. Select

To change settings, press **↑ ↓ ← →**.
 Press **+** to confirm the selection.

To exit the Menu, press **MENU**.

Caption Vision: Off
 Info Banner: On
 Video Label
 Tilt Correction: 0
 Language: English
 16:9 Enhanced
 Screen Mode: Normal

Setup Menu for
 KV-27/32/36HS420



Caption Vision: Off
 Info Banner: On
 Video Label
 Tilt Correction
 Vertical Correction
 Language: English
 Clock/Timers

Setup Menu for
 KV-30/34HS420

Selecting Setup Options

The Setup Menu includes the following options:

Option	Description	
Caption Vision	Allows you to select from three closed caption modes (for programs that are broadcast with closed caption).	
	CC1, CC2, CC3, CC4	Displays a printed version of the dialog or sound effects of a program. (Should be set to CC1 for most programs.)
	Text1, Text2, Text3, Text4	Displays network/station information presented using either half or the whole screen (if available). For closed captioning, set to CC1 .
	Off	Turns off Caption Vision.
Info Banner	Displays the program name and the time remaining in the program (if the broadcaster offers this service). Displays when the channel is changed or the DISPLAY button is pressed. Set to On or Off .	

Option	Description				
Video Label	<p>Allows you to identify A/V equipment you connected to the TV, such as a VCR, DVD, etc. For example, if you have a DVD player connected to the VIDEO 5 jack, you can select the label DVD for the VIDEO 5 input. Then when you press the TV/VIDEO button to change inputs, the Video Label you assigned to that input appears on screen.</p> <ol style="list-style-type: none"> Press ▲ or ▼ to highlight the video input (VIDEO 1-7) to which you want to assign a label. Then press ⏏ to select the input. Press ▲ or ▼ to highlight one of the displayed labels. Then press ⏏ to select the label. <p>You can select from the following labels for each input:</p> <table border="1"> <tr> <td>Video 1/2/3/4</td> <td>VHS, DVD, Receiver, Satellite, Cable Box, 8mm, DTV, Game, LD, Web, Beta, Skip</td> </tr> <tr> <td>Video 5/6/7</td> <td>DVD, Satellite, Cable Box, DTV, HD, Skip</td> </tr> </table> <p> If you select Skip, your TV skips this input when you press the TV/VIDEO button.</p>	Video 1/2/3/4	VHS, DVD, Receiver, Satellite, Cable Box, 8mm, DTV, Game, LD, Web, Beta, Skip	Video 5/6/7	DVD, Satellite, Cable Box, DTV, HD, Skip
Video 1/2/3/4	VHS, DVD, Receiver, Satellite, Cable Box, 8mm, DTV, Game, LD, Web, Beta, Skip				
Video 5/6/7	DVD, Satellite, Cable Box, DTV, HD, Skip				
Tilt Correction	<p>Allows you to correct any tilt of the picture.</p> <p>Press ◀ or ▶ to choose a correction between +7 and -7 and press ⏏.</p>				
Vertical Correction KV-30/34HS420 Only	<p>Allows you to make a vertical correction to the picture.</p> <p>Press ◀ or ▶ to choose a correction between +5 and -5 and press ⏏.</p>				
Language	<p>Select to display all on-screen Menus in your language of choice.</p>				
16:9 Enhanced KV-27/32/36HS420 Only	<p>Provides enhanced picture resolution for widescreen (anamorphic) sources, such as selected DVD titles. This option is available only when the TV is set to VIDEO 1-7, which you can do by pressing the TV/VIDEO button.</p> <table border="1"> <tr> <td>On</td> <td>To activate manually. Returns to Auto when you switch to another video input or change channels.</td> </tr> <tr> <td>Auto</td> <td>To activate automatically when a 16:9 signal is received.</td> </tr> </table> <p> If the Auto setting does not automatically detect the 16:9 signal from your DVD player, select On to manually turn on the 16:9 Enhanced feature.</p>	On	To activate manually. Returns to Auto when you switch to another video input or change channels.	Auto	To activate automatically when a 16:9 signal is received.
On	To activate manually. Returns to Auto when you switch to another video input or change channels.				
Auto	To activate automatically when a 16:9 signal is received.				

 The **Skip** label is useful for inputs that do not have equipment connected to them.

 Normally, **Tilt Correction** and **Vertical Correction** only need to be adjusted the first time you turn on the unit and after the unit is moved to a new location.

 To use **16:9 Enhanced** with widescreen DVDs, set your DVD player to 16:9 aspect ratio. (Aspect ratio is the ratio of width to height of the screen. 16:9 is also referred to as widescreen format.)

Option	Description
Clock/Timers KV-30/34HS420 Only	Select to set the clock and to program your TV to turn on and off at two scheduled viewing times.
Timer 1	You can use the Timers to program the TV to turn on and off and tune to a specific channel at two scheduled viewing times.
Timer 2	
Timer 1 and Timer 2 are not available to be set until you set the Current Time .	
1	Press ▲ or ▼ to highlight Timer 1 or Timer 2 . To set the timer, press ▶ .
2	Press ▲ or ▼ to highlight one of the following options, then press ⏪ .
Program	Select to set the Timer by day, time, duration, and channel.
Off	Select to turn off the Timer. (Your previous settings are saved.)
3	If you selected Program in step 2, press ▲ and ▼ to set the day(s), hour, minute, duration, and channel number. Press ⏪ or ▶ to confirm each setting and move to the next setting. Press ◀ to go back to the previous setting.
4	Press MENU to exit the Menu. An LED on the front panel will light, indicating the timer has been set.
Current Time	
1	Press ⏪ to select Current Time .
2	Press ▲ and ▼ to set the current time (day, hour, and minute). Press ⏪ or ▶ to confirm each setting and move to the next setting. Press ◀ to go back to the previous setting.
3	Press MENU to exit the Menu.
Screen Mode KV-27/32/36HS420 Only	Allows you to minimize the size of the "black bars" and increase the picture size of 480i signals that have been upconverted to 720p or 1080i. For details, see page 41.
Normal	Select to return the picture to its normal size.
Zoom	Enlarges the picture size.
 The Screen Mode option is grayed out when it is not available.	

 To go directly to programming Timer 1 or 2, press **⏪** instead of pressing **▶**.

 To return to the Timer Menu after programming one of the Timers, press **⏪** when the highlight is in the channel number field.

 To return to the Timer Menu after setting the Current Time, press **⏪** when the highlight is in the minute field.

 You can also change the Screen Mode setting using the **SCREEN MODE** button on the remote control.

Other Information

Overview

This chapter includes the following topics:

<i>Topic</i>	<i>Page</i>
Glossary	62
Contacting Sony	63
Troubleshooting	63
Specifications	66
Optional Accessories	67
Index	69

Glossary

analog signal

A signaling method that uses continuous changes in the amplitude or frequency of an electronic transmission to convey information.

aspect ratio

Refers to the ratio between the width and height of the screen. KV-27/32/36HS420 models have a 4:3 aspect ratio; KV-30/34HS420 models have a 16:9 (widescreen) aspect ratio.

4:3 aspect ratio



16:9 aspect ratio



component video



Component video is sent through three cables: two color shade (chrominance) signals and one brightness (luminance) signal. Component video achieves greater color accuracy than composite video or S VIDEO by splitting chrominance into two separate portions.

composite video



Composite video is sent through a single cable. Composite video combines the color shade (chrominance) and brightness (luminance) information into one video signal.

degauss

A process that demagnetizes the metal components in the TV monitor, which eliminates image distortion that can result from magnetic charges acquired by the TV's components. Your TV degausses automatically when it is turned on.

digital television (DTV)

A new technology for transmitting and receiving broadcast television signals. DTV provides clearer resolution and improved sound quality over analog television.

HDMI (High-Definition Multimedia Interface)

Provides an uncompressed, all-digital audio/video interface between this TV and any HDMI-equipped audio/video component, such as a set-top box, DVD player, and A/V receiver. HDMI supports enhanced, or high-definition video, plus two-channel digital audio.

National Television System Committee (NTSC)

A unit of the Federal Communications Commission, Washington, DC, that establishes television standards in the United States, such as NTSC Color, the standard used in this TV.

RF

Radio Frequency. That part of the frequency spectrum that is used to transmit TV and radio signals.

S VIDEO



S VIDEO requires a single cable, which carries the brightness (luminance) and color (chrominance) signals of the picture separately. S VIDEO provides better resolution than composite video, which carries the signals together.

VHF/UHF

VHF (Very High Frequency) is the part of the frequency spectrum from 30 to 300 megahertz. UHF (Ultra High Frequency) is the part of the frequency spectrum from 300 to 3,000 megahertz.

480i

Provides 480 lines of resolution. Displays images using interlaced scanning, which first transmits all the odd lines on the TV screen and then the even lines.

480p

Provides 480 lines of resolution. Displays images using progressive scanning, which transmits each line from top to bottom.

720p

Provides 720 lines of resolution. Displays images using progressive scanning, which transmits each line from top to bottom.

1080i

Provides 1080 lines of resolution. Displays images using interlaced scanning, which first transmits all the odd lines on the TV screen and then the even lines. 1080i is one of the formats used by HDTV (High Definition TV).

Contacting Sony

If, after reading these operating instructions, you have additional questions related to the use of your Sony television, please call our Customer Information Services Center at 1-800-222-SONY (7669) (US residents only) or (416) 499-SONY (7669) (Canadian residents only).

Before calling Sony customer support, please write down the model and serial numbers of your TV. You'll find this information on the front cover of this manual.

Troubleshooting

Remote Control

Problem	Possible Remedies
Remote control does not operate	<ul style="list-style-type: none">❑ The batteries could be weak. Replace the batteries.❑ Check the orientation of the batteries.❑ Press the TV FUNCTION button. You may have inadvertently pressed the SAT/CABLE FUNCTION or DVD/VCR FUNCTION button.❑ Make sure the TV's power cord is connected securely to the wall outlet.❑ Locate the TV at least 3-4 feet away from fluorescent lights.
Cannot change channels with the remote control	<ul style="list-style-type: none">❑ If you are using the TV to change channels, first press the TV FUNCTION button.❑ If you are using another device to change channels, be sure you have not inadvertently switched your TV from the channel 3 or 4 setting. Use the Channel Fix option to "fix" the channel based on the hookup you used (see page 52).❑ If you are using another device to change channels, be sure to press the FUNCTION button for that device. For example, if you are using your cable box to change channels, be sure to press the SAT/CABLE FUNCTION button.
Remote control does not operate non-Sony video equipment	<ul style="list-style-type: none">❑ If you replaced the batteries to the remote recently, the code numbers for the video equipment may need to be reprogrammed.❑ There may be more than one code for the equipment that you are attempting to operate.❑ There is a possibility that some non-Sony equipment cannot be operated by your Sony TV remote. You may need to use the equipment's original remote control.

Channels

Problem	Possible Remedies
Cannot receive upper channels (UHF) when using an antenna	<ul style="list-style-type: none">❑ Change the Cable option to Off (see page 52).❑ Use Auto Program in the Channel Menu to add receivable channels that are not presently in the TV's memory (see page 52).
TV is fixed to one channel	<ul style="list-style-type: none">❑ Use Auto Program in the Channel Menu to add receivable channels that are not presently in the TV's memory (see page 52).❑ Check your Channel Fix settings (see page 52).
Cannot receive any channels when using cable TV	<ul style="list-style-type: none">❑ Use Auto Program in the Channel Menu to add receivable channels that are not presently in the TV's memory (see page 52).❑ Make sure the Cable option is set to On in the Channel Menu (see page 52).
Cannot receive or select channels	<ul style="list-style-type: none">❑ Use Auto Program in the Channel Menu to add receivable TV channels that are not presently in TV memory (see page 52).

Video

Problem	Possible Remedies
No picture (screen not lit), no sound	<ul style="list-style-type: none">❑ If your TV does not turn on, and a red light keeps flashing, your TV may need service. Call your local Sony Service Center.❑ Make sure the power cord is plugged in.❑ Press the POWER button on the front of the TV.❑ Press the TV/VIDEO button to cycle through the connected video sources.❑ Try another channel; it could be station trouble.
Dark, poor or no picture (screen lit), good sound	<ul style="list-style-type: none">❑ Adjust the Picture option in the Video Menu (see page 46).❑ Adjust the Brightness option in the Video Menu (see page 46).❑ Check the antenna/cable connections.
No color	<ul style="list-style-type: none">❑ Adjust the Color option in the Video Menu (see page 46).
Only snow and noise appear on the screen	<ul style="list-style-type: none">❑ Check the antenna/cable connections.❑ Try another channel; it could be station trouble.
Dotted lines or stripes	<ul style="list-style-type: none">❑ Adjust the antenna.❑ Move the TV away from noise sources such as cars, neon signs, or hair-dryers.
Double images or ghosts	<ul style="list-style-type: none">❑ Using a highly directional outdoor antenna or a cable may solve the problem.
"Black box" on screen	<ul style="list-style-type: none">❑ You have selected a text option in the Setup Menu and no text is available. (See page 58 to reset Setup selections.) To turn off this feature, set the Caption Vision option to Off. If you were trying to select closed captioning, select CC1 instead of TEXT 1-4.
16:9 Enhanced feature KV-27/32/36HS420 Only	<ul style="list-style-type: none">❑ If the Auto setting does not automatically detect the 16:9 signal from your DVD player, select On to manually turn on the 16:9 Enhanced feature. For details, see page 59.
Black bands appear at the top and bottom of the screen KV-30/34HS420 Only	<ul style="list-style-type: none">❑ Some wide-screen programs are filmed in aspect ratios that are greater than 16:9, such as 2.35:1. (This is especially common with theatrical releases). Your TV will show these programs with black bands at the top and bottom of the screen. For more details, check the documentation that came with your DVD (or contact your program provider).

Audio

Problem	Possible Remedies
Good picture, no sound	<ul style="list-style-type: none">❑ Press MUTING so that the word Muting disappears from the screen (see page 35).❑ Make sure the Speaker option is set to On in the Audio Menu (see page 49).
Cannot gain enough volume when using a cable box	<ul style="list-style-type: none">❑ Increase the volume of the cable box using the cable box's remote control. Then press TV FUNCTION and adjust the TV's volume.
Sound seems weak or insufficient	<ul style="list-style-type: none">❑ The TV's audio might be set to Auto SAP or Mono, when it might be better set to Stereo. In the Audio Menu (see page 48), set the MTS setting to Stereo. If already set to Stereo, switch to Mono (which may reduce background noise during weak stereo broadcasts).
Cannot raise the volume on external audio speakers	<ul style="list-style-type: none">❑ If the Speaker option is set to Off and the Audio Out option is set to Fixed (in order to output the sound to your audio system) use your audio receiver to adjust the sound (see page 48). Or, to use the TV remote control, set the Audio Out option to Variable.❑ To turn on the TV speakers, set the Speaker option to On (see page 48).

General

Problem	Possible Remedies
How to reset TV to factory settings	<ul style="list-style-type: none">❑ Turn on the TV. While holding down the RESET button on the remote control, press the POWER button on the TV. (The TV will turn itself off, then back on again.) Release the RESET button.
How to restore Video settings to factory settings	<ul style="list-style-type: none">❑ Press the RESET button on the remote control while in the Video Menu (see page 46).
How to restore Audio settings to factory settings	<ul style="list-style-type: none">❑ Press the RESET button on the remote control while in the Audio Menu (see page 48).
Cannot cycle through the other video equipment connected to the TV	<ul style="list-style-type: none">❑ Be sure the Video Label option is not set to Skip (see page 59).
Cannot operate Menu	<ul style="list-style-type: none">❑ If a menu option appears in gray, this indicates that the TV is in a state in which the menu option is not available.
Lost password	<ul style="list-style-type: none">❑ In the password screen (see page 54), enter the following master password: 4357. The master password clears your previous password; it cannot be used to temporarily unblock channels.
TV makes "popping" sound when turned on	<ul style="list-style-type: none">❑ This is a normal sound that results from the TV automatically degaussing each time it is turned on.
LED on front panel is lit	<ul style="list-style-type: none">❑ This LED (see page 10) blinks when the TV is turned on, then shuts off when the picture is displayed. If the LED blinks continuously, this may indicate the TV needs service. When the timer is set, this LED will remain lit even when the TV is turned off.
Digital cable box does not work	<ul style="list-style-type: none">❑ If you are connecting a VCR and digital cable box using a splitter, as described on pages 18-19, you must use a special bi-directional splitter that is designed to work with your digital cable box. Contact your cable provider for details.

Specifications

Picture Tube	FD Trinitron® tube	
Antenna	75 ohm external terminal for VHF/UHF	
Television System	NTSC, American TV Standard	
Channel Coverage	VHF	2-13
	UHF	14-69
	CATV	1-125
Power Requirements	120V, 60 Hz	
Inputs/Outputs		
HDMI IN	Video	1080i, 720p, 480p, 480i
	Audio	Two channel linear PCM 32, 44.1 and 48 kHz, 16, 20 and 24 bit
Video (IN)	4 total (1 on front panel)	1 V _{p-p} , 75 ohms unbalanced, sync negative
S Video (IN)	3 total (1 on front panel)	Y: 1 V _{p-p} , 75 ohms unbalanced, sync negative C: 0.286 V _{p-p} (Burst signal), 75 ohms
Audio (IN)	7 total (1 on front panel)	500 mVrms (100% modulation) Impedance: 47 kilohm
Component Video Input	2 (Y, P _B , P _R)	Y: 1.0 V _{p-p} , 75 ohms unbalanced, sync negative; P _B : 0.7 V _{p-p} , 75 ohms P _R : 0.7 V _{p-p} , 75 ohms
CONTROLS (IN/OUT)	1	
Variable/Fixed Audio (OUT)	1	More than 408 mVrms at the maximum volume setting (Variable) More than 408 mVrms (Fixed) Impedance (output): 2 kilohms
Supplied Accessories	Remote Control	RM-Y197
	AA (R6) Batteries	2 supplied for remote control
Visible Screen Size (Picture Measured Diagonally)	KV-27HS420	27 in (685.8 mm)
	KV-30HS420	30 in (762 mm)
	KV-32HS420	32 in (812.8 mm)
	KV-34HS420	34 in (863.6 mm)
	KV-36HS420	36 in (914.4 mm)
Actual CRT Size (Picture Measured Diagonally)	KV-27HS420	29 in (736.6 mm)
	KV-30HS420	32 in (812.8 mm)
	KV-32HS420	34 in (863.6 mm)
	KV-34HS420	36 in (914.4 mm)
	KV-36HS420	38 in (965.2 mm)
Speaker Output	10W x 2	

Dimensions (W x H x D)	KV-27HS420	784 x 601.5 x 520 mm (30 7/8 x 23 5/8 x 20 1/2 in)
	KV-30HS420	898 x 604 x 564.5 mm (35 3/8 x 23 3/4 x 22 1/4 in)
	KV-32HS420	898 x 698 x 598 mm (35 3/8 x 27 1/2 x 23 1/2 in)
	KV-34HS420	994 x 654 x 604 mm (39 1/8 x 25 3/4 x 23 3/4 in)
	KV-36HS420	994 x 776.5 x 634 mm (39 1/8 x 30 5/8 x 25 in)
Mass	KV-27HS420	50.2 Kg (111 lbs)
	KV-30HS420	68 Kg (150 lbs)
	KV-32HS420	74.8 Kg (165 lbs)
	KV-34HS420	88 Kg (194 lbs)
	KV-36HS420	104.3 Kg (230.0 lbs)
Power Consumption	In Use	240 W
	In Standby	1 W

Design and specifications are subject to change without notice.

Optional Accessories

<i>Accessory</i>	<i>Description</i>	<i>Model Number</i>
Cables	Audio/Video	VMC-810/820/830 HG
	Audio	RKC-515HG
	Component Video	VMC-10/30 HG
TV Stands	For KV-27HS420	SU-27HX1
	For KV-30HS420	SU-30HX1
	For KV-32HS420	SU-32HX1
	For KV-34HS420	SU-34HX1
	For KV-36HS420	SU-36HX1

Index

0-9 buttons 36, 39
16:9 (widescreen) 8, 59
16:9 aspect ratio 40, 50
4:3 aspect ratio 40, 50
4:3 Default settings 51

A

antenna, connecting 12
aspect ratio 59
Audio Menu 45
Audio Out 49
audio receiver, connecting 30
Auto Program (channel setup) 32, 52
Auto SAP, MTS setting 48

B

balance, adjusting 48
bass, adjusting 48
batteries, inserting in remote 33
BBE 48
bilingual audio 48
blocking programs. *See ratings.*
brightness, adjusting 46

C

cable
 connecting 12
 setting On/Off 52
 with VCR, connecting 16
cable box
 connecting with VCR 18
 using with TV remote control 44
Caption Vision 58
CATV. *See cable*
CH buttons 10, 36, 39
Channel Menu 45
Channel Skip/Add 52
channels
 creating labels 53
 setting up 32
CineMotion 8, 35, 47
ClearEdge VM 8, 47
clearing, Favorite Channels 42
closed caption modes 58
CODE SET button 35

color, adjusting 46
CONTROL S 31
CONTROL S IN/OUT jacks, described 11
Cool, Color Temperature 46
cursor movement buttons 10

D

degauss 65
Digital Reality Creation 7, 47
DISPLAY button 39
DRC MODE button 35
DRC. *See Digital Reality Creation.*
DVD player
 using with TV remote control 44
 with A/V connectors, connecting 26

E

Effect button 35
ENTER button 36, 39

F

Fast-forward button 35
Favorite Channels
 clearing 42
 in Channel Menu 52
 using 42
features 7
Fixed audio setting 49
Full mode, setting 50

G

GUIDE button 36

H

HD Detailer 8
HD/DVD IN (1080i/720p/480p/480i) jacks,
 described 11
High-Definition Multimedia Interface (HDMI) 8,
 27, 28, 62
hue, adjusting 46

I

Info Banner 58
interlaced 7, 35, 47, 62

J

JUMP button 35, 39

L

label

channels 53

Language, setting 59

M

MENU button 10, 36, 39, 45

Menus

Audio 45

Channel 45

Parent 45, 54

Setup 45, 58

Timer 45, 57

Video 45

Mono, MTS setting 48

Movie mode 46

MTS 48

MTS/SAP button 35

MUTING button 35, 39

N

Neutral, Color Temperature 46

Normal mode, setting 50

O

off, turning off the TV 10

on, turning on the TV 10

P

Parent Menu 45, 54

parental control, described 8

password, changing 54

Pause button 35

PIC MODE button 35

picture contrast, adjusting 46

Play button 35

POWER button 10

power cord, removing from holder 9

powering on/off, the TV 10

presetting channels 52

Pro (Video) mode 46

problems, troubleshooting 63–65

progressive 7, 35, 47, 62

R

ratings, setting 54–56

ratings, viewing blocked programs 55, 56

Record buttons 35

remote control

inserting batteries 33

programming 37–38

removing, Favorite Channels 42

RESET button 35

resetting

Audio options 49

Timer options 57

Video options 47

Rewind button 35

S

S VIDEO jack, described 10, 11, 15

SAT/CABLE FUNCTION button 35

SAT/CABLE POWER button 35

satellite receiver, using with TV remote control 43

Screen Mode 40, 41, 50, 60

SELECT button 10

setting up channels 32

Setup Menu 45, 58

sharpness, adjusting 46

Simulated, audio effect 48

SLEEP button 35

speakers

turning on/off 49

using external speakers 49

specifications 67

STAND BY indicator 10, 65

Standard mode 46

Steady Sound, described 8

Steady Sound, setting 48

Stereo, MTS setting 48

Stop button 35

surround sound 48

SYSTEM OFF button 35

T

Tilt Correction 32

tilt, correcting 32, 59

Timer 57, 60

TIMER indicator 10

Timer Menu 45, 57

timers, setting 57, 60

transport buttons 35

treble, adjusting 48

troubleshooting 63–65

TruSurround, audio effect 48

TruSurround, Effect 48

turning on/off the TV 10

TV FUNCTION button 35, 39

TV POWER button 35, 39

TV/VIDEO button 35, 39

V

Variable audio setting 49

VCR

 using with TV remote control 43

 with cable box, connecting 18

 with cable, connecting 16

 with satellite receiver, connecting 22

Vertical Center, adjusting 51

Vertical Correction 32

Vertical Size, adjusting 51

VHF/UHF jack, described 11

VIDEO (L/R)/AUDIO jacks, described 11

Video Menu 45

Video modes, selecting 46

Vivid mode 46

VOL buttons 10, 35, 39

W

Warm, Color Temperature 46

Wega, described 7

Wide Zoom mode, setting 50

widescreen 59

widescreen, described 8

WOW, audio effect 48

Z

Zoom mode, setting 50

