

# SONY®

# Network Audio Component/Server

Operating Instructions

Getting started

Network connections

Enjoying audio content

Enjoying Sony Multiple-  
Room Products

Additional information

Troubleshooting

Precautions/Specifications

## WARNING

### To reduce the risk of fire or electric shock, do not expose this apparatus to rain or moisture.

To reduce the risk of fire, do not cover the ventilation opening of the apparatus with newspapers, tablecloths, curtains, etc. Do not place the naked flame sources such as lighted candles on the apparatus.

To reduce the risk of fire or electric shock, do not expose this apparatus to dripping or splashing, and do not place objects filled with liquids, such as vases, on the apparatus.

As the main plug is used to disconnect the unit from the mains, connect the unit to an easily accessible AC outlet. Should you notice an abnormality in the unit, disconnect the main plug from the AC outlet immediately.

Do not install the appliance in a confined space, such as a bookcase or built-in cabinet.

Do not expose batteries or apparatus with battery-installed to excessive heat such as sunshine, fire or the like.

The unit is not disconnected from the mains as long as it is connected to the AC outlet, even if the unit itself has been turned off.

### For customers in the United States

#### Owner's Record

The model and serial numbers are located at the rear exterior of the unit. Record these numbers in the space provided below. Refer to them whenever you call upon your Sony dealer regarding this product.

Model No. \_\_\_\_\_

Serial No. \_\_\_\_\_

#### Important Safety Instructions

- 1) Read these instructions.
- 2) Keep these instructions.
- 3) Heed all warnings.
- 4) Follow all instructions.

- 5) Do not use this apparatus near water.
- 6) Clean only with dry cloth.
- 7) Do not block any ventilation openings. Install in accordance with the manufacturer's instructions.
- 8) Do not install near any heat sources such as radiators, heat registers, stoves, or other apparatus (including amplifiers) that produce heat.
- 9) Do not defeat the safety purpose of the polarized or grounding-type plug. A polarized plug has two blades with one wider than the other. A grounding type plug has two blades and a third grounding prong. The wide blade or the third prong are provided for your safety. If the provided plug does not fit into your outlet, consult an electrician for replacement of the obsolete outlet.
- 10) Protect the power cord from being walked on or pinched particularly at plugs, convenience receptacles, and the point where they exit from the apparatus.
- 11) Only use attachments/accessories specified by the manufacturer.
- 12) Use only with the cart, stand, tripod, bracket, or table specified by the manufacturer, or sold with the apparatus. When a cart is used, use caution when moving the cart/apparatus combination to avoid injury from tip-over.



- 13) Unplug this apparatus during lightning storms or when unused for long periods of time.
- 14) Refer all servicing to qualified service personnel. Servicing is required when the apparatus has been damaged in any way, such as power-supply cord or plug is damaged, liquid has been spilled or objects have fallen into the apparatus, the apparatus has been exposed to rain or moisture, does not operate normally, or has been dropped.

**The following FCC statement applies only to the version of this model manufactured for sale in the U.S.A. Other versions may not comply with FCC technical regulations.**

#### NOTE:

This equipment has been tested and found to comply with the limits for a Class B digital device, pursuant to Part 15 of the FCC Rules. These limits are designed to provide reasonable protection against harmful interference in a residential installation. This equipment generates, uses and can radiate radio frequency energy and, if not installed and used in accordance with the instructions, may cause harmful interference to radio communications. However, there is no guarantee that interference will not occur in a particular installation. If this equipment does cause harmful interference to radio or television reception, which can be determined by turning the equipment off and on, the user is encouraged to try to correct the interference by one or more of the following measures:

- Reorient or relocate the receiving antenna.
- Increase the separation between the equipment and receiver.
- Connect the equipment into an outlet on a circuit different from that to which the receiver is connected.
- Consult the dealer or an experienced radio/TV technician for help.

#### CAUTION

You are cautioned that any changes or modifications not expressly approved in this manual could void your authority to operate this equipment.

Properly shielded and grounded cables and connectors must be used for connection to host computers and / or peripherals in order to meet FCC emission limits.

This device complies with Part 15 of the FCC Rules. Operation is subject to the following two conditions:  
(1) this device may not cause harmful interference, and (2) this device must accept any interference

received, including interference that may cause undesired operation.

This equipment must not be co-located or operated in conjunction with any other antenna or transmitter.

This equipment complies with FCC radiation exposure limits set forth for an uncontrolled environment and meets the FCC radio frequency (RF) Exposure Guidelines in Supplement C to OET65. This equipment should be installed and operated keeping the radiator at least 20cm or more away from person's body (excluding extremities: hands, wrists, feet and ankles).

### **For customers in Canada**

Properly shielded and grounded cables and connectors must be used for connection to host computers and / or peripherals.

Operation is subject to the following two conditions:

(1) this device may not cause interference, and (2) this device must accept any interference, including interference that may cause undesired operation of this device.

This equipment complies with IC radiation exposure limits set forth for an uncontrolled environment and meets RSS-102 of the IC radio frequency (RF) Exposure rules. This equipment should be installed and operated keeping the radiator at least 20cm or more away from person's body (excluding extremities: hands, wrists, feet and ankles).

# Before operating this product

## About copyright protection

Music data cannot be used without the permission of the copyright holder except when used solely for personal enjoyment.

## About the illustrations used in this manual

Illustrations and screens used in this manual may vary from the actual screens.

## How to use this manual

This manual explains how to operate the unit mainly using the buttons on the remote control. Buttons on the main unit with the same or similar name as that on the remote control can be used to perform the same operations.

## About services that can be used in conjunction with an Internet connection

Please note that Internet-based services are subject to change or termination without notice.

Malfunctions that occur during the normal use of the unit will be repaired by Sony in accordance with the conditions defined in the limited warranty for this unit. However, Sony will not be liable for any consequences arising from a failure to play caused by a damaged or malfunctioning unit.

# Table of Contents

Before operating this product.....	4
Features of this unit .....	8
Enjoying various music.....	8
Using the unit with DLNA-compliant devices .....	8

---

## Getting started

Checking the supplied accessories.....	9
Guide to parts and controls .....	10
Remote control.....	10
Main unit .....	12
Display window .....	13
Preparing the unit and the remote control .....	14
Connecting an amplifier and the AC power adaptor.....	14
Inserting batteries into the remote control .....	15
Using an iPod/iPhone.....	15
Basic operations .....	16
Turning on this unit .....	16
Setting the network standby mode .....	17
Selecting items with the unit .....	17
Entering text .....	18
Setting up the Sony amplifier .....	19
Performing initial setup operations.....	20
Setting the clock .....	22
Setting the clock through an Internet connection.....	22

---

## Network connections

Connecting the unit to your home network (network settings) .....	24
Checking the wireless LAN environment of your home network .....	25
Searching for an access point and setting up a wireless network (access point scan method) .....	25
Setting up a wireless network using an access point compliant with WPS .....	27
Setting up a wired network .....	29
Setting up the IP address/proxy server.....	30
Confirming the network settings .....	31

---

## Enjoying audio content

Listening to an iPod or iPhone.....	32
Selecting the operation mode .....	33
Listening to audio content stored on a server .....	35
Setting up the server .....	35
Playing audio content stored on a server .....	38
Listening to music services .....	41
Presetting stations .....	42
Enjoying a variety of music services.....	42
Listening to audio content from an external component (Audio In) .....	44
Changing the play mode .....	45
Searching for an item using a keyword.....	46

---

## Enjoying Sony Multiple-Room Products

Using the PARTY STREAMING function .....	47
Starting a PARTY .....	47
Joining a PARTY .....	48
Connecting the unit with other DLNA-compliant devices .....	49
Playing audio content on the unit using a controller .....	50
Streaming audio content to a renderer (network controlled player) using a controller.....	50
Playing audio content streamed from a server (such as a computer) using a controller.....	51

---

## Additional information

Setting up the functions related to network operations .....	52
Setting up access permission .....	52
Using lists of permitted and non-permitted devices.....	52
Using the SMART SELECT function .....	53
Setting the PARTY STREAMING function .....	54
Naming the unit .....	54
Turning the operating sound on or off.....	55
Using the timer.....	56
Using the Sleep Timer .....	56
Using the Play Timer .....	57
Viewing the information of the unit.....	58
Managing the system.....	59
Updating the system application.....	59
Formatting the system .....	60

---

# Troubleshooting

Troubleshooting .....	61
Messages .....	65

---

# Precautions/Specifications

Precautions .....	68
Specifications .....	69
Compatible iPod/iPhone models.....	70
The menu tree for the settings menu.....	72
Glossary .....	73
Index .....	75

# Features of this unit

---

## Enjoying various music

You can enjoy listening to music from sound sources with large amounts of music content. You can listen to your iPod or iPhone (page 32), play audio content stored on a server (such as your computer) (page 35), and play audio content streamed by music services via the Internet (page 41).

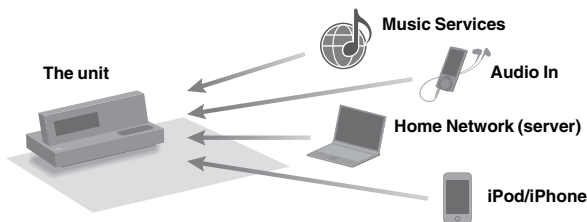

---

## Using the unit with DLNA-compliant devices

This unit complies with the DLNA standard. You can listen to music in various ways using the unit together with other DLNA-compliant devices. Connecting it to other DLNA devices allows you to enjoy audio content stored on a server, or stream audio content to other devices, even though they are all placed in different rooms (page 49).

Furthermore, the PARTY STREAMING function of the unit allows you to play back audio content with other devices that have a PARTY STREAMING function at the same time (page 47). You can use an iPod/iPhone placed on the unit, a server (a computer, etc.), music services, or an external device connected to the AUDIO IN jack of the unit as a sound source for the PARTY STREAMING function.

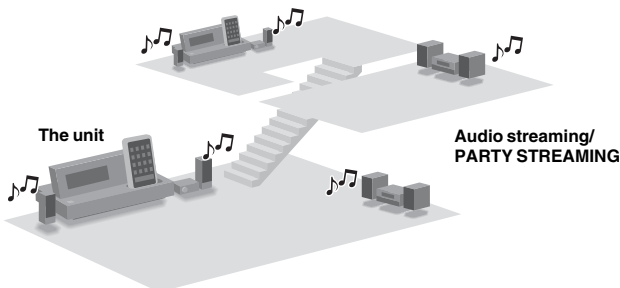

### About DLNA

DLNA is an abbreviation for Digital Living Network Alliance. It is the name of an organization that establishes guidelines (DLNA guidelines), and it is also the name of the method that allows devices in a house to share digital content (such as music data, image data, etc.) over a home network.



# Checking the supplied accessories

## ❑ Remote control (1)



## ❑ R6 (size AA) batteries (2)

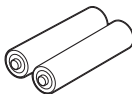

## ❑ AC power adaptor (1)

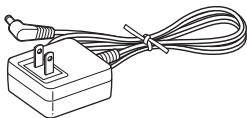

## ❑ Dock Adapters for iPhone models (1 set)

The adapter number is shown on the bottom of Dock Adapter.

For iPod models, use the Dock Adapter supplied with your iPod, or purchase a compatible dock adapter from Apple Inc.

⑫: For iPhone



⑮: For iPhone 3G and iPhone 3GS

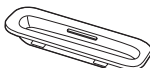

⑰: For iPhone 4



## ❑ Operating Instructions (this manual) (1)

This manual provides full explanations of the various settings, operations and the network connection procedure.

This manual also contains precautions for the safe use of the unit.

## ❑ Quick Setup Guide (1)

This manual explains how to set up the network connections and use the functions that can be used in conjunction with the network connections.

If you find any accessories missing or damaged, please contact your nearest Sony dealer.

# Guide to parts and controls

## Remote control

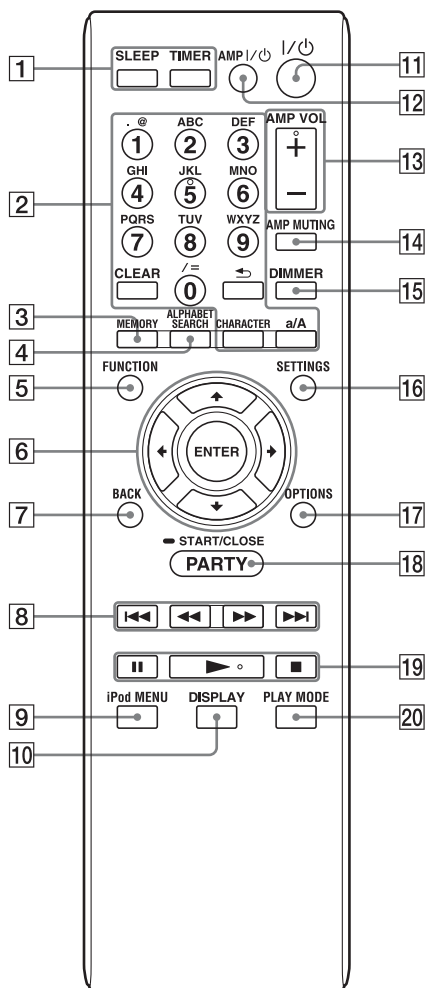

### 1 SLEEP and TIMER buttons

- SLEEP button (page 56)  
Use to set or confirm the sleep timer setting.
- TIMER button (page 57)  
Use to set the timer.

### 2 Numeric\*/text buttons

Use to select a track during playback or to enter text (pages 18, 26, 42, 54).

### 3 MEMORY button

Use to preset stations of the music services (page 42).

### 4 ALPHABET SEARCH button

Use to search for an item using a keyword (page 46).

### 5 FUNCTION button

Use to select a function (pages 17, 32).  
The unit has operating functions based on the sound source that the unit can play (iPod & iPhone function, Home Network function, etc.). Each press of this button changes the function in turn.

### 6 ↑/↓/←/→/ENTER buttons

Use to select an item (artist, album, track, menu item, etc.) and enter the selection (page 17, 18).

- ↑ and ↓ buttons (page 17)  
Use to select an item that is listed on the display. Use to move the focus up or down.
- ← and → buttons (pages 18, 46)  
Use to move the focus while entering text.  
Use to select the previous match or the next match while searching for an item using a keyword.
- ENTER button (page 17)  
Use to enter a selected item or setting.  
Press this button when an error message or a completion message is displayed, and the message will disappear.

### 7 BACK button

Use to go back to the previous display (pages 17, 26, 33).

**8** **◀◀/▶▶, ◀▶/▶▶ buttons**

- **◀◀** and **▶▶** buttons (page 33)  
Use to find the beginning of the current, the previous, or the next track.  
Press and hold the button to find a point in a track when the iPod & iPhone function is selected.
- **◀▶/▶▶** buttons (page 33)  
Use to find a point in a track.

**9** **iPod MENU button**

Use to display iPod/iPhone content lists, or use to go back to the previous iPod/iPhone content list (page 33).

**10** **DISPLAY button**

Use to display various information such as the time information of a track, an artist name, an album name, clock, etc. (page 33)

**11** **I/⏻ (power) button**

Use to turn the power on or off (page 16).

**12** **AMP I/⏻ button\*<sup>2</sup>**

Use to turn the power of a connected amplifier on or off (page 16).

**13** **AMP VOL +/- buttons\*<sup>1+2</sup>**

Use to adjust the output of a connected amplifier when it is turned on (pages 16, 44).

**14** **AMP MUTING button\*<sup>2</sup>**

Use to turn the sound of a connected amplifier off.

**15** **DIMMER button**

Use to change the brightness of the display. Each press of this button changes the brightness of the display to bright or dark.

**16** **SETTINGS button**

Use to display the settings menu (pages 17, 25, 52). Use to enter clock, network, and other system settings.

**17** **OPTIONS button**

Use to display the options menu (pages 17, 26, 34, 53).  
Menu items will vary according to the selected function.

**18** **PARTY button**

Use to operate the PARTY STREAMING function (page 47).  
Press and hold the button for a few seconds to start or close a PARTY.

**19** **Operation buttons**

- **⏸** (pause) button
- **■** (stop) button
- **▶** (play) button\*<sup>1</sup>

**20** **PLAY MODE button**

Use to select a play mode (page 45).

\*<sup>1</sup> An asterisk (\*) indicates buttons that have a tactile dot (number "5" button, AMP VOL + button and ▶ (play) button).

\*<sup>2</sup> These buttons operate only Sony amplifiers (page 19).

# Main unit

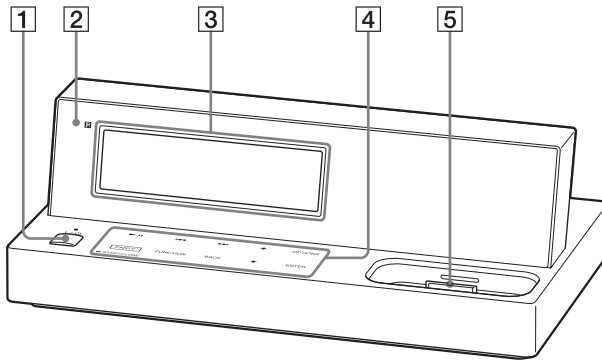

## 1 I/⏻ (power) button and the on/standby indicator

- I/⏻ (power) button (page 16)  
Use to turn the power on or off.
- On/standby indicator (page 16)  
The color indicates the power status of the unit.
  - Green: The unit is turned on.
  - Red: The “Network Standby” mode of the unit is set to “Off.”
  - Amber: The “Network Standby” mode of the unit is set to “On.”

## 2 Remote sensor

## 3 Display window

For details on the contents of the display, see “Display window” (page 13).

## 4 Touch panel operation buttons

- ▶|| (play or pause) button
- ◀◀/▶▶ buttons (page 33)  
Use to find the beginning of the current, the previous, or the next track.  
Press and hold the button to find a point in a track.
- ▲/▼ buttons (page 17)  
Use to select an item that is listed on the display. Use to move the focus up or down.
- OPTIONS button (pages 17, 26, 34, 53)  
Use to display the options menu.  
Menu items will vary according to the selected function.
- PARTY button  
Use to operate the PARTY STREAMING function (page 47).

Press and hold the button for a few seconds to start or close a PARTY.

- FUNCTION button (pages 17, 32)  
Use to select a function.
- BACK button (pages 17, 26, 33)  
Use to go back to the previous display.
- ENTER button (page 17)  
Use to enter a selected item or setting.

## 5 iPod/iPhone dock

Place an iPod or iPhone into the iPod/iPhone dock to listen to audio content stored on the iPod/iPhone (page 15).

## Display window

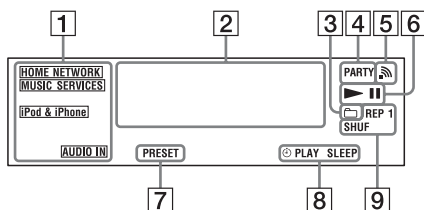

### 1 Function indicators

Light up when a function is selected (pages 17, 32).

### 2 Text information

Displays various information such as track names, album names, artist names, clock, progress bar, etc.

The following symbols appear on the display.

The meaning of each symbol is as follows.

Symbol	Description
▲ / ▼	The message is continued to/ from the next/previous page. Press ▲/▼ to see the entire text.
>	There are selectable items after this item (for example, the menu has a deeper level).

### 3 Folder indicator

Lights up when the playback range is set to “Current Folder” (factory setting) or “Parent Folder” while the unit is using the Home Network function (page 39).

### 4 PARTY indicator

Lights up when the PARTY STREAMING function is active (page 47).

### 5 Wireless LAN signal strength indicator

This antenna icon indicates the strength of the wireless LAN signal. More segments indicate a stronger signal.

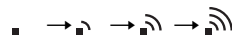

### 6 ►|| (play/pause) indicator

### 7 PRESET indicator

Lights up when a preset station of music services is selected.

### 8 Timer indicators

Light up when the Sleep Timer or Play Timer is set (page 56).

### 9 Play mode indicators

Light up when the play mode is set (page 45).

# Preparing the unit and the remote control

## Connecting an amplifier and the AC power adaptor

You can listen to the playback sound of the unit from an external component, such as an amplifier, stereo system, etc., connected to the AUDIO OUT jacks on the unit.

Use an audio connecting cord with two phono plugs (optional) to connect the AUDIO OUT jacks on the unit and the audio input jacks of the external component.

### Note

If you place the unit in an unstable location, it may move when you connect or disconnect cables. Hold the unit firmly when you connect or disconnect cables.

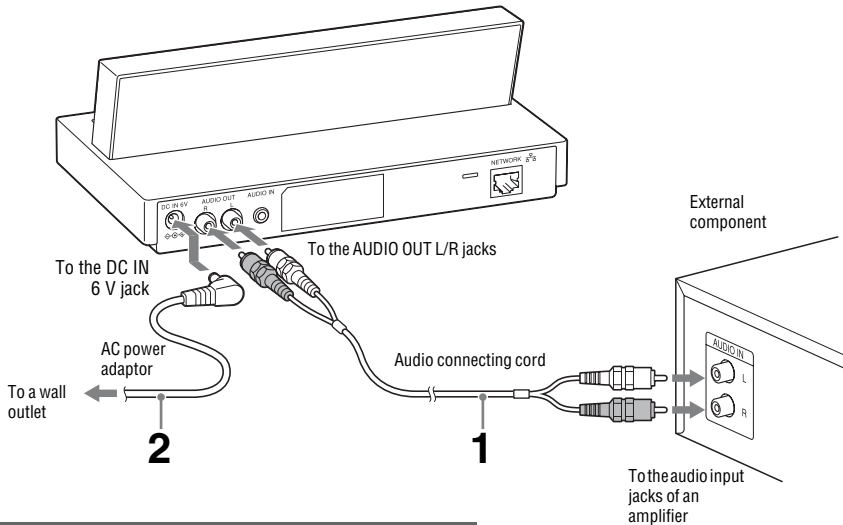

### WARNING

DO NOT plug the AC power adaptor into a wall outlet until all other connections have been made.

## 1 Connect the unit to an amplifier.

Use an audio connecting cord to connect the unit to an amplifier. Make sure to match the color-coded pins to the appropriate jacks: the white plug to the white (L) jack and the red plug to the red (R) jack.

Make sure to turn off the power of the amplifier before making a connection and connect all plugs securely to prevent noise.

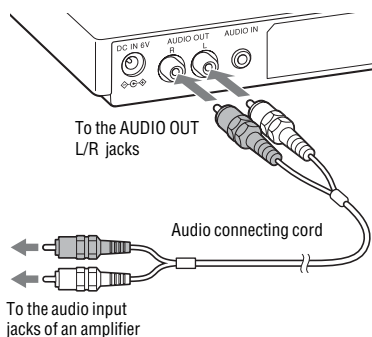

## 2 Connect one end of the AC power adaptor to the DC IN 6 V jack of the unit and the other end to a wall outlet.

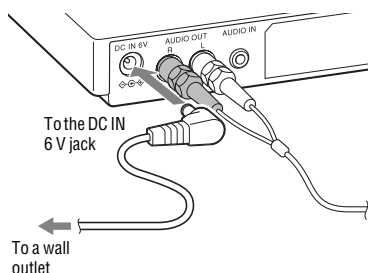

### WARNING

DO NOT plug the AC power adaptor into a wall outlet until all other connections have been made.

## Inserting batteries into the remote control

Remove the battery compartment lid, and then insert the supplied R6 (size AA) batteries (⊖ end first) matching the polarities as shown below. When the remote control is no longer able to operate the unit, replace both batteries with new ones.

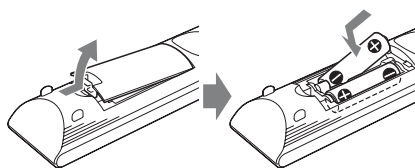

## Using an iPod/iPhone

Insert a Dock Adapter into the iPod/iPhone dock. When using an iPod model, use the dock adapter supplied with your iPod.

When using an iPhone model, use one of the Dock Adapters for iPhone models supplied with this unit.

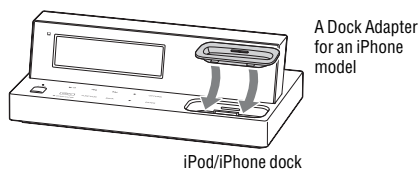

To remove the Dock Adapter for an iPhone model, pull it up with your fingernail or a flat object using the slot inside the adapter.

# Basic operations

This section explains the basic operations of the unit.

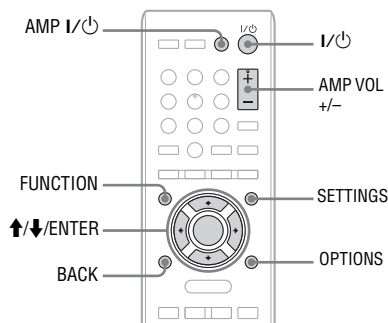

---

## Turning on this unit

---

- 1** Connect the AC power adaptor to a wall outlet.

When you connect the AC power adaptor to a wall outlet, the unit turns on once and the on/standby indicator lights up in green. After a while, the unit turns off automatically and the on/standby indicator changes to red.
- 2** Press I/⏻ (power).

The unit turns on and the on/standby indicator lights up in green.  
When the unit is turned on for the first time after purchase, you are required to make the initial settings. If this is the case, see “Performing initial setup operations” (page 20).

## To turn off the unit

Press I/⏻ on either the remote control or the main unit. When the unit is turned off and enters the standby mode, the color of the on/standby indicator changes.

The unit has two standby modes, network standby - off and network standby - on. For details, see “Setting the network standby mode” (page 17).

- **Network standby - off mode (factory setting)**

This standby mode consumes less power than network standby - on mode, though the unit takes more time to resume operations when powered on again. The on/standby indicator lights up in red in this mode.

- **Network standby - on mode**

In this standby mode, the unit is always connected to the network and remains partially active to quickly resume operations when controlled over the network, or powered on again. In this mode, the on/standby indicator lights up in amber and the clock appears on the display. To set the network standby mode, see “Setting the network standby mode” (page 17).

## To turn the Sony amplifier on or off

You can use the remote control to control the Sony amplifier (power on/off and volume). For details on the remote control settings required to operate the Sony amplifier, see “Setting up the Sony amplifier” (page 19).

- 1** Press AMP I/⏻ on the remote control to turn on the amplifier.
- 2** Press AMP VOL – on the remote control to turn the volume down to its lowest level.

When you start playing the sound source on the unit, press AMP VOL + to adjust the volume from the amplifier.
- 3** Set the source selector on the amplifier to the setting for this unit.



## Setting the network standby mode

While the “Network Standby” mode is set to “On,” the unit can always be connected and controlled over the network.

- 1 Press **SETTINGS** to enter the settings menu.
- 2 Press **↑/↓** to select “Network Standby” and press **ENTER**.
- 3 Press **↑/↓** to select “Off” or “On” and press **ENTER**.

Display	Description
◆ Off	The unit consumes less power than the network standby - on mode, though the unit takes more time to resume operations when powered on again. The on/standby indicator lights up in red.
On	The unit is connected to the network even though the power of the unit is turned off, and resumes operations when controlled over the network. The on/standby indicator lights up in amber.

(◆: Factory setting)

## Selecting items with the unit

You can use the **↑/↓/ENTER** buttons to select an item (menu item, artist, track, etc.) and enter the selection.

- 1 When a list of items (artists, tracks, menu items, etc.) is displayed, press **↑/↓** to select the desired item.  
The currently selected item is focused. Press and hold **↑/↓** to scroll the display. Press **BACK** to go back to the previous display.
- 2 Press **ENTER**.  
The selected item is set or the selected process is carried out.

### To select a function

The unit has operating functions based on the sound source that the unit can play (iPod & iPhone function, Home Network function, etc.). Press **FUNCTION** repeatedly to select the desired function.

### About menus for this unit

This unit has two menus, the settings menu and the options menu, and they allow you to make various settings.

- **Settings menu (page 72)**  
Press **SETTINGS** to display the settings menu. You can make various settings such as network settings, network standby settings, music services settings, etc.
- **Options menu**  
Press **OPTIONS** to display the options menu. Menu items will vary according to the selected function.

## Entering text

Entering text may be required during some setup operations such as network settings. You can enter text using the remote control.

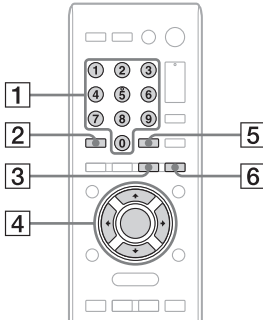

### 1 Numeric/text buttons

Press the button with the desired letter (ABC, DEF, etc.). Press repeatedly until the desired letter appears.

### 2 CLEAR button

Press this button to erase a letter that was just entered.

### 3 CHARACTER button

This button selects the type of characters and numbers. Each time you press the button, the type of characters and numbers changes between alphanumeric characters and numbers (“abc” or “ABC”) and numbers only (“123”). If you want to enter punctuation marks (e.g., !, ?, etc.) and other symbols (e.g., #, %, etc.), select “abc” or “ABC.”

### 4 ↑/↓/←/→/ENTER buttons

- ↑/↓/←/→ buttons  
Use these buttons to move the cursor.
- ENTER button  
Use this button to enter a text string.

### 5 ↶ button

Press this button so that the order of the characters which are assigned to a button appear in reverse. For example, pressing the no. 2 button repeatedly normally displays “A,” “B,” “C,” and “2,” however, pressing this button changes the order to “2,” “C,” “B,” and “A.”

### 6 a/A button

Press this button to switch between lowercase (“abc”) and uppercase (“ABC”) letters.

## Example of a character input display

The display shown below is an example of the character input display that appears when you are searching for an item using a keyword.

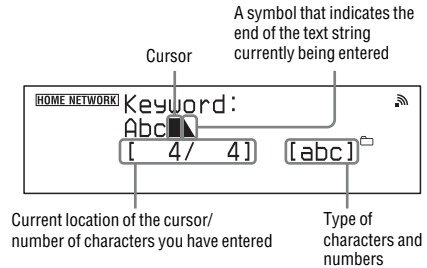

## How to enter text

**1** Press CHARACTER (switch between letters and numbers) and a/A (switch between lowercase and uppercase letters) to select the desired type of characters and numbers.

**2** Press the corresponding numeric/text button to enter the desired character, then press → to move the cursor to the next input position. Repeat this step to enter the text string.

**3** Press ENTER to confirm and save the text string.

## Other operations

To	Do the following
Restore the previous condition	Press BACK.
Move the cursor	Press ←/→ to move the cursor left or right. Press ↑/↓ so that the cursor moves to the beginning or to the end of the text string.

## To select the type of characters and numbers

Press CHARACTER to select alphanumeric characters and numbers (“abc” or “ABC”) or numbers only (“123”).

## To select the uppercase or lowercase letters

Press a/A to switch between lowercase (“abc”) and uppercase (“ABC”) letters.

## To enter punctuation marks (e.g., !, ?, etc.) or symbols (e.g., #, %, etc.)

Press 1 or 0 of the numeric/text button repeatedly while the type of characters is set to “abc” or “ABC.”

## To enter a space

Press 0 of the numeric/text button repeatedly while the type of characters is set to “abc” or “ABC.”

## To delete a character

Press CLEAR.

## Characters that are assigned to each numeric/text button

The table below shows the characters and numbers that you can enter for each type (“abc,” “ABC,” or “123”). You can check the characters, numbers and symbols that are assigned to each numeric text button.

Numeric/ text button	abc	ABC	123
1	., ! @ ^ ` ; ; ( ) [ ] { } < > 1	., ! @ ^ ` ; ; ( ) [ ] { } < > 1	1
2	a b c 2	A B C 2	2
3	d e f 3	D E F 3	3
4	g h i 4	G H I 4	4
5	j k l 5	J K L 5	5
6	m n o 6	M N O 6	6
7	p q r s 7	P Q R S 7	7
8	t u v 8	T U V 8	8
9	w x y z 9	W X Y Z 9	9
0	/ \   - ~ = _ + # \$ % & ^ “ * ? _ (space) 0	/ \   - ~ = _ + # \$ % & ^ “ * ? _ (space) 0	0

## Setting up the Sony amplifier

You can use the remote control to control the Sony amplifier (power on/off and volume).

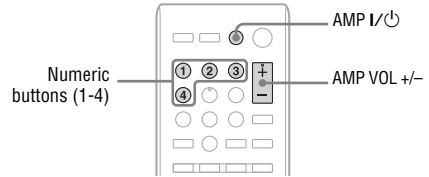

Press the corresponding numeric button (1 to 4) while pressing AMP I/⏻ to select the Sony amplifier.

Press	Type of amplifier
AMP I/⏻ and 1	Sony stereo amplifier or receiver
AMP I/⏻ and 2	Sony Mini/Micro system
AMP I/⏻ and 3	Sony AV receiver, multi channel amplifier, or home theater system
◆ AMP I/⏻ and 4	Sony home theater system

(◆: Factory setting)

### Note

It is possible to change the remote control code to make the remote control compatible with a multi channel amplifier or home theater system. If you do not know what your Sony amplifier type is, try selecting each of the four codes above to find out which one corresponds with your amplifier. This remote control may not be compatible with some Sony products.

# Performing initial setup operations

When the unit is turned on for the first time after you purchase it, initial setup operations are required. The initial setup includes the initial setting procedure for the unit (this will be performed automatically), network settings, the clock settings, and obtaining a service list (for the Music Services function).

When you are indicated to set the network or the clock, refer to the respective pages.

Entering characters will be required during the setup operations. For details on entering characters, see “Entering text” (page 18).

## WARNING

Do not disconnect the AC power adaptor while the unit is making the initial setup operations. Doing so may cause the unit to malfunction.

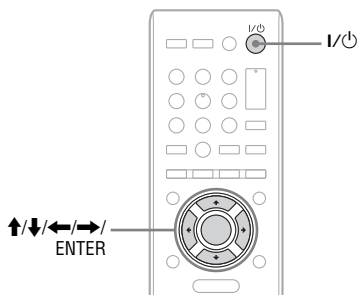

---

**1** Press I/O (power) to turn on the unit.

---

**2** When “Set the items required to use this unit. Press ENTER to continue.” appears, press ENTER.

---

**3** When the “Start setup?” display appears, select “OK.”

The unit starts making the initial settings.

---

**4** When the “Network Settings” display appears, select “Yes.”

The “Connection” display appears. Before you start setting up a network, check the chart on page 24 to decide which connection method you will use to connect the unit to your home network. Then, refer to the respective page (as follows) to perform the setup operation for the connection method chosen.

### When you use a wireless connection

- Access point scan method:  
Go to step 3 of “Searching for an access point and setting up a wireless network (access point scan method)” (page 26).
- Manual connection method:  
Go to step 3 of “If you cannot find the desired network name (SSID) (manual setup method)” (page 27).
- WPS push button configuration method:  
Go to step 3 of “Setting up a wireless network using the WPS push button configuration method” (page 27).
- WPS PIN code method:  
Go to step 3 of “Setting up a wireless network using the WPS PIN code method” (page 28).

### When you use a wired connection

Go to step 4 of “Setting up a wired network” (page 29).

Make sure that the network (LAN) cable has been connected to the NETWORK port on the rear of the unit. See step 1 of “Setting up a wired network” (page 29), as well.

When the network settings have been completed, the unit changes to the clock settings display.

## 5 When the “Date&Time” display appears, select “Auto” or “Manual.”

For details on the clock settings, refer to the respective page (as follows) to set the clock.

- When you select “Auto”:  
Go to step 5 of “Setting the clock through an Internet connection” (page 22).
- When you select “Manual”:  
Go to step 5 of “To set the clock manually” (page 23).

When the clock settings have been completed, the “Get Service List” display appears, allowing you to obtain a list of available music services.

### Note

If you do not set up a network connection, you cannot set the clock by selecting “Auto” in this step.

## 6 When the “Get Service List” display appears, select “OK.”

The unit obtains the service list for the Music Services function.

### Note

If you do not set up a network connection, you cannot obtain the list of available music services.

When the list is obtained, “Refreshed Service List.” appears, then the unit starts making the server and the renderer (network controlled player)\* settings automatically. Wait until the unit finishes making the settings.

\* For details on the server and the renderer (network controlled player), see page 49.

When the initial setup process has been completed, “Setup is complete.” appears on the display and the unit changes to the iPod & iPhone function automatically.

## To go back to the previous display

Press BACK when you need to go back to the previous display, such as when an error occurs during the setup operation.

## To cancel initial settings

Press FUNCTION. When “Cancel setup?” appears, select “Yes.”

If you select “Yes” to cancel the initial setup process before it is completed, “Setup later?” appears. Select “Yes” or “No.” If you select “Yes,” the initial setup process is required again the next time you turn the unit on.

# Setting the clock

The time on the clock must be set correctly for the proper operation of functions. The clock can be set either automatically by connecting the unit to the Internet, or manually using the remote control.

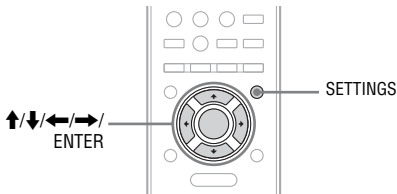

## Setting the clock through an Internet connection

You can set the clock by connecting the unit to the NTP (Network Time Protocol) server on the Internet. Before using this function, make sure the network settings have already been made properly.

- 1** Press **SETTINGS** to enter the settings menu and select “Date&Time Settings.”
- 2** When “Playback and network functions cannot be used during the setup. Press **ENTER** to continue.” appears, press **ENTER**. When “▼” is displayed, the message is continued to the next page. Press **↓** to see the entire text string.

---

### **3** Select “Date&Time Setting Method.”

The “Date&Time” display appears. If you are performing the initial setup operation and indicated that you want to set the clock (page 21), this display appears.

---

### **4** Select “Auto.”

---

### **5** Select the city where the unit is being used from the “Time Zone” display.

The “NTP Server” display appears. If the desired city does not appear in the “Time Zone,” select a city that is within the same time zone as the desired city.

---

### **6** Press **ENTER**.

The unit will connect to the default server in step 7.

If you want to use a different NTP server, erase “NtpServer” and enter the name or the IP address of the NTP server that you want to use, then press **ENTER**.

For details on entering text, see “Entering text” (page 18).

When you want to change the specified NTP server back to the default one, enter “NtpServer” in this step.

---

### **7** When “Set via Internet” appears, select “OK.”

When the clock settings have been completed, “Save settings.” and the clock appear on the display.

## A list of available time zones

The following items appear in step 5. Select the city where the unit is being used.

GMT+13 Nukualofa  
 GMT+12 Auckland  
 GMT+11 Noumea  
 GMT+10 Sydney, Port Moresby  
 GMT+9:30 Adelaide  
 GMT+9 Tokyo, Seoul  
 GMT+8 Beijing, Singapore  
 GMT+7 Bangkok, Jakarta  
 GMT+6:30 Yangon  
 GMT+6 Dhaka  
 GMT+5:45 Kathmandu  
 GMT+5:30 New Delhi  
 GMT+5 Karachi, Islamabad  
 GMT+4:30 Kabul  
 GMT+4 Abu Dhabi, Tbilisi  
 GMT+3:30 Teheran  
 GMT+3 Moscow, Riyadh  
 GMT+2 Athens, Helsinki  
 GMT+1 Paris, Berlin  
 GMT+0 London, Lisbon  
 GMT-1 Azores  
 GMT-2  
 GMT-3 Sao Paulo, Buenos Aires  
 GMT-3:30 St. John's  
 GMT-4 Halifax, Santiago  
 GMT-5 New York, Toronto  
 GMT-6 Chicago, Mexico City  
 GMT-7 Denver, Calgary  
 GMT-8 Los Angeles, Vancouver  
 GMT-9 Anchorage  
 GMT-10 Honolulu, Papeete  
 GMT-11 Pago Pago  
 GMT-12

## To set the clock manually

You can set the clock manually using the remote control.

The unit uses the month/day/year style for the date format and a 12-hour clock.

- 1** Press **SETTINGS** to enter the settings menu and select "Date&Time Settings."
- 2** When "Playback and network functions cannot be used during the setup. Press **ENTER** to continue." appears, press **ENTER**.  
When "▼" is displayed, the message is continued to the next page. Press **↓** to see the entire text string.

- 3** Select "Date&Time Setting Method."

The "Date&Time" display appears.

If you are performing the initial setup operation and indicated that you want to set the clock (page 21), this display appears.

- 4** Select "Manual."

- 5** Set the date.

Press **←/→** to select the item to be set, and press **↑/↓** to adjust the value. When you finish setting the date, press **ENTER**.

- 6** Set the time.

Repeat the same operation as that in step 5. When you finish setting the time, press **ENTER**.

When the clock settings have been completed, "Save settings." and the clock appear on the display.

### Tips

- You can set the time zone from the settings menu. Enter the settings menu and select "Date&Time Settings" - "Time Zone." Select the time zone from the list. The time zone setting can be changed only when the clock has been set automatically using the NTP server (page 22).
- You can set the daylight saving time setting. Enter the settings menu and select "Date&Time Settings" - "Daylight Saving." Select "Standard" or "Daylight Saving."

# Connecting the unit to your home network (network settings)

This section explains how to connect the unit to your home network. You can connect the unit to the network either through a wireless or a wired LAN. Check your connection method using the chart below. For details on which connection method your wireless LAN router/access point supports, refer to the operating manual of your wireless LAN router/access point.

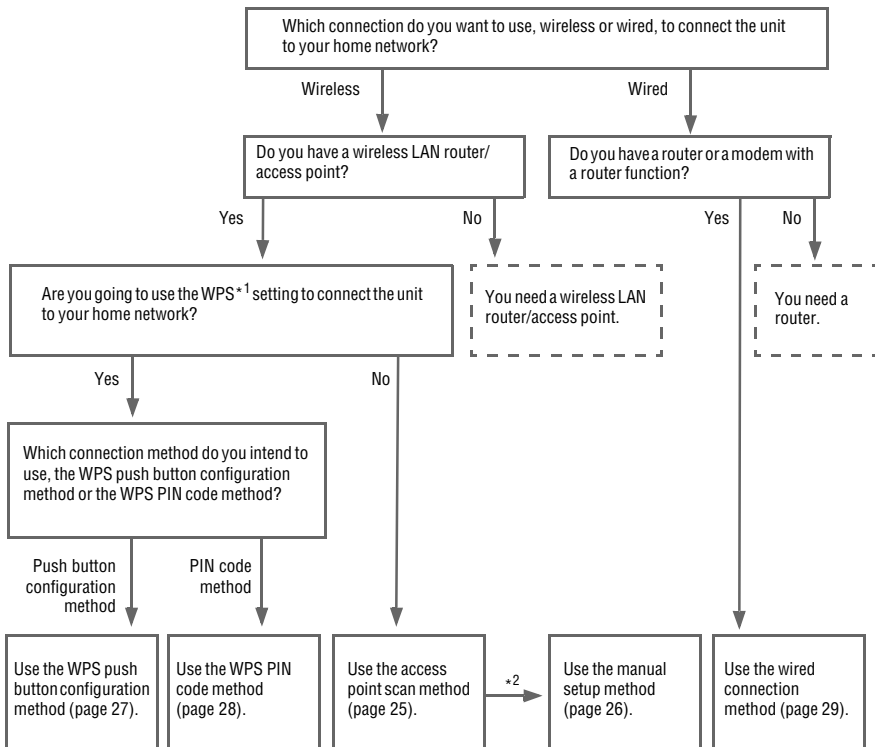

\*1 WPS (Wi-Fi Protected Setup) is a standard created by the Wi-Fi Alliance allowing you to setup a wireless network easily and securely.

\*2 You can use the manual setup method when you cannot find the desired access point using the access point scan method.

## What the unit can do when connected to a network

- The unit can play audio content stored on the server (a computer, etc.) on your home network (page 35).
- The unit can play music services via the Internet (page 41).



## Checking the wireless LAN environment of your home network

Read the following first

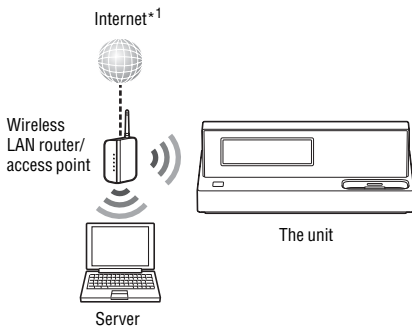

\*1 To listen to music services, you need an environment that allows you to access the Internet.

You must have the following environment to use the Home Network, Music Services, and PARTY STREAMING functions. Confirm your environment in advance.

- ❑ **A wireless LAN home network environment must be available. (Make sure that a wireless LAN router is used.)**
- ❑ **A device that can be used as a server (a computer, etc.) must be connected to your wireless LAN home network.\*2**
- ❑ **Internet access must be available. (When you want to listen to music services or use an NTP server to set the clock.)**

\*2 For details on servers which are compatible with this unit, see page 35.

There are several connection methods you can use to set up a wireless network: searching for an access point, using a WPS connecting method (either the push button configuration method or the PIN code method), or manual setting. Select the connection method that can be used for your home network using the chart on page 24.

### Notes

- Make sure not to use the wireless LAN function in a place where medical equipment (such as a pacemaker) is used or the use of wireless communication is prohibited.

- Before connecting to your home network, you need to prepare a wireless LAN router/access point. For details, refer to the operating manual of the device.
- Depending on your home network environment, the wireless LAN router/access point may have been set up such that it cannot be connected using WPS, even though it is compatible with WPS. For details on whether your wireless LAN router/access point is compatible or not compatible with WPS, and on the setup of a WPS connection, refer to the operating manual of your wireless LAN router/access point.
- You may encounter setup difficulties if the unit and the wireless LAN router/access point are located too far from each other. If you do, move the devices closer to each other.

## Searching for an access point and setting up a wireless network (access point scan method)

You can set up a wireless network by searching for the access point. Confirm you have the following information in advance, as you will need it to set up the network with this connection method.

- ❑ **The network name (SSID\*1) that identifies your network.\*2 (This will be needed in step 6.)**  
\_\_\_\_\_
- ❑ **If your wireless home network is secured by encryption, the security key (WEP key, WPA/WPA2 key) for your network.\*2 (This will be needed in step 7.)**  
\_\_\_\_\_

\*1 SSID (Service Set Identifier) is a name that identifies a particular access point.

\*2 This information should be available from a label on your wireless LAN router/access point, from the operating manual, from the person who set up your wireless network, or from the information provided by your Internet service provider.

- 1** Press **SETTINGS** to enter the settings menu and select “Network Settings.”

---

**2** When “Playback and network functions cannot be used during the setup. Press ENTER to continue.” appears, press ENTER.

When “▼” is displayed, the message is continued to the next page. Press ↓ to see the entire text string.

---

**3** Select “Connection Method.”

The “Connection” display appears. If you are performing the initial setup operation and indicated that you want to set the network connection (page 20), this display appears.

---

**4** Select “Wireless LAN.”

---

**5** Select “Access Point Scan.”

The unit automatically starts searching for access points and displays a list of network names (SSIDs) of available access points. The unit can display a maximum of 20 network names (SSIDs) on the list.

---

**6** Select the network name (SSID) from the list.

If the desired network name (SSID) does not appear on the display, or if a network name (SSID) cannot be detected, press BACK so that the unit returns to step 5, then perform step 5 again.

If the network name (SSID) still does not appear or still cannot be detected, you can input the network name (SSID) manually. See “If you cannot find the desired network name (SSID) (manual setup method)” (page 26).

---

**7** Enter the security key (WEP Key, WPA/WPA2 Key) of your network, and then press ENTER.

For details on how to input characters, see “Entering text” (page 18).

The security key appears as “\*\*\*\*\*”.

**Note**

If your network has not been secured by encryption (using the security key), the security key insertion display does not appear.

---

**8** When “Save settings and check connection. Press ENTER to continue.” appears, press ENTER.

It may take a while for the unit to complete the network settings.

When the network settings have been completed, “Complete.” appears and  lights up on the display.

If you are making the initial settings, the “Date&Time” display, step 5 of “Performing initial setup operations,” appears. Go back to page 21 and continue the initial setting process.

---

**9** Make the server settings.

To listen to audio content stored on the server through the network that have set up in this section, you need to set up your server (page 35).

**Tip**

You can view information on the access points when a list of network names (SSID) is displayed on step 5.

Place the focus on the access point (network name (SSID)) for which you want to view the information and press OPTIONS. Select “Information” from the options menu. You can check “SSID” (network name), “Signal Strength,” and “Security Method” (WPA2, etc.) for the selected access point.

**If you cannot find the desired network name (SSID) (manual setup method)**

If the desired network name (SSID) does not appear in the list of network names (SSIDs), you can enter the network name (SSID) manually.

**1** Press SETTINGS to enter the settings menu and select “Network Settings.”

- 2** When “Playback and network functions cannot be used during the setup. Press ENTER to continue.” appears, press ENTER.

When “▼” is displayed, the message is continued to the next page. Press ↓ to see the entire text string.

- 3** Select “Connection Method.”

The “Connection” display appears. If you are performing the initial setup operation and indicated that you want to set the network connection (page 20), this display appears.

- 4** Select “Wireless LAN.”

- 5** Select “Manual Registration” - “Direct Input.”

- 6** Enter the network name (SSID), and then press ENTER.

For details on how to input characters, see “Entering text” (page 18).

- 7** Select the security setting from the “Security Setting” display.

You can select from “WPA/WPA2-PSK (AES),” “WPA/WPA2-PSK (TKIP),” “WEP,” or “None.”

**Note**

If you select “None,” the unit skips step 8 and goes to step 9.

- 8** Enter the security key (WEP Key, WPA/WPA2 Key) of your network, and then press ENTER.

For details on how to input characters, see “Entering text” (page 18).

The security key appears as “\*\*\*\*\*”.

- 9** When “Save settings and check connection. Press ENTER to continue.” appears, press ENTER.

It may take a while for the unit to complete the network settings.

When the network settings have been completed, “Complete.” appears and  lights up on the display.

If you are making the initial settings, the “Date&Time” display, step 5 of “Performing initial setup operations,” appears. Go back to page 21 and continue the initial setting process.

- 10** Make the server settings.

To listen to audio content stored on the server through the network that have set up in this section, you need to set up your server (page 35).

## Setting up a wireless network using an access point compliant with WPS

You can easily set up a wireless network using an access point compliant with WPS. WPS setting can be made either by the push-button configuration method or the PIN (Personal Identification Number) code method.

### What is WPS (Wi-Fi Protected Setup)?

WPS is a standard created by the Wi-Fi Alliance allowing you to setup a wireless network easily and securely.

### Setting up a wireless network using the WPS push button configuration method

You can easily set up a WPS wireless connection with one push of the designated button.

- 1** Press SETTINGS to enter the settings menu and select “Network Settings.”
- 2** When “Playback and network functions cannot be used during the setup. Press ENTER to continue.” appears, press ENTER.

When “▼” is displayed, the message is continued to the next page. Press ↓ to see the entire text string.

- 3** Select “Connection Method.”

The “Connection” display appears. If you are performing the initial setup operation and indicated that you want to set the network connection (page 20), this display appears.

- 4** Select “Wireless LAN.”

- 5** Select “WPS Push.”

- 6** When the message that tells you to press the WPS button on the access point appears, press the WPS button on the access point for a few seconds, within two minutes.

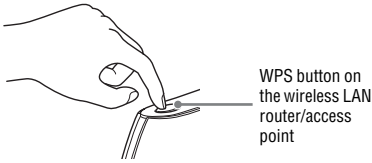

When the wireless LAN router/access point has been registered with the unit, “Access point registration is complete.” appears. It may take a while for the unit to complete the network settings.

- 7** When “Save settings and check connection. Press ENTER to continue.” appears, press ENTER.

It may take a while for the unit to complete the network settings.

When the network settings have been completed, “Complete.” appears and  lights up on the display.

If you are making the initial settings, the “Date&Time” display, step 5 of “Performing initial setup operations,” appears. Go back to page 21 and continue the initial setting process.

- 8** Make the server settings.

To listen to audio content stored on the server through the network that you have set up in this section, you need to set up your server (page 35).

## Setting up a wireless network using the WPS PIN code method

If the access point supports the WPS PIN (Personal Identification Number) code connection, you can set up a WPS wireless connection by entering the unit’s PIN code into the wireless LAN router/access point.

- 1** Press **SETTINGS** to enter the settings menu and select “Network Settings.”
- 2** When “Playback and network functions cannot be used during the

setup. Press **ENTER** to continue.” appears, press **ENTER**.

When “▼” is displayed, the message is continued to the next page. Press **↓** to see the entire text string.

- 3** Select “Connection Method.”

The “Connection” display appears. If you are performing the initial setup operation and indicated that you want to set the network connection (page 20), this display appears.

- 4** Select “Wireless LAN.”

- 5** Select “Manual Registration” - “WPS PIN.”

The unit’s PIN code (8 digits) is displayed. Leave the PIN code displayed on the unit until the connection is completed. (A different PIN code will be displayed each time you perform this operation.)

- 6** Input the unit’s PIN code into the wireless LAN router/access point.

For details on entering the PIN code, refer to the operating manual of the wireless LAN router/access point.

- 7** Press **ENTER**.

“Exchanging WPS info...” appears on the display.

When the wireless LAN router/access point has been registered with the unit, “Access point registration is complete.” appears. It may take a while for the unit to complete the network settings.

- 8** When “Save settings and check connection. Press ENTER to continue.” appears, press **ENTER**.

It may take a while for the unit to complete the network settings.

When the network settings have been completed, “Complete.” appears and  lights up on the display.

If you are making the initial settings, the “Date&Time” display, step 5 of “Performing initial setup operations,” appears. Go back to page 21 and continue the initial setting process.

- 9** Make the server settings.

To listen to audio content stored on the server through the network that you have set up in this section, you need to set up your server (page 35).

# Setting up a wired network

## Read the following first

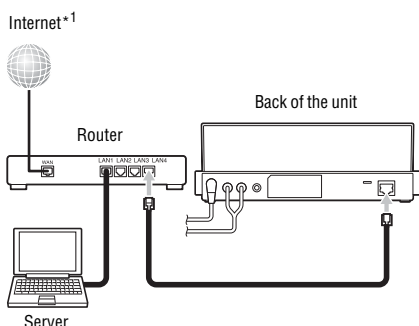

\*1 To listen to the music services, you need an environment that can access to the Internet.

You need the following environment to use the Home Network, Music Services, and PARTY STREAMING functions. Confirm your environment in advance.

- ❑ **A wired LAN home network environment must be available. (Make sure that a router is used.)**
- ❑ **A device that can be used as a server (a computer, etc.) must be connected to your wired LAN home network.\*2**
- ❑ **Internet access must be available. (When you want to listen to music services or use an NTP server to set the clock.)**

\*2 For details on servers which are compatible with this unit, see page 35.

Make sure to use a network (LAN) cable for a wired connection.

- 1** Connect the unit to a device that is connected to the server.

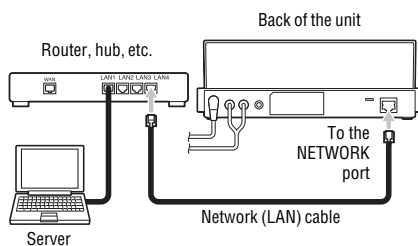

The connection configuration depends on the environment of your home network.

- When the server (a computer, etc.) is connected to a router or a hub:
  - If an unused port is available on the router or on the hub, connect the unit to that port.
  - If an unused port is not available on the router, add a hub and connect the server and the unit to the hub.
- When a router is not used\*:
  - Add a router and connect the server device and the unit to the router.

\* For example, when a server (a computer, etc.) is connected directly to a modem which does not have a router function.

- 2** Press **SETTINGS** to enter the settings menu and select “Network Settings.”

- 3** When “Playback and network functions cannot be used during the setup. Press **ENTER** to continue.” appears, press **ENTER**. When “▼” is displayed, the message is continued to the next page. Press **↓** to see the entire text string.

- 4** Select “Connection Method.”

The “Connection” display appears. If you are performing the initial setup operation and indicated that you want to set the network connection (page 20), this display appears.

---

## 5 Select “Wired LAN.”

The unit automatically starts setting up the network connection.

---

## 6 When “Save settings and check connection. Press ENTER to continue.” appears, press ENTER.

It may take a while for the unit to complete the network settings.

When the network settings have been completed, “Complete.” appears.

If you are making the initial settings, the “Date&Time” display, step 5 of “Performing initial setup operations,” appears. Go back to page 21 and continue the initial setting process.

---

## 7 Make the server settings.

To listen to audio content stored on the server through the network that you have set up in this section, you need to set up your server (page 35).

---

## Setting up the IP address/proxy server

You may have to use a fixed IP address and proxy server, depending on your home network settings, or the specifications of the Internet service provider.

For details on the input values in the following procedures, refer to the operating manual of the respective device or the information provided by your Internet service provider.

### To use a fixed IP address

The unit is set to obtain the IP address automatically as the factory setting, however, you can use a fixed IP address, depending on your network settings.

- 1** Press **SETTINGS** to enter the settings menu and select “Network Settings.”
- 2** When “Playback and network functions cannot be used during the setup. Press ENTER to continue.” appears, press **ENTER**.  
When “▼” is displayed, the message is continued to the next page. Press **↓** to see the entire text string.
- 3** Select “Tools” - “Advanced Settings.”
- 4** Select “IP Address Settings” - “Manual.”
- 5** Enter the values for “IP Address,” “Subnet Mask” and “Default Gateway.”  
When you press **ENTER** after you enter “Default Gateway,” the DNS server settings display appears.  
For details on how to input characters, see “Entering text” (page 18).
- 6** Enter the values for the “Primary DNS” setting.
- 7** When “Set Second. DNS?” appears, select “Yes.”  
If you do not have to set the secondary DNS server setting, select “No.”

**8** Enter the values for the “Secondary DNS” setting, and then press ENTER.

**9** When “Save settings and check connection. Press ENTER to continue.” appears, press ENTER.

When the network settings have been completed, “Complete.” appears.

**Tip**

If you want to obtain the IP address automatically using DHCP, select “Auto” for the “IP Address Settings” in step 4. If you select “Auto” in step 4, the “DNS Settings” selection display appears afterwards. In this case, select “Auto” or “Manual” for “DNS Settings” and enter the respective values following the instructions that appear on the display.

### To use a proxy server

If you need to use a proxy server (for example, when you are instructed to use a proxy server by your Internet service provider), be sure to prepare the proxy address and the port number in advance.

**1** Press SETTINGS to enter the settings menu and select “Network Settings.”

**2** When “Playback and network functions cannot be used during the setup. Press ENTER to continue.” appears, press ENTER.

When “▼” is displayed, the message is continued to the next page. Press ↓ to see the entire text string.

**3** Select “Tools” - “Advanced Settings.”

**4** Select “Proxy Settings” - “Use.”

**5** Enter the values for “Proxy Address” and “Proxy Port.”

When you enter the proxy address, press ENTER so that the “Proxy Port” display appears. Enter the proxy port number. For details on how to input characters, see “Entering text” (page 18).

**6** When “Save settings and check connection. Press ENTER to continue.” appears, press ENTER.

When the network settings have been completed, “Complete.” appears.

## Confirming the network settings

You can confirm the network status and settings.

**1** Press SETTINGS to enter the settings menu and select “Network Settings.”

**2** When “Playback and network functions cannot be used during the setup. Press ENTER to continue.” appears, press ENTER.

When “▼” is displayed, the message is continued to the next page. Press ↓ to see the entire text string.

**3** Select “Tools” - “Connection Diagnosis.”

Connection status appears as “Result:.”

**4** Select the item you want to check.

You can select from “Connection Method,” “SSID\*,” “Signal Strength\*,” “Security Method\*,” “IP Address” (“IP Address,” “Subnet Mask,” and “Default Gateway”), “DNS” (“Primary DNS” and “Secondary DNS”) and “Proxy Server” (“Address” and “Port”).

\* Appears only when a wireless network is being used.

When an error has occurred, “!” appears next to the error item.

# Listening to an iPod or iPhone

You can operate your iPod/iPhone with the remote control and listen to audio content stored on your iPod/iPhone. See “Compatible iPod/iPhone models” (page 70) for iPod/iPhone models that can be connected to this unit.

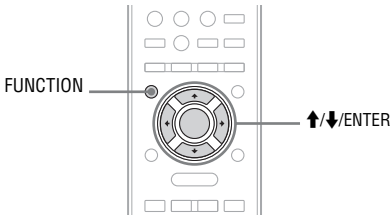

**1** Set the source selector on the amplifier to the setting for this unit.

**2** Place the iPod or iPhone on the iPod/iPhone dock.

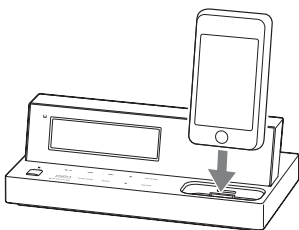

**3** Press FUNCTION repeatedly to select the iPod & iPhone function.

**4** Select a track by browsing through the various iPod/iPhone content lists on either the display of the unit or of the iPod/iPhone.

- When “Remote UI Mode” is set to “Off”: Operate the iPod/iPhone directly, browsing the items on the iPod/iPhone display.
- When “Remote UI Mode” is set to “On”: Operate the iPod/iPhone with the remote control of the unit or the main unit, browsing the items on the display of the unit.

For details on “Remote UI Mode,” see page 33.

**Example: Selecting a track from “Playlists” when “Remote UI Mode” is set to “On”**

① Press **↑/↓** to select [Playlists] from the iPod/iPhone content list, and then press **ENTER**.

If the iPod/iPhone content list is not displayed, press **BACK** repeatedly until the first level of the iPod/iPhone content list tree is displayed, then select the item.

② Press **↑/↓** to select the desired playlist, and then press **ENTER**. Tracks in the selected playlist appear.

③ Press **↑/↓** to select the desired track, and then press **ENTER**. The selected track starts playback.

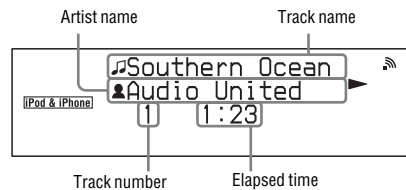



**Tip**

If “Network Standby” is set to “On,” the track that was playing when the unit was last turned off will start playing again when the unit is turned on again (only if the iPod/iPhone was not removed from the iPod/iPhone dock of the unit). The “Network Standby” mode is set to “Off” as the factory setting. To save the information on the last track played even when the unit is turned off, change the “Network Standby” mode to “On.” For details on the network standby mode setting, see page 17.

**Notes**

- The cover art and released year cannot be displayed on the unit.
- The unit does not save the information on the last track played if one of the following operations is carried out.
  - The AC power adaptor is disconnected from the wall outlet.
  - The iPod/iPhone is removed from the unit.
  - The unit is turned off and enters the network standby - off mode.
  - The play mode was set to a mode other than “Normal” when the unit was last turned off.
  - “Remote UI Mode” is changed.

**Other operations**

To	Do the following
Pause playback	Press <b>II</b> . Press <b>II</b> or <b>▶</b> to resume playback.
Scroll up/down the iPod/iPhone content lists	Press and hold <b>↑/↓</b> . When “Remote UI Mode” is set to “Off,” you can scroll up or down the iPod/iPhone content lists much like the Click Wheel operations or the drag up or down operations of the iPod/iPhone. When “Remote UI Mode” is set to “On,” the currently selected item number and the total number of items in a list appear on the display and you can scroll the iPod/iPhone content list rapidly.
Choose the selected item	Press <b>ENTER</b> . You can choose the selected item much like the center button or the touch operation of the iPod/iPhone.
Find the beginning of the previous/next track	Press <b>◀◀/▶▶</b> .
Find a point in a track	Press and hold <b>◀◀/▶▶</b> ( <b>◀◀/▶▶</b> on the main unit) while playing, and release it at the desired point.

To	Do the following
Return to the previous menu or reselect a menu while playing	Press <b>BACK</b> or <b>iPod MENU</b> . You can return to the previous menu or reselect a menu much like using the Menu button or the touch operation of the iPod/iPhone. To go back to the playback display, press <b>OPTIONS</b> and select “Now Playing” (only when “Remote UI Mode” is set to “On”).
View various information while the unit is playing a track (only when “Remote UI Mode” is set to “On”)	Press <b>DISPLAY</b> repeatedly. You can view the artist name, the album name, and the clock sequentially.

**Selecting the operation mode**

The unit has two operation modes for the iPod & iPhone function, remote UI mode - on and remote UI mode - off.

- **Remote UI mode - on:**

You can operate your iPod/iPhone with the buttons on the unit and the remote control. iPod/iPhone content lists are also displayed on the unit.

With the remote UI mode - on state, a play mode that has been set on the iPod/iPhone will be in effect when it is placed on the iPod/iPhone dock of the unit. A play mode set while the iPod/iPhone is placed on this unit will also be in effect when the iPod/iPhone is removed from the iPod/iPhone dock.

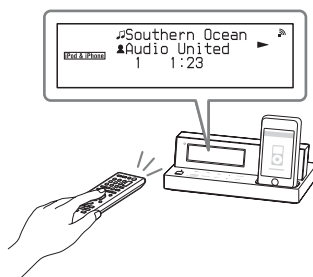

• **Remote UI mode - off (factory setting):**

You can use the buttons and controls on your iPod/iPhone to operate it. You can also use some buttons on the unit and the remote control, but the iPod/iPhone content lists are not displayed on the unit.

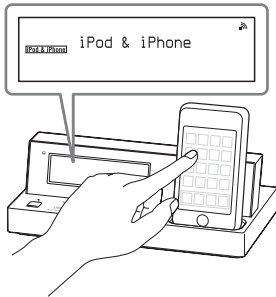

**Note**

You cannot use the buttons and controls on your iPod/iPhone in the remote UI mode - on mode.

To change the operation mode, do the following.

---

**1** While the iPod & iPhone function is selected, press **OPTIONS** to enter the options menu.

---

**2** Select "Remote UI Mode."

---

**3** Select "On" or "Off" (◆).  
(◆: Factory setting)

**To use the unit as a battery charger**

You can use the unit as a battery charger for an iPod/iPhone. The charging begins when the iPod/iPhone is placed on the iPod/iPhone dock. An iPod/iPhone can be charged when:

- the unit is turned on.
- the unit is turned off (in standby status) in the network standby - on mode.

**To stop charging the iPod/iPhone**

Remove the iPod/iPhone from the unit.

**Notes**

- An iPod/iPhone cannot be charged when the unit is turned off (in standby status) and in the network standby - off mode. For details on the charging status, refer to the operating manual of your iPod/iPhone. Charging is possible while the AC power adaptor of the unit is connected to a wall outlet.
- When placing or removing the iPod/iPhone, handle the iPod/iPhone at the same angle as that of the iPod/iPhone connector on the unit and do not twist or turn the iPod/iPhone to prevent connector damage.
- Do not carry the unit with an iPod/iPhone set on the iPod/iPhone dock. Doing so may cause a malfunction.
- When placing or removing the iPod/iPhone, brace the unit with one hand and take care not to press the controls of the iPod/iPhone by mistake.
- To change the volume level, adjust the volume on the amplifier (you can use the AMP VOL +/- button on the remote control to control the Sony amplifier). The volume level does not change when adjusted on the iPod/iPhone. For details on the remote control settings required to operate the Sony amplifier, see "Setting up the Sony amplifier" (page 19).
- The iPod/iPhone dock on the unit is designed for an iPod/iPhone only. You cannot connect any other portable audio players.
- To use an iPod/iPhone, refer to the operating manual of your iPod/iPhone.
- Sony cannot accept responsibility in the event that data recorded on the iPod/iPhone is lost or damaged when using an iPod/iPhone with this unit.
- If the album shuffle mode is set on the iPod/iPhone, "SHUF" lights up on the display when you connect the iPod/iPhone to the unit. If the album shuffle repeat mode is set on the iPod/iPhone, "SHUF" and "REP" light up on the display. (Note that this happens only when "Remote UI Mode" is set to "On.") For details on the play mode of the unit, see page 45.
- When the album shuffle mode or album shuffle repeat mode is set on the iPod/iPhone, the shuffle mode remains active but the unit does not shuffle tracks after you set the iPod/iPhone on the unit. If you want to shuffle tracks, set the play mode of the iPod/iPhone to shuffle or shuffle repeat mode.

# Listening to audio content stored on a server

This unit can play audio content that is stored on a server device (such as a computer) that supports the DLNA (Digital Living Network Alliance) standards.

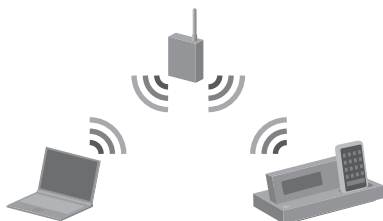

## To listen to audio content stored on a server

- **First of all, you need to connect the unit to your home network.**
  - See “Connecting the unit to your home network (network settings)” (page 24)
- **When you connect the unit to a home network, you need to set up the server.**
  - See “Setting up the server” (page 35)

### About DLNA

DLNA is an abbreviation for Digital Living Network Alliance. It is the name of an organization that establishes guidelines (DLNA guidelines), and it is also the name of the method that allows devices in a house to share digital content (such as music data, image data, etc.) over a home network.

## Setting up the server

To enjoy listening to audio content stored on your server with this unit, you must set up the server in advance.

The following server devices are compatible with this unit.

- Sony VAIO Media plus 2.0
- Sony NAS-S500HDE, NAS-S55HDE\* HDD Network Audio System
- Microsoft Windows Media Player 12 installed on Windows 7 (page 35)
- Microsoft Windows Media Player 11 installed on Windows Vista/XP (page 37)

\* These models may not be available in some countries/areas.

If the server has a function that limits access from other devices, you must change the setting on the server to allow the unit to access the server.

This section explains how to set up Windows Media Player when using it as a server.

For details on the settings of other server devices, refer to the operating manuals or help of the respective devices or applications.

### Note

The items displayed on the computer may be different from the ones shown in this section, depending on the version of the operating system or the computer environment. For details, refer to the help of your operating system.

## ■ When using a computer equipped with Windows 7

This section explains how to set up a manufacturer-installed version of Windows Media Player 12 for Windows 7 as a server to connect with this unit.

For details on how to operate Windows Media Player 12, refer to the help of Windows Media Player 12.

**1** Go to [Start] - [Control Panel].

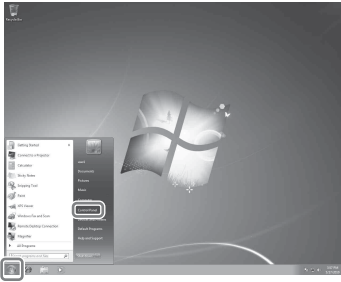

**2** Select [View network status and tasks] under [Network and Internet]. The [Network and Sharing Center] window appears.

**(Tip)**

If the desired item does not appear in the computer display, try to change the display type used by the Control Panel.

**3** Select [Public network] under [View your active networks]. If it shows other than [Public network], go to step 6.

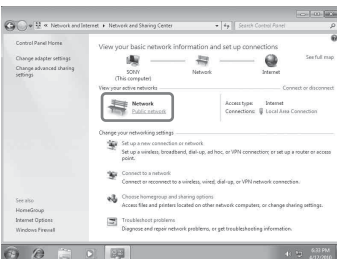

The [Set Network Location] window appears.

**4** Select [Home network] or [Work network] according to the environment in which the unit is being used.

**5** Follow the instructions that appear on the computer display according to the environment in which the unit is being used.

When the settings have been completed, confirm that the item under [View your active networks] has been changed to [Home network] or [Work network] in the [Network and Sharing Center] window.

**6** Select [Change advanced sharing settings].

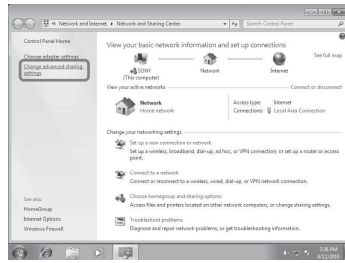

**7** Select [Choose media streaming options...] from [Media streaming].

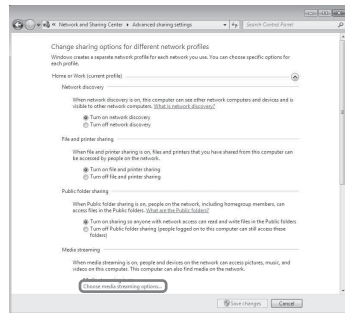

**8** If [Media streaming is not turned on] appears in the Media streaming options window, select [Turn on media streaming].

**9** Select [Allow All].

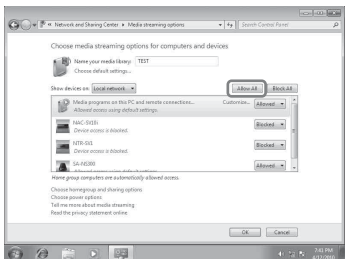

The [Allow All Media Devices] window opens. If all the devices in the local network are set to [Allowed], select [OK] and close the window.

**10** Select [Allow all computers and media devices].

- 11 Select [OK] to close the window.
- 12 Connect the unit to the server.  
After you finish setting up Windows Media Player 12, refresh the server list of the unit and select this server from the server list. For details on selecting a server, see “To refresh the server list” (page 40).

**■ When using a computer equipped with Windows Vista/Windows XP**

This section explains how to set up Windows Media Player 11 installed on Windows Vista/Windows XP\*, as a server to connect with this unit.

For details on how to operate Windows Media Player 11, refer to the help of Windows Media Player 11.

\* Windows Media Player 11 is not manufacturer-installed on Windows XP. Access the Microsoft web site, download the installer, and then install Windows Media Player 11 on your computer.

- 1 Go to [Start] - [All Programs].



- 2 Select [Windows Media Player]. Windows Media Player 11 starts up.
- 3 Select [Media Sharing...] from the [Library] menu.  
If you are using Windows XP, go to step 9.

- 4 When  is displayed, select [Networking...].



The [Network and Sharing Center] window appears.

- 5 Select [Customize].

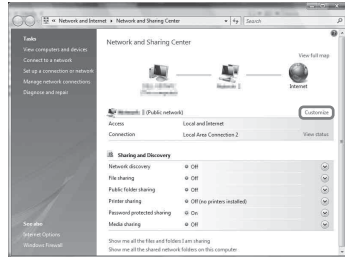

The [Set Network Location] window appears.

- 6 Add a check mark to [Private] and select [Next].

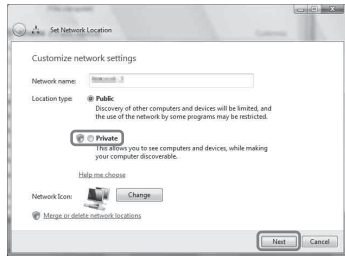

- 7 Confirm that the [Location type] has been changed to [Private] and select [Close].

- 8 Confirm that [(Private network)] is displayed in the [Network and Sharing Center] window and close the window.

- 9 If a check is not added next to [Share my media] in the [Media Sharing] window that is displayed in step 3, add a check mark to [Share my media], then select [OK].  
A list of connectable devices is displayed.

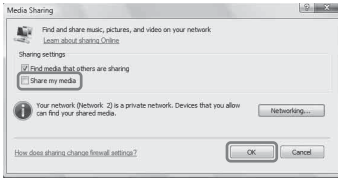

- 10 Select [Settings...] that appears beside [Share my media to:].
- 11 Add a check mark to [Allow new devices and computers automatically] and select [OK].

**Note**

Uncheck this item after you confirm that the unit can connect to the server and play audio data on the server in step 12.

- 12 Connect the unit to the server.  
After you finish setting up Windows Media Player 11, refresh the server list of the unit and select this server from the server list. For details on selecting a server, see “To refresh the server list” (page 40).

---

## Playing audio content stored on a server

The unit can play audio content stored on the server in the MP3, LinearPCM, WMA, AAC\* and HE-AAC formats. Audio content with copyright protection (Digital Rights Management) cannot be played by this unit.

\* The unit can play AAC files with the extension of “.m4a” only.

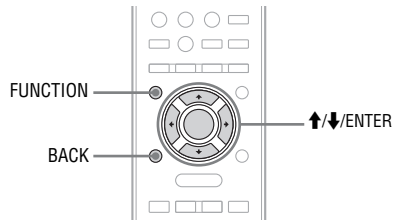

- 
- 1 Set the source selector on the amplifier to the setting for this unit.

- 
- 2 Press FUNCTION repeatedly to select the Home Network function.

- 
- 3 Select the server to be connected.  
When the server list appears, press ↑/↓ to select the server.  
If the server list does not appear, follow the procedure outlined in “To refresh the server list” (page 40) to find the server.

**Note**

Even if the power of the server device on the server list has been turned off, the unit turns the server on automatically if the server supports the Wake-on-LAN standard. If the server does not support the Wake-on-LAN standard, turn on the server in advance. For details on settings or operations of Wake-on-LAN of your server, refer to the operating manual or help of your server.

- 
- 4 Select the item you want to play.  
The items that are displayed (tracks, artists, albums, genres, folder name, etc.) depend on the connected server.
- Press ↑/↓ to select the item.

- Press and hold **↑/↓** so that the currently selected item number and the total number of items in a list appear on the display and you can scroll the list rapidly.
- Press **BACK** to go to the next higher directory.
- Press **ENTER** to go to the next lower directory.

## 5 Select the track you want to play and press **ENTER**.

The unit starts playing the selected track and the playback display appears.

Make sure that there is sound output from the connected amplifier.

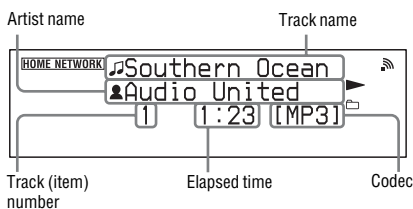

### Tips

- If you select a folder (such as an artist folder, genre folder, etc.) and press the **▶** button, the unit plays all items in the selected folder.
- The track on the server that was playing when the unit was last turned off will start playing again when the unit is turned on again (only if the AC power adaptor of the unit was not disconnected from the wall outlet).

### Notes

- Tracks that the unit cannot play appear on the display as well. You cannot sort a list of playable tracks. Tracks that cannot be played on the unit are skipped during playback.
- If you disconnect the AC power adaptor from the wall outlet, any information on the track on the server that was playing when the unit was last turned off will be erased.
- It may take a while for the display to change while the unit is searching for an item in a folder that contains a large amount of audio content. When you search for an item in a folder that has large amount of audio content, you can search for an item using a keyword (page 46).

## Other operations

To	Do the following
Pause playback	Press <b>  </b> during playback. Press <b>▶</b> to resume playback.
Stop playback	Press <b>■</b> .
Find a point in a track	Press and hold <b>◀◀/▶▶</b> ( <b>◀◀/▶▶</b> on the main unit) during playback and release it at the desired point.
Find the beginning of the previous/next track	Press <b>◀◀/▶▶</b> repeatedly.
Reselect the item you want to play	Press <b>BACK</b> repeatedly until the desired directory appears. Or press <b>OPTIONS</b> , select "To Server Top," and then select the item. To go back to the playback display, press <b>OPTIONS</b> and select "Now Playing."
Change the playback range* <sup>1</sup> * <sup>2</sup>	Press <b>OPTIONS</b> and select "Playback Range." You can select the playback range from "Current Folder" (factory setting) or "Parent Folder." When one of these playback range settings is selected, <b>□</b> lights up on the display.
Check the details of the selected item	Press <b>OPTIONS</b> and select "Information." You can see the detailed information of the selected item (content, folder, server, etc.).
View various information while the playback display appears* <sup>3</sup>	Press <b>DISPLAY</b> repeatedly. You can check the album name and the clock.

\*<sup>1</sup> If you change the playback range while the unit is playing a track, the playback will stop once when you select the playback range, then start playing the same track again from the beginning.

\*<sup>2</sup> When you set "Playback Range" to "Current Folder" or "Parent Folder," the unit plays audio content as follows.

- When you select "Current Folder," the unit plays tracks in the current folder.
- When you select "Parent Folder," the unit plays:
  - tracks in the parent folder.
  - tracks in folders contained in the parent folder.

The term “parent folder” used in this section means a folder one level higher in the structure tree than the folder that contains the currently selected item.

\*<sup>3</sup> You can view this information both when the unit is stopped and when it is playing a track, unless a list of items is displayed.

## To refresh the server list

If you cannot find the desired server in the server list (such as when you add a new server on the network but it does not appear on the server list, or when the server you normally use does not appear in the server list), refresh the server list.

**1** Press **FUNCTION** repeatedly to select the Home Network function.

If the unit automatically connects to the server that it was connected to the last time, press **BACK** repeatedly until the server list appears.

**2** While the unit is displaying the server list, press **OPTIONS** to enter the options menu and select “Refresh.”

“Scanning...” appears on the display and the unit searches for new servers. When the server list has been refreshed, a new server list appears.

### Tip

The unit keeps a history of the last five connected servers and these servers appear under the servers that are currently activated in the server list.

20 servers can be displayed in a server list. When the number of servers on the server list exceeds 20, the unit automatically deletes servers, starting from the oldest server. However, you can select and delete a server manually.

## To delete a server from the server list

You can delete non-operating or unrecognizable servers from the server list.

**1** Select the server you want to delete from the server list.

**2** Press **OPTIONS** to enter the options menu and select “Delete.”

**3** Select “OK.”

### Notes

- You cannot delete the server of which audio content is currently being played back by the unit. If you try to delete such a server, a message that requires you to stop playing the track appears on the display.
- Even if you delete the server from the server list, the server will appear in the list again when the unit finds it on the network (such as when you refresh the server list).



# Listening to music services

You can listen to music services offered on the Internet with this unit (Music Services function). To use this function, the unit has to be connected to the network and the network has to be connected to the Internet. For details on setting up the network, see “Connecting the unit to your home network (network settings)” (page 24). Refer to the following URL for details and further information on Music Services.  
<http://www.sony.net/audio/musicservices>

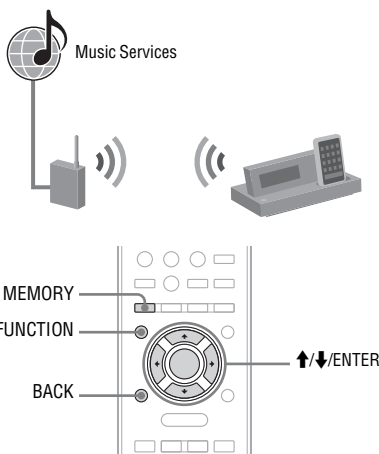

The following steps introduce how to select “vTuner” as an example of music services offered on the Internet.

---

**1** Set the source selector on the amplifier to the setting for this unit.

---

**2** Press **FUNCTION** repeatedly to select the Music Services function.

A list of service providers that the unit can connect to appears.

---

**3** Select “vTuner.”

---

**4** Select the desired folder or station, then press **ENTER**.

- Press **↑/↓** to select the item.
- Press and hold **↑/↓** so that the currently selected item number and the total number of items in a list appear on the display and you can scroll the list rapidly.
- Press **ENTER** to go to the next lower directory or to listen to the station.
- Press **BACK** to go to the next higher directory.

**Tip**

The station that was playing when the unit is turned off will start playing again when the unit is turned on again (only if the AC power adaptor of the unit was not disconnected from the wall outlet).

**Notes**

- If “No Service” appears and you cannot obtain a list of service providers, press **OPTIONS** and select “Refresh Service List.”
- If the unit is turned off and you disconnect the AC power adaptor from the wall outlet, information on the station that was playing when the unit was last turned off will be erased.

## Other operations

To	Do the following
Change the station or service	Press <b>BACK</b> to go back to the list of service providers and select the service again. To go back to the playback display again, press <b>OPTIONS</b> and select “Now Playing.”
Use various functions while the unit is selecting or playing a station or service	Press <b>OPTIONS</b> . The item displayed may vary according to the selected item or directory.

To	Do the following
View various information while the unit is playing a station or service	Press DISPLAY repeatedly to view the artist name, album name, the clock, etc.

### To refresh the service list

If the unit cannot find the music services, refresh the service list.

- 1** Press **SETTINGS** to enter the settings menu and select “Music Services Settings.”
- 2** When “Playback and network functions cannot be used during the setup. Press **ENTER** to continue.” appears, press **ENTER**.  
When “▼” is displayed, the message is continued to the next page. Press **↓** to see the entire text string.
- 3** Select “Refresh Service List.”
- 4** Select “OK.”

---

## Presetting stations

By presetting desired stations, you can easily reselect them by using the corresponding preset number. You can preset up to 20 stations.

This operation can only be carried out when the unit is playing a station.

- 1** Play the desired station.
- 2** Press **MEMORY**.  
A list of “Preset Memory” appears.
- 3** Press **↑/↓** to select a preset number and press **ENTER**.
- 4** Repeat steps 1 to 3 to preset other stations.

### To listen to the preset station

- 1** Press **FUNCTION** repeatedly to select the Music Services function.  
The unit automatically start playing the station that have received the last time.
- 2** Press **BACK** repeatedly until the list of service providers appears.
- 3** Select “Preset,” then select the desired preset station.

**Tip**

You can use the numeric buttons to select the preset station. Press the numeric button that corresponds to the preset number and press **ENTER** to select the preset station directly.

**Note**

There may be some stations that cannot be preset, depending on the service providers. If you try to preset such a station, “Not Available” appears on the display.

### To delete the preset station

- 1** Select the station you want to delete from the list of preset stations.
- 2** Press **OPTIONS** to enter the options menu and select “Delete.”
- 3** Select “OK.”

---

## Enjoying a variety of music services

You can enjoy listening to the content of a wide variety of music services offered on the Internet. Refer to the following URL for information on music services and how to listen to them with this unit.

### Music Services Portal

<http://www.sony.net/audio/musicservices>

## To check the registration code

You may be required to enter the registration code of the unit when you enjoy a new music service.

- 1** Press **SETTINGS** to enter the settings menu and select “Music Services Settings.”
- 2** When “Playback and network functions cannot be used during the setup. Press **ENTER** to continue.” appears, press **ENTER**.  
When “▼” is displayed, the message is continued to the next page. Press **↓** to see the entire text string.
- 3** Select “Registration Code.”  
The registration code of the unit appears on the display.

# Listening to audio content from an external component (Audio In)

You can listen to the playback sound from an external component (such as a portable music player, etc.) connected to the AUDIO IN jack on the unit.

Use an audio connecting cable (optional) to connect the AUDIO IN jack on the unit and the audio output jack on the external component. Make sure the audio connecting cable is firmly inserted into both jacks. If not, noise may be generated in the sound output.

---

**1** Set the source selector on the amplifier to the setting for this unit.

---

**2** Turn the volume of the connected amplifier down to its lowest level.

When the unit is connected to the Sony amplifier, press AMP VOL – on the remote control. For details on the remote control settings required to operate the Sony amplifier, see “Setting up the Sony amplifier” (page 19).

---

**3** Connect an external component to the AUDIO IN jack on the unit using an audio connecting cable.

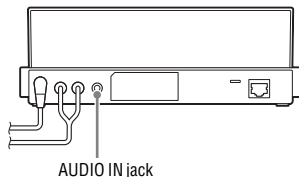

---

**4** Press FUNCTION repeatedly to select the AUDIO IN function.

---

**5** Start playback of the connected component and adjust its volume.

Playback sound is output from the connected amplifier. For details on the operation of the connected component, refer to the operating manual of the connected component.

## To adjust the input level

If the sound volume is too high or too low, you can change the input level on the unit according to the output level of the connected component.

**1** While the AUDIO IN function is selected, press OPTIONS to enter the options menu and select “AUDIO IN Sensitivity.”

**2** Select “Low(Line Out)” or “High(Headphone Out).”

Display	Description
◆ Low(Line Out)	When the unit is connected to the line out jack of the external component.
High(Headphone Out)	When the unit is connected to the headphone out jack of the external component.

(◆: Factory setting)

### Note

When the volume from an external component is too low, set the input level to “High(Headphone Out).” When the volume is too high or the sound is distorted, set the input level to “Low(Line Out).” Use the volume adjustment control if the connected component has a volume adjustment function.

# Changing the play mode

You can listen to tracks in random order (shuffle play) or one track repeatedly (repeat play). Play mode can be changed with the iPod & iPhone function and the Home Network function only.

## Notes

- The play mode that is set on the iPod/iPhone remains active after you place the iPod/iPhone on the unit. You can change the play mode with this unit. If you change the play mode on the unit, the play mode set on the unit remains active on the iPod/iPhone even after it is disconnected from the unit.
- If the album shuffle mode is set on the iPod/iPhone, “SHUF” lights up on the display when you connect the iPod/iPhone to the unit. If the album shuffle repeat mode is set on the iPod/iPhone, “SHUF” and “REP” light up on the display. (Note that this happens only when “Remote UI Mode” is set to “On.”)
- When the album shuffle mode or album shuffle repeat mode is set on the iPod/iPhone, the shuffle mode remains active but the unit does not shuffle tracks after you set the iPod/iPhone on the unit. If you want to shuffle tracks, set the play mode of the iPod/iPhone to shuffle or shuffle repeat mode.

Play mode/ indicator	Description
Normal/(none)	The unit plays all tracks for the selected playback range (artist, album, etc.) in sequential order.
Repeat/REP	The unit plays all tracks for the selected playback range (artist, album, etc.) repeatedly.
Repeat 1/REP 1	The unit plays the currently selected track repeatedly.
Shuffle*/SHUF	The unit plays the tracks for the selected playback range (artist, album, etc.) in random order.
Shuffle Repeat/ SHUF REP	The unit plays the tracks for the selected playback range (artist, album, etc.) in random order repeatedly.

\* Shuffle play is not available for the Home Network function.

## 1 While the unit is stopped, press PLAY MODE repeatedly.

The play mode and the play mode indicators change as follows.

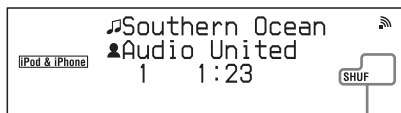

Play mode indicator\*

\* When the iPod & iPhone function is selected, the play mode indicators light up on the display only when “Remote UI Mode” is set to “On.”

## 2 Press ►.

Playback starts with the selected play mode.

# Searching for an item using a keyword

When a list of an item (such as an artist list, a track list, etc.) is displayed, you can enter a keyword to search for the desired item. This function can be used for the iPod & iPhone function\*, the Home Network function, and the Music Services function.

\* The alphabet search function can be used only when the “Remote UI Mode” for the iPod & iPhone function is set to “On.”

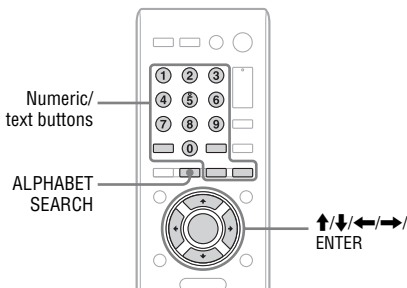

**1** When a list of an item (artist list, track list, etc.) is displayed, press ALPHABET SEARCH.

The keyword input display appears.

**2** Enter a keyword.

Use the numeric/text buttons to enter a keyword. For details on entering characters, see “Entering text” (page 18).

**Note**

Enter a keyword that will match the letters or a word at the beginning of the name or title of the item you want to search for. When the unit searches for an item, “The” at the beginning of a name and the following space will be ignored.

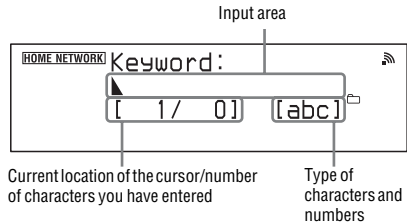

**3** When you finish entering the keyword, press ENTER.

“Searching...” appears on the display. When the unit finishes searching, an item that matches the keyword appears. If the item displayed is not the one you are searching for, press  $\leftarrow/\rightarrow$  so that the display changes to the next item which matches the keyword. If “No Results” appears and there is no item that matches the keyword, press  $\leftarrow/\rightarrow$  to try to find the item you are searching for. Press ALPHABET SEARCH again to go back to the keyword input display.

**4** When you find the desired item, press ENTER.

Playback starts.

# Using the PARTY STREAMING function

You can play back audio content that is being played back on this unit or on another device that has a PARTY STREAMING function at the same time, via your home network.

While using the PARTY STREAMING function, the device that starts a PARTY and streams the audio content is called the "PARTY host," and the device that joins a PARTY and plays the audio content streamed from the PARTY host is called a "PARTY guest."

Make sure that the "PARTY STREAMING" of the unit is set to "On" (page 54).

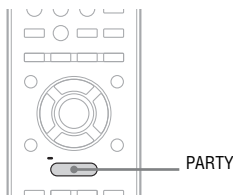
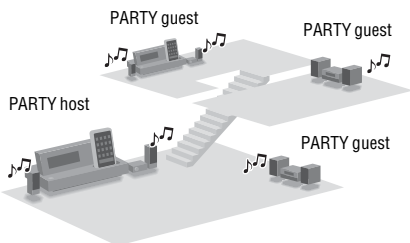

You can enjoy the PARTY STREAMING function with other devices that have this PARTY STREAMING logo (shown below).



## Starting a PARTY

You can start a PARTY so that other devices which support the PARTY STREAMING function can play the same music even though they are in different rooms.

- 1 Make sure the PARTY guest devices are turned on and are in the status which allows them to join a PARTY.
- 2 Play the desired sound source.  
Audio content played by the iPod & iPhone, Home Network, Music Services, or Audio In function can be streamed.
- 3 Press and hold PARTY for a few seconds.  
The unit starts PARTY STREAMING.

### To close a PARTY

Press and hold PARTY for a few seconds.

**Tip**

If the PARTY button is pressed on a device that has a PARTY STREAMING function while the unit is playing a track, the unit will start a PARTY as the PARTY host and the other device will join a PARTY as the PARTY guest.

---

## Joining a PARTY

The unit can join a PARTY which has been started by another device so that you can enjoy the same audio content as that being played in a different room.

---

When another device (PARTY host) is having a PARTY, press PARTY.

The unit joins the PARTY as a PARTY guest.

## To leave a PARTY

Press PARTY.

### Tips

- If the “Network Standby” mode of the unit is set to “On,” the unit turns on and joins the PARTY automatically when another device starts the PARTY.
- You can check the PARTY host information. Press OPTIONS and select “PARTY Host Info.”

### Notes

- You cannot join a PARTY in the following cases:
  - you have a PARTY on this unit.
  - you have already joined another PARTY.
- If you press PARTY when no PARTY is being held, but a device that has a PARTY STREAMING function is playing, the device will be the PARTY host and the unit will join the PARTY as the PARTY guest.



# Connecting the unit with other DLNA-compliant devices

This unit complies with the DLNA standard. You can enjoy listening to music in various ways by connecting the unit to other DLNA-compliant devices over your home network.

When using the unit together with other DLNA-compliant devices, the unit can perform three different roles, as a server, as a player, and as a renderer (network controlled player).

## About DLNA

DLNA is an abbreviation for Digital Living Network Alliance. It is the name of an organization that establishes guidelines (DLNA guidelines), and it is also the name of the method that allows devices in a house to share digital content (such as music data, image data, etc.) over a home network.

### ■ Server

The unit can be accessed by a player and the audio content from the unit can be played back by the player. The unit can stream audio content to one player at a time.



### About the status of the unit and the sound sources for audio streaming

When the unit is used as a server, audio content from an iPod/iPhone or an external component (Audio In) can be streamed to a player while the unit is turned on or is in the network standby - on mode status.

Audio can be streamed from the unit to a player when the unit is playing audio content or is stopped while the Home Network or Music Services function is selected.

### Notes

- To play content from an iPod/iPhone or an AUDIO IN sound source on a player or renderer (network controlled player), select the Home Network function or Music Services function on this unit or turn the unit off after setting the Network Standby mode to "On."
- The unit can stream audio content to one player at a time.

### ■ Player

The unit can access to a server and play the audio content stored on that server.

For details on the operation of the unit as a player, see "Listening to audio content stored on a server" (page 35).

The unit can access to one server at a time.



### Note

If the server supports the Wake-on-LAN standard, the unit turns on the server automatically. It may be necessary to make the required settings so the server can be turned on via the network by Wake-on-LAN. For details on the settings required for Wake-on-LAN, refer to the operating manual of the server.

### ■ Renderer (network controlled player)

When a DLNA-compliant controller operates the unit, the unit performs the role of a renderer (network controlled player). In this case, the controller sends the unit commands to access a server and play audio content stored on the server.

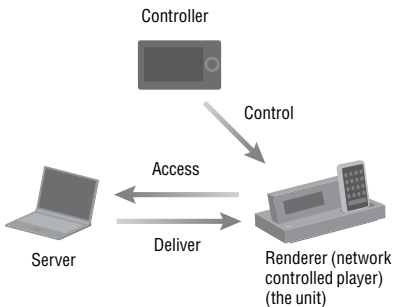

This section explains how to enjoy music with DLNA-compliant devices on your home network, using some examples.

**Note**

The unit is set to allow all devices access to the unit automatically as the factory setting. You can select and register devices which can or cannot access this unit. For details, see “Setting up access permission” (page 52) and “Using lists of permitted and non-permitted devices” (page 52).

## Playing audio content on the unit using a controller

You can use a DLNA controller to control the unit and to play audio content on the unit. To perform these operations, check the following first.

- Check that all devices are connected to your home network and set up correctly.
- Check that the unit is turned on or the unit is in the network standby - on mode.
- Check that the controller has been added to the “Permitted Devices” list of the unit.
- Check that the unit has been recognized and registered with the controller.

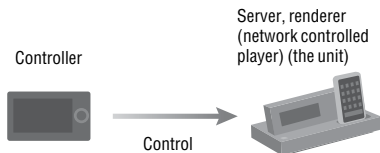

## Streaming audio content to a renderer (network controlled player) using a controller

You can use a DLNA controller to control the unit to stream audio content to a renderer (network controlled player). Content from an iPod/iPhone or Audio In can be streamed to a renderer (network controlled player). To perform these operations, check the following first.

- Check that all devices are connected to your home network and set up correctly.
- Check that the unit and the renderer (network controlled player) are turned on or the unit and the renderer (network controlled player) are in the network standby - on mode.
- Check that the controller and the renderer (network controlled player) have been added to the “Permitted Devices” list of the unit.
- Check that the unit and the renderer (network controlled player) have been recognized and registered with the controller.

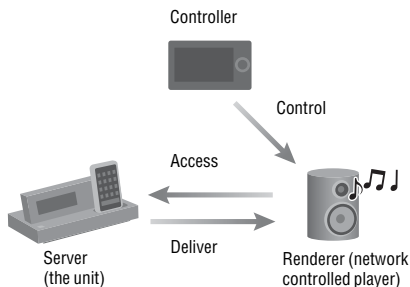

---

## Playing audio content streamed from a server (such as a computer) using a controller

You can use a DLNA controller to stream audio content stored on a server (such as a computer) to the unit.

- Check that all devices are connected to your home network and set up correctly.
- Check that the unit and the server are turned on or the unit and the server are in the network standby - on mode.
- Check that the unit and the controller are allowed to access the server.
- Check that the unit and the server have been recognized and registered with the controller.

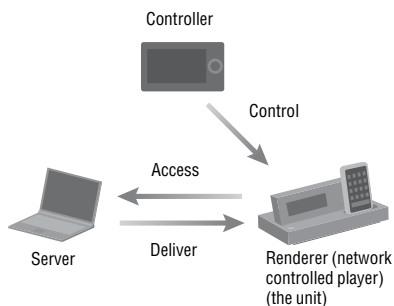

### Tip

If you use Windows 7 as a server, you can use the [Play To] function of Windows 7 to listen to the audio content stored on the computer.

# Setting up the functions related to network operations

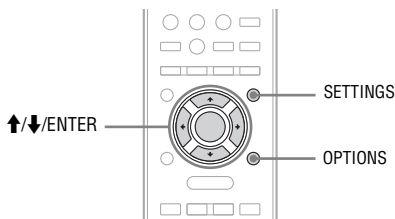

## Setting up access permission

When a new device is added on the network and accesses the unit, you can select whether the unit adds the device to the list of permitted devices automatically or manually. (For details on the list of permitted devices, see “Using lists of permitted and non-permitted devices” on page 52.)

**1** Press **SETTINGS** to enter the settings menu and select “Optional Network Settings.”

**2** When “Playback and network functions cannot be used during the setup. Press **ENTER** to continue.” appears, press **ENTER**. When “▼” is displayed, the message is continued to the next page. Press **↓** to see the entire text string.

**3** Select “Access Permission Settings.”

## 4 Select “Auto” or “Manual.”

Display	Description
◆ Auto	When a new device accesses the unit, the unit automatically adds the device to the “Permitted Devices” list of the unit (page 52).
Manual	When a new device accesses the unit, the unit does not add the device to the list of permitted devices, but to the “Pending Devices” list of the unit (page 52).

(◆: Factory setting)

### Note

Up to 20 devices can be added to the list of “Permitted Devices” or “Pending Devices.” If 20 devices have already been registered, a new device cannot be added to either list. In this case, delete unnecessary devices or move devices from the lists (see “To edit a list” on page 53).

## Using lists of permitted and non-permitted devices

The unit has two lists, a “Permitted Devices” list and a “Pending Devices” list, for the devices which are allowed to access the unit.

- **“Permitted Devices” list:**

Devices allowed to access the unit are on this list.

When the unit is used as a server, player devices which are registered in this list can access the unit.

- **“Pending Devices” list:**

Devices not yet allowed to access the unit are on this list.

As “Access Permission Settings” is set to “Auto” (factory setting) (page 52), the unit adds new devices that have accessed the unit to the “Permitted Devices” list automatically. You can view each list and edit it. Up to 20 devices can be added to a list.

**Note**

If the server name cannot be found, “No Name” appears in the “Permitted Devices” list, the “Pending Devices” list, and “Model Name” for “Information” in the options menu.

**To view a list**

- 1** Press **SETTINGS** to enter the settings menu and select “Optional Network Settings.”
- 2** When “Playback and network functions cannot be used during the setup. Press **ENTER** to continue.” appears, press **ENTER**.  
When “▼” is displayed, the message is continued to the next page. Press **↓** to see the entire text string.
- 3** Select “Access Control.”
- 4** Select “Permitted Devices” or “Pending Devices.”

**To edit a list**

You can view the details of the registered devices, and then delete them from the list.

- 1** While viewing either the “Permitted Devices” or “Pending Devices” list, select the device you want to edit.
- 2** Press **OPTIONS** to enter the options menu and select the desired item.

**When the options menu for the “Permitted Devices” list is displayed:**

Display	Description
Information	The “Model Name” and “MAC Address” of the selected device appear.
Delete	You can select from “Cancel” and “OK.” Select “OK” to delete the selected device.

Display	Description
Delete All	You can select from “Cancel” and “OK.” Select “OK” to delete all the devices on the list.

**When the options menu for the “Pending Devices” list is displayed:**

Display	Description
Information	The “Model Name” and “MAC Address” of the selected device appear.
Move	The selected device moves to the “Permitted Devices” list.
Delete	You can select from “Cancel” and “OK.” Select “OK” to delete the selected device.
Delete All	You can select from “Cancel” and “OK.” Select “OK” to delete all the devices on the list.

**Using the SMART SELECT function**

Setting “SMART SELECT” to “On” allows the applicable Sony controller SMART SELECT to find the unit as the target component by using the infrared function.

- 1** Press **SETTINGS** to enter the settings menu and select “Optional Network Settings.”
- 2** When “Playback and network functions cannot be used during the setup. Press **ENTER** to continue.” appears, press **ENTER**.  
When “▼” is displayed, the message is continued to the next page. Press **↓** to see the entire text string.

---

**3** Select “SMART SELECT.”

---

**4** Select “On” (◆) or “Off.”  
(◆: Factory setting)

---

---

## Setting the PARTY STREAMING function

You can set the unit to use the PARTY STREAMING function.

---

**1** Press **SETTINGS** to enter the settings menu and select “Optional Network Settings.”

---

**2** When “Playback and network functions cannot be used during the setup. Press **ENTER** to continue.” appears, press **ENTER**. When “▼” is displayed, the message is continued to the next page. Press **↓** to see the entire text string.

---

**3** Select “PARTY STREAMING.”

---

**4** Select “On” or “Off.”

Display	Description
◆ On	The unit can be detected by other devices on the home network. The unit can start or close a PARTY, and join or leave a PARTY.
Off	The unit can be detected by other devices on the home network. However, the unit cannot start or join a PARTY.

(◆: Factory setting)

---

## Naming the unit

You can name this unit so that the unit can be recognized by this name by other devices on the home network.

---

**1** Press **SETTINGS** to enter the settings menu and select “Optional Network Settings.”

---

**2** When “Playback and network functions cannot be used during the setup. Press **ENTER** to continue.” appears, press **ENTER**. When “▼” is displayed, the message is continued to the next page. Press **↓** to see the entire text string.

---

**3** Select “Device Name.”

---

**4** Enter the name.  
For details on how to enter text, see “Entering text” (page 18).

# Turning the operating sound on or off

The operating sound for the operation buttons on the main unit is set to “On” as the factory setting. You can turn this sound on or off.

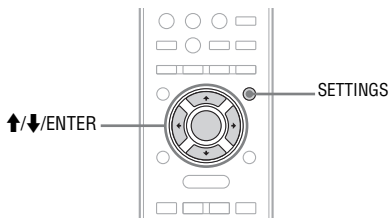

---

**1** Press **SETTINGS** to enter the settings menu and select “Touch Key Settings” - “Beep Settings.”

---

**2** Select “On” (◆) or “Off.”  
(◆: Factory setting)

# Using the timer

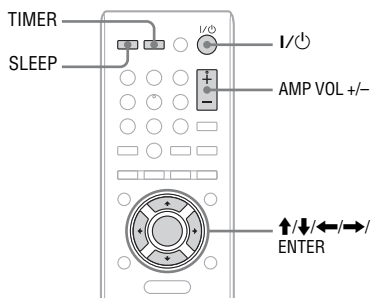

## Using the Sleep Timer

You can set the Sleep Timer so that the unit enters standby mode automatically after a certain period of time (Sleep Timer function). This function operates even if the clock is not set.

**1** Set the source selector on the amplifier to the setting for this unit.

**2** Play the desired sound source.

**3** Press **SLEEP** repeatedly.

Each time you press the button, the time interval changes as follows.

“SLEEP 15min” → “SLEEP 30min” →

“SLEEP 60min” → “SLEEP 90min” →

“SLEEP Off”(◆)

(◆: Factory setting)

The time interval display disappears if you do not operate the unit for 4 seconds, then the Sleep Timer is set.

While the unit is processing the selected time interval, the SLEEP indicator flashes slowly on the display. It keeps flashing until the unit enters the standby mode.

You can change the function (sound source, such as the iPod & iPhone function, the Home Network function, etc.) before the Sleep Timer turns the unit off.

After the selected time elapses, the unit enters standby mode automatically.

## To check the remaining time before the Sleep Timer turns the unit off

Press **SLEEP** so that the remaining time before the Sleep Timer turns the unit off appears on the display.

### Tip

If you set both the Sleep Timer and Play Timer at the same time, the Sleep Timer takes priority.

### Note

If you perform the following operations before the Sleep Timer turns the unit off, the Sleep Timer resets.

- Disconnect the AC power adaptor from the wall outlet.
- Update the system of the unit.
- Enter the settings menu and perform “All Reset.”



---

## Using the Play Timer

You can set the Play Timer to start playing an iPod/iPhone or a music service at a specified time (Play Timer function). Make sure you have set the clock.

---

**1** Set the source selector on the amplifier to the setting for this unit.

---

**2** Prepare the sound source.

Select the sound source (iPod/iPhone or Music Services), and then adjust the volume on the amplifier (you can use AMP VOL +/- to control the Sony amplifier). For details on the remote control settings required to operate the Sony amplifier, see “Setting up the Sony amplifier” (page 19).

---

**3** Press **TIMER**.

---

**4** When “**TIMER Setting**” appears, press **ENTER**.

The “Start Time” setting display appears, and the “ⓄPLAY” indicator starts flashing rapidly.

---

**5** Set the starting time.

Press **↑/↓** to change the hour and press **→**. The cursor moves to the minute setting. Perform the same operation to set the minute. Press **←/→** to move the cursor. Press and hold **↑/↓** to change the parameter sequentially. After you set the minute, press **ENTER**. The “End Time” setting display appears.

---

**6** Set the ending time.

Perform the same operation as that in step 5 to set the end time.

---

**7** Select the source (“iPod & iPhone” or “MUSIC SERVICES”) you want to play.

When the Play Timer is set, “Complete.” appears, and the “ⓄPLAY” indicator lights up on the display.

---

**8** Press **I/Ⓞ** to enter the standby mode.

---

### To go back to the previous display

Press **BACK** before you select the sound source in step 7.

### To cancel the timer setting

While the Play Timer is set, press **TIMER**. When “**TIMER Off**” appears on the display, press **ENTER**.

#### Notes

- Make sure that the power of the connected amplifier is turned on when the Play Timer starts.
- The Play Timer is erased if you format the system (page 60).
- If the unit is already turned on at the preset starting time, the Play Timer will not be activated.
- The Play Timer may not be activated depending on the status of the connected iPod/iPhone.
- If you select the Music Services function as the sound source, the sound may not be output, depending on the service provider or the network environment.

# Viewing the information of the unit

You can view the information of the unit.

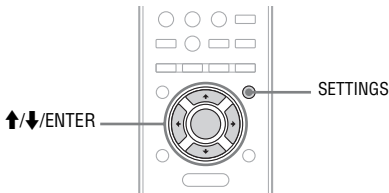

---

**1** Press **SETTINGS** to enter the settings menu and select “Device Details.”

---

**2** Select the item you want to view.

Display	Description
Model Name	This is the name that is set for this unit and is displayed on the server.
System Software	You can view the firmware version of this unit.
MAC Address(Wired LAN)	You can check the MAC address for the wired network of the unit.
MAC Address(Wireless LAN)	You can check the MAC address for the wireless network of the unit.

## To go back to the previous display

Press **BACK**.

# Managing the system

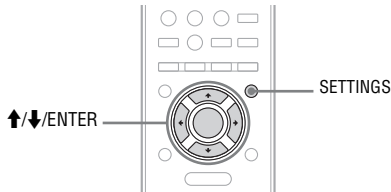

## Updating the system application

By downloading the latest version of the system application, you can take advantage of the newest functions. The unit accesses the Sony server to update the system.

When a new update is available, you will be notified by a message that appears on the display while the unit is on and connected to the Internet. Make sure that the unit is stopped before updating the system.

For details on system update available, refer to the customer support site (page 61).

### Notes

- Make sure not to turn off the unit or disconnect the network cable while the updating operation is in progress.
- If you try to update the system when the Sleep Timer is on, it will be changed to "Off" automatically.

- 1** Press **SETTINGS** to enter the settings menu and select "System Update."

- 2** When "Playback and network functions cannot be used during the setup. Press ENTER to continue." appears, press **ENTER**.

When "▼" is displayed, the message is continued to the next page. Press **↓** to see the entire text string.

- 3** When "Found latest update. Press ENTER." appears, press **ENTER**.

If the update is not available, "No update required." appears.

- 4** When "System Update" display appears, select "OK."

A message that confirms whether or not you agree to the terms of the system update appears. Confirm the message and also read the "END-USER LICENSE AGREEMENT FOR SONY SOFTWARE" (page 77), and then select "Agree."

- 5** Follow the display instructions.

The unit starts to update the system application. It may take a while (about 20 minutes at the longest) for the unit to finish the update. The required time will depend on the amount of data in the updates, the line type of the network, the network communication environment, etc. When the system update finishes, the unit restarts automatically.

### To cancel the procedure

Select "Cancel" in step 4.

## To go back to the previous display

Press BACK before the unit starts the system update.

You cannot go back to the previous display after the update starts.

---

## Formatting the system

This function formats the unit and restores it to the condition it was at the time of purchase. Note that this process deletes all settings and information (e.g., clock setting, network settings).

- 
- 1** Press **SETTINGS** to enter the settings menu and select “All Reset.”
  - 2** When “Playback and network functions cannot be used during the setup. Press **ENTER** to continue.” appears, press **ENTER**.  
When “▼” is displayed, the message is continued to the next page. Press **↓** to see the entire text string.
  - 3** Select “OK.”
  - 4** When “Are you sure?” appears, select “OK.”  
Formatting starts.  
The unit automatically restarts at the end of the procedure. When the unit finishes formatting, the initial setup display appears.

## To cancel the procedure

Select “Cancel” in step 3 or 4.

## To go back to the previous display

Press **BACK** before you select “OK” in step 4.

# Troubleshooting

If a problem occurs while operating the unit, follow the steps described below before consulting your nearest Sony dealer. If an error message appears, it is recommended that you make a note of its contents for reference.

**1** Check to see if the problem is listed in this “Troubleshooting” section.

**2** Check the following customer support site.

- For customers in the USA:  
<http://www.esupport.sony.com/>
- For customers in Canada:  
English:  
<http://www.sony.ca/ElectronicsSupport/>  
French:  
<http://fr.sony.ca/ElectronicsSupport/>

You will find the latest support information and a FAQ at this web site.

**3** If, after steps 1 and 2, you still cannot solve the problem, consult your nearest Sony dealer.

If the problem persists after doing all of the above, consult your nearest Sony dealer. When bringing the product in for repairs, be sure to bring in the entire system (main unit, remote control, and AC power adaptor). This product is a system product, and so the entire system is needed to determine the section requiring repair.

## How to reset the unit

It is usually unnecessary to reset this unit. However, on rare occasions, the unit enters an abnormal state and stops responding to button or on-screen operations. In this case, press and hold I/⏻ (power) on the main unit for 10 seconds to reset the unit.

### If the on/standby indicator flashes in red or amber

Immediately unplug the AC power adaptor, and check the following item.

- Is the iPod/iPhone connector short-circuited?

After the on/standby indicator stops flashing, reconnect the AC power adaptor, and turn on the unit.

If the issue persists, contact your nearest Sony dealer.

## Power

### The unit does not turn on.

- ➔ Connect the AC power adaptor to the unit and to the wall outlet firmly (page 14).
- ➔ The batteries in the remote control may be drained. Replace both batteries with new ones.
- ➔ The unit’s internal system may be malfunctioning, or the unit may be suffering from strong electrical noise caused by power supply abnormalities due to being dropped, excessive static electricity, or lightning. In this case, reset the unit (page 61). If the problem still persists, disconnect the AC power adaptor from the wall outlet, wait about 60 seconds, and then reconnect it.

### The unit does not turn off.

- ➔ The unit’s internal system may be malfunctioning, or the unit may be suffering from strong electrical noise caused by power supply abnormalities due to being dropped, excessive static electricity, or lightning. In this case, reset the unit (page 61). If the problem still persists, disconnect the AC power adaptor from the wall outlet, wait about 60 seconds, and then reconnect it.
- ➔ The I/⏻ (power) button may not respond while the unit is still starting up.
- ➔ The unit enters standby mode when you turn off the power. If you want to completely turn off the power, disconnect the AC power adaptor.

---

The on/standby indicator remains lit after you unplug the AC power adaptor from a wall outlet.

---

- ➔ The on/standby indicator may not turn off immediately after you unplug the AC power adaptor. This is not a malfunction. The indicator will turn off after 30 seconds.
- 

The clock is displayed after you turn the unit off.

---

- ➔ If the “Network Standby” mode is set to “On,” the clock is displayed when the unit is turned off.
- 

## Sound output

---

There is no sound.

---

- ➔ The volume may be minimized. Adjust the volume of the connected amplifier.
  - ➔ Check to make sure that the unit is not paused.
  - ➔ Check the amplifier connections and confirm that the amplifier is turned on.
  - ➔ Check the connections of the device connected to the unit. Check to make sure the proper function is selected.
  - ➔ The specified station may have temporarily stopped broadcasting.
  - ➔ If you select the Music Services function as the sound source, the sound may not be output, depending on the service provider or the network environment.
- 

There is severe humming or noise in the sound.

---

- ➔ Move the audio connecting cable away from any display, fluorescent light, or other electrical devices.
  - ➔ Move the unit away from any display or TV.
  - ➔ If plugs or jacks are dirty, wipe them with a cloth slightly moistened with alcohol.
  - ➔ Connect the unit to a different wall socket.
  - ➔ Install a noise filter (available separately) to the AC power adaptor.
- 

## Network connection

---

An error message appears.

---

- ➔ Check the nature of the error. See “Messages” (page 65).
- 

---

The unit cannot connect to the network.

---

- ➔ The network settings on the unit may be incorrect. Confirm the network status. Enter the settings menu and select “Network Settings” - “Tools” - “Connection Diagnosis” (page 31). For further information on the network connection, refer to the customer support site (page 61).
  - ➔ When the unit is connected via a wireless network, move the unit and the wireless LAN router/access point closer to each other and perform the setup again.
  - ➔ Check the settings of the router/wireless LAN router/access point and perform the setup again. For details on the settings of the devices, refer to the operating manual of the devices.
  - ➔ Wireless networks are influenced by electromagnetic radiation emitted by microwave ovens and other devices. Move the unit away from these devices.
  - ➔ Make sure that the router/wireless LAN router/access point is turned on.
  - ➔ If you have reset the unit or have performed a system recovery on your server, make the network settings again (page 24).
- 

## iPod & iPhone

---

“Insert iPod or iPhone” appears.

---

- ➔ Make sure the iPod/iPhone is connected securely.
- 

There is no sound.

---

- ➔ Make sure the iPod/iPhone is connected securely.
  - ➔ Make sure the iPod/iPhone is playing music.
  - ➔ Adjust the volume.
- 

The sound is distorted.

---

- ➔ Turn down the volume.
- 

The unit does not display the content stored on the connected iPod/iPhone.

---

- ➔ “Remote UI Mode” may be set to “Off.” When this item is set to “Off,” the iPod/iPhone content does not appear on the display. Enter the options menu of the iPod & iPhone function and set “Remote UI Mode” to “On” (page 33).
- 

The remote control does not function.

---

- ➔ Make sure the iPod/iPhone is updated with the latest software. If not, update the iPod/iPhone before using it with the unit.
  - ➔ “Remote UI Mode” may be set to “Off.” When this item is set to “Off,” the iPod/iPhone content does not appear on the display. Enter the options menu of the
-

iPod & iPhone function and set “Remote UI Mode” to “On” (page 33).

---

### The iPod/iPhone cannot be charged.

---

- ➔ Make sure the iPod/iPhone is connected securely.
- ➔ You can use the unit as a battery charger for an iPod/iPhone when the unit is on or when “Network Standby” set to “On” (page 34).

---

### “Remote UI Mode” is automatically set to “On” when an iPod/iPhone is connected to the iPod/iPhone dock of the unit.

---

- ➔ This may sometimes happen, depending on the iPod/iPhone model you are using.

---

### “Remote UI Mode” cannot be set to “Off.”

---

- ➔ This may sometimes happen, depending on the iPod/iPhone model you are using.

## Home Network

---

### The server (such as a computer) does not appear in the server list. (“No Server” appears.)

---

- ➔ Depending on the security software used on the computer, the computer may not appear in the server list of the unit. For details, refer to the help of the security software.
- ➔ You may have turned this unit on before you turned the server on. Enter the options menu and select “Refresh” in the server list display to refresh the server list (page 40).
- ➔ Make sure that the router/wireless LAN router/access point is turned on.
- ➔ Make sure that the server is turned on.
- ➔ Confirm that the server has been set correctly (page 35). Confirm that the unit has been registered with the server and is set to allow music streaming from the server.
- ➔ Confirm that the unit and the server are connected to the router/wireless LAN router/access point correctly. Enter the settings menu and select “Network Settings” - “Tools” - “Connection Diagnosis” (page 31). For further information on the network connection, refer to the customer support site (page 61).
- ➔ The server may be unstable. Restart it.
- ➔ If the ICF (Internet Connection Firewall) function is active on the computer, this may prevent the unit from connecting to the computer (only when your computer is used as a server). You may need to change the firewall settings to allow the unit to connect. (For details on changing the firewall settings, refer to the operating manual of your computer).

---

### You cannot play audio data normally.

---

- ➔ Shuffle repeat play is selected. Set the play mode to normal (page 45).

---

### The sound skips during playback.

---

- ➔ The bandwidth of your wireless LAN may be too low. Move the unit and the wireless LAN router/access point closer to each other, without any obstacles between them.
- ➔ When you are using your computer as a server, the computer may be running many applications. If anti-virus software is active on the computer, temporarily disable that software as it needs large amounts of system resources.
- ➔ Depending on the network environment or any radio interference, it may not be possible to play tracks with more than one device operating at one time. Turn off any other devices to enable the unit to play tracks.

---

### “Cannot Play” appears.

---

- ➔ You cannot play any files other than audio files.
- ➔ Confirm that the server has been set correctly (page 35). Confirm that the unit has been registered with the server and is set to allow music streaming from the server.
- ➔ Check to confirm whether the audio file on the server is damaged or erased. Refer to the operating manual of the server.
- ➔ You cannot play the following tracks:
  - A track that violates playback restrictions.
  - A track with irregular copyright information.
  - A track that you purchased at an online music store that does not allow home network streaming.
  - A track in a format not supported by the unit (page 38).
- ➔ Confirm that the selected track has not been erased from the server. If the track has been erased, select another track.
- ➔ Make sure that the router/wireless LAN router/access point is turned on.
- ➔ Make sure that the server is turned on.
- ➔ The server may be unstable. Restart it.
- ➔ Confirm that the unit and the server are connected to the router/wireless LAN router/access point correctly.

---

### “No Content” appears.

---

- ➔ If there are no tracks or folders in the selected folder, you cannot extend the folder to display its contents.

---

You cannot play a copyrighted WMA format track.

---

- ➔ Depending on the WMA file format, you may not be able to play some tracks.
- 

You cannot select a previously selected track.

---

- ➔ The track information may have been changed on the server. Reselect the server in the server list (page 38).
- 

The playback range cannot be changed.

---

- ➔ If the playback range has been set to “one track” for some reason, you cannot change the playback range using “Playback Range” in the options menu. In this case, reselect some other item from the content list.
- 

Devices on the network cannot connect to the unit.

---

- ➔ “Network Standby” may be set to “Off.” Turn on the unit or set “Network Standby” to “On” (page 17).
  - ➔ Confirm that the network is correctly set up. If it is not, the connection cannot be made (page 31).
  - ➔ The device has been added to the “Pending Devices” list. To add the device to the “Permitted Devices” list, select the device from the “Pending Devices” list, enter the options menu and then select “Move.” (page 53).
  - ➔ A maximum of 20 connectable devices have been set. Delete unnecessary devices from the “Permitted Devices” list, and then set “Access Permission Settings” to “Auto,” or move the device from “Pending Devices” to “Permitted Devices” (page 53).
  - ➔ Server operation of the unit is suspended if the unit is conducting one of the following operations.
    - Playing a track stored on the server (the unit is operating as a player)
    - Updating the system application
    - Formatting the system
  - ➔ The unit cannot stream audio content to multiple players. The unit can connect to only one player at a time.
- 

A player cannot play tracks on the iPod/iPhone placed on the unit.

---

- ➔ Track information on the connected iPod/iPhone has been updated. For this reason, the player may sometimes be unable to obtain the correct track information. If this is the case, the information on the player device should be refreshed.
- 

---

The unit cannot be turned on automatically when accessed by devices on the network.

---

- ➔ The unit itself does not support the Wake-on-LAN standard. Therefore the unit cannot be turned on by Wake-on-LAN when “Network Standby” is set to “Off.” Set “Network Standby” to “On” so that the unit can respond to operations by other devices via a network (page 17).
- 

A player cannot receive audio content from the unit.

---

- ➔ Audio streaming from the unit will depend on the function selected and the status of the unit. For details on audio streaming from the unit, see “About the status of the unit and the sound sources for audio streaming” (page 49).
- 

The unit cannot play the track that is currently being played by the PARTY host.

---

- ➔ The PARTY host is playing a track of an audio format that cannot be played on the unit.
  - ➔ It may take a while before the playback sound is output.
- 

The unit has joined an unintended PARTY.

---

- ➔ The PARTY feature is being used by several devices at the same time when the unit tries to join a PARTY, the unit may not be able to join the desired PARTY. Close all other instances of the PARTY feature except the desired one, then join the desired PARTY.
- 

## Music Services

---

You cannot connect the unit to a service.

---

- ➔ Make sure that the router/wireless LAN router/access point is turned on.
  - ➔ Confirm the network status. Enter the settings menu and select “Network Settings” - “Tools” - “Connection Diagnosis” (page 31). If an error occurs, an error number appears and “!” appears next to the error item.
  - ➔ When the unit is connected via a wireless network, move the unit and the wireless LAN router/access point closer to each other and perform the setup again.
  - ➔ If your contract with your Internet provider limits Internet connection to one device at a time, this device will not be able to access the Internet when another device is already connected. Consult your carrier or service provider.
-



---

The sound skips.

---

- ➔ The bandwidth of your wireless LAN may be too low. Move the unit and the wireless LAN router/ access point closer to each other, without any obstacles between them.
- 

The elapsed time is not displayed on the playback display.

---

- ➔ The elapsed time may not be displayed depending on the content.
- 

## Play Timer

---

“Date&Time Error” appears.

---

- ➔ If the clock on the unit has not been set, you cannot set the Play Timer. Set the clock before setting the Play Timer (page 22).
- 

“Time Error” appears.

---

- ➔ The ending time for the Play Timer cannot be the same as the starting time.
- 

Play Timer setting does not function when the starting time is reached.

---

- ➔ A power failure occurred while the timer setting was in standby mode or the AC power adaptor was disconnected.
- 

## Others

---

The unit works poorly.

---

- ➔ The unit may be under the influence of static electricity or other factors. In this case, restart the unit. If the unit still works poorly, reset the unit (page 61).
  - ➔ If a warning message appears, follow the instructions given by the message.
- 

The unit does not respond to any operations.  
The unit does not work correctly.

---

- ➔ The unit’s internal system may be malfunctioning, or the unit may be suffering from strong electrical noise caused by power supply abnormalities due to being dropped, excessive static electricity, or lightning. In this case, disconnect the AC power adaptor from the wall outlet, wait about 40 seconds, and then reconnect it.
- 

# Messages

## Common messages

### Browse Limit

You tried to select the 11th level in a file tree while the unit can select down only to the 10th level.

### Cannot connect.

#### [ Network settings ]

The unit cannot connect to a network, or the unit cannot obtain the IP address because it cannot connect to the DHCP server for some reason (e.g., you input an incorrect WEP key). Check the network connection (page 31) or go to the network settings procedures and input the security key (WEP Key, WPA/WPA2 Key) again (page 24).

#### [ Clock setting (Date&Time Settings) ]

The unit cannot connect to the NTP server. Check that the NTP server address is correct.

### Cannot connect to server.

The unit cannot connect to the server because the server may be turned off or the server may not be connected to a network. Turn on the power of the server or check if the server is connected to a network correctly.

### Cannot Play

You tried to play audio content that the unit cannot play.

### Cannot Retrieve Info

The unit cannot retrieve information from the server.

The unit failed to obtain the registration code for the Music Services settings. Check the registration code again (page 43).

### Data Error

The selected audio content (data) has been damaged.

### No Content

There is no content in the selected folder on the server.

### No Results

There is no item that corresponds to the keyword used to search for that item.

### Not Available

The operation that you performed is unavailable or invalid.

## Network settings

### Input Error

The string of letters and numbers you have entered is not correct.

### Not found.

The unit cannot find the access point.

### The same address is already set.

You entered the same string of numbers both for the primary DNS server address and the secondary DNS server address.

## iPod/iPhone

### Cannot connect to device

The unit failed to connect to the iPod/iPhone.

### Insert iPod or iPhone

An iPod/iPhone is not placed on the unit. This message may appear when the power of the connected iPod/iPhone is drained.

### Unsupported device connected

The connected iPod is not supported by the unit.

## Home Network

### Access denied.

The unit is not allowed to connect to the server. Register the unit with the server.

### Cannot delete.

The unit cannot delete a server from the server list or the “Permitted Devices” list.

### Cannot delete server. Stop Playback.

You tried to delete a server while it is streaming audio content to the unit.

### No more can be added.

You cannot add anymore items. (Appears when you try to add a server to a list.)

### No Server

There is no server that the unit can connect to. Try refreshing the server list (page 40).

## Music Services

### Cannot refresh Service List.

The unit cannot refresh the service list for some reason (the unit is not connected to a network, etc.). Check the network connection (page 31).

### No Preset

You selected a preset number for which no station is assigned.

### No Service

There is no service available. Refresh the service list (page 42).

## PARTY

### Cannot receive PARTY data.

The unit cannot obtain the audio content streamed by the PARTY host. Check the network connection (page 31). If the unit is connected to the network correctly, check the status of the PARTY host device.

### Enable PARTY STREAMING Setting.

The unit is set to disable the PARTY STREAMING function. Set the “PARTY STREAMING” setting to “On” (page 54).

### No PARTY STREAMING.

You tried to join a PARTY while there is no PARTY currently being hosted by other devices.

### PARTY not available.

The unit has failed to start or join a PARTY as there are no devices that can join the PARTY.

## Timer

### Date&Time Error

You tried to select the timer without first setting the clock.

### Time Error

The ending time that you tried to set for the Play Timer is the same time as the starting time.

## System update

### Cannot download.

The unit failed downloading the update data while performing the system update. Enter the settings menu and update the system again (page 59).

### Cannot update.

The unit cannot update the system application. Contact your nearest Sony dealer.

### Download Error

The unit cannot download the update data. Reset the unit (page 61), then enter the settings menu and update the system again (page 59).

## Others

### Internal Error

An internal error has occurred. Disconnect the AC power adaptor from the wall outlet, wait for a while, then reconnect it.

### Setup data error

The data location that holds various settings has been initialized. Perform the setup operations again.

### Unexpected error

An unexpected error has occurred. Perform the operation again. If the unit does not work correctly, reset the unit (page 61).

# Precautions

## On safety

- Completely disconnect the power cord (mains lead) from the wall socket (mains) if it is not going to be used for an extended period of time. When unplugging the unit, always grip the plug. Never pull the cord itself.
- Should any solid object or liquid get into the unit, unplug the unit, and have it checked by qualified personnel before operating it again.
- The AC power adaptor can be changed only by a qualified service facility.

## On placement

- Do not place the unit in an inclined position or in locations that are extremely hot, cold, dusty, dirty, humid, lacking adequate ventilation, subject to vibration, direct sunlight, or a bright light.
- Be careful when placing the unit on surfaces that have been specially treated (for example, with wax, oil, polish) as staining or discoloration of the surface may result.
- If the unit is brought directly from a cold to a warm location or is placed in a very damp room, moisture may condense inside of the unit, and cause the unit to malfunction. In this situation, leave the unit turned on for about an hour until the moisture evaporates.

## On heat buildup

- Heat buildup on the unit during operation is normal and is not cause for alarm.
- Do not touch the cabinet if it has been used continuously at a high volume because the cabinet may have become hot.

## About the AC power adaptor

- Use the AC power adaptor supplied with this unit. Do not use any other AC power adaptor since it may cause this unit to malfunction.



Polarity of the plug

- Connect the AC power adaptor to an easily accessible AC outlet. Should you notice an abnormality in the AC power adaptor, disconnect it from the AC outlet immediately.
- The unit is not disconnected from the AC power source (mains) as long as it is connected to the wall outlet, even if the unit itself has been turned off.
- If you are not going to use this unit for a long time, be sure to disconnect the power supply. To remove the AC power adaptor from the wall outlet, grasp the adaptor plug itself; never pull the cord.

## About this unit

- If you have connected to an outside network, such as the Internet, and have allowed access from other devices, unauthorized access by malicious outsiders can occur depending on your network configuration. It may cause damages such as data falsification. To avoid this problem, before using this unit, you need to:
  - Use a router and configure it correctly.
  - Register the equipment that is to access this unit.
- It is prohibited to send or leave copyrighted products to/on an out-of-home network which can be accessed from many people without the author's permission by the Copyright Act.

- About DLNA support:

This product is designed in accordance with DLNA Guideline v1.5. This product is commercialized to gain formal DLNA accreditation. This product may be upgraded to maintain interconnectivity.

## Do not drop this unit

Do not subject the unit to strong shocks. It may cause the unit to malfunction.

## On volume adjustment

If you raise the volume while listening to a segment containing only noise (as you might do in the case of a vinyl record), a sudden output of high-volume sound may cause damage to the speakers. Make sure to lower the volume before the start of playback.

## Consideration for others

Keep the volume at a moderate level out of consideration for your neighbors, especially at night.

## Cleaning the cabinet

Clean this unit with a soft cloth slightly moistened with a mild detergent solution. Do not use any type of abrasive pad, scouring powder, or solvent, such as thinner, benzene, or alcohol.

# Specifications

---

## Wireless LAN section

### Compatible standards:

IEEE 802.11 b/g  
(WEP 64 bit, WEP 128 bit,  
WPA/WPA2-PSK (AES),  
WPA/WPA2-PSK (TKIP))

### Radio frequency:

2.4 GHz

---

## Inputs/Outputs

### AUDIO IN jack:

Stereo mini jack  
Voltage: 1.0 V

### AUDIO OUT (L/R) jacks:

RCA jacks  
Voltage: 1.0 V

### iPod/iPhone dock:

Output voltage: DC 5.0 V  
The maximum output current:  
500 mA

### Network port:

10BASE-T/100BASE-TX

---

## General

### Power requirements:

AC power adaptor  
Input: 120 V AC, 60 Hz  
Output: DC 6 V 800 mA

### Power consumption:

Approx. 2.5 watts at the  
network standby - on mode  
0.5 watts or lower at the  
network standby - off mode

### Dimensions (w/h/d) (including projecting parts and controls) (approx.):

225 mm × 78 mm × 133 mm  
(8 <sup>7</sup>/<sub>8</sub> in. × 3 <sup>1</sup>/<sub>8</sub> in. × 5 <sup>1</sup>/<sub>4</sub> in.)

### Mass (approx.):

500 g (1.1 lb)

### Operating temperature:

+5 °C to +35 °C (+41 °F to  
+95 °F)

### Operating humidity:

25 % to 80 %

### Supplied accessories:

See page 9.

Design and specifications are  
subject to change without  
notice.

- Standby power consumption:  
0.5 W
- Halogenated flame retardants  
are not used in the certain  
printed wiring boards.

# Compatible iPod/iPhone models

You can use the following iPod/iPhone models on this unit. Update your iPod/iPhone with the latest software before using it.



iPhone



iPhone 3G



iPhone 3GS



iPhone 4

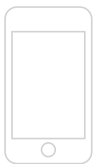

iPod touch  
1st generation



iPod touch  
2nd generation



iPod touch  
3rd generation



iPod touch  
4th generation



iPod  
5th generation  
(video)



iPod classic



iPod nano  
1st generation



iPod nano  
2nd generation  
(aluminum)



iPod nano  
3rd generation  
(video)



iPod nano  
4th generation  
(video)



iPod nano  
5th generation  
(video camera)



iPod nano  
6th generation

“Made for iPod,” and “Made for iPhone” mean that an electronic accessory has been designed to connect specifically to iPod or iPhone, respectively, and has been certified by the developer to meet Apple performance standards.

Apple is not responsible for the operation of this device or its compliance with safety and regulatory standards.

Please note that the use of this accessory with iPod or iPhone may affect wireless performance.

# The menu tree for the settings menu

You can set the various settings using the settings menu. The following menu tree shows an overview of the settings for the settings menu.

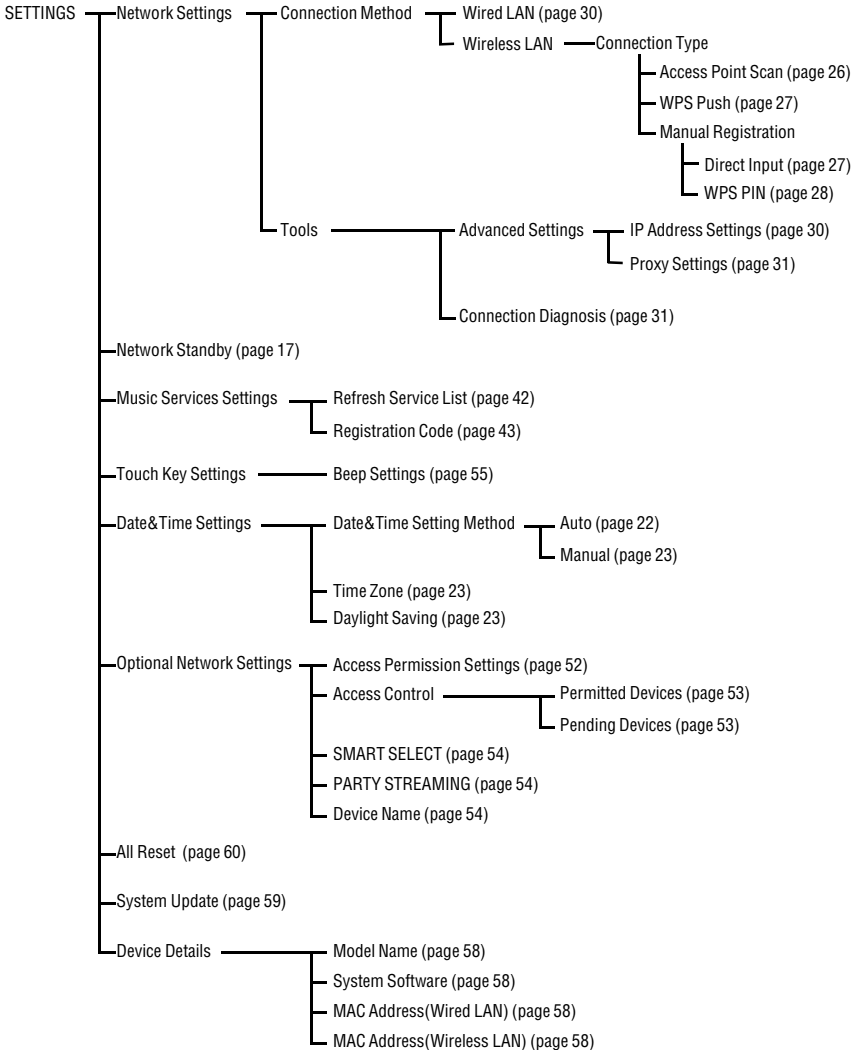



# Glossary

## AAC

Abbreviation for Advanced Audio Coding. It is a standard for audio file compression determined by the MPEG (Motion Picture Experts Group), an ISO (International Organization for Standardization)/IEC (International Electrotechnical Commission) working group.

## Bit rate

The bit rate is a measure of data volume expressed in bits per second (bps).

## Byte

One of the fundamental units used to express digitized data in computers. Digitized data is commonly expressed in binary digits (zeros and ones). A single unit of data is one bit. One byte consists of eight bits.

## Condensation

Condensation can occur in the unit when there is a rapid rise in temperature, as when a heater is turned on. If condensation occurs, keep the unit turned off until the moisture evaporates.

## DHCP

Abbreviation for Dynamic Host Configuration Protocol. A system for automatically allocating configuration data required for an Internet connection.

## DLNA

Abbreviation for Digital Living Network Alliance. The DLNA is a nonprofit organization that establishes design guidelines for digital content shared over networks. For details, see <http://www.dlna.org/home>

## DNS

Abbreviation for Domain Name System. A server that translates domain names to IP addresses, or IP addresses to domain names. A DNS is identified by an IP address. Also called a “DNS server.”

## HE-AAC

Abbreviation for High-Efficiency Advanced Audio Coding. Compare to AAC, it realizes high sound quality with low bit rate.

## Internet Service Provider

A company that offers a connection service to the Internet.

## IP address

IP addresses usually consist of four groups of up to three digits each, separated by a period (such as 192.168.239.1). All devices on a network must have an IP address.

## LAN

Abbreviation for Local Area Network. LAN is a general name for networks set up for communication among devices including computers, printers, and fax machines in relatively small areas such as offices or buildings.

## MAC address

Abbreviation for Media Access Control address. It is an identification name assigned to all network devices. Each device has its own address and there are no duplicate addresses. A MAC address may be necessary when identifying the unit separately from other devices (such as a DLNA server).

## MP3

Abbreviation for MPEG-1 Audio Layer3. It is a standard for audio file compression determined by the MPEG (Motion Picture Experts Group), an ISO (International Organization for Standardization) working group. It enables compression of audio files to about 1/10 of the data size of a standard compact disc. Since the MP3 encoding algorithm is disclosed, there are various encoders/decoders that are compliant with this standard. The MP3 standard is therefore widely used in the computer field.

## Network key (security key)

An encryption key used to limit the devices with which communication can occur. It is used to provide higher security for devices communicating via a wireless LAN router/access point.

## Proxy

A program or a server that provides Internet access to computers within a firewall or quicker downloading of web pages.

## Router

A device that bridges networks, converting the protocols and addresses of each network. When connecting multiple network devices to the Internet, a router is necessary. The term “router” by itself may refer to any of these devices.

## SSID

Abbreviation for Service Set Identifier. It is a name that identifies a particular access point within an IEEE 802.11 wireless LAN. To connect with an access point, a client device must be set with the same SSID. SSIDs can be up to 32 characters long. For higher security, a network key is normally also used. In this case, connection cannot occur unless the SSID matches the network key.

## **WEP**

Abbreviation for Wired Equivalent Privacy. An encryption key used in wireless LAN networks. As an IEEE standard based on RC4 algorithm cryptography, WEP is used to secure IEEE 802.11b wireless networks. During the transmission of a message between a wireless LAN access point and a client device, the sending side encrypts the data and the receiving side decrypts it. For communication to occur, both devices must use a common code key, which is called the “WEP key.” The encryption level is indicated by the bit count of the key; e.g., 64 bits or 128 bits. The higher the bit count, the higher the security level.

## **WMA**

Abbreviation for Windows Media Audio. WMA is audio compression technology developed by Microsoft Corporation that allows audio files to be compressed to about 1/22 of the data size of a standard compact disc.

## **WPA**

Abbreviation for Wi-Fi Protected Access. An encryption standard for wireless LAN networks created by the Wi-Fi Alliance to remedy a number of serious security problems in the WEP system. In addition to the network name (SSID) and encryption key (WEP), this protocol uses a user authentication framework called “EAP” (Extensible Authentication Protocol) and a protocol called “TKIP” (Temporal Key Integrity Protocol) which automatically updates the encryption code at regular intervals for higher security.

## **WPA2**

Abbreviation for Wi-Fi Protected Access 2. An encryption standard for wireless LAN networks. As an upgraded version of WPA created by the Wi-Fi Alliance, this standard uses AES (Advanced Encryption Standard) cryptography to provide stronger security than WPA.

## **WPS**

Abbreviation for Wi-Fi Protected Setup. A wireless network standard created by the Wi-Fi Alliance to allow you to set up a wireless network easily. A push button configuration method and a PIN code method are available.

# Index

## A

- AAC 73
- Access control 53
- Access Permission 52
- Access point 26
- Alphabet search 46
- Amplifier 14, 16, 19, 32
- Audio format 38
- Audio In 44

## C

- Clock 22
- Condensation 73
- Connecting the unit 14
- Connections
  - AC power adaptor 14
  - Amplifier 14
  - Audio In 44
  - DLNA 49
  - Dock Adapters for iPhone
    - models 15
  - Home network 24
  - Wired 29
  - Wireless 25
- Controller 49

## D

- Default gateway 30, 31
- DHCP 73
- DLNA 49, 73
  - Player 49
  - Renderer (network controlled player) 49
  - Server 49
- DNS server 30, 73

## E

- Editing
  - Permitted/Pending devices list 53
  - Server list 40

## F

- Features 8
- Fixed IP address 30
- Format 60
- Function 17

## H

- Home Network function 35
  - Listening 38
  - Optional network settings 52
  - Server setting 35

## I

- Information on the unit 58
- Initial setup 20
- Input level 44
- Internet 22, 41
- IP address 30, 73
- iPod/iPhone 15, 32
  - Charging 34
  - Compatible models 70
  - Dock Adapters for iPhone
    - models 9, 15
  - Listening 32
  - Operation mode 33
  - Remote UI Mode 33

## K

- Keyword 46

## M

- MAC address 53, 58, 73
- Manual setting
  - Access point 26
  - IP address 30
  - Proxy server 31
- Music Services 41
  - Options menu 41
  - Preset 42

## N

- Name of the unit
  - Add 54
  - Check 58
- Network name 25
- Network settings 24
  - Confirm 31
  - Connection method 24
  - Optional settings 52
  - Wired 29
  - Wireless 25
- Network standby 16, 17

## O

- On/standby indicator
  - Abnormal state 61
  - Color 16, 17
- Operating sound 55
- Options menu 17

## P

- Parts and controls 10
- PARTY STREAMING 47
  - Join 48
  - Optional setting 54
  - Start 47
- Pending Devices list 52
- Permitted Devices list 52
- Play mode (repeat/shuffle) 45
- Play Timer 57
- Precautions 68
- Preset
  - Music services 42
- Proxy server 31, 73

## R

- Registration code 43
- Remote control 10
- Remote UI Mode 33

## S

- Security key 73
- Server 35
  - Audio format 38
  - Delete 40
  - List 40
  - Listening 38
  - Refresh 40
  - Windows 7 35
  - Windows Vista/XP 37
- Server list
  - Delete 40
  - Refresh 40
- Settings
  - Access permission 52
  - Clock 22
  - Initial setup 20
  - Network connection 24
  - Optional network settings 52
  - Server 35
  - Sound 55
  - Timer 56
  - Windows 7 35
  - Windows Vista/XP 37
- Settings menu 17
- Sleep Timer 56
- SMART SELECT 53
- Sound sources that can be streamed from the unit 49
- SSID 25, 73
- Standby mode 16, 17
- Subnet mask 30, 31
- Supplied accessories 9
- Support site 61
- System application
  - Checking the firmware version 58
  - Update 59
- System information 58

## T

- Text input 18
- Timer 56
  - Play Timer 57
  - Sleep Timer 56
- Troubleshooting 61

## W

- Wake-on-LAN 38, 49
- WEP 26, 74
- Windows Media Player 11 37
- Windows Media Player 12 35
- Wired network 29
- Wireless LAN signal strength 13
- Wireless network 25
  - Search 25
- WMA 74
- WPA 26, 74, 91
- WPA2 26, 74
- WPS 27, 74
  - PIN code 28
  - Push button 27

# END-USER LICENSE AGREEMENT FOR SONY SOFTWARE

You should carefully read the following agreement before using the SONY SOFTWARE (defined below). Using the SONY SOFTWARE indicates your acceptance of the agreement. If you do not agree with it, you are not authorized to use the SONY SOFTWARE.

**IMPORTANT - READ CAREFULLY:** This End-User License Agreement (“EULA”) is a legal agreement between you and Sony Corporation (“SONY”), the manufacturer of your Sony hardware device (the “PRODUCT”) and the licensor of the SONY SOFTWARE. All Sony software and third party software (other than such software subject to its own separate license) included with your PRODUCT and any updates and upgrades thereto shall be referred to herein as the “SONY SOFTWARE”. You may use the SONY SOFTWARE only with the PRODUCT.

By using the SONY SOFTWARE, you agree to be bound by the terms of this EULA. If you do not agree to the terms of this EULA, SONY is unwilling to license the SONY SOFTWARE to you. In such event, you should not use the SONY SOFTWARE.

## SONY SOFTWARE LICENSE

The SONY SOFTWARE is protected by copyright laws and international copyright treaties, as well as other intellectual property laws and treaties. The SONY SOFTWARE is licensed, not sold.

## GRANT OF LICENSE

All title, copyright and other rights in and to the SONY SOFTWARE are owned by SONY or its licensors. This EULA grants you the right to use the SONY SOFTWARE for personal use only.

## DESCRIPTION OF REQUIREMENTS, RESTRICTIONS, RIGHTS AND LIMITATIONS

**Limitations.** You may not copy, modify, reverse engineer, decompile or disassemble the SONY SOFTWARE in whole or in part.

**Separation of Components.** The SONY SOFTWARE is licensed as a single product. Its component parts may not be separated.

**Use on Single PRODUCT.** The SONY SOFTWARE may only be used with a single PRODUCT.

**Rental.** You may not rent or lease the SONY SOFTWARE.

**Software Transfer.** You may permanently transfer all of your rights under this EULA only when the SONY SOFTWARE is transferred together with and as part of the PRODUCT, provided that you retain no copies, transfer all of the SONY SOFTWARE (including but not limited to all copies, component parts, media, instruction manuals, other printed materials, electronic documents, recovery disks and this EULA) and the recipient agrees to the terms of this EULA.

**Termination.** Without prejudice to any other rights, SONY may terminate this EULA if you fail to comply with the terms of this EULA. In such event, when requested by SONY, you must send the PRODUCT to an address designated by SONY, and SONY will send back the PRODUCT to you as soon as practicable after the SONY SOFTWARE has been deleted from the PRODUCT.

**Confidentiality.** You agree to keep confidential information contained in SONY SOFTWARE which is not publicly known and not to disclose such information to others without SONY’s prior written approval.

## HIGH RISK ACTIVITIES

The SONY SOFTWARE is not fault-tolerant and is not designed, manufactured or intended for use or resale as on-line control equipment in hazardous environments requiring fail-safe performance, such as in the operation of nuclear facilities, aircraft navigation or communication systems, air traffic control, direct life support machines or weapons systems, in which the failure of the SONY SOFTWARE could lead to death, personal injury or severe physical or environmental damage (“High Risk Activities”). SONY and its suppliers specifically disclaim any express or implied warranty of fitness for High Risk Activities.

## EXCLUSION OF WARRANTY ON SONY SOFTWARE

You expressly acknowledge and agree that use of the SONY SOFTWARE is at your sole risk. The SONY SOFTWARE is provided “AS IS” and without warranty of any kind, and SONY, its vendors and SONY’s licensors (for purposes of this SECTION only, collectively, “SONY”) EXPRESSLY DISCLAIM ALL WARRANTIES, EXPRESS OR IMPLIED, INCLUDING BUT NOT LIMITED TO THE IMPLIED WARRANTIES OF MERCHANTABILITY AND FITNESS FOR A PARTICULAR PURPOSE. SONY DOES NOT WARRANT THAT THE FUNCTIONS CONTAINED IN THE SONY SOFTWARE ARE FREE FROM ERRORS OR BUGS OR WILL MEET YOUR REQUIREMENT, AND SONY DOES NOT WARRANT THAT THE OPERATION OF THE SONY SOFTWARE WILL BE CORRECTED. FURTHERMORE, SONY DOES NOT WARRANT OR MAKE ANY REPRESENTATIONS REGARDING THE USE OR THE RESULTS OF THE USE OF THE SONY SOFTWARE IN TERMS OF ITS CORRECTNESS, ACCURACY, RELIABILITY OR OTHERWISE. NO ORAL OR WRITTEN INFORMATION OR ADVICE GIVEN BY SONY OR A

SONY AUTHORIZED REPRESENTATIVE SHALL CREATE A WARRANTY OR IN ANY WAY INCREASE THE SCOPE OF THIS WARRANTY. SOME JURISDICTIONS DO NOT ALLOW THE EXCLUSION OF IMPLIED WARRANTIES, IN WHICH CASE THE ABOVE EXCLUSION WOULD NOT APPLY TO YOU.

Without limiting any of the foregoing, it is specifically provided that the SONY SOFTWARE is not designed or intended for use on any product other than the PRODUCT. SONY provides no warranty that any product, software, content or data created by you or a third party will not be damaged by the SONY SOFTWARE.

### **LIMITATION OF LIABILITY**

SONY, ITS SUPPLIERS AND SONY'S LICENSOR'S (for purposes of this SECTION ONLY, collectively, "SONY") SHALL NOT BE LIABLE FOR ANY INCIDENTAL OR CONSEQUENTIAL DAMAGES RELATING TO THE SONY SOFTWARE ARISING FROM OR BASED ON BREACH OF ANY EXPRESS OR IMPLIED WARRANTY, BREACH OF CONTRACT, NEGLIGENCE, STRICT LIABILITY OR ANY OTHER LEGAL THEORY. SUCH DAMAGES INCLUDE, BUT ARE NOT LIMITED TO, LOSS OF PROFITS, LOSS OF REVENUE, LOSS OF DATA, LOSS OF USE OF THE PRODUCT OR ANY ASSOCIATED EQUIPMENT, DOWN TIME AND USER'S TIME, REGARDLESS OF WHETHER SONY HAS BEEN ADVISED OF THE POSSIBILITY OF SUCH DAMAGES. IN ANY CASE, SONY'S ENTIRE LIABILITY TO YOU UNDER ANY PROVISION OF THIS EULA SHALL BE LIMITED TO THE AMOUNT ACTUALLY PAID ALLOCABLE TO THE SONY SOFTWARE.

### **EXPORTS**

If you use or transfer the SONY SOFTWARE in or to a country other than your country of residence, you shall comply with applicable laws and regulations relating to exports, imports and customs.

### **GOVERNING LAW**

This EULA shall be construed, governed, interpreted and applied in accordance with the laws of Japan, without regards to any conflict of laws provisions. Any dispute arising out of this EULA shall be subject to the exclusive venue and jurisdiction of the courts in Tokyo, Japan, and you and SONY hereby consent to the venue and jurisdiction of such courts. YOU AND SONY WAIVE THE RIGHT TO TRIAL BY JURY WITH RESPECT TO ANY MATTERS ARISING UNDER OR RELATING TO THIS EULA.

### **SEVERABILITY**

If any part of this EULA is held invalid or unenforceable, other parts will remain valid.

Should you have any questions in connection with this EULA or the limited warranty provided hereunder, you may contact SONY by writing to SONY at the designated contact address mentioned in the warranty card included in the product package.

## Important information on software

Included with this product are software applications for which permission for use has been obtained either directly or indirectly by Sony Corporation (hereafter Sony) through a third party. Make sure to read this important information regarding these software applications.

### Information on GNU GPL- and GNU LGPL-compatible software

Included with this product are the following software applications (refer to the following "Package List") that are compatible with GNU General Public License (hereafter GPL) or GNU Lesser General Public License (hereafter LGPL). Users have the right to obtain, modify and redistribute the source code of these software applications in accordance with the attached GPL and LGPL.

---

### Package list

alsa-lib  
alsa-utils  
busybox  
dosfstools  
e2fsprogs  
glibc  
libgcc  
libusb  
linux  
netbase  
nfs-utils  
procps  
pump  
util-linux  
wireless-tools

The source code for these applications is provided by Sony at the following web site. Please go to this web site to obtain the source code.

<http://www.sony.net/Products/Linux/>

Please do not make direct enquiries regarding the source code contents.

---

# GNU GENERAL PUBLIC LICENSE

*Version 2, June 1991*

Copyright (C) 1989, 1991 Free Software Foundation, Inc.  
51 Franklin Street, Fifth Floor, Boston, MA 02110-1301,  
USA

Everyone is permitted to copy and distribute verbatim copies of this license document, but changing it is not allowed.

---

## Preamble

The licenses for most software are designed to take away your freedom to share and change it. By contrast, the GNU General Public License is intended to guarantee your freedom to share and change free software--to make sure the software is free for all its users. This General Public License applies to most of the Free Software Foundation's software and to any other program whose authors commit to using it. (Some other Free Software Foundation software is covered by the GNU Lesser General Public License instead.) You can apply it to your programs, too.

When we speak of free software, we are referring to freedom, not price. Our General Public Licenses are designed to make sure that you have the freedom to distribute copies of free software (and charge for this service if you wish), that you receive source code or can get it if you want it, that you can change the software or use pieces of it in new free programs; and that you know you can do these things.

To protect your rights, we need to make restrictions that forbid anyone to deny you these rights or to ask you to surrender the rights. These restrictions translate to certain responsibilities for you if you distribute copies of the software, or if you modify it.

For example, if you distribute copies of such a program, whether gratis or for a fee, you must give the recipients all the rights that you have. You must make sure that they, too, receive or can get the source code. And you must show them these terms so they know their rights.

We protect your rights with two steps: (1) copyright the software, and (2) offer you this license which gives you legal permission to copy, distribute and/or modify the software.

Also, for each author's protection and ours, we want to make certain that everyone understands that there is no warranty for this free software. If the software is modified by someone else and passed on, we want its recipients to know that what they have is not the original, so that any problems introduced by others will not reflect on the original authors' reputations.

Finally, any free program is threatened constantly by software patents. We wish to avoid the danger that redistributors of a free program will individually obtain patent licenses, in effect making the program proprietary.

To prevent this, we have made it clear that any patent must be licensed for everyone's free use or not licensed at all.

The precise terms and conditions for copying, distribution and modification follow.

---

## TERMS AND CONDITIONS FOR COPYING, DISTRIBUTION AND MODIFICATION

0. This License applies to any program or other work which contains a notice placed by the copyright holder saying it may be distributed under the terms of this General Public License. The "Program", below, refers to any such program or work, and a "work based on the Program" means either the Program or any derivative work under copyright law: that is to say, a work containing the Program or a portion of it, either verbatim or with modifications and/or translated into another language. (Hereinafter, translation is included without limitation in the term "modification".) Each licensee is addressed as "you".

Activities other than copying, distribution and modification are not covered by this License; they are outside its scope. The act of running the Program is not restricted, and the output from the Program is covered only if its contents constitute a work based on the Program (independent of having been made by running the Program). Whether that is true depends on what the Program does.

1. You may copy and distribute verbatim copies of the Program's source code as you receive it, in any medium, provided that you conspicuously and appropriately publish on each copy an appropriate copyright notice and disclaimer of warranty; keep intact all the notices that refer to this License and to the absence of any warranty; and give any other recipients of the Program a copy of this License along with the Program.

You may charge a fee for the physical act of transferring a copy, and you may at your option offer warranty protection in exchange for a fee.

2. You may modify your copy or copies of the Program or any portion of it, thus forming a work based on the Program, and copy and distribute such modifications or work under the terms of Section 1 above, provided that you also meet all of these conditions:

- a) You must cause the modified files to carry prominent notices stating that you changed the files and the date of any change.
- b) You must cause any work that you distribute or publish, that in whole or in part contains or is derived from the Program or any part thereof, to be licensed as a whole at no charge to all third parties under the terms of this License.
- c) If the modified program normally reads commands interactively when run, you must cause it, when started running for such interactive use in the most ordinary way, to print or display an announcement including an appropriate copyright notice and a notice that there is no warranty (or else, saying that



you provide a warranty) and that users may redistribute the program under these conditions, and telling the user how to view a copy of this License. (Exception: if the Program itself is interactive but does not normally print such an announcement, your work based on the Program is not required to print an announcement.)

These requirements apply to the modified work as a whole. If identifiable sections of that work are not derived from the Program, and can be reasonably considered independent and separate works in themselves, then this License, and its terms, do not apply to those sections when you distribute them as separate works. But when you distribute the same sections as part of a whole which is a work based on the Program, the distribution of the whole must be on the terms of this License, whose permissions for other licensees extend to the entire whole, and thus to each and every part regardless of who wrote it.

Thus, it is not the intent of this section to claim rights or contest your rights to work written entirely by you; rather, the intent is to exercise the right to control the distribution of derivative or collective works based on the Program.

In addition, mere aggregation of another work not based on the Program with the Program (or with a work based on the Program) on a volume of a storage or distribution medium does not bring the other work under the scope of this License.

3. You may copy and distribute the Program (or a work based on it, under Section 2) in object code or executable form under the terms of Sections 1 and 2 above provided that you also do one of the following:
  - a) Accompany it with the complete corresponding machine-readable source code, which must be distributed under the terms of Sections 1 and 2 above on a medium customarily used for software interchange; or,
  - b) Accompany it with a written offer, valid for at least three years, to give any third party, for a charge no more than your cost of physically performing source distribution, a complete machine-readable copy of the corresponding source code, to be distributed under the terms of Sections 1 and 2 above on a medium customarily used for software interchange; or,
  - c) Accompany it with the information you received as to the offer to distribute corresponding source code. (This alternative is allowed only for noncommercial distribution and only if you received the program in object code or executable form with such an offer, in accord with Subsection b above.)

The source code for a work means the preferred form of the work for making modifications to it. For an executable work, complete source code means all the source code for all modules it contains, plus any associated interface definition files, plus the scripts used to control compilation and installation of the executable. However, as a special exception, the source code distributed need not include anything that is normally distributed (in either source or binary form) with the major components (compiler, kernel, and so on) of the operating system on which the executable runs, unless that component itself accompanies the executable.

If distribution of executable or object code is made by offering access to copy from a designated place, then offering equivalent access to copy the source code from the same place counts as distribution of the source code, even though third parties are not compelled to copy the source along with the object code.

4. You may not copy, modify, sublicense, or distribute the Program except as expressly provided under this License. Any attempt otherwise to copy, modify, sublicense or distribute the Program is void, and will automatically terminate your rights under this License. However, parties who have received copies, or rights, from you under this License will not have their licenses terminated so long as such parties remain in full compliance.
5. You are not required to accept this License, since you have not signed it. However, nothing else grants you permission to modify or distribute the Program or its derivative works. These actions are prohibited by law if you do not accept this License. Therefore, by modifying or distributing the Program (or any work based on the Program), you indicate your acceptance of this License to do so, and all its terms and conditions for copying, distributing or modifying the Program or works based on it.
6. Each time you redistribute the Program (or any work based on the Program), the recipient automatically receives a license from the original licensor to copy, distribute or modify the Program subject to these terms and conditions. You may not impose any further restrictions on the recipients' exercise of the rights granted herein. You are not responsible for enforcing compliance by third parties to this License.
7. If, as a consequence of a court judgment or allegation of patent infringement or for any other reason (not limited to patent issues), conditions are imposed on you (whether by court order, agreement or otherwise) that contradict the conditions of this License, they do not excuse you from the conditions of this License. If you cannot distribute so as to satisfy simultaneously your obligations under this License and any other pertinent obligations, then as a consequence you may not distribute the Program at all. For example, if a patent license would not permit royalty-free redistribution of the Program by all those who receive copies directly or indirectly through you, then the only way you could satisfy both it and this License would be to refrain entirely from distribution of the Program.

If any portion of this section is held invalid or unenforceable under any particular circumstance, the balance of the section is intended to apply and the section as a whole is intended to apply in other circumstances.

It is not the purpose of this section to induce you to infringe any patents or other property right claims or to contest validity of any such claims; this section has the sole purpose of protecting the integrity of the free software distribution system, which is implemented by public license practices. Many people have made generous contributions to the wide range of software distributed through that system in reliance on consistent application of that system; it is up to the author/donor to decide if he

or she is willing to distribute software through any other system and a licensee cannot impose that choice.

This section is intended to make thoroughly clear what is believed to be a consequence of the rest of this License.

8. If the distribution and/or use of the Program is restricted in certain countries either by patents or by copyrighted interfaces, the original copyright holder who places the Program under this License may add an explicit geographical distribution limitation excluding those countries, so that distribution is permitted only in or among countries not thus excluded. In such case, this License incorporates the limitation as if written in the body of this License.
9. The Free Software Foundation may publish revised and/or new versions of the General Public License from time to time. Such new versions will be similar in spirit to the present version, but may differ in detail to address new problems or concerns.

Each version is given a distinguishing version number. If the Program specifies a version number of this License which applies to it and “any later version”, you have the option of following the terms and conditions either of that version or of any later version published by the Free Software Foundation. If the Program does not specify a version number of this License, you may choose any version ever published by the Free Software Foundation.

10. If you wish to incorporate parts of the Program into other free programs whose distribution conditions are different, write to the author to ask for permission. For software which is copyrighted by the Free Software Foundation, write to the Free Software Foundation; we sometimes make exceptions for this. Our decision will be guided by the two goals of preserving the free status of all derivatives of our free software and of promoting the sharing and reuse of software generally.

## NO WARRANTY

11. BECAUSE THE PROGRAM IS LICENSED FREE OF CHARGE, THERE IS NO WARRANTY FOR THE PROGRAM, TO THE EXTENT PERMITTED BY APPLICABLE LAW. EXCEPT WHEN OTHERWISE STATED IN WRITING THE COPYRIGHT HOLDERS AND/OR OTHER PARTIES PROVIDE THE PROGRAM “AS IS” WITHOUT WARRANTY OF ANY KIND, EITHER EXPRESSED OR IMPLIED, INCLUDING, BUT NOT LIMITED TO, THE IMPLIED WARRANTIES OF MERCHANTABILITY AND FITNESS FOR A PARTICULAR PURPOSE. THE ENTIRE RISK AS TO THE QUALITY AND PERFORMANCE OF THE PROGRAM IS WITH YOU. SHOULD THE PROGRAM PROVE DEFECTIVE, YOU ASSUME THE COST OF ALL NECESSARY SERVICING, REPAIR OR CORRECTION.
12. IN NO EVENT UNLESS REQUIRED BY APPLICABLE LAW OR AGREED TO IN WRITING WILL ANY COPYRIGHT HOLDER, OR ANY OTHER PARTY WHO MAY MODIFY AND/OR REDISTRIBUTE THE PROGRAM AS PERMITTED ABOVE, BE LIABLE TO YOU FOR DAMAGES, INCLUDING ANY GENERAL, SPECIAL,

INCIDENTAL OR CONSEQUENTIAL DAMAGES ARISING OUT OF THE USE OR INABILITY TO USE THE PROGRAM (INCLUDING BUT NOT LIMITED TO LOSS OF DATA OR DATA BEING RENDERED INACCURATE OR LOSSES SUSTAINED BY YOU OR THIRD PARTIES OR A FAILURE OF THE PROGRAM TO OPERATE WITH ANY OTHER PROGRAMS), EVEN IF SUCH HOLDER OR OTHER PARTY HAS BEEN ADVISED OF THE POSSIBILITY OF SUCH DAMAGES.

---

## END OF TERMS AND CONDITIONS

---

### How to Apply These Terms to Your New Programs

If you develop a new program, and you want it to be of the greatest possible use to the public, the best way to achieve this is to make it free software which everyone can redistribute and change under these terms.

To do so, attach the following notices to the program. It is safest to attach them to the start of each source file to most effectively convey the exclusion of warranty; and each file should have at least the “copyright” line and a pointer to where the full notice is found.

#### Copyright (C)

This program is free software; you can redistribute it and/or modify it under the terms of the GNU General Public License as published by the Free Software Foundation; either version 2 of the License, or (at your option) any later version.

This program is distributed in the hope that it will be useful, but WITHOUT ANY WARRANTY; without even the implied warranty of MERCHANTABILITY or FITNESS FOR A PARTICULAR PURPOSE. See the GNU General Public License for more details.

You should have received a copy of the GNU General Public License along with this program; if not, write to the Free Software Foundation, Inc., 51 Franklin Street, Fifth Floor, Boston, MA 02110-1301, USA

Also add information on how to contact you by electronic and paper mail.

If the program is interactive, make it output a short notice like this when it starts in an interactive mode:

```
Gnomovision version 69, Copyright (C) year name of
author Gnomovision comes with ABSOLUTELY NO
WARRANTY; for details type `show w'. This is free
software, and you are welcome to redistribute it under
certain conditions; type `show c' for details.
```

The hypothetical commands `show w' and `show c' should show the appropriate parts of the General Public

License. Of course, the commands you use may be called something other than `show w` and `show c`; they could even be mouse-clicks or menu items--whatever suits your program.

You should also get your employer (if you work as a programmer) or your school, if any, to sign a "copyright disclaimer" for the program, if necessary. Here is a sample; alter the names:

Yoyodyne, Inc., hereby disclaims all copyright interest in the program 'Gnomovision' (which makes passes at compilers) written by James Hacker.

<signature of TyCoon>, 1 April 1989 Ty Coon,  
President of Vice

This General Public License does not permit incorporating your program into proprietary programs. If your program is a subroutine library, you may consider it more useful to permit linking proprietary applications with the library. If this is what you want to do, use the GNU Lesser General Public License instead of this License.

---

# GNU LESSER GENERAL PUBLIC LICENSE

## *Version 2.1, February 1999*

Copyright (C) 1991, 1999 Free Software Foundation, Inc. 51 Franklin Street, Fifth Floor, Boston, MA 02110-1301, USA Everyone is permitted to copy and distribute verbatim copies of this license document, but changing it is not allowed.

[This is the first released version of the Lesser GPL. It also counts as the successor of the GNU Library Public License, version 2, hence the version number 2.1.]

---

## Preamble

The licenses for most software are designed to take away your freedom to share and change it. By contrast, the GNU General Public Licenses are intended to guarantee your freedom to share and change free software--to make sure the software is free for all its users.

This license, the Lesser General Public License, applies to some specially designated software packages--typically libraries--of the Free Software Foundation and other authors who decide to use it. You can use it too, but we suggest you first think carefully about whether this license or the ordinary General Public License is the better strategy to use in any particular case, based on the explanations below.

When we speak of free software, we are referring to freedom of use, not price. Our General Public Licenses are designed to make sure that you have the freedom to distribute copies of free software (and charge for this service if you wish); that you receive source code or can get it if you want it; that you can change the software and use pieces of it in new free programs; and that you are informed that you can do these things.

To protect your rights, we need to make restrictions that forbid distributors to deny you these rights or to ask you to surrender these rights. These restrictions translate to certain responsibilities for you if you distribute copies of the library or if you modify it.

For example, if you distribute copies of the library, whether gratis or for a fee, you must give the recipients all the rights that we gave you. You must make sure that they, too, receive or can get the source code. If you link other code with the library, you must provide complete object files to the recipients, so that they can relink them with the library after making changes to the library and recompiling it. And you must show them these terms so they know their rights.

We protect your rights with a two-step method: (1) we copyright the library, and (2) we offer you this license, which gives you legal permission to copy, distribute and/or modify the library.

To protect each distributor, we want to make it very clear that there is no warranty for the free library. Also, if the library is modified by someone else and passed on, the

recipients should know that what they have is not the original version, so that the original author's reputation will not be affected by problems that might be introduced by others.

Finally, software patents pose a constant threat to the existence of any free program. We wish to make sure that a company cannot effectively restrict the users of a free program by obtaining a restrictive license from a patent holder. Therefore, we insist that any patent license obtained for a version of the library must be consistent with the full freedom of use specified in this license.

Most GNU software, including some libraries, is covered by the ordinary GNU General Public License. This license, the GNU Lesser General Public License, applies to certain designated libraries, and is quite different from the ordinary General Public License. We use this license for certain libraries in order to permit linking those libraries into non-free programs.

When a program is linked with a library, whether statically or using a shared library, the combination of the two is legally speaking a combined work, a derivative of the original library. The ordinary General Public License therefore permits such linking only if the entire combination fits its criteria of freedom. The Lesser General Public License permits more lax criteria for linking other code with the library.

We call this license the "Lesser" General Public License because it does Less to protect the user's freedom than the ordinary General Public License. It also provides other free software developers Less of an advantage over competing non-free programs. These disadvantages are the reason we use the ordinary General Public License for many libraries. However, the Lesser license provides advantages in certain special circumstances.

For example, on rare occasions, there may be a special need to encourage the widest possible use of a certain library, so that it becomes a de-facto standard. To achieve this, non-free programs must be allowed to use the library. A more frequent case is that a free library does the same job as widely used non-free libraries. In this case, there is little to gain by limiting the free library to free software only, so we use the Lesser General Public License.

In other cases, permission to use a particular library in non-free programs enables a greater number of people to use a large body of free software. For example, permission to use the GNU C Library in non-free programs enables many more people to use the whole GNU operating system, as well as its variant, the GNU/Linux operating system.

Although the Lesser General Public License is Less protective of the users' freedom, it does ensure that the user of a program that is linked with the Library has the freedom and the wherewithal to run that program using a modified version of the Library.

The precise terms and conditions for copying, distribution and modification follow. Pay close attention to the difference between a "work based on the library" and a "work that uses the library". The former contains code derived from the library, whereas the latter must be combined with the library in order to run.

---

## TERMS AND CONDITIONS FOR COPYING, DISTRIBUTION AND MODIFICATION

0. This License Agreement applies to any software library or other program which contains a notice placed by the copyright holder or other authorized party saying it may be distributed under the terms of this Lesser General Public License (also called "this License"). Each licensee is addressed as "you".

A "library" means a collection of software functions and/or data prepared so as to be conveniently linked with application programs (which use some of those functions and data) to form executables.

The "Library", below, refers to any such software library or work which has been distributed under these terms. A "work based on the Library" means either the Library or any derivative work under copyright law: that is to say, a work containing the Library or a portion of it, either verbatim or with modifications and/or translated straightforwardly into another language. (Hereinafter, translation is included without limitation in the term "modification".)

"Source code" for a work means the preferred form of the work for making modifications to it. For a library, complete source code means all the source code for all modules it contains, plus any associated interface definition files, plus the scripts used to control compilation and installation of the library.

Activities other than copying, distribution and modification are not covered by this License; they are outside its scope. The act of running a program using the Library is not restricted, and output from such a program is covered only if its contents constitute a work based on the Library (independent of the use of the Library in a tool for writing it). Whether that is true depends on what the Library does and what the program that uses the Library does.

1. You may copy and distribute verbatim copies of the Library's complete source code as you receive it, in any medium, provided that you conspicuously and appropriately publish on each copy an appropriate copyright notice and disclaimer of warranty; keep intact all the notices that refer to this License and to the absence of any warranty; and distribute a copy of this License along with the Library.

You may charge a fee for the physical act of transferring a copy, and you may at your option offer warranty protection in exchange for a fee.

2. You may modify your copy or copies of the Library or any portion of it, thus forming a work based on the Library, and copy and distribute such modifications or work under the terms of Section 1 above, provided that you also meet all of these conditions:

- The modified work must itself be a software library.
- You must cause the files modified to carry prominent notices stating that you changed the files and the date of any change.

- c) You must cause the whole of the work to be licensed at no charge to all third parties under the terms of this License.
- d) If a facility in the modified Library refers to a function or a table of data to be supplied by an application program that uses the facility, other than as an argument passed when the facility is invoked, then you must make a good faith effort to ensure that, in the event an application does not supply such function or table, the facility still operates, and performs whatever part of its purpose remains meaningful.

(For example, a function in a library to compute square roots has a purpose that is entirely well-defined independent of the application. Therefore, Subsection 2d requires that any application-supplied function or table used by this function must be optional: if the application does not supply it, the square root function must still compute square roots.)

These requirements apply to the modified work as a whole. If identifiable sections of that work are not derived from the Library, and can be reasonably considered independent and separate works in themselves, then this License, and its terms, do not apply to those sections when you distribute them as separate works. But when you distribute the same sections as part of a whole which is a work based on the Library, the distribution of the whole must be on the terms of this License, whose permissions for other licensees extend to the entire whole, and thus to each and every part regardless of who wrote it.

Thus, it is not the intent of this section to claim rights or contest your rights to work written entirely by you; rather, the intent is to exercise the right to control the distribution of derivative or collective works based on the Library.

In addition, mere aggregation of another work not based on the Library with the Library (or with a work based on the Library) on a volume of a storage or distribution medium does not bring the other work under the scope of this License.

- 3. You may opt to apply the terms of the ordinary GNU General Public License instead of this License to a given copy of the Library. To do this, you must alter all the notices that refer to this License, so that they refer to the ordinary GNU General Public License, version 2, instead of to this License. (If a newer version than version 2 of the ordinary GNU General Public License has appeared, then you can specify that version instead if you wish.) Do not make any other change in these notices.

Once this change is made in a given copy, it is irreversible for that copy, so the ordinary GNU General Public License applies to all subsequent copies and derivative works made from that copy.

This option is useful when you wish to copy part of the code of the Library into a program that is not a library.

- 4. You may copy and distribute the Library (or a portion or derivative of it, under Section 2) in object code or executable form under the terms of Sections 1 and 2 above provided that you accompany it with the

complete corresponding machine-readable source code, which must be distributed under the terms of Sections 1 and 2 above on a medium customarily used for software interchange.

If distribution of object code is made by offering access to copy from a designated place, then offering equivalent access to copy the source code from the same place satisfies the requirement to distribute the source code, even though third parties are not compelled to copy the source along with the object code.

- 5. A program that contains no derivative of any portion of the Library, but is designed to work with the Library by being compiled or linked with it, is called a “work that uses the Library”. Such a work, in isolation, is not a derivative work of the Library, and therefore falls outside the scope of this License.

However, linking a “work that uses the Library” with the Library creates an executable that is a derivative of the Library (because it contains portions of the Library), rather than a “work that uses the library”. The executable is therefore covered by this License. Section 6 states terms for distribution of such executables.

When a “work that uses the Library” uses material from a header file that is part of the Library, the object code for the work may be a derivative work of the Library even though the source code is not. Whether this is true is especially significant if the work can be linked without the Library, or if the work is itself a library. The threshold for this to be true is not precisely defined by law.

If such an object file uses only numerical parameters, data structure layouts and accessors, and small macros and small inline functions (ten lines or less in length), then the use of the object file is unrestricted, regardless of whether it is legally a derivative work. (Executables containing this object code plus portions of the Library will still fall under Section 6.)

Otherwise, if the work is a derivative of the Library, you may distribute the object code for the work under the terms of Section 6. Any executables containing that work also fall under Section 6, whether or not they are linked directly with the Library itself.

- 6. As an exception to the Sections above, you may also combine or link a “work that uses the Library” with the Library to produce a work containing portions of the Library, and distribute that work under terms of your choice, provided that the terms permit modification of the work for the customer’s own use and reverse engineering for debugging such modifications.

You must give prominent notice with each copy of the work that the Library is used in it and that the Library and its use are covered by this License. You must supply a copy of this License. If the work during execution displays copyright notices, you must include the copyright notice for the Library among them, as well as a reference directing the user to the copy of this License. Also, you must do one of these things:

- a) Accompany the work with the complete corresponding machine-readable source code for the Library including whatever changes were used in the work (which must be distributed under Sections

- 1 and 2 above); and, if the work is an executable linked with the Library, with the complete machine-readable “work that uses the Library”, as object code and/or source code, so that the user can modify the Library and then relink to produce a modified executable containing the modified Library. (It is understood that the user who changes the contents of definitions files in the Library will not necessarily be able to recompile the application to use the modified definitions.)
- b) Use a suitable shared library mechanism for linking with the Library. A suitable mechanism is one that
    - (1) uses at run time a copy of the library already present on the user’s computer system, rather than copying library functions into the executable, and
    - (2) will operate properly with a modified version of the library, if the user installs one, as long as the modified version is interface-compatible with the version that the work was made with.
  - c) Accompany the work with a written offer, valid for at least three years, to give the same user the materials specified in Subsection 6a, above, for a charge no more than the cost of performing this distribution.
  - d) If distribution of the work is made by offering access to copy from a designated place, offer equivalent access to copy the above specified materials from the same place.
  - e) Verify that the user has already received a copy of these materials or that you have already sent this user a copy.

For an executable, the required form of the “work that uses the Library” must include any data and utility programs needed for reproducing the executable from it. However, as a special exception, the materials to be distributed need not include anything that is normally distributed (in either source or binary form) with the major components (compiler, kernel, and so on) of the operating system on which the executable runs, unless that component itself accompanies the executable.

It may happen that this requirement contradicts the license restrictions of other proprietary libraries that do not normally accompany the operating system. Such a contradiction means you cannot use both them and the Library together in an executable that you distribute.

7. You may place library facilities that are a work based on the Library side-by-side in a single library together with other library facilities not covered by this License, and distribute such a combined library, provided that the separate distribution of the work based on the Library and of the other library facilities is otherwise permitted, and provided that you do these two things:
  - a) Accompany the combined library with a copy of the same work based on the Library, uncombined with any other library facilities. This must be distributed under the terms of the Sections above.
  - b) Give prominent notice with the combined library of the fact that part of it is a work based on the Library, and explaining where to find the accompanying uncombined form of the same work.
8. You may not copy, modify, sublicense, link with, or distribute the Library except as expressly provided under this License. Any attempt otherwise to copy,

modify, sublicense, link with, or distribute the Library is void, and will automatically terminate your rights under this License. However, parties who have received copies, or rights, from you under this License will not have their licenses terminated so long as such parties remain in full compliance.

9. You are not required to accept this License, since you have not signed it. However, nothing else grants you permission to modify or distribute the Library or its derivative works. These actions are prohibited by law if you do not accept this License. Therefore, by modifying or distributing the Library (or any work based on the Library), you indicate your acceptance of this License to do so, and all its terms and conditions for copying, distributing or modifying the Library or works based on it.
10. Each time you redistribute the Library (or any work based on the Library), the recipient automatically receives a license from the original licensor to copy, distribute, link with or modify the Library subject to these terms and conditions. You may not impose any further restrictions on the recipients’ exercise of the rights granted herein. You are not responsible for enforcing compliance by third parties with this License.
11. If, as a consequence of a court judgment or allegation of patent infringement or for any other reason (not limited to patent issues), conditions are imposed on you (whether by court order, agreement or otherwise) that contradict the conditions of this License, they do not excuse you from the conditions of this License. If you cannot distribute so as to satisfy simultaneously your obligations under this License and any other pertinent obligations, then as a consequence you may not distribute the Library at all. For example, if a patent license would not permit royalty-free redistribution of the Library by all those who receive copies directly or indirectly through you, then the only way you could satisfy both it and this License would be to refrain entirely from distribution of the Library.

If any portion of this section is held invalid or unenforceable under any particular circumstance, the balance of the section is intended to apply, and the section as a whole is intended to apply in other circumstances.

It is not the purpose of this section to induce you to infringe any patents or other property right claims or to contest validity of any such claims; this section has the sole purpose of protecting the integrity of the free software distribution system which is implemented by public license practices. Many people have made generous contributions to the wide range of software distributed through that system in reliance on consistent application of that system; it is up to the author/donor to decide if he or she is willing to distribute software through any other system and a licensee cannot impose that choice.

This section is intended to make thoroughly clear what is believed to be a consequence of the rest of this License.

12. If the distribution and/or use of the Library is restricted in certain countries either by patents or by copyrighted interfaces, the original copyright holder who places the Library under this License may add an explicit

geographical distribution limitation excluding those countries, so that distribution is permitted only in or among countries not thus excluded. In such case, this License incorporates the limitation as if written in the body of this License.

13. The Free Software Foundation may publish revised and/or new versions of the Lesser General Public License from time to time. Such new versions will be similar in spirit to the present version, but may differ in detail to address new problems or concerns.

Each version is given a distinguishing version number. If the Library specifies a version number of this License which applies to it and “any later version”, you have the option of following the terms and conditions either of that version or of any later version published by the Free Software Foundation. If the Library does not specify a license version number, you may choose any version ever published by the Free Software Foundation.

14. If you wish to incorporate parts of the Library into other free programs whose distribution conditions are incompatible with these, write to the author to ask for permission. For software which is copyrighted by the Free Software Foundation, write to the Free Software Foundation; we sometimes make exceptions for this. Our decision will be guided by the two goals of preserving the free status of all derivatives of our free software and of promoting the sharing and reuse of software generally.

## NO WARRANTY

15. BECAUSE THE LIBRARY IS LICENSED FREE OF CHARGE, THERE IS NO WARRANTY FOR THE LIBRARY, TO THE EXTENT PERMITTED BY APPLICABLE LAW. EXCEPT WHEN OTHERWISE STATED IN WRITING THE COPYRIGHT HOLDERS AND/OR OTHER PARTIES PROVIDE THE LIBRARY “AS IS” WITHOUT WARRANTY OF ANY KIND, EITHER EXPRESSED OR IMPLIED, INCLUDING, BUT NOT LIMITED TO, THE IMPLIED WARRANTIES OF MERCHANTABILITY AND FITNESS FOR A PARTICULAR PURPOSE. THE ENTIRE RISK AS TO THE QUALITY AND PERFORMANCE OF THE LIBRARY IS WITH YOU. SHOULD THE LIBRARY PROVE DEFECTIVE, YOU ASSUME THE COST OF ALL NECESSARY SERVICING, REPAIR OR CORRECTION.
16. IN NO EVENT UNLESS REQUIRED BY APPLICABLE LAW OR AGREED TO IN WRITING WILL ANY COPYRIGHT HOLDER, OR ANY OTHER PARTY WHO MAY MODIFY AND/OR REDISTRIBUTE THE LIBRARY AS PERMITTED ABOVE, BE LIABLE TO YOU FOR DAMAGES, INCLUDING ANY GENERAL, SPECIAL, INCIDENTAL OR CONSEQUENTIAL DAMAGES ARISING OUT OF THE USE OR INABILITY TO USE THE LIBRARY (INCLUDING BUT NOT LIMITED TO LOSS OF DATA OR DATA BEING RENDERED INACCURATE OR LOSSES SUSTAINED BY YOU OR THIRD PARTIES OR A FAILURE OF THE LIBRARY TO OPERATE WITH ANY OTHER SOFTWARE), EVEN IF SUCH

HOLDER OR OTHER PARTY HAS BEEN ADVISED OF THE POSSIBILITY OF SUCH DAMAGES.

---

## END OF TERMS AND CONDITIONS

---

### How to Apply These Terms to Your New Libraries

If you develop a new library, and you want it to be of the greatest possible use to the public, we recommend making it free software that everyone can redistribute and change. You can do so by permitting redistribution under these terms (or, alternatively, under the terms of the ordinary General Public License).

To apply these terms, attach the following notices to the library. It is safest to attach them to the start of each source file to most effectively convey the exclusion of warranty; and each file should have at least the “copyright” line and a pointer to where the full notice is found.

<one line to give the library’s name and an idea of what it does.> Copyright (C) <year> <name of author>

This library is free software; you can redistribute it and/or modify it under the terms of the GNU Lesser General Public License as published by the Free Software Foundation; either version 2.1 of the License, or (at your option) any later version.

This library is distributed in the hope that it will be useful, but WITHOUT ANY WARRANTY; without even the implied warranty of MERCHANTABILITY or FITNESS FOR A PARTICULAR PURPOSE. See the GNU Lesser General Public License for more details.

You should have received a copy of the GNU Lesser General Public License along with this library; if not, write to the Free Software Foundation, Inc., 51 Franklin Street, Fifth Floor, Boston, MA 02110-1301, USA Also add information on how to contact you by electronic and paper mail.

You should also get your employer (if you work as a programmer) or your school, if any, to sign a “copyright disclaimer” for the library, if necessary. Here is a sample; alter the names:

Yoyodyne, Inc., hereby disclaims all copyright interest in the library ‘Frob’ (a library for tweaking knobs) written by James Random Hacker.

signature of Ty Coon, 1 April 1990 Ty Coon,  
President of Vice

That’s all there is to it!

---

## Notice regarding other third-party software

This product contains the following software applications for which Sony has been licensed either directly or indirectly by third parties.

1. OpenSSL (including the library called “Original SSLeay”)
2. libcurl
3. libjpeg
4. libpng
5. ncurses
6. ntp
7. zlib
8. Expat
9. NetBSD
10. libcap

By request of the copyright holders of these software applications, Sony provides our customers with the following notice.

### 1. OpenSSL

Copyright (c) 1998 - 2007 The OpenSSL Project. All rights reserved.

Copyright (c) 1995-1998 Eric Young (eay@cryptsoft.com) All rights reserved.

This product includes software developed by the OpenSSL.

Project for use in the OpenSSL Toolkit (<http://www.openssl.org/>).

### OpenSSL License

Redistribution and use in source and binary forms, with or without modification, are permitted provided that the following conditions are met:

1. Redistributions of source code must retain the above copyright notice, this list of conditions and the following disclaimer.
2. Redistributions in binary form must reproduce the above copyright notice, this list of conditions and the following disclaimer in the documentation and/or other materials provided with the distribution.
3. All advertising materials mentioning features or use of this software must display the following acknowledgement:  
“This product includes software developed by the OpenSSL Project for use in the OpenSSL Toolkit. (<http://www.openssl.org/>)”
4. The names “OpenSSL Toolkit” and “OpenSSL Project” must not be used to endorse or promote products derived from this software without prior written permission. For written permission, please contact [openssl-core@openssl.org](mailto:openssl-core@openssl.org).
5. Products derived from this software may not be called “OpenSSL” nor may “OpenSSL” appear in their names without prior written permission of the OpenSSL Project.
6. Redistributions of any form whatsoever must retain the following acknowledgement:  
“This product includes software developed by the OpenSSL Project for use in the OpenSSL Toolkit (<http://www.openssl.org/>)”

THIS SOFTWARE IS PROVIDED BY THE OpenSSL PROJECT “AS IS” AND ANY EXPRESSED OR IMPLIED WARRANTIES, INCLUDING, BUT NOT LIMITED TO, THE IMPLIED WARRANTIES OF MERCHANTABILITY AND FITNESS FOR A PARTICULAR PURPOSE ARE DISCLAIMED. IN NO EVENT SHALL THE OpenSSL PROJECT OR ITS CONTRIBUTORS BE LIABLE FOR ANY DIRECT, INDIRECT, INCIDENTAL, SPECIAL, EXEMPLARY, OR CONSEQUENTIAL DAMAGES (INCLUDING, BUT NOT LIMITED TO, PROCUREMENT OF SUBSTITUTE GOODS OR SERVICES; LOSS OF USE, DATA, OR PROFITS; OR BUSINESS INTERRUPTION) HOWEVER CAUSED AND ON ANY THEORY OF LIABILITY, WHETHER IN CONTRACT, STRICT LIABILITY, OR TORT (INCLUDING NEGLIGENCE OR OTHERWISE) ARISING IN ANY WAY OUT OF THE USE OF THIS SOFTWARE, EVEN IF ADVISED OF THE POSSIBILITY OF SUCH DAMAGE.

### Original SSLeay License

Redistribution and use in source and binary forms, with or without modification, are permitted provided that the following conditions are met:

1. Redistributions of source code must retain the copyright notice, this list of conditions and the following disclaimer.
2. Redistributions in binary form must reproduce the above copyright notice, this list of conditions and the following disclaimer in the documentation and/or other materials provided with the distribution.
3. All advertising materials mentioning features or use of this software must display the following acknowledgement:  
“This product includes cryptographic software written by Eric Young (eay@cryptsoft.com)” The word “cryptographic” can be left out if the routines from the library being used are not cryptographic related (-).
4. If you include any Windows specific code (or a derivative thereof) from the apps directory (application code) you must include an acknowledgement:  
“This product includes software written by Tim Hudson (tjh@cryptsoft.com)”

THIS SOFTWARE IS PROVIDED BY ERIC YOUNG “AS IS” AND ANY EXPRESS OR IMPLIED WARRANTIES, INCLUDING, BUT NOT LIMITED TO, THE IMPLIED WARRANTIES OF MERCHANTABILITY AND FITNESS FOR A PARTICULAR PURPOSE ARE DISCLAIMED. IN NO EVENT SHALL THE AUTHOR OR CONTRIBUTORS BE LIABLE FOR ANY DIRECT, INDIRECT, INCIDENTAL, SPECIAL, EXEMPLARY, OR CONSEQUENTIAL DAMAGES (INCLUDING, BUT NOT LIMITED TO, PROCUREMENT OF SUBSTITUTE GOODS OR SERVICES; LOSS OF USE, DATA, OR PROFITS; OR BUSINESS INTERRUPTION) HOWEVER CAUSED AND ON ANY THEORY OF LIABILITY, WHETHER IN CONTRACT, STRICT LIABILITY, OR TORT (INCLUDING NEGLIGENCE OR OTHERWISE) ARISING IN ANY WAY OUT OF THE USE OF THIS



SOFTWARE, EVEN IF ADVISED OF THE POSSIBILITY OF SUCH DAMAGE.

## 2. libcurl

### COPYRIGHT AND PERMISSION NOTICE

Copyright (c) 1996 - 2008, Daniel Stenberg,  
<daniel@haxx.se>.  
All rights reserved.

Permission to use, copy, modify, and distribute this software for any purpose with or without fee is hereby granted, provided that the above copyright notice and this permission notice appear in all copies.

THE SOFTWARE IS PROVIDED "AS IS", WITHOUT WARRANTY OF ANY KIND, EXPRESS OR IMPLIED, INCLUDING BUT NOT LIMITED TO THE WARRANTIES OF MERCHANTABILITY, FITNESS FOR A PARTICULAR PURPOSE AND NONINFRINGEMENT OF THIRD PARTY RIGHTS. IN NO EVENT SHALL THE AUTHORS OR COPYRIGHT HOLDERS BE LIABLE FOR ANY CLAIM, DAMAGES OR OTHER LIABILITY, WHETHER IN AN ACTION OF CONTRACT, TORT OR OTHERWISE, ARISING FROM, OUT OF OR IN CONNECTION WITH THE SOFTWARE OR THE USE OR OTHER DEALINGS IN THE SOFTWARE.

Except as contained in this notice, the name of a copyright holder shall not be used in advertising or otherwise to promote the sale, use or other dealings in this Software without prior written authorization of the copyright holder.

## 3. libjpeg

This software is based in part on the work of the Independent JPEG Group.

## 4. libpng

Copyright (c) 2004, 2006-2009 Glenn Randers-Pehrson  
Copyright (c) 2000-2002 Glenn Randers-Pehrson  
Copyright (c) 1998, 1999 Glenn Randers-Pehrson  
Copyright (c) 1996, 1997 Andreas Dilger  
Copyright (c) 1995, 1996 Guy Eric Schalnat, Group 42, Inc.

## 5. ncurses

Copyright (c) 1998-2004,2006 Free Software Foundation, Inc.

Permission is hereby granted, free of charge, to any person obtaining a copy of this software and associated documentation files (the "Software"), to deal in the Software without restriction, including without limitation the rights to use, copy, modify, merge, publish, distribute, distribute with modifications, sublicense, and/or sell copies of the Software, and to permit persons to whom the Software is furnished to do so, subject to the following conditions:

The above copyright notice and this permission notice shall be included in all copies or substantial portions of the Software.

THE SOFTWARE IS PROVIDED "AS IS", WITHOUT WARRANTY OF ANY KIND, EXPRESS OR IMPLIED, INCLUDING BUT NOT LIMITED TO THE WARRANTIES OF MERCHANTABILITY, FITNESS FOR A PARTICULAR PURPOSE AND NONINFRINGEMENT. IN NO EVENT SHALL THE

ABOVE COPYRIGHT HOLDERS BE LIABLE FOR ANY CLAIM, DAMAGES OR OTHER LIABILITY, WHETHER IN AN ACTION OF CONTRACT, TORT OR OTHERWISE, ARISING FROM, OUT OF OR IN CONNECTION WITH THE SOFTWARE OR THE USE OR OTHER DEALINGS IN THE SOFTWARE.

Except as contained in this notice, the name(s) of the above copyright holders shall not be used in advertising or otherwise to promote the sale, use or other dealings in this Software without prior written authorization.

## 6. ntp

Copyright (c) David L. Mills 1992-2009

Permission to use, copy, modify, and distribute this software and its documentation for any purpose with or without fee is hereby granted, provided that the above copyright notice appears in all copies and that both the copyright notice and this permission notice appear in supporting documentation, and that the name University of Delaware not be used in advertising or publicity pertaining to distribution of the software without specific, written prior permission. The University of Delaware makes no representations about the suitability this software for any purpose. It is provided "as is" without express or implied warranty.

## 7. zlib

Copyright (C) 1995-2004 Jean-loup Gailly and Mark Adler

## 8. Expat

### COPYRIGHT AND PERMISSION NOTICE

Copyright (c) 1996 - 2008, Daniel Stenberg,  
<daniel@haxx.se>.  
All rights reserved.

Permission to use, copy, modify, and distribute this software for any purpose with or without fee is hereby granted, provided that the above copyright notice and this permission notice appear in all copies.

THE SOFTWARE IS PROVIDED "AS IS", WITHOUT WARRANTY OF ANY KIND, EXPRESS OR IMPLIED, INCLUDING BUT NOT LIMITED TO THE WARRANTIES OF MERCHANTABILITY, FITNESS FOR A PARTICULAR PURPOSE AND NONINFRINGEMENT OF THIRD PARTY RIGHTS. IN NO EVENT SHALL THE AUTHORS OR COPYRIGHT HOLDERS BE LIABLE FOR ANY CLAIM, DAMAGES OR OTHER LIABILITY, WHETHER IN AN ACTION OF CONTRACT, TORT OR OTHERWISE, ARISING FROM, OUT OF OR IN CONNECTION WITH THE SOFTWARE OR THE USE OR OTHER DEALINGS IN THE SOFTWARE.

Except as contained in this notice, the name of a copyright holder shall not be used in advertising or otherwise to promote the sale, use or other dealings in this Software without prior written authorization of the copyright holder.

## 9. NetBSD

Copyright (c) 1994-2004 The NetBSD Foundation, Inc.  
All rights reserved.

Redistribution and use in source and binary forms, with or without modification, are permitted provided that the following conditions are met:

1. Redistributions of source code must retain the above copyright notice, this list of conditions and the following disclaimer.
2. Redistributions in binary form must reproduce the above copyright notice, this list of conditions and the following disclaimer in the documentation and/or other materials provided with the distribution.
3. All advertising materials mentioning features or use of this software must display the following acknowledgement:  
This product includes software developed by the NetBSD Foundation, Inc. and its contributors.
4. Neither the name of The NetBSD Foundation nor the names of its contributors may be used to endorse or promote products derived from this software without specific prior written permission.

THIS SOFTWARE IS PROVIDED BY THE REGENTS AND CONTRIBUTORS "AS IS" AND ANY EXPRESS OR IMPLIED WARRANTIES, INCLUDING, BUT NOT LIMITED TO, THE IMPLIED WARRANTIES OF MERCHANTABILITY AND FITNESS FOR A PARTICULAR PURPOSE ARE DISCLAIMED. IN NO EVENT SHALL THE REGENTS OR CONTRIBUTORS BE LIABLE FOR ANY DIRECT, INDIRECT, INCIDENTAL, SPECIAL, EXEMPLARY, OR CONSEQUENTIAL DAMAGES (INCLUDING, BUT NOT LIMITED TO, PROCUREMENT OF SUBSTITUTE GOODS OR SERVICES; LOSS OF USE, DATA, OR PROFITS; OR BUSINESS INTERRUPTION) HOWEVER CAUSED AND ON ANY THEORY OF LIABILITY, WHETHER IN CONTRACT, STRICT LIABILITY, OR TORT (INCLUDING NEGLIGENCE OR OTHERWISE) ARISING IN ANY WAY OUT OF THE USE OF THIS SOFTWARE, EVEN IF ADVISED OF THE POSSIBILITY OF SUCH DAMAGE.

The following notices are required to satisfy the license terms of the software that we have mentioned in this document:

- This product includes software developed by Adam Glass.
- This product includes software developed by Bill Paul.
- This product includes software developed by Brini.
- This product includes software developed by Causality Limited.
- This product includes software developed by Charles M. Hannum.
- This product includes software developed by Christian E. Hopps.
- This product includes software developed by Christopher G. Demetriou.
- This product includes software developed by Christopher G. Demetriou for the NetBSD Project.
- This product includes software developed by Christos Zoulas.
- This product includes software developed by Gardner Buchanan.
- This product includes software developed by Gordon W. Ross.
- This product includes software developed by Manuel Bouyer.

This product includes software developed by Mark Brinicombe.

This product includes software developed by Rolf Grossmann.

This product includes software developed by ToolS GmbH.

This product includes software developed by the NetBSD Foundation, Inc. and its contributors.

This product includes software developed by the RiscBSD team.

This product includes software developed by the University of California, Berkeley and its contributors.

This product includes software developed by the University of California, Lawrence Berkeley Laboratory and its contributors.

This product includes software developed by the University of California, Lawrence Berkeley Laboratory.

This product includes software developed for the NetBSD Project by Wasabi Systems, Inc.

This product includes software developed for the NetBSD Project by Matthias Drochner.

## 10.libcap



Redistribution and use in source and binary forms of libcap, with or without modification, are permitted provided that the following conditions are met:

1. Redistributions of source code must retain any existing copyright notice, and this entire permission notice in its entirety, including the disclaimer of warranties.
2. Redistributions in binary form must reproduce all prior and current copyright notices, this list of conditions, and the following disclaimer in the documentation and/or other materials provided with the distribution.
3. The name of any author may not be used to endorse or promote products derived from this software without their specific prior written permission.

ALTERNATIVELY, this product may be distributed under the terms of the GNU General Public License, in which case the provisions of the GNU GPL are required INSTEAD OF the above restrictions. (This clause is necessary due to a potential conflict between the GNU GPL and the restrictions contained in a BSD-style copyright.)

THIS SOFTWARE IS PROVIDED "AS IS" AND ANY EXPRESS OR IMPLIED WARRANTIES, INCLUDING, BUT NOT LIMITED TO, THE IMPLIED WARRANTIES OF MERCHANTABILITY AND FITNESS FOR A PARTICULAR PURPOSE ARE DISCLAIMED. IN NO EVENT SHALL THE AUTHOR(S) BE LIABLE FOR ANY DIRECT, INDIRECT, INCIDENTAL, SPECIAL, EXEMPLARY, OR CONSEQUENTIAL DAMAGES (INCLUDING, BUT NOT LIMITED TO, PROCUREMENT OF SUBSTITUTE GOODS OR SERVICES; LOSS OF USE, DATA, OR PROFITS; OR BUSINESS INTERRUPTION) HOWEVER CAUSED AND ON ANY THEORY OF LIABILITY, WHETHER IN CONTRACT, STRICT LIABILITY, OR TORT (INCLUDING NEGLIGENCE OR OTHERWISE) ARISING IN ANY WAY OUT OF THE USE OF THIS SOFTWARE, EVEN IF ADVISED OF THE POSSIBILITY OF SUCH DAMAGE.

## Trademarks, etc.

- This software is based in part on the work of the Independent JPEG Group.
- PARTY STREAMING and the PARTY STREAMING logo are trademarks of Sony Corporation.
- VAIO, , and VAIO Media are registered trademarks of Sony Corporation.
- US and foreign patents licensed from Dolby Laboratories.
- MPEG Layer-3 audio coding technology and patents licensed from Fraunhofer IIS and Thomson.
- Microsoft, Windows, Windows Vista, Windows 7™, Windows Media are trademarks or registered trademarks of Microsoft Corporation in the United States and/or other countries.
- iPhone, iPod, iPod classic, iPod nano, and iPod touch are trademarks of Apple Inc., registered in the U.S. and other countries.
- “” is a mark of the Wi-Fi Alliance.
- DLNA®, the DLNA Logo and DLNA CERTIFIED™ are trademarks, service marks, or certification marks of the Digital Living Network Alliance.

- This product is protected by certain intellectual property rights of Microsoft Corporation. Use or distribution of such technology outside of this product is prohibited without a license from Microsoft or an authorized Microsoft subsidiary.
- The system names and product names indicated in this manual are generally the trademarks or registered trademarks of the manufacturer.
- In this manual, Microsoft Windows XP Home Edition, Microsoft Windows XP Professional and Microsoft Windows XP Media Center Edition are referred to as Windows XP.
- In this manual, Microsoft Windows Vista Home Basic, Microsoft Windows Vista Home Premium, Microsoft Windows Vista Business and Microsoft Windows Vista Ultimate are referred to as Windows Vista.
- In this manual, Microsoft Windows 7 Starter, Microsoft Windows 7 Home Premium, Microsoft Windows 7 Professional, Microsoft Windows 7 Ultimate are referred to as Windows 7.
- ™ and ® marks are omitted in this manual.

## WPA Supplicant

Copyright (c) 2003-2006, Jouni Malinen

<jkmaline@cc.hut.fi> and contributors

All Rights Reserved.

Redistribution and use in source and binary forms, with or without modification, are permitted provided that the following conditions are met:

- 1 Redistributions of source code must retain the above copyright notice, this list of conditions and the following disclaimer.
- 2 Redistributions in binary form must reproduce the above copyright notice, this list of conditions and the following disclaimer in the documentation and/or other materials provided with the distribution.
- 3 Neither the name(s) of the above-listed copyright holder(s) nor the names of its contributors may be used to endorse or promote products derived from this software without specific prior written permission.

THIS SOFTWARE IS PROVIDED BY THE COPYRIGHT HOLDERS AND CONTRIBUTORS “AS IS” AND ANY EXPRESS OR IMPLIED WARRANTIES, INCLUDING, BUT NOT LIMITED TO, THE IMPLIED WARRANTIES OF MERCHANTABILITY AND FITNESS FOR A PARTICULAR PURPOSE ARE DISCLAIMED. IN NO EVENT SHALL THE COPYRIGHT OWNER OR CONTRIBUTORS BE LIABLE FOR ANY DIRECT, INDIRECT, INCIDENTAL, SPECIAL, EXEMPLARY, OR CONSEQUENTIAL DAMAGES (INCLUDING, BUT NOT LIMITED TO, PROCUREMENT OF SUBSTITUTE GOODS OR SERVICES; LOSS OF USE, DATA, OR PROFITS; OR BUSINESS INTERRUPTION) HOWEVER CAUSED AND ON ANY THEORY OF LIABILITY, WHETHER IN CONTRACT, STRICT LIABILITY, OR TORT (INCLUDING NEGLIGENCE OR OTHERWISE) ARISING IN ANY WAY OUT OF THE USE OF THIS SOFTWARE, EVEN IF ADVISED OF THE POSSIBILITY OF SUCH DAMAGE.

<http://www.sony.net/>

**MP3**

