

SONY[®]

User guide

Xperia[™] ZR
C5503/C5502

Contents

Xperia™ ZR User guide.....	6
Getting started.....	7
Android™ – what and why?.....	7
Device overview.....	7
Assembly.....	8
Turning the device on and off	10
Screen lock.....	10
Setup guide.....	10
Accounts and services.....	11
Getting to know your device.....	12
Using the keys.....	12
Battery.....	12
Using the touchscreen.....	15
Using the lockscreen.....	17
Home screen.....	18
Accessing and using applications.....	20
Status and notifications.....	23
Settings menu.....	24
Typing text.....	25
Customising your device.....	29
Enhancing the sound output.....	32
Memory.....	32
Using a headset	33
Internet and messaging settings.....	33
Controlling data usage.....	34
Mobile network settings.....	35
Google Play™.....	37
Getting started with Google Play™.....	37
Downloading from Google Play™.....	37
Clearing your application data.....	37
Permissions.....	38
Installing applications not from Google Play™	38
Calling.....	39
Emergency calls.....	39
Call handling.....	39
Voicemail.....	41
Multiple calls.....	41
Conference calls.....	41
Call settings.....	42

Contacts	44
About Contacts.....	44
Transferring contacts to your new device.....	44
Contacts screen overview.....	46
Managing your contacts.....	46
Communicating with your contacts.....	48
Sharing your contacts.....	48
Backing up contacts.....	49
Messaging	50
Using text and multimedia messaging.....	50
Text and multimedia message options.....	51
Google Talk™	52
Email	53
Getting started with Email.....	53
Using email.....	54
Socialife™	57
Using the Socialife™ application.....	57
"WALKMAN" application	58
About the "WALKMAN" application.....	58
Transferring media files to your device	58
Using the "WALKMAN" application	59
Visualiser	60
Getting more information about a track or artist.....	60
Using My music to organise your tracks	60
Managing playlists.....	62
"WALKMAN" application widget	63
Protecting your hearing.....	63
Music services	64
TrackID™ technology.....	64
Music Unlimited™.....	65
About the PlayNow™ service.....	65
FM radio	67
About the FM radio.....	67
Using your favourite radio channels.....	68
Sound settings.....	68
Identifying radio tracks using TrackID™	68
Camera	70
About the camera.....	70
Using the still camera.....	70
Face detection.....	71
Using Smile Shutter™ to capture smiling faces.....	71
Adding the geographical position to your photos.....	72

Using still camera settings.....	72
Using the video camera.....	76
Album.....	81
About Album.....	81
Mobile BRAVIA® Engine.....	81
Viewing photos and videos in the Pictures tab	81
Viewing photos and videos in the My albums tab	82
Viewing your photos on a map.....	86
Viewing online albums.....	87
Movies.....	89
About Movies.....	89
Using Movies.....	89
Video Unlimited™.....	91
About Video Unlimited™	91
Renting or buying a video.....	91
Watching a video from Video Unlimited™.....	92
Web browser.....	93
About the web browser.....	93
Connectivity.....	94
Connecting to wireless networks.....	94
Sharing content with DLNA Certified™ devices.....	97
NFC.....	99
Bluetooth™ wireless technology.....	102
Connecting your device to a computer.....	104
Connecting your device to a TV set.....	106
Screen mirroring.....	107
Scanning barcodes with the NeoReader™ application.....	107
Smart Connect.....	108
Synchronising data on your device.....	110
About synchronising data on your device.....	110
Synchronising with Google™.....	110
Synchronising your corporate email, calendar and contacts.....	110
Synchronising with Facebook™.....	111
Maps and locations.....	113
About location services.....	113
Using GPS.....	113
Google Maps™.....	114
Using Google Maps™ to get directions.....	114
Calendar and alarm clock.....	115
Calendar.....	115
Alarm clock.....	115

Support and maintenance	118
Updating your device.....	118
Backup and restore application.....	119
Resetting your device.....	120
Locking and protecting your device.....	121
Support application.....	123
Recycling your device.....	123
Reference	124
Settings overview.....	124
Status and notification icons overview.....	125
Application overview.....	126
Important information	128
Important information leaflet.....	128
Limitations to services and features.....	128
Protecting your device from water and dust.....	128
Legal information.....	130
Index	131

Xperia™ ZR User guide



Getting started

Android™ – what and why?

Your Xperia™ from Sony runs on the Android platform. Android devices can perform many of the same functions as a computer and you can customise them to your own needs. For example, you can add and delete applications, or enhance existing applications to improve functionality. On Google Play™ you can download a range of applications and games from a constantly growing collection. You can also integrate applications on your Android™ device with other applications and with online services that you use. For example, you can back up your contacts, access your different email accounts and calendars from one place, keep track of your appointments, and engage in social networking.

Android™ devices are constantly evolving. When a new software version is available and your device supports this new software, you can update your device to get new features and the latest improvements.

- 💡 Your Android™ device is pre-loaded with Google™ services. To get the most out of the provided Google™ services, you should have a Google™ account and sign in to it when you first start your device. You also need to have Internet access to use many of the features in Android™.
- ! New software releases may not be compatible with all devices.

Device overview



- 1 Front camera lens
- 2 Ear speaker
- 3 Headset jack
- 4 Light sensor
- 5 Power key

- 6 Volume/Zoom key
- 7 Camera key
- 8 Strap hole
- 9 Microphone
- 10 Notification light

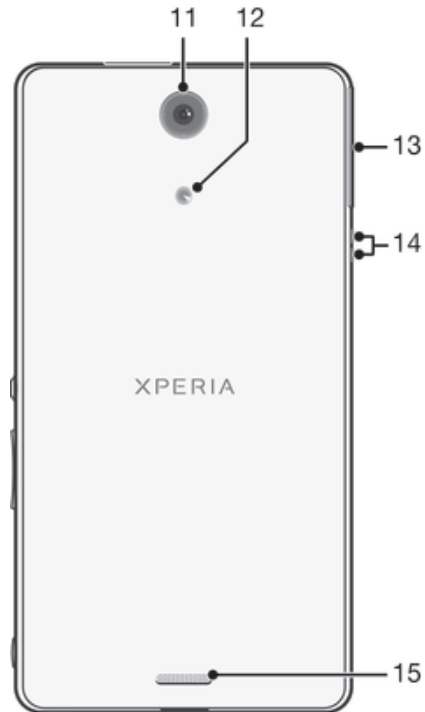

- 11 Camera lens
- 12 Camera light
- 13 Port for charger/USB cable
- 14 Connector for charging dock
- 15 Speaker

Assembly

To remove the back cover



- Insert a thumbnail into the gap between the back cover and the bottom side of your device, then lift up the cover.

To insert the micro SIM card

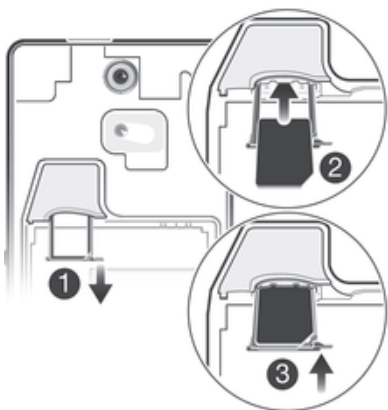

- 1 Remove the battery cover and the battery, then pull out the micro SIM card holder.
- 2 Place the micro SIM card into the micro SIM card holder, with the gold-coloured contacts facing down.
- 3 Push the micro SIM card and the holder back into the phone.

To insert a memory card

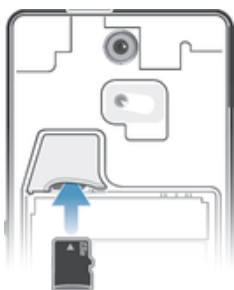

- 1 Remove the back cover and the battery.
 - 2 Insert the memory card into the memory card slot, with the gold-coloured contacts facing down.
- ! The memory card may not be included at purchase in all markets.

To attach the back cover

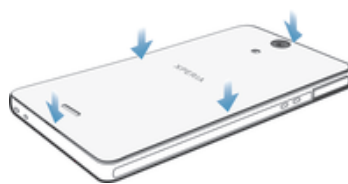





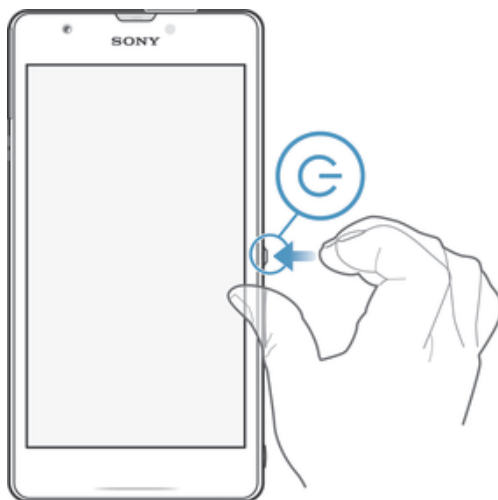

- 1 Place the back cover over the back of the device, then press down on the top corners to lock them into place.
- 2 Moving from top to bottom, press down the sides of the cover. The clips on the inside of the cover make clicking noises as they lock into place.



Turning the device on and off

To turn on the device



- 1 Press and hold down the power key  until the device vibrates.
 - 2 If your screen goes dark, briefly press the power key  to activate the screen.
 - 3 To unlock the screen, drag  up or drag  down.
 - 4 Enter your SIM card PIN when requested, then select **OK**.
 - 5 Wait a while for the device to start.
-  Your SIM card PIN is initially supplied by your network operator, but you can change it later from the **Settings** menu. To correct a mistake made while entering your SIM card PIN, tap .

To turn off the device

- 1 Press and hold down the power key  until the options menu opens.
 - 2 In the options menu, tap **Power off**.
 - 3 Tap **OK**.
-  It may take a while for the device to shut down.

Screen lock



When your device is on and left idle for a set period of time, the screen darkens to save battery power, and locks automatically. This lock prevents unwanted actions on the touchscreen when you are not using it. On the lockscreen, you can still take photos and play audio tracks.

To activate the screen

- Briefly press the power key .

To unlock the screen



- Drag  up or drag  down.

To lock the screen manually

- When the screen is active, briefly press the power key .

Setup guide

The first time you start your device, a setup guide opens to explain basic functions and help you enter essential settings. This is a good time to configure the device to

your specific needs. You can also access the setup guide later from the settings menu.

To access the setup guide manually

- 1 From the Home screen, tap .
- 2 Tap **Settings > Setup guide**.

Accounts and services

Sign in to your online service accounts from your device to get easy access when you're on the move. For example, you can integrate contacts from your Google™ account into your phonebook, so you have everything in one place. You can sign up to new online services from your device as well as from a computer.

Google™ account

Having a Google™ account is key to using a range of applications and services with your Android device. You need a Google™ account, for example, to use the **Gmail™** application in your device, to chat with friends using Google Talk™, and to synchronise the calendar application on your device with your Google Calendar™. You also need a Google™ account to download applications and games, music, movies and books from Google Play™.

Microsoft® Exchange ActiveSync® account

Synchronise your device with your corporate Microsoft® Exchange ActiveSync® account. This way, you keep your work email, contacts and calendar events with you at all times.

Facebook™ account

Facebook™ is a social networking service that connects you with friends, family and colleagues around the world. Set up Facebook to work on your device so that you can stay in touch from anywhere.

Getting to know your device

Using the keys



Back

- Go back to the previous screen
- Close the on-screen keypad, a dialog box, an options menu, or the Notification panel



Home

- Go to the **Home screen**



Task

- Tap to open a window showing your most recently used applications and a small apps bar

Battery

Charging the battery

Your battery is partly charged when you buy the device. It may take a few minutes before the battery icon  appears on the screen when you connect the charger cable to a power source, such as a USB port or a charger. You can still use your device while it is charging. Charging your device over a long period of time, for example, overnight, does not damage the battery or the device.

- ! The battery will start to discharge a little after it is fully charged and then charges again after a certain time when the charger is connected. This is to extend battery life and may result in the charge status showing a level below 100 percent.

To charge your device

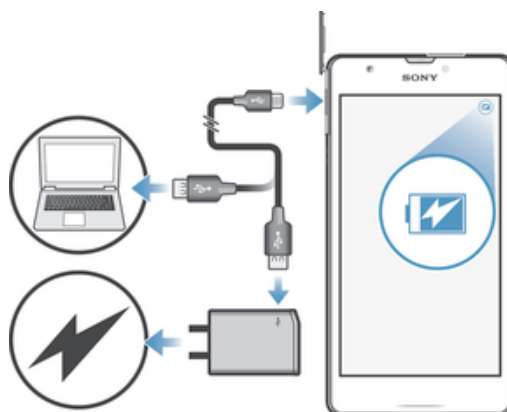

- 1 Plug the charger into a power outlet.
- 2 Plug one end of the USB cable into the charger (or into the USB port of a computer).
- 3 Plug the other end of the cable into the micro USB port on your device, with the USB symbol facing up. The battery status LED lights up when charging starts.
- 4 When the battery status LED is green, the device is fully charged. Disconnect the USB cable from your device by pulling it straight outwards. Make sure not to bend the connector when removing the cable from the device.

! Use the charger and USB cable provided with the device to ensure faster charging.

💡 If the battery is completely discharged, it may take a few minutes before the LED lights up after you connect the charger cable to a power source.

Battery LED status

Green	The battery is fully charged
Red	The battery level is low
Orange	The battery is charging. The battery level is between low and full

To check the battery level

- 1 From your **Home screen**, tap .
- 2 Find and tap **Settings > About phone > Status > Battery level**.

Improving battery performance

The following tips can help you improve battery performance:

- Charge your device often. This will not affect the lifetime of the battery.
- Downloading data from the Internet is power consuming. When you're not using the Internet, you can save power by disabling all data connections over mobile networks. This setting does not prevent your device from transmitting data over other wireless networks.
- Turn off Bluetooth™ and Wi-Fi® when you don't need these features. You can turn them on and off more easily by adding the Quick settings widget to your **Home screen**.
- Use the **STAMINA mode** and **Low battery mode** features to reduce battery consumption. You can select the power saving mode that best suits the way you use your device. You can also customise the settings of each power saving mode.
- Set your synchronisation applications (used to synchronise your email, calendar and contacts) to synchronise manually. You can also synchronise automatically, but increase the synchronisation intervals.
- Check the battery usage menu in your device to see which applications use the most power. Your battery consumes more power when you use video and music streaming

applications, such as YouTube™. Some applications downloaded from Google Play™ may also consume more power.

- Close and exit applications that you are not using.
- Lower the screen display brightness level.
- Turn off your device or activate the **Airplane mode** setting if you are in an area with no network coverage. Otherwise, your device repeatedly scans for available networks, and this consumes power.
- Use a Sony original handsfree device to listen to music. Handsfree devices demand less battery power than your device's own loudspeakers.
- Keep your device in standby mode whenever possible. Standby time refers to the time during your device is connected to the network and is not being used.
- Disable any live wallpaper.

To access the battery usage menu

- 1 From your **Home** screen, tap .
- 2 Find and tap **Settings** > **Power management** > **Battery usage**.

To add the Data traffic widget to your Home screen

- 1 Tap and hold an empty area of your **Home** screen.
- 2 Tap **Widgets** > **Tools**.
- 3 Tap and hold the **Mobile data** widget, then drag it to an empty area of your Home screen.



To add the Quick settings widget to your Home screen

- 1 Tap and hold an empty area of your **Home** screen.
- 2 Tap **Widgets** > **Tools**.
- 3 Tap and hold the **Quick settings** widget, then drag it to an empty area of your Home screen.



Using STAMINA mode

Activate the **STAMINA mode** feature to pause your **Wi-Fi®** connection, data traffic and several power consuming applications when your screen is inactive. When **STAMINA mode** is active, you can still receive phone calls, and text and multimedia messages. You can also set up an applications list to allow some applications to keep running when your screen is inactive. Once the screen becomes active again, all paused functions are resumed.

To activate STAMINA mode

- 1 From your **Home** screen, tap .
- 2 Find and tap **Settings** > **Power management**.
- 3 Tap  next to **STAMINA mode**, then tap **Activate**.

To deactivate STAMINA mode

- 1 From your **Home** screen, tap .
- 2 Find and tap **Settings** > **Power management**.
- 3 Tap  next to **STAMINA mode**.

To change the settings for STAMINA mode

- 1 From your **Home** screen, tap .
- 2 Find and tap **Settings** > **Power management**.
- 3 To open the settings menu, tap **STAMINA mode**.
- 4 Add or remove applications, as desired.
- 5 When you're finished, tap **Done**.

Estimating the standby time of your device

Standby time refers to the amount of time the battery can last when your device is connected to the network but is not in active use, for example, to receive or make phone calls. **STAMINA mode**, when activated, continuously evaluates the remaining standby time, which can vary depending on how you use your device. **STAMINA mode** is more effective in lengthening the standby time if you keep the screen of your

device locked. If you rarely lock the screen, you may not see much improvement in battery performance.

- ! When you use your device for the first time, the estimated standby time may not be accurate since there is no previous usage history to estimate from.



To view the estimated standby time

- 1 From your **Home screen**, tap .
- 2 Find and tap **Settings > Power management**.



Using Low battery mode

You can activate the **Low battery mode** feature when the battery level is low. This feature helps you to adjust the settings for screen brightness, data traffic and the vibrate function so that you can reduce battery consumption.



To activate Low battery mode

- 1 From your **Home screen**, tap .
- 2 Find and tap **Settings > Power management**.
- 3 Tap  next to **Low battery mode**, then tap **Activate**.

To deactivate Low battery mode

- 1 From your **Home screen**, tap .
- 2 Find and tap **Settings > Power management**.
- 3 Tap  next to **Low battery mode**.

To change the settings for Low battery mode

- 1 From your **Home screen**, tap .
- 2 Find and tap **Settings > Power management**.
- 3 To open the settings menu, tap **Low battery mode**.
- 4 Adjust the settings as desired.
- 5 When you're finished, tap .

Using the touchscreen

A protective plastic sheet is already attached to the screen of your device when you buy it. You should peel off this sheet before using the touchscreen. Otherwise, the touchscreen might not function properly.

When your device is on and left idle for a set period of time, the screen darkens to save battery power, and locks automatically. This lock prevents unwanted actions on the touchscreen when you are not using it. You can also set personal locks to protect your subscription and make sure only you can access content on your device.

- ! The device screen is made from glass. Do not touch the screen if the glass is cracked or shattered. Avoid trying to repair a damaged screen yourself. Glass screens are sensitive to drops and mechanical shocks. Cases of negligent care are not covered by the Sony warranty service.

To open or highlight an item

- Tap the item.

Marking options

- Marked checkbox
- Unmarked checkbox
- Marked list option
- Unmarked list option

To mark or unmark options

- Tap the relevant checkbox or list option.

Zooming

The zoom options available depend on the application you are using.

To zoom

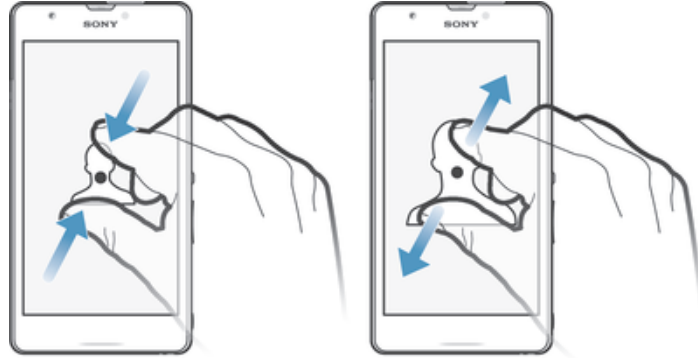

- Place two fingers on the screen at once and pinch them together (to zoom out) or spread them apart (to zoom in).
- 💡 When you use two fingers on the screen to zoom, it is only possible to zoom if both fingers are within the zoomable area. If you, for example, want to zoom in on a photo, make sure that both fingers are within the photo frame area.

Scrolling

Scroll by moving your finger up or down on the screen. On some web pages you can also scroll to the sides.

- ! Dragging or flicking will not activate anything on the screen.

To scroll

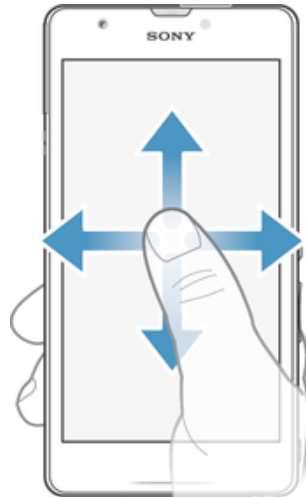

- Drag or flick your finger in the direction you want to scroll on the screen.
- 💡 To scroll more quickly, flick your finger in the direction you want to go on the screen.

To flick

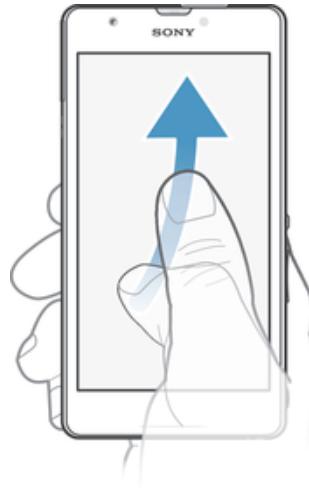

- To scroll more quickly, flick your finger in the direction you want to go on the screen. You can wait for the scrolling movement to stop by itself, or you can stop it immediately by tapping the screen.

Sensors

Your device has sensors that detect both light and proximity. The light sensor detects the ambient light level and adjusts the brightness of the screen accordingly. The proximity sensor turns the touch screen off during voice calls when your ear is close to the screen. This prevents you from unintentionally activating other functions on your device when you are engaged in a call.

Using the lockscreen

On the lockscreen, you can play tracks, take photos and record videos without unlocking the screen.

To take a photo from the lockscreen



- 1 To activate the screen, briefly press the power key (⏻).
- 2 To activate the camera controls, drag 📷 to the left across the screen.
- 3 Tap 📷.

To play an audio track from the lockscreen





- 1 To activate the screen, briefly press the power key (⏻).
- 2 To display the music player controls, drag 🎵 to the right across the screen.
- 3 Tap ▶.

To pause an audio track from the lockscreen

- 1 To activate the screen, briefly press the power key (⏻).
- 2 When the music player controls appear, tap ⏸.

To change the currently playing audio track from the lockscreen

- 1 To activate the screen, briefly press the power key .
- 2 When the music player controls appear, tap  or .

Home screen

The Home screen is your gateway to the main features on your device. You can customise your **Home screen** with widgets, shortcuts, folders, themes, wallpaper and other items.

The **Home screen** extends beyond the regular screen display width, so you need to flick left or right to view content in all of the Home screen's panes.  shows which part of the **Home screen** you are in. You can set a pane as the main Home screen pane, and add or delete panes.



-  The items in the bar at the bottom of the screen are always available for quick access.

To go to the Home screen

- Press .

To browse the Home screen

- Flick right or left.

To set a pane as the main Home screen pane



- 1 Touch and hold an empty area on your **Home screen** until the device vibrates.
- 2 Flick left or right to browse to the pane that you want to set as your main Home screen pane, then tap .

To add a pane to your Home screen

- 1 Touch and hold an empty area on your **Home screen** until the device vibrates.
- 2 Flick left or right to browse the panes, then tap .

To delete a pane from your Home screen

- 1 Touch and hold an empty area on your **Home screen** until the device vibrates.
- 2 Flick left or right to browse to the pane that you want to delete, then tap .

Widgets

Widgets are small applications that you can use directly on your **Home screen**. For example, the “WALKMAN” widget allows you to start playing music directly.

Some widgets are resizable, so you can expand them to view more content or shrink them to save space on your **Home screen**.

To add a widget to the Home screen

- 1 Touch and hold an empty area on your **Home screen** until the device vibrates, then tap **Widgets**.
- 2 Find and tap the widget that you want to add.

To resize a widget





- 1 Touch and hold a widget until it magnifies and the device vibrates, then release the widget. If the widget can be resized, for example, the Calendar widget, then a highlighted frame and resizing dots appear.
- 2 Drag the dots inward or outward to shrink or expand the widget.
- 3 To confirm the new size of the widget, tap anywhere on the **Home screen**.

Rearranging your Home screen

Customise the appearance of your Home screen and change the features that you can access from it. Change the screen background, move items around, create folders, and add shortcuts and widgets.

Customisation options

When you touch and hold an empty area of your Home screen, the following customisation options appear:

-  Add widgets to your Home screen.
-  Add applications and shortcuts.
-  Set a wallpaper for your Home screen.
-  Set a background theme.

To view customisation options from the Home screen

- Touch and hold an empty area on your **Home screen** until the device vibrates and customisation options appear at the bottom of the screen.

To add a shortcut to your Home screen

- 1 Touch and hold an empty area on your **Home screen** until the device vibrates.
- 2 Tap **Apps > Shortcuts**.
- 3 Select a shortcut.

- 💡 You can add an application shortcut directly from the Application screen by touching and holding the application.

To move an item on the Home screen

- Touch and hold the item until it magnifies and the device vibrates, then drag the item to the new location.

To delete an item from the Home screen

- Touch and hold an item until it magnifies and the device vibrates, then drag the item to .

To create a folder on the Home screen

- 1 Touch and hold an application icon or a shortcut until it magnifies and the device vibrates, then drag and drop it on top of another application icon or shortcut.
- 2 Enter a name for the folder and tap **Done**.

To add items to a folder on the Home screen

- Touch and hold an item until it magnifies and the device vibrates, then drag the item to the folder.

To rename a folder on the Home screen

- 1 Tap the folder to open it.
- 2 Tap the folder's title bar to show the **Folder name** field.
- 3 Enter the new folder name and tap **Done**.

Changing the background of your Home screen

Adapt the **Home screen** to your own style using wallpapers and different themes.

To change your Home screen wallpaper

- 1 Touch and hold an empty area on your **Home screen** until the device vibrates.
- 2 Tap **Wallpapers** and select an option.

To set a theme for your Home screen

- 1 Touch and hold an empty area on your **Home screen** until the device vibrates.
- 2 Tap **Themes**, then select a theme.

- ! When you change a theme, the background also changes in some applications.

Accessing and using applications

Open applications from shortcuts on your **Home screen** or from the Application screen.

Application screen

The Application screen, which you open from your **Home screen**, contains the applications that come pre-installed on your device as well as the applications you download.

The Application screen extends beyond the regular screen width, so you need to flick left and right to view all content.

To open the Application screen



- From your **Home screen**, tap .



To browse the Application screen

- From the Application screen, flick right or left.

To create a shortcut to an application on the Home screen

- 1 From your **Home screen**, tap .
- 2 Touch and hold an application icon until the screen vibrates, then drag the icon to the top of the screen. The **Home screen** opens.
- 3 Drag the icon to the desired location on the **Home screen**, then release your finger.

To share an application from your Application screen



- 1 From your **Home screen**, tap .
- 2 Tap , then tap **Share**. All applications which can be shared are indicated by .
- 3 Tap the application that you want to share, then select an option and confirm, if necessary. A link to a download of the application is sent to the people you have selected.

Opening and closing applications

To open an application

- From your **Home screen** or the Application screen, tap the application.

To close an application

- Press .
-  Some applications are paused when you press  to exit, while other applications may continue to run in the background. In the first case, the next time you open the application, you can continue where you left off. Remember that some applications may cause data connection charges when they are running in the background, for example, social networking services.

Recently used applications window

You can switch between recently used applications from this window. You can also open small apps.

To open the recently used applications window

- Press . The recently used applications window appears on the right of the screen.

Using small apps

From the recently used applications window, you can get quick access to several small apps at any time using the small apps bar. A small app only takes up a small area of your screen. So you can interact with a small app and another application at the same time on the same screen.

To open the small apps bar

- Press . The small apps bar appears at the bottom of the screen.

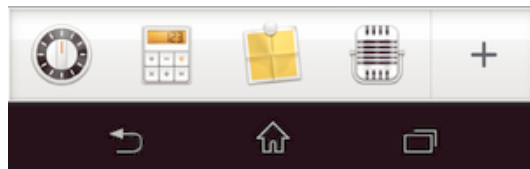

To open a small app

- 1 To make the small apps bar appear, press .
- 2 Tap the small app that you want to open. A small app window appears.

To close a small app

- Tap  on the small app window.

To move a small app

- When the small app is open, touch and hold the top left corner of the small app, then move it to the desired location.

To minimise a small app

- When the small app is open, touch and hold the top left corner of the small app, then drag it to the right edge or to the bottom edge of the screen.

To rearrange your small apps

- 1 To make the small apps bar appear, press .
- 2 Touch and hold a small app and drag it to the desired position in the small apps bar.



To remove a small app from the small apps bar

- 1 To make the small apps bar appear, press .
- 2 Touch and hold a small app icon and drag it away from the small apps bar.

To restore a previously removed small app

- 1 To make the small apps bar appear, press .
- 2 Tap **+** > **Installed small apps**.
- 3 Select the small app that you want to restore.

To download a small app

- 1 To make the small apps bar appear, press .
- 2 Tap **+** > .
- 3 Find a small app that you want to download, then follow the instructions to complete the installation.

Application menu

You can open a menu at any time when you are using an application. The menu will look different depending on which application you are using.

To open a menu in an application

- While using the application, press .
- ! A menu is not available in all applications.

Rearranging your Application screen

Move the applications around on the Application screen according to your preferences.



To arrange applications on the Application screen

- 1 From your **Home screen**, tap  to go to the Application screen.
- 2 Tap the drop-down list on the top left of the screen and select an option.

To move an application on the Application screen

- 1 Open the Application screen.
 - 2 Touch and hold an item until it magnifies and the device vibrates, then drag the item to the new location.
- ! You can only move your applications when **Own order** is selected.

To uninstall an application from the Application screen

- 1 From your **Home screen**, tap .
- 2 Tap , then tap **Uninstall**. All uninstalleable applications are indicated by .
- 3 Tap the application that you want to uninstall, then tap **Uninstall**.

Status and notifications

The status bar at the top of your screen shows what's going on in your device. To the left you get notifications when there is something new or ongoing. For example, new message and calendar notifications appear here. The right side shows the signal strength, battery status, and other information.



The status bar allows you to adjust basic settings on your device, for example, Wi-Fi®, Bluetooth™, data traffic, and sound. You can also open the settings menu from the Notification panel to change other settings.

A notification light also gives you battery status information and some notifications. For example, a flashing blue light means there is a new message or a missed call. The notification light may not work when the battery level is low.



Checking notifications and ongoing activities

You can drag down the status bar to open the Notification panel and get more information. For example, you can use the panel to open a new message or view a calendar event. You can also open some applications that run in the background, such as the music player.

To open the Notification panel



- Drag the status bar downwards.

To close the Notification panel



- Drag the tab at the bottom of the Notification panel upwards.

To open a running application from the Notification panel

- Tap the icon for the running application to open it.

To dismiss a notification from the Notification panel

- Place your finger on a notification and flick left or right.

To clear the Notification panel

- From the Notification panel, tap Clear.

Setting your device from the Notification panel

You can open the settings menu from the Notification panel to adjust basic device settings. For example, you can turn on Wi-Fi®.

To open the device settings menu from the Notification panel

- 1 Drag the status bar downwards.
- 2 Tap .

To adjust sound settings from the Notification panel

- 1 Drag the status bar downwards.
- 2 Tap .

To control the Bluetooth™ function from the Notification panel

- 1 Drag the status bar downwards.
- 2 Tap .

To control the Wi-Fi® function from the Notification panel

- 1 Drag the status bar downwards.
- 2 Tap .



To enable or disable data traffic from the Notification panel

- 1 Drag the status bar downwards.
- 2 Tap .

Settings menu

View and change settings for your device from the Settings menu.

To access your device settings

- 1 From your Home screen, tap .
 - 2 Tap **Settings**.
- 💡 You can also drag the status bar downwards on the Home screen and tap  to access your device settings.

Typing text

You can select from a number of keyboards and input methods to type text containing letters, numbers and other characters.

On-screen keyboard

Tap the keys of the on-screen QWERTY keyboard to enter text conveniently. Some applications open the on-screen keyboard automatically. You can also open this keyboard by touching a text field.

Using the on-screen keyboard



- 1 Change the character case and turn on the caps lock. For some languages, this key is used to access extra characters in the language.
- 2 Close the on-screen keyboard view. Note that this icon does not appear in portrait mode.
- 3 Display numbers and symbols.
- 4 Personalise your keyboard. This key disappears after the keyboard is personalised.
- 5 Enter a space.
- 6 Enter a carriage return or confirm text input.
- 7 Delete a character before the cursor.

- ! All illustrations are for illustration purposes only and may not accurately depict the actual device.

To display the on-screen keyboard to enter text

- Tap a text entry field.

To hide the on-screen keyboard

- When the on-screen keyboard is open, tap .

To personalise the on-screen keyboard

- 1 Open the on-screen keyboard, then tap .
 - 2 Follow the instructions to personalise your on-screen keyboard, for example, mark the **Smiley key** checkbox.
- 💡 If you don't mark the **Smiley key** checkbox when you personalise the on-screen keyboard, the smiley icon will not appear.

To use the on-screen keyboard in landscape orientation

- When you enter text, turn the device sideways.
- ! For the keyboard to support this feature, landscape mode must be supported by the application you are using, and your screen orientation settings must be set to automatic.

To enter text using the on-screen keyboard

- 1 To enter a character visible on the keyboard, tap the character.
- 2 To enter a character variant, touch and hold a regular keyboard character to get a list of available options, then select from the list. For example, to enter "é", touch and hold "e" until other options appear, then, while keeping your finger pressed on the keyboard, drag to and select "é".

To shift between upper-case and lower-case letters

- Before you enter a letter, tap ⇧ to switch to upper-case ⬆, or vice versa.

To turn on the caps lock

- Before you type a word, touch and hold ⇧ or ⬆ until ⬆ appears.

To enter numbers or symbols

- When you enter text, tap 12!?. A keyboard with numbers and symbols appears. Tap += \$ to view more options.

To enter common punctuation marks

- 1 When you finish entering a word, tap the space bar.
 - 2 Select a punctuation mark from the candidate bar. The selected mark is inserted before the space.
- 💡 To quickly enter a full stop, tap the space bar twice when you finish entering a word.

To delete characters

- Tap to place the cursor after the character you want to delete, then tap ✖.

To enter a carriage return

- When you enter text, tap ↵ to enter a carriage return.

To select text

- 1 Enter some text, then double-tap the text. The word you tap gets highlighted by tabs on both sides.
- 2 Drag the tabs left or right to select more text.

To edit text in landscape orientation

- 1 Enter some text, then double-tap the entered text.
 - 2 Select the text you want to work with, then tap **Edit...** and select an option.
- ! To paste text from the clipboard, double-tap the text field to make **Paste** appear, then tap **Paste**.

To edit text in portrait orientation

- 1 Enter some text, then double-tap the entered text to make the application bar appear.
 - 2 Select the text you want to edit, then use the application bar to make your desired changes.
- ! To paste text from the clipboard, double-tap the text field to make **Paste** appear, then tap **Paste**.

Application bar



- 1 Close the application bar
- 2 Select all text
- 3 Cut text
- 4 Copy text
- 5 Paste text

!  only appears when you have text stored on the clipboard.

Using the Gesture input function to write words

You can input text by sliding your finger from letter to letter on the on-screen keyboard.



! Gesture input is only available when you use the on-screen keyboard.

To enter text using the Gesture input function

- 1 When you enter text using the on-screen keyboard, slide your finger from letter to letter to trace the word you want to write.
- 2 Lift up your finger when you've finished entering a word. A word is suggested based on the letters you have traced. If necessary, select the correct word in the candidate bar.
- 3 To view more options, scroll right or left in the word candidate bar. If you cannot find the desired word, tap  once to delete the entire word. Then try again to trace the word using the Gesture input function, or tap each letter to enter the word.
- 4 If the **Space between gestures** setting is activated, trace the next word that you want to enter. If not, tap the space bar and then trace the next word you want to enter.

💡 To enter joined compound words when the **Space between gestures** setting is activated, you may need to slide to enter the first part of the word, then tap each letter to enter the rest of the word.

To change the Gesture input settings

- 1 When you enter text using the on-screen keyboard, tap .
- 2 Tap , then tap **Keyboard settings**.
- 3 Tap **Text input settings**.
- 4 Mark or unmark the **Gesture input** checkbox.
- 5 If you want to automatically add a space between gestures without having to tap the space bar each time, mark the **Space between gestures** checkbox.

Phonepad

The Phonepad is similar to a standard 12-key telephone keypad. It gives you predictive text and multi-tap input options. You can activate the Phonepad text input method via the keyboard settings. The Phonepad is only available in portrait orientation.

Using the Phonepad



- 1 Choose a text input option
- 2 Change the character case and turn on the caps lock
- 3 Display numbers
- 4 Display symbols and smileys
- 5 Enter a space
- 6 Enter a carriage return or confirm text input
- 7 Delete a character before the cursor

! All illustrations are for illustration purposes only and may not accurately depict the actual device.

To open the Phonepad for the first time

- 1 Tap a text entry field, then tap **12!?**.
- 2 Tap **☒**, then tap **Keyboard settings**.
- 3 Tap **Keyboard appearance > Keyboard layout**.
- 4 Select the Phonepad.

💡 The Phonepad can only be used in portrait mode.

To enter text using the Phonepad

- When **☒** appears in the Phonepad, tap each character key only once, even if the letter you want is not the first letter on the key. Tap the word that appears or tap **▶** to view more word suggestions and select a word from the list.
- When **☒** appears in the Phonepad, tap the on-screen key for the character you want to enter. Keep pressing this key until the desired character is selected. Then do the same for the next character you want to enter, and so on.

To enter numbers using the Phonepad

- When the Phonepad is open, tap **123**. A Phonepad with numbers appears.

To insert symbols and smileys using the Phonepad

- 1 When the Phonepad is open, tap **&☺**. A grid with symbols and smileys appears.
- 2 Scroll up or down to view more options. Tap a symbol or smiley to select it.

Keyboard and Phonepad settings

You can select settings for the on-screen keyboard and the Phonepad, such as writing language and automatic correction.

To access the on-screen keyboard and Phonepad settings

- 1 When you enter text using the on-screen keyboard or Phonepad, tap ^{121?} or ¹²³.
- 2 Tap , then tap **Keyboard settings**.

To add a writing language for text input

- 1 When you enter text using the on-screen keyboard or Phonepad, tap ^{121?} or ¹²³.
- 2 Tap , then tap **Keyboard settings**.
- 3 Tap **Languages > Writing languages** and mark the relevant checkboxes. Tap **OK** to confirm.

Text input settings

When entering text using the on-screen keyboard or the Phonepad, you can access a text input settings menu that helps you set options for text prediction, automatic spacing and quick fixes. For example, you can decide how word options are presented and how words get corrected as you type. You can also set the text input application to remember new words that you write.



To change the text input settings

- 1 When you enter text using the on-screen keyboard or the Phonepad, tap ^{121?} or ¹²³.
- 2 Tap , then tap **Keyboard settings > Text input settings** and select the relevant settings.



Entering text using voice input

When you enter text, you can use the voice input function instead of typing the words. Just speak the words that you want to enter. Voice input is an experimental technology from Google™, and is available for a number of languages and regions.

To enable voice input

- 1 When you enter text using the on-screen keyboard or the Phonepad, tap ^{121?} or ¹²³.
- 2 Tap , then tap **Keyboard settings**.
- 3 Mark the **Google voice typing key** checkbox.
- 4 Press  to save your settings. A microphone icon  appears on your on-screen keyboard or Phonepad.

To enter text using voice input

- 1 Open the on-screen keyboard or the Phonepad.
- 2 If  is available, tap it. If not, touch and hold the input language key, for example, **EN¹**.
- 3 When  appears, speak to enter text. When you're finished, tap  again. The suggested text appears.
- 4 Edit the text manually if necessary.

Customising your device

You can adjust several device settings to suit your own needs. For example, you can change the language, add a personal ringtone, or change the screen brightness.

Adjusting the volume

You can adjust the ringtone volume for incoming calls and notifications as well as for music and video playback.

To adjust the ring volume with the volume key

- Press the volume key up or down.



To adjust the media playing volume with the volume key

- When playing music or watching video, press the volume key up or down.





Adjusting the sound settings

You can adjust several sound settings. For example, you can set your device to silent mode so that it doesn't ring when you're in a meeting.

To set your device to vibrate mode

- Press the volume key down until  appears in the status bar.
- 💡 You can also press and hold down the power key  and then tap  in the menu that opens to set your device to vibrate mode.

To set your device to silent mode

- 1 Press the volume key down until the device vibrates and  appears in the status bar.
 - 2 Press the volume key down again.  appears in the status bar.
- 💡 You can also press and hold down the power key  and then tap  in the menu that opens to set your device to silent mode.

To set your device to vibrate and ring mode

- 1 From your Home screen, tap .
- 2 Find and tap **Settings > Sound**.
- 3 Mark the **Vibrate when ringing** checkbox.

Time and date

You can change the time and date on your device.

To set the date manually

- 1 From the Home screen, tap .
- 2 Find and tap **Settings > Date & time**.
- 3 Unmark the **Automatic date & time** checkbox, if it is marked.
- 4 Tap **Set date**.
- 5 Adjust the date by scrolling up and down.
- 6 Tap **Done**.

To set the time manually

- 1 From your Home screen, tap .
- 2 Find and tap **Settings > Date & time**.
- 3 Unmark the **Automatic date & time** checkbox if it is marked.
- 4 Tap **Set time**.
- 5 Scroll up or down to adjust the hour and minute.
- 6 If applicable, scroll up to change **am** to **pm**, or vice versa.
- 7 Tap **Done**.

To set the time zone

- 1 From your Home screen, tap .
- 2 Find and tap **Settings > Date & time**.
- 3 Unmark the **Automatic time zone** checkbox, if it is marked.
- 4 Tap **Select time zone**.
- 5 Select an option.

Ringtone settings

To set a ringtone

- 1 From your Home screen, tap .
- 2 Find and tap **Settings > Sound > Phone ringtone**.
- 3 Select a ringtone.
- 4 Tap **Done**.

To enable touch tones

- 1 From your Home screen, tap .
- 2 Find and tap **Settings > Sound**.
- 3 Mark the **Dial pad touch tones** and **Touch sounds** checkboxes.

To select the notification sound

- 1 From your Home screen, tap .
- 2 Find and tap **Settings > Sound > Default notification**.
- 3 Select the sound to be played when notifications arrive.
- 4 Tap **Done**.

Screen settings

To adjust the screen brightness

- 1 From your Home screen, tap .
- 2 Find and tap **Settings > Display > Brightness**.
- 3 Drag the slider to adjust the brightness.
- 4 Tap **OK**.

 The brightness level affects your battery performance. For tips on how to improve battery performance, see *Improving battery performance*.

To set the screen to vibrate

- 1 From your Home screen, tap .
- 2 Find and tap **Settings > Sound**.
- 3 Mark the **Vibrate on touch** checkbox. The screen now vibrates when you tap soft keys and certain applications.

To adjust the idle time before the screen turns off

- 1 From your Home screen, tap .
- 2 Find and tap **Settings > Display > Sleep**.
- 3 Select an option.

 To turn off the screen quickly, briefly press the power key .

To keep the screen active while your device is charging



- 1 From the Home screen, tap .
- 2 Find and tap **Settings > Developer options**.
- 3 Mark the **Stay awake** checkbox.

Language settings

You can select a default language for your device and change it again at a later time.

To change the language

- 1 From the Home screen, tap .
- 2 Find and tap **Settings > Language & input > Language**.
- 3 Select an option.
- 4 Tap **OK**.

 If you select the wrong language and cannot read the menu texts, find and tap . Then select the text beside  and select the first entry in the menu that opens. You can then select the language you want.

Airplane mode

In Airplane mode, the network and radio transceivers are turned off to prevent disturbance to sensitive equipment. However, you can still play games, listen to music, watch videos and other content, as long as all this content is saved on your

memory card or internal storage. You can also be notified by alarms, if alarms are activated.

- 💡 Turning on Airplane mode reduces battery consumption.

To turn on Airplane mode

- 1 From your **Home screen**, tap .
- 2 Find and tap **Settings > More....**
- 3 Mark the **Airplane mode** checkbox.

- 💡 You can also press and hold down the power key  and then select **Airplane mode** in the menu that opens.

Enhancing the sound output

You can enhance the sound output that comes from the speakers in your device using features such as Clear Phase™ and xLOUD™ technology.

Using Clear Phase™ technology

Use Clear Phase™ technology from Sony to automatically adjust the sound quality coming from your device's internal speakers and get a cleaner, more natural sound.

To enhance the speaker sound quality using Clear Phase™

- 1 From your **Home screen**, tap .
- 2 Find and tap **Settings > Sound**.
- 3 Mark the **Clear Phase™** checkbox.

- ! The activation of the Clear Phase™ feature has no effect on voice communication applications. For example, there is no change in the voice call sound quality.

Using xLOUD™ technology

Use xLOUD™ audio filter technology from Sony to enhance the speaker volume without sacrificing quality. Get a more dynamic sound as you listen to your favourite songs.

To enhance the speaker volume using xLOUD™

- 1 From your **Home screen**, tap .
- 2 Find and tap **Settings > Sound**.
- 3 Mark the **xLOUD™** checkbox.

- ! The activation of the xLOUD™ feature has no effect on voice communication applications. For example, there is no change in the voice call sound quality.

Memory

You can save content to your device's internal storage and to a memory card.

Memory card

Your device supports a microSD™ memory card, which is used for storing content. This type of card can also be used as a portable memory card with other compatible devices.

- ! You may have to purchase a memory card separately.

Formatting the memory card

You can format the memory card in your device, for example, to free up memory. This means that you erase all data on the card.

- ! All content on the memory card gets erased when you format it. Make sure you make backups of everything you want to save before formatting the memory card. To back up your content,

you can copy it to your computer. For more information, refer to the chapter *Connecting your device to a computer* on page 104.

Using a headset



- ! Use the accessories provided with your device, or other compatible accessories, for optimal performance.

To use a headset

- 1 Connect the headset to your device.
 - 2 To answer a call, press the call handling key.
 - 3 To end the call, press the call handling key.
- ! If a headset is not included with the device, you may purchase one separately.
 - 💡 If you are listening to music, the music stops when you answer a call and resumes after you end the call.

Internet and messaging settings



To send text and multimedia messages and to access the Internet, you must have a mobile data connection and the correct settings. There are different ways to get these settings:

- For most mobile networks and operators, Internet and messaging settings come preinstalled on your device. You can then start using the Internet and send messages right away.
- In some cases you will get the option to download Internet and messaging settings the first time you turn on your device. It is also possible to download these settings later from the **Settings** menu.
- You can manually add and change Internet and network settings on your device at any time. Contact your network operator for detailed information about Internet and messaging settings.

To download Internet and messaging settings

- 1 From your **Home** screen, tap .
- 2 Find and tap **Settings** > **Xperia™** > **Internet settings**.
- 3 Tap **Accept**.

To reset the default Internet settings

- 1 From the **Home** screen, tap .
- 2 Tap **Settings** > **More...** > **Mobile networks** > **Access Point Names**.
- 3 Tap .
- 4 Tap **Reset to default**.

Access Point Names (APNs)

An APN is used to establish data connections between your device and the Internet. The APN defines which type of IP address to use, which security methods to invoke, and which fixed-end connections to use. Checking the APN is useful when you



cannot access the Internet, have no data connection, or cannot send or receive multimedia messages.

To view the current APN

- 1 From your **Home screen**, tap .
- 2 Find and tap **Settings > More... > Mobile networks**.
- 3 Tap **Access Point Names**.

- ! If you have several available connections, the active network connection is indicated by a marked button.

To add Internet settings manually

- 1 From the **Home screen**, tap .
- 2 Find and tap **Settings > More... > Mobile networks > Access Point Names**.
- 3 Tap .
- 4 Tap **New APN**.
- 5 Tap **Name** and enter the name of the network profile that you want to create.
- 6 Tap **APN** and enter the access point name.
- 7 Enter all other information required by your network operator.
- 8 Tap , then tap **Save**.

Usage info

For quality purposes, Sony collects anonymous bug reports and statistics regarding your device. None of the information gathered includes personal data.

To allow the sending of usage info

- 1 From your **Home screen**, tap .
- 2 Find and tap **Settings > Xperia™ > Usage info settings**.
- 3 Mark the **Send usage info** checkbox if it is not already marked.
- 4 Tap **Agree** to allow the sending of usage information.

Controlling data usage

Keep track of and control the amount of data transferred to and from your device during a given period. For example, you can set data usage warnings and limits for your device to avoid additional charges. You can also limit the amount of data used by individual applications.

- ! Adjusting data usage settings can help you keep greater control over data usage but cannot guarantee the prevention of additional charges.

To access data usage settings

- 1 From your **Home screen**, tap .
- 2 Find and tap **Settings > Data usage**.

To turn data traffic on or off

- 1 From your **Home screen**, tap .
- 2 Find and tap **Settings > Data usage**.
- 3 To turn data traffic on or off, tap the on-off switch beside **Mobile data** accordingly.

- 💡 You can also turn data traffic on or off by marking or unmarking the **Mobile data traffic** checkbox under **Settings > More... > Mobile networks**.

To set a data usage warning

- 1 Make sure that you have turned on data traffic.
- 2 From your **Home screen**, tap .
- 3 Find and tap **Settings > Data usage**.
- 4 To set the warning level, drag the lines to the desired values. You receive a warning notification when the amount of data traffic approaches the level you set.

To set a data usage limit

- 1 Make sure that you have turned on data traffic.
 - 2 From your **Home screen**, tap .
 - 3 Find and tap **Settings > Data usage**.
 - 4 Mark the **Set mobile data limit** checkbox if it is not marked, then tap **OK**.
 - 5 To set the data usage limit, drag the lines to the desired values.
- ! Once your data usage reaches the set limit, data traffic on your device will be turned off automatically.

To control the data usage of individual applications

- 1 From your **Home screen**, tap .
 - 2 Find and tap **Settings > Data usage**.
 - 3 Find and tap the desired application.
 - 4 Make the necessary adjustments to change the data usage limit, restrict background data, or restrict all data traffic for the application.
 - 5 To access more specific settings for the application, tap **View app settings** and make the desired changes.
- ! Specific settings for an application may not always be accessible.
- 💡 The performance of individual applications may be affected if you change the related data usage settings.

Mobile network settings

Your device automatically switches between mobile networks depending on what mobile networks are available in different areas. You can also manually set your device to use a particular mobile network mode, for example, WCDMA or GSM.

To select a network mode

- 1 From your **Home screen**, tap .
- 2 Find and tap **Settings > More... > Mobile networks**.
- 3 Tap **Network Mode**.
- 4 Select a network mode.

To select another network manually

- 1 From the **Home screen**, tap .
 - 2 Find and tap **Settings > More... > Mobile networks > Network operators**.
 - 3 Tap **Search mode > Manual**.
 - 4 Select a network.
- ! If you select a network manually, your device will not search for other networks, even if you move out of range of the manually selected network.

To activate automatic network selection

- 1 From the **Home screen**, tap .
- 2 Find and tap **Settings > More... > Mobile networks > Network operators**.
- 3 When a pop-up window appears, tap **Search mode**.
- 4 Tap **Automatic**.

Turning off data traffic

You can disable all data connections over mobile networks to avoid any unwanted data downloads and synchronisations. Contact your network operator if you need detailed information about your subscription plan and data traffic charges.

- 💡 When data traffic is turned off, you can still use Wi-Fi® and Bluetooth™ connections. You can also send and receive multimedia messages.

To turn off all data traffic

- 1 From your **Home screen**, tap .
- 2 Find and tap **Settings > More... > Mobile networks**.
- 3 Unmark the **Mobile data traffic** checkbox.

Data roaming

Some network operators allow mobile data connections via mobile networks when you are outside of your home network (roaming). Note that data transmission charges may apply. Contact your network operator for more information.

- ! Applications may sometimes use the Internet connection in your home network without any notification, for example, when sending search and synchronisation requests. Additional charges may apply when such Internet connections are established while you are roaming. Consult your network operator for more information.

To activate data roaming

- 1 From the **Home screen**, tap .
 - 2 Find and tap **Settings > More... > Mobile networks**.
 - 3 Mark the **Data roaming** checkbox.
- ! You can't activate data roaming when data connections have been deactivated.

Google Play™

Getting started with Google Play™

Open Google Play™ and enter a world of applications and games. You can browse these applications and games through different categories. You can also rate an application or game and send feedback on it.

To use Google Play™, you need to have a Google™ account. See *To set up a Google™ account on your device* on page 54.

- ! Google Play™ may not be available in all countries or regions

To open Google Play™

- 1 From the **Home screen**, tap .
- 2 Find and tap **Play Store**.

Downloading from Google Play™

You can download all kinds of applications from Google Play™, including free applications.

Before you download applications

Before you start downloading from Google Play™, make sure that you have a working Internet connection.

Also, remember that you might incur data traffic charges when you download content to your device. Contact your operator for more information.

To download a free application

- 1 In Google Play™, find an item you wish to download by browsing categories, or by using the search function.
- 2 Tap the item to view its details, and follow the instructions to complete the installation.

To download a paid application

- 1 In Google Play™, find an item you wish to download by browsing categories, or by using the search function.
- 2 Tap the item to view its details, and follow the instructions to complete your purchase.

To open a downloaded application

- 1 In Google Play™, press , then tap **My Apps**.
- 2 Tap the downloaded application.

- 💡 You can also access downloaded applications from the Application screen.

Clearing your application data

You may sometimes need to clear data for an application. This might happen if, for example, the application memory becomes full, or you want to clear high scores for a game. You might also want to erase incoming email, text and multimedia messages in some applications.

To clear all cache for an application

- 1 From your **Home** screen, tap .
- 2 Find and tap **Settings**.
- 3 Tap **Apps**.
- 4 Tap the application for which you want to clear all cache.
- 5 Tap **Clear cache**.

! It is not possible to clear the cache for some applications.

To delete an installed application

- 1 From your **Home** screen, tap .
- 2 Find and tap **Settings**.
- 3 Tap **Apps**.
- 4 Select the application that you want to delete.
- 5 Tap **Uninstall**.

! It is not possible to delete some preinstalled applications.

Permissions

Some applications may need to access data, settings and various functions on your device in order to work properly. If so, then they need the relevant permissions from you. For example, a navigation application needs permissions to send and receive data traffic, and access your location. Some applications might misuse their permissions by stealing or deleting data, or by reporting your location. Make sure you only install and give permissions to applications you trust.

To view permissions of an application

- 1 From your **Home** screen, tap .
- 2 Find and tap **Settings**.
- 3 Tap **Apps**.
- 4 Tap the desired application.
- 5 Scroll down to view the relevant details under **Permissions**.

Installing applications not from Google Play™

Installing applications of unknown or unreliable origin can damage your device. By default, your device is set to block such installations. However, you can change this setting and allow installations from unknown sources.

! Sony does not warrant or guarantee the performance of any third-party applications or content transferred via download or other interface to your device. Similarly, Sony is not responsible for any damage or reduced performance of your device attributable to the transfer of third-party content. Only use content from reliable sources. Contact the content provider if you have any questions or concerns.

To allow the installation of applications not from Google Play™

- 1 From your **Home** screen, tap .
- 2 Find and tap **Settings > Security**.
- 3 Mark the **Unknown sources** checkbox.
- 4 Tap **OK**.

Calling

Emergency calls

Your device supports international emergency numbers, for example, 112 or 911. You can normally use these numbers to make emergency calls in any country, with or without the SIM card inserted if you are within range of a network.

To make an emergency call

- 1 From your **Home screen**, tap .
- 2 Find and Tap **Phone**.
- 3 Enter the emergency number and tap **Call**. To delete a number, tap .

- 💡 You can make emergency calls when no SIM card is inserted or when outgoing calls are barred.





To make an emergency call while the SIM card is locked

- 1 Tap **Emergency call**.
- 2 Enter the emergency number and tap **Call**. To delete a number, tap .

Call handling

You can make a call by manually dialling a phone number, by tapping a number saved in your contact list, or by tapping the phone number in your call log view. You can also use the smart dial feature to quickly find numbers from your contact list and call logs.

To dial a phone number

- 1 From your **Home screen**, tap .
- 2 Find and tap .
- 3 If the call log appears, tap  to enter the dialpad view.
- 4 Enter the phone number and tap .

- 💡 To delete a digit entered by mistake, tap .

To make a call using smart dial

- 1 From your **Home screen**, tap .
- 2 Find and tap **Phone**.
- 3 Use the dialpad to enter letters or numbers that correspond to the contact you want to call. As you enter each letter or number, a list of possible matches appears.
- 4 Tap the contact you want to call.

To end a call

- Tap **End call**.

To make an international call

- 1 From your **Home screen**, tap .
- 2 Find and tap **Phone**.
- 3 Touch and hold 0 until a “+” sign appears.
- 4 Enter the country code, area code (without the first 0) and phone number, then tap **Call**.

To answer a call

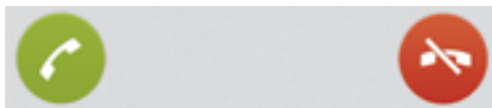

- Drag  to the right across the screen.

To decline a call

- Drag  to the left across the screen.

To reject a second call

- When you hear repeated beeps during a call, tap .

To change the ear speaker volume during a call

- Press the volume key up or down.

To turn on the loudspeaker during a call

- Tap .

To mute the microphone during a call

- Tap .

To activate the screen during a call

- Briefly press .

To enter numbers during a call

- 1 During the call, tap **Dialpad**. A keypad appears.
- 2 Tap the numbers you want to enter.

To mute the ringtone for an incoming call

- When you receive the call, press the volume key.

Recent calls

In the call log, you can view missed , received  and dialled  calls.

To view your missed calls

- 1 When you have missed a call,  appears in the status bar. Drag the status bar downwards.
- 2 Tap **Missed call**.

To call a number from your call log

- 1 From your **Home screen**, tap .
- 2 Find and tap **Phone**. The call log view appears on the upper part of the screen.
- 3 To call a number directly, tap the number. To edit a number before calling, touch and hold the number, then tap **Edit number before call**.

- ! You can also call a number by tapping **> > Call back**.

To add a number from the call log to your contacts

- 1 From your **Home screen**, tap .
- 2 Find and tap **Phone**. The call log view appears on the upper part of the screen.
- 3 Touch and hold the number, then tap **Add to Contacts**.
- 4 Tap the desired contact, or tap **Create new contact**.
- 5 Edit the contact details and tap **Done**.

Voicemail

If your subscription includes a voicemail service, callers can leave voice messages for you when you can't answer calls. Your voicemail service number is normally saved on your SIM card. If not, you can get the number from your service provider and enter it manually.

To enter your voicemail number

- 1 From the **Home screen**, tap .
- 2 Find and tap **Settings > Call settings > Voicemail > Voicemail settings > Voicemail number**.
- 3 Enter your voicemail number.
- 4 Tap **OK**.

To call your voicemail service

- 1 From your **Home screen**, tap .
- 2 Find and tap **Phone**.
- 3 Touch and hold **1**.

Multiple calls

If you have activated call waiting, you can handle multiple calls at the same time. When it is activated, you will be notified by a beep if you receive another call.

To activate or deactivate call waiting

- 1 From the **Home screen**, tap .
- 2 Find and tap **Settings > Call settings > Additional settings**.
- 3 To activate or deactivate call waiting, tap **Call waiting**.

To answer a second call and put the ongoing call on hold

- When you hear repeated beeps during a call, tap .

To make a second call

- 1 During an ongoing call, tap **Dialpad**.
- 2 Enter the number of the recipient and tap **Call**.
- 3 The first call is put on hold.

- 💡 The same procedure applies to subsequent calls.

To switch between multiple calls

- To switch to another call and put the current call on hold, tap .

To end the ongoing call and return to the next call on hold

- Tap **End call**.

Conference calls

With a conference or multiparty call, you can have a joint conversation with two or more persons.

- ! For details on the number of participants you can add to a conference call, contact your network operator.

To make a conference call

- 1 During an ongoing call, tap **Dialpad**.
- 2 Dial the number of the second participant and tap **Call**. After the second participant answers, the first participant is put on hold.
- 3 Tap  to add the second participant to the conference call.
- 4 Repeat steps 1 to 3 to add more call participants.

To have a private conversation with a conference call participant

- 1 During an ongoing conference call, tap **{0} participants**.
- 2 Tap the telephone number of the participant with whom you want to talk privately.
- 3 To end the private conversation and return to the conference call, tap ➤.

To release a participant from a conference call

- 1 During an ongoing conference call, tap the button showing the number of participants. For example, tap **3 participants** if there are three participants.
- 2 Tap  next to the participant you want to release.

To end a conference call

- During the conference call, tap **End conference call**.

Call settings

Barring calls

You can bar all or certain categories of incoming and outgoing calls. When you use call barring for the first time, you need to enter your PUK (Personal Unblocking Key) and then a new password to activate the call barring function.

To bar incoming or outgoing calls

- 1 From your **Home screen**, tap .
- 2 Find and tap **Settings > Call settings > Call barring**.
- 3 Select an option.
- 4 Enter the password and tap **Enable**.

Rejecting a call with a message

You can reject a call with a predefined message. When you reject a call with such a message, the message is automatically sent to the caller and saved on your device.

Six messages are predefined on your device. You can select from these predefined messages, which can also be edited if necessary.

To reject a call with a predefined message

- Drag **Reject with message** upward, then select a message.

To reject a second call with a predefined message

- When you hear repeated beeps during a call, drag **Reject with message** upward, then select a message.

To edit the message used to reject a call

- 1 From your **Home screen**, tap .
- 2 Find and tap **Settings > Call settings > Reject call with message**.
- 3 Tap the message you want to edit, then make the necessary changes.
- 4 When you're done, tap **OK**.

Forwarding calls

You can forward calls, for example, to another phone number, or to an answering service.

To forward calls

- 1 From your **Home screen**, tap .
- 2 Find and tap **Settings > Call settings > Call forwarding**.
- 3 Select an option.
- 4 Enter the number you want to forward the calls to, then tap **Enable**.

To turn off call forwarding

- 1 From your **Home** screen, tap .
- 2 Find and tap **Settings** > **Call settings** > **Call forwarding**.
- 3 Select an option, then tap **Disable**.

Showing or hiding your phone number

You can select to show or hide your phone number on call recipients' devices when you call them.

To show or hide your phone number

- 1 From your **Home** screen, tap .
- 2 Find and tap **Settings** > **Call settings** > **Additional settings** > **Caller ID**.

Fixed Dialling Numbers

If you have received a PIN2 code from your service provider, you can use a list of Fixed Dialling Numbers (FDN) to restrict outgoing calls.

To enable or disable fixed dialling

- 1 From your **Home** screen, tap .
- 2 Find and tap **Settings** > **Call settings** > **Fixed dialling numbers**.
- 3 Tap **Activate fixed dialling** or **Deactivate fixed dialling**.
- 4 Enter your PIN2 and tap **OK**.

To access the list of accepted call recipients

- 1 From your **Home** screen, tap .
- 2 Find and tap **Settings** > **Call settings** > **Fixed dialling numbers** > **Fixed dialling numbers**.

Contacts

About Contacts

Use the Contacts application to store and manage all your numbers, email addresses, and other contact data in one place. Just tap on a contact to see all communications with that contact in one easy overview.

You can add new contacts in your device and synchronise them with contacts saved in your Google™ account, Microsoft® Exchange ActiveSync® account, or other accounts that support synchronisation. The Contacts application automatically creates new entries and also helps you match data such as email addresses with existing entries.

Transferring contacts to your new device

There are several ways to transfer contacts to your new device. Select a transfer method that best suits your situation.

Transferring contacts using a PC

You can use a PC to transfer contacts from several device brands, including iPhone, Samsung, HTC and Nokia.

You need:

- An Internet-connected PC running Windows®
- A USB cable for your old device
- A USB cable for your new Android™ device
- Your old device
- Your new Android™ device

Using the PC Companion program to transfer contacts

If you are transferring contacts using a PC, use the PC Companion program. It's free, and the installation files are already saved on your new device. PC Companion also offers a range of other features, including help to update your device software.

To install PC Companion

- 1 **New device:** Turn on your new Android™ device and connect it to a PC using a USB cable.
- 2 **New device:** Tap **Install** to install PC Companion on the PC.
- 3 **Computer:** If a popup window appears to notify you about available PC software, select *Run Startme.exe*.
- 4 **Computer:** Click *Install* to start the installation and then follow the instructions to complete the installation.

To transfer contacts to your new device using PC Companion

- 1 Make sure that PC Companion is installed on your PC.
- 2 Open the PC Companion program on the PC, then click *Contacts Setup* and follow the instructions to transfer your contacts.

Transferring contacts using an Apple® Mac® computer





For detailed instructions on how to use an Apple Mac computer to transfer contacts from your old device, go to *Transfer your contacts*.

Transferring contacts using synchronisation accounts

Your device works with popular online synchronisation accounts such as Google Sync™, Microsoft® Exchange ActiveSync® or Facebook™. If you have synced the contacts in your old device or your computer with an online account, you can transfer



your contacts to your new device using that account. For more detailed information about synchronisation, see *Synchronising your corporate email, calendar and contacts* on page 110.

To synchronise contacts on your device with a synchronisation account

- 1 From your **Home screen**, tap , then tap .
- 2 Tap , then tap **Settings > Accounts & sync**.
- 3 If you have already set up a synchronisation account and you want to sync with that account, tap the account, then tap , and tap **Sync now**.



Transferring contacts from a SIM card

To import contacts from a SIM card

- 1 From your **Home screen**, tap , then tap .
- 2 Press , then tap **Import contacts > SIM card**.
- 3 If you have set up a synchronisation account, you can choose to add the SIM card contacts under that account. Or you can choose to only use these contacts on your device. Select your desired option.
- 4 To import an individual contact, find and tap the contact. To import all contacts, tap **Import all**.

Transferring contacts from a memory card

To import contacts from a memory card

- 1 From your **Home screen**, tap , then tap .
- 2 Press , then tap **Import contacts > SD card**.
- 3 If you have set up a synchronisation account, you can add the imported memory card contacts under that account. Or you can choose to only use the imported contacts on your device. Select your desired option.
- 4 If you have more than one vCard file on the SD card, a list appears showing different batches of contacts saved on your device, with the corresponding dates for when they were created. Select the batch that you want to import.

Receiving contacts from other devices

To receive contact data sent using Bluetooth™ technology

- 1 Make sure you have the Bluetooth™ function turned on and your device set to visible. If not, then you cannot receive data from other devices.
- 2 When you are asked to confirm whether you want to receive the file, tap **Accept**.
- 3 Drag down the Notification panel and tap the file you received to import the contact data.

To receive contacts sent using a messaging service

- 1 When you receive a new text message, multimedia message, or email message, open the message.
- 2 The received contact data appears as a vCard attachment. Tap, or touch and hold the vCard file to open a menu so you can save the contact data.

Contacts screen overview

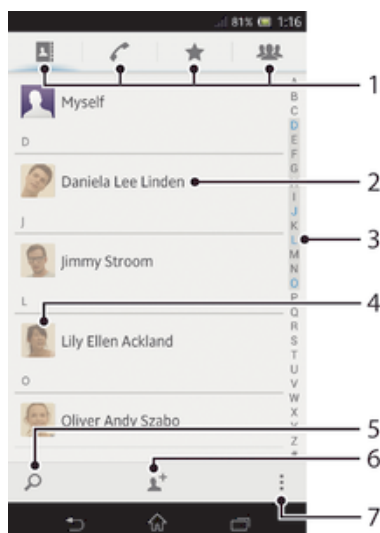

1 Shortcut tabs

2 Tap a contact to view its details

3 Alphabetical index for browsing contacts

4 Tap a contact thumbnail to access the quick contact menu

5 Search for contacts

6 Create a contact

7 Open more options

Managing your contacts

You can create, edit and synchronise your contacts in a few simple steps. You can select contacts saved in different accounts and manage how you display them on your device.



If you synchronise your contacts with more than one account, you can join contacts on your device to avoid duplicates.

- ! Some synchronisation services, for example, some social networking services, do not allow you to edit contact details.





To view your contacts

- From your Home screen, tap , then tap . Your contacts are listed here.



To select which contacts to display in the Contacts application

- From your Home screen, tap , then tap .
- Press , then tap Filter.
- In the list that appears, mark and unmark the desired options. If you have synchronised your contacts with a synchronisation account, that account appears in the list. To further expand the list of options, tap the account.
- When you are finished, tap OK.





To add a contact

- 1 From your **Home screen**, tap , then tap .
 - 2 Tap .
 - 3 If you have synchronised your contacts with one or more accounts, select the account to which you want to add this contact, or tap **Phone contact** if you only want to use this contact on your device.
 - 4 Enter or select the desired information for the contact.
 - 5 When you are finished, tap **Done**.
-  If you add a plus sign and the country code before a contact's phone number, you do not have to edit the number again when you make calls from other countries.



To edit a contact

- 1 From the **Home screen**, tap , then tap .
- 2 Tap the contact you want to edit, then tap .
- 3 Edit the desired information. When you are finished, tap **Done**.





To associate a picture with a contact

- 1 From your **Home screen**, tap , then tap .
 - 2 Tap the contact you want to edit, then tap .
 - 3 Tap  and select the desired method for adding the contact picture.
 - 4 When you have added the picture, tap **Done**.
-  You can also add a picture to a contact directly from the **Album** application.



To view your communication with a contact

- 1 From the **Home screen**, tap , then tap .
- 2 Tap the contact you want to view.
- 3 To view your communication with the contact for different media, tap or flick through the filter items at the bottom of the screen.

To delete contacts

- 1 From your **Home screen**, tap , then tap .
- 2 Touch and hold the contact you want to delete. To delete all contacts, press , then tap **Mark several**.
- 3 Tap the downwards arrow to open the drop down menu, then select **Mark all**.
- 4 Tap , then tap **OK**.



To edit contact information about yourself

- 1 From your **Home screen**, tap , then tap .
- 2 Tap **Myself**, then tap .
- 3 Enter the new information or make the changes you want.
- 4 When you are done, tap **Done**.



Avoiding duplicate entries in the Contacts application

If you synchronise your contacts with a new account or import contact information in other ways, you could end up with duplicate entries in the Contacts application. If this happens, you can join such duplicates to create a single entry. And if you join entries by mistake, you can separate them again later.

To link contacts

- 1 From your **Home screen**, tap , then tap .
- 2 Tap the contact you want to link with another contact.
- 3 Press , then tap **Link contact**.
- 4 Tap the contact whose information you want to join with the first contact, then tap **OK** to confirm. The information from the first contact is merged with the second contact, and the first contact is no longer displayed in the Contacts list.



To separate linked contacts

- 1 From your **Home screen**, tap , then tap .
- 2 Tap the linked contact you want to edit, then tap .
- 3 Tap **Unlink contact**.
- 4 Tap **OK**.



Favourites

You can mark contacts as favourites so that you can get quick access to them from the Contacts application.

To mark or unmark a contact as a favourite

- 1 From the **Home screen**, tap , then tap .
- 2 Tap the contact you want to add to or remove from your favourites.
- 3 Tap .

To view your favourite contacts

- 1 From your **Home screen**, tap , then tap .
- 2 Tap .

Groups



You can assign contacts to groups to get quicker access to them from within the Contacts application.

To assign a contact to a group

- 1 In the Contacts application, tap the contact that you want to assign to a group.
- 2 Tap , then tap the bar directly under **Assign to group**.
- 3 Mark the checkboxes for the groups to which you want to add the contact, then tap **Done**.
- 4 Tap **Done**.

Communicating with your contacts

To search for a contact

- 1 From your **Home screen**, tap , then tap .
- 2 Tap  and enter the first few letters of the contact name in the **Search contacts** field. All contacts beginning with those letters appear.



The quick contact menu

Tap a contact's thumbnail to view quick communication options for a particular contact. Options include calling the contact, sending a text or multimedia message, and starting a chat using the Google Talk™ application.



- !
- For an application to appear as an option in the quick contact menu, you may need to set up the application in your device and be logged in to the application. For example, you need to start the Gmail™ application and enter your login details before you can use Gmail™ from the quick contact menu.

Sharing your contacts





To send your business card

- 1 From your **Home screen**, tap , then tap .
- 2 Tap **Myself**.
- 3 Press , then tap **Send contact > OK**.
- 4 Select an available transfer method and follow the on-screen instructions.

To send a contact

- 1 From your **Home screen**, tap , then tap .
- 2 Tap the contact whose details you want to send.
- 3 Press , then tap **Send contact** > **OK**.
- 4 Select an available transfer method and follow the on-screen instructions.



To send several contacts at once

- 1 From your **Home screen**, tap , then tap .
- 2 Press , then tap **Mark several**.
- 3 Mark the contacts you want to send, or select all if you want to send all contacts.
- 4 Tap , then select an available transfer method and follow the on-screen instructions.



Backing up contacts

You can use a memory card, a SIM card or an online synchronisation tool such as Microsoft® Exchange ActiveSync® to back up contacts.

To export all contacts to a memory card

- 1 From your **Home screen**, tap , then tap .
- 2 Press , then tap **Back up contacts** > **Memory Card**.
- 3 Tap **OK**.

To export contacts to a SIM card

- 1 From your **Home screen**, tap , then tap .
 - 2 Press , then tap **Back up contacts** > **SIM card**.
 - 3 Mark the contacts you want to export, or tap **Mark all** if you want to export all your contacts.
 - 4 Tap **Back up**.
 - 5 Select **Add contacts** if you want to add the contacts to existing contacts on your SIM card, or select **Replace all contacts** if you want to replace the existing contacts on your SIM card.
- ! When you export contacts to a SIM card, not all information may get exported. This is due to memory limitations on SIM cards.







Messaging

Using text and multimedia messaging

You can send and receive text messages from your device using SMS (Short Message Service). If your subscription includes MMS (Multimedia Messaging Service), you can also send and receive messages that contain media files, for example, pictures and videos. The number of characters you can send in a single text message varies depending on the operator and the language you use. If you exceed the character limit, then all your single messages are linked together and sent as one message. You are charged for each single text message you send. When you view your messages, they appear as conversations, which means that all messages to and from a particular person are grouped together.



- ! To send multimedia messages, you need the correct MMS settings on your device. See *Internet and messaging settings*.

To create and send a message

- 1 From your **Home screen**, tap , then find and tap .
- 2 Tap .
- 3 Tap , then select the desired recipients from the Contacts list. If the recipient is not listed as a contact, enter the contact's number manually and tap .
- 4 When you are finished adding recipients, tap **Done**.
- 5 Tap **Write message** and enter your message text.
- 6 If you want to add a media file, tap  and select an option.
- 7 To send the message, tap **Send**.



- 💡 If you exit a message before sending, it gets saved as a draft. The conversation gets tagged with the word **Draft**.

To read a received message





- 1 From your **Home screen**, tap , then find and tap .
- 2 Tap the desired conversation.
- 3 If the message is not yet downloaded, tap and hold the message, then tap **Download message**.

- 💡 You can also open messages from the status bar when  appears there. Just drag down the bar and tap the message.

To reply to a message



- 1 From your **Home screen**, tap , then find and tap .
- 2 Tap the conversation containing the message.
- 3 Enter your reply and tap **Send**.

To forward a message





- 1 From your **Home screen**, tap , then find and tap .
- 2 Tap the conversation containing the message you want to forward.
- 3 Touch and hold the message you want to forward, then tap **Forward message**.
- 4 Tap , then select a recipient from the Contacts list. If the recipient is not listed as a contact, enter the contact's number manually and tap .
- 5 When you are finished adding recipients, tap **Done**.
- 6 Edit the message, if necessary, and tap **Send**.

- 💡 In step 4, you can also tap **To** and enter the recipient's phone number manually.



To delete a message

- 1 From your **Home screen**, tap , then find and tap .
- 2 Tap the conversation containing the message you want to delete.
- 3 Touch and hold the message you want to delete, then tap **Delete message** > **Delete**.



To delete conversations

- 1 From your **Home screen**, tap , then find and tap .
- 2 Tap , then tap **Delete conversations**.
- 3 Mark the checkboxes for the conversations that you want to delete, then tap  > **Delete**.



To save a sender's number

- 1 From your **Home screen**, tap , then find and tap .
- 2 Tap  > **Save**.
- 3 Select an existing contact, or tap **Create new contact**.
- 4 Edit the contact information and tap **Done**.





To call a message sender

- 1 From your **Home screen**, tap , then find and tap .
- 2 Tap a conversation.
- 3 Tap the recipient name or number at the top of the screen, then select the recipient name or number from the list that appears.
- 4 If the recipient is saved in your contacts, tap the phone number that you want to call. If you have not saved the recipient in your contacts, tap .



To save a file contained in a message you receive

- 1 From your **Home screen**, tap , then find and tap .
- 2 Tap the conversation you want to open.
- 3 If the message has not been downloaded yet, tap and hold the message, then tap **Download message**.
- 4 Touch and hold the file you want to save, then select the desired option.



To star a message

- 1 From your **Home screen**, tap , then find and tap .
- 2 Tap the conversation you want to open.
- 3 In the message you want to star, tap .
- 4 To unstar a message, tap .

To view starred messages



- 1 From your **Home screen**, tap , then find and tap .
- 2 Tap , then tap **Starred messages**.
- 3 All starred messages appear in a list.

To search for messages



- 1 From your **Home screen**, tap , then find and tap .
- 2 Tap , then tap **Search**.
- 3 Enter your search keywords, then tap the confirm key.

Text and multimedia message options



To change your message notification settings

- 1 From your **Home screen**, tap , then find and tap .
- 2 Tap , then tap **Settings**.
- 3 To set a notification sound, tap **Notification tone** and select an option.
- 4 For other notification settings, check or uncheck the relevant checkboxes.

To change the delivery report settings for outgoing messages

- 1 From your **Home screen**, tap , then find and tap .
- 2 Tap , then tap **Settings**.
- 3 Tap **Delivery report** to activate or deactivate delivery reports.

To view messages saved on the SIM card

- 1 From your **Home screen**, tap , then find and tap .
- 2 Tap , then tap **Settings** > **SIM messages**.

Google Talk™

The Google Talk™ application lets you chat with your friends using text, voice and video.

To start Google Talk™

- 1 From your Home screen, tap .
- 2 Find and tap Talk.

To reply to an instant message with Google Talk™

- 1 When someone contacts you on Google Talk™,  appears in the status bar.
- 2 Drag the status bar downwards, then tap the message and begin to chat.



Email

Getting started with Email



You can handle several email accounts at the same time using the Email application, including corporate Microsoft Exchange Active Sync accounts. Emails you receive to your Gmail™ account can be accessed on your device from both the Email and the Gmail™ applications.

Using email accounts



To set up an email account on your device

- 1 From your **Home screen**, tap .
 - 2 Find and tap **Email**.
 - 3 Follow the instructions that appear on the screen to complete the setup.
-  For some email services, you may need to contact your email service provider for information on detailed settings for the email account.



To set an email account as your default account

- 1 From your **Home screen**, tap .
 - 2 Find and tap **Email**.
 - 3 Press , then tap **Settings**.
 - 4 Select the account you want to use as the default account for composing and sending emails.
 - 5 Mark the **Default account** checkbox. The inbox of the default account appears every time you open the email application.
-  If you only have one email account, this account is automatically the default account.

To add an extra email account on your device

- 1 From your **Home screen**, tap .
- 2 Find and tap **Email**.
- 3 Tap  at the top of the screen, then tap **Add account**.
- 4 Enter the email address and password, then tap **Next**. If the settings for the email account cannot be downloaded automatically, complete the setup manually.
- 5 When prompted, enter a name for your email account so that it is easily identifiable. The same name shows in the emails you send from this account.
- 6 When you are finished, tap **Next**.

To remove an email account from your device



- 1 From your **Home screen**, tap .
- 2 Find and tap **Email**.
- 3 Press , then tap **Settings**.
- 4 Select the account you want to remove.
- 5 Tap **Delete account** > **OK**.

Gmail™ and other Google™ services

If you have a Google™ account, you can use the Gmail™ application on your device to read, write and organise email messages. After you set up your Google™ account to work on your device, you can also chat to friends using the Google Talk™ application, synchronise your calendar application with your Google Calendar™, and download applications and games from Google Play™.

-  The services and features described in this chapter may not be supported in all countries or regions, or by all networks and/or service providers in all areas.

To set up a Google™ account on your device





- 1 From your **Home screen**, tap .
 - 2 Find and tap **Settings > Add account > Google**.
 - 3 Follow the registration wizard to create a Google™ account, or sign in if you already have an account.
-  You can also sign in to or create a Google™ account from the setup guide the first time you start your device. Or you can go online and create an account at www.google.com/accounts.

To open the Gmail™ application





- 1 From the **Home screen**, tap .
- 2 Find and tap **Gmail**.

Using email



To create and send an email message

- 1 Make sure that you have set up an email account.
- 2 From your **Home screen**, tap , then find and tap **Email**.
- 3 If you are using several email accounts, tap  at the top of the screen and select the account that you want to use.
- 4 Tap , then tap **To** and start typing the recipient's name or email address, or tap  and select one or more recipients from your **Contacts list**.
- 5 Enter the email subject and message text, then tap .



To receive email messages



- 1 From your **Home screen**, tap .
 - 2 Find and tap **Email**.
 - 3 If you are using several email accounts, tap  at the top of the screen and select the account that you want to check. If you want to check all your email accounts at once, tap **Combined view**.
 - 4 To download new messages, tap .
-  If you have set up a corporate email account, you can set the check frequency to **Automatic (Push)**.

To read your email messages



- 1 From your **Home screen**, tap .
- 2 Find and tap **Email**.
- 3 If you are using several email accounts, tap  at the top of the screen and select the account you want to check. If you want to check all your email accounts at once, tap **Combined view**.
- 4 In the email inbox, scroll up or down and tap the email you want to read.

To use the email preview pane



- 1 From your **Home screen**, tap , then find and tap **Email**.
- 2 If you are using several email accounts, tap  and select the account you want to check. If you want to check all your email accounts at once, tap **Combined view**.
- 3 Hold your device horizontally. The email preview pane appears.
- 4 Scroll up or down in the email inbox and tap the email you want to read. The email opens in the preview pane. To view more information about the email, tap the downward arrow next to the sender's name. In the body text field, pinch two fingers together, or spread them apart, to zoom out or in.
- 5 To view the email in fullscreen format, tap the split bar (located between the email list and email body) accordingly. In fullscreen format, use the leftward and rightward arrows to read your previous or next message.
- 6 To return to the inbox view, tap the split bar accordingly.

-  Before using the preview pane, activate it in the preview pane settings.
-  To hide the preview pane, hold your device vertically, or change the preview pane settings.

To change email preview pane settings

- 1 From your **Home screen**, tap , then find and tap **Email**.
- 2 Press , then tap **Settings**.
- 3 Tap **General** > **Preview pane**, then select an option.



To view an email message attachment

- 1 From your **Home screen**, tap .
- 2 Find and tap **Email**.
- 3 Find and tap the email message containing the attachment that you want to view. Emails with attachments are indicated by .
- 4 After the email message opens, tap , then tap **View**.





To save a sender's email address to your contacts

- 1 From your **Home screen**, tap .
- 2 Find and tap **Email**.
- 3 Find and tap a message in your email inbox.
- 4 Tap the name of the sender, then tap **OK**.
- 5 Select an existing contact, or tap **Create new contact**.
- 6 Edit the contact information, if desired, then tap **Done**.



To reply to an email message

- 1 From your **Home screen**, tap .
- 2 Find and tap **Email**.
- 3 In your email inbox, find and tap the message you want to reply to, then tap .
- 4 Tap **Reply** or **Reply all**.
- 5 Enter your reply, then tap .



To forward an email message

- 1 From your **Home screen**, tap .
- 2 Find and tap **Email**.
- 3 In your email inbox, find and tap the message you want to forward, then tap .
- 4 Tap **Forward**.
- 5 Tap **To** and enter the recipient's email address manually, or tap  to select a recipient from your contacts.
- 6 Enter your message text, then tap .



To delete an email message

- 1 From your **Home screen**, tap .
- 2 Find and tap **Email**.
- 3 In your email inbox, find and tap the message you want to delete, then tap .
- 4 Tap **Yes**.

To sort your emails



- 1 From your **Home screen**, tap .
- 2 Find and tap **Email**.
- 3 If you are using several email accounts, tap  at the top of the screen and select the account that you want to check. If you want to check all your email accounts at once, tap **Combined view**.
- 4 Press , then tap **Sort**.
- 5 Select a sorting option.

To search for emails



- 1 From your **Home screen**, tap , then find and tap **Email**.
- 2 Tap  at the top of the screen and select the account that you want to search.
- 3 Tap .
- 4 Enter your search text, then tap **Go** on your keyboard.
- 5 The search result appears in a list sorted by date. Tap the email that you want to open.

-  To change search options, tap  and select a different option.



To view all folders for one email account

- 1 From your **Home screen**, tap . Then find and tap **Email**.
- 2 Tap  at the top of the screen and select the account you want to check, then tap  again and select **Show all folders** to view all the folders in this account.

To change the inbox check frequency

- 1 From your **Home screen**, tap .
- 2 Find and tap **Email**.
- 3 Press , then tap **Settings**.
- 4 Select the account for which you want to change the inbox check frequency.
- 5 Tap **Inbox check frequency** and select an option.

To set an Out of Office auto-reply in an Exchange Active Sync account

- 1 From your **Home screen**, tap , then find and tap **Email**.
- 2 Press , then tap **Settings**.
- 3 Select the EAS (Exchange Active Sync) account for which you want to set an Out of Office auto-reply.
- 4 Tap **Out of office**.
- 5 Tap beside **Out of office** so that changes to .
- 6 If needed, mark the **Set time range** checkbox and set the time range for the auto reply.
- 7 Enter your Out of Office message in the body text field.
- 8 Tap **OK** to confirm.

Socialife™

Using the Socialife™ application

Use the Socialife™ application from Sony to get your favourite news, videos and social networking feeds in one place. The Socialife™ home screen gives a clear overview of friends' Facebook and Twitter activity, plus news feeds that you have subscribed to. It colour-codes and sizes articles for easy reading, adding photos and cropping images of your friends' faces to illustrate each story.

- ! The Socialife™ application is not available in all markets.

To open the Socialife™ application

- 1 From your Home screen, tap .
- 2 Find and tap .

"WALKMAN" application

About the "WALKMAN" application

Get the most out of your "WALKMAN" application. Listen to and organise music and audio books that you have transferred to your device from a computer, or purchased and downloaded from online stores.

To make content easily available to the "WALKMAN" application, you can use the Media Go™ application. Media Go™ helps transfer music content between a computer and your device. For more information, see *Connecting your device to a computer* on page 104.

"WALKMAN" application overview





- 1 Browse your music
- 2 Search all tracks saved on your device
- 3 Tap the infinite button to find related information online and plug-ins on Google Play™
- 4 Album art (if available)
- 5 Go to the next track in the current play queue, or fast forward
- 6 Total time length of the track
- 7 Elapsed time of current track
- 8 Progress indicator – drag the indicator or tap along the line to fast forward or rewind
- 9 Play/Pause button
- 10 Go to the previous track in the current play queue, or rewind

Transferring media files to your device

Before using the "WALKMAN" application, it's a good idea to transfer all your favourite media content from a computer to your device and then play or view this content on your device. Media content can include music, photos and videos. The easiest way to transfer files is with a USB cable. After you connect your device and the computer using the USB cable, you can use the file manager application on the computer or the Media Go™ application to transfer the files.



Using the "WALKMAN" application

To play audio content

- 1 From your **Home screen**, tap , then find and tap .
- 2 In **My music**, select a music category and browse to the track that you want to open.
- 3 Tap a track to play it.

- ! You might not be able to play copyright-protected items. Please verify that you have necessary rights in material that you intend to share.

To change tracks

- When a track is playing, tap  or .
- When a track is playing, swipe the album art left or right.

To pause a track

- Tap .



To fast forward and rewind music

- Touch and hold  or .
- 💡 You can also drag the progress indicator marker right or left.

To adjust the audio volume

- Press the volume key.

To improve the sound quality using the equaliser

- 1 When the "WALKMAN" application is open, tap .
- 2 Tap **Settings > Sound enhancements**.
- 3 To adjust the sound manually, drag the frequency band buttons up or down. To adjust the sound automatically, tap  and select a style.



To turn on the surround sound feature

- 1 When the "WALKMAN" application is open, tap .
- 2 Tap **Settings > Sound enhancements > Settings > Surround sound (VPT)**.
- 3 Select a setting, then tap **OK** to confirm.

To view the current play queue

- 1 While a track is playing in the "WALKMAN" application, tap .
- 2 Tap **Play queue**.

To minimise the "WALKMAN" application

- When the "WALKMAN" application is playing, tap  to go to the previous screen, or tap  to go to the **Home screen**. The "WALKMAN" application stays playing in the background.

To open the "WALKMAN" application when it is playing in the background

- 1 While a track is playing in the background, drag the status bar downwards to open the Notification panel.
- 2 Tap the track title to open the "WALKMAN" application.

- 💡 Alternatively, you can press  and then select the "WALKMAN" application.

To delete a track

- 1 In **My music**, browse to the track that you want to delete.
- 2 Touch and hold the track title, then tap **Delete**.

- 💡 You can also delete albums this way.

To send a track

- 1 In **My music**, when browsing your tracks, touch and hold a track title.
 - 2 Tap **Send**.
 - 3 Select an application from the list, and follow the on-screen instructions.
- 💡 You can also send albums and playlists in the same way.



To "Like" a track on Facebook™

- 1 While the track is playing in the "WALKMAN" application, tap the album art.
- 2 Tap  to show that you "Like" the track on Facebook™. If desired, add a comment in the comments field.
- 3 Tap **Share** to send the track to Facebook™. If the track is received successfully, you will get a confirmation message from Facebook™.



Visualiser

The Visualiser adds visual effects to your music tracks as you play them. The effects for each track are based on the characteristics of the music. They change, for example, in response to changes in the music's loudness, rhythm and frequency level. You can also change the background theme.

To turn on the Visualiser

- 1 In the "WALKMAN" application, tap .
 - 2 Tap **Visualiser**.
- 💡 Tap  to switch to full screen view.

To change the background theme

- 1 In the "WALKMAN" application, tap .
- 2 Tap **Visualiser**.
- 3 Tap  > **Theme** and select a theme.

Getting more information about a track or artist

In the "WALKMAN" application, you can get more information about the artist that you are listening to by tapping the infinite button .

The infinite button  also gives you access to related content such as:

- Music videos on YouTube™
 - Artist info on Wikipedia
 - Lyrics on Google
 - Karaoke videos on YouTube™
 - Extension searches on the web
 - Content from the PlayNow™ service
- ! The accuracy of search results may vary.

To get more information about an artist or track

- When a track is playing in the "WALKMAN" application, tap .

Using My music to organise your tracks

Tap the **My music** tab in the "WALKMAN" application to get an overview of all the tracks that are available from your device. In **My music**, you can manage your albums and playlists, create shortcuts, and arrange your music by mood and tempo.

Overview of My music



- 1 Go back to the current track
- 2 Picture of the currently playing artist (if available)
- 3 Browse your music by artist
- 4 Categorise your music using SensMe™ channels
- 5 Manage and edit your music using Music Unlimited™
- 6 Browse your favourite playlists
- 7 Collect links to music and related content that you and friends have shared using online services
- 8 Browse all playlists
- 9 Browse audio by track
- 10 Browse by album

To add a shortcut to a track

- 1 In **My music**, tap , , or , then browse to the track for which you want to create a shortcut.
- 2 Touch and hold the track title.
- 3 Tap **Add as shortcut**. The shortcut now appears in the **My music** main view.

To rearrange shortcuts

- In **My music**, touch and hold a shortcut until it magnifies and your device vibrates, then drag the item to a new location.

To delete a shortcut

- In **My music**, touch and hold a shortcut until it magnifies and your device vibrates, then drag the item to .

! You can only delete shortcuts that you create yourself.

To update your music with the latest information

- 1 In **My music**, tap .
- 2 Tap **Download music info** > **Start**. Your device searches online and downloads the latest available album art and track information for your music.

💡 The SensMe™ channels application is activated when you download music information.

Categorising your music using SensMe™ channels

The SensMe™ channels application helps you arrange your music by mood and tempo. SensMe™ groups all your tracks into several categories, or channels, so you can select music that matches your mood or suits the time of day.

To enable the SensMe™ channels application

- In **My music**, tap , then tap **Download music info**.
- ! This application requires a mobile or Wi-Fi® network connection.

Using the Friends' music function to share music

The Friends' music function collects links to music and music-related content that you and your friends have shared using Facebook™.

To manage music from your friends

- 1 In **My music**, tap **Friends' music > Recent**.
- 2 Tap an item to open it, then work on it as desired.
- 3 Tap  to show that you "Like" the track on Facebook™. If desired, add a comment in the comments field.



To view your shared music

- 1 In **My music**, tap **Friends' music > My shares**.
- 2 Scroll to an item you want to open, then tap it. All comments about the item, if any, are displayed.

Playing music in random order

You can play tracks in playlists in random order. A playlist can be, for example, a playlist you have created yourself or an album.

To play tracks in random order

- 1 In **My music**, tap  and navigate to an album, or tap  and browse to a playlist.
- 2 Tap the album art, then tap  to turn on **Shuffle mode**.

To turn off shuffle mode

- When tracks are playing in random order, tap the album art > .

Managing playlists

In **My music**, you can create your own playlists from the music that is saved on your device.

In addition, you can install the Media Go™ application on a computer and use it to copy playlists from the computer to your device.

To create your own playlists

- 1 In the WALKMAN player, tap the **MY MUSIC** tab.
- 2 Tap **Playlists**.
- 3 In the menu that opens, tap **Create new playlist**.
- 4 Enter a name for the playlist and tap **OK**.
- 5 Select your music and tap the **Save** icon at the top right of the screen.

To add tracks to a playlist

- 1 In **My music**, when browsing your tracks, touch and hold the name of the artist or the title of the album or track that you want to add.
- 2 Tap **Add to playlist**.
- 3 Tap the name of the playlist to which you want to add the artist, album or track. The artist, album or track is added to the playlist.

To play your own playlists

- 1 In **My music**, tap .
- 2 Under **Playlists**, tap a playlist.
- 3 Tap a track to play it.

To remove a track from a playlist

- 1 In a playlist, touch and hold the title of the track you want to delete.
- 2 Tap **Delete from playlist** from the list that appears.

To delete a playlist

- 1 In **My music**, then select **Playlists**.
- 2 Touch and hold the playlist you want to delete.
- 3 Tap **Delete**.
- 4 Tap **Delete** again to confirm.

- ! You cannot delete default playlists.

"WALKMAN" application widget

The "WALKMAN" application widget is a miniature application that gives you direct access to the "WALKMAN" application from your **Home screen**. You need to add this widget to your **Home screen** before you can use it.

To add the "WALKMAN" application widget to your Home screen

- 1 Tap an empty area on your **Home screen**, then tap **Widgets**.
- 2 Find and tap **WALKMAN**.

Protecting your hearing

Listening to the "WALKMAN" application or other media players at excessive volume or for a prolonged period of time can damage your hearing, even when the volume is at a moderate level. To alert you to such risks, a volume level warning appears when the volume is too high, and after the "WALKMAN" application is used for over 20 hours.

To turn off the volume level warning

- When  appears, tap **OK** to dismiss the warning.
- 💡 Every time you restart your device, the media volume is automatically set to a moderate level.

Music services

TrackID™ technology

Identifying music using TrackID™ technology

Use the TrackID™ music recognition service to identify a music track you hear playing in your surroundings. Just record a short sample of the song and you'll get artist, title and album info within seconds. You can purchase tracks identified by TrackID™ and you can view TrackID™ charts to see what TrackID™ users around the globe are searching for. For best results, use TrackID™ technology in a quiet area.

- ! The TrackID™ application and the TrackID™ service are not supported in all countries/regions, or by all networks and/or service providers in all areas.

To open the TrackID™ application

- 1 From your **Home screen**, tap .
- 2 Find and tap **TrackID™**.

- 💡 You can also use the TrackID™ widget to open the TrackID™ application.

To search for track information using TrackID™

- 1 Open the **TrackID™** application, then hold your device towards the music source.
- 2 Tap . If the track is recognised by the TrackID™ service, the results appear on the screen.

- 💡 To return to the TrackID™ start screen, press .

To view TrackID™ charts

- 1 Open the **TrackID™** application, then tap **Charts**. The first time you view a chart, it is set to your own region.
- 2 To see charts of the most popular searches in other regions, tap  > **Regions**.
- 3 Select a country or region.

Using TrackID™ technology results

Track information appears when the TrackID™ application recognises a track. You can select to purchase the track or share it using email, SMS or a social networking service. You can also get more information about the track's artist.

To buy a track recognised by the TrackID™ application

- 1 After a track has been recognised by the **TrackID™** application, tap **Download**.
- 2 Follow the instructions on your device to complete your purchase.

- 💡 You can also select a track to buy by opening the **History** or **Charts** tabs from the TrackID™ start screen.

- ! The track purchase feature may not be supported in all countries/regions, or by all networks and/or service providers in all areas.

To share a track

- 1 After a track has been recognised by the **TrackID™** application, tap **Share**, then select a sharing method.
- 2 Follow the instructions on your device to complete the procedure.

- 💡 You can also select a track to share by opening the **History** or **Charts** tabs from the TrackID™ start screen.

To view the artist information for a track

- After a track has been recognised by the TrackID™ application, tap **Artist info**.
- 💡 You can also view the artist information for a track by opening the **History** or **Charts** tabs from the TrackID™ start screen.

To delete a track from the track history

- 1 Open the TrackID™ application, then tap **History**.
- 2 Tap a track title, then tap **Delete**.
- 3 Tap **Yes** to confirm.

Music Unlimited™

Using Music Unlimited™

Music Unlimited™ is a subscription-based service that offers access to millions of songs over a mobile network or Wi-Fi® connection. You can manage and edit your personal music library in the cloud from a variety of devices, or sync your playlists and music using a PC that runs the Windows® operating system. Go to www.sonyentertainmentnetwork.com for more information.

- ! Music Unlimited™ might not be available in all countries or regions.

To open Music Unlimited™

- 1 From your **Home** screen, tap .
- 2 Find and tap .

About the PlayNow™ service

You can use the PlayNow™ service to download applications, music, games, ringtones and wallpapers. The PlayNow™ service offers both free and non-free downloads. Note that payment options for non-free applications may vary per country.



- 💡 The PlayNow™ service is not available in all countries.

Before you download content

Before you download, make sure that you have an Internet connection. Also, you may need to have a memory card inserted in your device to download content.

- ! When you download content to your device, you might be charged for the amount of data transferred. Contact your operator for information about data transfer rates in your country.

To start PlayNow™

- 1 From the **Home** screen, tap .
- 2 Find and tap .

Downloading from the PlayNow™ service

Download a range of content from the PlayNow™ service direct to your device. Choose from a variety of applications, games, music, ringtones and other content. Note that payment options for non-free applications may vary per country.

To download a PlayNow item to your device

- 1 From your **Home screen**, tap .
- 2 Find and tap **PlayNow™**.
- 3 Find an item you want to download by browsing categories, or by using the search function.
- 4 Tap the item to view its details.
- 5 Click “Buy now!” to start the purchase process. After your purchase has been validated, you can start to download your content.



FM radio

About the FM radio

The FM radio in your device works like any FM radio. For example, you can browse and listen to FM radio stations and save them as favourites. You must connect a wired headset or headphones to your device before you can use the radio. This is because the headset or headphones act as an antenna. After one of these devices is connected, you can then switch the radio sound to the speaker, if desired.

- 💡 When you open the FM radio, available channels appear automatically. If a channel has RDS information, it appears a few seconds after you start listening to the channel.

To start the FM radio

- 1 Connect a headset or a set of headphones to your device.
- 2 From your **Home screen**, tap .
- 3 Find and tap **FM radio** . The available channels appear as you scroll through the frequency band.

- ! When you start the FM radio, available channels appear automatically. If a channel has RDS information, it appears a few seconds after you start listening to the channel.

To move between radio channels

- Flick your finger up or down along the frequency band.

To select the radio region

- 1 When the radio is open, press .
- 2 Tap **Set radio region**.
- 3 Select an option.

To adjust the visualizer

- 1 When the radio is open, tap .
- 2 Tap **Visualiser**.
- 3 Select an option.

FM radio overview

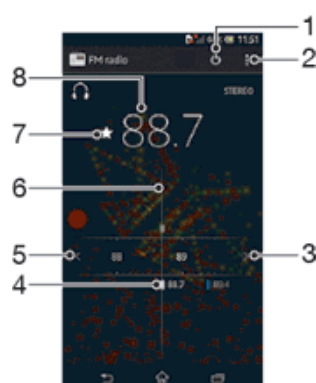

- 1 Radio on/off button
- 2 View menu options
- 3 Move up the frequency band to search for a channel
- 4 A saved favourite channel
- 5 Move down the frequency band to search for a channel
- 6 Tuning dial

Using your favourite radio channels

You can save the radio channels you most frequently listen to as favourites. By using favourites you can quickly return to a radio channel.

To save a channel as a favourite

- 1 When the radio is open, navigate to the channel that you want to save as a favourite.
- 2 Tap ☆.
- 3 Enter a name and select a colour for the channel, then press **Save**.

To remove a channel as a favourite

- 1 When the radio is open, navigate to the channel that you want to remove.
- 2 Tap ★, then tap **Delete**.

Making a new search for radio channels

If you have moved to a new location or the reception has improved in your current location, you can start a new scan for radio channels.

- ! Any favourites you have saved are not affected by a new scan.

To start a new search for radio channels

- 1 When the radio is open, press ⋮.
- 2 Tap **Search for channels**. The radio scans the whole frequency band, and all available channels are displayed.

Sound settings

Switching the radio sound between devices

You can listen to the radio through a wired headset or through wired headphones. Once either device is connected, you can switch the sound to the speaker, if desired.

To switch the radio sound to the speaker

- 1 When the radio is open, press ⋮.
 - 2 Tap **Play in speaker**.
- 💡 To switch the sound back to the wired headset or headphones, press ⋮ and tap **Play in headphones**.

Switching between mono and stereo sound mode

You can listen to your FM radio in either mono or stereo mode. In some situations, switching to mono mode can reduce noise and improve sound quality.

To switch between mono and stereo sound mode

- 1 When the radio is open, press ⋮.
- 2 Tap **Enable stereo sound**.
- 3 To listen to the radio in mono sound mode again, press ⋮ and tap **Force mono sound**.

Identifying radio tracks using TrackID™

Use TrackID™ technology to identify music tracks as they play on your device's FM radio.

To identify a song on the FM radio using TrackID™

- 1 While the song is playing on your device's FM radio, tap **TrackID™**.
 - 2 A progress indicator appears while the TrackID™ application samples the song. If successful, you are presented with a track result or a list of possible tracks.
 - 3 Press ↶ to return to the FM Radio.
- ! The TrackID™ application and the TrackID™ service are not supported in all countries/regions, or by all networks and/or service providers in all areas.

Camera

About the camera

The camera in your device is equipped with the highly sensitive Exmor R sensor, which helps you capture sharp photos and videos even in low lighting conditions. From the camera, you can, for example, send your photos and videos to friends as messages, or upload them to a web service. Your device also has a front camera, which is useful for self-portraits.

Camera controls overview

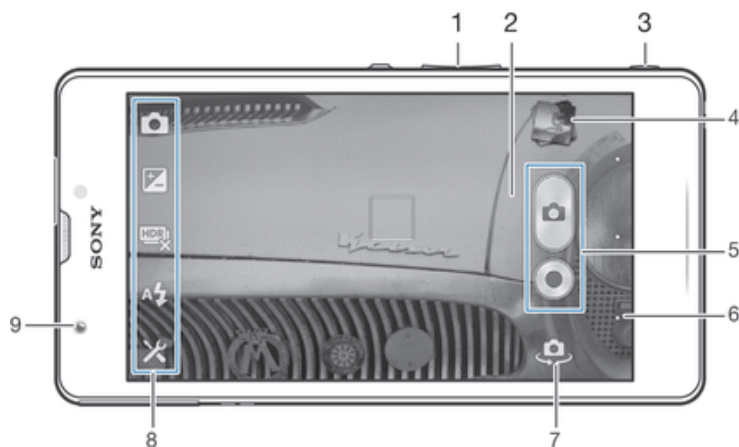

- 1 Zoom in or out
- 2 Main camera screen
- 3 Camera key – Activate the camera/Take photos/Record videos
- 4 View photos and videos
- 5 Take photos or record video clips
- 6 Go back a step or exit the camera
- 7 Switch between front and main camera
- 8 Camera setting icons
- 9 Front camera

To open the camera

- When the screen is active, press and hold down the camera key.

To close the camera

- Press ↶ from the main camera screen.

Using the still camera

There are three ways to take photos with the still camera. You can press the camera key, tap the on-screen camera button, or touch a spot on the screen.

To take a photo using the camera key

- 1 Activate the camera.
- 2 Press the camera key fully down.

To take a photo by tapping the on-screen camera button

- 1 Activate the camera.
- 2 Point the camera towards the subject.
- 3 Tap the on-screen camera button . The photo is taken as soon as you release your finger.

To take a self-portrait using the front camera

- 1 Activate the camera.
- 2 Tap the icon on the top left of the screen, then find and select **Front camera**.
- 3 To take the photo, press the camera key. The photo is taken as soon as you release your finger.

To use the zoom function

- When the camera is open, press the volume key up or down to zoom in or out.



To use the still camera flash

- 1 When the camera is open, tap .
- 2 Tap **Flash**, and select your desired flash setting.
- 3 Take the photo.

To view your photos and videos

- 1 Open the camera, then tap a thumbnail at the top right of the screen to open a photo or video.
- 2 Flick left or right to view your photos and videos. Videos are identified by .

To delete a photo

- 1 Open the photo that you want to delete.
- 2 Tap an empty area of the screen to make  appear.
- 3 Tap .
- 4 Tap **OK** to confirm.

Face detection

You can use face detection to bring an off-centre face into focus. The camera automatically detects up to five faces, indicated by white frames. A yellow frame shows which face has been selected for focus. Focus is set to the face closest to the camera. You can also tap one of the frames to select which face should be in focus.

To turn on face detection

- 1 Activate the camera.
- 2 Tap the icon on the top left of the screen, then select **Normal**.
- 3 To display all settings, tap .
- 4 Tap **Focus mode > Face detection**.

To take a photo using face detection

- 1 When the camera is open and **Face detection** turned on, point the camera at your subject. Up to five faces can be detected, and each detected face is framed.
- 2 Press the camera key halfway down. A yellow frame shows which face is in focus.
- 3 To take the photo, press the camera key fully down.

Using Smile Shutter™ to capture smiling faces

Use Smile Shutter™ technology to photograph a face just as it smiles. The camera detects up to five faces and selects one face for smile detection and auto focus. When the selected face smiles, the camera automatically takes a photo.

To turn on Smile Shutter™



- 1 Activate the camera.
- 2 To display all settings, tap .
- 3 Tap **Smile Shutter** and select a smile level.

To take a photo using Smile Shutter™



- 1 When the camera is open and Smile Shutter is turned on, point the camera at your subject. The camera selects which face to focus on.
- 2 The face selected appears inside a green frame and the photo is taken automatically.
- 3 If no smile is detected, press the camera key to take the photo manually.

Adding the geographical position to your photos

Turn on geotagging to add the approximate geographical location (a geotag) to photos when you take them. The geographical location is determined either by wireless networks (mobile or Wi-Fi® networks) or GPS technology.

When  appears on the camera screen, geotagging is turned on but the geographical position has not been found. When  appears, geotagging is turned on and the geographical location is available, so your photo can get geotagged. When neither of these two symbols appears, geotagging is turned off.

To turn on geotagging



- 1 Activate the camera.
- 2 Tap , then tap **Geotagging > On**.
- 3 Tap **OK** to agree to enable GPS and/or wireless networks.
- 4 Check the options that you want to select under **Location services**.
- 5 After you confirm your settings, press  to return to the camera screen.
- 6 If  appears on the camera screen, your location is available and your photo can get geotagged. If not, check your GPS and/or wireless network connection.

Using still camera settings

To adjust the still camera settings

- 1 Activate the camera.
- 2 To display all settings, tap .
- 3 Select the setting that you want to adjust, then edit as desired.

To customise the still camera settings panel

- 1 When the camera is open, tap  to display all settings.
 - 2 Touch and hold the setting you want to move and drag it to the desired position.
-  If you drag the setting outside of the settings panel, the change is cancelled.

Still camera settings overview



Superior auto
Optimise your settings to suit any scene.





Burst
Use the Burst speed shooting mode to capture several photos in quick succession by keeping your finger pressed on the shutter button. You can choose between three burst speeds, which come with different resolution levels, that is, different picture sizes.



Normal









Front camera
Select the front camera if you want to take self-portrait photos.

-  **Picture effect**
Apply effects to photos.
- SCN Scene selection**
Use a pre-programmed scene type to quickly set the camera for common situations.
-  **Sweep Panorama**
Use this setting to take wide-angle, panoramic photos. Just press the camera key and move the camera steadily from one side to the other.

Resolution

Choose between several picture sizes and aspect ratios before taking a photo. A photo with a higher resolution requires more memory.





-  **13 MP 4:3**
13 megapixel picture size with 4:3 aspect ratio. Suitable for photos you want to view on non-widescreen displays or print in high resolution. 13MP is available in the following conditions: select Normal capturing mode and HDR is off; select Scene mode except in Backlight Correction HDR mode.
-  **12 MP 4:3**
12 megapixel picture size with 4:3 aspect ratio. Suitable for photos you want to view on non-widescreen displays or print in high resolution. 12MP is maximum resolved in Superior Auto mode.
-  **9 MP 16:9**
9 megapixel picture size with 16:9 aspect ratio. A high resolution widescreen format. Has a higher resolution than full HD. Suitable for photos you want to view on widescreen displays.
-  **5MP 4:3**
5 megapixel picture size with 4:3 aspect ratio. Suitable for photos you want to view on non-widescreen displays or print in high resolution.
-  **2MP 16:9**
2 megapixel picture size with 16:9 aspect ratio. Suitable for photos you want to view on widescreen displays.
-  **VGA**
VGA format with 4:3 aspect ratio. 640x480 pixels.

! 12 MP is the maximum resolution available when photos are taken using **Superior auto mode**; when HDR is turned on in **Normal mode**; or when **Scenes (Backlight correction HDR mode)** mode is selected.

! The 13 MP resolution is only available when **Normal capturing mode** is selected and HDR is turned off, and when **Scenes mode** is selected (except in **Backlight correction HDR mode**).



Flash

Use the flash to take photos when lighting conditions are poor or when there is a backlight.

-  **Auto**
The camera automatically determines if the lighting conditions require the use of a flash.
-  **Fill flash**
Use this setting when the background is brighter than the subject. This removes unwanted dark shadows.
-  **Off**
The flash is turned off. Sometimes photo quality can be better without the flash, even if lighting conditions are poor. Taking a good photo without using the flash requires a steady hand. Use the self-timer to avoid blurred photos.
-  **Red-eye reduction**
Reduces the red colour of eyes when taking a photo.

Self-timer

With the self-timer you can take a photo without holding the device. Use this function to take self-portraits, or group photos where everyone can be in the photo. You can also use the self-timer to avoid shaking the camera when taking photos.





-  **On (10 s.)**
Set a 10-second delay from when you tap the camera screen until the photo is taken.
-  **On (2 s.)**
Set a 2-second delay from when you tap the camera screen until the photo is taken.
-  **Off**
The photo is taken as soon as you tap the camera screen.

Smile Shutter™

Use the smile shutter function to determine what kind of smile the camera reacts to before taking a photo.





Quick launch

Use Quick launch settings to launch the camera from the lock screen. If the device is in sleep mode of camera, press the camera key.

-  **Launch and capture**
By pressing and holding down the camera key, the first photo is captured immediately after the camera is launched from sleep mode.
-  **Launch only (still camera)**
By pressing and holding down the camera key, the still camera is launched from sleep mode.
-  **Launch and record video**
By pressing and holding down the camera key, the first video is shot immediately after the camera video camera is launched from sleep mode.
-  **Launch only (video camera)**
By pressing and holding down the camera key, the video camera is launched from sleep mode.
-  **Off**

Focus mode

The focus function controls which part of a photo should be sharp. When continuous autofocus is on, the camera keeps adjusting focus so that the area within the yellow focus frame stays sharp.

-  **Single auto focus**
The camera automatically focuses on the selected subject. Continuous autofocus is on. Touch and hold the camera screen until the yellow focus frame turns blue, indicating that the focus is set. The photo is taken when you release your finger.
-  **Multi auto focus**
The focus is automatically set on several areas of the image. Touch and hold the camera screen until the yellow focus frame turns blue, indicating that the focus is set. The photo is taken when you release your finger. Continuous autofocus is off.
-  **Face detection**
The camera automatically detects up to five human faces, indicated by frames on the screen. The camera automatically focuses on the nearest face. You can also select which face to focus on by tapping it on the screen. When you tap the camera screen, a blue frame shows which face is selected and in focus. Face detection cannot be used for all scene types. Continuous autofocus is on.
-  **Touch focus**
Touch a specific area on the camera screen to set the area of focus. Continuous autofocus is off. Touch and hold the camera screen until the yellow focus frame turns blue, indicating that the focus is set. The photo is taken when you release your finger.
-  **Object tracking**
When you select an object by touching it in the viewfinder, the camera tracks it for you.

! This setting is only available in **Normal** capturing mode.

Exposure value



Determine the amount of light in the photo you want to take. A higher value indicates an increased amount of light.

- ! This setting is only available in **Normal** capturing mode.





HDR

Use the HDR (High Dynamic Range) setting to take a photo against strong back light or in conditions where the contrast is sharp. HDR compensates for the loss of detail and produces a picture that is representative of both dark and bright areas.

- ! This setting is only available in **Normal** capturing mode.

White balance







The white balance setting adjusts the colour balance according to the lighting conditions.

-  **Auto**
Adjusts the colour balance automatically to suit the lighting conditions.
-  **Incandescent**
Adjusts the colour balance for warm lighting conditions, such as under light bulbs.
-  **Fluorescent**
Adjusts the colour balance for fluorescent lighting.
-  **Daylight**
Adjusts the colour balance for sunny outdoor conditions.
-  **Cloudy**
Adjusts the colour balance for a cloudy sky.

- ! This setting is only available in **Normal** capturing mode.

ISO



You can reduce image blurring caused by dark conditions or moving subjects by increasing the ISO sensitivity.

-  **Auto**
Sets the ISO sensitivity automatically.
-  **100**
Sets the ISO sensitivity to 100.
-  **200**
Sets the ISO sensitivity to 200.
-  **400**
Sets the ISO sensitivity to 400.
-  **800**
Sets the ISO sensitivity to 800.
-  **1600**
Sets the ISO sensitivity to 1600.

- ! This setting is only available in **Normal** capturing mode.

Metering

This function automatically determines a well-balanced exposure by measuring the amount of light striking the image you want to capture.

-  **Centre**
Adjusts the exposure to the centre of the image.
-  **Average**
Calculates the exposure based on the amount of light striking the whole image.

-  **Spot**
Adjusts the exposure in a very small part of the image that you want to capture.





! This setting is only available in **Normal** capturing mode.

Image stabiliser

When taking a photo, it can be difficult to hold the device steady. The stabiliser helps you by compensating for small movements of the hand.

Geotagging

Tag photos with details of where you took them.

-  **On**
When geotagging is turned on, the approximate geographical location is added to photos when you take them. To use geotagging, you must enable location features from the **Settings** menu. For geotags to be added to a photo, the location must be determined before you take the photo. Your location is determined when  appears on the camera screen. When your device is searching for your position,  appears.
-  **Off**
When geotagging is turned off, you cannot view the location where you took a photo.

Auto upload

Automatically upload updates to photos to a pre-selected social networking service (SNS).

Touch capture

Identify a particular focus area by touching the camera screen with your finger. The photo is taken as soon as you release your finger. This setting is only available when focus mode is set to touch focus.



On



Off

Shutter sound

Choose to turn on or turn off the shutter sound when you record a video.

Data storage

You can choose to save your data either to a removable SD card or to your device's internal storage.



Internal storage
Photos or videos are saved on the device memory.



SD card
Photos or videos are saved on the SD card.



Using the video camera

To record a video using the camera key

- 1 Activate the camera.
- 2 To start recording a video, press the camera key.
- 3 To stop recording, press the camera key again.





💡 Shoot your videos in landscape orientation to get the best results.

To record a video by tapping the screen



- 1 Activate the camera.
- 2 Point the camera towards the subject.
- 3 Tap  to start recording.
- 4 Tap  to stop recording.

 Shoot your videos in landscape orientation to get the best results.

To play recorded videos

- 1 Activate the camera.
- 2 Tap the thumbnails at the top right of the screen.
- 3 Flick left or right to browse all photo and video files. Videos are identified by .
- 4 Tap  to play a video.
- 5 To stop playing the video, tap  or .

To delete a recorded video



- 1 Browse to the video that you want to delete.
- 2 Tap an empty area of the screen to make  appear.
- 3 Tap .
- 4 Tap OK to confirm.

Using video camera settings

To adjust the video camera settings

- 1 Activate the camera.
- 2 Tap one of the settings icons on the screen.
- 3 To display all settings, tap .
- 4 Select the setting that want to adjust, then make your changes.







To customise the video camera settings panel

- 1 When the video camera is open, tap  to display all settings.
 - 2 Touch and hold the setting that you want to move, then drag it to the desired position.
-  If you drag the setting outside of the settings panel, the change is cancelled.

Video camera settings overview

Scenes

The Scenes feature helps you to quickly set up the camera for common situations using pre-programmed scenes. The camera determines a number of settings for you to fit the selected scene, ensuring the best possible video.

-  **Off**
The Scenes feature is off and you can shoot videos manually.
-  **Soft snap**
Use for shooting videos against soft backgrounds.
-  **Landscape**
Use for videos of landscapes. The camera focuses on distant objects.
-  **Night**
When turned on, light sensitivity is increased. Use in poorly lit environments. Videos of fast-moving objects may get blurred. Hold your hand steady, or use a support. Turn off night mode when lighting conditions are good, to improve the video quality.
-  **Beach**
Use in bright environments to avoid overexposed videos.
-  **Snow**
Use in bright environments to avoid overexposed videos.
-  **Sports**

Use for videos of fast-moving objects. Short exposure time minimises motion blurring.



Party

Use for indoor videos in poorly lit environments. This scene picks up indoor background lighting or candlelight. Videos of fast-moving objects may get blurred. Hold your hand steady, or use a support.

Video resolution

Adjust the video resolution for different formats.



1920×1080(16:9)

Full HD (Full High Definition) format with 16:9 aspect ratio. 1920×1080 pixels.



1280×720(16:9)

HD (High Definition) format with 16:9 aspect ratio. 1280×720 pixels.



640×480(4:3)

VGA format with 4:3 aspect ratio. 640×480 pixels.



176×144(11:9)

Record videos suitable for sending in multimedia messages. The recording time of this video format is limited to fit in a multimedia message.

Photo light

Use the light to record videos when lighting conditions are poor or when there is a backlight.



On



Off

Sometimes the video quality can be better without a light, even if lighting conditions are poor.

Self-timer

With the self-timer you can record a video without holding the device. Use it to record group videos where everyone can be in the video. You can also use the self-timer to avoid shaking the camera when recording videos.



On (10 s.)

Set a 10-second delay from when you tap the camera screen until the video begins to record.



On (2 s.)

Set a 2-second delay from when you tap the camera screen until the video begins to record.



Off

The video begins to record as soon as you tap the camera screen.

Quick launch

Use Quick launch settings to launch the camera from the lock screen. If the device is in sleep mode of camera, press the camera key.



Launch and capture

By pressing and holding down the camera key, the first photo is captured immediately after the camera is launched from sleep mode.



Launch only (still camera)

By pressing and holding down the camera key, the still camera is launched from sleep mode.



Launch and record video

By pressing and holding down the camera key, the first video is shot immediately after the camera video camera is launched from sleep mode.



Launch only (video camera)



By pressing and holding down the camera key, the video camera is launched from sleep mode.



Off

Focus mode

The focus setting controls which part of a video should be sharp. When continuous autofocus is on, the camera keeps adjusting focus so that the area within the white focus frame stays sharp.





-  **Single auto focus**
The camera automatically focuses on the selected subject. Continuous autofocus is on.
-  **Face detection**
The camera automatically detects up to five human faces, indicated by frames on the screen. The camera automatically focuses on the nearest face. You can also select which face to focus on by tapping it on the screen. When you tap the camera screen, a yellow frame shows which face is selected and in focus. Face detection cannot be used for all scene types. Continuous autofocus is on.
-  **Object tracking**
When you select an object by touching it in the viewfinder, the camera tracks it for you.

Exposure value

-  This setting allows you to determine the amount of light in the image you capture. A higher value indicates an increased amount of light.



White balance

The white balance setting adjusts the colour balance according to the lighting conditions.

-  **Auto**
Adjust the colour balance automatically to the lighting conditions.
-  **Incandescent**
Adjusts the colour balance for warm lighting conditions, such as under light bulbs.
-  **Fluorescent**
Adjust the colour balance for fluorescent lighting.
-  **Daylight**
Adjust the colour balance for sunny outdoor conditions.
-  **Cloudy**
Adjust the colour balance for a cloudy sky.





Metering

This function automatically determines a well-balanced exposure by measuring the amount of light striking the image that you want to capture.

-  **Centre**
Adjust the exposure to the centre of the image.
-  **Average**
Calculate the exposure based on the amount of light striking the whole image.
-  **Spot**
Adjust the exposure in a very small part of the image that you want to capture.

Geotagging

Tag photos with details of where you took them.

-  **On**
When geotagging is turned on, the approximate geographical location is added to photos when you take them. To use geotagging, you must enable location features from the **Settings** menu. For geotags to be added to a photo, the location must be determined before you take the photo. Your location is determined when  appears on the camera screen. When your device is searching for your position,  appears.
-  **Off**
When geotagging is turned off, you cannot view the location where you took a photo.

Microphone

Select whether to pick up the surrounding sound when recording videos.

Touch capture

Identify a particular focus area by touching the camera screen with your finger. The photo is taken as soon as you release your finger. This setting is only available when focus mode is set to touch focus.



On



Off

Shutter sound

Choose to turn on or turn off the shutter sound when you record a video.

Data storage

You can choose to save your data either to a removable SD card or to your device's internal storage.



Internal storage

Photos or videos are saved on the device memory.



SD card

Photos or videos are saved on the SD card.

Album

About Album

Use Album to view photos and play videos that you've taken with your camera, or to view similar content that you've saved to your device. You can add geotags to your photos and videos, and then view them on a world map. In Album, you can also view photos and videos that you've uploaded to an online service, for example, to a Picasa™ web album or to Facebook™.

From Album, you can share your favourite photos and videos with friends via Bluetooth™ wireless technology, email, messaging and various online services. You can also perform basic editing tasks on photos and set them as wallpaper or contact pictures. For more information, see *Connecting your device to a computer* on page 104.

Album tab overview

The following tabs are available in Album:

- **Pictures** – view all photos and videos saved on your device.
- **My albums** – view your online albums, and your geotagged photos and video clips on a world map .

To open Album

- 1 From your **Home screen**, tap .
- 2 Find and tap **Album**.

-  If the screen orientation does not change automatically when you turn your device sideways, mark the **Auto-rotate screen** checkbox under **Settings > Display**.

Mobile BRAVIA® Engine

Sony's Mobile BRAVIA® Engine technology improves the viewing quality of photos and videos after you take them, giving you clearer, sharper and more natural images. Mobile BRAVIA Engine is turned on by default, but you can turn it off if you want to reduce battery consumption.

To turn on Mobile BRAVIA® Engine

- 1 From your **Home screen**, tap .
- 2 Find and tap **Settings > Display**.
- 3 Mark the **Mobile BRAVIA Engine 2** checkbox if it is not marked.

Viewing photos and videos in the Pictures tab



In the **Pictures** tab in Album, you can view your photos and videos in thumbnails in a grid view.

Overview of Pictures tab



- 1 Grid view of photos and videos.
- 2 View menu options.
- 3 Scroll up or down to view content.
- 4 Tap a photo or video to view it.
- 5 The date and number of items in the group below.



To view photos and videos in grid view

- 1 From your **Home screen**, tap .
 - 2 Find and tap **Album**. All photos and videos are displayed in a chronologically ordered grid. Videos are indicated by .
 - 3 Tap a photo or video to view it.
 - 4 Flick left to view the next photo or video. Flick right to view the previous photo or video.
-  If the screen orientation does not change automatically when you turn your device sideways, mark the **Auto-rotate screen** checkbox under **Settings > Display**.

To change the size of the thumbnails in Album

- When viewing thumbnails of photos and videos in Album, spread two fingers apart to zoom in, or pinch two fingers together to zoom out.

To work with batches of photos or videos in Album

- 1 When viewing thumbnails of photos and videos in Album, tap , then tap **Select items**.
 - 2 Tap the items you want to work with. Selected items are indicated by a blue frame.
 - 3 Use the tools in the toolbar at the top of the screen to work with your selected items.
-  To activate selection mode, you can also touch and hold an item until its frame turns blue. Then you can tap other items to select them.

Viewing photos and videos in the My albums tab

The following tiles are available in My albums:

- **Camera albums** – view all photos and videos taken with your device's camera.
- **Internal memory** – view all photos and videos saved to your device's internal storage.



- **My SD card** – view all photos and videos saved to a removable memory card in your device.

Overview of My albums tab





- 1 View photos and videos using the PlayMemories online service.
- 2 View photos and videos on Facebook™.
- 3 View photos and videos in Picasa™.
- 4 View your photos on a map.
- 5 View all photos and videos saved to your device's internal storage.
- 6 View all photos and videos saved to the removable memory card.
- 7 View your photos in globe mode.
- 8 View all photos and videos taken with your device's camera.



To view content in list view in the Camera albums tile

- 1 From your **Home screen**, tap .
 - 2 Find and tap **Album > My albums > Camera albums**.
 - 3 Tap a folder that you want to open. The folder's content appears in a chronologically ordered grid. Videos are indicated by .
 - 4 Tap a photo or video to view it.
 - 5 Flick left to view the next photo or video. Flick right to view the previous photo or video.
-  If the screen orientation does not change automatically when you turn your device sideways, mark the **Auto-rotate screen** checkbox under **Settings > Display**.

To view content in list view in the Internal memory tile

- 1 From your **Home screen**, tap .
 - 2 Find and tap **Album > My albums > Internal memory**.
 - 3 Tap a folder that you want to open. The folder's content appears in a chronologically ordered grid. Videos are indicated by .
 - 4 Tap a photo or video to view it.
 - 5 Flick left to view the next photo or video. Flick right to view the previous photo or video.
-  If the screen orientation does not change automatically when you turn your device sideways, mark the **Auto-rotate screen** checkbox under **Settings > Display**.

To view content in list view in the My SD card tile

- 1 From your Home screen, tap .
 - 2 Find and tap **Album > My albums > My SD card**.
 - 3 Tap a folder that you want to open. The folder's content appears in a chronologically ordered grid. Videos are indicated by .
 - 4 Tap a photo or video to view it.
 - 5 Flick left to view the next photo or video. Flick right to view the previous photo or video.
-  If the screen orientation does not change automatically when you turn your device sideways, mark the **Auto-rotate** screen checkbox under **Settings > Display**.

Working with photos in Album

You can edit photos in Album. For example, you can crop photos, associate them with contacts, or use them as wallpaper.





To zoom a photo

- When you are viewing a photo, double-tap the screen to zoom in. Double-tap again to zoom out.
- When you are viewing a photo, spread two fingers apart to zoom in, or pinch two fingers together to zoom out.

To watch a slideshow of your photos

- 1 When you are viewing a photo, tap the screen to display the toolbars, then tap  > **Slideshow** to start playing all the photos in an album.
- 2 Tap a photo to end the slideshow.

To watch a slideshow of your photos with music

- 1 When you are viewing a photo, tap the screen to display the toolbars, then tap  > **SensMe™ slideshow**.
 - 2 Select the music and theme that you want to use for the slideshow, then tap . The Album application analyses your photos and uses SensMe™ music data to play a slideshow.
 - 3 To pause playing, tap the screen to display the controls, then tap .
-  For more information about SensMe™, see *Categorising your music using SensMe™ channels* on page 62.

To rotate a photo

- 1 When you are viewing a photo, tap the screen to display the toolbars, then tap .
- 2 Select **Rotate left** or **Rotate right**. The photo is saved in the new orientation.

To crop a photo

- 1 When you are viewing a photo, tap the screen to display the toolbars, then tap  > **Edit photo > Crop**.
- 2 To adjust the crop frame, touch and hold the edge of the crop frame. When the squares at the edges disappear, drag inward or outward to resize the frame.
- 3 To resize all sides of the crop frame at the same time, touch and hold one of the four corners to make the squares at the edges disappear, then drag the corner accordingly.
- 4 To move the crop frame to another area of the photo, touch and hold inside the frame, then drag it to the desired position.
- 5 To save a copy of the photo as you cropped it, tap **Save**. The original uncropped version remains on your device.

To use a photo

- 1 When you are viewing a photo, tap the screen to display the toolbars, then tap  > **Use as**.
- 2 Select an option from the list that appears.
- 3 Follow the relevant steps to use the photo.

To edit a photo

- When you are viewing a photo, tap the screen to display the toolbars, then tap  > **Edit photo**.

To share a photo

- 1 When you are viewing a photo, tap the screen to display the toolbars, then tap .
- 2 In the menu that opens, tap the application that you want to use to share the photo, then follow the steps to send it.

To add a geotag to a photo

- 1 When you are viewing a photo, tap the screen to display the toolbars, then tap  to open the map screen.
- 2 Find and tap the desired location to put the photo on the map.
- 3 To adjust the location of the photo, tap the location on the map to where you want to move the photo.
- 4 When you are finished, tap **OK** to save the geotag and return to the photo viewer.

- When a photo is geotagged,  appears along with location information. You can tap this icon to view the photo on a map.

To delete a photo

- 1 When you are viewing a photo, tap the screen to display the toolbars, then tap .
- 2 Tap **OK**.

Working with videos in Album

Use Album to watch videos that you've taken with the camera, downloaded, or copied to your device. You can also share your videos with friends, for example, by uploading them to online services.

To play a video

- 1 Open the **Pictures** tab or the **My albums** tab in Album.
- 2 Using grid view or list view, locate the video that you want to open.
- 3 Tap the video to play it.
- 4 If the playback controls are not displayed, tap the screen to display them. To hide the controls, tap the screen again.

To pause a video

- 1 When a video is playing, tap the screen to display the controls.
- 2 Tap .

To fast forward and rewind a video

- 1 When a video is playing, tap the screen to display the controls.
- 2 Drag the progress bar marker left to rewind, or right to fast forward.

To adjust the volume of a video

- Press the volume key.

To share a video

- 1 When a video is playing, tap the screen to display the toolbars, then tap  > **Share**.
- 2 In the menu that opens, tap the application that you want to use to share the selected video, then follow the relevant steps to send it.

- You might not be able to copy, send or transfer copyright-protected items. Also, some items may not send if the file size is too large.

To delete a video

- 1 In Album, find the video you want to delete.
- 2 Touch and hold the video to activate selection mode. The frame of the video thumbnail turns blue when it is selected.
- 3 Tap , then tap **OK**.

Viewing your photos on a map

If you enable location detection when taking photos, you can use the information gathered at a later stage. For example, you can view your photos on a map and show friends and family where you were when you took the photo. Adding location information is also referred to as geotagging. When you enable location detection, you can select to use either GPS satellites or wireless networks, or both, to find your position.

Overview of Maps tile







- 1 Search a location on the map.
- 2 View menu options.
- 3 A group of photos and/or videos geotagged with the same location.
- 4 Double tap to zoom in. Pinch to zoom out. Drag to view different parts of the map.
- 5 Thumbnails of the selected group of photos and/or videos. Tap an item to view it in full screen.





To enable location detection

- 1 From your **Home screen**, tap .
- 2 Find and tap **Settings > Location services**.
- 3 Mark the **GPS satellites** and/or **Google's location service** checkboxes.

To view geotagged photos on a map in Album

- 1 From your **Home screen**, tap .
 - 2 Find and tap **Album > My albums > Maps**.
 - 3 Tap a photo to view it in full screen.
 - 4 If several photos were taken at the same location, only one of them appears on the map. The total number of photos appears in the top right corner, for example, . To view these photos, tap the cover photo and then tap one of the thumbnails at the bottom of the screen.
-  When viewing a geotagged photo in the photo viewer, you can touch the screen to display the toolbars, then tap  to view the photo on the map.

To view geotagged photos on a globe in Album

- 1 From your Home screen, tap .
 - 2 Find and tap **Album** > **My albums** > **Globe**.
 - 3 Tap a photo to view it in full screen.
 - 4 If several photos were taken at the same location, only one of them appears on the map. The total number of photos appears in the top right corner, for example, . To view these photos, tap the cover photo and then tap one of the thumbnails at the bottom of the screen.
-  When viewing a geotagged photo from the camera application, you can touch the screen to display the toolbars, then tap  to view the photo on the map.

To add a geotag when viewing the map in Album

- 1 When viewing the map in Album, tap , then tap **Add geotag**.
- 2 Find and tap the photo to which you want to add the geotag.
- 3 Tap the desired location on the map to set the geotag, then tap **OK**.

To edit the geotag of a photo in Album

- 1 When viewing a photo on the map in Album, touch and hold the photo until its frame turns blue.
 - 2 Drag the photo to the new location.
-  You can also tap the desired location on the map instead of dragging.

To change the map view in Album

- When viewing the map in Album, tap , then select **Classic view**, **Globe view** or **Satellite view**.

Viewing online albums

In Album, view the photos and videos that you and your friends have uploaded to online services, such as Picasa™ and Facebook™. You can view comments from your friends and add your own comments as well.

Overview of online services



- 1 Active online service.
- 2 Name of online album.
- 3 Number of items in the online album.
- 4 Refresh.
- 5 View menu options.

To view photos from online services in Album

- 1 From your **Home screen**, tap .
- 2 Find and tap **Album > My albums**.
- 3 Tap the desired online service.
- 4 Tap **Connect**. All available online albums that you have uploaded to the service are displayed.
- 5 Tap any album to view its content, then tap a photo in the album.
- 6 Flick left to view the next photo or video. Flick right to view the previous photo or video.

To view and add comments to online album content

- 1 When viewing a photo from an online album, tap the screen to display the toolbars, then tap  to view the comments.
- 2 To view more comments, scroll down the screen.
- 3 To add your own comments, enter your comments at the bottom of the screen, then tap **Post**.

To "Like" a photo or video on Facebook™

- While viewing a photo or video from one of your Facebook™ albums, tap the screen to display the toolbars, then tap  to show that you "Like" the item on Facebook™.

Movies

About Movies

Use the Movies application to play movies and other video content that you've saved on your device. The Movies application also helps you get poster art, plot summaries, genre info and director details for each movie. You can also play your movies on other devices that are connected to the same network.

- ! Videos taken with your device's camera are displayed in the Album application, not in the Movies application.

Overview of Movies

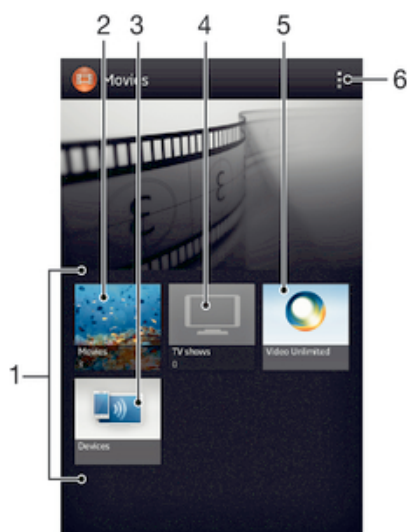



- 1 All video categories available on your device.
- 2 Browse all movies.
- 3 Browse content on other connected DLNA Certified™ devices.
- 4 Browse all TV shows.
- 5 Manage video content from Video Unlimited™.
- 6 View menu options.



- ! Video Unlimited™ may not be available in all countries or regions.

Using Movies

To play a video in Movies

- 1 From your **Home screen**, tap , then find and tap **Movies**.
- 2 Select a video category and browse to the video that you want to play.
- 3 Tap the video you want to select, then tap  to play it.
- 4 To display or hide the controls, tap the screen.
- 5 To pause playing, tap .
- 6 To rewind, drag the progress bar marker left. To fast forward, drag the progress bar marker right.



To play a video in full screen

- 1 When a video is playing, tap the screen to display the controls.
 - 2 Tap .
- 💡 To play the video in its original size, tap .

To share a video

- 1 When a video saved under Movies or TV shows is playing, tap , then tap **Share**.
- 2 Tap the application that you want to use to share the selected video, then follow the relevant steps to send it.



To get movie information manually

- 1 Make sure that your device has an active data connection.
 - 2 From your **Home screen**, tap , then find and tap **Movies**.
 - 3 Tap , then make sure that the **Get video details** checkbox is marked.
 - 4 Open the Movies or TV shows tab and browse to the thumbnail of a file that you want to get information about.
 - 5 Touch and hold the thumbnail for the video, then tap **Search for info**.
 - 6 In the search field, enter keywords for the video, then tap the confirm key on the keyboard. All matches are displayed in a list.
 - 7 Select a search result, then tap **Done**. The download of the information begins.
- ! You also get information about newly added videos automatically when the Movies application is opened and the **Get video details** checkbox is marked. Data transmission charges may apply.
- 💡 If the downloaded information is not correct, tap  and search again using different keywords.

To clear information about a video

- 1 From your **Home screen**, tap , then find and tap **Movies**.
- 2 Select a video category and browse to the video that you want to edit.
- 3 Touch and hold the video thumbnail, then tap **Clear info**.

To play a video on an external device

- 1 Make sure the devices that you want to share files with are connected to the same **Wi-Fi®** network as your device.
- 2 From your **Home screen**, tap , then find and tap **Movies >** .
- 3 Tap **Throw**, then select a device from the list.
- 4 Select the video that you want to play.

To change the sound settings while a video is playing

- 1 While a video is playing, tap the screen to display the controls.
- 2 Tap , then tap **Sound settings**.
- 3 Mark the checkboxes for the sound settings that you want to activate.
- 4 When you're finished, tap **OK**.

To delete a video

- 1 From your **Home screen**, tap , then find and tap **Movies**.
- 2 Select a video category and browse to the video that you want to delete.
- 3 Touch and hold the video thumbnail, then tap **Delete** from the list that appears.
- 4 Tap **Delete** again to confirm.

Video Unlimited™

About Video Unlimited™









Use the Video Unlimited™ service to rent and purchase videos that you can view not only on your Android device, but also on a PC, PlayStation® Portable (PSP®) or PlayStation® 3. Select your pick from the latest Hollywood releases, action movies, comedies, classics, and a range of other categories.

- ! Video Unlimited™ might not be available in all countries or regions.

To open Video Unlimited™

- 1 From your **Home screen**, tap .
- 2 Find and tap .

Video Unlimited™ menu overview

	View your account information
	Search for a video
	View the download status for all your items
	View and change settings for your account, purchases, and downloads
	Add the current video to a wish list
	Delete all items in your wish list
	Delete the video you're currently viewing from the wish list
	Share information about the current video via a social network, email, Bluetooth or other method
	View legal information

- ! The Video Unlimited™ menu is dynamic, which means that all options are not always available. For example, the option to delete all items in your wish list is only available when you are viewing the list.

To open the Video Unlimited™ menu

- Open **Video Unlimited**, then tap .

Creating a Video Unlimited™ account

You need to create a Video Unlimited™ account if you want to buy or rent movies through the Video Unlimited™ service.

Exploring the Video Unlimited™ selection







Browse videos by category, or enter text to search for a particular item. You can also choose to preview videos you're interested in.

Renting or buying a video

When you rent a video, you have a fixed amount of time in which to view it. This time period varies from market to market. You can also choose to download a purchased video to most Sony™ devices that are connected to your Video Unlimited™ account.

Video Unlimited™ notifications overview

When you buy or rent videos, the following notifications may appear:





-  Downloading of video is completed
-  Downloading has failed. You need to check that, for example, your device is connected to a Wi-Fi® network, and that you have enough free space on your memory card.
-  Downloading of video is ongoing
-  Downloading is paused
-  Confirmation of successful purchase
-  Rental countdown period has started

Watching a video from Video Unlimited™

You can watch your rented or purchased videos on most Sony™ device that are connected to your Video Unlimited™ account.

Video menu overview

When you watch a video from Video Unlimited™, you can open a menu to get the following options:

-  Delete the current video
-  View information about the current video
-  Change the audio language
-  Change the language of subtitles, or remove subtitles

Web browser

About the web browser

The Google Chrome™ web browser for Android™ devices comes pre-installed in most markets. Go to <http://support.google.com/chrome> and click the "Chrome for Mobile" link to get more detailed information about how to use this web browser.

- ! Google Chrome™ is not available in all markets.

To open the web browser

- 1 From your **Home screen**, tap .
- 2 Find and tap .

Connectivity

Connecting to wireless networks

You can access the Internet wirelessly from your device using **Wi-Fi®** technology. This way you can browse the web and share media files over the same **Wi-Fi®** network with other DLNA Certified™ devices, for example, TVs and computers.

If your company or organisation has a virtual private network (VPN), you can connect to this network using your device. You can use a VPN to access intranets and other internal services at your company.

Before using Wi-Fi®





To browse the Internet using a **Wi-Fi®** connection, you need to search for and connect to an available **Wi-Fi®** network and then open the Internet browser. The signal strength of the **Wi-Fi®** network may differ depending on your device's location. Move closer to the **Wi-Fi®** access point to increase the signal strength.

To turn on Wi-Fi®

- 1 From your **Home** screen, tap .
- 2 Find and tap **Settings**.
- 3 Drag the slider beside **Wi-Fi®** to the right to turn on the **Wi-Fi®** function.

! It may take a few seconds before **Wi-Fi®** is enabled.

To connect to a Wi-Fi® network

- 1 From the **Home** screen, tap .
- 2 Find and tap **Settings**.
- 3 Make sure that the **Wi-Fi®** function is on. Tap **Wi-Fi**.
- 4 Available **Wi-Fi®** networks are displayed. The available networks may be open or secured. Open networks are indicated by  and secured networks are indicated by  next to the **Wi-Fi®** network name.
- 5 Tap a **Wi-Fi®** network to connect to it. If you are trying to connect to a secure network, you are asked to enter a password.  is displayed in the status bar once you are connected.



! Your device remembers **Wi-Fi®** networks you connect to. The next time you come within reach of a previously connected **Wi-Fi®** network, your device automatically connects to it.

💡 In some locations, open **Wi-Fi®** networks require you to log in to a web page before you can get access to the network. Contact the relevant **Wi-Fi®** network administrator for more information.

To connect to another Wi-Fi® network

- 1 From your **Home** screen, tap .
- 2 Find and tap **Settings** > **Wi-Fi**. Detected **Wi-Fi®** networks are displayed.
- 3 Tap another **Wi-Fi®** network to connect to it.

To scan for Wi-Fi® networks manually

- 1 From your **Home** screen, tap  to go to the Application screen.
- 2 Find and tap **Settings** > **Wi-Fi**.
- 3 Press , then tap **Scan**. Your device now scans for all available **Wi-Fi®** networks.
- 4 To connect to a **Wi-Fi®** network, tap the network name from the list of available networks.

To add a Wi-Fi® network manually

- 1 Make sure that **Wi-Fi®** is turned on.
- 2 From the **Home** screen, tap .
- 3 Find and tap **Settings > Wi-Fi**.
- 4 Tap **+**.
- 5 Enter the **Network SSID** for the network.
- 6 Tap the **Security** field to select a security type.
- 7 If required, enter a password.
- 8 Tap **Save**.



! The **Wi-Fi®** network name may be indicated as SSID, ESSID or Access Point. Contact your **Wi-Fi®** network administrator to get the Network SSID and password.

Advanced Wi-Fi® settings

Wi-Fi® network status

When you are connected to a **Wi-Fi®** network or when there are **Wi-Fi®** networks available in your vicinity, it is possible to see the status of these **Wi-Fi®** networks. You can also enable your device to notify you whenever an open **Wi-Fi®** network is detected.

To enable Wi-Fi® network notifications

- 1 Turn on **Wi-Fi®**, if it is not already on.
- 2 From your **Home** screen, tap .
- 3 Find and tap **Settings > Wi-Fi**.
- 4 Press .
- 5 Tap **Advanced**.
- 6 Mark the **Network notification** checkbox.

To view detailed information about a connected Wi-Fi® network



- 1 From the **Home** screen, tap .
- 2 Find and tap **Settings > Wi-Fi**.
- 3 Tap the **Wi-Fi®** network that you are currently connected to. Detailed network information is displayed.

Wi-Fi® sleep policy

By adding a **Wi-Fi®** sleep policy, you can specify when to switch from **Wi-Fi®** to mobile data.

! If you are not connected to a **Wi-Fi®** network, your device uses a mobile data connection to access the Internet (if you have set up and enabled a mobile data connection on your device).

To add a Wi-Fi® sleep policy

- 1 From the **Home** screen, tap .
- 2 Find and tap **Settings > Wi-Fi**.
- 3 Press .
- 4 Tap **Advanced**.
- 5 Tap **Keep Wi-Fi on during sleep**.
- 6 Select an option.

Sharing your mobile data connection

You can share your device's mobile data connection with a single computer using a USB cable. This process is called USB tethering. You can also share your device's data connection with up to eight other devices at once, by turning your device into a portable **Wi-Fi®** hotspot.

When your device is sharing its data connection, the following icons may appear in the status bar or in the Notification panel:

 USB tethering is active



Portable Wi-Fi® hotspot is active

To share your data connection using a USB cable

- 1 Deactivate all USB cable connections to your device.
 - 2 Using the USB cable that came with your device, connect your device to a computer.
 - 3 From your **Home screen**, tap .
 - 4 Find and tap **Settings > More... > Tethering & portable hotspot**.
 - 5 Mark the **USB tethering** checkbox.
 - 6 To stop sharing your data connection, unmark the **USB tethering** checkbox or disconnect the USB cable.
- ! You cannot share your device's data connection and SD card over a USB cable at the same time.
- 💡 You may need to prepare your computer to establish a network connection via USB cable. Go to www.android.com/tether to get the most current information.

To use your device as a portable Wi-Fi® hotspot

- 1 From the **Home screen**, tap .
- 2 Find and tap **Settings > More... > Tethering & portable hotspot**.
- 3 Tap **Portable Wi-Fi hotspot settings > Set up Wi-Fi hotspot**.
- 4 Enter the **Network SSID** for the network. Tap the **Security** field to select a security type.
- 5 If required, enter a password.
- 6 Tap **Save**.
- 7 Mark the **Portable Wi-Fi hotspot** checkbox. Your device starts broadcasting its Wi-Fi network name (SSID). Up to eight computers or other devices can now connect to this network.
- 8 Unmark the **Portable Wi-Fi hotspot** checkbox when you want to stop sharing your data connection via Wi-Fi®.

To rename or secure your portable hotspot

- 1 From the **Home screen**, tap .
- 2 Find and tap **Settings > More... > Tethering & portable hotspot**.
- 3 Tap **Portable Wi-Fi hotspot settings > Set up Wi-Fi hotspot**.
- 4 Enter the **Network SSID** for the network.
- 5 To select a security type, tap the **Security** field.
- 6 If required, enter a password.
- 7 Tap **Save**.

Virtual private networks (VPNs)

Use your device to connect to virtual private networks (VPNs), which allow you to access resources inside a secured local network from outside the actual network. For example, VPN connections are commonly used by corporations and educational institutions for users who need to access intranets and other internal services when they are outside of the internal network, for example, when they are travelling.

VPN connections can be set up in many ways, depending on the network. Some networks may require you to transfer and install a security certificate in your device. For detailed information on how to set up a connection to your virtual private network, please contact the network administrator of your company or organisation.

To add a virtual private network

- 1 From your **Home screen**, tap .
- 2 Find and tap **Settings > More... > VPN**.
- 3 Tap **Add VPN profile**.
- 4 Select the type of VPN to add.
- 5 Enter your VPN settings.
- 6 Tap **Save**.

To connect to a virtual private network

- 1 From your **Home** screen, tap .
- 2 Find and tap **Settings** > **More...** > **VPN**.
- 3 In the list of available networks, tap the VPN that you want to connect to.
- 4 Enter the required information.
- 5 Tap **Connect**.

To disconnect from a virtual private network

- 1 Drag the status bar downwards.
- 2 Tap the notification for the VPN connection to turn it off.

Sharing content with DLNA Certified™ devices

You can view or play media content saved to your device on other devices such as, for example, a TV, or a computer. Such devices must be DLNA Certified™ by the Digital Living Network Alliance and all devices must be connected to the same **Wi-Fi®** network in order for content to be shared. You can also view or play content from other DLNA Certified™ devices on your device.

After you set up the sharing of content between devices, you can, for example, listen to music files stored on your home computer from your device, or view photos taken with your device's camera on a large-screen TV.

Playing files from DLNA Certified™ devices on your device

When you play files from another DLNA Certified™ device on your device, this other device acts as a server. In other words, it shares content over a network. The server device must have its content sharing function enabled and give access permission to your device. It also must be connected to the same **Wi-Fi®** network as your device.

To play a shared track on your device

- 1 Make sure the devices that you want to share files with are connected to the same **Wi-Fi®** network as your device.
- 2 From your **Home** screen, tap , then find and tap **WALKMAN**.
- 3 Tap **My music** to open the music library.
- 4 Select a device from the list of connected devices.
- 5 Browse the folders of the connected device and select the track that you want to play. The track starts playing automatically.

To play a shared video on your device

- 1 Make sure the devices that you want to share files with are connected to the same **Wi-Fi®** network as your device.
- 2 From your **Home** screen, tap , then find and tap **Movies** > **Devices**.
- 3 Select a device from the list of connected devices.
- 4 Browse the folders of the connected device and select the video that you want to play.

To view a shared photo on your device





- 1 Make sure the devices that you want to share files with are connected to the same **Wi-Fi®** network as your device.
- 2 From your **Home** screen, tap .
- 3 Find and tap **Album** > **My albums**. All your available online albums and connected devices are displayed.
- 4 Select a device from the list of connected devices.
- 5 Browse the folders of the connected device and select a photo to view it.

Preparing to play content from your device on DLNA Certified™ devices



Before you can view or play media files from your device on other DLNA Certified™ devices, you must set up file sharing on your device. The devices that you share content with are called client devices. For example, a TV, computer or tablet can act

as client devices. Your device works as a media server when it makes content available to client devices. When you set up file sharing on your device, you must also give access permission to client devices. After you do so, such devices appear as registered devices. Devices that are waiting for access permission are listed as pending devices.



To set up file sharing with other DLNA Certified™ devices

- 1 Connect your device to a **Wi-Fi®** network.
 - 2 From your **Home screen**, tap , then find and tap .
 - 3 Tap **My music** to open the music library.
 - 4 Press , then tap **Media server**.
 - 5 To turn on the **Share content** function, drag the slider.  appears in the status bar. Your device can now work as a media server.
 - 6 Connect your computer or other devices to the same **Wi-Fi®** network as your device.
 - 7 A notification appears in the status bar of your device. Open the notification and set the relevant access permissions for other devices.
- ! The instructions described above may differ depending on the client devices used. Refer to your client device User guide for more information. If the device cannot connect, check that your **Wi-Fi®** network is working.
- 💡 You can also access the **Media server** menu under **Settings > More... > Media server settings**. If you close the **Media server** view, file sharing function stays running in the background.



To stop sharing files with other DLNA Certified™ devices

- 1 From your **Home screen**, tap , then find and tap .
- 2 Tap **My music** to open the music library.
- 3 Press , then tap **Media server**.
- 4 Drag the slider to turn off the **Share content** function.



To set access permissions for a pending device

- 1 From your **Home screen**, tap , then find and tap .
- 2 Tap **My music** to open the music library.
- 3 Press , then tap **Media server**.
- 4 Select a device from the **Pending devices** list.
- 5 Select an access permission level.





To change the name of a registered device

- 1 From your **Home screen**, tap , then find and tap .
- 2 Tap **My music** to open the music library.
- 3 Press , then tap **Media server**.
- 4 Select a device from the **Registered devices** list, then select **Change name**.
- 5 Enter a new name for the device.

To change the access level of a registered device

- 1 From your **Home screen**, tap , then find and tap .
- 2 Tap **My music** to open the music library.
- 3 Press , then tap **Media server**.
- 4 Select a device from the **Registered devices** list.
- 5 Tap **Change access level** and select an option.

To get help about sharing content with other DLNA Certified™ devices





- 1 From your **Home screen**, tap , then find and tap .
- 2 Tap **My music** to open the music library.
- 3 Press , then tap **Media server**.
- 4 Tap .

Playing files on a Digital Media Renderer device



Using DLNA™ technology, you can push media content saved on your device to another device connected to the same Wi-Fi® network. The other device must be able to function as a Digital Media Renderer (DMR) device, which means that it can render, or play, content received from your device. A DMR device can be, for example, a TV with DLNA function, or a PC running Windows® 7 or higher.

- ! The settings for enabling the Digital Media Renderer may vary depending on the device used. Refer to the user guide for the respective device for more detailed information.

To view photos or videos from your device on a DMR device

- 1 Make sure that you have correctly set up the DMR device and that it is connected to the same Wi-Fi® network as your device.
 - 2 From your **Home screen**, tap .
 - 3 Find and tap **Album**.
 - 4 Browse to and open the file that you want to view.
 - 5 Tap the screen to display the toolbars, then tap  and select a DMR device to share your content with. The selected files start playing in chronological order on the device that you select.
 - 6 To disconnect from the DMR device, tap  and select **My phone**. The file stops playing on the DMR device but continues playing on your device.
- 💡 You can also share a video from the Movies application on your device by tapping the video and then tapping .

To play a music track from your device on a DMR device

- 1 Make sure that you have correctly set up the DMR device and that it is connected to the same Wi-Fi® network as your device.
- 2 From your **Home screen**, tap , then find and tap **WALKMAN**.
- 3 Tap **My music** to open the music library.
- 4 Select a music category and browse to the track that you want to share, then tap the track.
- 5 Tap  and select a DMR device to share your content with. The track plays automatically on the device that you select.
- 6 To disconnect from the DMR device, tap  and select **My phone**. The track stops playing on the DMR device but continues playing on your device.

NFC

Use Near Field Communications (NFC) to share data with other devices, such as a video, photo, web page address, music file or contact. You can also use NFC to scan tags that give you more information about a product or service as well as tags that activate certain functions on your device.

NFC is a wireless technology with a maximum range of one centimetre, so the devices sharing data must be held close to each other. Before you can use NFC, you must first turn on the NFC function, and the device's screen must be active.

- ! NFC may not be available in all countries and/or regions.

To turn on the NFC function

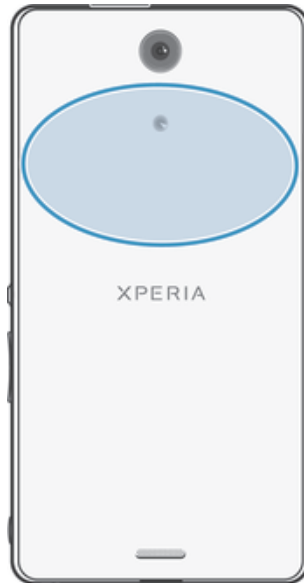

- 1 From your **Home screen**, tap .
- 2 Find and tap **Settings > More....**
- 3 Mark the **NFC** checkbox.

NFC detection area





- ! The location of the NFC detection area is not the same on all devices. When sharing data with another device using NFC, refer to the User guide of the other device for more information.

To share a contact with another device using NFC



- 1 Make sure that both devices have the NFC function turned on, and that both screens are active.
- 2 To view contacts, go to your **Home screen**, tap , then tap .
- 3 Tap the contact that you want to share.
- 4 Hold your device and the receiving device back to back so that the NFC detection areas of each device touch each other. When the devices connect, they vibrate and play a short sound. A thumbnail of the contact appears.
- 5 Tap the thumbnail to start the transfer.
- 6 When the transfer is done, the contact information is displayed on the screen of the receiving device and is also saved on the receiving device.

To share a music file with another device using NFC



- 1 Make sure that both your device and the receiving device have the NFC function turned on, and that both screens are active.
- 2 To open the "WALKMAN" application, tap , then find and tap .
- 3 Tap the **My music** tab to open the music library.
- 4 Select a music category and browse to the track you want to share.
- 5 Tap the track to play it. You can then tap  to pause the track. The transfer works whether the track is playing or paused.
- 6 Hold your device and the receiving device back to back so that the NFC detection areas of each device touch each other. When the devices connect, they vibrate and play a short sound. A thumbnail of the track appears.
- 7 Tap the thumbnail to start the transfer.
- 8 When the transfer is done, the music file plays immediately on the receiving device. At the same time, the file is saved on the receiving device.

- ! You might not be able to copy, send or transfer copyright-protected items.

To share a photo or video with another device using NFC

- 1 Make sure that both devices have the NFC function turned on, and that both screens are active.
 - 2 To view photos and videos in your device, go to your **Home screen**, tap , then find and tap **Album**.
 - 3 Tap the photo or video that you want to share.
 - 4 Hold your device and the receiving device back to back so that the NFC detection areas touch each other. When the devices connect, they vibrate and play a short sound. A thumbnail of the photo or video appears.
 - 5 Tap the thumbnail to start the transfer.
 - 6 When the transfer is done, the photo or video is displayed on the screen of the receiving device. At the same time, the item is saved on the receiving device.
-  You can also use NFC to share a video from the Movies application.

To share a web address with another device using NFC

- 1 Make sure that both devices have the NFC function turned on, and that both screens are active.
- 2 From your **Home screen**, tap .
- 3 To open the web browser, find and tap .
- 4 Load the web page that you want to share.
- 5 Hold your device and the receiving device back to back so that the NFC detection areas touch each other. When the devices connect, they vibrate and play a short sound. A thumbnail of the web page appears.
- 6 Tap the thumbnail to start the transfer.
- 7 When the transfer is done, the web page is displayed on the screen of the receiving device.

Scanning NFC tags

Your device can scan various kinds of NFC tags. For example, it can scan embedded tags on a poster, on a billboard advertisement, or beside a product in a retail store. You can receive additional information, such as a web address.

To scan an NFC tag

- 1 Make sure that your device has the NFC function turned on and that the screen is active.
- 2 Place your device over the tag so that the NFC detection area touches it. Your device scans the tag and displays the content collected. Tap the content of the tag to open it.
- 3 To open the tag, tap it.

Paying for items with your device

You can use the Operator wallet application on your device to pay for items in stores that support NFC payment methods. Just tap your device on specially enabled electronic payment pads to pay for your purchases. Payments are backed by a credit or debit card, or by prepaid cards or vouchers. Your payment information is stored in the payment application, so you don't need to enter it every time.

-  To use Operator wallet, your SIM card must have a secure element embedded. Contact your network operator for more details.

Google Wallet™

Use the Google Wallet™ application to pay for goods at checkouts. If there is a supported NFC terminal at the checkout, you can just tap your device on the terminal to pay. Google Wallet™ stores details of your credit and debit cards as well as details of coupons and other special offers. Most major credit card types are supported. Security features include a PIN, encrypted storage and the ability to remotely disable a lost wallet.

Operator wallet

The Operator wallet application lets you access a variety of services provided by your network operator, such as the option to pay for items in underground trains and stores. Contact your network operator for more information about such services.

To select a wallet for use on your device

- 1 Make sure that the NFC function is on.
- 2 From your **Home screen**, tap .
- 3 Find and tap **Settings > More....**
- 4 Tap **Wallet** and select an option.

Connecting to an NFC compatible device

You can connect your device to other NFC compatible devices produced by Sony, such as a speaker or a headphone. When establishing this kind of connection, refer to the User guide of the compatible device for more information.

- ! You may need to have Wi-Fi® or Bluetooth™ activated on both devices for the connection to work.

Bluetooth™ wireless technology



Use the Bluetooth™ function to send files to other Bluetooth™ compatible devices, or to connect to handsfree accessories. Turn on the Bluetooth™ function in your device and create wireless connections to other Bluetooth™ compatible devices such as computers, handsfree accessories, and phones. Bluetooth™ connections work better within 10 metres (33 feet), with no solid objects in between. In some cases you have to manually pair your device with other Bluetooth™ devices.

- ! Interoperability and compatibility among Bluetooth™ devices can vary.

To turn on the Bluetooth™ function and make your device visible

- 1 From your **Home screen**, tap .
- 2 Find and tap **Settings**.
- 3 Tap the on-off switch beside **Bluetooth** to turn on the Bluetooth™ function.
- 4 Tap **Bluetooth**. Your device and a list of available Bluetooth™ devices appear.
- 5 Tap your device name to make your device visible to other Bluetooth™ devices.



To adjust your device's visibility time to other Bluetooth™ devices

- 1 From your **Home screen**, tap .
- 2 Find and tap **Settings > Bluetooth**.
- 3 Press  and select **Visibility timeout**.
- 4 Select an option.

Naming your device

You can give your device a name. This name is shown to other devices after you have turned on the Bluetooth™ function and your device is set to visible.

To give your device a name

- 1 Make sure that the Bluetooth™ function is turned on.
- 2 From your **Home screen**, tap .
- 3 Find and tap **Settings > Bluetooth**.
- 4 Press  and select **Rename phone**.
- 5 Enter a name for your device.
- 6 Tap **Rename**.

Pairing with another Bluetooth™ device

When you pair your device with another device, you can, for example, connect your device to a Bluetooth™ headset or a Bluetooth™ car kit and use these other devices to make and receive calls.

Once you have paired your device with a Bluetooth™ device, your device will remember this pairing. When pairing your device with a Bluetooth™ device, you may need to enter a passcode. Your device will automatically try the generic passcode 0000. If this does not work, refer to the user guide for your Bluetooth™ device to get the device passcode. You do not need to re-enter the passcode the next time you connect to a paired Bluetooth™ device.

Some Bluetooth™ devices, for example, most Bluetooth™ headsets, require you to both pair and connect with the other device.

You can pair your device with several Bluetooth™ devices, but you can only connect to one Bluetooth™ profile at the same time.



To pair your device with another Bluetooth™ device

- 1 Make sure that the device you want to pair your device with has the Bluetooth™ function activated and is visible to other Bluetooth™ devices.
- 2 From the **Home screen**, tap .
- 3 Find and tap **Settings > Bluetooth**. All available Bluetooth™ devices appear in a list.
- 4 Tap the Bluetooth™ device that you want to pair with your device.
- 5 Enter a passcode, if required, or confirm the same passcode on both devices. Your device and the Bluetooth™ device are now paired.

To connect your device to another Bluetooth™ device

- 1 If you are connecting to a Bluetooth device that requires you to first pair your device before connecting, follow the relevant steps to pair your device with that device.
- 2 From your **Home screen**, tap .
- 3 Find and tap **Settings > Bluetooth**.
- 4 Tap the Bluetooth™ device to which you want to connect your device.

To unpair a Bluetooth™ device

- 1 From the **Home screen**, tap .
- 2 Find and tap **Settings > Bluetooth**.
- 3 Under **Paired devices**, tap  beside the name of the device that you want to unpair.
- 4 Tap **Unpair**.

Sending and receiving items using Bluetooth™ technology

Share items with other Bluetooth™ compatible devices such as phones or computers. You can send and receive several kinds of items using the Bluetooth™ function, such as:

- Photos and videos
- Music and other audio files
- Contacts
- Web pages

To send items using Bluetooth™

- 1 **Receiving device:** Make sure the Bluetooth™ function is turned on and that the device is visible to other Bluetooth™ devices.
- 2 **Sending device:** Open the application which contains the item that you want to send, and scroll to the item.
- 3 Depending on the application and the item you want to send, you may need to, for example, touch and hold the item, open the item or press . Other ways to send an item may exist.
- 4 Select **Share** or **Send**.
- 5 Select **Bluetooth**.
- 6 Turn on Bluetooth™, if you are asked to do so.
- 7 Tap the name of the receiving device.
- 8 **Receiving device:** If asked, accept the connection.
- 9 **Sending device:** If asked, confirm the transfer to the receiving device.
- 10 **Receiving device:** Accept the incoming item.

To receive items using Bluetooth™

- 1 Make sure that the Bluetooth™ function is on and is visible to other Bluetooth™ devices.
- 2 The sending device now starts sending data to your device.
- 3 If prompted, enter the same passcode on both devices, or confirm the suggested passcode.
- 4 When you are notified of an incoming file to your device, drag the status bar downwards and tap the notification to accept the file transfer.
- 5 Tap **Accept** to start the file transfer.
- 6 To view the progress of the transfer, drag the status bar downwards.
- 7 To open a received item, drag the status bar downwards and tap the relevant notification.

To view files you have received using Bluetooth™

- 1 From your **Home screen**, tap .
- 2 Find and tap **Settings > Bluetooth**.
- 3 Press and select **Show received files**.

Connecting your device to a computer

Connect your device to a computer and start transferring pictures, music and other file types. The easiest ways to connect are using a USB cable or Bluetooth wireless technology.

When you connect your device to the computer using a USB cable, you are prompted to install the PC Companion application on your computer. PC Companion helps you access additional computer applications to transfer and organise media files, update your device, synchronise device content, and more.

- ! You might not be able to transfer some copyright-protected material between your device and a computer.

Transferring and handling content using a USB cable

Use a USB cable connection between a computer and your device for easy transfer and management of your files. Once the two devices are connected, you can drag and drop content between your device and the computer, or between your device's internal storage and SD card, using the computer's file explorer.

If you're transferring music, video, pictures or other media files to your device, it's best to use the Media Go™ application on your computer. Media Go™ converts media files so that you can use them on your device.

To transfer content between your device and computer using a USB cable

- 1 Using a USB cable, connect your device to a computer. **Internal storage & SD card connected** appears in the status bar on the screen of your device.
- 2 **Computer:** Open Microsoft® Windows® Explorer from the desktop and wait until your device's internal storage and your SD card appear as external disks in Microsoft® Windows® Explorer.
- 3 **Computer:** Drag and drop the desired files between your device and the computer.

To transfer content between internal storage and an SD card via USB

- 1 Using a USB cable, connect your device to a computer. **Internal storage & SD card connected** appears in the status bar on the screen of your device.
- 2 **Computer:** Open Microsoft® Windows® Explorer from the desktop and wait until your device's internal storage and your SD card appear as external disks in Microsoft® Windows® Explorer.
- 3 **Computer:** Drag and drop the desired files between the device's internal storage and the SD card.

To transfer files directly from internal storage to an SD card in the device

- 1 From your **Home** screen, tap .
- 2 Find and tap **Settings > Storage > Transfer data to SD card**.
- 3 Mark the file types you want to transfer to the SD card.
- 4 Tap **Transfer**.

 The direct transfer method means that a USB cable connection to a computer is not necessary.

Transferring files using Media transfer mode via Wi-Fi®

You can transfer files between your device and other MTP compatible devices, such as a computer, using a Wi-Fi® connection. Before connecting, you first need to pair the two devices. If you're transferring music, video, pictures or other media files between your device and a computer, it's best to use the Media Go™ application on the computer. Media Go™ converts media files so that you can use them on your device.

 In order to use this feature, you need a Wi-Fi® enabled device that supports Media transfer, for example, a computer running Microsoft® Windows Vista® or Windows® 7.

To pair your device wirelessly with a computer using Media transfer mode

- 1 Make sure Media transfer mode is enabled on your device. It is normally enabled by default.
- 2 Connect your device to the computer using a USB cable.
- 3 **Computer:** Once the name of your device appears on the screen, click *Network configuration* and follow the instructions to pair the computer.
- 4 When you are finished pairing, disconnect the USB cable from both devices.

 The above instructions only work if Windows® 7 is installed on your computer and the computer is connected to a Wi-Fi® Access Point via a network cable.

To connect paired devices wirelessly in Media transfer mode

- 1 Make sure Media transfer mode is enabled on your device. It is normally enabled by default.
- 2 From your **Home** screen, tap .
- 3 Find and tap **Settings > Xperia™ > USB Connectivity**.
- 4 Tap the paired device that you want to connect to under **Trusted devices**.
- 5 Tap **Connect**.

 Make sure the Wi-Fi® function is turned on.

To disconnect a wirelessly paired device in Media transfer mode

- 1 From your Home screen, tap .
- 2 Find and tap **Settings** > **Xperia™** > **USB Connectivity**.
- 3 Tap the paired device that you want to disconnect from under **Trusted devices**.
- 4 Tap **Disconnect**.

To remove a pairing with another device

- 1 From your Home screen, tap .
- 2 Find and tap **Settings** > **Xperia™** > **USB Connectivity**.
- 3 Tap the paired device that you want to remove.
- 4 Tap **Forget**.

PC Companion

PC Companion is a computer application that gives you access to additional features and services which help you transfer music, video and pictures to and from your device. You can also use PC Companion to update your device and get the latest software version available. The installation files for PC Companion are saved on your device and the installation is launched from the device when you connect it to a computer via USB cable.

You need an internet connected computer running one of the following operating systems to use the PC Companion application:

- Microsoft® Windows® 7
- Microsoft® Windows Vista®
- Microsoft® Windows® XP (Service Pack 3 or higher)

To start PC Companion

- 1 Make sure that PC Companion is installed on your PC.
- 2 Open the PC Companion application on the PC, then click **Start** to open one of the features that you want to use.

Media Go™

The Media Go™ computer application helps you transfer and manage media content in your device and computer. You can install and access Media Go™ from within the PC Companion application.

You need one of these operating systems to use the Media Go™ application:

- Microsoft® Windows® 7
- Microsoft® Windows Vista®
- Microsoft® Windows® XP, Service Pack 3 or higher

To transfer content using the Media Go™ application

- 1 Connect your device to a computer using a supported USB cable.
- 2 **Device:** In the status bar, **Internal storage connected** appears.
- 3 **Computer:** Open the PC Companion application on the PC first. In PC Companion, click *Media Go* to start the Media Go™ application. In some cases, you may have to wait for Media Go™ to install.
- 4 Using Media Go™, drag and drop files between your computer and device.

Connecting your device to a TV set

Connect your device to a TV set and start viewing content saved in your device on a larger screen. When you connect your device to the TV set, the TV launcher application opens. This application helps you to play media files from your device on TVs and other devices.

- 💡 You may have to purchase an MHL cable separately.

To view content from your device on a TV which supports MHL input

- 1 Connect your device to the TV using an MHL cable.  appears in your device's status bar after a connection is established.
- 2 The **TV launcher** application starts automatically. Follow the instructions to view your media files on the TV.

To view content from your device on a TV which supports HDMI™ input

- 1 Connect your device to an MHL-HDMI adaptor, and connect the adaptor to a USB power supply.
- 2 Connect the adaptor to a TV using a HDMI™ cable.  appears in your device's status bar after a connection is established.
- 3 The **TV launcher** application starts automatically. Follow the instructions to view your media files on the TV.

To view help about using the TV remote control

- 1 While your device is connected to the TV set, drag the status bar downwards to open the Notification panel.
 - 2 Tap **MHL connected**.
-  You can also press the yellow button on the TV remote control to open the Notification panel.

To disconnect your device from the TV set

- Disconnect the MHL™ cable or the MHL-HDMI adaptor from your device.

Screen mirroring

Use Screen mirroring to show the screen of your device on a TV or other large display without using a cable connection. Wi-Fi Direct™ technology creates a wireless connection between the two devices, so you can sit back and enjoy your favourite photos from the comfort of your couch. You can also use this feature to listen to music from your phone via the TV's speakers.

- ! Your TV must support screen mirroring based on Wi-Fi CERTIFIED Miracast™ for the functionality described above to work. If your TV does not support screen mirroring, you need to purchase a wireless display adapter separately.
- ! When using screen mirroring, the image quality may sometimes be negatively impacted if there is interference from other Wi-Fi® networks.

To mirror the screen of your device on a TV screen

- 1 Follow the instructions in the User guide for your TV to turn on the screen mirroring function.
 - 2 From your **Home screen**, tap .
 - 3 Find and tap **Settings** > **Xperia™** > **Screen mirroring**.
 - 4 Tap **Turn on Screen mirroring** and select a device.
- ! When using screen mirroring, do not cover the Wi-Fi antenna area of your device.

Scanning barcodes with the NeoReader™ application

About scanning with the NeoReader™ application

Use your device as a barcode scanner to find out more about items you scan. For example, you see a coat in a magazine ad and want to find the nearest retail outlet to buy it. If the ad contains a readable barcode, the NeoReader™ application uses this code to access mobile web content, such as a web page with more product information or a map of nearby outlets. NeoReader™ supports most standard barcode types.

To start the NeoReader™ application

- 1 From the **Home** screen, tap .
- 2 Find and tap  **NeoReader™**.

To scan a barcode







- 1 When the NeoReader™ application is open, hold your device over the barcode until the complete barcode is visible in the viewfinder.
- 2 Your device automatically scans the barcode, and vibrates when the barcode is recognised.

To enter a barcode manually

- 1 When the NeoReader™ application is open, tap .
- 2 Enter the numbers of the barcode in the text field, then tap **GO!**.

NeoReader™ application menu overview

The following menu options are available in the NeoReader™ application:

	Tap to open more options
	Enter the barcode numbers manually. This option can be used if your camera has difficulty reading the barcode
	View a list of previously scanned barcodes
	View information about the NeoReader™ application. Read more about different barcode types, and about how to use NeoReader™
	Select your personal settings, such as language or country. This information is used to personalise barcode content. Also, you can select preferences for how you use the NeoReader™ application
	Send a text message to invite a friend to download the NeoReader™ application

Smart Connect

About Smart Connect

Use the Smart Connect application to set what happens in your device when you connect or disconnect an accessory. You can also use it to set a specific action or a group of actions to launch on your device at certain times of the day.

For example, when you connect your headset or headphones, you can set an event so that the following actions are launched on your device:

- Between 7am and 9am, when you commute to work, the WALKMAN player starts, and the web browser opens the morning paper. The ring volume is set to vibrate.
- Between office hours, a conference call app opens on your device.
- On the way back from work, the FM radio starts, and a notes app with your shopping list opens.

To start the Smart Connect application

- 1 From your **Home** screen, tap .
- 2 Find and tap **Smart Connect**.

To create a Smart Connect event

- 1 Start the Smart Connection application. If you are opening Smart Connect for the first time, tap **OK** to close the introduction screen.
 - 2 On the **Events** tab, tap **+**.
 - 3 Give the event a name, then tap **Create**.
 - 4 Under **When**, add either an accessory or a time interval, or both.
 - 5 Under **Do this**, add what you want to happen in your device.
 - 6 Under **At the end**, add what you want to happen when you disconnect the accessory or when the time interval comes to an end. If both these conditions are set, the actions start either when you disconnect the accessory, or when the time interval comes to an end.
 - 7 To save the event, press ↵.
- 💡 To add a Bluetooth™ accessory, you have to first pair it with your device.

To edit a Smart Connect event

- 1 Start the Smart Connection application.
 - 2 On the **Events** tab, tap an event.
 - 3 If the event is switched off, tap .
 - 4 Adjust the settings as desired.
 - 5 To save the event, press ↵.
- 💡 To delete an incorrect entry, touch and hold the entry and then tap **Delete**.

Synchronising data on your device

About synchronising data on your device

You can sync contacts, email, calendar events, and other information with your device from multiple email accounts, synchronisation services and other kinds of accounts, depending on the applications installed on your device. Synchronising your device with other information sources is an easy and practical way to stay up to date.



Synchronising with Google™

Synchronise your device with different Google™ services to keep your information up to date, regardless of which device you're using your Google™ account from. For example, you can synchronise your contacts, Gmail™, calendar and web browser data.

To set up a Google™ account for synchronisation

- 1 From your **Home screen**, tap .
- 2 Tap **Settings > Add account > Google**.
- 3 Follow the registration wizard to create a Google™ account, or sign in if you already have an account.
- 4 Mark the **Back up & restore** checkbox if you want to back up data to your Google™ account, then tap **Next**.
- 5 Tap your newly created Google™ account, then tap the items you that want to synchronise.

To synchronise manually with your Google™ account

- 1 From the **Home screen**, tap .
- 2 Tap **Settings > Google**.
- 3 Tap the Google™ account that you want to synchronise.
- 4 Press , then tap **Sync now**.



To synchronise an application with a Google™ account

- 1 From your **Home screen**, tap .
- 2 Tap **Settings > Google**.
- 3 Tap the Google™ account that you want to synchronise with. A list appears of applications that can be synchronised with the Google account.
- 4 Tap the application that you want to synchronise with the selected Google account.

To synchronise the web browser data

- 1 From your **Home screen**, tap .
- 2 Tap **Settings > Google**.
- 3 Tap the Google™ account that you want to synchronise with, then tap **Sync Browser**.

To remove a Google™ account

- 1 From your **Home screen**, tap .
- 2 Tap **Settings > Google**.
- 3 Tap the Google™ account that you want to remove from the accounts list.
- 4 Press , then tap **Remove account**.
- 5 Tap **Remove account** again to confirm.

Synchronising your corporate email, calendar and contacts

Access your corporate email messages, calendar appointments and contacts directly from your device. View and manage them just as easily as you would from a



computer. After setup, you can find your information in the **Email, Calendar and Contacts** applications.

- ! For you to access the functionality described above, your corporate information must be stored on a Microsoft® Exchange server.



To set up corporate email, calendar and contacts

- 1 From your **Home screen**, tap .
- 2 Tap **Settings > Add account > Exchange ActiveSync**.
- 3 Enter your corporate email address and password.
- 4 Tap **Next**. Your device begins to retrieve your account information. If a failure occurs, contact your corporate network administrator for more information.
- 5 Tap **OK** to allow your corporate server to control your device.
- 6 Select what data you want to sync with your device, such as contacts and calendar entries.
- 7 If desired, activate the device administrator to allow your corporate server to control certain security features on your device. For example, you can allow your corporate server to set password rules and set storage encryption.
- 8 When the setup is done, enter a name for the corporate account.



To edit the setup of corporate email, calendar and contacts

- 1 From your **Home screen**, tap .
- 2 Tap **Email**, then tap .
- 3 Tap **Settings** and select a corporate account.
- 4 Change the desired settings.

To set a synchronisation interval for a corporate account

- 1 From your **Home screen**, tap .
- 2 Tap **Email**, then tap .
- 3 Tap **Settings** and select a corporate account.
- 4 Tap **Inbox check frequency** and select an interval option.

To remove a corporate account

- 1 From your **Home screen**, tap .
- 2 Tap **Settings > Exchange ActiveSync**, then select the corporate account.
- 3 Tap , then tap **Remove account**.
- 4 Tap **Remove account** again to confirm.



Synchronising with Facebook™

There are two ways to use Facebook™ on your device. You can use the standard Facebook application to access your online Facebook account, or you can synchronise your Facebook account with your device and share content between Facebook™ and a range of other applications. For example, you can share music in the "WALKMAN" application on your device via Facebook. To synchronise your device with Facebook, you must first set up an "Xperia™ with Facebook" account — a solution developed by Sony to enable easy integration.

To set up an "Xperia™ with Facebook" account on your device



- 1 From your **Home screen**, tap .
- 2 Tap **Settings > Add account > Xperia™ with Facebook**.
- 3 Follow the on-screen instructions to sign in to your Facebook™ account, or create a new account.

To synchronise manually with an "Xperia™ with Facebook" account

- 1 From your **Home screen**, tap .
- 2 Tap **Settings > Xperia™ with Facebook**.
- 3 Select the account that you want to synchronise.
- 4 Press , then tap **Sync now**.

To remove an "Xperia™ with Facebook" account

! When you remove an "Xperia™ with Facebook" account from your device, the associated online Facebook account is not deleted and you can still access it from a computer.

- 1 From your **Home screen**, tap .
- 2 Tap **Settings > Xperia™ with Facebook**.
- 3 Select the account that you want to remove.
- 4 Press , then tap **Remove account**.
- 5 Tap **Remove account** again to confirm.

Maps and locations

About location services

Use your device to find out where you are. There are two methods: GPS and wireless networks. Enable the wireless networks option if you only need your approximate location, and want it fast. If you want a more exact position, and have a clear view of the sky, enable the GPS option. In situations where the wireless network connection is weak, you should enable both options to ensure that your location is found.

- ! Sony does not warrant the accuracy of any location services including but not limited to navigational services.

Using GPS

Your device has a global positioning system (GPS) receiver that uses satellite signals to calculate your location.

- ! When you use features that require the GPS receiver to find your location, make sure you have a clear view of the sky.

To enable GPS

- 1 From your Home screen, tap .
- 2 Tap **Settings** > **Location services**.
- 3 Mark the **GPS satellites** checkbox.

Getting the best performance

The first time you use the GPS it can take 5 to 10 minutes for your location to be found. To help the search, make sure you have a clear view of the sky. Stand still and don't cover the GPS antenna (the highlighted area in the image). The GPS signals can pass through clouds and plastic, but not through most solid objects such as buildings and mountains. If your location isn't found after a few minutes, move to another location.



Google Maps™

Track your current location, view real-time traffic situations and receive detailed directions to your destination. Before taking trips, you can download and save maps to your memory card to avoid high roaming costs.

- ! The Google Maps™ application requires the use of an Internet connection. You may incur data connection charges when you connect to the Internet from your device. Contact your network operator for more information. The Google Maps™ application may not be available in every market, country or region.

To use Google Maps™

- 1 From your **Home screen**, tap .
- 2 Find and tap **Maps**.

- ! If you want to use Google Maps™, you have to enable one of the location methods available under **Settings > Location services**.

To learn more about Google Maps™

- When you use Google Maps™, tap , then tap **Help**.

Viewing your friends' locations with Google Latitude™

Join Google Latitude™ to view your friends' locations on maps and share your location and other information with them.

Using Google Maps™ to get directions

Use the Google Maps™ application to get directions when you travel by foot, public transportation, or car. You can add a shortcut to a destination on your Home screen to get quick directions from wherever you are.

When you view a map, you make an Internet connection, and data is transferred to your device. So it's a good idea to download and save maps to your device before you take a trip. This way, you can avoid high roaming costs.

- ! Sony does not warrant the accuracy of any directional services.

Using the Navigation application

Use the Navigation application in your device to get turn-by-turn instructions on how to get places. The directions are both spoken and displayed on the screen.

- ! The Navigation application may not be available in every market.

To start Navigation

- 1 From your **Home screen**, tap .
- 2 Find and tap **Navigation**.

Calendar and alarm clock



Calendar

Your device has a calendar application for managing your time schedule. If you have a Google™ account, you can also synchronise the calendar application on your device with your web calendar.

To set the calendar view

- 1 From your **Home screen**, tap , then find and tap **Calendar**.
- 2 Tap **Month**, **Week** or **Day** to select an option.

To view multiple calendars

- 1 From your **Home screen**, tap , then find and tap **Calendar**.
- 2 Press , then tap **My calendars**.
- 3 Select the calendars you want to view.

To create a calendar event



- 1 From your **Home screen**, tap , then tap **Calendar**.
- 2 Tap **+**.
- 3 Enter the name, time, location and description for the event.
- 4 Select a reminder for the event. To add a new reminder for the event, tap **+**.
- 5 If desired, tap **More** and select another option under **Repetition**.
- 6 Tap **Done**.

- When the appointment time approaches, your device plays a short sound to remind you. Also,  appears in the status bar.

To view a calendar event

- 1 From your **Home screen**, tap , then tap **Calendar**.
- 2 Tap the event you want to view.

To change the calendar settings

- 1 From your **Home screen**, tap , then tap **Calendar**.
- 2 Press , then tap **Settings**.
- 3 Tap the setting you want to change, then edit as desired.

Alarm clock

Use your device as an alarm clock and select any sound saved on your device as your alarm signal. The alarm does not sound if your device is turned off. But it does sound when the device is set to silent mode.

To open the alarm clock

- 1 From your **Home screen**, tap .
- 2 Find and tap **Alarm & clock**.

To set a new alarm



- 1 From your **Home screen**, tap .
- 2 Find and tap **Alarm & clock**.
- 3 Tap **Add alarm**.
- 4 Tap **Time** and adjust the time by scrolling up and down.
- 5 Tap **Done**.
- 6 If desired, edit other alarm settings.
- 7 Tap **Done**.

To edit an existing alarm



- 1 From your **Home screen**, tap .
- 2 Find and tap **Alarm & clock**.
- 3 Tap the alarm you want to edit.
- 4 Tap **Time** and adjust the time by scrolling up and down.
- 5 Tap **Done**.
- 6 If desired, edit other alarm settings.
- 7 Tap **Done**.

! The alarm time format displayed is the same as the format you select for your general time settings, for example, 12-hour or 24-hour.

To deactivate an alarm

- 1 From your **Home screen**, tap .
- 2 Find and tap **Alarm & clock**.
- 3 Tap  next to the alarm you want to deactivate.

To activate an existing alarm

- 1 From your **Home screen**, tap .
- 2 Find and tap **Alarm & clock**.
- 3 Tap  next to the alarm you want to activate.

To delete an alarm

- 1 From your **Home screen**, tap .
- 2 Find and tap **Alarm & clock**.
- 3 Touch and hold the alarm you want to delete.
- 4 Tap **Delete alarm**, then tap **Yes**.

To set the ringtone for an alarm

- 1 From your **Home screen**, tap .
- 2 Find and tap **Alarm & clock**.
- 3 Tap the alarm you want to edit.
- 4 Tap **Advanced alarm settings** and unmark the **Style settings** checkbox.
- 5 Tap **Alarm sound** and select an option.
- 6 Tap **Done**, then tap **Done**.

To set a recurring alarm

- 1 From your **Home screen**, tap .
- 2 Find and tap **Alarm & clock**.
- 3 Tap the alarm you want to edit.
- 4 Tap **Repeat**.
- 5 Mark the checkboxes for the desired days, then tap **OK**.
- 6 Tap **Done**.

To set the title for an alarm

- 1 From your **Home screen**, tap .
- 2 Find and tap **Alarm & clock**.
- 3 Tap the alarm you want to edit.
- 4 Tap **Advanced alarm settings**, then tap the **Alarm text** field and enter a name for the alarm.
- 5 Tap **Done**.

To activate the vibrate function for an alarm

- 1 From your **Home screen**, tap .
- 2 Find and tap **Alarm & clock**.
- 3 Tap the alarm you want to edit.
- 4 Tap **Advanced alarm settings**, then mark the **Vibrate** checkbox.
- 5 Tap **Done**.

To set alarms to sound when the device is in silent mode

- 1 From your Home screen, tap .
- 2 Find and tap Alarm & clock, then tap to select an alarm.
- 3 Tap Advanced alarm settings, then mark the Alarm in silent mode checkbox.
- 4 Tap Done.

To snooze an alarm when it sounds

- Tap Snooze - min.

To turn off an alarm when it sounds

- Slide  to the right.

Support and maintenance

Updating your device

Update your device to the most recent software version to get optimal performance and the latest enhancements.

You can use the Update center application on your device to run a wireless update or you can use the PC Companion application on a computer to run an update using a USB cable connection. If you update wirelessly, then you can use either a mobile network or a Wi-Fi® network connection. Just make sure you back up and save all data stored on your device before you update.

- ! When you run an update using the Update center application, a data connection is established and related charges may be incurred. Also, the availability of updates over a mobile network depends on your operator. Contact your network operator for more information.

Updating your device wirelessly



Use the Update center application to update your device wirelessly. You can download software updates manually, or you can allow Update service to update your device automatically whenever downloads become available. When the automatic update feature is activated, a notification appears in the status bar every time an update becomes available.

To download software updates manually from Update center

- 1 From your Home screen, tap .
- 2 Find and tap **Update Centre**.
- 3 Select the desired application or system update and tap **Download**, or tap **Update all** to download all application updates.

- ! Application updates launch automatically after download. With system updates, wait for your device to restart, then install the update manually. You may incur data connection charges when downloading updates over mobile networks.

To activate automatic software updates using the Update Center application

- 1 From your Home screen, tap .
- 2 Find and tap **Update Centre**.
- 3 Press , then tap **Settings**.
- 4 Mark the **Allow automatic downloads** checkbox, then tap **Agree**. Updates are now downloaded automatically as soon as they become available.

- ! You may incur data connection charges when downloading updates over mobile networks.

To install system updates

- 1 From your Home screen, tap .
- 2 Find and tap **Update Centre**.
- 3 Select a system update you want to install, then tap **Install**.

Updating your device using a USB cable connection

Some updates are not available for wireless download. Notifications appear in the status bar to inform you of such updates. To download and run the updates, you need a USB cable and a computer running the PC Companion application. You can install PC Companion on the computer using installation files saved on your device, or you can download the application directly from *PC Companion*.

To download the PC Companion application from your device

- 1 Connect your device to a computer using a USB cable.
 - 2 When prompted, follow the instructions in your device to launch the installation of PC Companion on the computer.
- 💡 PC Companion can also be downloaded from *PC Companion*.

To download software updates using a USB cable connection

- 1 Install the PC Companion application on the computer you are using, if it is not already installed.
- 2 Connect your device to the computer using a USB cable.
- 3 **Computer:** Launch the PC Companion application. After a few moments, PC Companion detects your device and searches for new software for it.
- 4 **Device:** When notifications appear in the status bar, follow the on-screen instructions to carry out the relevant software updates.

To update your device using an Apple® Mac® computer

- 1 Install Sony™ Bridge for Mac application on the Apple® Mac® computer you are using, if it is not already installed.
 - 2 Using a USB cable, connect your device to the Apple® Mac® computer.
 - 3 **Computer:** Launch Sony™ Bridge for Mac application. After a few moments, Sony™ Bridge for Mac application detects your device and searches for new software for it.
 - 4 **Computer:** If a new software update is detected, a popup window appears. Follow the on-screen instructions to carry out the relevant software updates.
- ! Sony™ Bridge for Mac application is downloadable from *Bridge for mac*.

Backup and restore application

Use the Backup and restore application to make backups of content to a memory card or a USB storage device. Such backups can be used to restore your content and some settings in cases where your data gets lost or deleted.

Types of content you can back up

Use the Backup and restore application to back up the following types of data:

- Bookmarks
 - Call log
 - Contacts
 - Applications downloaded from Google Play™
 - Multimedia messages
 - System settings (such as alarms, ringer volume, and language settings)
 - Text messages
- ! You do not need to back up music files and photos or videos taken with the camera. They are backed up automatically to the device's memory card.
- ! You may incur additional data transmission charges when you restore applications from Google Play™.

Preparing to use the Backup and restore application

Before backing up your content, you can select the backup destination and the types of data that you want to back up.

To select the backup destination

- 1 From your **Home screen**, tap .
- 2 Find and tap **Back up & restore**.
- 3 Tap **Back up**.
- 4 Tap the bar under **Where to store data**.
- 5 Select the destination to which you want to back up your content.

To select the data types to back up

- 1 From your **Home** screen, tap .
- 2 Find and tap **Back up & restore**.
- 3 Tap **Back up**.
- 4 Select the data types that you want to back up.

To back up content

- 1 From your **Home** screen, tap .
- 2 Find and tap **Back up & restore**.
- 3 Tap **Back up**, then tap **Back up now**.

Restoring backed up content using the Backup and restore application

When you restore backed up content, you must select a backup record to restore from. If you have backed up content several times, you may have several backup records. After you select a backup record, you can then select which types of data to restore.



To restore content from a backup record

- 1 From your **Home** screen, tap .
 - 2 Find and tap **Back up & restore**.
 - 3 Tap **Restore**.
 - 4 Select the record that you want to restore from, then tap **Restore now**.
- ! Remember that any changes you make to your data and settings after you create a backup will get deleted during a restore procedure.



Managing backup records

You can delete or rename records of the backups that you make using the Backup & restore function.

To rename a backup record

- 1 From your **Home** screen, tap .
- 2 Find and tap **Back up & restore**.
- 3 Press , then tap **Manage backup records**.
- 4 Select the backup record that you want to rename.
- 5 Tap .
- 6 Enter a new name and tap **Rename**.

To delete backup records

- 1 From your **Home** screen, tap .
- 2 Find and tap **Back up & restore**.
- 3 Press , then tap **Manage backup records**.
- 4 Select the backup record that you want to delete, or tap if you want to delete all records.
- 5 Tap  > **Delete**.

Resetting your device

About resetting your device

You can reset your device to its original settings, with or without deleting all of your personal data. It is possible to reset your device to the state it was in before you first turned it on. But before you perform a reset, make sure to back up any important data saved on your device.

To perform a factory data reset

- ⚠ To avoid permanent damage to your device, do not restart your device while a reset procedure is underway.
- 1 From your **Home** screen, tap .
- 2 Find and tap **Settings > Backup & reset**.
- 3 Tap **Factory data reset**.
- 4 If you also want to erase data such as pictures and music, which is saved to your device's internal storage, mark the **Erase internal storage** checkbox.
- 5 Tap **Reset phone**.
- 6 To confirm, tap **Erase everything**.

Locking and protecting your device

IMEI number

Every device has a unique IMEI (International Mobile Equipment Identity) number. You should keep a copy of this number. If your device is stolen, your network provider can use your IMEI number to stop the device from accessing the network in your country.

To view your IMEI number



- Turn off your phone, then remove the battery cover and battery to view your IMEI number.
- Open the phone dialer on your device and enter ***#06#**.

To view your IMEI number in the device

- 1 From your **Home** screen, tap .
- 2 Find and tap **Settings > About phone > Status**.
- 3 Scroll to **IMEI** to view the IMEI number.

Setting a screen lock

There are several ways to lock the screen on your device. For example, you can use the Face Unlock feature, which uses a picture of your face to unlock the screen. You can also set a screen unlock pattern, a number-based PIN lock, or a text-based password.

It is very important that you remember your screen unlock pattern, PIN or password. If you forget this information, it may not be possible to restore important data such as contacts and messages. Refer to Sony customer support for more information.

To set a screen lock

- 1 From your **Home** screen, tap  > **Settings** > **Security** > **Screen lock**.
- 2 Select an option.

To set up the Face Unlock feature

- 1 From your **Home** screen, tap  > **Settings** > **Security** > **Screen lock**.
- 2 Tap **Face Unlock**, then follow the instructions in your device to capture your face.
- 3 After your face is successfully captured, tap **Continue**.
- 4 Select a backup lock method and follow the instructions in the device to complete the setup.

! The Face Unlock feature is less secure than a screen lock pattern, PIN, or password. Someone who looks similar to you could unlock your device.

💡 For best results, capture your face in an indoor area that is well lit but not too bright, and hold the device at eye level.

To unlock the screen using the Face Unlock feature

- 1 Activate the screen.
- 2 Look at your device from the same angle you used to capture your Face Unlock photo.

💡 If the Face Unlock feature fails to recognise your face, you need to draw the backup pattern or enter the PIN to unlock the screen.

To disable the Face Unlock protection

- 1 From your **Home** screen, tap  > **Settings** > **Security** > **Screen lock**.
- 2 Draw your backup screen unlock pattern or enter your PIN.
- 3 Tap **Swipe**.

To create a screen unlock pattern

- 1 From the **Home** screen, tap .
- 2 Find and tap **Settings** > **Security** > **Screen lock** > **Pattern**.
- 3 Follow the instructions in your device. You are asked to select a security question that will be used to unlock the device if you forget your screen unlock pattern.

To unlock the screen using a screen unlock pattern

- 1 Activate the screen.
- 2 Draw your screen unlock pattern.

! If the unlock pattern you draw on the screen is rejected five times in a row, you can select to either wait 30 seconds and then try again, or to answer the security question you have selected.



To change the screen unlock pattern

- 1 From your **Home** screen, tap .
- 2 Find and tap **Settings** > **Security** > **Screen lock**.
- 3 Draw your screen unlock pattern.
- 4 Tap **Pattern**.
- 5 Follow the instructions in your device.

To disable the screen unlock pattern

- 1 From your **Home** screen, tap  > **Settings** > **Security** > **Screen lock**.
- 2 Draw the screen unlock pattern.
- 3 Tap **Swipe**.



To create a screen unlock PIN

- 1 From your Home screen, tap  > **Settings** > **Security** > **Screen lock** > **PIN**.
- 2 Enter a numeric PIN.
- 3 If necessary, tap  to minimise the keyboard.
- 4 Tap **Continue**.
- 5 Re-enter and confirm your PIN.
- 6 If necessary, tap  to minimise the keyboard.
- 7 Tap **OK**.

To disable the screen unlock PIN

- 1 From your Home screen, tap  > **Settings** > **Security** > **Screen lock**.
- 2 Enter your PIN, then tap **Next**.
- 3 Tap **Swipe**.

To create a screen lock password

- 1 From your Home screen, tap  > **Settings** > **Security** > **Screen lock** > **Password**.
- 2 Enter a password.
- 3 If necessary, tap  to minimise the keyboard.
- 4 Tap **Continue**.
- 5 Re-enter and confirm your password.
- 6 If necessary, tap  to minimise the keyboard.
- 7 Tap **OK**.

To disable the screen unlock password

- 1 From your Home screen, tap  > **Settings** > **Security** > **Screen lock**.
- 2 Enter your password and tap **Continue**.
- 3 Tap **Swipe**.

Support application

To access the support application

- 1 From your Application screen, find and tap .
- 2 Find and tap the required support item.

Recycling your device

Got an old device lying around the house? Why not recycle it? By doing so, you will help us reuse its materials and components, and you'll protect the environment, too! Find out more about the recycling options in your region at blogs.sonymobile.com/about-us/sustainability/commitment/overview/.

Reference

Settings overview

Get to know the settings in your device so that you can personalise them to your own requirements.

























Wi-Fi	Turn Wi-Fi® on or off, scan for available Wi-Fi® networks, or add a Wi-Fi® network.
Bluetooth	Turn Bluetooth™ on or off, search for available Bluetooth™ devices, and make your device visible or invisible to other Bluetooth™ devices.
Data usage	Turn the mobile data traffic on or off, and keep track of your data usage details over a specified period of time.
More...	Turn Airplane mode on or off, configure settings for VPN and mobile networks, and enable your device to share its mobile data connection as a portable Wi-Fi® hotspot, or via USB tethering or Bluetooth™ tethering. You can also enable or disable the NFC function.
Call settings	Manage and configure settings for fixed dialing numbers, voicemail and Internet calls.
Sound	Configure how your device rings, vibrates, or alerts you when you receive communications. You can also use these settings to set the volume level for music, video, games or other media with audio, and to make related adjustments.
Display	Enable the screen to switch orientation when you rotate your device. You can also set the brightness, font size, wallpaper and screen timeout.
Storage	Check out the available space on the internal storage and on the SD card. You can also erase the SD card, or unmount it for safe removal.
Power management	Turn the power saving modes on or off. You can also view your battery status and see how different applications consume battery power.
Apps	Manage running applications, downloaded applications and applications on the SD card.
Xperia™	Access a range of settings tailored to your Xperia device, for example, USB connection mode, Internet, screen mirroring, security, and Throw settings.
Location services	Enable or disable access to your location information.
Security	Protect your device by setting up different locks and passwords. You can also allow the installation of applications not from Google Play™.
Language & input	Select the device language, adjust text input options, add words to the personal dictionary and configure speech settings.
Backup & reset	Back up your data and reset your device.
Setup guide	Get help setting up your device.
Add account	Add an account on your device, for example, an email account or a Google™ account.

Date & time	Set the time and date, or choose the network-provided values. Select your preferred date and hour format.
Accessibility	Enable your installed accessibility services and adjust related settings.
Developer options	Set options for application development. For example, you can display CPU usage on the Home screen or set your device to enter debug mode when USB connections are active.
About phone	View information about your device, such as the model number and signal strength. You can also update your software to the latest version.

Status and notification icons overview

















Status icons

The following status icons may appear on your screen:













	Signal strength
	No signal
	Roaming
	GPRS is available
	EDGE is available
	NFC is activated
	3G is available
	Sending and downloading GPRS data
	Sending and downloading EDGE data
	Sending and downloading 3G data
	Battery status
	The battery is charging
	GPS is activated
	Airplane mode is activated
	The Bluetooth™ function is activated
	The SIM card is not inserted
	The microphone is muted
	The speakerphone is on
	Silent mode
	Vibrate mode
	An alarm is set
	Synchronisation is ongoing
	Problem with sign-in or synchronisation
	A Wi-Fi® connection is enabled and wireless networks are available

















Notification icons

The following notification icons may appear on your screen:

	New email message
	New text message or multimedia message
	New voicemail
	An upcoming calendar event
	A song is playing
	The device is connected to a computer via a USB cable
	Warning message
	Error message
	Missed call
	Call ongoing
	Call on hold
	Call forwarding on
	Software updates available
	Downloading data
	Uploading data
	More (undisplayed) notifications

Application overview

	Use the Alarm and clock application to set various kinds of alarms.
	Use your web browser to navigate and view web pages, manage bookmarks, and manage text and images.
	Use the Calculator application to perform basic calculations.
	Use the Calendar application to keep track of your events and manage your appointments.
	Use the camera to take photos and record video clips.
	Use the Contact application to manage phone numbers, email address and other information related to your contacts.
	Access your downloaded applications.
	Use the Email application to send and receive emails through both private and corporate accounts.
	Use the Facebook application to engage in social networking with friends, family members and colleagues around the world.
	Browse and listen to FM radio stations.
	Use the Album application to view and to work with your photos and videos.
	Use the Gmail™ application to read, write and organise email messages.
	Search for information in your device and on the web.

-  View your current location, find other locations, and calculate routes using Google Maps™.
-  Go to Google Play™ to download free and paid applications for your device.
-  Use the Messaging application to send and receive text and multimedia messages.
-  Use the Movies application to play videos in your device, and share videos with your friends or on other devices using DLNA™.
-  Use the "WALKMAN" application to organise and play music, audio books and podcasts.
-  Navigate your way using spoken, turn-by-turn instructions.
-  View news stories and weather forecasts.
-  Make phone calls by dialling the number manually or by using the smart dial function.
-  Search for places, for example, restaurants and cafés.
-  Use the Video Unlimited™ application to rent and purchase videos.
-  Use the subscription-based Music Unlimited™ application to access millions of songs over a mobile data connection or Wi-Fi® connection.
-  Optimise settings to suit your own requirements.
-  Use the Google Talk™ application to chat with friends online.
-  Identify music tracks that you hear playing in your surroundings, and get artist, album and other info.
-  Use the Help application to access user support in the device. For example, you can access a User guide, troubleshooting information, plus tips and tricks.
-  Use YouTube™ to share and view videos from around the world.
-  Download and install new applications and updates.

! Some applications are not supported all networks and/or service providers in all areas.

Important information

Important information leaflet

Before you use your device, please read the Important information leaflet provided in the Setup guide in your device or in the box.

To access the setup guide manually

- 1 From the Home screen, tap .
- 2 Tap **Settings** > **Setup guide**.

Limitations to services and features

Some of the services and features described in this User guide are not supported in all countries/regions or by all networks and/or service providers in all areas. Without limitation, this applies to the GSM International Emergency Number, 112. Please contact your network operator or service provider to determine availability of any specific service or feature and whether additional access or usage fees apply.

Use of certain features and applications described in this guide may require access to the Internet. You may incur data connection charges when you connect to the Internet from your device. Contact your wireless service provider for more information.

Protecting your device from water and dust

In order for your device to be waterproof, the covers for the micro USB port and the headset jack must be firmly closed. Also, make sure that the battery cover is attached correctly.

Avoid exposing your device to environments with excessive dust or moisture. Normal wear and tear along with damage to your device can reduce its ability to resist dust or moisture. You can use the device in the following fresh (non-saline) water conditions:



Swimming pool



Diving

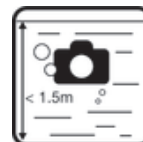

Shooting photos
and videos

- ! You should only use the device in water depths of 1.5 metres or less.

Do not use your device in the following conditions:



Sand/mud



Salt water



Other liquid
chemicals

- ! Water can sometimes cause unintended touch actions on the screen. So it is recommended to activate the Touch Block function before using the device in water. You may need to first download the Touch Block application by using the Update center application in your device.

Your smartphone is waterproof and dust resistant in compliance with the Ingress Protection ratings IP5X, IPX5 and IPX8 (see details below). Always firmly attach all covers to ensure the water and dust resistance of the device. If liquid is detected inside the device, for example, underneath one of the covers or on the battery, your warranty will be void. Never submerge your device in salt water or let the micro USB port or headset jack come in contact with salt water. Also, never expose the device to any liquid chemicals, or to moist environments with extreme high or low temperatures. The waterproof ability of the micro USB port and the headset jack is not guaranteed in all environments or conditions. After using the device in water, dry off the areas around the micro USB port cover and the headset jack cover.

If the speaker or microphone get wet, dry these areas and wait for three hours before using them again. You can, however, use other features in the device that do not utilise the speaker or microphone.

All compatible accessories, including batteries, chargers, handsfree devices and micro USB cables, are not waterproof and dust resistant on their own.

Your warranty does not cover damage or defects caused by abuse or improper use of your device. If you have any further questions about the use of your products, refer to our Customer support service for help.

IP (Ingress Protection) rating

Your device has an IP rating, which means it has undergone certified tests to measure its resistance levels to both dust and water. The first digit in the two-digit IP rating indicates the level of protection against solid objects, including dust. The second digit indicates how resistant the device is to water. The higher the numbers, the higher the respective protection.

Your smartphone is waterproof and dust resistant in compliance with the Ingress Protection ratings IP5X, IPX5 and IPX8 (see details below). These ratings mean that your device is dust resistant and is protected against low pressure water stream as well as against the effects of submersion for 30 minutes in fresh (non-saline) water up to 1.5 metres deep. You can therefore use the device in dusty environments, when your fingers are wet, and in extreme weather conditions, for example, when it's snowing or raining, or when humidity levels are high. You can also use the device in fresh water conditions (for example, in a swimming pool) to take underwater photos or shoot underwater videos using the Camera key. See the table below for more details.

Resistance to solid objects and dust	Resistance to water
IP0X. No special protection	IPX0. No special protection
IP1X. Protected against solid objects > 50 mm in diameter	IPX1. Protected against dripping water
IP2X. Protected against solid objects > 12.5 mm in diameter	IPX2. Protected against dripping water when tilted up to 15 degrees from normal position
IP3X. Protected against solid objects > 2.5 mm in diameter	IPX3. Protected against spraying water
IP4X. Protected against solid objects > 1 mm in diameter	IPX4. Protected against splashing water
IP5X. Protected against dust; limited ingress (no harmful deposit)	IPX5. Protected against water jet spray
IP6X. Dust tight	IPX6. Protected against heavy jet spray
	IPX7. Protected against the effects of immersion
	IPX8. Protected against submersion

! The IPX5 and IPX8 ratings are based on tests lasting 30 minutes in water depths of 1.5 metres. Go to www.sonymobile.com/testresults for more information.

Legal information

Sony C5503/C5502

This User guide is published by Sony Mobile Communications AB or its local affiliated company, without any warranty. Improvements and changes to this User guide necessitated by typographical errors, inaccuracies of current information, or improvements to programs and/or equipment, may be made by Sony Mobile Communications AB at any time and without notice. Such changes will, however, be incorporated into new editions of this User guide.

©Sony Mobile Communications AB, 2013.

All rights reserved.

Your mobile phone has the capability to download, store and forward additional content, for example, ringtones. The use of such content may be restricted or prohibited by rights of third parties, including but not limited to restriction under applicable copyright laws. You, and not Sony, are entirely responsible for additional content that you download to or forward from your mobile phone. Prior to your use of any additional content, please verify that your intended use is properly licensed or is otherwise authorized. Sony does not guarantee the accuracy, integrity or quality of any additional content or any other third party content. Under no circumstances will Sony be liable in any way for your improper use of additional content or other third party content.

This User guide may reference services or applications provided by third parties. Use of such programming or services may require separate registration with the third party provider and may be subject to additional terms of use. For applications accessed on or through a third-party website, please review such websites' terms of use and applicable privacy policy in advance. Sony does not warrant or guarantee the availability or performance of any third-party websites or offered services.

Remove the battery to see regulatory information such as the CE mark.

All product and company names mentioned herein are the trademarks or registered trademarks of their respective owners. Any rights not expressly granted herein are reserved. All other trademarks are property of their respective owners.

Visit www.sonymobile.com for more information.

All illustrations are for illustration purposes only and may not accurately depict the actual phone.

This product is protected by certain intellectual property rights of Microsoft. Use or distribution of such technology outside of this product is prohibited without a license from Microsoft.

Content owners use Windows Media digital rights management technology (WMDRM) to protect their intellectual property, including copyrights. This device uses WMDRM software to access WMDRM-protected content. If the WMDRM software fails to protect the content, content owners may ask Microsoft to revoke the software's ability to use WMDRM to play or copy protected content. Revocation does not affect unprotected content. When you download licenses for protected content, you agree that Microsoft may include a revocation list with the licenses. Content owners may require you to upgrade WMDRM to access their content. If you decline an upgrade, you will not be able to access content that requires the upgrade.

This product is licensed under the MPEG-4 visual and AVC patent portfolio licenses for the personal and non-commercial use of a consumer for (i) encoding video in compliance with the MPEG-4 visual standard ("MPEG-4 video") or the AVC standard ("AVC video") and/or (ii) decoding MPEG-4 or AVC video that was encoded by a consumer engaged in a personal and non-commercial activity and/or was obtained from a video provider licensed by MPEG LA to provide MPEG-4 and/or AVC video. No license is granted or shall be implied for any other use. Additional information including that relating to promotional, internal and commercial uses and licensing may be obtained from MPEG LA, L.L.C. See <http://www.mpegla.com>. MPEG Layer-3 audio decoding technology licensed from Fraunhofer IIS and Thomson.

Index

A	
accounts	11
Exchange Active Sync®	11
Facebook™	11
Google™	11
adjusting volume	59
Airplane mode	31
alarm	115
Album	81, 82
map	86
My albums	83
online albums	87
opening	81
pictures	82
SensMe™ slideshow	84
thumbnail size	82
viewing	82, 83, 86, 87
viewing local content	81
viewing online photos	88
Android Market™ - See Google Play™	37
Android™	7
animated wallpaper	20
answering service	41
applications	
arranging	22
overview	126
screen	20
sorting	22
audio	62
adjusting volume	59
playing	59
playing tracks in random order	62
audio content	
related content	60
B	
back cover	
attaching	9
removing	8
backing up	
contacts	49, 119
content	119
battery	12
Bluetooth™ wireless technology	102
BRAVIA® Engine	81
brightness	31
business cards	
sending	48
C	
calendar	115
create an event	115
calls	39, 43
barring	42
diverting	42
emergency	39
forwarding	42
log	40
missed	40
multiple	41
reject	42
settings	42
waiting	41
camera	70, 72, 77
closing	70
controls	70
face detection	71
geotagging	72
icons	77
overview	70
recording videos	76, 77
screen	70
self-portraits	71
settings	72, 77
smile detection	72
Smile Shutter™	72
taking photos	70, 71, 72
using the flash	71
video	76
viewing photos	71
viewing videos	77
zoom	71
caps lock	25
charging	12
chat	52
conference calls	41
connectivity	94
contacts	44
backing up	49
copying	49
favourite	48
groups	48
importing from SIM card	45
joining contact information	47
picture	47
sending	48
sharing	48
transferring	44, 45
corporate email, calendar and contacts	110
cropping	
photos	84
D	
data traffic	34
date	
format	30
deleting	59
an alarm	115
music	65
photos	85
tracks	59
videos	86
device	
battery	13
performance	13
update	118
download	
Internet settings	33
driving directions	114
E	
editing	
photos	85
email	53
more than one account	53
emergency numbers	39
equaliser	59
events	
calendar	115
extensions	18
F	
face detection	71
Facebook™	
"Like" a track on Facebook™	60
synchronisation	111

Xperia™ with Facebook	111	micro SIM card	
favourites		inserting	9
removing radio channels as	68	Microsoft® Exchange synchronisation	110
saving radio channels as	68	Mobile BRAVIA® Engine	81
fixed dialling	43	Movies	89
flash		clearing video information	90
using when taking photos	71	Multimedia Messaging Service (MMS)	
Flight mode - See Airplane mode	31	settings	33
FM radio		music	33, 58, 63
favourites	68	adjusting volume	59
selecting a channel	67	changing tracks	59
Friends' music	62	deleting	65
front camera	70	downloading music information	61
G		hearing protection	63
geotagging		My playlists	63
of photos	72	pausing a track	59
gesture input	27	playing	59
Gmail™	53	purchasing	64
Google Latitude™	114	searching using TrackID™	64
Google Maps™	114	sending	60
Google Play™	37	sharing	64
Google Talk™	52	shortcuts	61
Google™ account setup	54	transferring to your device	58
Google™ synchronisation	110	transferring to/from a computer	58
GPS	113	using a headset	33
H		viewing artist info	65
headset	33	Visualiser	60
using	33	music services	64
Home screen	18	Music Unlimited™	65
customising	19	My music	61
I		N	
icons	125, 126	Navigation application	114
in the camera	77	notification	126
importing SIM contacts	45	light	23
improving photos with Mobile BRAVIA® Engine ...	81	panel	23, 24
infinite button	60	ringtone	30
instant messaging	52	setting	24
Internet		O	
settings	33	on-screen keyboard	25
web browser	93	overview	61
K		P	
keyboard	25	pausing a track	59
settings	28	personal information	44
keys	12	phone maintenance	118
L		phonebook	44
language	31	Phonepad	25, 27
writing	28	photo albums	
Latitude	114	viewing	81
LCD backlight control	31	photos	85
"Like" a photo on Facebook™	88	adding a geotag	85
"Like" a track on Facebook™	60	adding the geographical position	72
"Like" a video on Facebook™	88	associating with a contact	47
live wallpaper	20	cropping	84
location	72, 113	deleting	85
locks		editing	85
activating the screen	10	photo viewer	82
locking the screen	10	rotating	84
screen lock	10	selecting	82
M		SensMe™ slideshow	84
maintenance	118	sharing	85
Maps	113, 114	slideshow	84
marking options	15	taking	70, 71, 72
Media Go™	106	transferring to/from a computer	58
messages		using as	84
settings	33	viewing	71, 81, 82
MHL (Mobile High-Definition Link)	106	viewing on a map	86
		viewing same location	72
		zooming	84
		PIN	121

playing	
music	59
playlists	62
adding a track	62
deleting	63
playing your own	63
removing tracks	63
powering off	10
powering on	10
presets	
removing radio channels as	68
saving radio channels as	68
protective plastic sheet	15
PUK	121
purchasing	
music	64
R	
radio	67
favourites	68
listening to with the speaker	68
mono sound	68
moving between channels	67
opening	67
radio region	67
searching for channels	68
selecting a channel	67
stereo sound	68
visualizer	67
radio sound	68
receiving items using Bluetooth™	103
recently used applications window	21
recommending music	60
recommending photos and videos	88
recording videos	70
using the camera key	76
recycling your device	123
resetting	120
resizing	
photos	84
ringtone	115
rotating	
photos	84
S	
scanning barcodes	107
screen	31
cracked	15
glass	15
screen unlock pattern	121
warranty	15
screen mirroring	107
searching	
music using TrackID™	64
track information	64
self-portrait	70
sending	
business cards	48
contacts	48
music	60
sending items using Bluetooth™	103
SensMe™ channels	62
services	11
settings	
call	42
camera	72, 77
data usage	34
Internet	33
messaging	33
MMS	33
quick settings	23
still camera	72
video camera	77
setup guide	10
sharing	
music	64
photos	85
shuffle music	62
silent mode	29
SIM card	121
exporting contacts to	49
importing contacts from	45
slideshow	84
Smart Connect	108
smile detection	72
Smile Shutter™	72
SOS - See emergency numbers	39
STAMINA mode	
changing settings	14
standby time	
estimating	14
status	125
bar	23
still camera	70, 72
settings	72
support	118
Support application	123
surround sound feature	59
symbols	25
synchronising	110
Facebook™ contacts, calendar, photos	111
Google™ contacts, calendar, email	110
with Microsoft® Exchange	110
T	
taking photos	70
by tapping	71
self-portraits	71
using face detection	71
using smile detection	72
using Smile Shutter™	72
using the camera key	70
telephony - See calls	39
tethering	
USB tethering	95
with Xperia Link™	95
text input method	25
themes	20
time	30
time management	115
TrackID™ technology	64
buying a track	64
deleting a track	65
opening	64
searching for track information	64
sharing a track	64
using results	64
using with the FM Radio	69
viewing artist info	65
viewing charts	64
transferring	
contacts	44, 45
turning off	10
turning on	10
U	
updating your device	118
usage info	34
USB connection	104
using Movies	89
using the equaliser	59

V	
vibration	30, 115
video albums	
viewing	81
video camera	70, 76, 77
recording videos	77
settings	77
Video Unlimited™	91
buying videos	91
creating an account	91
menu overview	91, 92
notifications	91
renting videos	91
watching a video	92
videos	85
adjusting volume	85
deleting	86
fast forwarding and rewinding	85
pausing	85
playing	85
recording	76, 77
selecting	82
sending	85
sharing	85
transferring to/from a computer	58
viewing	77, 81, 82
viewing	
Movies	89
photos	71
videos recorded using the camera	77
voice input	29
voice recognition	29
voicemail	41
volume	
adjusting for videos	85
key	29
W	
"WALKMAN" application	
adding tracks to playlists	62
deleting tracks	59
minimising	59
overview	58
playing tracks in random order	62
playlists	62
using	59
using the equaliser	59
"WALKMAN" application widget	63
wallpaper	20
web browser	93
widgets	19
resizing	19
wireless networks	113
Z	
zoom	71
zooming	
photos	84