

Multi Channel AV Receiver

Operating Instructions

STR-DH700

WARNING

To reduce the risk of fire or electric shock, do not expose this apparatus to rain or moisture.

To reduce the risk of fire, do not cover the ventilation opening of the apparatus with newspapers, tablecloths, curtains, etc. Do not place the naked flame sources such as lighted candles on the apparatus.

Do not install the appliance in a confined space, such as a bookcase or built-in cabinet.

To reduce the risk of fire or electric shock, do not expose this apparatus to dripping or splashing, and do not place objects filled with liquids, such as vases, on the apparatus.

As the main plug is used to disconnect the unit from the mains, connect the unit to an easily accessible AC outlet. Should you notice an abnormality in the unit, disconnect the main plug from the AC outlet immediately.

Do not expose batteries or apparatus with battery-installed to excessive heat such as sunshine, fire or the like.

The unit is not disconnected from the mains as long as it is connected to the AC outlet, even if the unit itself has been turned off.

Excessive sound pressure from earphones and headphones can cause hearing loss.

For customers in the United States and Canada



This symbol is intended to alert the user to the presence of the Hot Surface that may be hot if it is touched during the normal operation.



ENERGY STAR® is a U.S. registered mark.

As an ENERGY STAR® partner, Sony Corporation has determined that this product meets the ENERGY STAR® guidelines for energy efficiency.

For customers in the United States

Owner's Record

The model and serial numbers are located on the rear of the unit. Record these numbers in the space provided below. Refer to them whenever you call upon your Sony dealer regarding this product.

Model No. _____ Serial No. _____



This symbol is intended to alert the user to the presence of uninsulated "dangerous voltage" within the product's enclosure that may be of sufficient magnitude to constitute a risk of electric shock to persons.



This symbol is intended to alert the user to the presence of important operating and maintenance (servicing) instructions in the literature accompanying the appliance.

Important Safety Instructions

- 1) Read these instructions.
- 2) Keep these instructions.
- 3) Heed all warnings.
- 4) Follow all instructions.
- 5) Do not use this apparatus near water.
- 6) Clean only with dry cloth.
- 7) Do not block any ventilation openings. Install in accordance with the manufacturer's instructions.
- 8) Do not install near any heat sources such as radiators, heat registers, stoves, or other apparatus (including amplifiers) that produce heat.
- 9) Do not defeat the safety purpose of the polarized or grounding-type plug. A polarized plug has two blades with one wider than the other. A grounding type plug has two blades and a third grounding prong. The wide blade or the third prong are provided for your safety. If the provided plug does not fit into your outlet, consult an electrician for replacement of the obsolete outlet.
- 10) Protect the power cord from being walked on or pinched particularly at plugs, convenience receptacles, and the point where they exit from the apparatus.
- 11) Only use attachments/accessories specified by the manufacturer.

- 12) Use only with the cart, stand, tripod, bracket, or table specified by the manufacturer, or sold with the apparatus. When a cart is used, use caution when moving the cart/apparatus combination to avoid injury from tip-over.



- 13) Unplug this apparatus during lightning storms or when unused for long periods of time.
- 14) Refer all servicing to qualified service personnel. Servicing is required when the apparatus has been damaged in any way, such as power-supply cord or plug is damaged, liquid has been spilled or objects have fallen into the apparatus, the apparatus has been exposed to rain or moisture, does not operate normally, or has been dropped.

The following FCC statement applies only to the version of this model manufactured for sale in the U.S.A. Other versions may not comply with FCC technical regulations.

NOTE:

This equipment has been tested and found to comply with the limits for a Class B digital device, pursuant to Part 15 of the FCC Rules. These limits are designed to provide reasonable protection against harmful interference in a residential installation.

This equipment generates, uses and can radiate radio frequency energy and, if not installed and used in accordance with the instructions, may cause harmful interference to radio communications. However, there is no guarantee that interference will not occur in a particular installation. If this equipment does cause harmful interference to radio or television reception, which can be determined by turning the equipment off and on, the user is encouraged to try to correct the interference by one or more of the following measures:

- Reorient or relocate the receiving antenna.
- Increase the separation between the equipment and receiver.
- Connect the equipment into an outlet on a circuit different from that to which the receiver is connected.
- Consult the dealer or an experienced radio/TV technician for help.

CAUTION

You are cautioned that any changes or modifications not expressly approved in this manual could void your authority to operate this equipment.

To reduce the risk of electric shock, the speaker cord should be connected to the apparatus and the speakers in accordance with the following instructions.

- 1) Disconnect the AC power cord from the MAINS.
- 2) Strip 10 to 15 mm of the wire insulation of the speaker cord.
- 3) Connect the speaker cord to the apparatus and the speakers carefully so as not to touch the core of speaker cord by hand. Also disconnect the AC power cord from the MAINS before disconnecting the speaker cord from the apparatus and the speakers.

About This Manual

- The instructions in this manual are for model STR-DH700. Check your model number by looking at the lower right corner of the front panel. In this manual, models of area code U is used for illustration purposes unless stated otherwise. Any difference in operation is clearly indicated in the text, for example, “Models of area code CA only”.
- The instructions in this manual describe the controls on the supplied remote. You can also use the controls on the receiver if they have the same or similar names as those on the remote.

About area codes

The area code of the receiver you purchased is shown on the lower right portion of the rear panel (see the illustration below).

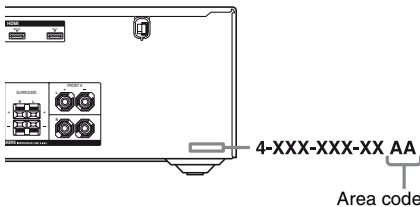

Any differences in operation, according to the area code, are clearly indicated in the text, for example, “Models of area code AA only”.

On Copyrights

This receiver incorporates Dolby® Digital and Pro Logic Surround and the DTS® Digital Surround System.

- * Manufactured under license from Dolby Laboratories. Dolby, Pro Logic, and the double-D symbol are trademarks of Dolby Laboratories.
- ** Manufactured under license under U.S. Patent #'s: 5,451,942; 5,956,674; 5,974,380; 5,978,762; 6,226,616; 6,487,535; 7,003,467; 7,212,872 & other U.S. and worldwide patents issued & pending. DTS, DTS Digital Surround, ES, and Neo:6 are registered trademarks and the DTS logos, Symbol and DTS 96/24 are trademarks of DTS, Inc. © 1996-2008 DTS, Inc. All Rights Reserved.

This receiver incorporates High-Definition Multimedia Interface (HDMI™) technology. HDMI, the HDMI logo and High-Definition Multimedia Interface are trademarks or registered trademarks of HDMI Licensing LLC.

SIRIUS, XM and all related marks and logos are trademarks of Sirius XM Radio Inc. and its subsidiaries. All rights reserved.

“x.v.Color (x.v.Colour)” and “x.v.Color (x.v.Colour)” logo are trademarks of Sony Corporation.

“BRAVIA” is a trademark of Sony Corporation.

“S-AIR” and its logo are trademarks of Sony Corporation.

Table of Contents

Description and location of parts 7

Getting Started

1: Installing the speakers 17
2: Connecting the speakers 18
3: Connecting the TV 20
4a: Connecting the audio components 21
4b: Connecting the video components 22
5: Connecting the antennas (aerials) 28
6: Preparing the receiver and the remote..... 29
7: Selecting the speaker system 30
8: Calibrating the appropriate settings
automatically
(AUTO CALIBRATION) 31
9: Adjusting the speaker levels and
balance (TEST TONE)..... 35

Playback

Selecting a component 36
Listening/Watching a component..... 38

Amplifier Operations

Navigating through menus 40
Adjusting the level (LEVEL menu) 45
Adjusting the equalizer (EQ menu) 46
Settings for the surround sound
(SUR menu) 46
Settings for the tuner (TUNER menu) 48
Settings for the audio (AUDIO menu) 49
Settings for the HDMI (HDMI menu) 50
Settings for the system (SYSTEM menu)... 51
Calibrating the appropriate settings
automatically (A. CAL menu) 55
Settings for the S-AIR (S. AIR menu) 56

Enjoying Surround Sound

Enjoying Dolby Digital and DTS Surround
sound (AUTO FORMAT DIRECT) 56
Selecting a pre-programmed sound field..... 58
Using only the front speakers
(2CH STEREO)..... 60
Listening to the sound without any
adjustment (ANALOG DIRECT)..... 61
Resetting sound fields to the initial
settings..... 61

Tuner Operations

Listening to FM/AM radio 62
Presetting FM/AM radio stations 64
Listening to Satellite Radio 66
Connecting the SIRIUS Satellite Radio 67
Preparing to listen to the SIRIUS
Satellite Radio 67
Selecting a channel of the SIRIUS
Satellite Radio 69
Presetting SIRIUS Satellite Radio
channels 70
Restricting access to specific channels
(Parental Lock) (SIRIUS only)..... 72

“BRAVIA” Sync Features

What is “BRAVIA” Sync?..... 75
Preparing for the “BRAVIA” Sync..... 76
Watching a DVD (One-Touch Play)..... 77
Enjoying the TV sound from the speakers
connected to the receiver
(System Audio Control) 78
Turning off the receiver with the TV
(System Power Off)..... 79

S-AIR Operations

About S-AIR products.....	80
Setting up an S-AIR product	81
Enjoying the system's sound in another room.....	85
Changing the channel for better sound transmission.....	86
Enjoying the S-AIR receiver while the S-AIR main unit is in standby mode	87

Other Operations

Switching between digital and analog audio (INPUT MODE)	88
Listening to digital sound from other inputs (DIGITAL ASSIGN)	89
Enjoying the DIGITAL MEDIA PORT (DMPort)	90
Changing the display	92
Using the Sleep Timer	93
Recording using the receiver	93
Using a bi-amplifier connection	94

Using the Remote

Changing button assignments.....	96
----------------------------------	----

Additional Information

Glossary	97
Precautions	99
Troubleshooting.....	101
Specifications.....	106
Index	Back cover

Description and location of parts

Front panel

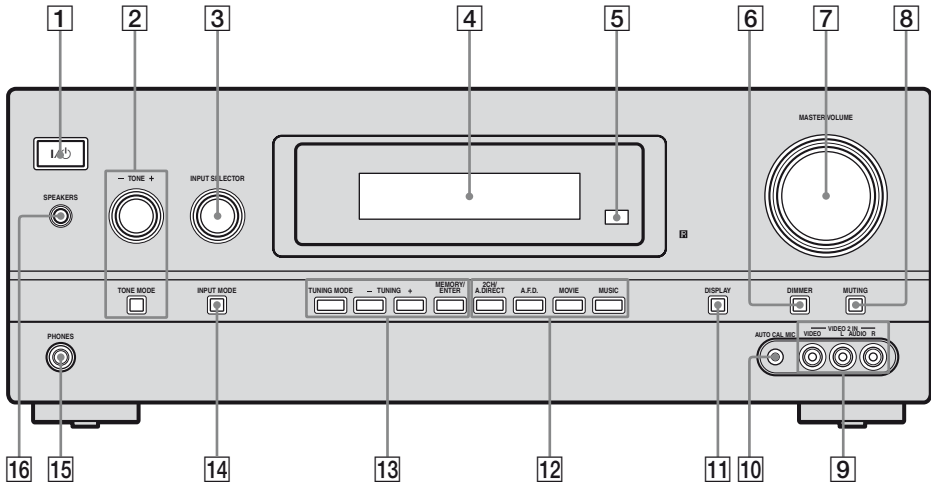

Name	Function
1 I/O	Press to turn the receiver on or off (page 29, 38, 39, 61, 63).
2 TONE +/- TONE MODE	Adjust the bass and treble for the front channels. Press TONE MODE repeatedly to select BASS or TREBLE, then turn TONE +/- to adjust the level (page 41).
3 INPUT SELECTOR	Turn to select the input source to play back (page 36, 37, 38, 39, 61, 62, 64, 65, 68, 88, 92, 93, 94).
4 Display	The current status of the selected component or a list of selectable items appears here (page 9).
5 Remote sensor	Receives signals from remote commander.

Name	Function
6 DIMMER	Press repeatedly to adjust the brightness of the display.
7 MASTER VOLUME	Turn to adjust the volume level of all speakers at the same time (page 35, 36, 38, 39).
8 MUTING	Press to turn off the sound temporarily. Press MUTING again to restore the sound (page 36).
9 VIDEO 2 IN jacks	Connects to a portable audio/video component such as a camcorder or video game (page 27, 36).
10 AUTO CAL MIC jack	Connects to the supplied optimizer microphone for the Auto Calibration function (page 31).

continued

Name	Function
11 DISPLAY	Press to select information displayed on the display (page 92).
12 2CH/ A.DIRECT	Press to select a sound field (page 56, 58).
A.F.D.	
MOVIE	
MUSIC	
13 TUNING MODE	Press to operate a tuner (FM/AM) and satellite radio (SIRIUS) (page 62, 68).
TUNING +/-	
MEMORY/ ENTER	
14 INPUT MODE	Press to select the input mode when the same components are connected to both digital and analog jacks (page 88).
15 PHONES jack	Connects to headphones (page 101).
16 SPEAKERS	Press to select the front speaker system (page 30).

About the indicators on the display

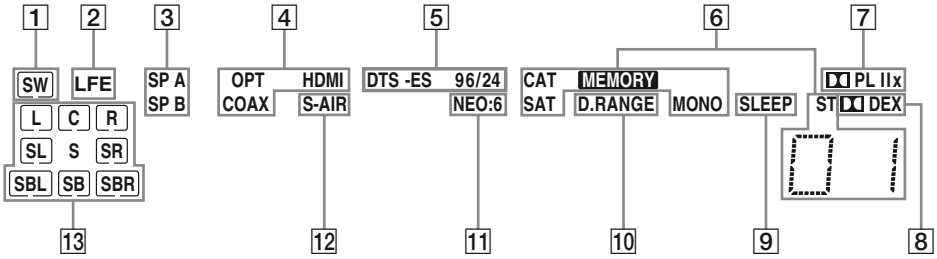

Name	Function
1 SW	Lights up when subwoofer selection is set to “YES” (page 51) and the audio signal is output from the SUBWOOFER jack.
2 LFE	Lights up when the disc being played back contains an LFE (Low Frequency Effect) channel and the LFE channel signal is actually being reproduced.
3 SP A/SP B	Lights up according to the speaker system used. However, these indicators do not light up if the speaker output is turned off or if headphones are connected.

Name	Function
4 Input indicators	Light up to indicate the current input.
OPT	Lights up when INPUT MODE is set to “AUTO” and the source signal is a digital signal being input through the OPTICAL jack or when INPUT MODE is set to “OPT”. However, “NO INPUT” appears on the display when INPUT MODE is set to “OPT” and no digital signal is input through the OPTICAL jack (page 88).
COAX	Lights up when INPUT MODE is set to “AUTO” and the source signal is a digital signal being input through the COAXIAL jack or when INPUT MODE is set to “COAX”. However, “NO INPUT” appears on the display when INPUT MODE is set to “COAX” and no digital signal is input through the COAXIAL jack (page 88).
HDMI	Lights up when the receiver recognizes a component connected via an HDMI IN jacks (page 23).

continued

Name	Function
5 DTS(-ES) indicators	Light up when DTS or DTS-ES signals are input.
DTS	Lights up when the receiver is decoding DTS signals.
DTS-ES	Lights up when the receiver is decoding DTS-ES signals.
DTS 96/24	Lights up when the receiver is decoding DTS 96/24 (96 kHz/24 bit) signals.
	Note When playing a DTS format disc, be sure that you have made digital connections and that INPUT MODE is not set to "ANALOG" (page 88).
6 Tuning indicators	Lights up when the receiver tunes in radio stations, or satellite radio stations.
CAT	Lights up when the category mode is set to "ONE CAT" during the satellite radio operation.
SAT	Lights up when the SiriusConnect Home tuner is connected and "SIRIUS" is selected.
MEMORY	Lights up when a memory function, such as Preset Memory (page 65), etc., is activated.
MONO	Monaural broadcast
ST	Stereo broadcast
	A preset station number appears when the preset radio station is selected.
	Note The preset station number will change according to the preset station you select. For details on presetting radio stations, see page 64.

Name	Function
7 Dolby Pro Logic indicators	Lights up one of the respective indicators when the receiver applies Dolby Pro Logic processing to 2 channel signals in order to output the center and surround channel signals.
<input checked="" type="checkbox"/> PL	Dolby Pro Logic
<input checked="" type="checkbox"/> PLII	Dolby Pro Logic II
<input checked="" type="checkbox"/> PLIIx	Dolby Pro Logic IIx
	Notes
	<ul style="list-style-type: none"> • These indicators do not light up if both the center and surround speakers are set to "NO" (page 43) and you select a sound field using the A.F.D. button. • Dolby Pro Logic IIx decoding does not function for DTS format signals or for signals with a sampling frequency of more than 48 kHz.
8 Dolby Digital Surround indicators	Lights up one of the respective indicators when the receiver is decoding the corresponding Dolby Digital format signals.
<input checked="" type="checkbox"/> D	Dolby Digital
<input checked="" type="checkbox"/> DEX	Dolby Digital Surround EX
	Note When playing a Dolby Digital format disc, be sure that you have made digital connections and that INPUT MODE is not set to "ANALOG" (page 88).
9 SLEEP	Lights up when the sleep timer is activated.
10 D.RANGE	Lights up when dynamic range compression is activated (page 41).
11 NEO:6	Lights up when DTS Neo:6 Cinema/Music decoder is activated (page 57).
12 S-AIR	Lights up when the S-AIR transmitter (not supplied) is connected.

Name	Function
13 Playback channel indicators	The letters (L, C, R, etc.) indicate the channels being played back. The boxes around the letters vary to show how the receiver downmixes the source sound (based on the speaker settings).
L	Front Left
R	Front Right
C	Center (monaural)
SL	Surround Left
SR	Surround Right
S	Surround (monaural or the surround components obtained by Pro Logic processing)
SBL	Surround Back Left
SBR	Surround Back Right
SB	Surround Back (the surround back components obtained by 6.1 channel decoding)
	Example: Recording format (Front/Surround): 3/2.1 Output channel: When surround speakers are set to "NO" (page 43) Sound Field: A.F.D. AUTO
	<div style="text-align: center;"> <div style="border: 1px solid black; display: inline-block; padding: 2px 5px;">SW</div> <div style="display: flex; justify-content: center; gap: 10px;"> <div style="border: 1px solid black; display: inline-block; padding: 2px 5px;">L</div> <div style="border: 1px solid black; display: inline-block; padding: 2px 5px;">C</div> <div style="border: 1px solid black; display: inline-block; padding: 2px 5px;">R</div> </div> <div style="display: flex; justify-content: center; gap: 20px;"> <div style="border: 1px solid black; display: inline-block; padding: 2px 5px;">SL</div> <div style="border: 1px solid black; display: inline-block; padding: 2px 5px;">SR</div> </div> </div>

Rear panel

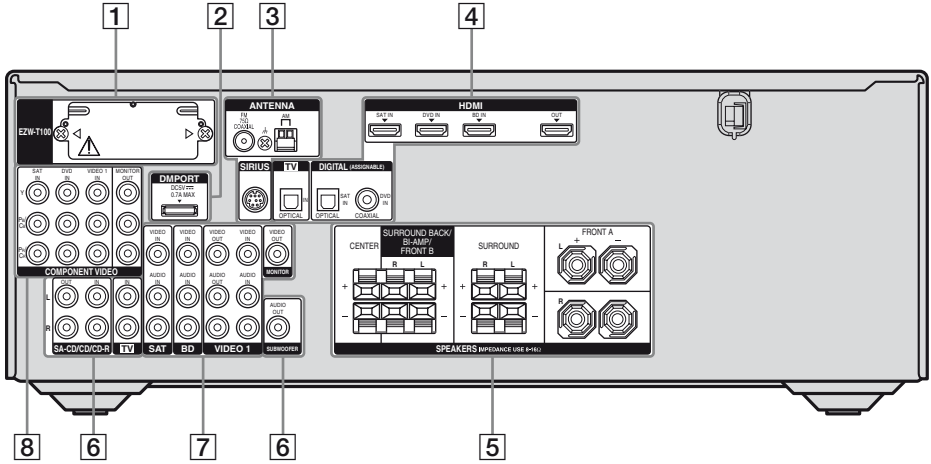

1 S-AIR (EZW-T100)

With slot cover



slot

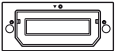

⚠ CAUTION
Please do not remove the slot cover until you want to install the wireless transmitter.

Connects to a wireless transmitter (not supplied) (page 81).

2 DMPORT



DMPORT
jack

Connects to a DIGITAL MEDIA PORT adapter (page 91).

3 ANTENNA section



FM
ANTENNA
jack

Connects to the supplied FM wire antenna (aerial) (page 28).



AM
ANTENNA
terminals

Connects to the supplied AM loop antenna (aerial) (page 28).



SIRIUS jack

Connects to a SiriusConnect Home tuner (not supplied) (page 67).

4 DIGITAL INPUT/OUTPUT section



OPTICAL
IN jacks

Connects to a DVD player, etc. The COAXIAL jack provides a better sound quality (page 25, 26).



COAXIAL IN
jack



HDMI IN/
OUT* jacks

Connects to a DVD player, satellite tuner, or a Blu-ray disc player. The image is output to a TV or a projector while the sound can be output from a TV or/and speakers connected to this receiver (page 23).

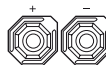

5 SPEAKERS section





Connects to the speakers (page 18).





6 AUDIO INPUT/OUTPUT section

	White (L) AUDIO IN/OUT jacks	Connects to a Super Audio CD player, CD recorder, etc. (page 21).
	Red (R)	
	Black AUDIO OUT jack	Connects to a subwoofer (page 18).

7 VIDEO/AUDIO INPUT/OUTPUT section

	White (L) AUDIO IN/OUT jacks	Connects to a VCR, Blu-ray disc player, etc. (page 20–27).
	Red (R)	
	Yellow VIDEO IN/OUT* jacks	

8 COMPONENT VIDEO INPUT/OUTPUT section

	Green (Y) Y, PB/CB, PR/CR IN/OUT* jacks	Connects to a DVD player, TV, satellite tuner, etc. You can enjoy high quality image (page 20–27).
	Blue (PB/CB)	
	Red (PR/CR)	

* You can watch the selected input image when you connect the MONITOR OUT or HDMI OUT jack to a TV or projector (page 20).

Remote commander

You can use the supplied RM-AAU021 Remote Commander to operate the receiver and to control the Sony audio/video components that the remote is assigned to operate (page 96).

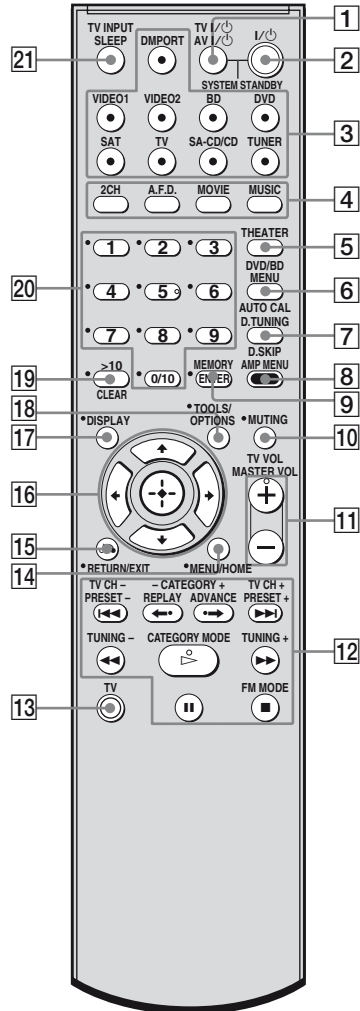

continued

Name	Function
1 TV I/⏻ (on/standby)	Press TV I/⏻ and TV (13) at the same time to turn the TV on or off.
AV I/⏻ (on/standby)	Press to turn on or off the Sony audio/video components that the remote is assigned to operate (page 96). If you press I/⏻ (2) at the same time, it will turn off the receiver and other Sony components (SYSTEM STANDBY). Note The function of the AV I/⏻ switch changes automatically each time you press the input buttons (3).
2 I/⏻ (on/standby)	Press to turn the receiver on or off. To turn off all Sony components, press I/⏻ and AV I/⏻ (1) at the same time (SYSTEM STANDBY).
3 Input buttons	Press one of the buttons to select the component you want to use. When you press any of the input buttons, the receiver turns on. The buttons are factory assigned to control Sony components. You can change the button assignments following the steps in "Changing button assignments" on page 96.
4 2CH A.F.D. MOVIE MUSIC	Press to select a sound field.
5 THEATER	Press to enjoy optimal image suited for movies and to output the sound from the speakers connected to this receiver automatically. Note This button will only function if your TV is compatible with Theater Mode. Refer to the operating instructions supplied with the TV for details.

Name	Function
6 DVD/BD MENU	Press to display the menu of the DVD or Blu-ray disc on the TV screen. Then, use \blacktriangle , \blacktriangledown , \blacktriangleleft , \blacktriangleright and \oplus (16) to perform menu operations.
AUTO CAL	Press to activate the Auto Calibration function.
7 D.TUNING	Press to enter direct tuning mode.
D.SKIP	Press to skip a disc when using a multi-disc changer.
8 AMP MENU	Press to display the menu of the receiver. Then, use \blacktriangle , \blacktriangledown , \blacktriangleleft , \blacktriangleright and \oplus (16) to perform menu operations.
9 ENTER	Press to enter the value after selecting a channel, disc or track using the numeric buttons of the TV, VCR or satellite tuner.
MEMORY	Press to store a station.
10 MUTING	Press to turn off the sound temporarily. Press MUTING again to restore the sound. Press MUTING and TV (13) at the same time to activate the TV's muting function.
11 TV VOL +^a/-^b	Press TV VOL + ^a /- and TV (13) at the same time to adjust the volume level of the TV.
MASTER VOL +^a/-^b	Press to adjust the volume level of all speakers at the same time.
12 $\blacktriangleleft\blacktriangleright$^b	Press to skip a track of the CD player, DVD player or Blu-ray disc player.
REPLAY \blacktriangleleft/ ADVANCE \blacktriangleright	Press to replay the previous scene or fast forward the current scene of the VCR, DVD player or Blu-ray disc player.
$\blacktriangleleft\blacktriangleright$^b	Press to – search tracks in the forward/reverse direction of the DVD player. – start fast forward/rewind of the VCR, CD player or Blu-ray disc player.

Name	Function
a)b)	Press to start playback of the VCR, CD player, DVD player, or Blu-ray disc player.
b)	Press to pause playback or recording of the VCR, CD player, DVD player or Blu-ray disc player. (Also starts recording with components in recording standby.)
b)	Press to stop playback of the VCR, CD player, DVD player or Blu-ray disc player.
TV CH +/-	Press TV CH +/- and TV () at the same time to select preset TV channels.
CATEGORY +/-	Press to select a category for SIRIUS Satellite Radio (page 69).
PRESET +/-	Press to select – preset stations. – preset channels of the VCR or satellite tuner.
TUNING +/-	Press to scan a station.
CATEGORY MODE	Press to select the category mode for satellite tuner (page 69).
FM MODE	Press to select the FM monaural or stereo reception.
TV	Press TV and the button with orange printing at the same time to enable TV operation.
MENU/HOME	Press to display the menu of the VCR, DVD player, satellite tuner or Blu-ray disc player on the TV screen. Press MENU/HOME and TV () at the same time to display the TV's menu. Then, use , , , and () to perform menu operations.

Name	Function
RETURN/EXIT	Press to – return to the previous menu. – exit the menu while the menu or on-screen guide of the VCR, DVD player, satellite tuner or Blu-ray disc player is displayed on the TV screen. Press RETURN/EXIT () and TV () at the same time to return to the previous menu or exit the TV's menu while the menu is displayed on the TV screen.
MENU , , ,	After pressing DVD/BD MENU (), AMP MENU (), or MENU/HOME (), press , , , or to select the settings. Then, press to enter the selection if you have pressed DVD/BD MENU or MENU/HOME previously. Press also to enter the selection of the receiver, VCR, satellite tuner, CD player, DVD player or Blu-ray disc player.
DISPLAY	Press to select information displayed on the TV screen of the VCR, satellite tuner, CD player, DVD player or Blu-ray disc player. Press DISPLAY and TV () at the same time to display TV's information on the TV screen.
TOOLS/OPTIONS	Press to display and select the options of the DVD player or Blu-ray disc player. Press TOOLS/OPTIONS and TV () at the same time to display the options applicable to the Sony TV.

continued

Name	Function
19 ●	Press to input the decimal point for channel numbers of the Digital CATV terminal. Press ● and TV (13) at the same time to input the decimal point for the channel numbers of the TV.
>10	Press to select track numbers over 10 of the CD player.
CLEAR	Press to clear a mistake when you press the incorrect numeric button.
20 Numeric buttons (number 5^a)	Press to <ul style="list-style-type: none"> – preset/tune to preset stations. – select track numbers of the CD player, DVD player or Blu-ray disc player. Press 0/10 to select track number 10. – select channel numbers of the VCR or satellite tuner. Press the numeric buttons and TV (13) at the same time to select the TV channels.
21 TV INPUT	Press TV INPUT and TV (13) at the same time to select the input signal (TV input or video input).
SLEEP	Press to activate the Sleep Timer function and the duration which the receiver turns off automatically.

Notes

- Some functions explained in this section may not work depending on the model.
- The above explanation is intended to serve as an example only. Therefore, depending on the component, the above operation may not be possible or may operate differently than described.

^{a)}The number 5, MASTER VOL +, TV VOL +, and ▷ buttons have tactile dots. Use the tactile dots as references when operating the receiver.

^{b)}This button is also available for DIGITAL MEDIA PORT adapter operation. For details on the function of the button, refer to the operating instructions supplied with the DIGITAL MEDIA PORT adapter.

1: Installing the speakers

This receiver allows you to use a 7.1 channel system (7 speakers and one subwoofer).

Enjoying a 5.1/7.1 channel system

To fully enjoy theater-like multi channel surround sound requires five speakers (two front speakers, a center speaker, and two surround speakers) and a subwoofer (5.1 channel).

Example of a 5.1 channel speaker system configuration

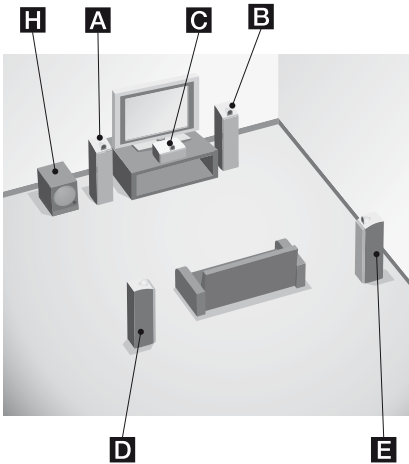

- A** Front speaker (left)
- B** Front speaker (right)
- C** Center speaker
- D** Surround speaker (left)
- E** Surround speaker (right)
- H** Subwoofer

You can enjoy high fidelity reproduction of DVD software recorded sound in the Surround EX format if you connect one additional surround back speaker (6.1 channel system) or two surround back speakers (7.1 channel system). See “Using the surround back decoding mode (SB DEC)” (page 47).

Example of a 7.1 channel speaker system configuration

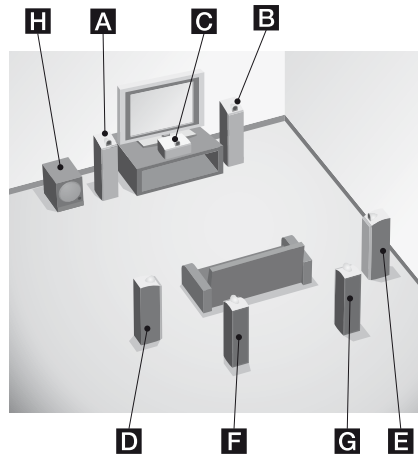

- A** Front speaker (left)
- B** Front speaker (right)
- C** Center speaker
- D** Surround speaker (left)
- E** Surround speaker (right)
- F** Surround back speaker (left)
- G** Surround back speaker (right)
- H** Subwoofer

Tips

- When you connect a 6.1 channel speaker system, place the surround back speaker behind the listening position.
- Since the subwoofer does not emit highly directional signals, you can place it wherever you want.

2: Connecting the speakers

Before connecting the cords, be sure to disconnect the AC power cord (mains lead).

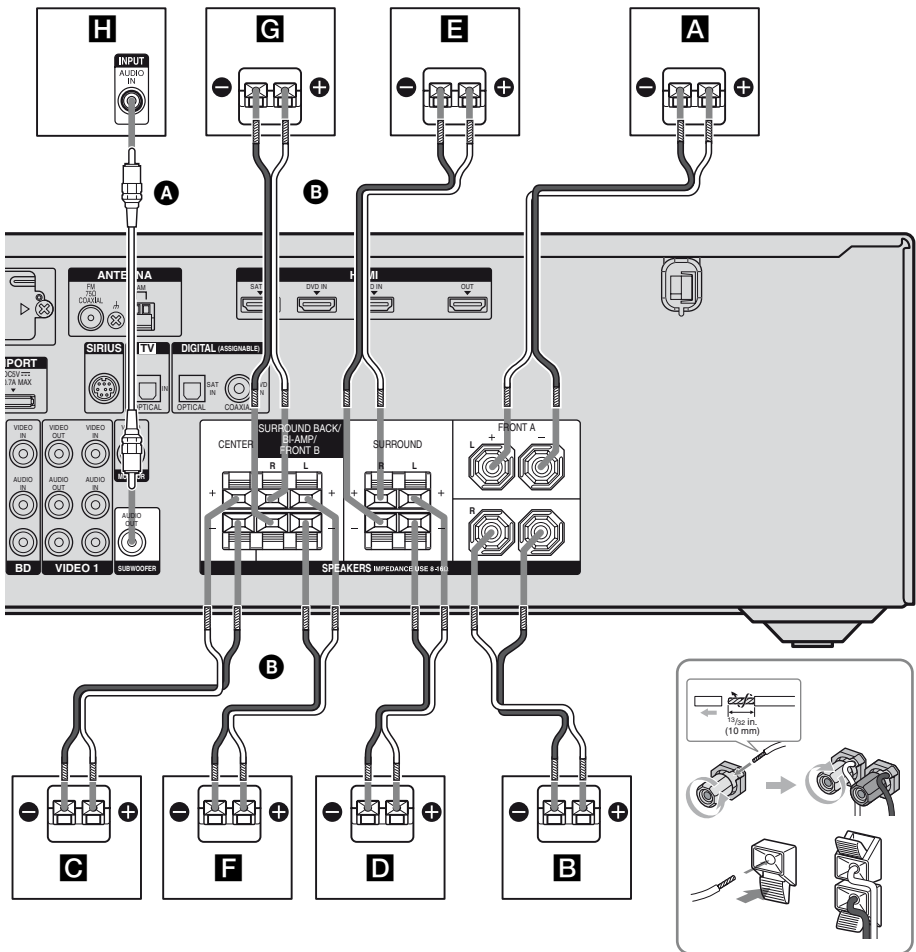

- A** Monaural audio cord (not supplied)
- B** Speaker cords (not supplied)

- A** Front speaker A (left)
- B** Front speaker A (right)
- C** Center speaker
- D** Surround speaker (left)

- E** Surround speaker (right)
- F** Surround back speaker (left)^{a)b)c)}
- G** Surround back speaker (right)^{a)b)c)}
- H** Subwoofer^{d)}

- a) If you connect only one surround back speaker, connect it to the SPEAKERS SURROUND BACK/BI-AMP/FRONT B L terminals.
- b) If you are not using surround back speaker, and you have an additional front speaker system, connect the additional front speaker system to the SPEAKERS SURROUND BACK/BI-AMP/FRONT B terminals. Set “SB ASGN” to “SPK B” in the System settings menu (page 43). You can select the front speaker system you want to use with SPEAKERS on the front panel (page 30).
- c) If you are not using surround back speakers, you can connect the front speakers to the SPEAKERS SURROUND BACK/BI-AMP/FRONT B terminals using a bi-amplifier connection (page 94). Set “SB ASGN” to “BI-AMP” in the System settings menu (page 43).
- d) When you connect a subwoofer with an auto standby function, turn off the function when watching movies. If the auto standby function is set to on, it turns to standby mode automatically based on the level of the input signal to a subwoofer, then sound may not be output.

3: Connecting the TV

You can watch the selected input image when you connect the HDMI OUT or MONITOR OUT jack to a TV.

It is not necessary to connect all the cords. Connect audio and video cords according to the jacks of your components.

Before connecting the cords, be sure to disconnect the AC power cord (mains lead).

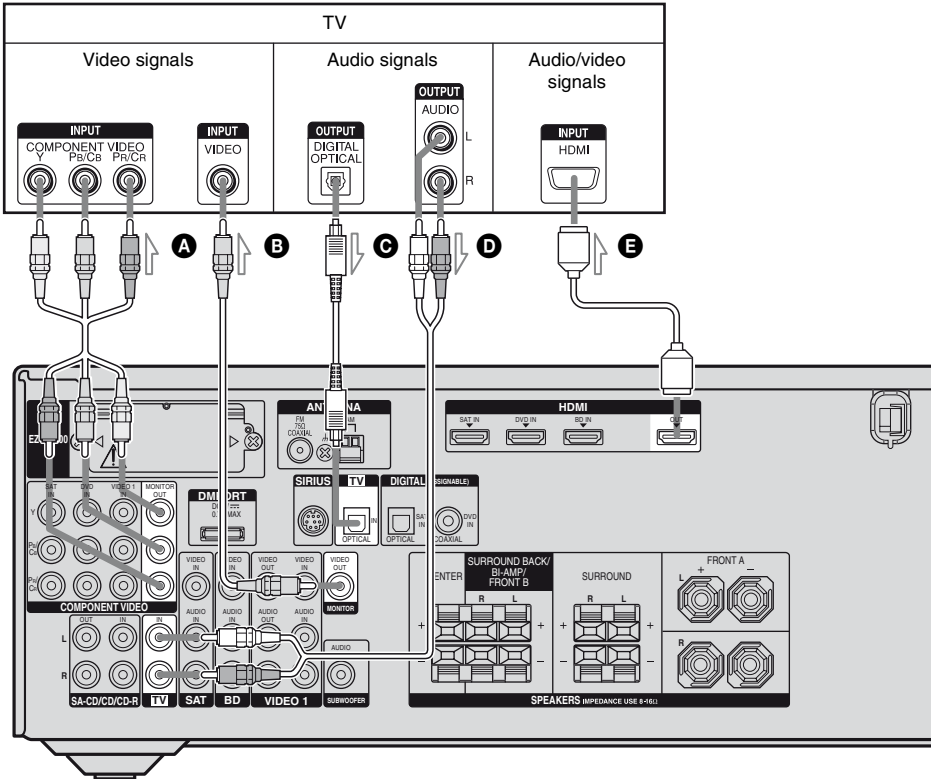

- A** Component video cord (not supplied)
- B** Video cord (not supplied)
- C** Optical digital cord (not supplied)
- D** Audio cord (not supplied)
- E** HDMI cable (not supplied)

We recommend that you use a Sony HDMI cable.

Notes

- Be sure to turn on the receiver when the video and audio signals of a playback component are being output to a TV via the receiver. Unless the power is turned on, neither video nor audio signals will be transmitted.
- When connecting optical digital cords, insert the plugs straight in until they click into place.
- Do not bend or tie optical digital cords.

Tips

- To output the sound of the TV from the speakers connected to the receiver, be sure to
 - connect the audio output jacks of the TV to the TV IN jacks of the receiver.
 - turn off the TV's volume or activate the TV's muting function.
- All the digital audio jacks are compatible with 32 kHz, 44.1 kHz, 48 kHz, and 96 kHz sampling frequencies.

4a: Connecting the audio components

Connecting a Super Audio CD/ CD player or CD recorder

The following illustration shows how to connect a Super Audio CD player, CD player or CD recorder.

Before connecting the cords, be sure to disconnect the AC power cord (mains lead). After connecting your audio component, proceed to “4b: Connecting the video components”(page 22).

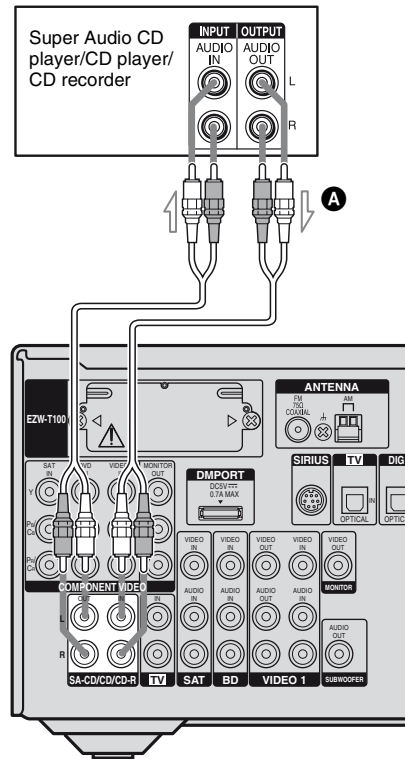

A Audio cord (not supplied)

4b: Connecting the video components

How to connect your components

This section describes how to connect your video components to this receiver. Before you begin, refer to “Component to be connected” below for the pages which describe how to connect each component.

Before connecting the cords, be sure to disconnect the AC power cord (mains lead). After connecting all your components, proceed to “5: Connecting the antennas (aerials)” (page 28).

Component to be connected

Component	Page
TV	20
With HDMI jack	23
DVD player/Blu-ray disc player	25
Satellite tuner/Set-top box	26
DVD recorder, VCR	27
Camcorder, video game, etc.	27

If you want to connect several digital components, but cannot find an unused input

See “Listening to digital sound from other inputs (DIGITAL ASSIGN)” (page 89).

Video input/output jacks to be connected

The image quality depends on the connecting jack. Refer to the illustration that follows. Select the connection according to the jacks on your components.

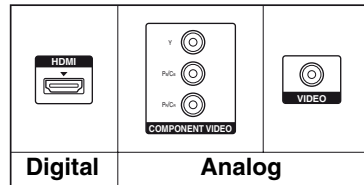

← High quality image

Note

Be sure to turn on the receiver when the video and audio signals of a playback component are being output to a TV via the receiver. Unless the power is turned on, neither video nor audio signals will be transmitted.

Connecting components with HDMI jacks

HDMI is the abbreviated name for High-Definition Multimedia Interface. It is an interface which transmits video and audio signals in digital format.

To enjoy TV multi channel surround sound broadcasting

You can listen to TV multi channel surround sound broadcasting from the speakers connected to the receiver. Connect the OPTICAL output jack of the TV to the OPTICAL IN jack of the receiver.

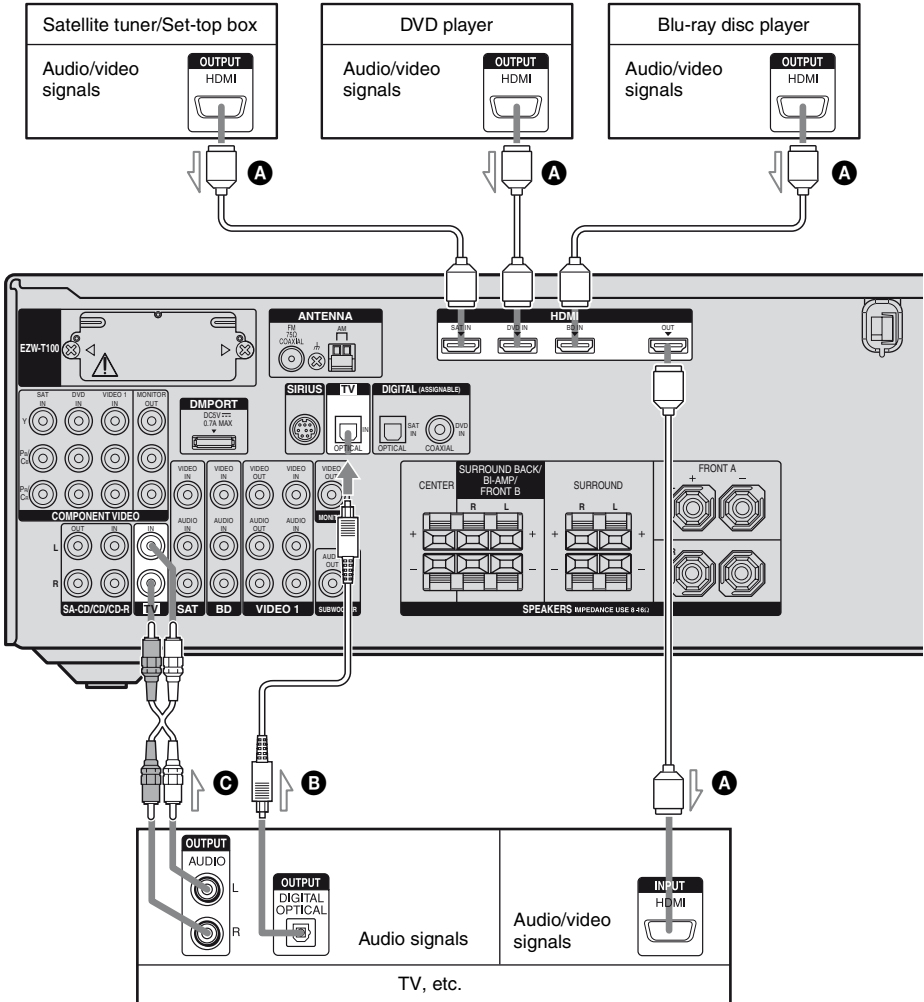

A HDMI cable (not supplied)

We recommend that you use a Sony HDMI cable.

B Optical digital cord (not supplied)*

C Audio cord (not supplied)*

* Connect at least one of the audio cords (**B** or **C**).

continued

HDMI features

- A digital audio signal transmitted by HDMI can be output from the speakers connected to this receiver. This signal supports Dolby Digital, DTS, and Linear PCM.
- The receiver supports xvYCC transmission.
- This receiver supports the Control for HDMI function. For details, see ““BRAVIA” Sync Features” (page 75).

Notes on HDMI connections

- An audio signal input to the HDMI IN jack is output from the speaker output jack and HDMI OUT jack. It is not output from any other audio jacks.
- Video signals input to the HDMI IN jack can only be output from the HDMI OUT jack. The video input signals cannot be output from the VIDEO OUT jacks or MONITOR OUT jacks.
- When you want to listen to the sound from the TV speaker, set “AUDIO FOR HDMI” to “TV+AMP” in the HDMI menu (page 42). If you cannot play back multi channel software, set to “AMP”. However, the sound will not output from the TV speaker.
- The multi/stereo area audio signals of a Super Audio CD are not output.
- Audio signals (sampling frequency, bit length, etc.) transmitted from an HDMI jack may be suppressed by the connected component. Check the setup of the connected component if an image is poor or the sound does not come out of a component connected via the HDMI cable.
- Sound may be interrupted when the sampling frequency, the number of channels or the audio format of the audio output signals from the playback component is switched.
- When the connected component is not compatible with copyright protection technology (HDCP), the image and/or the sound from the HDMI OUT jack may be distorted or may not be output. In this case, check the specification of the connected component.

- You can enjoy multi channel Linear PCM only with an HDMI connection.
- Set the image resolution of the playback component to 720p, 1080i or 1080p when you output 96 kHz multi-channel sound over an HDMI connection.
- You may need to make certain settings on the image resolution of the player before you can enjoy multi channel Linear PCM. Refer to the operating instructions of the player.
- Refer to the operating instructions of each component connected for details.
- We do not recommend using an HDMI-DVI conversion cable. When you connect an HDMI-DVI conversion cable to a DVI-D component, the sound and/or the image may not be output.

Connecting a DVD player/ Blu-ray disc player

The following illustration shows how to connect a DVD player or a Blu-ray disc player. It is not necessary to connect all the cords. Connect audio and video cords according to the jacks of your components.

Note

To input multi channel digital audio from the DVD player, set the digital audio output setting on the DVD player. Refer to the operating instructions supplied with the DVD player.

Tip

All the digital audio jacks are compatible with 32 kHz, 44.1 kHz, 48 kHz, and 96 kHz sampling frequencies.

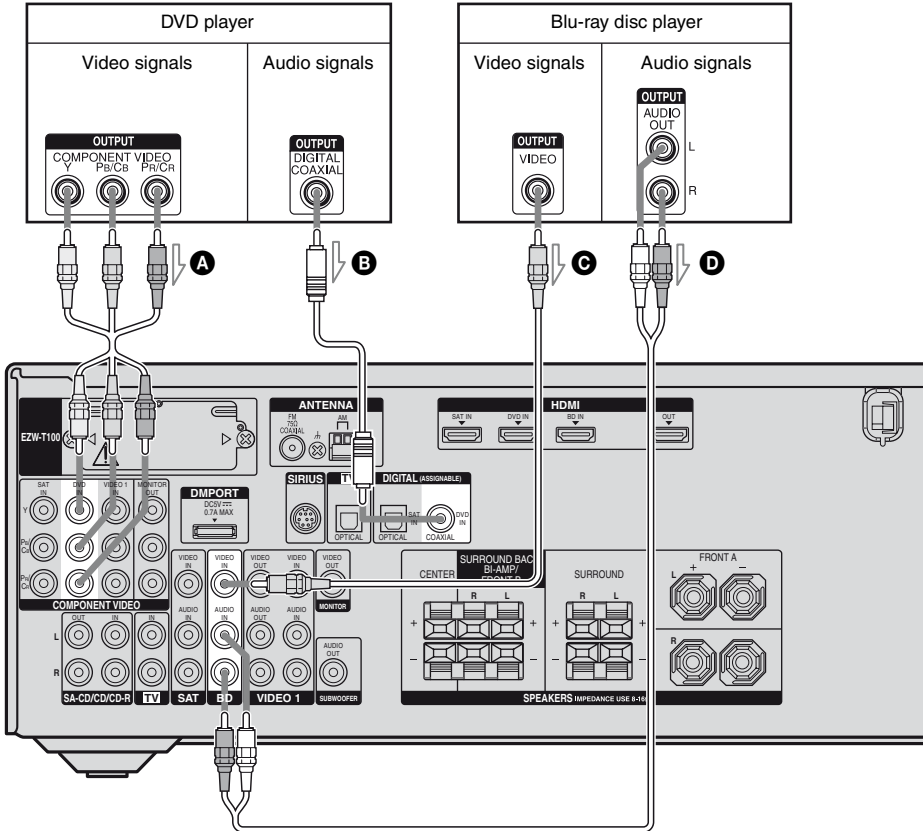

- A** Component video cord (not supplied)
- B** Coaxial digital cord (not supplied)
- C** Video cord (not supplied)
- D** Audio cord (not supplied)

Connecting components with analog video and audio jack

It is not necessary to connect all the cords. Connect audio and video cords according to the jacks of your components.

The following illustration shows how to connect a component which has analog jacks such as a DVD recorder, VCR, etc.

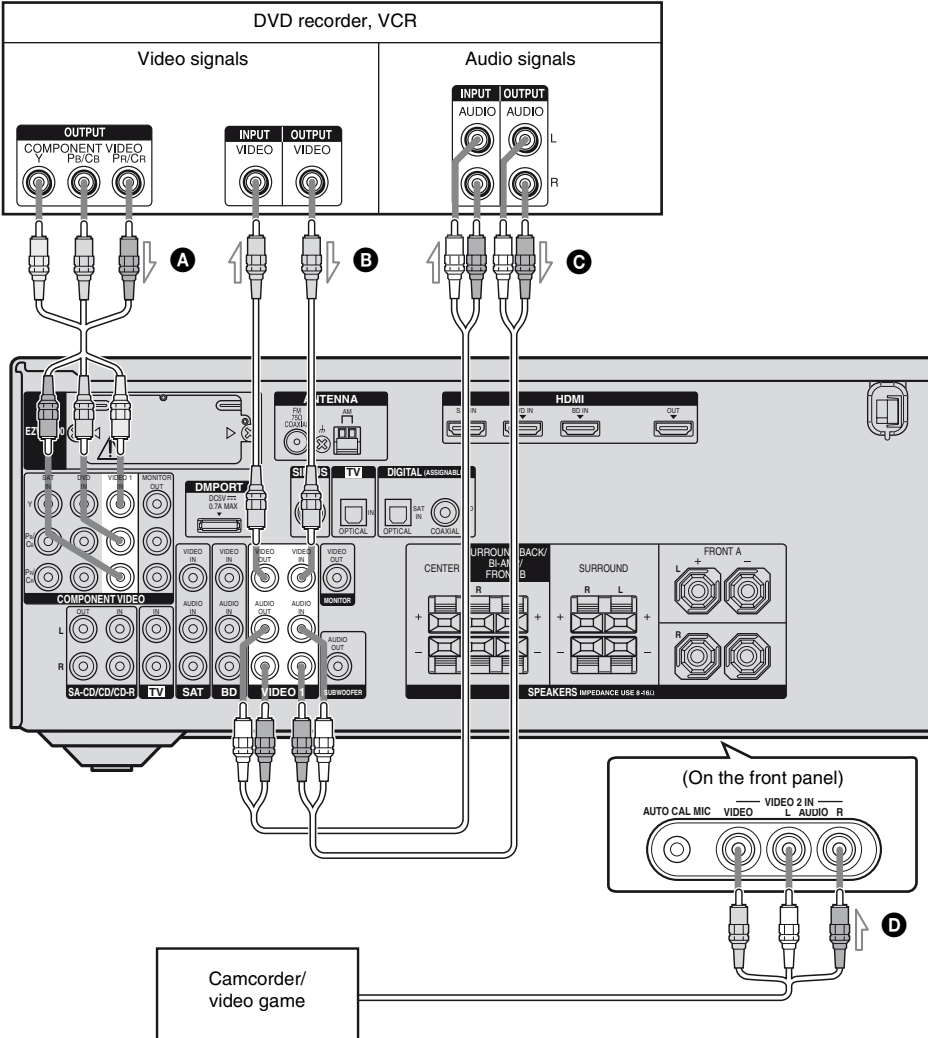

- A** Component video cord (not supplied)
- B** Video cord (not supplied)
- C** Audio cord (not supplied)
- D** Audio/video cord (not supplied)

Notes

- Be sure to change the factory setting of the VIDEO 1 input button on the remote so that you can use the button to control your DVD recorder. For details, see “Changing button assignments” (page 96).
- You can also rename the VIDEO 1 input so that it can be displayed on the receiver’s display. For details, see “Naming input” (page 37).

5: Connecting the antennas (aerials)

Connect the supplied AM loop antenna (aerial) and FM wire antenna (aerial). Before connecting the antennas (aerials), be sure to disconnect the AC power cord (mains lead).

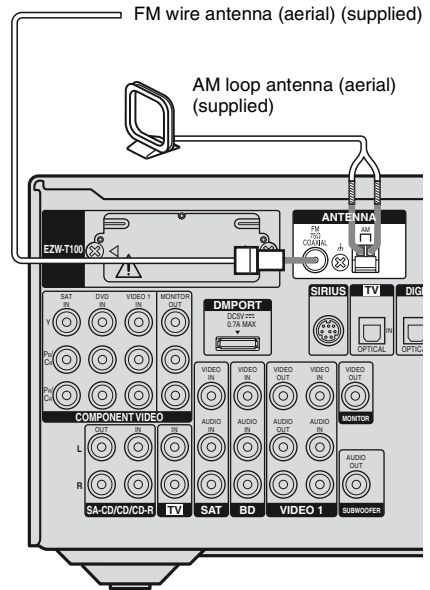

Notes

- To prevent noise pickup, keep the AM loop antenna (aerial) away from the receiver and other components.
- Be sure to fully extend the FM wire antenna (aerial).
- After connecting the FM wire antenna (aerial), keep it as horizontal as possible.

6: Preparing the receiver and the remote

Connecting the AC power cord (mains lead)

Connect the AC power cord (mains lead) to a wall outlet.

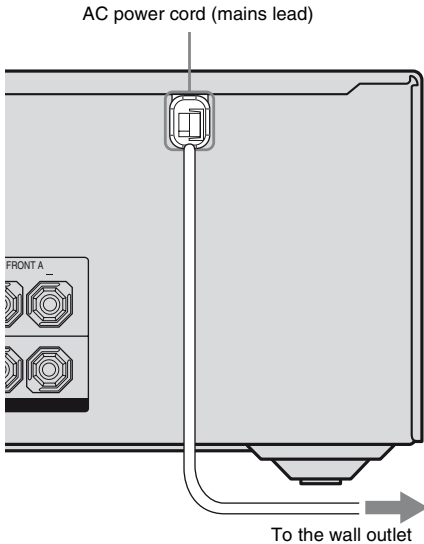

Performing initial setup operations

Before using the receiver for the first time, initialize the receiver by performing the following procedure. This procedure can also be used to return settings you have made to their factory defaults.

Be sure to use the buttons on the receiver for this operation.

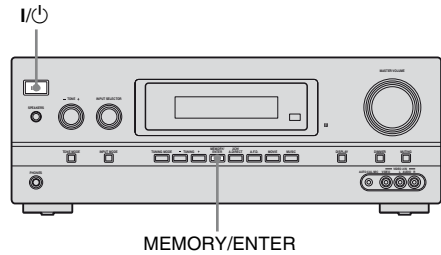

- 1 Press I/⏻ to turn off the receiver.**
- 2 Hold down I/⏻ for 5 seconds.**
“PUSH” and “ENTER” appears on the display alternately.
- 3 Press MEMORY/ENTER.**
After “CLEARING” appears on the display for a while, “CLEARED” appears.
All the settings you have changed or adjusted are reset to the initial settings.

Inserting batteries into the remote

Insert two R6 (size-AA) batteries in the RM-AAU021 Remote Commander. Observe the correct polarity when installing batteries.

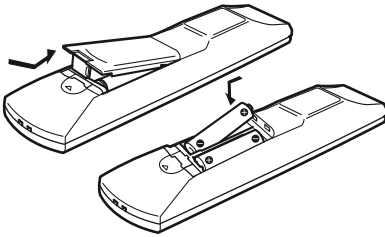

Notes

- Do not leave the remote in an extremely hot or humid place.
- Do not use a new battery with old ones.
- Do not mix manganese batteries and other kinds of batteries.
- Do not expose the remote sensor to direct sunlight or lighting apparatuses. Doing so may cause a malfunction.
- If you do not intend to use the remote for an extended period of time, remove the batteries to avoid possible damage from battery leakage and corrosion.
- When you replace the batteries, the remote buttons may be reset to their factory settings. If this happens, reassign the buttons again (page 96).
- When the remote no longer operates the receiver, replace all the batteries with new ones.

7: Selecting the speaker system

You can select the front speakers you want to drive.

Be sure to use the buttons on the receiver for this operation.

SPEAKERS

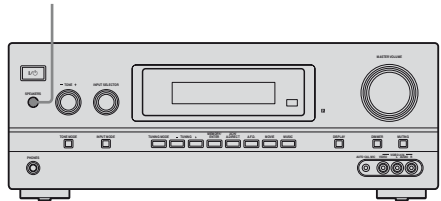

Press SPEAKERS repeatedly to select the front speaker system you want to drive.

To select	Light up
The front speakers connected to the SPEAKERS FRONT A terminals	SP A
The front speakers connected to the SPEAKERS SURROUND BACK/BI-AMP/FRONT B terminals	SP B*
The front speakers connected to both the SPEAKERS FRONT A terminals and SPEAKERS SURROUND BACK/BI-AMP/FRONT B terminals (parallel connection)	SP A and SP B*

* To select "SP B", set "SB ASGN" to "SPK B" in the System settings menu (page 43).

To turn off the speaker output, press SPEAKERS repeatedly until the "SP A" and "SP B" indicators on the display light off.

Note

You cannot switch the front speaker system by pressing SPEAKERS when the headphones are connected to the receiver.

8: Calibrating the appropriate settings automatically

(AUTO CALIBRATION)

The DCAC (Digital Cinema Auto Calibration) function allows you to perform automatic calibration such as:

- Checking the connection between each speaker and the receiver.
- Adjusting the speaker level.
- Measuring the distance of each speaker from your listening position.

The DCAC is designed to obtain proper sound balance in your room. However, you can adjust the speaker levels and balance manually according to your preference. For details, see “9: Adjusting the speaker levels and balance (TEST TONE)” (page 35).

Before you perform Auto Calibration

Before you perform Auto Calibration, install and connect the speakers (page 17, 18).

- The AUTO CAL MIC jack is used for the supplied optimizer microphone only. Do not connect other microphones to this jack. Doing so may damage the receiver and the microphone.
- During calibration, the sound that comes out of the speakers is very loud. The volume of the sound cannot be adjusted. Pay attention to the presence of children or to the effect on your neighborhood.
- Perform Auto Calibration in a quiet environment to avoid the effect of noise and to get a more accurate measurement.
- If there are any obstacles in the path between the optimizer microphone and the speakers, the calibration cannot be performed correctly. Remove any obstacles from the measurement area to avoid measurement error.

- When you use a bi-amplifier connection, set “SB ASGN” to “BI-AMP” in the System settings menu before you perform auto calibration (page 43).

Notes

- The Auto Calibration function does not work when headphones are connected.
- If the muting function has been activated before you perform Auto Calibration, the muting function will be set to off automatically.

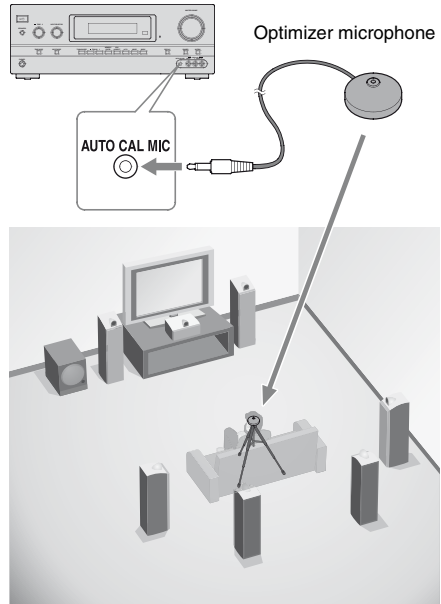

1 Connect the supplied optimizer microphone to the AUTO CAL MIC jack.

2 Set up the optimizer microphone.

Place the optimizer microphone at your listening position. You can also use a stool or tripod so that the optimizer microphone remains at the same height as your ears.

Performing Auto Calibration

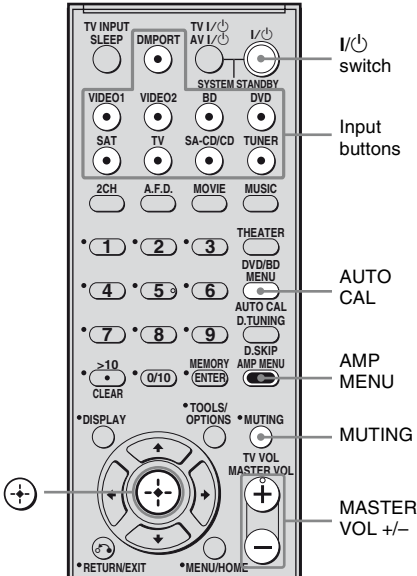

1 Press AMP MENU.

2 Press AUTO CAL.

Measurement starts in 5 seconds and the display changes as follows:

A.CAL [5] → A.CAL [4] → A.CAL [3] → A.CAL [2] → A.CAL [1]

While the time is counting down, stand away from the measurement area to avoid measurement error.

3 Measurement starts.

The measurement process will take a few minutes to complete.

The table below shows the display when measurement starts.

Measurement for	Display
Environment noise level	NOISE.CHK
Speaker connection	MEASURE and SP DET. appears alternately*
Speaker level	MEASURE and GAIN appears alternately*
Speaker distance	MEASURE and DISTANCE appears alternately*

* The corresponding speaker indicator lights up in the display during measurement.

4 Measurement ends.

“COMPLETE” appears on the display and the settings are registered.

When you have finished

Disconnect the optimizer microphone from the AUTO CAL MIC jack.

Notes

- Auto Calibration cannot detect the subwoofer. Therefore, all subwoofer settings will be maintained.
- If you have changed the position of the speakers, it is recommended that you perform Auto Calibration again in order to enjoy the surround sound.

Tips

- When Auto Calibration starts:
 - Stand some distance from the speakers and the listening position to avoid measurement failure. This is because test signals are output from the speakers during measurement.
 - Avoid making noise to get a more accurate measurement.
- The Auto Calibration function will be canceled when you do the following during the measurement process:
 - Press I/⏻ or MUTING.
 - Press the input buttons or turn the INPUT SELECTOR on the receiver.
 - Change the volume level.
 - Connect the headphones.
 - Press AUTO CAL again.

Error and warning codes

When error codes appear

When an error is detected during Auto Calibration, an error code will appear on the display cyclically after each measurement process as follows:

Error code → blank display → (error code → blank display)^{a)} → PUSH → blank display → ENTER

^{a)} Appears when there are more than one error code.

To rectify the error

- 1 Record down the error code.
- 2 Press ⊕.
- 3 Press I/⏻ to turn off the receiver.
- 4 Rectify the error.
For details, see “Error codes and remedies” below.
- 5 Turn on the receiver and perform Auto Calibration again (page 32).

Error codes and remedies

Error code	Cause and remedy
ERROR 10	The environment is too noisy. Make sure the environment is quiet during Auto Calibration.
ERROR 11	The speakers are placed too near the optimizer microphone. Place your speakers further away from the optimizer microphone.
ERROR 12	None of the speakers are detected. Make sure that the optimizer microphone is connected properly and perform Auto Calibration again.
ERROR 20	Front speakers are not detected or only one front speaker is detected. Check the front speakers connection.
ERROR 21	Only one surround speaker is detected. Check the surround speakers connection.
ERROR 22	The surround back speaker is connected only to the SPEAKERS SURROUND BACK/BI-AMP/FRONT B R terminals. When you connect only one surround back speaker, connect it to the SPEAKERS SURROUND BACK/BI-AMP/FRONT B L terminals.
ERROR 23	Surround back speaker is detected but surround speakers are not connected. Be sure to connect the surround speakers.

When warning codes appear

During Auto Calibration, the warning code provides information on the measurement result. The warning code will appear on the display cyclically as follows:

Warning code → blank display → (warning code → blank display)^{b)} → PUSH → blank display → ENTER

^{b)} Appears when there are more than one warning code.

You can choose to ignore the warning code as the Auto Calibration function will automatically adjust the settings. You can also change the settings manually.

To change the settings manually

- 1 Record down the warning code.
- 2 Press ⊕.
- 3 Press I/⏻ to turn off the receiver.
- 4 Follow the solution provided in the “Warning codes and solutions” below.
- 5 Turn on the receiver and perform Auto Calibration again (page 32).

Warning codes and solutions

Warning code	Explanation and solution
WARN. 40	The environment is noisy. Make sure the environment is quiet during Auto Calibration.
WARN. 60	The front speaker balance is out of range. Reposition your front speakers. ^{c)}
WARN. 62	The center speaker level is out of range. Reposition your center speaker. ^{d)}
WARN. 63	The surround left speaker level is out of range. Reposition your surround left speaker. ^{d)}
WARN. 64	The surround right speaker level is out of range. Reposition your surround right speaker. ^{d)}
WARN. 65	The surround back left speaker level is out of range. Reposition your surround back left speaker. ^{d)}
WARN. 66	The surround back right speaker level is out of range. Reposition your surround back right speaker. ^{d)}
WARN. 70	The front speaker distance is out of range. Reposition your front speakers. ^{c)}
WARN. 72	The center speaker distance is out of range. Reposition your center speaker. ^{d)}
WARN. 73	The surround left speaker distance is out of range. Reposition your surround left speaker. ^{d)}
WARN. 74	The surround right speaker distance is out of range. Reposition your surround right speaker. ^{d)}

Warning code	Explanation and solution
WARN. 75	The surround back left speaker distance is out of range. Reposition your surround back left speaker. ^{d)}
WARN. 76	The surround back right speaker distance is out of range. Reposition your surround back right speaker. ^{d)}

^{c)}For details, refer “Front speaker distance” (page 53).

^{d)}For details, refer “Tip” on page 54.

9: Adjusting the speaker levels and balance (TEST TONE)

You can adjust the speaker levels and balance while listening to the test tone from your listening position.

Tip

The receiver employs a test tone with a frequency centered at 800 Hz.

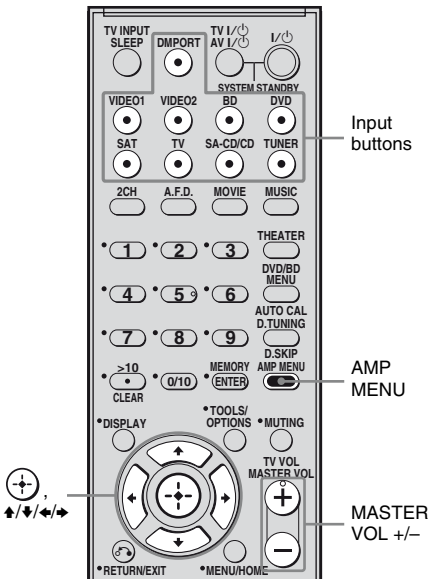

- 1 Press AMP MENU.**
“1-LEVEL” appears on the display.
- 2 Press \oplus or \rightarrow to enter the menu.**
- 3 Press \updownarrow repeatedly to select “T. TONE”.**
- 4 Press \oplus or \rightarrow to enter the parameter.**

- 5 Press \updownarrow repeatedly to select “T. TONE Y”.**

The test tone is output from each speaker in sequence as follows:

Front left \rightarrow Center \rightarrow Front right \rightarrow Surround right \rightarrow Surround back right* \rightarrow Surround back left* \rightarrow Surround left \rightarrow Subwoofer

- * You will only hear the test tone from the
- surround back left and right speakers when surround back speakers are set to “DUAL”.
 - surround back left speaker when surround back speakers are set to “SINGLE”.

- 6 Adjust the speaker levels and balance using the LEVEL menu so that the level of the test tone sounds the same from each speaker.**

For details, see “Adjusting the level (LEVEL menu)” (page 45).

Tips

- To adjust the level of all speakers at the same time, press MASTER VOL +/- . You can also use MASTER VOLUME on the receiver.
- The adjusted value is shown on the display during adjustment.

- 7 Repeat steps 1 to 5 to select “T. TONE N”.**

You can also press any input buttons. The test tone turns off.

When a test tone is not output from the speakers

- The speaker cords may not be connected securely.
- The speaker cords may have the short-circuit problem.

Note

The test tone does not work when ANALOG DIRECT is selected.

Playback

Selecting a component

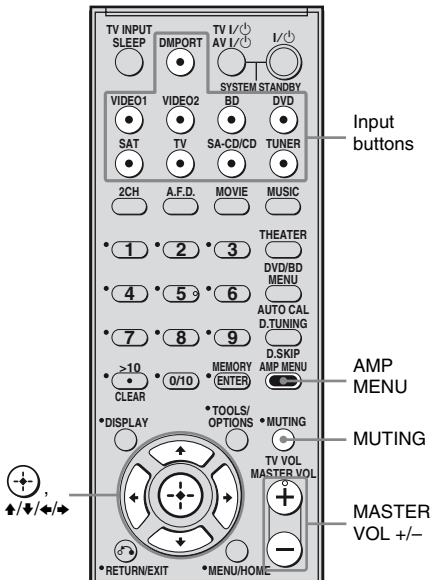

1 Press the input button to select a component.

You can also use INPUT SELECTOR on the receiver.
The selected input appears on the display.

Selected input [Display]	Components that can be played back
DMPORT [DMPORT]	DIGITAL MEDIA PORT adapter connected to the DMPORT jack
VIDEO 1 [VIDEO 1]	DVD recorder, VCR, etc., connected to the VIDEO 1 jack
VIDEO 2 [VIDEO 2]	Camcorder, video game, etc., connected to the VIDEO 2 IN jack
BD [BD]	Blu-ray disc player, etc., connected to the BD jack
DVD [DVD]	DVD player, etc., connected to DVD jack

Selected input [Display]	Components that can be played back
SAT [SAT]	Satellite tuner, etc. connected to the SAT jack
TV [TV]	TV, etc. connected to the TV jack
SA-CD/CD [SA-CD/CD/CD-R]*	Super Audio CD/CD player/CD recorder, etc., connected to the SA-CD/CD/CD-R jack
TUNER [FM or AM band]	Built-in radio tuner
TUNER [SIRIUS]	SiriusConnect Home tuner connected to the SIRIUS jack.

* "SA-CD/CD/CD-R" scrolls across the display, then "SA-CD/CD" appears.

2 Turn on the component and start playback.

3 Press MASTER VOL +/- to adjust the volume.

You can also use MASTER VOLUME on the receiver.

To activate the muting function

Press MUTING.

The muting function will be canceled when you do the following.

- Press MUTING again.
- Increase the volume.
- Turn off the receiver.

To avoid damaging your speakers

Before you turn off the receiver, be sure to turn down the volume level.

Naming input

You can enter a name of up to 8 characters for inputs and display it on the receiver's display. This is convenient for labeling the jacks with the names of the connected components.

1 Press the input button to select the input you want to create an index name for.

You can also use INPUT SELECTOR on the receiver.

2 Press AMP MENU.

"1-LEVEL" appears on the display.

3 Press \uparrow/\downarrow repeatedly to select "7-SYSTEM".

4 Press \oplus or \rightarrow to enter the menu.

5 Press \uparrow/\downarrow to select "NAME IN".

6 Press \oplus or \rightarrow to enter the parameter.

The cursor flashes and you can select a character.

7 Press \uparrow/\downarrow to select a character, then press \leftarrow/\rightarrow to move the cursor to the next position.

If you made a mistake

Press \leftarrow/\rightarrow until the character you want to change flashes, then press \uparrow/\downarrow to select the correct character.

Tips

- You can select the character type as follows by pressing \uparrow/\downarrow .
Alphabet (upper case) \rightarrow Numbers \rightarrow Symbols
- To enter a blank space, press \rightarrow without selecting a character.

8 Press \oplus .

The name you entered is registered.

Listening/Watching a component

Listening to a Super Audio CD/CD

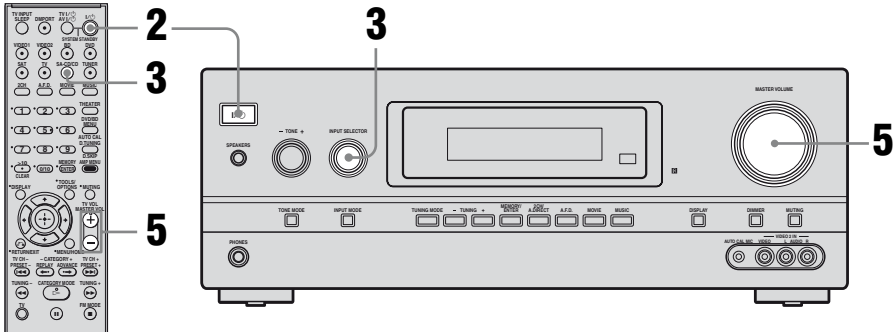

Notes

- The operation is described for a Sony Super Audio CD player.
- Refer to the operating instructions supplied with the Super Audio CD player or CD player.

Tip

You can select the sound field to suit the music. Refer to page 58 for details.

Recommended sound fields:

Classical: HALL

Jazz: JAZZ

Live concert: CONCERT

1 Turn on the Super Audio CD player/CD player, then place the disc on the tray.

2 Turn on the receiver.

3 Press SA-CD/CD.

You can also use INPUT SELECTOR on the receiver to select “SA-CD/CD/CD-R”.

4 Play back the disc.

5 Adjust to a suitable volume.

6 After you have finished listening to the Super Audio CD/CD, eject the disc and turn off the receiver and Super Audio CD player/CD player.

Watching a DVD/Blu-ray disc

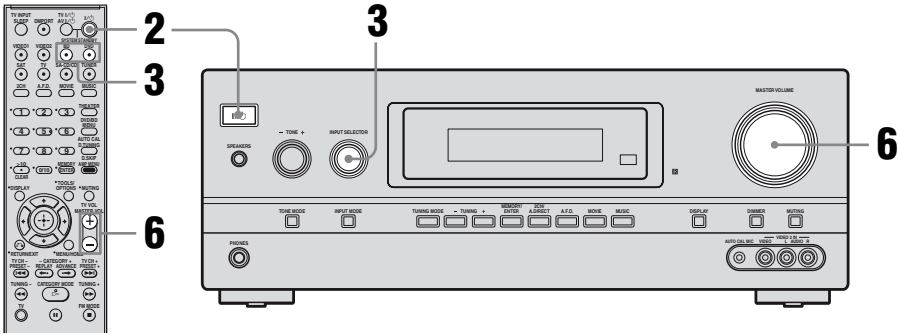

Notes

- Refer to the operating instructions supplied with the TV and DVD player/Blu-ray disc player.
- Check the following if you cannot listen to multi channel sound.
 - Be sure this receiver is connected to the DVD player/Blu-ray disc player via a digital connection.
 - Be sure the digital audio output of the DVD player/Blu-ray disc player is set up properly.

Tips

- Select the sound format of the disc to be played, if necessary.
- You can select the sound field to suit the movie/music. Refer to page 58 for details.
Recommended sound fields:
Movie: C.ST.EX
Music: CONCERT

- 1 Turn on the TV and DVD player/Blu-ray disc player.**
- 2 Turn on the receiver.**
- 3 Press DVD to watch a DVD or press BD to watch a Blu-ray disc.**
You can also use INPUT SELECTOR on this receiver to select “DVD” or “BD”.
- 4 Switch the input of the TV so that an image of the DVD/Blu-ray disc is displayed.**
- 5 Play back the disc.**
- 6 Adjust to a suitable volume.**
- 7 After you have finished watching the DVD/Blu-ray disc, eject the disc and turn off the receiver, TV and DVD player/Blu-ray disc player.**

Amplifier Operations

Navigating through menus

By using the amplifier menus, you can make various adjustments to customize the receiver.

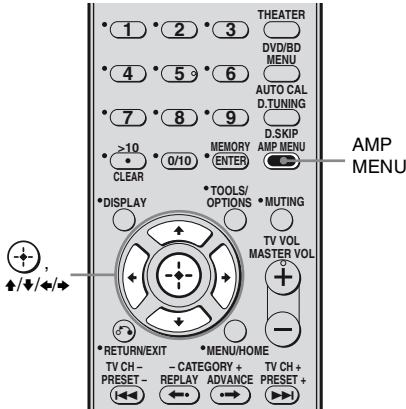

To return to the previous display

Press ←.

To exit the menu

Press AMP MENU.

Note

Some parameters and settings may appear dimmed on the display. This means that they are either unavailable or fixed and unchangeable.

1 Press AMP MENU.

“1-LEVEL” appears on the display.

2 Press ↑/↓ repeatedly to select the menu you want.

3 Press Ⓢ or → to enter the menu.

4 Press ↑/↓ repeatedly to select the parameter you want to adjust.

5 Press Ⓢ or → to enter the parameter.

6 Press ↑/↓ repeatedly to select the setting you want.

The setting is entered automatically.

Overview of the menus

The following options are available in each menu. For details on navigating through menus, see page 40.

Menu [Display]	Parameters [Display]	Settings	Initial setting
LEVEL [1-LEVEL] (page 45)	Test tone ^{a)} [T. TONE]	T. TONE N, T. TONE Y	T. TONE N
	Front speaker balance ^{a)} [FRT BAL]	BAL. L +1 to BAL. L +8, BALANCE, BAL. R +1 to BAL. R +8	BALANCE
	Center speaker level [CNT LVL]	CNT -10 dB to CNT +10 dB (1 dB step)	CNT 0 dB
	Surround left speaker level [SL LVL]	SUR L -10 dB to SUR L +10 dB (1 dB step)	SUR L 0 dB
	Surround right speaker level [SR LVL]	SUR R -10 dB to SUR R +10 dB (1 dB step)	SUR R 0 dB
	Surround back speaker level ^{b)} [SB LVL]	SB -10 dB to SB +10 dB (1 dB step)	SB 0 dB
	Surround back left speaker level ^{c)} [SBL LVL]	SBL -10 dB to SBL +10 dB (1 dB step)	SBL 0 dB
	Surround back right speaker level ^{c)} [SBR LVL]	SBR -10 dB to SBR +10 dB (1 dB step)	SBR 0 dB
	Subwoofer level [SW LVL]	SW -10 dB to SW +10 dB (1 dB step)	SW 0 dB
	Dynamic range compressor ^{a)} [D. RANGE]	COMP. OFF, COMP. STD, COMP. MAX	COMP. OFF
EQ [2-EQ] (page 46)	Equalizer on/off ^{a)} [EQ]	EQ OFF, EQ ON	EQ OFF
	Front speaker bass level ^{a)} [BASS LVL]	BASS -6 dB to BASS +6 dB (1 dB step)	BASS 0 dB
	Front speaker treble level ^{a)} [TRE LVL]	TRE -6 dB to TRE +6 dB (1 dB step)	TRE 0 dB
SUR [3-SUR] (page 46)	Sound field selection ^{a)} [S.F. SELCT]	For details, see “Enjoying Surround Sound” (page 56).	A.F.D. AUTO
	Surround back decoding mode ^{a)} [SB DEC]	SB OFF, SB AUTO, SB ON	SB AUTO
	Effect level ^{a)} [EFFECT]	EFCT. MIN, EFCT. STD, EFCT. MAX	EFCT. STD

Menu [Display]	Parameters [Display]	Settings	Initial setting
TUNER [4-TUNER] (page 48)	FM station receiving mode ^{a)} [FM MODE]	FM AUTO, FM MONO	FM AUTO
	Naming preset stations ^{a)} [NAME IN]	For details, see “Naming preset stations” (page 65).	
	Parental lock ^{a)d)} [PARENTAL]	OFF, ON	OFF
	Lock code edit ^{a)d)} [CODE EDT.]	For details, see “Restricting access to specific channels (Parental Lock (SIRIUS only))” (page 72).	
	SIRIUS antenna aiming mode ^{a)d)} [SR ANT]	For details, see “Checking receiving conditions (SIRIUS Antenna Aiming)” (page 68).	
	SIRIUS radio ID ^{a)d)} [SR ID]	For details, see “Checking the SIRIUS Radio ID” (page 67).	
AUDIO [5-AUDIO] (page 49)	Digital audio input decoding priority ^{a)} [DEC. PRI.]	DEC. PCM, DEC. AUTO	DEC. PCM for: SA-CD/CD; DEC. AUTO for: VIDEO 1, 2, BD, DVD, SAT, TV
	Digital broadcast language selection ^{a)} [DUAL]	DUAL M/S, DUAL M, DUAL S, DUAL M+S	DUAL M
	Synchronizes audio with video output ^{a)} [A.V. SYNC.]	A.V.SYNC. N, A.V.SYNC. Y	A.V.SYNC. N
	Digital audio input assignment ^{a)} [D. ASSIGN]	For details, see “Listening to digital sound from other inputs (DIGITAL ASSIGN)” (page 89).	
HDMI [6-HDMI] (page 50)	Audio for HDMI ^{a)e)} [AUDIO FOR HDMI]	AMP, TV+AMP	AMP
	Control for HDMI ^{a)c)} [CONTROL FOR HDMI]	CTRL OFF, CTRL ON	CTRL OFF

Menu [Display]	Parameters [Display]	Settings	Initial setting
SYSTEM [7-SYSTEM] (page 51)	Subwoofer ^{a)} [SW SPK]	NO, YES	YES
	Front speakers ^{a)} [FRT SPK]	SMALL, LARGE	LARGE
	Center speaker ^{a)} [CNT SPK]	NO, SMALL, LARGE	LARGE
	Surround speakers ^{a)} [SUR SPK]	NO, SMALL, LARGE	LARGE
	Surround back speakers ^{a)} [SB SPK]	NO, SINGLE, DUAL	DUAL
	Surround back speaker assign ^{a)f)} [SB ASGN]	OFF, BI-AMP, SPK B	OFF
	Front speaker distance ^{a)} [FRT DIST.]	DIST. 3 ft. to DIST. 23 ft. (1 ft. step)	DIST. 10 ft.
	Center speaker distance ^{a)} [CNT DIST.]	DIST. 3 ft. to DIST. 23 ft. (1 ft. step)	DIST. 10 ft.
	Surround left speaker distance ^{a)} [SL DIST.]	DIST. 3 ft. to DIST. 23 ft. (1 ft. step)	DIST. 10 ft.
	Surround right speaker distance ^{a)} [SR DIST.]	DIST. 3 ft. to DIST. 23 ft. (1 ft. step)	DIST. 10 ft.
	Surround back speaker distance ^{a)b)} [SB DIST.]	DIST. 3 ft. to DIST. 23 ft. (1 ft. step)	DIST. 10 ft.
	Surround back left speaker distance ^{a)c)} [SBL DIST.]	DIST. 3 ft. to DIST. 23 ft. (1 ft. step)	DIST. 10 ft.
	Surround back right speaker distance ^{a)c)} [SBR DIST.]	DIST. 3 ft. to DIST. 23 ft. (1 ft. step)	DIST. 10 ft.
	Surround speaker position ^{a)} [SUR POS.]	BEHD/HI, BEHD/LO, SIDE/HI, SIDE/LO	SIDE/LO
	Speaker crossover frequency ^{a)} [CRS. FREQ]	CRS > 40 Hz to CRS > 160 Hz (10 Hz step)	CRS > 100 Hz
	Brightness of the display ^{a)} [DIMMER]	0% dim, 40% dim, 70% dim	0% dim
	Naming inputs ^{a)} [NAME IN]	For details, see “Naming input” (page 37).	
A. CAL [8-A. CAL] (page 55)	Auto Calibration ^{a)} [AUTO CAL]	A.CAL NO, A.CAL YES	A.CAL NO

Menu [Display]	Parameters [Display]	Settings	Initial setting
S-AIR [9- S-AIR] (page 56)	S-AIR ID ^{g)} [ID SETUP]	ID A, ID B, ID C	ID A
	Pairing ^{g)} [PAIRING]	START, STATUS	
	S-AIR Mode ^{g)} [MODE]	PARTY, SEPARATE	PARTY
	RF Change ^{g)} [RF SETUP]	RF AUTO, RF ON, RF OFF	RF AUTO
	S-AIR Standby ^{g)} [STANDBY]	STBY ON, STBY OFF	STBY OFF

a) For details, refer to the page in the parentheses.

b) You can only select this parameter when the surround back speakers are set to “SINGLE”.

c) You can only select this parameter when the surround back speakers are set to “DUAL”.

d) This parameter is only available if the SiriusConnect Home tuner is connected to the SIRIUS jack on the receiver.

e) “AUDIO FOR HDMI” and “CONTROL FOR HDMI” scroll across the display, then “AUDIO” and “CONTROL” appear respectively.

f) You can only select this parameter when the surround back speakers are set to “NO”.

g) This parameter is only available if the S-AIR transmitter (not supplied) is inserted to the EZW-T100 slot on the receiver.

Adjusting the level

(LEVEL menu)

You can use the LEVEL menu to adjust the balance and level of each speaker. These settings are applied to all sound fields. Select “1-LEVEL” in the amplifier menus. For details on adjusting the parameters, see “Navigating through menus” (page 40) and “Overview of the menus” (page 41).

LEVEL menu parameters

■ T. TONE (Test tone)

Lets you adjust the speaker levels and balance while listening to the test tone from your listening position. For details, see “9: Adjusting the speaker levels and balance (TEST TONE)” (page 35).

■ FRT BAL (Front speaker balance)

Lets you adjust the balance between front left and right speakers.

■ CNT LVL (Center speaker level)

■ SL LVL (Surround left speaker level)

■ SR LVL (Surround right speaker level)

■ SB LVL (Surround back speaker level)^{a)}

■ SBL LVL (Surround back left speaker level)^{b)}

■ SBR LVL (Surround back right speaker level)^{b)}

■ SW LVL (Subwoofer level)

a) You can only select this parameter when the surround back speakers are set to “SINGLE” in SYSTEM menu.

b) You can only select this parameter when the surround back speakers are set to “DUAL” in SYSTEM menu.

■ D. RANGE (Dynamic range compressor)

Lets you compress the dynamic range of the sound track. This may be useful when you want to watch movies at low volumes late at night. Dynamic range compression is possible with Dolby Digital sources only.

- COMP. OFF

The dynamic range is not compressed.

- COMP. STD

The dynamic range is compressed as intended by the recording engineer.

- COMP. MAX

The dynamic range is compressed dramatically.

Tip

Dynamic range compressor lets you compress the dynamic range of the soundtrack based on the dynamic range information included in the Dolby Digital signal.

“COMP. STD” is the standard setting, but it only enacts light compression. Therefore, we recommend using the “COMP. MAX” setting. This greatly compresses the dynamic range and lets you view movies late at night at low volumes. Unlike analog limiters, the levels are predetermined and provide a very natural compression.

Adjusting the equalizer (EQ menu)

You can use the EQ menu to adjust the tonal quality (bass/treble level) of the front speakers.

Select “2-EQ” in the amplifier menus. For details on adjusting the parameters, see “Navigating through menus” (page 40) and “Overview of the menus” (page 41).

EQ menu parameters

■ EQ (Equalizer on/off)

Lets you turn the equalizer on or off.

- EQ OFF
The equalizer is turned off.
- EQ ON
The equalizer is turned on.

■ BASS LVL (Front speaker bass level)

■ TRE LVL (Front speaker treble level)

Notes

- This function does not work for signals with a sampling frequency of more than 48 kHz.
- If you adjust the equalizer during DTS 96/24 signal reception, the signal will be output only at 48 kHz.

Settings for the surround sound (SUR menu)

You can use the SUR menu to select the sound field you want for your listening pleasure.

Select “3-SUR” in the amplifier menus. For details on adjusting the parameters, see “Navigating through menus” (page 40) and “Overview of the menus” (page 41).

SUR menu parameters

■ S.F. SELCT (Sound field selection)

Lets you select the sound field you want. For details, see “Enjoying Surround Sound” (page 56).

Note

The receiver lets you apply the last selected sound field to an input whenever it is selected (Sound Field Link). For example, if you select “HALL” for the DVD input, then change to a different input and then return to DVD, “HALL” will automatically be applied again.

■ SB DEC (Surround back decoding mode)

Lets you select the surround back decoding mode. For details, see “Using the surround back decoding mode (SB DEC)” (page 47).

■ EFFECT (Effect level)

Lets you adjust the “presence” of the surround effect for sound fields selected with the MOVIE or MUSIC buttons.

- EFCT. MIN
The surround effect is minimum.
- EFCT. STD
The surround effect is standard.
- EFCT. MAX
The surround effect is maximum.

Using the surround back decoding mode (SB DEC)

By decoding the surround back signal of DVD software (etc.) recorded in Dolby Digital Surround EX, DTS-ES Matrix, DTS-ES Discrete 6.1, etc., format, you can enjoy the surround sound intended by the filmmakers. Select the surround back decoding mode using “SB DEC” on the SUR menu (page 46).

Types of the surround back decoding functions

■ SB OFF

Surround back decoding is not performed.

■ SB AUTO

When the input stream contains the 6.1 channel decode flag^{a)}, the appropriate decoding is performed on the surround back signal.

Input stream	Output channel	Surround back decoding
Dolby Digital 5.1	5.1 ^{e)}	—
Dolby Digital Surround EX ^{b)}	6.1 ^{e)}	Matrix decoder that conforms to Dolby Digital EX
DTS 5.1	5.1 ^{e)}	—
DTS-ES Matrix 6.1 ^{c)}	6.1 ^{e)}	DTS Matrix decoding
DTS-ES Discrete 6.1 ^{d)}	6.1 ^{e)}	DTS Discrete decoding
Dolby Digital Surround EX ^{b)}	7.1	Matrix decoder that conforms to Dolby Pro Logic IIX
DTS-ES Matrix 6.1 ^{c)}	7.1	DTS Matrix decoding
DTS-ES Discrete 6.1 ^{d)}	7.1	DTS Discrete decoding

■ SB ON

To decode the surround back signal regardless of the 6.1 channel decode flag^{a)}, Dolby Digital EX is applied when the output channel is 6.1.

Input stream	Output channel	Surround back decoding
Dolby Digital 5.1	6.1 ^{e)}	Matrix decoder that conforms to Dolby Digital EX
Dolby Digital Surround EX ^{b)}	6.1 ^{e)}	Matrix decoder that conforms to Dolby Digital EX
DTS 5.1	6.1 ^{e)}	Matrix decoder that conforms to Dolby Digital EX
DTS-ES Matrix 6.1 ^{c)}	6.1 ^{e)}	Matrix decoder that conforms to Dolby Digital EX
DTS-ES Discrete 6.1 ^{d)}	6.1 ^{e)}	Matrix decoder that conforms to Dolby Digital EX
Dolby Digital 5.1	7.1	Matrix decoder that conforms to Dolby Pro Logic IIX
Dolby Digital Surround EX ^{b)}	7.1	Matrix decoder that conforms to Dolby Pro Logic IIX
DTS 5.1	7.1	Matrix decoder that conforms to Dolby Digital EX
DTS-ES Matrix 6.1 ^{c)}	7.1	Matrix decoder that conforms to Dolby Digital EX
DTS-ES Discrete 6.1 ^{d)}	7.1	Matrix decoder that conforms to Dolby Digital EX

^{a)} A 6.1 channel decode flag is information recorded in software such as DVDs.

^{b)} A Dolby Digital DVD that includes a Surround EX flag. The Dolby Corporation web page can help you distinguish Surround EX films.

^{c)} Software encoded with a flag to denote it has both DTS-ES Matrix and 5.1 channel signals.

^{d)} Software encoded with both 5.1 channel signals and an extension stream designed for returning those signals to 6.1 discrete channels. Discrete 6.1 channel signals are DVD specific signals not used in movie theaters.

^{e)} When two surround back speakers are connected, the output channel will be 7.1 channel.

continued

Notes

- There may be no sound from the surround back speaker in Dolby Digital EX mode. Some discs have no Dolby Digital Surround EX flag even though the packages have Dolby Digital EX logos. In this case, select “SB ON”.
- You can select the surround back decoding mode only when A.F.D. mode is selected. However, this function is canceled when Dolby Pro Logic IIx is selected.

Settings for the tuner (TUNER menu)

You can use the TUNER menu to set the FM station receiving mode and to name preset stations.

Select “4-TUNER” in the amplifier menus. For details on adjusting the parameters, see “Navigating through menus” (page 40) and “Overview of the menus” (page 41).

TUNER menu parameters

■ FM MODE (FM station receiving mode)

- FM AUTO
This receiver will decode the signal as stereo signal when the radio station is broadcast in stereo.
- FM MONO
This receiver will decode the signal as mono signal regardless of the broadcast signal.

■ NAME IN (Naming preset stations)

Lets you set the name of preset stations. For details, see “Naming preset stations” (page 65).

■ PARENTAL (Parental lock)

Lets you restrict access to certain channels using your own lock code. For details, see “Restricting access to specific channels (Parental Lock) (SIRIUS only)” (page 72).

■ CODE EDT. (Lock code edit)

Lets you change the lock code. For details, see “To change the lock code (Lock Code)” (page 72).

■ SR ANT (SIRIUS antenna aiming mode)

This parameter helps you to aim the SIRIUS antenna for optimal signal reception. For details, see “Checking receiving conditions (SIRIUS Antenna Aiming)” (page 68).

■ SR ID (SIRIUS radio ID)

Lets you check the SIRIUS Radio ID. For details, see “Checking the SIRIUS Radio ID” (page 67).

Settings for the audio (AUDIO menu)

You can use the AUDIO menu to make settings for the audio to suit your preference. Select “5-AUDIO” in the amplifier menus. For details on adjusting the parameters, see “Navigating through menus” (page 40) and “Overview of the menus” (page 41).

AUDIO menu parameters

■ DEC. PRI. (Digital audio input decoding priority)

Lets you specify the input mode for the digital signal input to the DIGITAL IN and HDMI IN jacks.

- DEC. PCM
When signals from the DIGITAL IN jack are selected, PCM signals are given priority (to prevent interruption when playback starts). However, when other signals are input, there may be no sound, depending on the format. In this case, set this item to “DEC. AUTO”. When signals from the HDMI IN jack are selected, only PCM signals are output from the connected player. When signals in any other format are received, set this item to “DEC. AUTO”.
- DEC. AUTO
Automatically switches the input mode between DTS, Dolby Digital, or PCM.

Note

When set to “DEC. AUTO” and the sound from the digital audio jacks (for a CD, etc.) is interrupted when playback starts, set to “DEC. PCM”.

■ DUAL (Digital broadcast language selection)

Lets you select the language you want to listen to during digital broadcast. This feature only functions for Dolby Digital sources.

- DUAL M/S (Main/Sub)
Sound of the main language will be output through the front left speaker and sound of the sub language will be output through the front right speaker simultaneously.
- DUAL M (Main)
Sound of the main language will be output.
- DUAL S (Sub)
Sound of the sub language will be output.
- DUAL M+S (Main + Sub)
Mixed sound of both the main and sub languages will be output.

■ A.V. SYNC. (Synchronizes audio with video output)

- A.V.SYNC. N (No) (Delay time: 0 ms)
The audio output is not delayed.
- A.V.SYNC. Y (Yes) (Delay time: 60 ms)
The audio output is delayed so that the time gap between the audio output and visual display is minimized.

Notes

- This parameter is useful when you use a large LCD or plasma TV or a projector.
- This parameter is valid only when you use a sound field selected with the 2CH or A.F.D. buttons.
- This parameter is not valid when
 - signals with a sampling frequency of more than 48 kHz is input.
 - the multi channel Linear PCM signals are received via an HDMI IN jack.
 - ANALOG DIRECT function is selected.

■ D. ASSIGN (Digital audio input assignment)

Lets you assign the digital audio input to other input source. For details, see “Listening to digital sound from other inputs (DIGITAL ASSIGN)” (page 89).

Settings for the HDMI (HDMI menu)

You can use the HDMI menu to make various adjustments for HDMI.

Select “6-HDMI” in the amplifier menus. For details on adjusting the parameters, see “Navigating through menus” (page 40) and “Overview of the menus” (page 41).

HDMI menu parameters

■ AUDIO FOR HDMI (Audio for HDMI)

Lets you set the audio output for HDMI from the playback component connected to the receiver via an HDMI connection.

- AMP
The HDMI audio signals from the playback component is only output to speakers connected to the receiver. Multi-channel sound can be played back as it is.

Note

Audio signals are not output from the TV’s speakers when “AUDIO FOR HDMI” is set to “AMP”.

- TV+AMP
The sound is output from TV’s speaker and the speakers connected to the receiver.

Notes

- The sound quality of the playback component depends on the TV’s sound quality, such as the number of channels, and the sampling frequency, etc. When the TV has stereo speakers, the sound output from the receiver is also stereo as that of the TV, even if you play back multi-channel source.
- When you connect the receiver to a video component (projector, etc.), sound may not be output from the receiver. In this case, select “AMP”.

■ CONTROL FOR HDMI (Control for HDMI)

Lets you turn the Control for HDMI function on or off. For details, see ““BRAVIA” Sync Features” (page 75).

Settings for the system (SYSTEM menu)

You can use the SYSTEM menu to set the size and distance of the speakers connected to this system.

Select “7-SYSTEM” in the amplifier menus. For details on adjusting the parameters, see “Navigating through menus” (page 40) and “Overview of the menus” (page 41).

SYSTEM menu parameters

■ SW SPK (Subwoofer)

- NO
If you have not connected a subwoofer, select “NO”. This activates the bass redirection circuitry and outputs the LFE signals from other speakers.
- YES
If you have connected a subwoofer, select “YES”.

Tip

In order to take full advantage of the Dolby Digital bass redirection circuitry, we recommend setting the subwoofer’s cut off frequency as high as possible.

■ FRT SPK (Front speakers)

- SMALL
If the sound is distorted, or you feel a lack of surround effects when using multi channel surround sound, select “SMALL” to activate the bass redirection circuitry and output the front channel bass frequencies from the subwoofer. When the front speakers are set to “SMALL”, the center and surround speakers are also automatically set to “SMALL” (unless previously set to “NO”).
- LARGE
If you connect large speakers that will effectively reproduce bass frequencies, select “LARGE”. Normally, select “LARGE”. When the subwoofer is set to “NO”, the front speakers are automatically set to “LARGE”.

■ CNT SPK (Center speaker)

- NO

If you have not connected a center speaker, select “NO”. The sound of the center channel will be output from the front speakers.

- SMALL

If the sound is distorted, or you feel a lack of surround effects when using multi channel surround sound, select “SMALL” to activate the bass redirection circuitry and output the center channel bass frequencies from the front speakers (if set to “LARGE”) or subwoofer.

- LARGE

If you connect a large speaker that will effectively reproduce bass frequencies, select “LARGE”. Normally, select “LARGE”. However, if the front speakers are set to “SMALL”, you cannot set the center speaker to “LARGE”.

■ SUR SPK (Surround speakers)

The surround back speakers will be set to the same setting.

- NO

If you have not connected surround speakers, select “NO”.

- SMALL

If the sound is distorted, or you feel a lack of surround effects when using multi channel surround sound, select “SMALL” to activate the bass redirection circuitry and output the surround channel bass frequencies from the subwoofer or other “LARGE” speakers.

- LARGE

If you connect large speakers that will effectively reproduce bass frequencies, select “LARGE”. Normally, select “LARGE”. However, if the front speakers are set to “SMALL”, you cannot set the surround speakers to “LARGE”.

■ SB SPK (Surround back speakers)

When the surround speakers are set to “NO”, the surround back speakers are also automatically set to “NO” and the setting cannot be changed.

- NO

If you have not connected a surround back speaker, select “NO”.

- SINGLE

If you connect only one surround back speaker, select “SINGLE”. The sound will be output to a maximum of 6.1 channel.

- DUAL

If you connect two surround back speakers, select “DUAL”. The sound will be output to a maximum of 7.1 channel.

Tip

The “LARGE” and “SMALL” settings for each speaker determine whether the internal sound processor will cut the bass signal from that channel. When the bass is cut from a channel, the bass redirection circuitry sends the corresponding bass frequencies to the subwoofer or other “LARGE” speakers.

However, since bass sounds have a certain amount of directionality, it is best not to cut them, if possible. Therefore, even when using small speakers, you can set them to “LARGE” if you want to output the bass frequencies from that speaker. On the other hand, if you are using a large speaker, but prefer not to have bass frequencies output from that speaker, set it to “SMALL”.

If the overall sound level is lower than you prefer, set all speakers to “LARGE”. If there is not enough bass, you can use the equalizer to boost the bass levels. For details, see page 41.

■ SB ASGN (Surround back speaker assign)

- OFF
If you connect surround back speakers to the SPEAKERS SURROUND BACK/BI-AMP/FRONT B terminals, select “OFF”.
- BI-AMP
If you connect front speakers to the SPEAKERS SURROUND BACK/BI-AMP/FRONT B terminals using a bi-amplifier connection, select “BI-AMP”.
- SPK B
If you connect an additional front speaker system to the SPEAKERS SURROUND BACK/BI-AMP/FRONT B terminals, select “SPK B”.

Notes

- SB ASGN cannot be selected if SB SPK is set to “SINGLE” or “DUAL”.
- SB ASGN will be set to “OFF” automatically if you set SB SPK to “SINGLE” or “DUAL”.

■ FRT DIST. (Front speaker distance)

Lets you set the distance from your listening position to the front speakers (A).
If both front speakers are not placed an equal distance from your listening position, set the distance to the closest speaker.

With only one surround back speaker

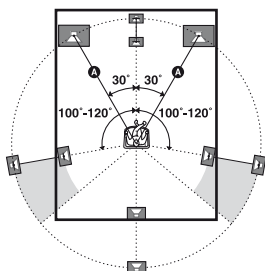

With two surround back speakers (The angle B should be the same)

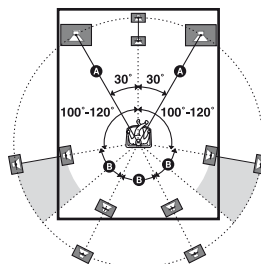

■ CNT DIST. (Center speaker distance)

Lets you set the distance from your listening position to the center speaker.

■ SL DIST. (Surround left speaker distance)

■ SR DIST. (Surround right speaker distance)

Lets you set the distance from your listening position to the surround speakers.

■ SB DIST. (Surround back speaker distance)^{a)}

■ SBL DIST. (Surround back left speaker distance)^{b)}

■ SBR DIST. (Surround back right speaker distance)^{b)}

Lets you set the distance from your listening position to the surround back speakers.

^{a)} You can only select this parameter when the surround back speakers are set to “SINGLE” in SYSTEM menu.

^{b)} You can only select this parameter when the surround back speakers are set to “DUAL” in SYSTEM menu.

Tip

To enjoy better surround sound, the distance between the center speaker and the listening position **B** cannot be more than 5 feet closer than the one between the listening position and the front speaker **A**. Place the speakers so that the difference in the length of **B** in the following diagram is no more than 5 feet closer than the length of **A**.

Example: Adjust the distance **B** to 15 feet or more when the distance **A** is 20 feet.

Also, the distance between the surround speakers/ surround back speakers and the listening position **C** cannot be more than 15 feet closer than the distance between the listening position and the front speakers **A**. Place the speakers so that the difference in the length of **C** in the following diagram is no more than 15 feet closer than the length of **A**.

Example: Adjust the distance **C** to 5 feet or more when the distance **A** is 20 feet.

This is important because incorrect speaker placement is not conducive to the enjoyment of surround sound. Please note that placing the speakers closer than the required will cause a delay in the output of the sound from that speaker. In other words, the speaker will sound like it is farther away. Adjusting these parameter while listening to the sound often results in much better surround sound. Give it a try!

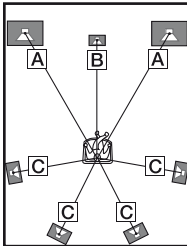

■ SUR POS. (Surround speaker position)

Lets you specify the location of your surround speakers for proper implementation of the surround effects in the CINEMA STUDIO EX modes (page 57). This setup item is not available when the surround speakers are set to “NO” (page 43).

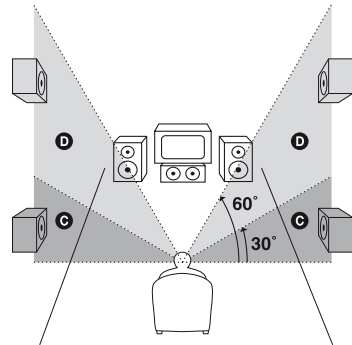
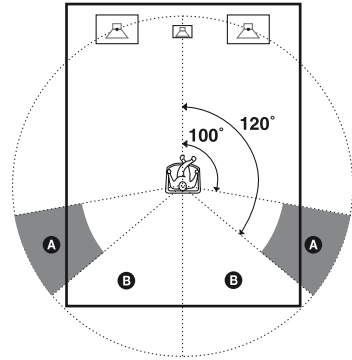

- BEHD/HI
Select if the location of your surround speakers corresponds to sections **B** and **D**.
- BEHD/LO
Select if the location of your surround speakers corresponds to sections **B** and **C**.
- SIDE/HI
Select if the location of your surround speakers corresponds to sections **A** and **D**.
- SIDE/LO
Select if the location of your surround speakers corresponds to sections **A** and **C**.

Tip

Surround speaker position is designed specifically for implementation of the CINEMA STUDIO EX modes. For other sound fields, speaker position is not so critical.

Those sound fields were designed under the premise that the surround speakers would be located behind the listening position, but presentation remains fairly consistent even with the surround speakers positioned at a rather wide angle. However, if the speakers are pointing toward the listener from the immediate left and right of the listening position, the surround effects become unclear unless set to “SIDE/LO” or “SIDE/HI”.

Nevertheless, each listening environment has many variables, such as wall reflections, and you may obtain better results using “BEHD/HI” if your speakers are located high above the listening position, even if they are located to the immediate left and right.

Therefore, although it may result in a setting contrary to the above explanation, we recommend that you play back multi channel surround encoded software and select the setting that provides a good sense of spaciousness and that best succeeds in forming a cohesive space between the surround sound from the surround speakers and the sound of the front speakers. If you are not sure which sounds best, select “BEHD/LO” or “BEHD/HI” and then use the speaker distance parameter and speaker level adjustments to obtain proper balance.

■ CRS. FREQ (Speaker crossover frequency)

Lets you set the bass crossover frequency of the speakers that have been set to “SMALL” on the SYSTEM menu. This setup item is only available when at least one speaker is set to “SMALL” and the corresponding speaker indicator flashes on the display.

■ DIMMER (Brightness of the display)

Lets you adjust the brightness in 3 steps.

■ NAME IN (Naming inputs)

Lets you set the name of inputs. For details, see “Naming input” (page 37).

Calibrating the appropriate settings automatically

(A. CAL menu)

For details on Auto Calibration, see “8: Calibrating the appropriate settings automatically (AUTO CALIBRATION)” (page 31).

Settings for the S-AIR

(S. AIR menu)

For details on S-AIR, see “S-AIR Operations” (page 80).

Enjoying Surround Sound

Enjoying Dolby Digital and DTS Surround sound (AUTO FORMAT DIRECT)

The Auto Format Direct (A.F.D.) mode allows you to listen to higher fidelity sound and select the decoding mode for listening to a 2 channel stereo sound as multi channel sound.

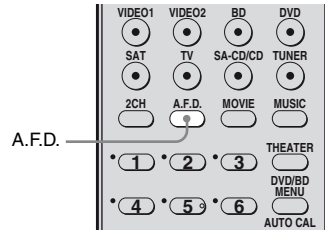

Press A.F.D. repeatedly to select the sound field you want.

For details, see “Types of A.F.D. mode” (page 57).

Types of A.F.D. mode

A.F.D. mode [Display]	Multi channel audio after decoding	Effect
A.F.D. AUTO [A.F.D. AUTO]	(Detecting automatically)	Presents the sound as it was recorded/encoded without adding any surround effects. However, this receiver will generate a low frequency signal for output to the subwoofer when there is no LFE signals.
PRO LOGIC [DOLBY PL]	4 channel	Performs Dolby Pro Logic decoding. The source recorded in 2 channel format is decoded into 4.1 channels.
PRO LOGIC II MOVIE [PLII MV]	5 channel	Performs Dolby Pro Logic II Movie mode decoding. This setting is ideal for movies encoded in Dolby Surround. In addition, this mode can reproduce sound in 5.1 channel for watching videos of overdubbed or old movies.
PRO LOGIC II MUSIC [PLII MS]	5 channel	Performs Dolby Pro Logic II Music mode decoding. This setting is ideal for normal stereo sources such as CDs.
PRO LOGIC II GAME [PLII GM]	5 channel	Performs Dolby Pro Logic II Game mode decoding. This setting is ideal for game softwares.
PRO LOGIC IIx MOVIE* [PLIIX MV]	7 channel	Performs Dolby Pro Logic IIx Movie mode decoding. This setting expands Dolby Pro Logic II Movie or Dolby Digital 5.1 to discrete 7.1 movie channels.
PRO LOGIC IIx MUSIC* [PLIIX MS]	7 channel	Performs Dolby Pro Logic IIx Music mode decoding. This setting is ideal for normal stereo sources such as CDs.
PRO LOGIC IIx GAME* [PLIIX GM]	7 channel	Performs Dolby Pro Logic IIx Game mode decoding.
Neo:6 Cinema [NEO6 CIN]	6 channel	Performs DTS Neo:6 Cinema mode decoding.
Neo:6 Music [NEO6 MUS]	6 channel	Performs DTS Neo:6 Music mode decoding. This setting is ideal for normal stereo sources such as CDs.
MULTI STEREO [MULTI ST.]	(Multi Stereo)	Outputs 2 channel left/right signals from all speakers. However, sound may not be output from certain speakers depending on the speaker settings.

* You cannot select this decoding mode if the surround back speakers are set to "NO".

If you connect a subwoofer

This receiver will generate a low frequency signal for output to the subwoofer when there is no LFE signal, which is a low-pass sound effect output from a subwoofer to a 2 channel signal. However, the low frequency signal is not generated for “NEO6 CIN” or “NEO6 MUS” when all speakers are set to “LARGE”.

Notes

- This function does not work when ANALOG DIRECT is selected.
- Dolby Pro Logic IIx decoding does not function for DTS format signals or for signals with a sampling frequency of more than 48 kHz.

Tip

When a multi channel signal is input, only Dolby Pro Logic IIx decoding is effective. When you select decoding modes other than Dolby Pro Logic IIx, multi channel sound (being encoded) is output.

Selecting a pre-programmed sound field

You can take advantage of surround sound simply by selecting one of the receiver’s pre-programmed sound fields. They bring the exciting and powerful sound of movie theaters and concert halls into your home.

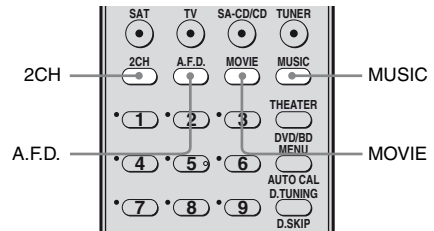

Press MOVIE repeatedly to select a sound field for movies or press MUSIC repeatedly to select a sound field for music.

For details, see “Types of sound field available” (page 59).

Types of sound field available

Sound field for	Sound field [Display]	Effect
Movie	CINEMA STUDIO EX A DCS [C.ST.EX A]	Reproduces the sound characteristics of the Sony Pictures Entertainment "Cary Grant Theater" cinema production studio. This is a standard mode, great for watching almost any type of movie.
	CINEMA STUDIO EX B DCS [C.ST.EX B]	Reproduces the sound characteristics of the Sony Pictures Entertainment "Kim Novak Theater" cinema production studio. This mode is ideal for watching science-fiction or action movies with lots of sound effects.
	CINEMA STUDIO EX C DCS [C.ST.EX C]	Reproduces the sound characteristics of the Sony Pictures Entertainment scoring stage. This mode is ideal for watching musicals or films where orchestra music is featured in the soundtrack.
Music	HALL [HALL]	Reproduces the acoustics of a classical concert hall.
	JAZZ CLUB [JAZZ]	Reproduces the acoustics of a jazz club.
	LIVE CONCERT [CONCERT]	Reproduces the acoustics of a 300-seat live house.
	STADIUM [STADIUM]	Reproduces the feeling of a large open-air stadium.
	SPORTS [SPORTS]	Reproduces the feeling of sports broadcasting.
	PORTABLE AUDIO ENHANCER [PORTABLE]	Reproduces a clear enhanced sound image from your portable audio device. This mode is ideal for MP3 and other compressed music.
Headphone*	HEADPHONE 2CH [HP 2CH]	This mode is selected automatically if you use headphones when 2 channel mode (page 60)/A.F.D. mode (page 57) is selected. Standard 2 channel stereo sources completely bypass the sound field processing and multi channel surround formats are downmixed to 2 channels.
	HEADPHONE DIRECT [HP DIR]	Outputs the analog signals without processing by the tone, sound field, etc.

* You can only select this sound field if the headphones are connected to the receiver.

Notes

- The effects provided by the virtual speakers may cause increased noise in the playback signal.
- When listening with sound fields that employ the virtual speakers, you will not be able to hear any sound coming directly from the surround speakers.
- This function does not work when:
 - ANALOG DIRECT is selected.
 - signals with a sampling frequency of more than 48 kHz is input.
 - the multi channel Linear PCM signals are received via an HDMI IN jack.
- When one of the sound fields for music is selected, no sound is output from the subwoofer if all the speakers are set to “LARGE” on the SYSTEM menu. However, the sound will be output from the subwoofer if
 - the digital input signal contains LFE signals.
 - the front and surround speakers are set to “SMALL”.
 - the sound field for movie is selected.

Tips

- You can identify the encoding format of DVD software, etc., by looking at the logo on the package.
- Sound fields with **DCS** mark use DCS technology. See “Glossary” (page 97).

To turn off the surround effect for movie/music

Press 2CH to select “2CH ST.” or press A.F.D. repeatedly to select “A.F.D. AUTO”.

Using only the front speakers (2CH STEREO)

In this mode, the receiver outputs the sound from the front left/right speakers only. There is no sound from the subwoofer. Standard 2 channel stereo sources completely bypass the sound field processing and multi channel surround formats are downmixed to 2 channel.

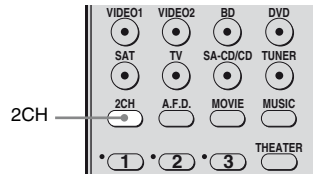

Press 2CH.

Note

No sound is output from the subwoofer in the 2CH STEREO mode. To listen to 2 channel stereo sources using the front left/right speakers and a subwoofer, select “A.F.D. AUTO” (page 57).

Listening to the sound without any adjustment (ANALOG DIRECT)

You can switch the audio of the selected input to two channel analog input. This function enables you to enjoy high quality analog sources.

When using this function, only the volume and front speaker balance can be adjusted.

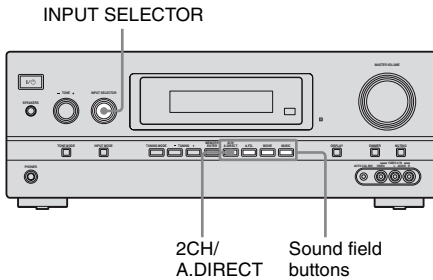

- 1 Turn INPUT SELECTOR on the receiver to select the input you want to listen to in analog audio.**

You can also use the input buttons on the remote.

- 2 Press 2CH/A.DIRECT repeatedly on the receiver to select "A.DIRECT".**

The analog audio is output.

To cancel ANALOG DIRECT

Press 2CH/A.DIRECT on the receiver again. You can also press any sound field buttons.

Notes

- When headphones are connected, "HP DIR" appears on the display.
- This function is not available when DMPort and DVD input is selected.

Resetting sound fields to the initial settings

Be sure to use the buttons on the receiver for this operation.

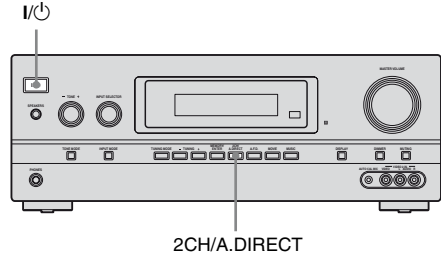

- 1 Press I/⏻ to turn off the power.**
- 2 While holding down 2CH/A.DIRECT, press I/⏻.**

"S.F. CLR." appears on the display and all sound fields are reset to their initial setting.

Tuner Operations

Listening to FM/AM radio

You can listen to FM and AM broadcasts through the built-in tuner. Before operation, make sure you have connected the FM and AM antennas (aerials) to the receiver (page 28).

Tip

The tuning scale for direct tuning differs depending on the area code as shown in the following table. For details on area codes, see page 4.

Area code	FM	AM
U, CA	100 kHz	10 kHz*

* The AM tuning scale can be changed (page 63).

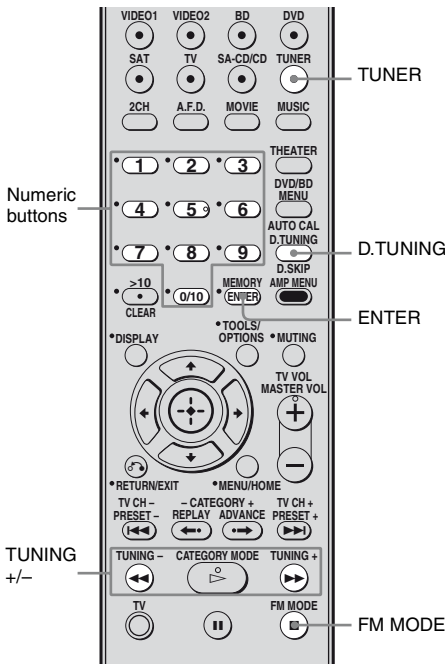

Tuning into a station automatically (Automatic Tuning)

- 1 Press **TUNER** repeatedly to select the FM or AM band.
- 2 Press **TUNING +** or **TUNING -**.
Press **TUNING +** to scan from low to high; press **TUNING -** to scan from high to low.
The receiver stops scanning whenever a station is received.

Using the controls on the receiver

- 1 Turn **INPUT SELECTOR** to select the FM or AM band.
- 2 Press **TUNING MODE** repeatedly to select "AUTO T".
- 3 Press **TUNING +** or **TUNING -**.

In case of poor FM stereo reception

If the FM stereo reception is poor and "ST" flashes on the display, select monaural audio so that the sound will be less distorted. Press **FM MODE** repeatedly until the "MONO" indicator lights up on the display. To return to stereo mode, press **FM MODE** repeatedly until the "MONO" indicator on the display does not light up.

Tuning into a station directly (Direct Tuning)

Enter the frequency of a station directly by using the numeric buttons.

1 Press TUNER repeatedly to select the FM or AM band.

You can also use INPUT SELECTOR on the receiver.

2 Press D.TUNING.

3 Press the numeric buttons to enter the frequency.

Example 1: FM 102.50 MHz

Select 1 → 0 → 2 → 5 → 0

Example 2: AM 1,350 kHz

Select 1 → 3 → 5 → 0

If you have tuned in an AM station, adjust the direction of the AM loop antenna (aerial) for optimum reception.

4 Press ENTER.

You can also use MEMORY/ENTER on the receiver.

If you cannot tune in a station

Make sure you have entered the right frequency. If not, repeat steps 2 to 4. If you still cannot tune in a station, the frequency is not used in your area.

Changing the AM tuning scale

(Models of area code U, CA only)

You can change the AM tuning scale to either 9 kHz or 10 kHz using the buttons on the receiver.

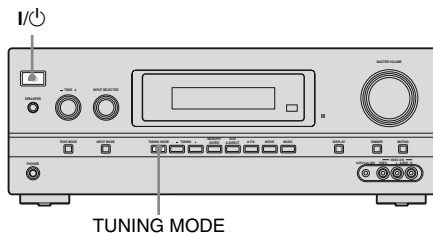

1 Press I/Power to turn off the receiver.

2 While holding down TUNING MODE, press I/Power.

3 Change the current AM tuning scale to 9 kHz (or 10 kHz).

To reset the scale to 10 kHz (or 9 kHz), repeat the procedure above.

Note

All preset stations will be erased when you change the tuning scale.

Presetting FM/AM radio stations

You can preset up to 30 FM stations and 30 AM stations. Then you can easily tune in the stations you often listen to.

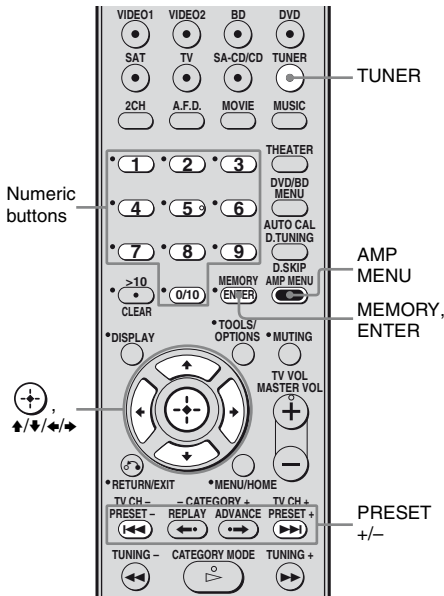

1 Press TUNER repeatedly to select the FM or AM band.

You can also use INPUT SELECTOR on the receiver.

2 Tune in the station that you want to preset using Automatic Tuning (page 62) or Direct Tuning (page 63).

In case of poor FM stereo reception, switch the FM reception mode (page 62).

3 Press MEMORY.

You can also use MEMORY/ENTER on the receiver.

“MEMORY” lights up for a few seconds. Perform steps 4 and 5 before “MEMORY” goes out.

4 Press the numeric buttons to select a preset number.

You can also press PRESET + or PRESET – to select a preset number. If “MEMORY” goes out before you select the preset number, start again from step 3.

5 Press ENTER.

You can also use MEMORY/ENTER on the receiver.

The station is stored as the selected preset number.

If “MEMORY” goes out before you press ENTER, start again from step 3.

6 Repeat steps 1 to 5 to preset another station.

Tuning to preset stations

- 1 Press **TUNER** repeatedly to select the FM or AM band.
- 2 Press **PRESET +** or **PRESET -** repeatedly to select the preset station you want.

Each time you press the button, you can select a preset station as follows:

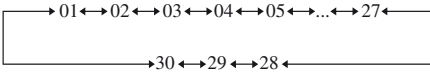

You can also press the numeric buttons to select the preset station you want. Then, press **ENTER** to enter the selection.

Using the controls on the receiver

- 1 Turn **INPUT SELECTOR** to select the FM or AM band.
- 2 Press **TUNING MODE** repeatedly to select “PRESET T”.
- 3 Press **TUNING +** or **TUNING -** to select the preset station you want.

Naming preset stations

- 1 Press **TUNER** repeatedly to select the FM or AM band.
You can also use **INPUT SELECTOR** on the receiver.
- 2 Tune in the preset station you want to create an index name for (page 65).
- 3 Press **AMP MENU**.
“1-LEVEL” appears on the display.
- 4 Press **▲/▼** repeatedly to select “4-TUNER”.
- 5 Press **⊕** or **▶** to enter the menu.
- 6 Press **▲/▼** repeatedly to select “NAME IN”.
- 7 Press **⊕** or **▶** to enter the parameter.
The cursor flashes and you can select a character.
- 8 Press **▲/▼** to select a character, then press **◀/▶** to move the cursor to the next position.

If you made a mistake

Press **◀/▶** until the character you want to change flashes, then press **▲/▼** to select the correct character.

Tips

- You can select the character type as follows by pressing **▲/▼**.
Alphabet (upper case) → Numbers → Symbols
- To enter a blank space, press **▶** without selecting a character.

- 9 Press **⊕**.

The name you entered is registered.

Listening to Satellite Radio

To listen to Satellite Radio, you'll need to connect a SIRIUS Satellite Radio tuner (sold separately) to your Sirius-Ready receiver. SIRIUS Satellite Radio is available to residents of the US (except Alaska and Hawaii) and Canada.

Satellite Radio delivers a variety of commercial-free music from categories ranging from Pop, Rock, Country, R&B, Dance, Jazz, Classical and many more plus coverage of all the top professional and college sports including play by play games from select leagues and teams. Additional programming includes expert sports talk, uncensored entertainment, comedy, family programming, local traffic and weather and news from your most trusted sources.

Once you've purchased a SIRIUS tuner you'll need to activate it and subscribe to begin enjoying the service. Easy to follow installation and setup instructions are provided with the SIRIUS tuner. There are a variety of programming packages available, including the option of adding "The Best of XM" programming to the SIRIUS service. The "Best of XM" service is not available to SIRIUS Canada subscribers at this time. Please check with SIRIUS Canada for any updates using the numbers and web address below.

Family friendly packages are also available to restrict channels featuring content that may be inappropriate for children.

To subscribe to SIRIUS, U.S. and Canadian customers can call 1-888-539-SIRI (1-888-539-7474) or visit sirius.com (US) or siriuscanada.ca (Canada).

SIRIUS and all related marks and logos are trademarks of Sirius XM Radio Inc. and its subsidiaries. All other marks and logos are the property of their respective owners. All rights reserved. SIRIUS subscription sold separately. Taxes and a one-time activation fee may apply. SIRIUS tuner required (sold separately) to receive the SIRIUS service. All programming and fees subject to change. It is prohibited to copy, decompile, disassemble, reverse engineer, hack, manipulate or otherwise make available any technology or software incorporated in receivers compatible with the SIRIUS Satellite Radio System. **Service not available in Alaska or Hawaii.**

Connecting the SIRIUS Satellite Radio

Connect the SiriusConnect Home tuner. When you use the SiriusConnect Home tuner with this receiver, be sure to connect the AC power adaptor supplied with the tuner to a wall outlet.

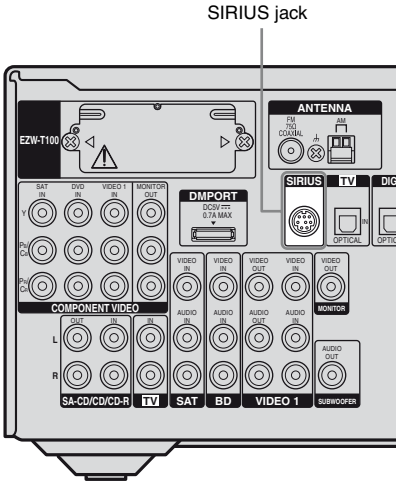

Note

Keep the SiriusConnect Home tuner, antenna, and AC power adaptor away from the speaker cords and the power cord to avoid picking up noise.

Preparing to listen to the SIRIUS Satellite Radio

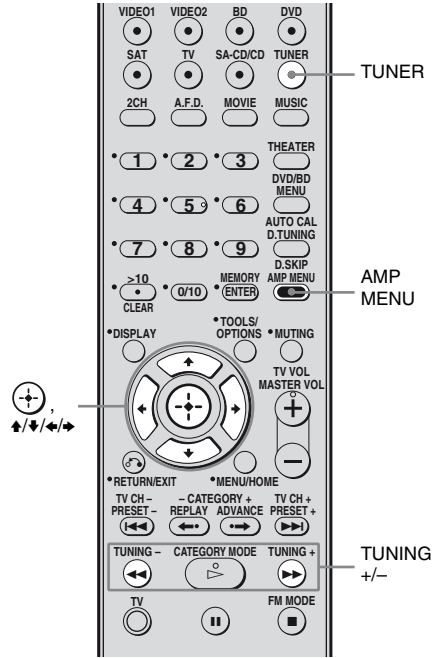

Checking the SIRIUS Radio ID

- 1** Press **TUNER** repeatedly to select "SIRIUS".
- 2** Press **AMP MENU**.
"1-LEVEL" appears on the display.
- 3** Press **↑/↓** repeatedly to select "4-TUNER".
- 4** Press **⊕** or **→** to enter the menu.
- 5** Press **↑/↓** repeatedly to select "SR ID".
- 6** Press **⊕** or **→**.
The first 6 digits appear on the display.

continued

7 Press →.

The last 6 digits appear on the display.

8 Check the SIRIUS ID on the display and write it in the space provided here.

SIRIUS ID: _____

Using the controls on the receiver

- 1 Turn INPUT SELECTOR to select “SIRIUS”.
- 2 Press TUNING MODE repeatedly to select “AUTO T.”, and then press TUNING + or TUNING – to select channel 0.
- 3 Check the SIRIUS ID on the display and write it in the space provided here.
SIRIUS ID: _____

Checking receiving conditions (SIRIUS Antenna Aiming)

- 1 Press TUNER repeatedly to select “SIRIUS”.
You can also use INPUT SELECTOR on the receiver.
- 2 Press AMP MENU.
“1-LEVEL” appears on the display.
- 3 Press ▲/▼ repeatedly to select “4-TUNER”.
- 4 Press ⊕ or → to enter the menu.
- 5 Press ▲/▼ repeatedly to select “SR ANT”.
- 6 Press ⊕ or → to enter the parameter.

7 While checking the parameter, aim your antenna to where the best reception will be received.

For details on the parameter, see “SIRIUS Signal strength” below.

SIRIUS Signal strength

Signal strength	Signal type	
	Satellite	Terrestrial
EXC (excellent)	S : 3	T : 3
GOOD	S : 2	T : 2
WEAK	S : 1	T : 1
NONE	S : 0	T : 0

When you have finished

Press AMP MENU.

Receiving SIRIUS Satellite Radio broadcasts

- 1 Press TUNER repeatedly to select “SIRIUS”.
You can also use INPUT SELECTOR on the receiver.
- 2 Press TUNING + or TUNING – to select a channel.
You can also press TUNING MODE on the receiver to select “AUTO T.”, and then press TUNING + or TUNING – to select a channel.

Selecting a channel of the SIRIUS Satellite Radio

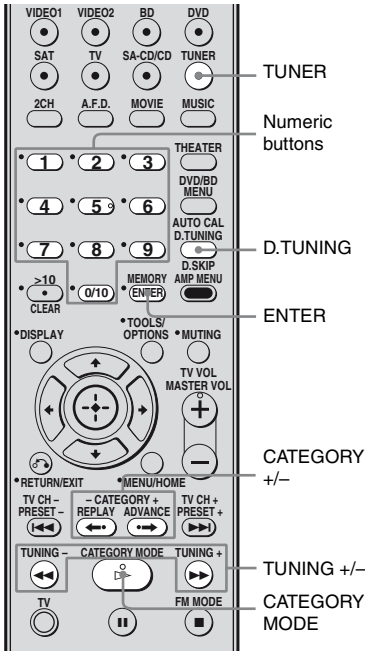

Selecting channels from a category (CATEGORY TUNING)

You can select a channel from one category or all the categories by changing the category mode.

1 Press TUNER repeatedly to select “SIRIUS”.

You can also use INPUT SELECTOR on the receiver.

2 Press CATEGORY MODE repeatedly to select the “ONE CAT”.

- ALL CAT: You can select a channel from all the categories. The initial setting is “ALL CAT”.
- ONE CAT: You can select a channel from one category. “CAT” is displayed on the display when you set to “ONE CAT” mode.

3 Press CATEGORY + or CATEGORY – to select the category you want.

The category is selected and the channel with the lowest number in the specified category is selected.

4 Press TUNING + or TUNING – to select the channel.

You can also press TUNING MODE on the receiver to select “AUTO T.”, and then press TUNING + or TUNING – to select a channel.

Notes

- When you select a channel in the “ONE CAT” mode, the channel you selected may not be the one in the category you want. This is because one channel may belong to more than one category.
- If you press CATEGORY + or CATEGORY – in the “ALL CAT” mode, the first channel of the next or previous category is selected (CATEGORY SKIP).

Selecting channels by inputting the channel number directly (DIRECT TUNING)

- 1 Press TUNER repeatedly to select “SIRIUS”.**
You can also use INPUT SELECTOR on the receiver.
- 2 Press D.TUNING.**
- 3 Press the numeric buttons to enter the channel number.**
- 4 Press ENTER.**
You can also use MEMORY/ENTER on the receiver.
The selected channel is tune in.

Displaying the SIRIUS Satellite Radio information on the front panel display

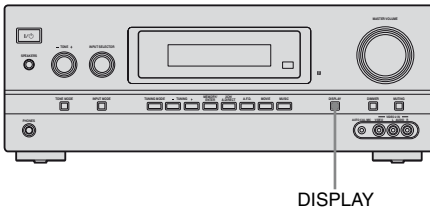

Press DISPLAY on the receiver repeatedly.

Each time you press DISPLAY while tuning in the channel, the display changes cyclically as follows:

- Channel name → Channel number →
- Category name → Artist name/Feature →
- Song/Program title → Composer name →
- Signal strength → Sound field type

Presetting SIRIUS Satellite Radio channels

You can select the channels you want directly by presetting them using the preset numbers. You can preset up to 30 SIRIUS Satellite Radio channels.

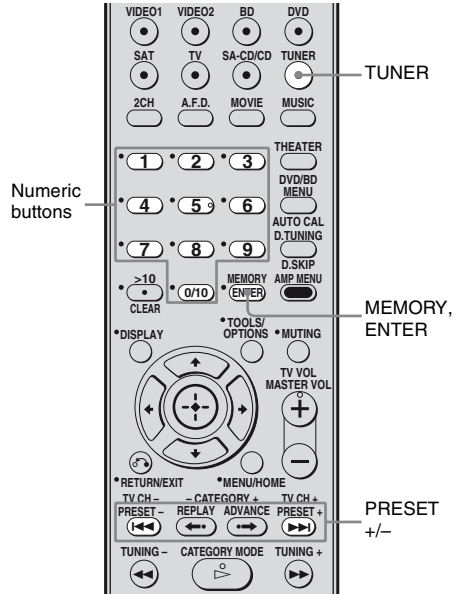

Presetting channels using the preset numbers

- 1 Press TUNER repeatedly to select “SIRIUS”.**
You can also use INPUT SELECTOR on the receiver.
- 2 Select a channel you want to preset using Category Tuning (page 69) or Direct Tuning (page 70).**

3 Press MEMORY.

You can also use MEMORY/ENTER on the receiver.

4 Press the numeric buttons to select a preset number you want to use as the preset channel.

You can also select the number by pressing PRESET + or PRESET -. You can also press TUNING + or TUNING - on the receiver.

Preset channels from 1 to 30 are available, and channel 184 is preset for all the preset channels when you purchase the receiver.

5 Press ENTER.

You can also use MEMORY/ENTER on the receiver.

The selected channel is registered as the preset channel you selected in step 1.

6 Repeat steps 2 to 5 to preset another channel.

You can store channels from 1 to 30.

Selecting the channel by using the preset numbers

1 Press TUNER repeatedly to select "SIRIUS".

You can also use INPUT SELECTOR on the receiver.

2 Press PRESET + or PRESET - repeatedly to select the preset channel you want.

You can also press the numeric buttons to select the preset channel you want. Then press ENTER to enter the selection.

You can also press TUNING MODE on the receiver to select "PRESET T.", and then press TUNING + or TUNING -.

You can select preset channels from 1 to 30.

Note

The channel information you have preset may be changed if Sirius XM Radio Inc. change their channel programming.

Restricting access to specific channels (Parental Lock) (SIRIUS only)

You can restrict access to certain channels using your own lock code. The lock code is set to “0000” as the default.

Change the lock code before you use this function for the first time. See “To change the lock code (Lock Code)” (page 72).

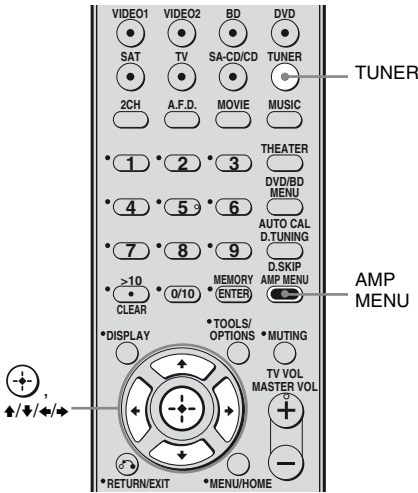

1 Press TUNER repeatedly to select “SIRIUS”.

You can also use INPUT SELECTOR on the receiver.

2 Select a channel you want to lock using Category Tuning (page 69) or Direct Tuning (page 70).

3 Press AMP MENU.

“1-LEVEL” appears on the display.

4 Press \uparrow/\downarrow repeatedly to select “4-TUNER”.

5 Press \oplus or \rightarrow to enter the menu.

6 Press \uparrow/\downarrow repeatedly to select “PARENTAL”.

7 Press \oplus or \rightarrow to enter the parameter.

8 Press \uparrow/\downarrow repeatedly to select “ON”, then press \oplus .

“LOCK” appears on the display.

9 Enter your 4-digit lock code using the numeric buttons.

“LOCKED” appears on the display and the Parental Lock is set.

To delete the numbers you have entered, repeat the procedure above from step 3. Select “OFF” in step 8.

To change the lock code (Lock Code)

1 Press TUNER repeatedly to select “SIRIUS”.

You can also use INPUT SELECTOR on the receiver.

2 Press AMP MENU.

“1-LEVEL” appears on the display.

3 Press \uparrow/\downarrow repeatedly to select “4-TUNER”.

4 Press \oplus or \rightarrow to enter the menu.

5 Press \uparrow/\downarrow repeatedly to select “CODE EDT.”.

6 Press \oplus or \rightarrow to enter the parameter. “CODE” appears on the display.

7 Enter your 4-digit lock code using the numeric buttons. “NEW” appears on the display.

8 Enter a new 4-digit lock code using the numeric buttons.

“CONF.” appears on the display.

- 9** Reenter the new lock code with the numeric buttons.
“CHANGED” appears on the display.

To listen to the locked channels

- 1** Press TUNER repeatedly to select “SIRIUS”.
You can also use INPUT SELECTOR on the receiver.
- 2** Select a locked channel you want to listen using Direct Tuning (page 70).
“LOCKED” appears on the display.
- 3** Enter your 4-digit lock code using the numeric buttons.
The channel is tuned in.

To cancel the Parental Lock

- 1** Press TUNER repeatedly to select “SIRIUS”.
You can also use INPUT SELECTOR on the receiver.
- 2** Select a channel you want to unlock using Direct Tuning (page 70).
“LOCKED” appears on the display.
- 3** Enter your 4-digit lock code using the numeric buttons.
The channel is tuned in.
- 4** Press AMP MENU.
“1-LEVEL” appears on the display.
- 5** Press $\blacktriangle/\blacktriangledown$ repeatedly to select “4-TUNER”.
- 6** Press \odot or \blacktriangleright to enter the menu.
- 7** Press $\blacktriangle/\blacktriangledown$ repeatedly to select “PARENTAL”.
- 8** Press \odot or \blacktriangleright to enter the parameter.
- 9** Press $\blacktriangle/\blacktriangledown$ repeatedly to select “OFF”, then press \odot .
“LOCK” appears on the display.

- 10** Enter your 4-digit lock code using the numeric buttons.
“UNLOCKED” appears on the display.

Notes

- When you select a channel using Category Tuning, locked channels are skipped.
- When the receiver is reset to the factory settings, the lock code returns to the default (0000), but the Parental Lock settings are not removed.
- You cannot preset locked channels. If you set the Parental Lock for a preset channel, the preset information for that channel returns to the default.
- You cannot set the Parental Lock for channel 0 or channel 184.

SIRIUS Satellite Radio message list

Message appears	Explanation	Remedies
ANTENNA ERROR*	The antenna is not connected properly.	Check the connection between the SiriusConnect Home tuner and the antenna.
LINKING	The receiving condition is not good.	Try moving the antenna to another location. For details about the antenna location, see the instructions supplied with the SiriusConnect Home tuner.
CALL 888 539-SIRI**	You have not subscribed for the selected channel.	—
SR TUNER	The SiriusConnect Home tuner is not connected properly.	Check all the connections, and then turn the system on again. Also make sure if the AC adaptor supplied with the SiriusConnect Home tuner is connected to a wall socket.
INVALID	You have entered an invalid channel number.	The channel to be tuned-in is void due to the change by the broadcast service, or the receiving condition is not good.
LOCKED	The selected channel is locked.	—
SUB UPDT	The subscription information has been updated.	—
UPDATING	Channel information is being updated.	—
FW UPDT	The SiriusConnect Home tuner firmware is being updated.	—
----	There is no text information in the channel.	This is not an error. The text information may not be displayed depending on the system condition, for example, right after the system has received a channel.

* “ANTENNA” and “ERROR” appears on the display alternately.

** “CALL 888” and “539-SIRI” appears on the display alternately.

What is “BRAVIA” Sync?

“BRAVIA” Sync is compatible with a Sony TV, Blu-ray Disc/DVD player, AV amplifier, etc., that is equipped with the Control for HDMI function.

By connecting Sony components that are compatible with the “BRAVIA” Sync with an HDMI cable (not supplied), operation is simplified as follows:

- **One-Touch Play:** When you play back a component such as a DVD/Blu-ray disc player, the receiver and the TV will switch to the appropriate HDMI input automatically. In case the receiver or/and the TV is in standby mode, they will be turned on automatically.
- **System Audio Control:** While watching TV, you can select to output the sound from the TV speaker or the speakers connected to the receiver.
- **System Power Off:** When you turn off the TV, the receiver and connected components are also turned off simultaneously.

Control for HDMI is a mutual control function standard used by HDMI CEC (Consumer Electronics Control) for HDMI (High-Definition Multimedia Interface).

The Control for HDMI function does not work in the following cases:

- When you connect the receiver to a component which does not correspond with Sony Control for HDMI function.
- When you connect the receiver and components using other than HDMI connection.

We recommend that you connect the receiver to products featuring “BRAVIA” Sync.

Note

Depending on the connected component, the Control for HDMI function may not work. Refer to the operating instructions of the component.

Preparing for the “BRAVIA” Sync

To use the “BRAVIA” Sync, turn the Control for HDMI function on for both the receiver and the connected component. The receiver is compatible with the “Control for HDMI-Easy Setting” function.

When your TV is compatible with the “Control for HDMI-Easy Setting” function

When you connect a Sony TV with the “Control for HDMI-Easy Setting” function, the Control for HDMI function of the receiver can be turned on simultaneously by turning the Control for HDMI function of the TV on.

- 1 Make sure that the receiver, TV, and playback components are connected using an HDMI cable (not supplied). (The respective components must be compatible with the Control for HDMI function.)
- 2 Turn on the receiver, TV and playback components.
- 3 Turn the Control for HDMI function of the TV on.
The Control for HDMI function of the receiver and all the connected components are simultaneously turned on. During setup, “CONTROL”, “SCAN FOR” and “HDMI” appear sequentially in the display, and once setting is completed, “COMPLETE” will appear. Wait until the setup is complete.

For details on setting the TV, refer to the operating instructions supplied with the TV.

When your TV is not compatible with the “Control for HDMI-Easy Setting” function

Turn the Control for HDMI function of the receiver and the connected component on individually.

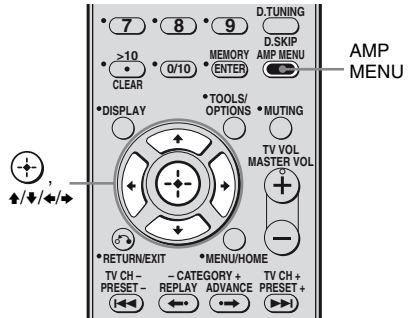

- 1 Perform the steps given in “When your TV is compatible with the “Control for HDMI-Easy Setting” function” (page 76).
- 2 Press AMP MENU.
“1-LEVEL” appears on the display.
- 3 Press \uparrow/\downarrow repeatedly to select “6-HDMI”.
- 4 Press \oplus or \rightarrow to enter the menu.
- 5 Press \uparrow/\downarrow repeatedly to select “CONTROL FOR HDMI”.
“CONTROL FOR HDMI” scrolls across the display, then “CONTROL” appears.
- 6 Press \oplus or \rightarrow to enter the parameter.
- 7 Press \uparrow/\downarrow repeatedly to select “CTRL ON”.
Control for HDMI function is activated.
- 8 Select the HDMI input of the receiver and TV to match the HDMI input of the connected component, so that the image from the connected component is displayed.

- 9** Set the Control for HDMI function for the connected component to on.
If the Control for HDMI function for the connected component is already set to on, you do not need to change the setting.

- 10** Repeat step 8 and 9 for other components that you want to use the Control for HDMI function.

For details on setting the TV and connected components, refer to the operating instructions of the respective components.

Notes

- When you unplug the HDMI cable or change the connection, perform the steps given in “When your TV is compatible with the “Control for HDMI-Easy Setting” function” (page 76) or “When your TV is not compatible with the “Control for HDMI-Easy Setting” function” (page 76).
- You cannot perform One-Touch Play and System Audio Control during Control for HDMI-Easy Setting operation.
- Before you do the Control for HDMI-Easy Setting from the TV, be sure to turn on the TV, connected components and receiver.
- If the playback components cannot function after you have made the settings for Control for HDMI-Easy Setting, check the Control for HDMI setting on your TV.
- If the connected components do not support Control for HDMI-Easy Setting, you need to set the Control for HDMI function for the connected components to on before you perform the Control for HDMI-Easy Setting from the TV.

Watching a DVD (One-Touch Play)

You can enjoy sound and image from the components connected to the receiver via HDMI connections by a simple operation.

Play back a connected component.

The receiver and the TV will switch to the appropriate HDMI input automatically.

In case the receiver or/and the TV is in standby mode, they will be turned on automatically.

Watching a DVD/Blu-ray disc by simple operation

You can also select a connected component, such as a DVD/Blu-ray disc player using the TV menu. In this case, the receiver and the TV switch to the appropriate HDMI input.

Note

Depending on the TV, the start of the content may not be output.

Enjoying the TV sound from the speakers connected to the receiver (System Audio Control)

You can enjoy the TV sound from the speakers connected to the receiver by a simple operation.

You can operate System Audio Control function using the TV menu. For details, refer to the operating instructions of the TV. When System Audio Control function is turned on, the receiver will turn on and switches to the appropriate input automatically.

TV sound is output from the speakers connected to the receiver, and the volume of the TV is minimized simultaneously.

You can also use the System Audio Control function as follows.

- If you turn on the receiver while the TV is turned on, the System Audio Control function will automatically be set to on and the TV sound will output from the speakers connected to the receiver. However, if you turn off the receiver, the sound will output from the TV speakers.
- You can adjust the receiver's volume when you adjust the TV volume.

Notes

- If System Audio Control does not function according to your TV setting, refer to the operating instructions of the TV.
- When "CONTROL FOR HDMI" is set to "CTRL ON", the "AUDIO FOR HDMI" settings in the HDMI menu will set automatically depending on the System Audio Control settings.
- When you connect a TV that does not have System Audio Control function, the System Audio Control function does not work.
- If the TV is turned on before turning on the receiver, the TV sound will not be output for a moment.
- When you switch to an input other than HDMI or TV, the System Audio Control function will automatically be set to off.

Turning off the receiver with the TV

(System Power Off)

When you turn the TV off by using the POWER button on the TV’s remote, the receiver and the connected components turn off automatically.

You can also use the receiver’s remote to turn off the TV.

Notes

- Set the TV Standby Synchro to “ON” before using the System Power Off function. For details, refer to the operating instructions of the TV.
- Depending on the status, the connected components may not be turned off. For details, refer to the operating instructions of the connected components.

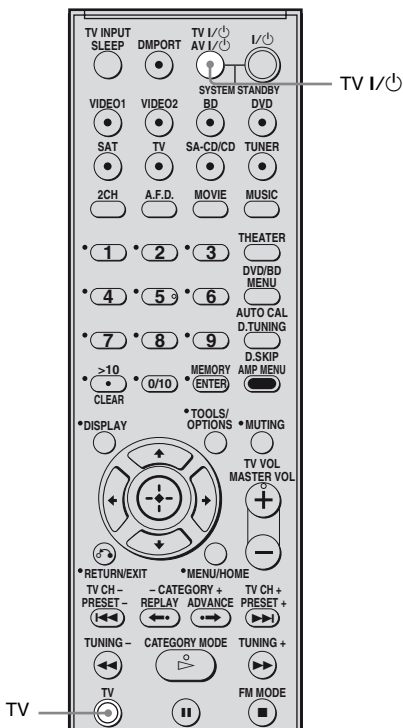

Press TV and TV I/TV I at the same time.

The TV, receiver and the components connected via HDMI are turned off.

S-AIR Operations

About S-AIR products

This receiver is compatible with the S-AIR function (page 98), which allows wireless sound transmission between S-AIR products. When you purchase the S-AIR product, you need to establish sound transmission (page 81).

There are two types of S-AIR product.

- S-AIR main unit (this receiver):
The S-AIR main unit is for transmitting sound.
You can use up to 3 S-AIR main units. (The number of usable S-AIR main unit depends on the use environment.)
- S-AIR sub unit (not supplied): The S-AIR sub unit is for receiving sound.
 - Surround amplifier: You can enjoy surround and surround back speakers sound wirelessly. For details, refer to the operating instruction supplied with the surround amplifier.
 - S-AIR receiver: You can enjoy system sound in another room.

These S-AIR products can be purchased as an option (the S-AIR product lineup differs depending on the area).

Notes or instructions for the surround amplifier or S-AIR receiver in this operating instructions is refer only when the surround amplifier or S-AIR receiver is used.

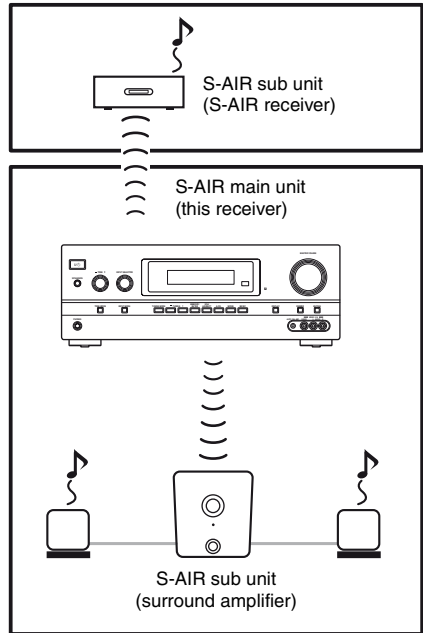

Setting up an S-AIR product

Before using an S-AIR product, be sure to perform the following settings to establish the sound transmission.

Inserting the wireless transmitter/transceiver

To make use of the S-AIR function, you need to insert the wireless transmitter (not supplied) into the S-AIR main unit and the wireless transceiver (not supplied) into the S-AIR sub unit.

Notes

- Before inserting the wireless transmitter/transceiver, be sure to disconnect the AC power cord (mains lead).
- Do not touch the terminals of the wireless transmitter/transceiver.

To insert the wireless transmitter into the S-AIR main unit

- 1 Remove the screws and detach the slot cover.

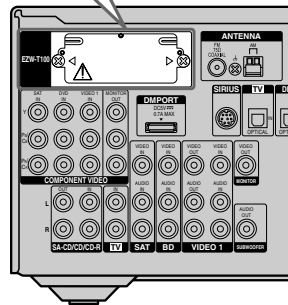
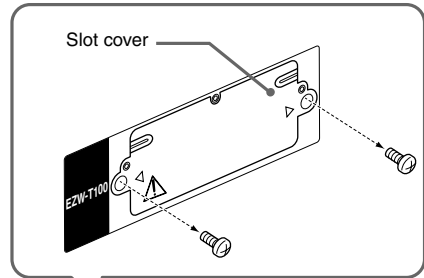

Notes

- Remove the screws from the slot cover bearing the caution mark. Do not remove other screws.
- The slot cover is no longer necessary. However, keep it after detaching.

- 2 Insert the wireless transmitter.

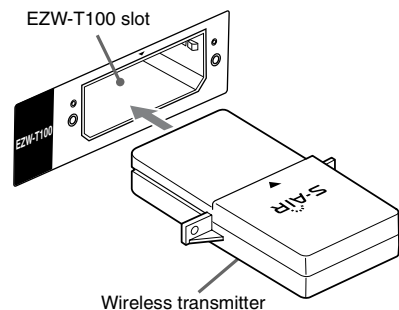

Notes

- Insert the wireless transmitter with the S-AIR logo facing up.
- Insert the wireless transmitter so that the ▼ marks are aligned.
- Do not insert other than the wireless transmitter into the EZW-T100 slot.

- 3** Use the screws that you removed from step 1 to fasten the wireless transmitter.

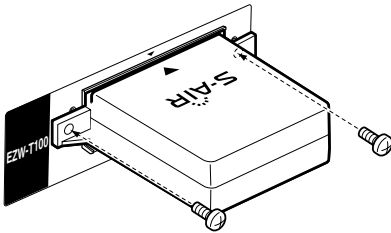

Note

Do not use other screws to fasten the wireless transmitter.

To insert the wireless transceiver into the S-AIR sub unit

For details on installing the wireless transceiver into surround amplifier and S-AIR receiver, refer to the operating instructions supplied with the surround amplifier and S-AIR receiver.

Establishing sound transmission between the S-AIR main unit and S-AIR sub unit (ID setting)

When you match the ID of the S-AIR main unit and the S-AIR sub unit, you can establish sound transmission. You can use multiple S-AIR main unit by setting a different ID for each unit.

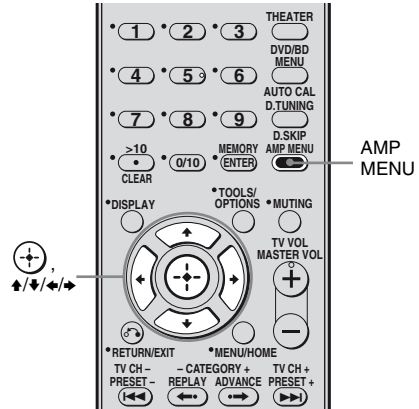

To set the ID of the S-AIR main unit

- 1** Press AMP MENU.
“1-LEVEL” appears on the display.
- 2** Press ▲/▼ repeatedly to select “9- S-AIR”.
- 3** Press ⊕ or ► to enter the menu.
- 4** Press ▲/▼ repeatedly to select “ID SETUP”.
- 5** Press ⊕ or ► to enter the parameter.
- 6** Press ▲/▼ repeatedly to select the ID (A, B or C) you want, then press ⊕.

To exit the menu

Press AMP MENU.

To set the ID of the S-AIR sub unit

Be sure to match the ID on S-AIR sub unit you want to the S-AIR main unit.

For details on setting the ID of the surround amplifier and S-AIR receiver, refer to the operating instructions supplied with the surround amplifier and S-AIR receiver.

Sound transmission is established as follows (example):

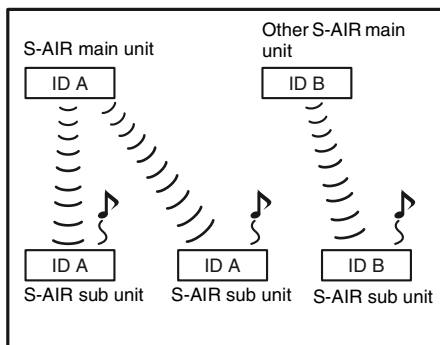

Notes

- Sources with copyright protection may not be playable on S-AIR sub unit.
- When sound transmission is established
 - sound can only be output from the S-AIR receiver if you connect the components to this receiver via the analog jacks. The sound cannot be output if the components are connected to the COAXIAL, OPTICAL or HDMI jacks on this receiver.
 - the headphones function on the surround amplifier is not available.

Pairing the S-AIR main unit with a specific S-AIR sub unit (Pairing operation)

To establish sound transmission, you need to set the same ID for your S-AIR main unit and S-AIR sub unit.

However, if your neighbors have S-AIR products and their IDs are the same as yours, your neighbors could receive the sound of your S-AIR main unit or vice versa.

To prevent this, you can pair the S-AIR main unit with a specific S-AIR sub unit by performing the pairing operation.

■ Before pairing

Sound transmission is established by the ID (example).

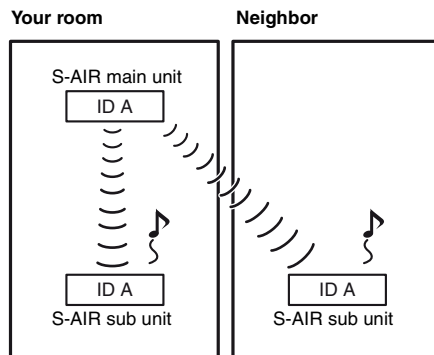

■ After pairing

Sound transmission is established between the paired S-AIR main unit and S-AIR sub unit(s) only.

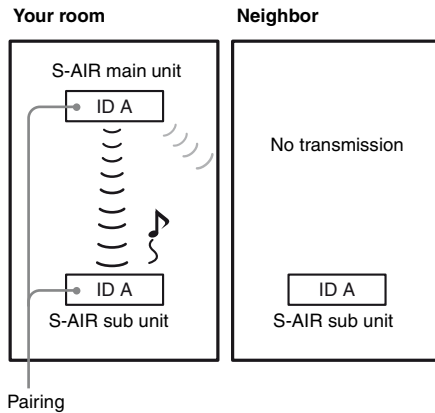

1 Place the S-AIR sub unit that you want to pair near the S-AIR main unit.

2 Match the IDs of the S-AIR main unit and the S-AIR sub unit.

- To set the ID of the S-AIR main unit, see “To set the ID of the S-AIR main unit” (page 82).
- To set the ID of the S-AIR sub unit, refer to the operating instructions supplied with the S-AIR sub unit.

3 Press AMP MENU.

“1-LEVEL” appears on the display.

4 Press \uparrow/\downarrow repeatedly to select “9- S-AIR”.

5 Press \oplus or \rightarrow to enter the menu.

6 Press \uparrow/\downarrow repeatedly to select “PAIRING”.

7 Press \oplus or \rightarrow to enter the parameter.

8 Press \uparrow/\downarrow repeatedly to select the setting you want, then press \oplus .

- **START:** The S-AIR main unit starts pairing. “SEARCH” flashes on the display.
- **STATUS:** You can check the current ID. When the pairing setting is not made, “NO PAIR” appears on the display.

9 Start pairing of the S-AIR sub unit.

■ For the surround amplifier
Refer to the operating instructions supplied with the surround amplifier.

■ For the S-AIR receiver
Refer to the operating instructions supplied with the S-AIR receiver.

10 Pairing completed.

“COMPLETE” appears on the display.

To exit the menu

Press AMP MENU.

Note

Perform the pairing within several minutes after step 8. Otherwise, the pairing is canceled automatically and “ERROR” appears on the display.

To cancel pairing

Reset the ID of the S-AIR main unit.

For details, see “To set the ID of the S-AIR main unit” (page 82). You can select the same ID as before.

Enjoying the system's sound in another room

(For the S-AIR receiver only (not supplied))

You can enjoy the system's sound in another room by using the S-AIR receiver. The S-AIR receiver can be installed anywhere, regardless of the location of the S-AIR main unit.

For details of the S-AIR receiver, refer to the operating instructions supplied with the S-AIR receiver.

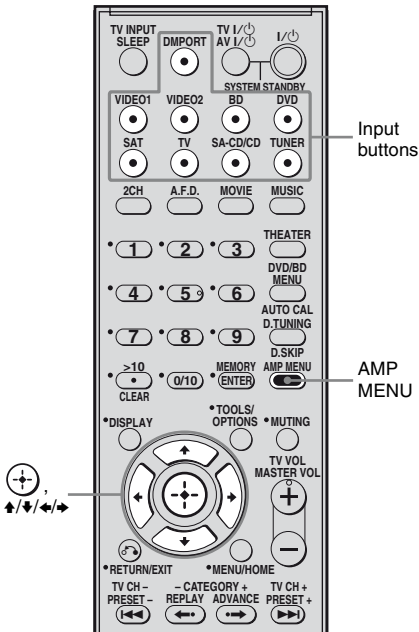

1 Set the ID of the S-AIR receiver to match the ID of the S-AIR main unit.

- To set the ID of the S-AIR main unit, see “To set the ID of the S-AIR main unit” (page 82).
- To set the ID of the S-AIR receiver, refer to the operating instructions supplied with the S-AIR receiver.

Notes

- When you are using another S-AIR sub unit, such as a surround amplifier, do not change the ID of the S-AIR main unit. Set the ID of the S-AIR receiver to match the ID of the S-AIR main unit.
- When you pair the S-AIR main unit and another S-AIR sub unit, such as a surround amplifier, you also need to pair the S-AIR main unit and the S-AIR receiver. For details, see “Pairing the S-AIR main unit with a specific S-AIR sub unit (Pairing operation)” (page 83).

2 Press AMP MENU.

“1-LEVEL” appears on the display.

3 Press \uparrow/\downarrow repeatedly to select “9- S-AIR”.

4 Press \oplus or \rightarrow to enter the menu.

5 Press \uparrow/\downarrow repeatedly to select “MODE”.

6 Press \oplus or \rightarrow to enter the parameter.

7 Press \uparrow/\downarrow repeatedly to select the setting you want.

- PARTY: The S-AIR receiver outputs sound according to the input selected on the S-AIR main unit. However, if DVD is selected on S-AIR main unit, S-AIR receiver remains as the last selected input.
- SEPARATE: You can select the input you want for the S-AIR receiver while the input of the S-AIR main unit remain unchanged.

Note

When TUNER (FM/AM band) is selected on the S-AIR main unit, you can only select the same band for the tuner on the S-AIR receiver. However, you can select input other than TUNER on the S-AIR receiver.

8 Adjust the volume on the S-AIR receiver.

Note

The sound of the S-AIR receiver may be cut off by operation of the S-AIR main unit.

Changing the channel for better sound transmission

If you use multiple wireless systems which sharing the 2.4 GHz band, such as wireless LAN or Bluetooth, the transmission of S-AIR products or other wireless systems may be unstable. In this case, you may improve the transmission by changing the “RF SETUP” setting.

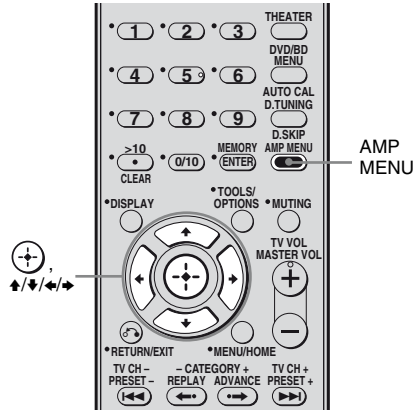

- 1 Press AMP MENU.**
“1-LEVEL” appears on the display.
- 2 Press \uparrow/\downarrow repeatedly to select “9- S-AIR”.**
- 3 Press \oplus or \rightarrow to enter the menu.**
- 4 Press \uparrow/\downarrow repeatedly to select “RF SETUP”.**
- 5 Press \oplus or \rightarrow to enter the parameter.**

6 Press \uparrow/\downarrow repeatedly to select the setting you want.

- RF AUTO: Normally select this. The system changes “RF SETUP” to “RF ON” or “RF OFF” automatically.
- RF ON: The system transmits sound by searching the better channel for transmitting.
- RF OFF: The system transmits sound by fixing the channel for transmitting.

To exit the menu

Press AMP MENU.

Notes

- When the wireless transmitter is not inserted in the S-AIR main unit, you cannot set “RF SETUP”.
- In most cases, you will not need to change this setting.
- If “RF SETUP” is set to “RF OFF,” transmission between the S-AIR main unit and S-AIR sub unit can be performed using one of the following channels.
 - S-AIR ID A: equivalent channel for Wi-Fi channel 1
 - S-AIR ID B: equivalent channel for Wi-Fi channel 6
 - S-AIR ID C: equivalent channel for Wi-Fi channel 11
- The transmission may be improved by changing the transmission channel (frequency) of the other wireless system(s). For details, refer to the operating instructions of the other wireless system(s).

Enjoying the S-AIR receiver while the S-AIR main unit is in standby mode

(For the S-AIR receiver only (not supplied))

You can enjoy the S-AIR receiver while the S-AIR main unit is in standby mode by setting “STANDBY” to “STBY ON”.

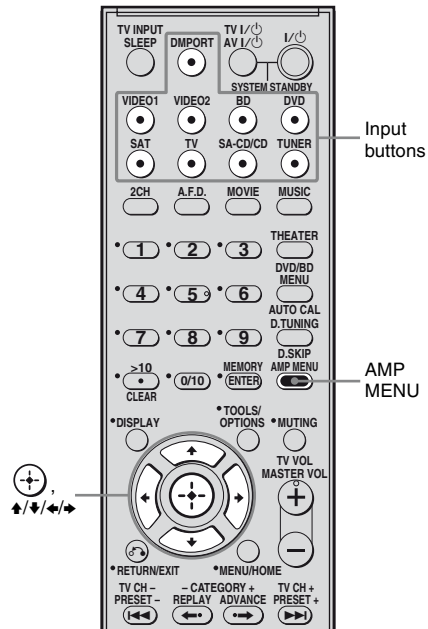

- 1 Press AMP MENU.
“1-LEVEL” appears on the display.
- 2 Press \uparrow/\downarrow repeatedly to select “9- S-AIR”.
- 3 Press \odot or \rightarrow to enter the menu.
- 4 Press \uparrow/\downarrow repeatedly to select “STANDBY”.

continued

5 Press **⊕** or **➔** to enter the parameter.

6 Press **⬆**/**⬇** repeatedly to select the setting you want.

- **STBY OFF:** You cannot enjoy the S-AIR receiver while the S-AIR main unit is in standby mode.
- **STBY ON:** You can enjoy the S-AIR receiver while the S-AIR main unit is in standby mode or turned on.

To exit the menu

Press AMP MENU.

Notes

- When you set “STANDBY” to “STBY ON”, the power consumption increases during the standby mode.
- When the wireless transmitter is not inserted in the S-AIR main unit, you cannot set “STANDBY”.
- When the wireless transmitter is removed from the S-AIR main unit, “STANDBY” is set to “STBY OFF” automatically.
- If you have selected TUNER (FM/AM band) on the S-AIR main unit before you turn it off and “STANDBY” is set to “STBY ON”, you can only select the same band for the tuner on the S-AIR receiver. However, you can select input other than TUNER on the S-AIR receiver.
- The sound of the S-AIR receiver may be cut off by operation of the S-AIR main unit.

Other Operations

Switching between digital and analog audio (INPUT MODE)

When you connect components to both digital and analog audio input jacks on the receiver, you can fix the audio input mode to either of them, or switch from one to the other, depending on the type of material you intend to watch.

1 Turn **INPUT SELECTOR** on the receiver to select the input.

You can also use the input buttons on the remote.

2 Press **INPUT MODE** repeatedly on the receiver to select the audio input mode.

The selected audio input mode appears on the display.

Audio input modes

• **AUTO**

Gives priority to digital audio signals when there are both digital and analog connections.

If there are more than one digital connection, HDMI audio signals have priority over COAXIAL and OPTICAL audio signals.

If there are no digital audio signals, analog audio signals are selected.

• **COAX**

Specifies the digital audio signals input to the DIGITAL COAXIAL jack.

• **OPT**

Specifies the digital audio signals input to the DIGITAL OPTICAL jack.

• **ANALOG**

Specifies the analog audio signals input to the AUDIO IN (L/R) jacks.

Notes

- Some audio input modes may not be set up depending on the input.
- When the ANALOG DIRECT function is being used, the audio input mode is set to “ANALOG” automatically. You cannot select other modes.

Listening to digital sound from other inputs

(DIGITAL ASSIGN)

You can reassign digital audio input that has OPTICAL or COAXIAL (SAT IN, DVD IN) signals to another input when they are not currently being used.

For example, to output the sound source for the DVD player using the OPTICAL IN jack on the receiver:

- Connect the optical output jack of the DVD player to the OPTICAL SAT IN jack of the receiver.
- Assign “SAT OPT” to “DVD” in the “D. ASSIGN” setting.

1 Press AMP MENU.

“1-LEVEL” appears on the display.

2 Press \uparrow/\downarrow repeatedly to select “5-AUDIO”.

3 Press \oplus or \rightarrow to enter the menu.

4 Press \uparrow/\downarrow repeatedly to select “D. ASSIGN”.

5 Press \oplus or \rightarrow to enter the parameter.

6 Press \uparrow/\downarrow repeatedly to select a vacant digital audio input (“SAT OPT” in the example).

7 Press \oplus or \rightarrow to enter your selection.

8 Press **▲/▼** repeatedly to select the input (“SAT- DVD” in the example) you want to assign to the digital audio input jack selected in step 6.

When “DVD” input is selected, the sound of the DVD player will become a digital sound through the OPTICAL SAT IN jack.

The input you can assign varies for each audio input. For details, see the following “Assignable inputs for digital audio input”.

Assignable inputs for digital audio input

The initial setting is marked with an underscore.

Digital audio input [Display]	Assignable inputs	Display
COAXIAL DVD IN [DVD COAX]	VIDEO 1	DVD- VD1
	VIDEO 2	DVD- VD2
	BD	DVD- BD
	DVD	<u>DVD- DVD</u>
	SAT	DVD- SAT
	SA-CD/CD	DVD- CD
OPTICAL SAT IN [SAT OPT]	VIDEO 1	SAT- VD1
	VIDEO 2	SAT- VD2
	BD	SAT- BD
	DVD	SAT- DVD
	SAT	<u>SAT- SAT</u>
	SA-CD/CD	SAT- CD

Notes

- You cannot reassign more than one digital audio input to the same input.
- You cannot use the digital audio input as the original input when it has been reassigned to another input.
- When you assign the digital audio input, the INPUT MODE setting may change automatically (page 88).

Enjoying the DIGITAL MEDIA PORT (DMPORT)

The DIGITAL MEDIA PORT (DMPORT) allows you to enjoy sound and image from a network system such as a portable audio/video source or computer.

By connecting a DIGITAL MEDIA PORT adapter (not supplied), you can enjoy sound and image from the connected component on the receiver.

For details, refer to the operating instructions supplied with the DIGITAL MEDIA PORT adapter.

Notes

- Do not connect an adapter other than the DIGITAL MEDIA PORT adapter.
- Before connecting the cords, be sure to disconnect the AC power cord (mains lead).
- Do not connect or disconnect the DIGITAL MEDIA PORT adapter while the receiver is turned on.
- Depending on the DIGITAL MEDIA PORT adapter, video output may not be possible.
- The DIGITAL MEDIA PORT adapters are available for purchase depending on the area.

Connecting the DIGITAL MEDIA PORT adapter

You can listen to the sound and view the images from the component connected through the DIGITAL MEDIA PORT adapter to the DMPORT jack on the receiver.

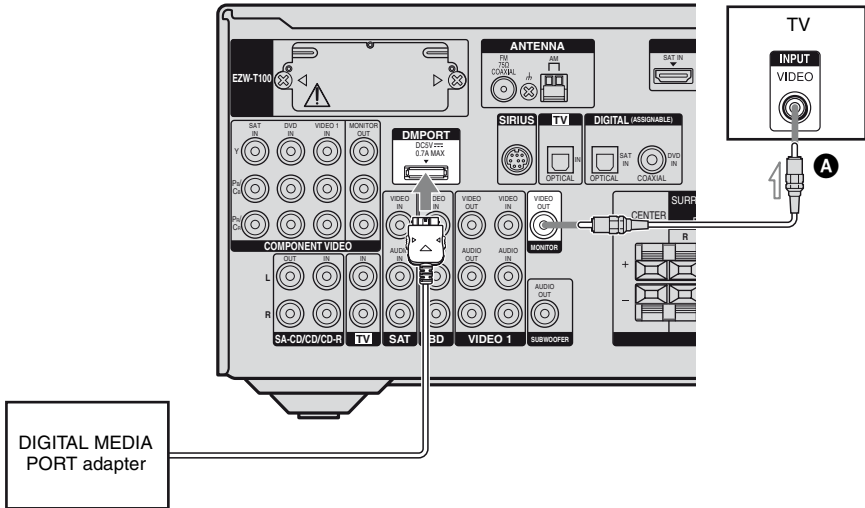

A Video cord (not supplied)

To detach the DIGITAL MEDIA PORT adapter from DMPORT jack

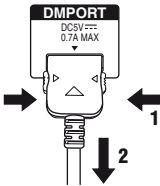

Press and hold both sides of the connector and then pull out the connector.

Notes

- When connecting the DIGITAL MEDIA PORT adapter, be sure the connector is inserted with the arrow mark facing towards the arrow mark on the DMPORT jack.
- Be sure to make DMPORT connections firmly, insert the connector straight in.
- As the connector of the DIGITAL MEDIA PORT adapter is fragile, be sure to handle with care when placing or moving the receiver.

Listening/watching a connected component through DMPORT connection

1 Press DMPORT.

You can also use the INPUT SELECTOR on the receiver to select “DMPORT”.

2 Start playback of the connected component.

The sound is played back on the receiver and the image appears on the TV.

For details, refer to the operating instructions supplied with the DIGITAL MEDIA PORT adapter.

Notes

- Depending on the type of DIGITAL MEDIA PORT adapter, you can operate the connected component by using the remote. For details on the remote button operation, see page 13.
- Be sure you have connected the MONITOR OUT of the receiver to the TV (page 91).

Tip

When listening to MP3 or other compressed music using a portable audio source, you can enhance the sound. Press MUSIC repeatedly to select “PORTABLE” (page 58).

Changing the display

You can check the sound field, etc., by changing the information on the display. Be sure to use the buttons on the receiver for this operation.

Press DISPLAY repeatedly.

Each time you press the button, the display changes cyclically as follows.

All inputs except the FM and AM band and SIRIUS Satellite Radio

Index name of the input* → Selected input → Sound field currently applied

FM and AM band

Preset station name* → Frequency → Sound field currently applied

SIRIUS Satellite Radio

Channel name → Channel number →
Category name → Artist name/Feature →
Song/program title → Composer name →
Signal strength → Sound field type

* Index name appears only when you have assigned one to the input or preset station (page 37, 65).
Index name does not appear when only blank spaces have been entered, or it is the same as the input name.

Note

Character or marks may not be displayed for some languages.

Using the Sleep Timer

You can set the receiver to turn off automatically at a specified time.

Press SLEEP repeatedly while the power is on.

Each time you press SLEEP, the display changes cyclically as follows:

2-00-00 → 1-30-00 → 1-00-00 → 0-30-00
→ OFF

When sleep timer is being used, "SLEEP" lights up in the display.

Tip

To check the remaining time before the receiver turns off, press SLEEP. The remaining time appears on the display. If you press SLEEP again, the sleep timer will be canceled.

Recording using the receiver

You can record from an audio/video component using the receiver. Refer to the operating instructions supplied with your recording component.

Recording onto a CD-R

You can record onto a CD-R using the receiver. Refer to the operating instructions supplied with your CD recorder.

1 Press one of the input buttons to select the playback component.

You can also use INPUT SELECTOR on the receiver.

2 Prepare the playback component for playing.

For example, tune to the radio station you want to record (page 62).

3 Prepare the recording component.

Insert a blank CD-R into the CD recorder and adjust the recording level.

4 Start recording on the recording component, then start playback on the playback component.

Note

Sound adjustments do not affect the signal output from the SA-CD/CD/CD-R OUT jacks.

Recording onto a recording media

- 1 Press one of the input buttons to select the playback component.**

You can also use INPUT SELECTOR on the receiver.

- 2 Prepare the playback component for playing.**

For example, insert the video tape you want to copy into the VCR.

- 3 Prepare the recording component.**

Insert a blank video tape, etc. into the recording component (VIDEO 1) for recording.

- 4 Start recording on the recording component, then start playback on the playback component.**

Note

Some sources contain copy guards to prevent recording. In this case, you may not be able to record from the source.

Using a bi-amplifier connection

If you are not using surround back speakers, you can connect the front speakers to the SPEAKERS SURROUND BACK/BI-AMP/FRONT B terminals using a bi-amplifier connection.

To connect speakers

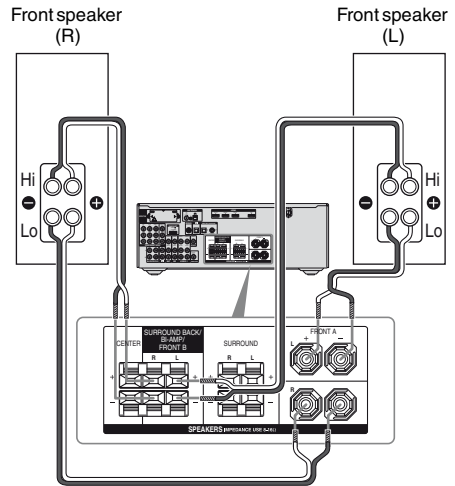

Connect the jacks on the Lo (or Hi) side of the front speakers to the SPEAKERS FRONT A terminals, and connect the jacks on the Hi (or Lo) side of the front speakers to the SPEAKERS SURROUND BACK/BI-AMP/FRONT B terminals.

Make sure that metal fittings of Hi/Lo attached to the speakers have been removed from the speakers. Not doing so may cause a malfunction of the receiver.

To set up speakers

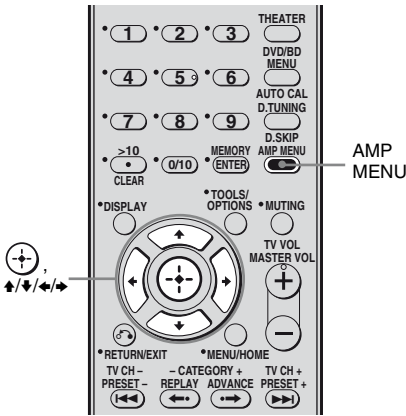

- 1 Press AMP MENU.**
“1-LEVEL” appears on the display.
- 2 Press \uparrow/\downarrow repeatedly to select “7-SYSTEM”.**
- 3 Press \odot or \rightarrow to enter the menu.**
- 4 Press \uparrow/\downarrow repeatedly to select “SB SPK”.**
- 5 Press \odot or \rightarrow to enter the parameter.**
- 6 Press \uparrow/\downarrow repeatedly to select “NO”.**
- 7 Press \leftarrow .**
- 8 Press \uparrow/\downarrow repeatedly to select “SB ASGN”.**
- 9 Press \odot or \rightarrow to enter the parameter.**

10 Press \uparrow/\downarrow repeatedly to select “BI-AMP”.

The same signals output from the SPEAKERS FRONT A terminals can be output from the SPEAKERS SURROUND BACK/BI-AMP/FRONT B terminals.

To exit the menu

Press AMP MENU.

Notes

- Set “SB ASGN” to “BI-AMP” before you perform auto calibration.
- If you set “SB ASGN” to “BI-AMP”, the speaker level and distance settings of the surround back speakers become invalid, and those of the front speakers are used.
- If SB SPK is set to “SINGLE” or “DUAL”, you cannot select “SB ASGN”.

Changing button assignments

You can change the factory settings of the input buttons to suit the components in your system. For example, if you connect a DVD recorder to the VIDEO 1 jacks on the receiver, you can set the VIDEO 1 button on this remote to control the DVD recorder.

Note

You cannot change the settings of DMPORT and TUNER buttons.

1 Hold down the input button of which you want to change the assignment.

Example: Hold down VIDEO 1.

2 Referring to the table below, press the corresponding button for the category you want.

Example: Press 4.

Now you can use the VIDEO 1 button to control the DVD recorder.

Categories and the corresponding buttons

Categories	Press
VCR (command mode VTR 3) ^{a)}	1
VCR (command mode VTR 2) ^{a)}	2
DVD player/DVD recorder (command mode DVD1) ^{b)}	3
DVD recorder (command mode DVD3) ^{b)}	4
CD player	5
Euro Digital Satellite Receiver	6
DVR (Digital CATV terminal)	7
DSS (Digital Satellite Receiver)	8
Blu-ray disc player (command mode BD1) ^{c)}	9
Blu-ray disc recorder (command mode BD3) ^{c)}	0/10
TV	●/>10/ CLEAR

^{a)}Sony VCRs are operated with a VTR 2 or VTR 3 setting which corresponds to 8 mm and VHS respectively.

^{b)}Sony DVD recorders are operated with a DVD1 or DVD3 setting. For details, refer to the operating instructions supplied with the DVD recorders.

^{c)}For details on the BD1 or BD3 setting, refer to the operating instructions supplied with the Blu-ray disc player or Blu-ray disc recorder.

To clear all remote button assignments

While holding down MASTER VOL –, press I/⏻ and DMPORT.

The remote is reset to its factory settings.

Glossary

■ Cinema Studio EX

A surround sound mode that can be regarded as the compilation of Digital Cinema Sound technology, delivers the sound of a dubbing theater using three technologies: “Virtual Multi Dimensions”, “Screen Depth Matching”, and “Cinema Studio Reverberation”.

“Virtual Multi Dimensions”, the virtual speaker technology, creates a virtual multi-surround environment with actual speakers up to 7.1 channels, and brings the surround sound experience of a theater with the latest facilities into your home.

“Screen Depth Matching” reproduces treble attenuation, fullness, and depth of sound usually created in a theater using sound emission from behind the screen. This is then added to the front and center channels.

“Cinema Studio Reverberation” reproduces the sound characteristics of state-of-the-art dubbing theaters and recording studios, including Sony Pictures Entertainment’s dubbing studios. There are three modes, A/B/C, available according to the studio type.

■ Component video

A format for transmitting video signal information consisting of three separate signals: luminance Y, chrominance Pb, and chrominance Pr. High quality pictures, such as DVD video or HDTV pictures, are transmitted more faithfully. The three jacks are color-coded green, blue and red.

■ Composite video

A standard format for transmitting video signal information. The luminance signal Y and chrominance signal C are combined and transmitted together.

■ Digital Cinema Sound (DCS)

A unique sound reproduction technology for home theater developed by Sony, in cooperation with Sony Pictures Entertainment, for enjoying the exciting and powerful sound of movie theaters at home. With this “Digital Cinema Sound” developed by integrating a DSP (Digital Signal Processor) and measured data, the ideal sound field intended by filmmakers can be experienced at home.

■ Dolby Digital

Digital audio encoding/decoding technology developed by Dolby Laboratories, Inc. It consists of front (left/right), center, surround (left/right) and subwoofer channels. It is a designated audio standard for DVD-video and also known as 5.1 channel surround. Since surround information is recorded and reproduced in stereo, more realistic sound with fuller presence is delivered than with Dolby surround.

■ Dolby Digital Surround EX

Acoustic technology developed by Dolby Laboratories, Inc. Surround back information is matrixed into regular left and right surround channels so that the sound can be reproduced in 6.1 channel. Active scenes, especially, are recreated with a more dynamic and realistic sound field.

■ Dolby Pro Logic II

This technology converts 2 channel stereo recorded audio into 5.1 channel for playback. There is a MOVIE mode for movies and MUSIC mode for stereo sources such as music. Old movies encoded in the traditional stereo format can be enhanced with 5.1 channel surround sound.

■ Dolby Pro Logic IIx

Technology for 7.1 channel (or 6.1 channel) playback. Along with audio encoded in Dolby Digital Surround EX, 5.1 channel Dolby Digital encoded audio can be reproduced in 7.1 channel (or 6.1 channel). Furthermore, existing stereo recorded content can also be reproduced in 7.1 channel (or 6.1 channel).

■ Dolby Surround (Dolby Pro Logic)

Audio processing technology developed by Dolby Laboratories, Inc. Center and mono surround information is matrixed into two stereo channels. When reproduced, audio is decoded and output in 4 channel surround sound. This is the most common audio processing method for DVD-video.

■ DTS 96/24

A high sound quality digital signal format. It records audio at a sampling frequency and bit rate of 96kHz/24bit which is the highest possible for DVD-video. The number of playback channels varies depending on the software.

■ DTS Digital Surround

Digital audio encoding/decoding technology for theaters developed by DTS, Inc. It compresses audio less than Dolby Digital, delivering a higher quality sound reproduction.

■ DTS-ES

Format for 6.1 channel playback with surround back information. There are two modes, "Discrete 6.1" which records all channels independently, and "Matrix 6.1" which matrixes surround back channel into LS (left surround) and RS (right surround) channels. It is ideal for playback of motion picture soundtracks.

■ DTS Neo:6

This technology converts 2 channel stereo recorded audio for 6.1 channel playback. There are two modes to select according to the playback source or your preference, CINEMA for movies, and MUSIC for stereo sources such as music.

■ HDMI (High-Definition Multimedia Interface)

HDMI (High-Definition Multimedia Interface) is an interface that supports both video and audio on a single digital connection, allowing you to enjoy high quality digital picture and sound. The HDMI specification supports HDCP (High-bandwidth Digital Contents Protection), a copy protection technology that incorporates coding technology for digital video signals.

■ PCM (Pulse Code Modulation)

A method of converting analog audio to digital audio for easy enjoyment of digital sound.

■ S-AIR (Sony Audio Interactive Radio frequency)

Recent times have seen the rapid spread of DVD media, Digital Broadcasting, and other high quality media.

To ensure that the subtle nuances of these high quality media are transmitted with no deterioration, Sony has developed a technology called "S-AIR" for the radio transmission of digital audio signals with no compression, and has incorporated this technology into the EZWRT10/EZW-T100. This technology transfers digital audio signals with no compression using the 2.4 GHz band range of ISM band (Industrial, Scientific, and Medical band), such as wireless LANs and Bluetooth applications.

■ Sampling frequency

To convert analog audio to digital, analog data should be quantified. This process is called sampling, and the number of times per second the analog data is quantified is called the sampling frequency. A standard music CD stores data quantified at 44,100 times per second, which is expressed as a sampling frequency of 44.1 kHz. Generally speaking, a higher sampling frequency means better sound quality.

■ x.v.Color

x.v.Color is a more familiar term for the xvYCC standard proposed by Sony, and is a trademark of Sony. xvYCC is an international standard for color space in video. This standard can express a wider color range than the currently used broadcast standard.

Precautions

On safety

Should any solid object or liquid fall into the cabinet, unplug the receiver and have it checked by qualified personnel before operating it any further.

On power sources

- Before operating the receiver, check that the operating voltage is identical with your local power supply.
The operating voltage is indicated on the nameplate on the back of the receiver.
- The unit is not disconnected from the AC power source (mains) as long as it is connected to the wall outlet, even if the unit itself has been turned off.
- If you are not going to use the receiver for a long time, be sure to disconnect the receiver from the wall outlet. To disconnect the AC power cord (mains lead), grasp the plug itself; never pull the cord.
- One blade of the plug is wider than the other for the purpose of safety and will fit into the wall outlet only one way. If you are unable to insert the plug fully into the outlet, contact your dealer.
- The AC power cord (mains lead) must be changed only at a qualified service shop.

On heat buildup

Although the receiver heats up during operation, this is not a malfunction. If you continuously use this receiver at a large volume, the cabinet temperature of the top, side and bottom rises considerably. To avoid burning yourself, do not touch the cabinet.

On placement

- Place the receiver in a location with adequate ventilation to prevent heat buildup and prolong the life of the receiver.
- Do not place the receiver near heat sources, or in a place subject to direct sunlight, excessive dust, or mechanical shock.
- Do not place anything on top of the cabinet that might block the ventilation holes and cause malfunctions.
- Do not place the receiver near equipment such as a television, VCR, or tape deck. If the receiver is being used in combination with a television, VCR, or tape deck, and is placed too close to that equipment, noise may result, and picture quality may suffer. This is especially likely when using an indoor antenna (aerial). Therefore, we recommend using an outdoor antenna (aerial).
- Use caution when placing the receiver on surfaces that have been specially treated (with wax, oil, polish, etc.) as staining or discoloration of the surface may result.

On operation

Before connecting other components, be sure to turn off and unplug the receiver.

On cleaning

Clean the cabinet, panel, and controls with a soft cloth slightly moistened with a mild detergent solution. Do not use any type of abrasive pad, scouring powder, or solvent, such as alcohol or benzine.

If you have any questions or problems concerning your receiver, please consult your nearest Sony dealer.

About S-AIR function

- As the S-AIR function transmits sound by radio waves, sound may skip when radio waves are obstructed. This is a characteristic of radio waves and is not malfunction.
- As the S-AIR function transmits sound by radio waves, equipment that generates electromagnetic energy, such as a microwave oven, may interfere with sound transmission.
- As the S-AIR function uses the radio waves that share the same frequency as other wireless systems, such as wireless LAN or Bluetooth, interference or poor transmission may result. In this case, take the following steps:
 - Do not install the system near other wireless systems.
 - Do not use the system and the other wireless systems at the same time.
- The transmission distance differs depending on the usage environment. Find a location where transmission between the S-AIR main unit and sub unit is most effective, and install the S-AIR main unit and sub unit there.

Troubleshooting

If you experience any of the following difficulties while using the receiver, use this troubleshooting guide to help you remedy the problem.

Audio

There is no sound, no matter which component is selected, or only a very low-level sound is heard.

- Check that the speakers and components are connected correctly and securely.
- Check that all speaker cords are connected correctly.
- Check that both the receiver and all components are turned on.
- Check that MASTER VOLUME is not set to “VOL MIN”.
- Check that the SPEAKERS is not set to OFF (page 30).
- Check that headphones are not connected.
- Press MUTING to cancel the muting function.
- Check that you have selected the correct component with the input buttons.
- The protective device on the receiver has been activated. Turn off the receiver, eliminate the short-circuit problem, and turn on the power again.

There is no sound from a specific component.

- Check that the component is connected correctly to the audio input jacks for that component.
- Check that the cord(s) used for the connection is (are) fully inserted into the jacks on both the receiver and the component.

There is no sound from one of the front speakers.

- Connect a pair of headphones to the PHONES jack to verify that sound is output from the headphones. If only one channel is output from the headphones, the component may not be connected to the receiver correctly. Check that all the cords are fully inserted into the jacks on both the receiver and the component. If both channels are output from the headphones, the front speaker may not be connected to the receiver correctly. Check the connection of the front speaker which is not outputting any sound.
- Make sure you have connected to both the L and R jacks of an analog component, and not only to either the L or R jack. Use an audio cord (not supplied).

There is no sound from digital sources (from COAXIAL or OPTICAL input jack).

- Check that the INPUT MODE is not set to “ANALOG” (page 88).
- Check that ANALOG DIRECT is not set to on.
- Check to make sure the selected digital audio input jack is not assigned to other inputs using DIGITAL ASSIGN function (page 89).

The left and right sounds are unbalanced or reversed.

- Check that the speakers and components are connected correctly and securely.
- Adjust the balance parameters using the LEVEL menu.

“NO INPUT” appears on the display

- Check that your component is connected to the COAXIAL or OPTICAL jack. If no signal is input through the COAXIAL or OPTICAL jack, “NO INPUT” appears on the display and this is not a malfunction.

There is severe hum or noise.

- Check that the speakers and components are connected securely.
- Check that the connecting cords are away from a transformer or motor, and at least 10 feet (3 meters) away from a TV set or fluorescent light.
- Move your audio components away from the TV.
- The plugs and jacks are dirty. Wipe them with a cloth slightly moistened with alcohol.

There is no sound, or only a very low-level sound is heard from the center/surround/surround back speakers.

- Select a CINEMA STUDIO EX mode (page 59).
- Adjust the speaker level (page 35).
- Make sure the center/surround speakers are set to either “SMALL” or “LARGE” (page 43).
- Make sure the surround back speakers are set to “SINGLE” or “DUAL” (page 43).

There is no sound from the surround back speaker.

- Some discs have no Dolby Digital Surround EX flag even though the packages have Dolby Digital Surround EX logos. In this case, select “SB ON” (page 41).

There is no sound from the subwoofer.

- Check that the subwoofer is connected correctly and securely.
- Make sure you have turned on your subwoofer.
- Make sure the subwoofer is set to “YES” (page 43).
- There is no sound from the subwoofer depending on the sound field.

The surround effect cannot be obtained.

- Make sure the sound field function is on (press MOVIE, or MUSIC).
- Sound fields do not function for signals with a sampling frequency of more than 48 kHz.

Dolby Digital or DTS multi channel sound is not reproduced.

- Check that the DVD, etc. you are playing is recorded in Dolby Digital or DTS format.
- When connecting the DVD player, etc., to the digital input jacks of this receiver, check the audio setting (the settings for the audio output) of the connected component.

There is no sound from the component connected to the DIGITAL MEDIA PORT adapter.

- Adjust the volume of this receiver.
 - The DIGITAL MEDIA PORT adapter and/or component is not connected correctly. Turn off the receiver, then reconnect the DIGITAL MEDIA PORT adapter and/or component.
 - Check the DIGITAL MEDIA PORT adapter and/or component device to make sure it supports this receiver.
-

Video

There is no picture or an unclear picture appears on the TV screen.

- Select the appropriate input using the input buttons.
- Set your TV to the appropriate input mode.
- Move your audio components away from the TV.
- Depending on the DIGITAL MEDIA PORT adapter, video output may not be possible.

Recording cannot be carried out.

- Check that the components are connected correctly (page 22).
- Select the source component using the input buttons (page 36).

HDMI

The source sound input to the HDMI jack on the receiver is not output from the receiver or the TV speaker.

- Check the HDMI connection.
- You cannot listen to the Super Audio CD by connecting HDMI.
- Depending on the playback component, you may need to set up the component. Refer to the operating instructions supplied with each component.

The source image input to the HDMI jack on the receiver is not output from the TV.

- Check the HDMI connection.
- Depending on the playback component, you may need to set up the component. Refer to the operating instructions supplied with each component.

The control for HDMI function does not work.

- Check the HDMI connection (page 23).
- Make sure “CONTROL FOR HDMI” is set to “CTRL ON” in HDMI menu.
- Make sure the connected component is compatible with the Control for HDMI function.
- Check the Control for HDMI settings on the connected component. See the operating instructions of the connected component.
- If you change the HDMI connection, connect/disconnect the AC power cord, or there is a power failure, repeat the procedures of “Preparing for the “BRAVIA” Sync” (page 76).

No sound is output from the receiver and TV speaker while using the System Audio Control function.

- Make sure the TV is compatible with the System Audio Control function.
- If the TV does not have System Audio Control function, set the “AUDIO FOR HDMI” settings in HDMI menu to
 - “TV+AMP” if you want to listen to the sound from the TV speaker and receiver.
 - “AMP” if you want to listen to the sound from the receiver.
- If you cannot listen to the sound of a component connected to the receiver
 - Select the appropriate input when you want to watch a program on a component connected via HDMI connection to the receiver.
 - Change the TV channel when you want to watch a TV broadcast.
 - Select the component or input you want to watch when you watch a program on the component connected to the TV. Refer to the operating instructions of the TV on this operation.

The TV's remote cannot be used to control the connected component when using the Control for HDMI function.

- Change the input of the receiver to the HDMI input connected to the component.
-

S-AIR function

Sound transmission is not established.

- If you use another S-AIR main unit, place it more than 26 1/4 feet (8 m) away from this S-AIR main unit.
- Confirm the ID of the S-AIR main unit and S-AIR sub unit (page 82).
- You performed pairing the S-AIR main unit and another S-AIR sub unit. Perform pairing of the desired S-AIR sub unit (page 83).
- The S-AIR main unit is pairing with another S-AIR sub unit. Cancel pairing.
- Install the S-AIR main unit and S-AIR sub unit away from other wireless products.
- Stop using another wireless product.
- The S-AIR sub unit is turned off. Make sure the AC power cord (mains lead) is connected and turn on the S-AIR sub unit.

No sound is heard from the S-AIR receiver.

- Check that the components are connected to analog jack of this receiver.

No sound is heard from the S-AIR product.

- If you use another S-AIR main unit, place it more than 26 1/4 feet (8 m) away from this S-AIR main unit.
- Confirm the ID of the S-AIR main unit and S-AIR sub unit (page 82).
- Confirm the pairing setting (page 83).
- Install the S-AIR main unit and S-AIR sub unit closer together.
- Avoid use of equipment that generates electromagnetic energy, such as a microwave oven.
- Install the S-AIR main unit and S-AIR sub unit away from other wireless products.
- Stop using another wireless product.
- Change the "RF SETUP" setting (page 86).
- Change the ID settings of the S-AIR main unit and S-AIR sub unit.
- Turn off the system and S-AIR sub unit, then turn on them.
- Check that headphones are not connected to the S-AIR sub unit.

There is noise or the sound skips.

- If you use another S-AIR main unit, place it more than 26 1/4 feet (8 m) away from this S-AIR main unit.
 - Install the S-AIR main unit and S-AIR sub unit closer together.
 - Avoid use of equipment that generates electromagnetic energy, such as a microwave oven.
 - Install the S-AIR main unit and S-AIR sub unit away from other wireless products.
 - Stop using another wireless product.
 - Change the "RF SETUP" setting (page 86).
 - Change the ID settings of the S-AIR main unit and S-AIR sub unit.
-

Tuner

The FM reception is poor.

- Use a 75-ohm coaxial cable (not supplied) to connect the receiver to an outdoor FM antenna (aerial) as shown below. If you connect the receiver to an outdoor antenna (aerial), ground it against lightning. To prevent a gas explosion, do not connect the ground wire to a gas pipe.

Outdoor FM antenna (aerial)

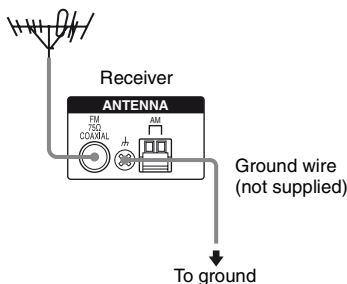

Radio stations cannot be tuned in.

- Check that the antennas (aerials) are connected securely. Adjust the antennas (aerials) and connect an external antenna (aerial), if necessary.
- The signal strength of the stations is too weak (when tuning in with automatic tuning). Use direct tuning.
- Make sure you set the tuning interval correctly (when tuning in AM stations with direct tuning).
- No stations have been preset or the preset stations have been cleared (when tuning by scanning preset stations). Preset the stations (page 64).
- Press DISPLAY repeatedly on the receiver so that the frequency appears on the display.

Remote commander

The remote does not function.

- Point the remote at the remote sensor on the receiver.
- Remove any obstacles in the path between the remote and the receiver.
- Replace all the batteries in the remote with new ones, if they are weak.
- Make sure you select the correct input on the remote.

Error messages

If there is a malfunction, the display shows a message. You can check the condition of the system by the message. Refer to the following table to solve the problem. If any problem persists, consult your nearest Sony dealer. If an error message appears while you perform Auto Calibration, see “Error and warning codes” (page 33) to solve the problem. For other message, see “SIRIUS Satellite Radio message list” (page 74).

PROTECT

Irregular current is output to the speakers, or the upper panel of the receiver is covered with something. The receiver will automatically turn off after a few seconds. Check the speaker connection and turn on the power again.

If you are unable to remedy the problem using the troubleshooting guide

Clearing the receiver's memory may remedy the problem (page 29). However, note that all memorized settings will be reset to their initial settings and you will have to readjust all settings on the receiver.

If the problem persists

Consult your nearest Sony dealer. Note that if service personnel changes some parts during repair, these parts may be retained. In the event of a problem with S-AIR function, have a Sony dealer check the entire system together (S-AIR main unit and S-AIR sub unit).

Reference sections for clearing the receiver's memory

To clear	See
All memorized settings	page 29
Customized sound fields	page 61

Specifications

AUDIO POWER SPECIFICATIONS

POWER OUTPUT AND TOTAL HARMONIC DISTORTION: (Models of area code U only)

With 8 ohm loads, both channels driven, from 20 – 20,000 Hz; rated 95 watts per channel minimum RMS power, with no more than 0.09% total harmonic distortion from 250 milliwatts to rated output.

Amplifier section

Models of area code U, CA¹⁾

Minimum RMS Output Power (8 ohms, 20 Hz – 20 kHz, THD 0.09%)

95 W + 95 W

Stereo Mode Output Power (8 ohms, 1 kHz, THD 1%)

105 W + 105 W

Surround Mode Output Power²⁾ (8 ohms, 1 kHz, THD 10%)

140 W/ch

¹⁾Measured under the following conditions:

Area code	Power requirements
U, CA	120 V AC, 60 Hz

²⁾Reference power output for front, center, surround and surround back speakers. Depending on the sound field settings and the source, there may be no sound output.

Frequency response

Analog 10 Hz – 70 kHz
+0.5/-2 dB (with sound field and equalizer bypassed)

Inputs

Analog Sensitivity: 500 mV/
50 kohms
S/N³: 96 dB
(A, 500 mV⁴)

Digital (Coaxial) Impedance: 75 ohms
S/N: 100 dB
(A, 20 kHz LPF)

Digital (Optical) S/N: 100 dB
(A, 20 kHz LPF)

Outputs (Analog)

AUDIO OUT Voltage: 500 mV/
10 kohms

SUBWOOFER Voltage: 2 V/1 kohm

Equalizer

Gain levels ±6 dB, 1 dB step

³INPUT SHORT (with sound field and equalizer bypassed).

⁴Weighted network, input level.

FM tuner section

Tuning range 87.5 – 108.0 MHz
Antenna FM wire antenna
Antenna terminals 75 ohms, unbalanced
Intermediate frequency
10.7 MHz

AM tuner section

Tuning range

Area code	Tuning scale	
	10 kHz step	9 kHz step
U, CA	530 – 1,710 kHz	531 – 1,710 kHz

Antenna Loop antenna

Intermediate frequency
450 kHz

Video section

Inputs/Outputs

Video: 1 V_{p-p}/75 ohms

COMPONENT VIDEO:

Y: 1 V_{p-p}/75 ohms
PB/CB: 0.7 V_{p-p}/75 ohms
PR/CR: 0.7 V_{p-p}/75 ohms
80 MHz HD Pass Through

General

Power requirements

Area code	Power requirements
U, CA	120 V AC, 60 Hz

Power output (DIGITAL MEDIA PORT)

DC OUT: 5 V, 0.7 A MAX

Power consumption

Area code	Power consumption
U, CA	240 W

Power consumption (during standby mode)

0.3 W (when “CONTROL FOR HDMI” in HDMI menu is set to “CTRL OFF” and “STANDBY” in S-AIR menu is set to “STBY OFF”)

Dimensions (w/h/d) (Approx.)

17 × 6 1/4 × 12 3/4 inches
(430 × 157.5 × 322 mm)
including projecting parts and controls

Mass (Approx.) 17 lb 11 oz (8.0 kg)

Supplied accessories

Operating instructions (this manual)

Quick Setup Guide (1)

FM wire antenna (aerial) (1)

AM loop antenna (aerial) (1)

RM-AAU021 Remote Commander (1)

R6 (size-AA) batteries (2)

Optimizer microphone (ECM-AC2 or ECM-AC2a) (1)

For details on the area code of the component you are using, see page 4.

Design and specifications are subject to change without notice.

Halogenated flame retardants are not used in the certain printed wiring boards.

Index

Numerics

- 2 channel 60
- 2CH STEREO 60
- 5.1 channel 17
- 7.1 channel 17

A

- AUTO CALIBRATION 31
- AUTO FORMAT DIRECT (A.F.D.) 56

B

- BI-AMP 53
- Bi-amplifier connection 94
- Blu-ray disc player
 - connecting 23, 25
 - playback 39

C

- Camcorder
 - connecting 27
- CD player
 - connecting 21
 - playback 38
- CD recorder
 - connecting 21

D

- DIGITAL ASSIGN 89
- Digital Cinema Sound (DCS) 97
- DIGITAL MEDIA PORT
 - connecting 91
- Dolby Digital 97
- DTS 98
- DVD player
 - connecting 25
 - playback 39
- DVD recorder
 - connecting 27

E

- Error messages 105

H

- HDMI
 - Audio for HDMI 50
 - connecting 23
 - Control for HDMI 51

I

- Initial setup 29
- INPUT MODE 88

M

- Menu
 - A. CAL 55
 - AUDIO 49
 - EQ 46
 - HDMI 50
 - LEVEL 45
 - S. AIR 56
 - SUR 46
 - SYSTEM 51
 - TUNER 48
- Muting 36

N

- Naming 37, 65

O

- One-Touch Play 77

P

- PAIRING 83
- Parental Lock 42, 72

R

- Recording
 - onto a CD-R 93
 - onto a recording media 94
- Remote commander 13

S

- S-AIR 80
- Satellite tuner
 - connecting 26
- SB DEC 47
- Selecting
 - component 36
 - sound field 58
 - speaker system 30
- Set-top box
 - connecting 26
- SIRIUS Satellite Radio 66
- Sleep Timer 93
- Sound fields
 - resetting 61
 - selecting 58
- Speakers
 - connecting 18
- Super Audio CD player
 - connecting 21
 - playback 38
- System Audio Control 78
- System Power Off 79

T

- TEST TONE 35
- Tuner
 - connecting 28
- Tuning
 - automatically 62
 - directly 63
 - to preset stations 65
- TV
 - connecting 20

V

- VCR
 - connecting 27
- Video game
 - connecting 27



* 4 1 2 9 7 8 3 1 1 * (3)