

Multi Channel AV Receiver

Operating Instructions

STR-DN1010

WARNING

To reduce the risk of fire or electric shock, do not expose this apparatus to rain or moisture.

To reduce the risk of fire, do not cover the ventilation opening of the apparatus with newspapers, tablecloths, curtains, etc.

Do not place the naked flame sources such as lighted candles on the apparatus.

To reduce the risk of fire or electric shock, do not expose this apparatus to dripping or splashing, and do not place objects filled with liquids, such as vases, on the apparatus.

Do not install the appliance in a confined space, such as a bookcase or built-in cabinet.

As the main plug is used to disconnect the unit from the mains, connect the unit to an easily accessible AC outlet. Should you notice an abnormality in the unit, disconnect the main plug from the AC outlet immediately.

Do not expose batteries or apparatus with battery-installed to excessive heat such as sunshine, fire or the like.

The unit is not disconnected from the mains as long as it is connected to the AC outlet, even if the unit itself has been turned off.

Excessive sound pressure from earphones and headphones can cause hearing loss.



This symbol is intended to alert the user to the presence of the Hot Surface that may be hot if it is touched during the normal operation.

For customers in the United States

Owner's Record

The model and serial numbers are located on the rear of the unit. Record these numbers in the space provided below. Refer to them whenever you call upon your Sony dealer regarding this product.

Model No. _____

Serial No. _____



This symbol is intended to alert the user to the presence of uninsulated "dangerous voltage" within the product's enclosure that may be of sufficient magnitude to constitute a risk of electric shock to persons.



This symbol is intended to alert the user to the presence of important operating and maintenance (servicing) instructions in the literature accompanying the appliance.

Important Safety Instructions

- 1) Read these instructions.
- 2) Keep these instructions.
- 3) Heed all warnings.
- 4) Follow all instructions.
- 5) Do not use this apparatus near water.
- 6) Clean only with dry cloth.
- 7) Do not block any ventilation openings. Install in accordance with the manufacturer's instructions.
- 8) Do not install near any heat sources such as radiators, heat registers, stoves, or other apparatus (including amplifiers) that produce heat.
- 9) Do not defeat the safety purpose of the polarized or grounding-type plug. A polarized plug has two blades with one wider than the other. A grounding type plug has two blades and a third grounding prong. The wide blade or the third prong are provided for your safety. If the provided plug does not fit into your outlet, consult an electrician for replacement of the obsolete outlet.
- 10) Protect the power cord from being walked on or pinched particularly at plugs, convenience receptacles, and the point where they exit from the apparatus.
- 11) Only use attachments/accessories specified by the manufacturer.

- 12) Use only with the cart, stand, tripod, bracket, or table specified by the manufacturer, or sold with the apparatus. When a cart is used, use caution when moving the cart/apparatus combination to avoid injury from tip-over.



- 13) Unplug this apparatus during lightning storms or when unused for long periods of time.
- 14) Refer all servicing to qualified service personnel. Servicing is required when the apparatus has been damaged in any way, such as power-supply cord or plug is damaged, liquid has been spilled or objects have fallen into the apparatus, the apparatus has been exposed to rain or moisture, does not operate normally, or has been dropped.

The following FCC statement applies only to the version of this model manufactured for sale in the U.S.A. Other versions may not comply with FCC technical regulations.

NOTE:

This equipment has been tested and found to comply with the limits for a Class B digital device, pursuant to Part 15 of the FCC Rules. These limits are designed to provide reasonable protection against harmful interference in a residential installation. This equipment generates, uses and can radiate radio frequency energy and, if not installed and used in accordance with the instructions, may cause harmful interference to radio communications. However, there is no guarantee that interference will not occur in a particular installation. If this equipment does cause harmful interference to radio or television reception, which can be determined by turning the equipment off and on, the user is encouraged to try to correct the interference by one or more of the following measures:

- Reorient or relocate the receiving antenna.
- Increase the separation between the equipment and receiver.
- Connect the equipment into an outlet on a circuit different from that to which the receiver is connected.
- Consult the dealer or an experienced radio/TV technician for help.

CAUTION

You are cautioned that any changes or modifications not expressly approved in this manual could void your authority to operate this equipment.

To reduce the risk of electric shock, the speaker cord should be connected to the apparatus and the speakers in accordance with the following instructions.

- 1) Disconnect the AC power cord from the MAINS.
- 2) Strip 10 to 15 mm of the wire insulation of the speaker cord.
- 3) Connect the speaker cord to the apparatus and the speakers carefully so as not to touch the core of speaker cord by hand. Also disconnect the AC power cord from the MAINS before disconnecting the speaker cord from the apparatus and the speakers.

For customers in Europe



Disposal of Old Electrical & Electronic Equipment (Applicable in the European Union and other European countries with separate collection systems)

This symbol on the product or on its packaging indicates that this product shall not be treated as household waste. Instead it shall be handed over to the applicable collection point for the recycling of electrical and electronic equipment. By ensuring this product is disposed of correctly, you will help prevent potential negative consequences for the environment and human health, which could otherwise be caused by inappropriate waste handling of this product. The recycling of materials will help to conserve natural resources. For more detailed information about recycling of this product, please contact your local Civic Office, your household waste disposal service or the shop where you purchased the product.



Disposal of waste batteries (applicable in the European Union and other European countries with separate collection systems)

This symbol on the battery or on the packaging indicates that the battery provided with this product shall not be treated as household waste.

On certain batteries this symbol might be used in combination with a chemical symbol. The chemical symbols for mercury (Hg) or lead (Pb) are added if the battery contains more than 0.0005% mercury or 0.004% lead.

By ensuring these batteries are disposed of correctly, you will help prevent potentially negative consequences for the environment and human health which could otherwise be caused by inappropriate waste handling of the battery. The recycling of the materials will help to conserve natural resources.

In case of products that for safety, performance or data integrity reasons require a permanent connection with an incorporated battery, this battery should be replaced by qualified service staff only. To ensure that the battery will be treated properly, hand over the product at end-of-life to the applicable collection point for the recycling of electrical and electronic equipment.

For all other batteries, please view the section on how to remove the battery from the product safely. Hand the battery over to the applicable collection point for the recycling of waste batteries.

For more detailed information about recycling of this product or battery, please contact your local Civic Office, your household waste disposal service or the shop where you purchased the product.

Notice for customers: The following information is only applicable to equipment sold in countries applying EU Directives.

The manufacturer of this product is Sony Corporation, 1-7-1 Konan Minato-ku Tokyo, 108-0075 Japan. The Authorized Representative for EMC and product safety is Sony Deutschland GmbH, Hedelfinger Strasse 61, 70327 Stuttgart, Germany. For any service or guarantee matters please refer to the addresses given in separate service or guarantee documents.

For customers in Australia



Disposal of Old Electrical & Electronic Equipment (Applicable in the European Union and other European countries with separate collection systems)

About This Manual

- The instructions in this manual are for model STR-DN1010. Check your model number by looking at the lower right corner of the front panel. In this manual, models of area code U2 is used for illustration purposes unless stated otherwise. Any difference in operation is clearly indicated in the text, for example, "Models of area code ECE only".
- The instructions in this manual describe the controls on the supplied remote. You can also use the controls on the receiver if they have the same or similar names as those on the remote.

About area codes

The area code of the receiver you purchased is shown on the lower right portion of the rear panel (see the illustration below).

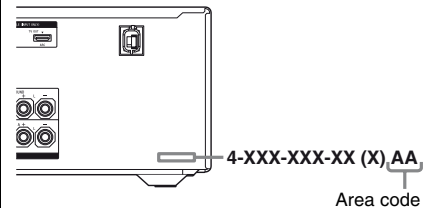

Any differences in operation, according to the area code, are clearly indicated in the text, for example, "Models of area code AA only".

On copyrights

This receiver incorporates Dolby* Digital and Pro Logic Surround and the DTS** Digital Surround System.

* Manufactured under license from Dolby Laboratories. Dolby, Pro Logic, and the double-D symbol are trademarks of Dolby Laboratories.

** Manufactured under license under U.S. Patent #'s: 5,451,942; 5,956,674; 5,974,380; 5,978,762; 6,226,616; 6,487,535; 7,212,872; 7,333,929; 7,392,195; 7,272,567 & other U.S. and worldwide patents issued & pending. DTS is a registered trademark and the DTS logos, Symbol, DTS-HD and DTS-HD Master Audio are trademarks of DTS, Inc. © 1996-2008 DTS, Inc. All Rights Reserved.

This receiver incorporates High-Definition Multimedia Interface (HDMI™) technology. HDMI, the HDMI Logo, and High-Definition Multimedia Interface are trademarks or registered trademarks of HDMI Licensing LLC in the United States and other countries.

SIRIUS, XM and all related marks and logos are trademarks of Sirius XM Radio Inc. and its subsidiaries. All rights reserved. Service not available in Alaska and Hawaii.

The font type (Shin Go R) installed in this receiver is provided by MORISAWA & COMPANY LTD. These names are the trademarks of MORISAWA & COMPANY LTD., and the copyright of the font also belongs to MORISAWA & COMPANY LTD.

iPod is a trademark of Apple Inc., registered in the U.S. and other countries.

All other trademarks and registered trademarks are of their respective holders. In this manual, ™ and ® marks are not specified.

The Bluetooth word mark and logos are owned by the Bluetooth SIG, Inc. and any use of such marks by Sony Corporation is under license.

Other trademarks and trade names are those of their respective owners.

“M-crew Server” is a trademark of Sony Corporation.

“x.v.Color (x.v.Colour)” and “x.v.Color (x.v.Colour)” logo are trademarks of Sony Corporation.

“BRAVIA” is a trademark of Sony Corporation.

“PlayStation” is a registered trademark of Sony Computer Entertainment Inc.

“S-AIR” and its logo are trademarks of Sony Corporation.

DLNA and DLNA CERTIFIED are trademarks and/or service marks of the Digital Living Network Alliance.

Table of Contents

About This Manual.....	4
Supplied accessories.....	8
Description and location of parts.....	9

Connections

1: Installing the speakers	19
2: Connecting the speakers	21
3: Connecting the TV	23
4a: Connecting the audio components.....	24
4b: Connecting the video components	26
5: Connecting the antennas (aerials).....	35
6: Inserting the wireless transmitter/ transceiver.....	35
7: Connecting the AC power cord (mains lead)	36

Preparing the Receiver

Initializing the receiver	37
Selecting the front speaker system	37
Calibrating the appropriate speaker settings automatically (Auto Calibration).....	38
Guide to on-screen display operation	44

Basic Operations

Playback	46
Enjoying sound/images from the components connected to the DIGITAL MEDIA PORT	48
Using the Sleep Timer	52
Recording using the receiver	52

Tuner Operations

Listening to FM/AM radio.....	53
Presetting FM/AM radio stations (Preset Tuning).....	55
Using the Radio Data System (RDS).....	56
(Models of area code CEK, ECE, AU1, TW2 only)	
Listening to Satellite Radio.....	57
(Models of area code U2, CA2 only)	
Connecting the SIRIUS Satellite Radio.....	58
Preparing to listen to the SIRIUS Satellite Radio.....	58
Selecting a channel of the SIRIUS Satellite Radio.....	59
Presetting SIRIUS Satellite Radio channels	61
Restricting access to specific channels (Parental Lock)	62

Enjoying Surround Sound

Selecting the sound field.....	65
Enjoying the surround effect at low volume levels (NIGHT MODE)	69
Resetting sound fields to the initial settings	69

“BRAVIA” Sync Features

What is “BRAVIA” Sync?	70
Preparing for the “BRAVIA” Sync.....	70
Playing back components with one-touch operation (One-Touch Play).....	72
Enjoying the TV sound from the speakers connected to the receiver (System Audio Control).....	72
Turning off the receiver with the TV (System Power Off)	73
Enjoying movies with the optimum sound field (Theater/Theatre Mode Sync).....	73
Enjoying the TV sound via an HDMI cable (Audio Return Channel).....	74

S-AIR Operations

About S-AIR products	75
Setting up an S-AIR product.....	76
Enjoying the system's sound in another room	80
Changing the channel for better sound transmission	81
Stabilizing S-AIR reception.....	82
Enjoying the S-AIR receiver while the S-AIR main unit is in standby mode	83

Advanced Operations

Switching between digital and analog audio (INPUT MODE)	84
Enjoying the sound/images from other inputs	85
Using a bi-amplifier connection.....	88
Using the setting menu.....	89
Auto Calibration menu.....	90
Speaker Settings menu.....	91
Surround Settings menu.....	95
EQ Settings menu.....	96
Audio Settings menu.....	96
Video Settings menu	97
HDMI Settings menu	98
System Settings menu	100
Operating without connecting to a TV.....	101

Using the Remote

Programming the remote.....	112
Clearing all the contents of the remote's memory	116

Additional Information

Glossary	117
Precautions	120
Troubleshooting	122
Specifications	129
Index.....	132

Supplied accessories

- Operating Instructions (this manual)
- Quick Setup Guide
- GUI Menu List
- FM wire antenna (aerial) (1)



- AM loop antenna (aerial) (1)

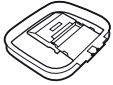

- Remote commander (1)
 - RM-AAP051 (Models of area code U2, CA2 only)
 - RM-AAP052 (Models of area code ECE, CEK, AU1, TW2 only)

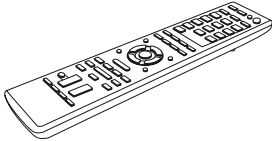

- R6 (size-AA) batteries (2)



- Optimizer microphone (ECM-AC2) (1)



Inserting batteries into the remote

Insert two R6 (size-AA) batteries in the RM-AAP051 (Models of area code U2, CA2 only) or RM-AAP052 (Models of area code CEK, ECE, AU1, TW2 only) Remote Commander.

Observe the correct polarity when installing batteries.

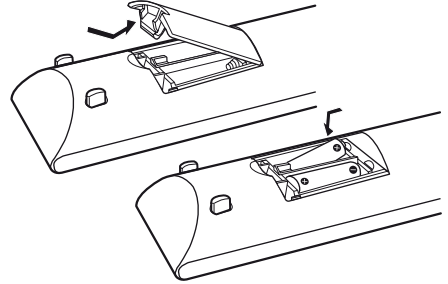

Notes

- Do not leave the remote in an extremely hot or humid place.
- Do not use a new battery with old ones.
- Do not mix manganese batteries and other kinds of batteries.
- Do not expose the remote sensor to direct sunlight or lighting apparatuses. Doing so may cause a malfunction.
- If you do not intend to use the remote for an extended period of time, remove the batteries to avoid possible damage from battery leakage and corrosion.
- When you replace the batteries, the programmed remote codes may be cleared. If this happens, program the remote codes again (page 112).
- When the remote no longer operates the receiver, replace all the batteries with new ones.

Description and location of parts

Front panel

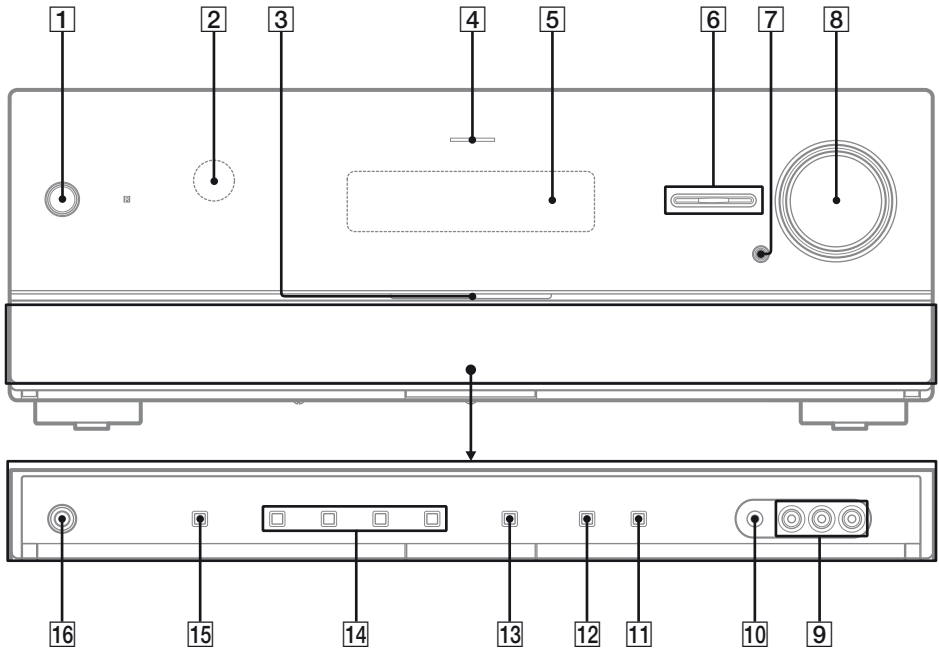

Name and function

- 1** I/⏻ (on/standby)
Turns the receiver on or off (page 37, 55, 69).
- 2** Remote sensor
Receives signals from remote commander.
- 3** White indicator
Lights up when the receiver is on.
Lights off when the receiver is off.
- 4** MULTI CHANNEL DECODING indicator
Lights up when multi channel audio signals are decoded (page 124).
- 5** Display
Displays the current status of the selected component or a list of selectable items (page 11).
- 6** INPUT SELECTOR +/-
Selects the input source to playback (page 46, 52, 84).

Name and function

- 7** MUTING
Turns off the sound temporarily.
Press MUTING again to restore the sound (page 47, 122).
- 8** MASTER VOLUME
Adjusts the volume level of all speakers at the same time (page 46, 122).
- 9** VIDEO 2 IN jacks
Connects to a portable audio/video component such as a camcorder or video game (page 33).
- 10** AUTO CAL MIC jack
Connects to the supplied optimizer microphone for the Auto Calibration function (page 39).
- 11** DISPLAY
Selects the information displayed on the display (page 47, 128).

continued

Name and function

12 DIMMER

Adjusts the brightness of the display (page 111).

13 INPUT MODE

Selects the input mode when the same components are connected to both digital and analog jacks (page 84).

14 2CH/A.DIRECT, A.F.D., MOVIE, MUSIC

Selects a sound field (page 65, 66).

15 SPEAKERS

Selects the front speaker system (page 37).

16 PHONES jack

Connects to headphones (page 122).

About the indicators on the display

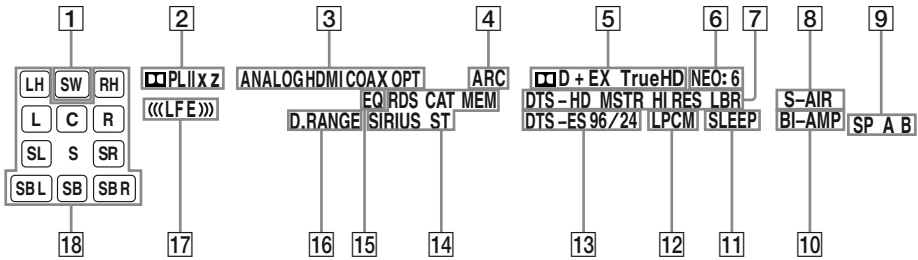

Indicator and explanation

1 SW

Lights up when the audio signal is output from the SUBWOOFER jack.

2 Dolby Pro Logic indicators

Lights up one of the respective indicators when the receiver performs Dolby Pro Logic processing. This matrix surround decoding technology can enhance input signals.

PL	Dolby Pro Logic
PL II	Dolby Pro Logic II
PL IIX	Dolby Pro Logic IIx
PL IIz	Dolby Pro Logic IIz

Note

These indicators may not light up depending on the speaker pattern setting.

3 Input indicators

Light up to indicate the current input.

ANALOG

Lights up when

- INPUT MODE is set to “ANALOG”.
- Sound Field is set to “Analog Direct”.
- No digital signals are detected.

HDMI

The receiver recognizes a component connected via an HDMI IN jack.

COAX

When INPUT MODE is set to “AUTO” and the source signal is a digital signal being input through the COAXIAL jack (page 84).

OPT

When INPUT MODE is set to “AUTO” and the source signal is a digital signal being input through the OPTICAL jack (page 84).

4 ARC

Lights up when TV input is selected and the Audio Return Channel (ARC) signals are detected (page 100).

Indicator and explanation

5 Dolby Digital Surround indicators

Lights up one of the respective indicators when the receiver is decoding the corresponding Dolby Digital format signals.

D	Dolby Digital
D EX	Dolby Digital Surround EX
D+	Dolby Digital Plus
TrueHD	Dolby TrueHD

Note

When playing a Dolby Digital format disc, be sure that you have made digital connections and that INPUT MODE is set to “AUTO” (page 84).

6 NEO:6

Lights up when DTS Neo:6 Cinema/Music decoder is activated (page 66).

7 DTS-HD indicators

Lights up one of the respective indicators when the receiver is decoding the corresponding DTS-HD format signals.

DTS-HD MSTR	DTS-HD Master Audio
DTS-HD HI RES	DTS-HD High Resolution Audio
DTS-HD LBR	DTS-HD Low Bit Rate Audio

8 S-AIR

Lights up when the S-AIR transmitter (not supplied) is inserted.

9 SP A/SP B/SP A B

Lights up according to the front speaker system used (page 37).

However, these indicators do not light up if the speaker output is turned off or if headphones are connected.

10 BI-AMP

Lights up when surround back speakers selection is set to “BI-AMP” (page 88).

continued

Indicator and explanation

11 SLEEP

Lights up when the Sleep Timer is activated.

12 LPCM

Lights up when Linear PCM (Pulse Code Modulation) signals are decoded.

13 DTS(-ES) indicators

Lights up one of the respective indicators when the receiver is decoding the corresponding DTS format signals.

DTS	DTS
DTS-ES	DTS-ES
DTS 96/24	DTS 96 kHz/24 bit

Note

When playing a DTS format disc, be sure that you have made digital connections and that INPUT MODE is set to "AUTO" (page 84).

14 Tuning indicators

Lights up when the receiver tunes in radio stations, or satellite radio stations.

RDS (Models of area code CEK, ECE, AU1, TW2 only)

A station that provides RDS services is tuned in.

CAT (Models of area code U2, CA2 only)

The category mode is selected during the satellite radio operation.

MEM

A memory function, such as Preset Memory (page 55), etc., is activated.

SIRIUS (Models of area code U2, CA2 only)

The SiriusConnect Home tuner is connected and "SR" is selected.

ST

Stereo broadcast

15 EQ

Lights up when the equalizer is activated.

16 D.RANGE

Lights up when dynamic range compression is activated (page 94).

17 (((LFE)))

Lights up when the disc being played back contains an LFE (Low Frequency Effect) channel and the LFE channel signal is actually being reproduced.

Indicator and explanation

18 Playback channel indicators

The letters (L, C, R, etc.) indicate the channels being played back. The boxes around the letters vary to show how the receiver downmixes or upmixes the source sound (based on the speaker pattern settings).

LH	Front Left High
RH	Front Right High
L	Front Left
R	Front Right
C	Center (monaural)
SL	Surround Left
SR	Surround Right
S	Surround (monaural or the surround components obtained by Pro Logic processing)
SBL	Surround Back Left
SBR	Surround Back Right
SB	Surround Back (the surround back components obtained by 6.1 channel decoding)

Example:
Speaker pattern: 3/0.1
Recording format: 3/2.1
Sound Field: A.F.D. AUTO

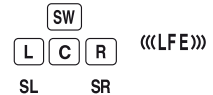

Rear panel

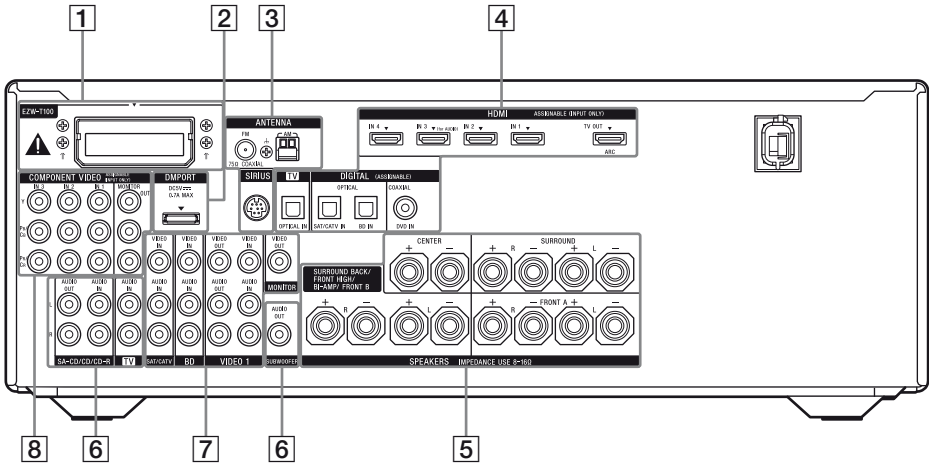

1 S-AIR section

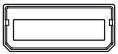

EZW-T100 slot Connects to a wireless transmitter (not supplied) (page 35).

2 DMPORT section



DMPORT jack Connects to a Sony DIGITAL MEDIA PORT adapter (page 24).

3 ANTENNA section



FM ANTENNA jack Connects to the supplied FM wire antenna (aerial) (page 35).



AM ANTENNA terminals Connects to the supplied AM loop antenna (aerial) (page 35).



SIRIUS jack (Models of area code U2, CA2 only) Connects to a SiriusConnect Home tuner (not supplied) (page 58).

4 DIGITAL INPUT/OUTPUT section



OPTICAL IN jacks Connects to a Blu-ray disc player, etc. (page 23, 30, 31, 32).



COAXIAL IN jack





HDMI IN/OUT* jacks Connects to a DVD player, satellite tuner, Blu-ray disc player, etc. The image is output to a TV or a projector while the sound can be output from a TV or/and speakers connected to this receiver (page 23, 27).

5 SPEAKERS section





Connects to speakers (page 21).



6 AUDIO INPUT/OUTPUT section

 White (L)	AUDIO IN/ OUT jacks	Connects to a Super Audio CD player, etc. (page 23, 24).
 Red (R)		
 Black	AUDIO OUT jack	Connects to a subwoofer (page 21).

7 VIDEO/AUDIO INPUT/OUTPUT section

 White (L)	AUDIO IN/ OUT jacks	Connects to a VCR, Blu-ray disc player, etc. (page 30, 32, 33).
 Red (R)		
 Yellow	VIDEO IN/ OUT* jacks	

8 COMPONENT VIDEO INPUT/ OUTPUT section

 Green (Y)	Y, Pb/Cb, Pr/Cr IN/ OUT* jacks	Connects to a Blu-ray disc player, TV, satellite tuner, etc. (page 23, 30, 31, 32).
 Blue (Pb/Cb)		
 Red (Pr/Cr)		

* You can watch the selected input image when you connect the MONITOR OUT or HDMI TV OUT jack to a TV (page 23).

Remote commander

You can use the supplied remote to operate the receiver and to control the Sony audio/video components that the remote is assigned to operate.

You can also program the remote to control non-Sony audio/video components. For details, see “Programming the remote” (page 112).

- **RM-AAP051 (Models of area code U2, CA2 only)**
- **RM-AAP052 (Models of area code CEK, ECE, AU1, TW2 only)**

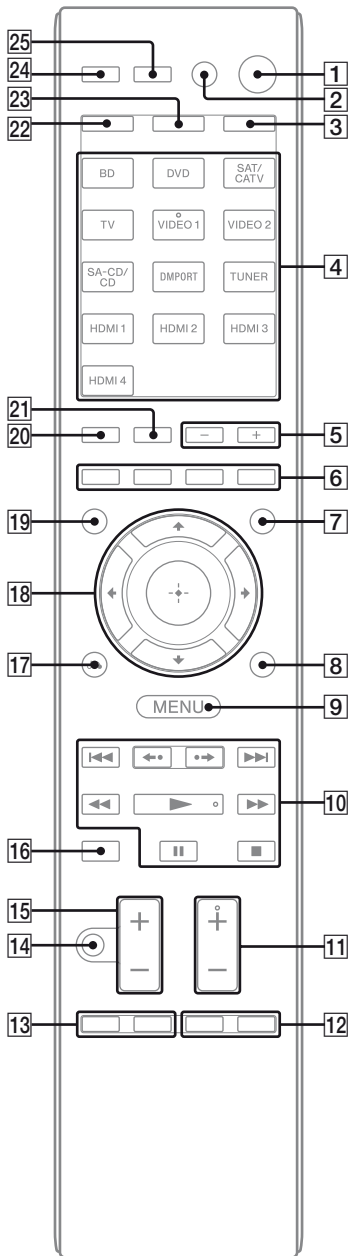

Name and function

1 I/⏻ (on/standby)

Turns the receiver on or sets it to the standby mode.

To turn off all components, press I/⏻ and AV I/⏻ (2) at the same time (SYSTEM STANDBY).

Saving the power in standby mode.

When "Ctrl for HDMI" is set to "OFF" (page 70) and "S-AIR Stby" is set to "OFF" (page 83).

2 AV I/⏻^{a)} (on/standby)

Turns on or off the audio/video components that the remote is programmed to operate.

To turn the TV on or off, press TV (23) and then press AV I/⏻.

If you press I/⏻ (1) at the same time, it will turn off the receiver and other components (SYSTEM STANDBY).

Note

The function of the AV I/⏻ switch changes automatically each time you press the input buttons (4).

3 AMP

The button lights up and activates the receiver operation (page 101).

4 Input buttons (VIDEO 1^{b)})

Selects the component you want to use. When you press any of the input buttons, the receiver turns on. The buttons are initially assigned to control Sony components. You can program the remote to control non-Sony components following the steps in "Programming the remote" on page 112.

Numeric buttons^{a)} (number 5^{b)})

Press SHIFT (22), then press numeric buttons to

- preset/tune to preset stations.
- select track numbers. Press 0/10 to select track number 10.
- select channel numbers.

Press TV (23), then press the numeric buttons to select the TV channels.

-/--^{a)}

Press SHIFT (22), then press -/-- to select the channel entry mode, either one or two digit.

To select the channel entry mode of the TV, press TV (23) and then press -/--.

>10^{a)}

Press SHIFT (22), then press >10 to select track numbers over 10. You can also select the channel numbers of the DIGITAL CATV terminal.

Name and function

ENTER^{a)}

Press SHIFT (22), then press ENTER to enter the value after selecting a channel, disc or track using the numeric buttons.

To enter the value of Sony TV, press TV (23) and then press ENTER.

MEMORY

Press SHIFT (22), then press MEMORY to store a station during tuner operation.

^{a)} (Text) (RM-AAP052 only)

Press TV (23), then press  to display text.

5 SOUND FIELD +/-

Selects a sound field (page 65).

6 Color buttons^{a)}

Displays an operation guide on the TV screen when the color buttons are available. Follow the operation guide to perform a selected operation.

7 GUI MODE

Displays the GUI menu on the TV screen.

8 TOOLS/OPTIONS^{a)}

Displays and selects items from the option menus.

To display the options of Sony TV, press TV (23) and then press TOOLS/OPTIONS.

9 MENU, HOME^{a)}

Displays the menu to operate the audio/video components.

To display the menus of Sony TV, press TV (23) and then press HOME.

10 ^{a)}, ^{a)}, ^{a)}, ^{a)}, ^{a)}

Skip, backward/forward, play, pause, stop operation.

^{a)}

Replay the previous scene or fast forward the current scene.

CATEGORY +/- (RM-AAP051 only)

Selects a category for satellite tuner (page 60, 110).

CATEGORY MODE^{b)} (RM-AAP051 only)

Selects the category mode for satellite tuner (page 59, 110).

TUNING +/-^{a)}

Scans a station.

D.TUNING

Enters direct tuning mode (page 54, 109).

Name and function

11 TV CH +^{b)}/^{b)}-^{a)} (RM-AAP051 only)

PROG +^{b)}/^{b)}-^{a)} (RM-AAP052 only)

Press TV (23), then press TV CH +/- or PROG +/- to select preset TV channels.



PRESET +^{b)}/^{b)}-^{a)}

Selects

- preset stations.

- preset channels.

^{b)}/^{b)} (RM-AAP052 only)

In text mode: Press TV (23), then press ^{b)}/^{b)} to select the next or previous page.

12 F1^{a)}, F2^{a)}

Press BD or DVD (4), then press F1 or F2 to select a component.

• DVD/HDD COMBO

F1: HDD

F2: DVD disc, Blu-ray disc

• DVD/VCR COMBO



F1: DVD disc, Blu-ray disc

F2: VHS



SLEEP

Activates the Sleep Timer function and the duration which the receiver turns off automatically (page 52).

13 BD/DVD TOP MENU^{a)}

Displays the menu or on-screen guide on the TV screen. Then, use ^{a)}/^{a)} (18) and  (18) to perform menu operations.

BD/DVD MENU^{a)}

Displays the menu on the TV screen. Then, use ^{a)}/^{a)} (18) and  (18) to perform menu operations.

TV INPUT^{a)} (RM-AAP051 only)

^{a)} (Input select) (RM-AAP052 only)

Press TV (23), then press TV INPUT or ^{a)} to select the input signal (TV input or video input).

^{a)} (Text hold) (RM-AAP052 only)

In text mode: Press TV (23), then press ^{a)} to hold the current page.

WIDE^{a)} (RM-AAP051 only)

^{a)} (Wide mode) (RM-AAP052 only)

Press TV (23), then press WIDE or ^{a)} repeatedly to select the wide picture mode.

14 MUTING^{a)} (RM-AAP051 only)

^{a)} (RM-AAP052 only)

Activates the muting function. Press the button again to restore the sound. To activate the TV's muting function, press TV (23) and then press MUTING or ^{a)}.

Name and function

- 15 TV VOL +/-^{a)} (RM-AAP051 only)**
△ +/-^{a)} (RM-AAP052 only)
Press TV (23), then press TV VOL +/- or △ +/- to adjust the TV volume level.
-
- MASTER VOL +/-^{a)} (RM-AAP051 only)**
△ +/-^{a)} (RM-AAP052 only)
Adjust the volume level of all speakers at the same time.
-
- 16 DISC SKIP^{a)}**
Skips disc when using a multi-disc changer.
-
- 17 RETURN/EXIT ⏪^{a)}**
Returns to the previous menu or exits the menu while the menu or on-screen guide is displayed on the TV screen.
To return to the previous menu of Sony TV, press TV (23) and then press RETURN/EXIT ⏪.
-
- 18** ^{a)} **(+)**, **↑/↓/←/→^{a)}**
Press ↑/↓/←/→ to select the menu items, then press (+) to enter the selection.
-
- 19 GUIDE^{a)} (RM-AAP051 only)**
≡^{a)} (Guide) (RM-AAP052 only)
Press TV (23), then press GUIDE or ≡ to display the on-screen program guide.
-
- 20 DISPLAY^{a)}**
Views information on the display.
DISPLAY^{a)} (RM-AAP051 only)
Press TV (23), then press DISPLAY to display information of TV.
(i+), (?) (Info, Text reveal) (RM-AAP052 only)
Press TV (23), then press (i+) to display information such as current channel number and screen mode.
In text mode: Press TV (23), then press (?) to reveal hidden information (e.g. answers to a quiz).
-
- 21 NIGHT MODE**
Activates the Night Mode function (page 69).
-
- 22 SHIFT**
The button lights up and activates the buttons with pink printing.
-
- 23 TV**
The button light up and activates the buttons with yellow printing.
-

Name and function

- 24 THEATER (RM-AAP051 only)**
THEATRE (RM-AAP052 only)
Sets the optimal picture settings automatically for watching movies when you connect a Sony TV that is compatible with the THEATER or THEATRE button function (page 73).
-
- 25 RM SET UP**
Set up the remote.
-
- ^{a)} See the table on page 18 for information on the buttons that you can use to control each component.
^{b)} The following buttons have tactile dots. Use the tactile dots as reference when operating the receiver.
– number 5, VIDEO 1
– ►, CATEGORY MODE (RM-AAP051 only)
– PRESET +, TV CH + (RM-AAP051 only), PROG + (RM-AAP052 only), (E▲) (RM-AAP052 only)

Notes

- Some functions explained in this section may not work depending on the model.
- The above explanation is intended to serve as an example only. Therefore, depending on the component, the above operation may not be possible or may operate differently than described.

To control other Sony components

Name	TV	VCR	DVD player, DVD/ VCR combo	Blu-ray disc player	HDD Recorder	PSX	Video CD player, LD player	Digital CATV terminal ^{*1}	DSS ^{*1}	Digital satellite/ terrestrial receiver ^{*2}	Tape deck A/B	DAT deck	CD MO deck	DIGITAL MEDIA PORT device
2 AV I/⏻	●	●	●	●	●	●	●	●	●	●		●	●	
4 Numeric buttons	●	●	●	●	●	●	●	●	●	●	●	●	●	●
-/., >10	●	●	●	●	●	●	●	●	●		●		●	
ENTER	●	●	●	●	●	●	● ^{*4}	●	●		●	●	●	
☰ ^{*2} (Text)	●									●				
6 Color buttons	●		● ^{*3}	●	●					●				
8 TOOLS/ OPTIONS	●		●	●	●	●		●	●					
9 MENU, HOME	●	●	●	●	●	●		●	●	●				●
10 I◀◀/▶▶I	●	●	●	●	●	●	●	●			● ^{*5}	●	●	●
←./→	●		●	●	●	●		●						●
◀◀/TUNING-, ▶▶/TUNING +	●	●	●	●	●	●	●	●			●	●	●	● ^{*7}
▶, II, ■	●	●	●	●	●	●	●	●			●	●	●	●
11 PRESET +/-, TV CH +/- ^{*1} , PROG +/- ^{*2}	●	●	●	●	●		● ^{*4}	●	●	●				
12 F1, F2			●	●										
13 BD/DVD TOP MENU, BD/ DVD MENU			●	●		●								
TV INPUT ^{*1} , ↺ ^{*2} (Input select), (⊕) ^{*2} (Text hold), WIDE ^{*1} , (⊞) ^{*2} (Wide mode)	●													
14 MUTING ^{*1} , ⊗ ^{*2}	●													
15 MASTER VOL +/- ^{*1} , TV VOL +/- ^{*1} , △ +/- ^{*2}	●													
16 DISC SKIP			●	●			● ^{*6}						●	
17 RETURN/ EXIT ⏪	●		●	●	●	●	●	●	●	●				●
18 ⏪/⏩/⏴/⏵, (⊕)	●	●	●	●	●	●	●	●	●	●				●
19 GUIDE ^{*1} , ☰ ^{*2} (Guide)	●		● ^{*3}	●	●	●		●		●				
20 DISPLAY	●	●	●	●	●	●	●	●	●				●	

*1 RM-AAP051 only.

*2 RM-AAP052 only.

*3 DVD player only.

*4 LD player only.

*5 Deck B only.

*6 Video CD only.

*7 ◀◀/▶▶ only.

1: Installing the speakers

This receiver allows you to use a 7.1 channel system (7 speakers and one subwoofer).

To fully enjoy theater-like multi channel surround sound requires five speakers (two front speakers, a center speaker, and two surround speakers) and a subwoofer (5.1 channel).

You can enjoy high fidelity reproduction of DVD software recorded sound in the Surround EX format if you connect additional one surround back speaker (6.1 channel) or two surround back speakers (7.1 channel).

You can enjoy vertical sound effects if you connect additional two front high speakers (7.1 channel) in PLIIz mode (page 66).

Example of speaker system configuration

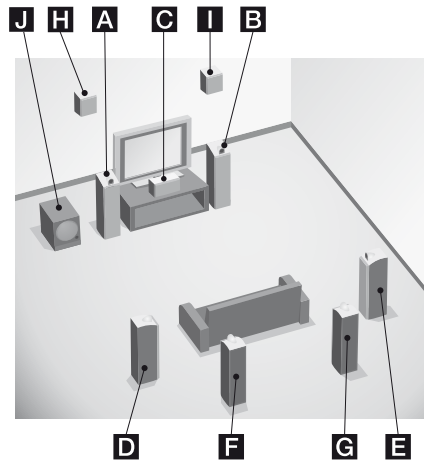

- A** Front speaker (Left)
- B** Front speaker (Right)
- C** Center speaker
- D** Surround speaker (Left)
- E** Surround speaker (Right)
- F** Surround back speaker (Left)*
- G** Surround back speaker (Right)*
- H** Front high speaker (Left)*
- I** Front high speaker (Right)*
- J** Subwoofer

* You cannot use the surround back speakers and the front high speakers simultaneously.

Tips

- When you connect a 7.1 channel speaker system with two surround back speakers, all angle **A** should be the same.

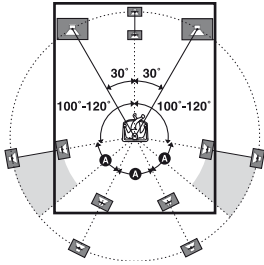

- When you connect a 7.1 channel speaker system with two front high speakers, place the front high speakers
 - at an angle between 22° to 45°.
 - at least 3.3 feet (1 meter) directly above the front speakers.

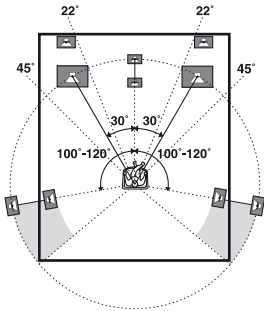

- When you connect a 6.1 channel speaker system, place the surround back speaker behind the listening position.

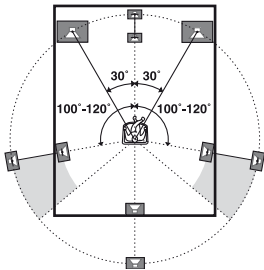

- Since the subwoofer does not emit highly directional signals, you can place it wherever you want.

2: Connecting the speakers

Before connecting cords, be sure to disconnect the AC power cord (mains lead).

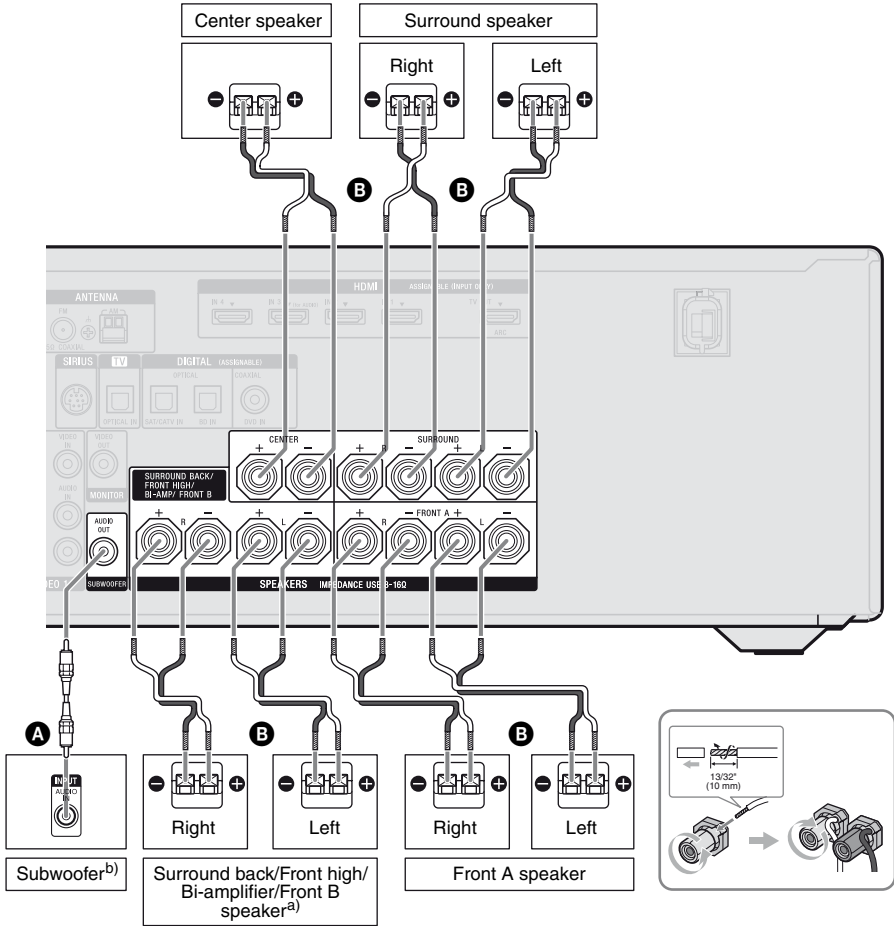

A Monaural audio cord (not supplied)

B Speaker cord (not supplied)

a) Notes on the SPEAKERS SURROUND BACK/FRONT HIGH/BI-AMP/FRONT B terminals connection.

- If you connect only one surround back speaker, connect it to L of this terminals.
- If you are not using surround back speaker or front high speakers, and you have an additional front speaker system, connect the additional front speaker system to this terminals. Set “SB Assign” to “Speaker B” in the Speaker Settings menu (page 91). You can select the front speaker system you want using the SPEAKERS button on the receiver (page 37).
- If you are not using surround back speaker or front high speakers, you can connect the front speakers to this terminals using bi-amplifier connection (page 22). Set “SB Assign” to “BI-AMP” in the Speaker Settings menu (page 91).

b) When you connect a subwoofer with an auto standby function, turn off the function when watching movies. If the auto standby function is set to on, it turns to standby mode automatically based on the level of the input signal to a subwoofer, then sound may not be output.

Notes

- Before connecting the AC power cord (mains lead), make sure that metallic wires of the speaker cords are not touching each other between the SPEAKERS terminals.
- After you have install and connect your speaker, be sure to select the speaker pattern from the Speaker Settings menu (page 91).

Bi-amplifier connection

If you are not using surround back speakers or front high speakers, you can connect the front speakers to the SPEAKERS SURROUND BACK/FRONT HIGH/BI-AMP/FRONT B terminals using a bi-amplifier connection.

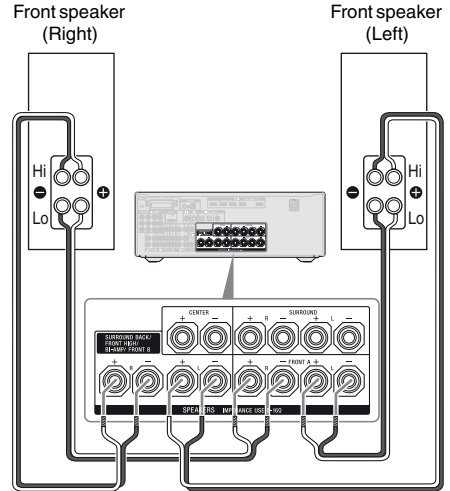

Connect the jacks on the Lo (or Hi) side of the front speakers to the SPEAKERS FRONT A terminals, and connect the jacks on the Hi (or Lo) side of the front speakers to the SPEAKERS SURROUND BACK/FRONT HIGH/BI-AMP/FRONT B terminals. Make sure that metal fittings of Hi/Lo attached to the speakers have been removed from the speakers. Not doing so may cause a malfunction of the receiver. After you have made the bi-amplifier connection, set “SB Assign” to “BI-AMP” in the Speaker Settings menu (page 91).

3: Connecting the TV

You can watch the selected input image when you connect the HDMI TV OUT or MONITOR OUT jack to a TV. You can operate this receiver using a GUI (Graphical User Interface) if you connect HDMI TV OUT jack to a TV.

It is not necessary to connect all the cables. Connect audio and video cords according to the jacks of your components. Before connecting cords, be sure to disconnect the AC power cord (mains lead).

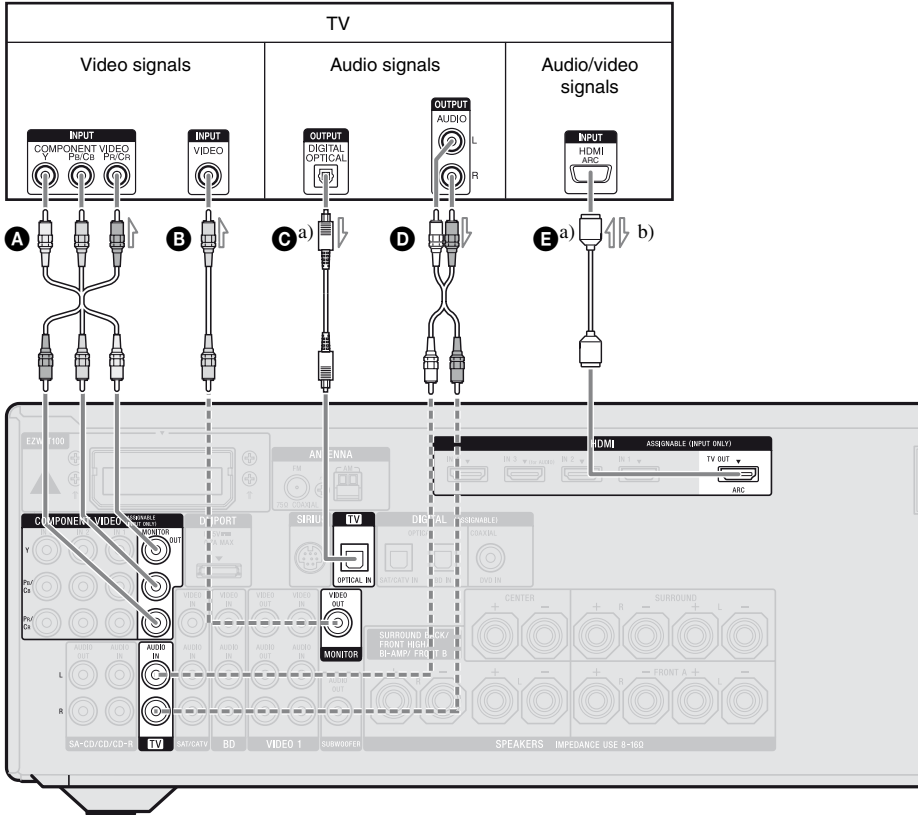

- A** Component video cord (not supplied) — Recommended connection
- B** Video cord (not supplied) - - - - - Alternative connection
- C** Optical digital cord (not supplied)
- D** Audio cord (not supplied)
- E** HDMI cable (not supplied)

Sony recommends that you use an HDMI-authorized cable or Sony HDMI cable.

- a) To enjoy TV multi channel surround sound broadcasting from the speakers connected to the receiver, connect **C** or **E**.
Be sure to turn off the TV's volume or activate the TV's muting function.
- b) If your TV is compatible with the Audio Return Channel (ARC) function, the TV sound will output from the speakers connected to the receiver via HDMI TV OUT connection. In this case, set "ARC" to "ON" in HDMI Settings menu (page 100).

Notes

- Be sure to turn on the receiver when the video and audio signals of a playback component are being output to a TV via the receiver. If the power supply of the receiver is not turned on, neither video nor audio signals will be transmitted.
- Connect image display components such as a TV monitor or a projector to the HDMI TV OUT or MONITOR OUT jack on the receiver. You may not be able to record, even if you connect recording components.
- Depending on the status of the connection between the TV and the antenna (aerial), the image on the TV screen may be distorted. In this case, place the antenna (aerial) farther away from the receiver.
- When connecting optical digital cords, insert the plugs straight in until they click into place.
- Do not bend or tie optical digital cords.

Tips

- All the digital audio jacks are compatible with 32 kHz, 44.1 kHz, 48 kHz, and 96 kHz sampling frequencies.
- The receiver has a video conversion function. For details, see "Function for conversion of video signals" (page 34).
- When you connect the audio output jack of the TV to the TV IN jacks of the receiver to output the TV sound from the speakers connected to the receiver, set the sound output jack of the TV to "Fixed" if it can be switched between either "Fixed" or "Variable".

4a: Connecting the audio components

The following illustration shows how to connect a Super Audio CD player, CD player, CD recorder and DIGITAL MEDIA PORT adapter. Before connecting cords, be sure to disconnect the AC power cord (mains lead).

Notes on connecting DIGITAL MEDIA PORT adapter

- Do not connect or disconnect the DIGITAL MEDIA PORT adapter while the receiver is turned on.
- Be sure to make DMPORT connections firmly, insert the connector straight in.
- As the connector of the DIGITAL MEDIA PORT adapter is fragile, be sure to handle with care when placing or moving the receiver.
- When connecting the DIGITAL MEDIA PORT adapter, be sure the connector is inserted with the arrow mark facing towards the arrow mark on the DMPORT jack.

To detach the DIGITAL MEDIA PORT adapter from DMPORT jack

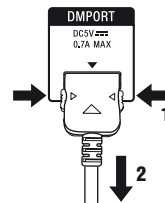

Press and hold both sides of the connector and then pull out the connector.

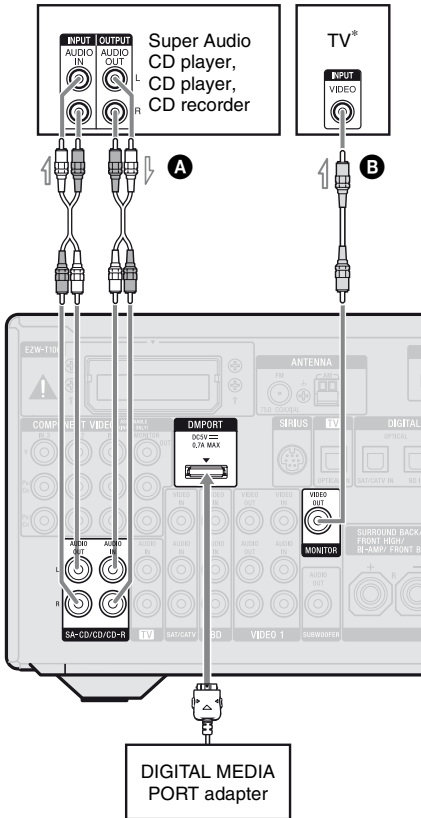

- A** Audio cord (not supplied)
- B** Video cord (not supplied)

* You can enjoy the images from the components connected to the DIGITAL MEDIA PORT adapter when you connect the TV to the receiver.

4b: Connecting the video components

Components to be connected

Connect your video components according to the table below.

Component	Page
Blu-ray disc player*	27, 30
DVD player*	27, 31
DVD recorder*	27, 31
Satellite tuner*, Cable TV tuner*	27, 32
“PlayStation 3”	27
VCR	33
Camcorder, video game, etc.	33

* We recommend that you connect your video components via HDMI connection if they have HDMI jacks.

If you want to connect several digital components, but cannot find an unused input

See “Enjoying the sound/images from other inputs” (page 85).

Video input/output jacks to be connected

The image quality depends on the connecting jack. See the illustration that follows. Select the connection according to the jacks on your components.

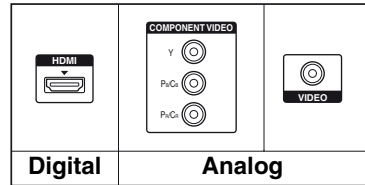

← High quality image

Converting video signals

This receiver is equipped with a function for up-converting video signals. For details, see “Function for conversion of video signals” (page 34).

Notes

- Before connecting cords, be sure to disconnect the AC power cord (mains lead).
- It is not necessary to connect all the cords. Connect according to the availability of jacks on the connected components.
- Be sure to turn on the receiver when the video and audio signals of a playback component are being output to a TV via the receiver. If the power supply of the receiver is not turned on, neither video nor audio signals will be transmitted.
- When connecting optical digital cords, insert the plugs straight in until they click into place.
- Do not bend or tie optical digital cords.

Tip

All the digital audio jacks are compatible with 32 kHz, 44.1 kHz, 48 kHz, and 96 kHz sampling frequencies.

Connecting components with HDMI jacks

HDMI is the abbreviated name for High-Definition Multimedia Interface. It is an interface which transmits video and audio signals in digital format.

Sony recommends that you connect components to the receiver using an HDMI cable.

By connecting Sony “BRAVIA” Sync-compatible components using HDMI cables, operations can be simplified. See ““BRAVIA” Sync Features” (page 70).

HDMI features

- A digital audio signals transmitted by HDMI can be output from the speakers connected to the receiver. This signal supports Dolby Digital, DTS, and Linear PCM.
- The receiver can receive Multi Linear PCM (up to 8 channels) with a sampling frequency of 192 kHz or less with an HDMI connection.
- Analog video signals input to the VIDEO jack or COMPONENT VIDEO jacks can be up-converted as HDMI signals (page 34). Audio signals are not output from an HDMI TV OUT jack when the image is converted.
- This receiver supports High Bitrate Audio (DTS-HD Master Audio, Dolby TrueHD), Deep Color (Deep Colour), x.v.Color (x.v.Colour) and 3D transmission.
- This receiver supports the Control for HDMI function. For details, see ““BRAVIA” Sync Features” (page 70).

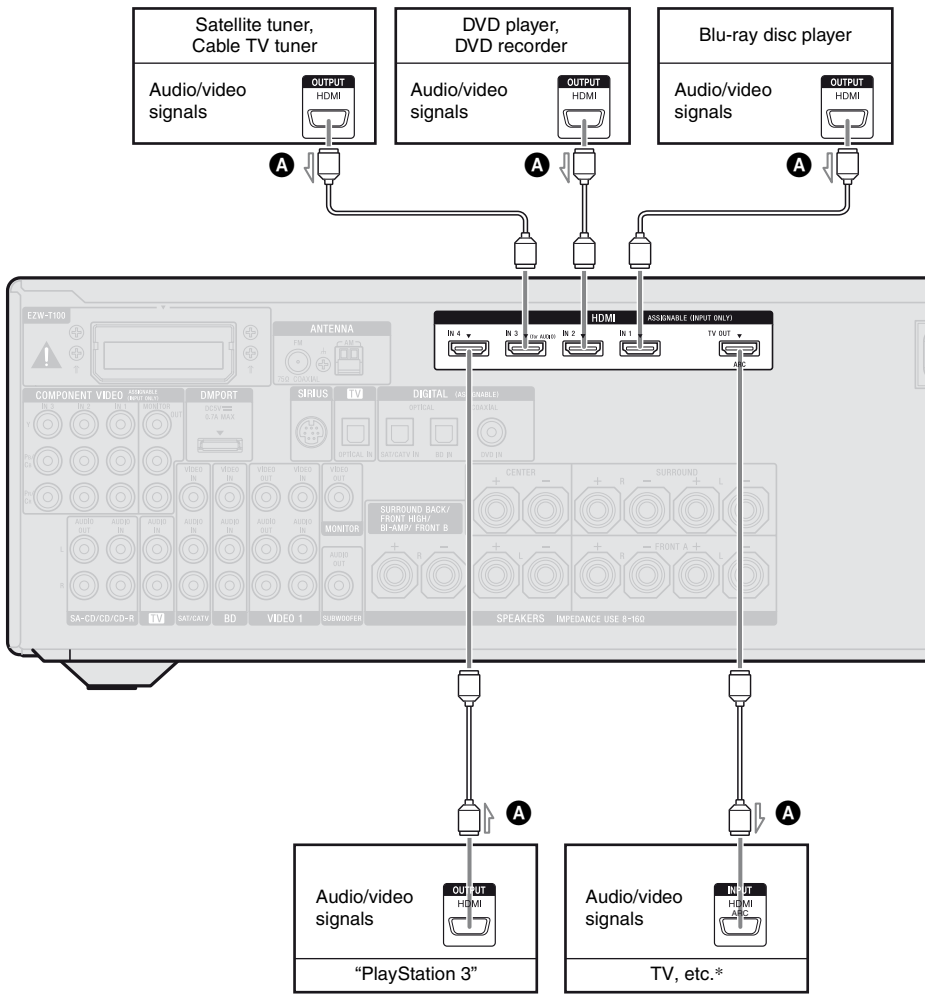

A HDMI cable (not supplied)

Sony recommends that you use an HDMI-authorized cable or Sony HDMI cable.

* For details on the audio connection of TV to the receiver, see page 23.

Notes

- HDMI 3 input has a better sound quality. When you need a higher sound quality, connect your component to the HDMI IN 3 (for AUDIO) jack and select HDMI 3 as input.
- Be sure to change the initial setting of the HDMI 1–4 input button on the remote so that you can use the button to control your components. For details, see “Programming the remote” (page 112).
- You can also rename the HDMI input so that it can be displayed on the receiver’s display. For details, see “Naming the input (Name Input)” (page 47).

Notes on connecting cables

- Use a High Speed HDMI cable. If you use a Standard HDMI cable, 1080p, Deep Color (Deep Colour) or 3D images may not be displayed properly.
- We do not recommend using an HDMI-DVI conversion cable. When you connect an HDMI-DVI conversion cable to a DVI-D component, the sound and/or the image may not be output. Connect other audio cords or digital connecting cords, then set “Input Assign” in the Input Option menu when the sound is not output correctly.

Notes on HDMI connections

- An audio signal input to the HDMI IN jack is output from the SPEAKERS jacks, HDMI TV OUT jack and PHONES jack. It is not output from any other audio jacks.
- Video signals input to the HDMI IN jack can only be output from the HDMI TV OUT jack. The video input signals cannot be output from the VIDEO OUT jacks or MONITOR OUT jacks.
- The audio and video signals of HDMI input are not output from the HDMI TV OUT jack while the GUI menu is displayed.
- When you want to listen to the sound from the TV speaker, set “Audio Out” to “TV+AMP” in the HDMI Settings menu (page 98). If you cannot play back multi channel audio source, set to “AMP”. However, the sound will not output from the TV speaker.
- DSD signals of Super Audio CD are not input and output.
- Be sure to turn on the receiver when the video and audio signals of a playback component are being output to a TV via the receiver. If you set “Pass Through” to “OFF”, video and audio signals will not be transmitted when the power is turned off.
- Audio signals (sampling frequency, bit length, etc.) transmitted from an HDMI jack may be suppressed by the connected component. Check the setup of the connected component if the image is poor or the sound does not come out of a component connected via the HDMI cable.

- Sound may be interrupted when the sampling frequency, the number of channels or audio format of audio output signals from the playback component is switched.
- When the connected component is not compatible with copyright protection technology (HDCP), the image and/or the sound from the HDMI TV OUT jack may be distorted or may not be output. In this case, check the specification of the connected component.
- You can enjoy High Bitrate Audio (DTS-HD Master Audio, Dolby TrueHD), multi channel Linear PCM only with an HDMI connection.
- Set the image resolution of the playback component to more than 720p/1080i to enjoy High Bitrate Audio (DTS-HD Master Audio, Dolby TrueHD).
- The image resolution of playback component may need certain settings be made before you can enjoy multi channel Linear PCM. Refer to the operating instructions of the playback component.
- To enjoy 3D images, connect 3D-compatible TV and video components (Blu-ray disc player, Blu-ray disc recorder, “PlayStation 3”, etc.) to the receiver using High Speed HDMI cables, put on 3D glasses, and then play back a 3D-compatible content.
- Depending on the TV or the video component, 3D images may not be displayed. Check the 3D image formats supported by the receiver (page 130).
- Not every HDMI component supports all functions that are defined by the specified HDMI version. For example, components that support HDMI, version 1.4, may not support Audio Return Channel (ARC).
- Refer to the operating instructions of each connected component for details.

Connecting a Blu-ray disc player

The following illustration shows how to connect a Blu-ray disc player.

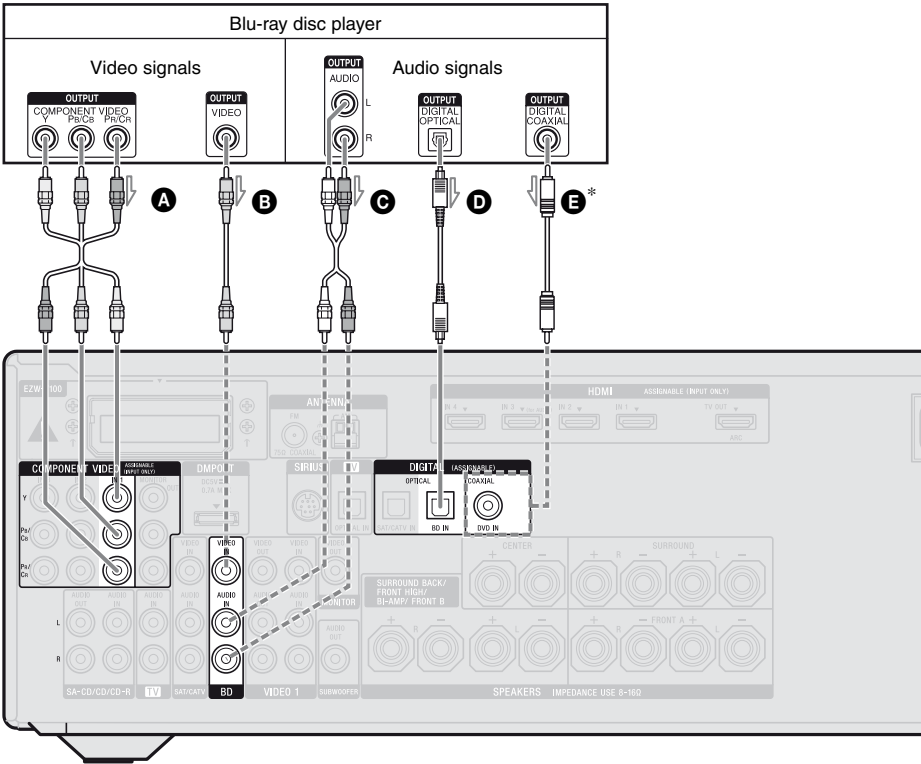

- A** Component video cord (not supplied)
- B** Video cord (not supplied)
- C** Audio cord (not supplied)
- D** Optical digital cord (not supplied)
- E** Coaxial digital cord (not supplied)

—— Recommended connection
 - - - - Alternative connection

* When you connect a component equipped with an COAXIAL jack, set “Input Assign” in the Input Option menu (page 85).

Notes

- The initial setting of the COMPONENT VIDEO IN 1 jacks are Blu-ray disc player. If you want to connect your Blu-ray disc player to the COMPONENT VIDEO IN 2 or IN 3 jacks, set “Input Assign” in the Input Option menu (page 85).
- To input multi channel digital audio from the Blu-ray disc player, set the digital audio output setting on the Blu-ray disc player. Refer to the operating instructions supplied with the Blu-ray disc player.

Connecting a DVD player, DVD recorder

The following illustration shows how to connect a DVD player or DVD recorder.

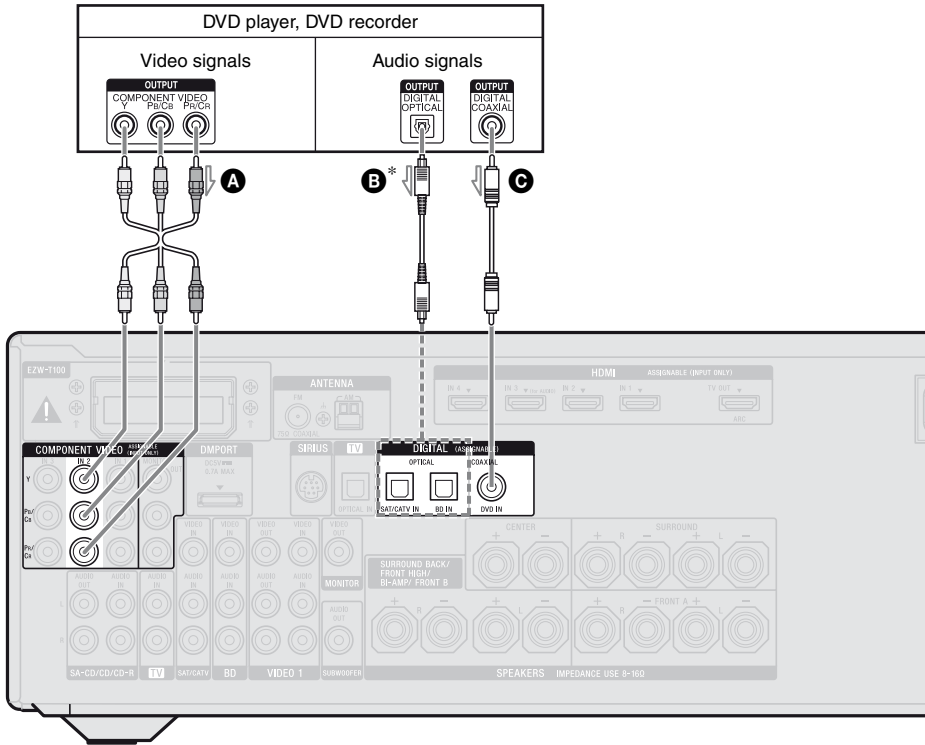

- A** Component video cord (not supplied)
- B** Optical digital cord (not supplied)
- C** Coaxial digital cord (not supplied)

- Recommended connection
- - - - Alternative connection

* When you connect a component equipped with an OPTICAL jack, set “Input Assign” in the Input Option menu.

Notes

- The initial setting for the DVD input button is as follows:
 - RM-AAP051: DVD player
 - RM-AAP052: DVD recorder
 To control other components, be sure to change the initial setting of the DVD input button on the remote. For details, see “Programming the remote” (page 112).
- You can also rename the DVD input so that it can be displayed on the receiver’s display. For details, see “Naming the input (Name Input)” (page 47).
- The initial setting of the COMPONENT VIDEO IN 2 jacks are DVD player or DVD recorder. If you want to connect your DVD player or DVD recorder to the COMPONENT VIDEO IN 1 or IN 3 jacks, set “Input Assign” in the Input Option menu (page 85).
- To input multi channel digital audio from the DVD player or DVD recorder, set the digital audio output setting on the DVD player or DVD recorder. Refer to the operating instructions supplied with the DVD player or DVD recorder.

Connecting a satellite tuner, cable TV tuner

The following illustration shows how to connect a satellite tuner or cable TV tuner.

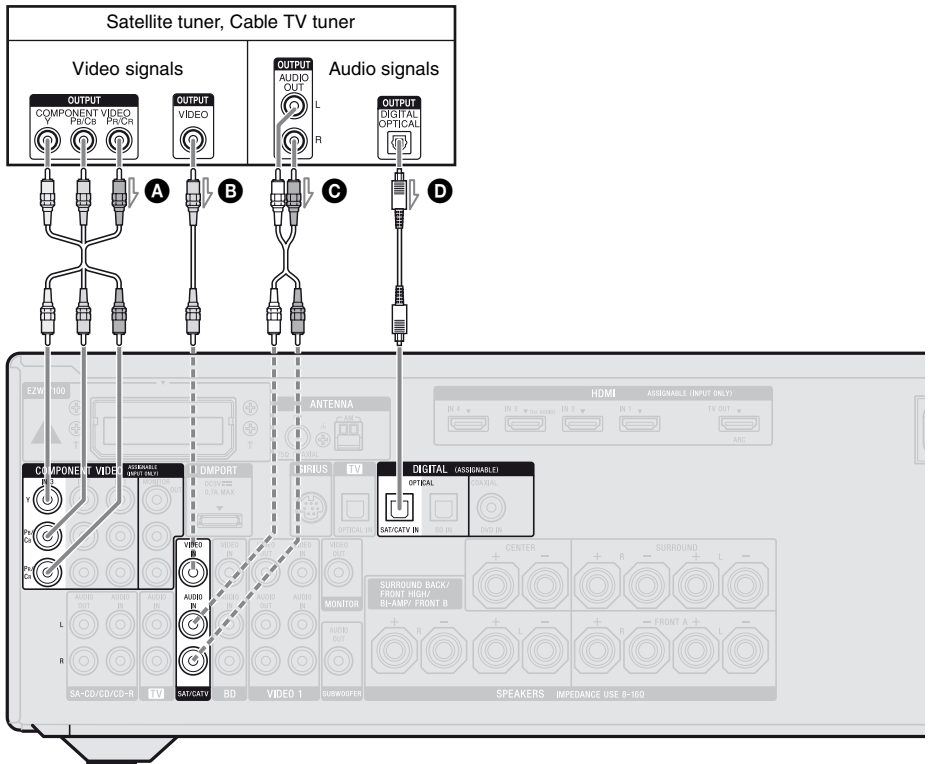

- A** Component video cord (not supplied)
- B** Video cord (not supplied)
- C** Audio cord (not supplied)
- D** Optical digital cord (not supplied)

— Recommended connection
 - - - - Alternative connection

Note

The initial setting of the COMPONENT VIDEO IN 3 jacks are satellite tuner or cable TV tuner. If you want to connect your satellite tuner or cable TV tuner to the COMPONENT VIDEO IN 1 or IN 2 jacks, set “Input Assign” in the Input Option menu (page 85).

Connecting components with analog video and audio jack

The following illustration shows how to connect a component which has analog jacks such as a DVD recorder, VCR, etc.

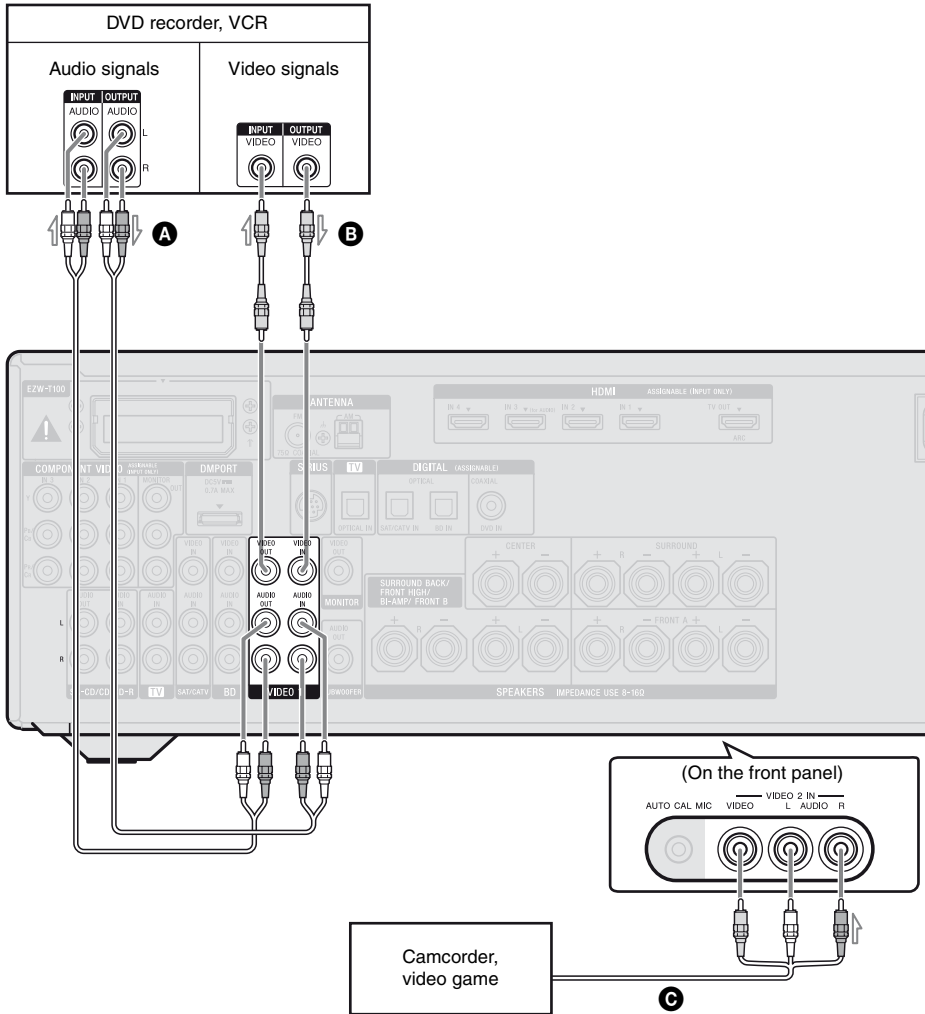

- A** Audio cord (not supplied)
- B** Video cord (not supplied)
- C** Audio/video cord (not supplied)

Notes

- Be sure to change the initial setting of the VIDEO 1 input button on the remote so that you can use the button to control your DVD recorder. For details, see “Programming the remote” (page 112).
- You can also rename the VIDEO 1 input so that it can be displayed on the TV screen and display. For details, see “Naming the input (Name Input)” (page 47).

continued

Function for conversion of video signals

This receiver is equipped with a function for converting video signals.

Video signals and component video signals can be output as HDMI video signals (HDMI TV OUT jack only).

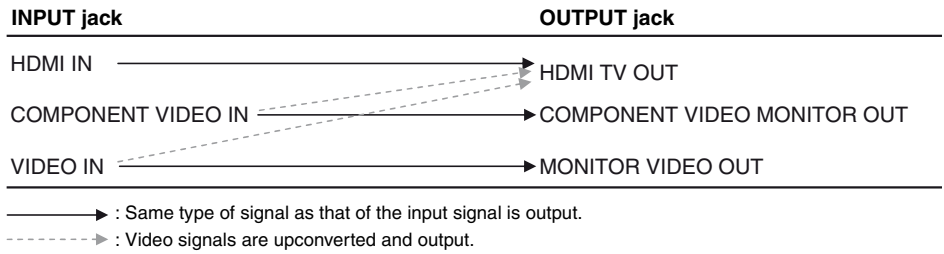

As the initial setting, video signals input from the connected component are output as shown in the table above. We recommend that you set the video conversion function to match the resolution of the monitor you are using. For details, see “Video Settings menu” (page 97).

Notes on converting video signals

- When video signals from a VCR, etc., are converted on this receiver and then output to your TV, depending on the status of the video signal output, the image on the TV screen may appear distorted horizontally or no image may be output.
- HDMI video signals cannot be converted to component video signals and video signals.
- The converted video signals are not output from the MONITOR VIDEO OUT and COMPONENT VIDEO MONITOR OUT jack.
- When you play back a VCR with an image improvement circuit, such as TBC, the images may be distorted or may not be output. In this case, set the image improvement circuit function to off.
- The resolution of the signals output to the HDMI TV OUT jacks are converted up to 1080p.
- COMPONENT VIDEO MONITOR OUT jacks have restrictions on resolution when the resolution of video signals protected by copyright technology is converted. Resolution of up to 480p can be output to the COMPONENT VIDEO MONITOR OUT jacks. The HDMI TV OUT jack has no restriction on resolution.

- Converted HDMI image output does not support x.v.Color (x.v.Colour), Deep Color (Deep Colour) and 3D image.

To connect a recording component

When recording, connect the recording component to the VIDEO OUT jacks of the receiver. Connect cords for input and output signals to the same type of jack, as VIDEO OUT jacks do not have an up-conversion function.

Note

Signals output from the HDMI TV OUT or MONITOR OUT jacks may not be recorded properly.

5: Connecting the antennas (aerials)

Connect the supplied AM loop antenna (aerial) and FM wire antenna (aerial). Before connecting the antennas (aerials), be sure to disconnect the AC power cord (mains lead).

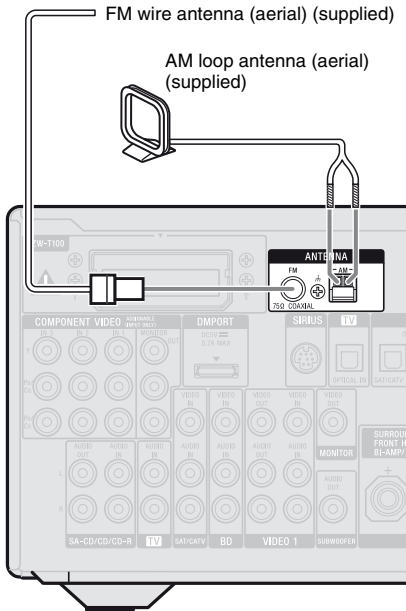

Notes

- To prevent noise pickup, keep the AM loop antenna (aerial) away from the receiver and other components.
- Be sure to fully extend the FM wire antenna (aerial).
- After connecting the FM wire antenna (aerial), keep it as horizontal as possible.

6: Inserting the wireless transmitter/transceiver

To use the S-AIR function, you need to insert the wireless transmitter (not supplied) into the S-AIR main unit and the wireless transceiver (not supplied) into the S-AIR sub unit.

Notes

- Before inserting the wireless transmitter/transceiver, be sure to disconnect the AC power cord (mains lead).
- Do not touch the terminals of the wireless transmitter/transceiver.

To insert the wireless transmitter into the S-AIR main unit

- 1 Remove the screws.

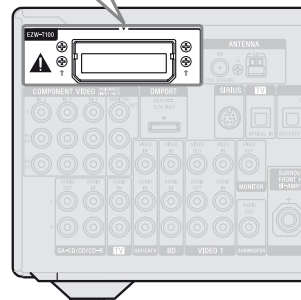
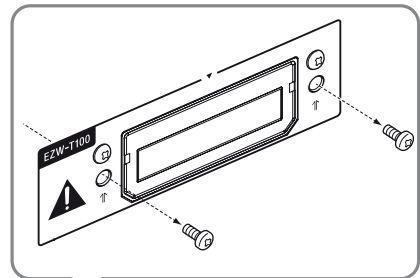

Note

Remove the screws pointed with ↑ mark. Do not remove other screws.

2 Insert the wireless transmitter.

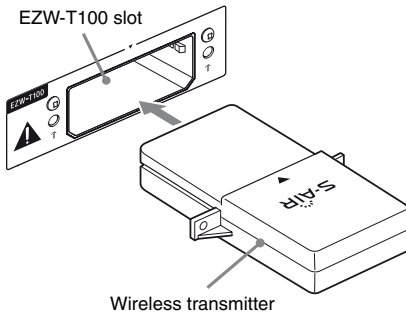

Notes

- Insert the wireless transmitter with the S-AIR logo facing up.
- Insert the wireless transmitter so that the ▼ marks are aligned.
- Do not insert other than the wireless transmitter into the EZW-T100 slot.

3 Use the screws that you removed from step 1 to fasten the wireless transmitter.

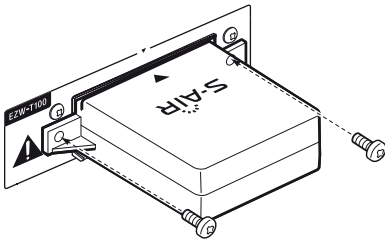

Note

Do not use other screws to fasten the wireless transmitter.

To insert the wireless transceiver into the S-AIR sub unit

Refer to the operating instructions supplied with the surround amplifier and S-AIR receiver.

7: Connecting the AC power cord (mains lead)

Connect the AC power cord (mains lead) to a wall outlet.

Notes

- Before connecting the AC power cord (mains lead), make sure that metallic wires of the speaker cords are not touching each other between the SPEAKERS terminals.
- Connect the AC power cord (mains lead) firmly.

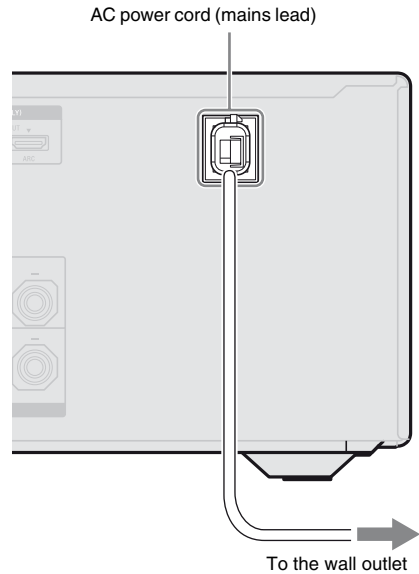

Initializing the receiver

Before using the receiver for the first time, initialize the receiver by performing the following procedure. This procedure can also be used to return settings you have made to their initial settings.

Be sure to use the buttons on the receiver for this operation.

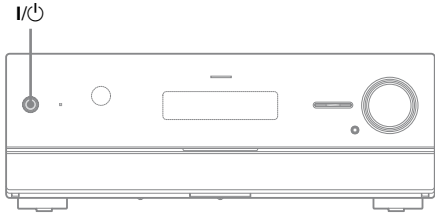

- 1 Press I/O to turn off the receiver.**
- 2 Hold down I/O for 5 seconds.**

After “CLEARING” appears on the display for a while, “CLEARED!” appears.

All the settings you have changed or adjusted are reset to the initial settings.

Selecting the front speaker system

You can select the front speakers you want to drive.

Be sure to use the buttons on the receiver for this operation.

SPEAKERS

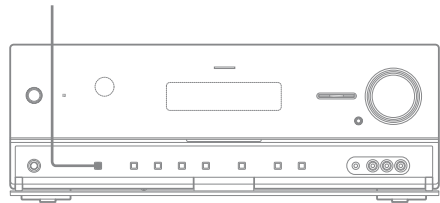

Press SPEAKERS repeatedly to select the front speaker system you want to drive.

To select the front speakers connected to	Light up
The SPEAKERS FRONT A terminals	SP A
The SPEAKERS SURROUND BACK/FRONT HIGH/BI-AMP/FRONT B terminals	SP B*
Both the SPEAKERS FRONT A and SPEAKERS SURROUND BACK/FRONT HIGH/BI-AMP/FRONT B terminals (parallel connection)	SP A B*

* To select “SP B” or “SP A B”, set “SB Assign” to “Speaker B” in the Speaker Settings menu (page 91).

To turn off the speaker output

Press SPEAKERS repeatedly until the “SP A” and “SP B” indicators on the display do not light up. “SPK OFF” appears on the display.

Note

You cannot switch the front speaker system by pressing SPEAKERS when the headphones are connected.

Calibrating the appropriate speaker settings automatically

(Auto Calibration)

This receiver is equipped with DCAC (Digital Cinema Auto Calibration) function which allows you to perform automatic calibration as follows:

- Check the connection between each speaker and the receiver.^{a)}
- Adjust the speaker level.
- Measure the distance of each speaker from your listening position.^{a)b)}
- Measure the speaker size.^{a)}
- Measure the speaker polarity.
- Measure the frequency characteristics.^{a)c)}

^{a)}The measurement result is not utilized when “Analog Direct” is selected.

^{b)}The measurement result is not utilized when signals with a sampling frequency of more than 96 kHz are being received.

^{c)}The measurement result is not utilized when signals with a sampling frequency of more than 48 kHz are being received.

The DCAC is designed to obtain proper sound balance in your room. However, you can adjust the speaker levels and balance manually according to your preference. For details, see “Test Tone” (page 93).

Before you perform Auto Calibration

Before you perform Auto Calibration, check the following items.

- Set up and connect the speakers (page 19–21).
- Connect only the supplied optimizer microphone to the AUTO CAL MIC jack. Do not connect other microphones to this jack.
- Set “SB Assign” to “BI-AMP” in the Speaker Settings menu if you use bi-amplifier connection (page 91).
- Set “SB Assign” to “Speaker B” in the Speaker Settings menu if you use speakers front B connection (page 91).
- Pair the surround amplifier to S-AIR main unit if you want to use surround amplifier.
- Make sure the speaker output is not set to “SPK OFF” (page 37).
- Disconnect the headphones.
- Remove any obstacles in the path between the optimizer microphone and the speakers to avoid measurement errors.
- Make sure the environment is quiet to avoid the effect of noise and get a more accurate measurement.
- Select the seating position as position 1, 2 or 3 to save the Auto Calibration result (page 90).

Notes

- During the measurement, the sound that comes out of the speakers is very loud. The volume of the sound cannot be adjusted. Pay attention to the presence of children or to the effect on your neighborhood.
- If the muting function has been activated before you perform Auto Calibration, the muting function will be set to off automatically.

1: Setting up the Auto Calibration

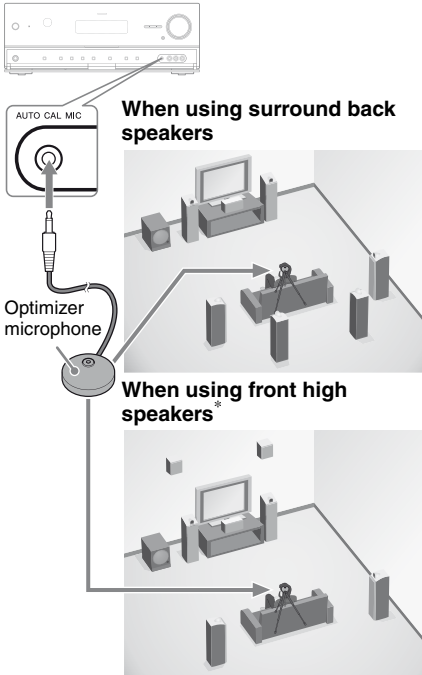

* Be sure to set the speaker pattern setting with front high speakers (page 91).

1 Connect the supplied optimizer microphone to the AUTO CAL MIC jack.

2 Set up the optimizer microphone.

Place the optimizer microphone at your listening position. Use a stool or tripod so that the optimizer microphone remains at the same height as your ears.

On setting up the active subwoofer

- When a subwoofer is connected, turn on the subwoofer and turn up the volume beforehand. Turn the MASTER VOLUME to just before the mid-point.
- If you connect a subwoofer with a crossover frequency function, set the value to maximum.
- If you connect a subwoofer with an auto standby function, set it to off (deactivated).

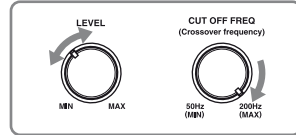

Note

Depending on the characteristics of the subwoofer you are using, the setup distance value may be further away from the actual position.

2: Performing Auto Calibration

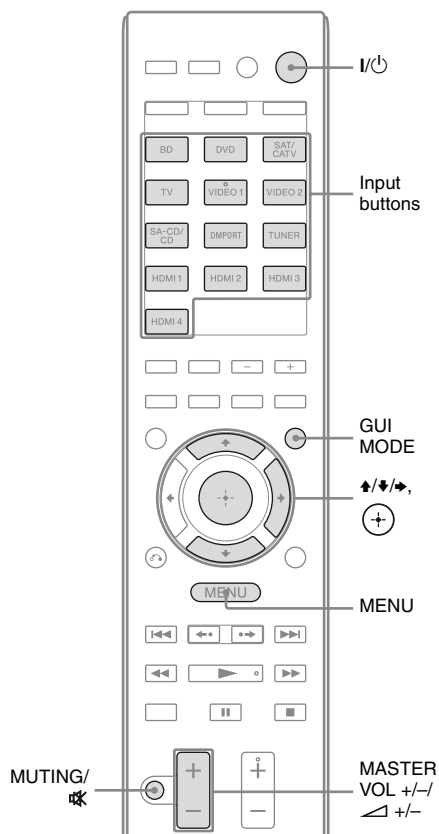

1 Press GUI MODE.

After “MENU ON” appears on the display for a while, “GUI” appears and the GUI menu appears on the TV screen. Press MENU if the GUI menu does not appear on the TV screen.

2 Press \uparrow/\downarrow repeatedly to select “Settings”, then press \oplus or \rightarrow .

The Settings menu list appears on the TV screen.

3 Press \uparrow/\downarrow repeatedly to select “Auto Cal.”, then press \oplus or \rightarrow .

4 Press \uparrow/\downarrow repeatedly to select “Auto Cal. Start”, then press \oplus or \rightarrow .

5 Press \oplus to select “START”.

6 The measurement starts in five seconds.

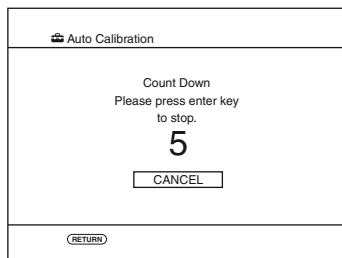

7 Measurement starts.

The measurement process will take approximately 30 seconds with a test tone. Wait until the measurement process completes.

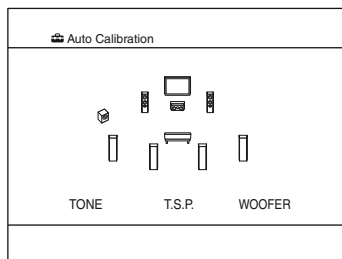

Tips

- Operations other than turning the receiver on or off are deactivated during the measurement.
- The measurements may not be performed correctly or Auto Calibration cannot be performed when special speakers, such as dipole speakers are used.

To cancel Auto Calibration

The Auto Calibration function will be canceled when you do the following during the measurement process:

- Press I/O.
- Press the input buttons on the remote or press the INPUT SELECTOR +/- repeatedly on the receiver.
- Press MUTING (RM-AAP051 only) or  (RM-AAP052 only) on the remote. You can also use MUTING on the receiver.
- Press SPEAKERS on the receiver.
- Change the volume level.
- Connect the headphones.
- Press (+).

3: Confirming/saving the measurement results

1 Confirm the measurement result.

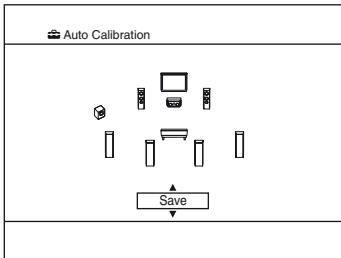

When the measurement ends, a beep sounds.



Note

If an error code appears on the screen, see “Message list after Auto Calibration measurement” (page 43).

2 View the measurement result.

Press / repeatedly to select the item you want, then press (+).

Item and explanation

Retry

Performs the Auto Calibration again.

Save

Saves the measurement results and exits the setting process.

Warning

Displays warning concerning the measurement results. See “Message list after Auto Calibration measurement” (page 43).

Phase*

Displays the phase of each speaker (in phase/out of phase).

Distance

Displays the measurement result for speaker distance.

Level

Displays the measurement result for speaker level.

Exit

Exits the setting process without saving the measurement results.

* When the speaker(s) is (are) out of the phase, “OUT” is displayed on the TV screen. The “+” and “-” terminals of the speaker may be connected the other way around. However, depending on the speakers, “OUT” appears on the TV screen even though the speakers are connected properly. This is because of the speakers’ specifications. In this case, you can continue to use the receiver.

3 Save the measurement result.

Select “Save” in step 2.

4 Select the Auto Calibration Type.

Press $\blacktriangle/\blacktriangledown$ repeatedly to select “Auto Cal. Type”, then press \oplus .

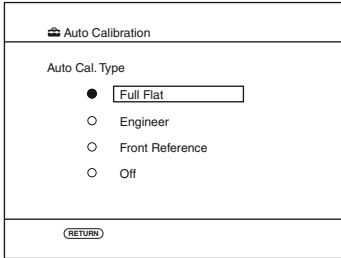

Calibration type and explanation

Full Flat

Makes the measurement of frequency from each speaker flat.

Engineer

Sets the frequency to one that matches that of the Sony listening room standard.

Front Reference

Adjusts the characteristics of all the speakers to match the characteristics of the front speaker.

Off

Sets the Auto Calibration to off.

5 Disconnect the optimizer microphone after you have finished.

Note

If you have reposition your speaker, we recommend that you perform Auto Calibration again to enjoy the surround sound.

Tip

The size of a speaker (“Large”/“Small”) is determined by the low frequency characteristics. The measurement results may vary, depending on the position of the optimizer microphone and speakers, and the shape of the room. It is recommended that you follow the measurement results. However, you can change those settings in the Speaker Settings menu. Save the measurement results first, then try to change the settings if you want.

Message list after Auto Calibration measurement

Display and explanation

Error Code 31

The SPEAKERS is set to off. Set it to others and perform the Auto Calibration again.

Error Code 32

None of the speakers were detected. Make sure that the optimizer microphone is connected properly and perform the measurement again.

If the optimizer microphone is connected properly but the error code appears, the optimizer microphone cable may be damaged or improperly connected.

Error Code 33

- None of the front speakers are connected or only one front speaker is connected.
- The optimizer microphone is not connected.
- Either the surround left or surround right speaker is not connected.
- Surround back speakers or front high speakers are connected even though surround speakers are not connected. Connect the surround speaker(s) to the SPEAKERS SURROUND terminals.
- The surround back speaker is connected only to the SPEAKERS SURROUND BACK/FRONT HIGH/BI-AMP/FRONT B R terminals. When you connect only one surround back speaker, connect it to the SPEAKERS SURROUND BACK/FRONT HIGH/BI-AMP/FRONT B L terminals.
- Either the front left high or front right high speaker is not connected.

Warning 40

The measurement has completed. However, the noise level is high. You may be able to perform the measurement properly if you try it again, even though the measurement cannot be performed in all environments. Try to perform the measurement in a quiet environment.

Warning 41

The sound input from the optimizer microphone is outside the acceptable range. It is louder than the loudest sound that can be measured. Try to perform the measurement when the environment is quiet enough to allow proper measurement.

Warning 42

The volume of the receiver is out of the acceptable range. Try to perform the measurement when the environment is quiet enough to allow proper measurement.

Warning 43

The distance and position of a subwoofer cannot be detected. This may be caused by noise. Try to perform the measurement in a quiet environment.

NO WARNING

There is no warning information.

When “Error Code” appears

Check the error and perform Auto Calibration again.

- 1 When you press ⊕, “RETRY?” appears.
- 2 Press ←/→ to select “YES”.
- 3 Press ⊕.
The measurement starts in five seconds.

When “Warning” appears

If a warning on the measurement result is present, detailed information is displayed.

Press ⊕ to return to step 1 of “3: Confirming/saving the measurement results” (page 41).

Tip

Depending on the position of the subwoofer, the measurement results for polarity may vary. However, there will be no problems even if you continue to use the receiver with that value.

Guide to on-screen display operation

You can display the menu of the receiver on the TV screen and select the function you want to use on the TV screen by pressing $\uparrow/\downarrow/\leftarrow/\rightarrow$ and \oplus on the remote.

To display the menu of the receiver on the TV screen, make sure that the receiver is in “GUI MODE” following the steps in “To turn “GUI MODE” on and off” (page 44).

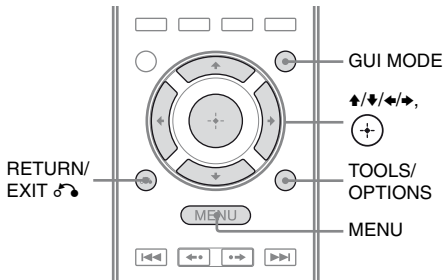

2 Press \uparrow/\downarrow repeatedly to select a menu you want, then press \oplus .

The menu item list appears on the TV screen.

Example: When you select “Settings”.

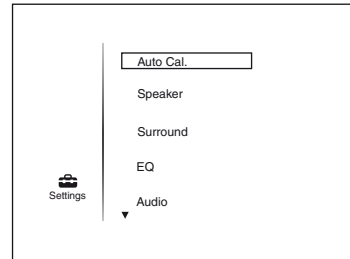

3 Press \uparrow/\downarrow repeatedly to select the menu item you want to adjust, then press \oplus to enter the menu item.

4 Repeat steps 2 and 3 to select the parameter you want.

Using the menu

1 Press GUI MODE.

After “MENU ON” appears on the display for a while, “GUI” appears and the GUI menu appears on the TV screen. Press MENU if the GUI menu does not appear on the TV screen.

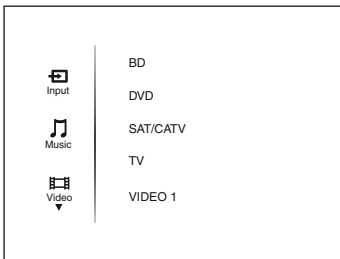

To return to the previous screen

Press RETURN/EXIT \leftarrow .





To exit the menu

Press MENU.

To turn “GUI MODE” on and off

Press GUI MODE. “MENU ON” or “MENU OFF” appears on the display, depending on the mode selected.

Overview of the main menus

Menu icon	Description
 Input	Selects the input source component connected to the receiver (page 46).
 Music	Selects the music from the audio component connected to the DIGITAL MEDIA PORT adapter (page 48).
 Video	Selects the images from the video components connected to the DIGITAL MEDIA PORT adapter (page 48).
 FM/AM/SR	Selects the built-in FM/AM radio or satellite tuner connected (page 53, 57).
 Settings	You can adjust the settings of the speakers, the surround effect, equalizer, audio, video and other inputs connected to the HDMI jacks (page 89).

Using the option menus

When you press TOOLS/OPTIONS, the option menus for the selected main menu are displayed. You can select a related function without reselecting the menu.

1 Press GUI MODE.

After “MENU ON” appears on the display for a while, “GUI” appears and the GUI menu appears on the TV screen. Press MENU if the GUI menu does not appear on the TV screen.

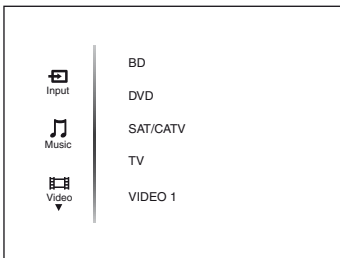

2 Press \uparrow/\downarrow repeatedly to select a menu you want, then press \oplus or \rightarrow to enter the menu.

The menu item list appears on the TV screen.

Example: when you select “Input”.

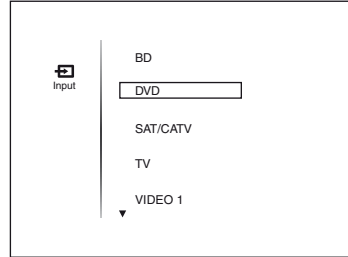

3 Press TOOLS/OPTIONS while the menu item list is displayed.

The option menu appears.

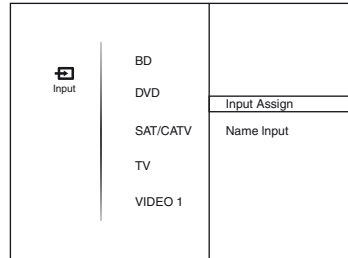

4 Press \uparrow/\downarrow repeatedly to select the option menu item you want, then press \oplus or \rightarrow .

5 Press \uparrow/\downarrow repeatedly to select the parameter you want, then press \oplus .

To exit the menu

Press MENU.

Playback

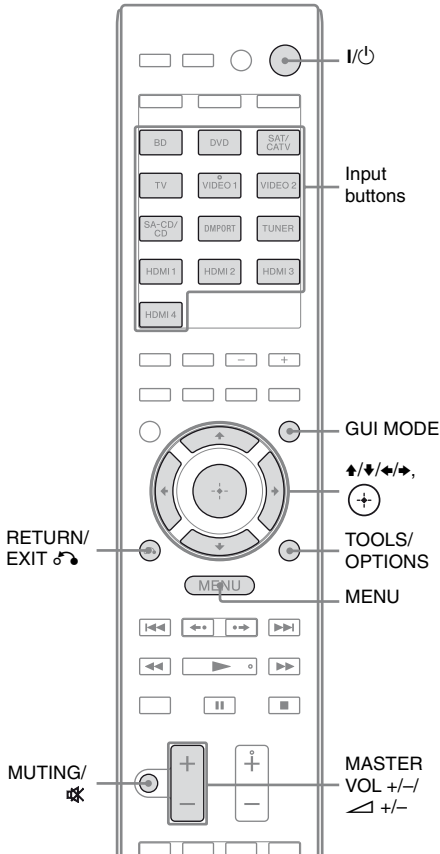

1 Press GUI MODE.

After "MENU ON" appears on the display for a while, "GUI" appears and the GUI menu appears on the TV screen. Press MENU if the GUI menu does not appear on the TV screen.

2 Press \uparrow/\downarrow repeatedly to select "Input", then press \oplus or \rightarrow .

The menu item list appears on the TV screen.

3 Press \uparrow/\downarrow repeatedly to select the component you want, then press \oplus .

The selected input appears on the TV screen.

4 Turn on the component and start playback.

5 Press MASTER VOL +/- (RM-AAP051 only) or \triangle +/- (RM-AAP052 only) to adjust the volume.

You can also use MASTER VOLUME on the receiver.

6 Press SOUND FIELD +/- to enjoy the surround sound.

You can also use 2CH/A.DIRECT, A.F.D., MOVIE, MUSIC button on the receiver.

For details, see page 65.

Tips

- You can press INPUT SELECTOR +/- on the receiver repeatedly or press input buttons on the remote to select the component you want.
- You can adjust the volume differently depending on the speed with which you turn the MASTER VOLUME on the receiver.
 - To turn the volume up or down quickly: turn the knob quickly.
 - To make fine adjustment: turn the knob slowly.
- You can adjust the volume differently depending on the length of time you press and hold the MASTER VOL +/- (RM-AAP051 only) or \triangle +/- (RM-AAP052 only) button on the remote.
 - To turn the volume up or down quickly: press and hold the button.
 - To make a fine adjustment: press the button and release it immediately.

To activate the muting function

Press MUTING (RM-AAP051 only) or  (RM-AAP052 only) on the remote.

You can also use MUTING on the receiver. The muting function will be canceled when you do the following.

- Press MUTING (RM-AAP051 only) or  (RM-AAP052 only) again.
- Increase the volume.
- Turn off the receiver.
- Perform Auto Calibration.



To avoid damaging your speakers

Before you turn off the receiver, be sure to turn down the volume level.



Naming the input (Name Input)

You can enter a name of up to 8 characters for inputs and display it.

This is convenient for labeling the jacks with the names of the connected components.

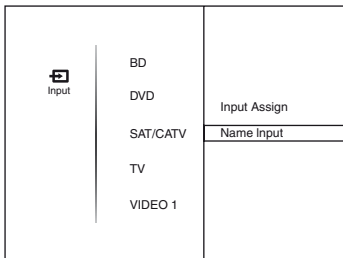
- 1 Press  repeatedly on the “Input” screen to select the input you want.**
- 2 Press TOOLS/OPTIONS.**
The option menu appears.
- 3 Press  repeatedly to select “Name Input”, then press .**



- 4 Press  to select a character, then press .**

The name you entered is registered.

To cancel naming input

Press RETURN/EXIT .

Viewing information on the display

You can check the sound field, etc., by changing the information on the display.

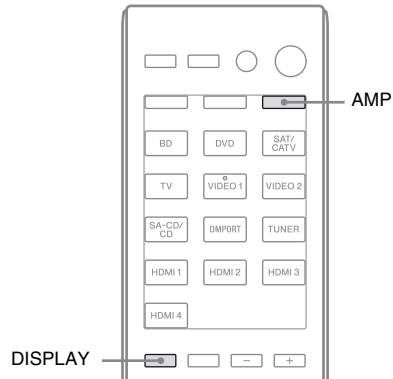

Press AMP, then press DISPLAY repeatedly.

You can also use DISPLAY on the receiver. Each time you press DISPLAY, the display will change as follows.

Input name you selected^{a)} → Original input name → Sound field currently applied → Volume level → Stream information

FM and AM band

Program Service name^{b)} or preset station name^{a)} → Frequency → Program Type indication^{b)} → Radio Text indication^{b)} → Current Time indication (in 24-hour system mode)^{b)} → Sound field currently applied → Volume level

SIRIUS Satellite Radio (Models of area code U2, CA2 only)

Channel name → Channel number →

Category name → Artist name/Feature →

Song/program title → Composer name →

Signal strength → Sound field type →

Volume level

^{a)} Index name appears only when you have assigned one to the input or preset station (page 56). Index name does not appear when only blank spaces have been entered or it is the same as the input name.

^{b)} During RDS reception only (Models of area code CEK, ECE, AU1, TW2 only) (page 56).

Note

Character or marks may not be displayed for some languages.

Tip

You cannot switch the display while “GUI” is shown on the display. Press GUI MODE repeatedly to select “MENU OFF”.

Enjoying sound/images from the components connected to the DIGITAL MEDIA PORT

The DIGITAL MEDIA PORT (DMPORT) allows you to enjoy picture and sound from a network system such as a portable audio/video source or computer.

For details on connecting the DIGITAL MEDIA PORT adapter, see “Connecting audio components” (page 24).

You can use the following Sony DIGITAL MEDIA PORT adapters:

- TDM-BT1/BT10 Bluetooth™ Wireless Audio Adapter
- TDM-NW10 DIGITAL MEDIA PORT Adapter
- TDM-NC1 Wireless Network Audio Client
- TDM-iP10/iP50 DIGITAL MEDIA PORT Adapter
- TDM-MP10 DIGITAL MEDIA PORT Adapter

The DIGITAL MEDIA PORT adapter is an optional product.

Notes

- Do not connect an adapter other than the DIGITAL MEDIA PORT adapter to the DMPORT jack.
- Before disconnecting the DIGITAL MEDIA PORT adapter, be sure to turn off the receiver.
- Do not connect or disconnect the DIGITAL MEDIA PORT adapter while the receiver is turned on.
- Depending on the type of DIGITAL MEDIA PORT adapter, video output may not be possible.
- The DIGITAL MEDIA PORT adapters are available for purchase depending on the area.

Selecting the operation screen

You can select an operation screen using the GUI menu, depending on the DIGITAL MEDIA PORT adapter you want to use. For some adapter, such as TDM-BT1, the operation screen is fixed and you cannot change it on the GUI screen.

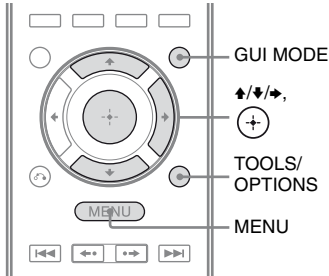

1 Press GUI MODE.

After “MENU ON” appears on the display for a while, “GUI” appears and the GUI menu appears on the TV screen. Press MENU if the GUI menu does not appear on the TV screen.

2 Press \uparrow/\downarrow repeatedly to select “Music” or “Video”, then press \oplus or \rightarrow .

3 Press TOOLS/OPTIONS.

The option menu appears.

4 Press \uparrow/\downarrow repeatedly to select the mode you want, then press \oplus .

The details of each mode are as follows:

- System GUI
This mode is for the TDM-iP50 and TDM-NC1. The list of tracks will be displayed on the GUI screen of the receiver. You can select a track you want and play it back on each GUI screen.
- iPod
This mode is for the TDM-iP50.

If the option menu does not appear on the screen, refer to the operating instructions of the connected component.

When an adapter other than iPod is connected, a hierarchical menu does not appear.

Operating the component connected to the DIGITAL MEDIA PORT adapter

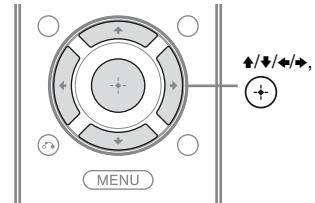

To operate the TDM-iP50 or TDM-NC1 using the GUI menu of the receiver

1 Make sure that “System GUI” is selected in step 4 in “Selecting the operation screen” (page 49).

2 Press $\uparrow/\downarrow/\leftarrow/\rightarrow$ repeatedly to select the content you want from the contents list displayed on the GUI screen, then press \oplus to play it back.

The following content lists are just examples. They may vary depending on the components connected to the receiver.

Contents list for audio

- iPod — Playlists > Playlist > Track
- Artists > Artist > Album > Track
- Albums > Album > Track
- Songs > Track
- Genres > Genre > Artist > Album > Track
- Composers > Composer > Track
- Audiobooks > Audiobook > Track

- Network Client — Music Surfin^{a)} > Album^{c)} > Track
- Playlist^{a)} > Playlist > Track
- Web Radio^{a)} > Station > Program
- Music Library^{b)} > Album > Track

^{a)} Displayed only when M-crew Server is connected.

^{b)} Displayed only when a DLNA server other than M-crew Server is connected.

^{c)} Displayed as “Genre”, “Artist” or “Album”, depending on setting of “List Mode”.

Contents list for video

- iPod — Movies > Content
- TV Shows > Episode > Content
- Music Videos > Artist > Content
- Video Playlists > Video Playlist > Content
- Video Podcasts > Episode > Content

3 Press MASTER VOL +/- (RM-AAP051 only) or \triangle +/- (RM-AAP052 only) to adjust the volume.

To operate the TDM-iP50 using the iPod menu

Make sure that “iPod” is selected in step 4 in “Selecting the operation screen” (page 49).

For details on operating the iPod, refer to the operating instructions supplied with the iPod.

Playing the selected track

During playback of the selected track, the displayed screen changes depending on the DIGITAL MEDIA PORT adapter connected.

Example of a “System GUI” screen

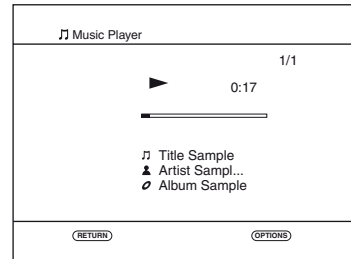

You can operate the components connected to the DIGITAL MEDIA PORT adapter using the following buttons on the remote of the receiver.

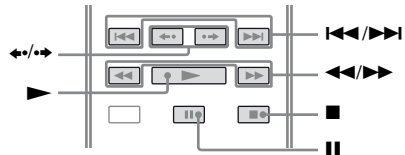

To	Do the following
Play	Press ▶ .
Pause	Press ⏸ . To resume play, press the button again.
Stop	Press ■ .
Find the beginning of a track during playback, or find the beginning of the previous track	Press ⏮ .
Find the beginning of the next track	Press ⏭ .
Skip to the previous/next album	Press ◀/▶ .
Go backward/forward	Press ◀/▶ .*

* Fast-backward/forward while pressing and holding the **◀/▶** button.

Selecting the playback mode

1 Play back the track you want to listen to following the steps in “Operating the component connected to the DIGITAL MEDIA PORT adapter” (page 49).

2 Press **TOOLS/OPTIONS**.
The option menu appears.

3 Press **▲/▼** repeatedly to select “Repeat”, “Shuffle”, “List Mode” or “Audiobook”, then press **+** or **▶**.

4 Press **▲/▼** repeatedly to select the mode you want to select from the following, then press **+**.

■ Repeat (TDM-iP50 only)

- OFF
- One
- All

■ Shuffle (TDM-iP50 only)

- OFF
- Songs
- Albums

■ List Mode (TDM-NC1 only)

- All Tracks
- Disc List
- Artist List
- Genre List

■ Audiobook (TDM-iP50 only)

- Low
- Normal
- High

DIGITAL MEDIA PORT message list

Message and explanation
No Adapter The adapter is not connected.
No Device There is no device connected to the adapter.
No Audio No audio file was found.
Loading The data is being read.
No Server* There is no server connected.
No Track* No track was found.
No Item No item was found.
Connecting* Connecting to the server.
Configuring* The network is setting up.
Warning* Check the display of the DIGITAL MEDIA PORT adapter.
Searching* Searching the server.

* TDM-NC1 only.

Using the Sleep Timer

You can set the receiver to turn off automatically at a specified time.

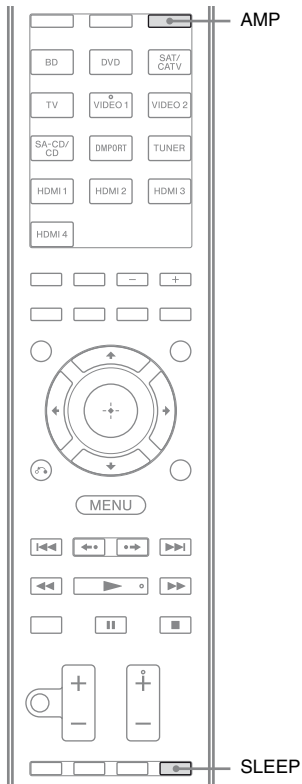

Press AMP, then press SLEEP repeatedly while the power is on.

“SLEEP” lights up on the display.

Each time you press the button, the display changes cyclically as follows:

0:30:00 → 1:00:00 → 1:30:00 → 2:00:00
→ OFF

Tip

To check the remaining time before the receiver turns off, press SLEEP. The remaining time appears on the display. If you press SLEEP again, the Sleep Timer will be canceled.

Recording using the receiver

You can record from a video/audio component using the receiver. Refer to the operating instructions supplied with your recording component.

Recording onto a CD-R

You can record onto a CD-R using the receiver. Refer to the operating instructions supplied with your CD recorder.

1 Press one of the input buttons to select the playback component.

You can also use INPUT SELECTOR +/- on the receiver.

2 Prepare the playback component for playing.

For example, tune to the radio station you want to record (page 53).

3 Prepare the recording component.

Insert a blank CD-R into the CD recorder and adjust the recording level.

4 Start recording on the recording component, then start playback on the playback component.

Note

Sound adjustments do not affect the signal output from the SA-CD/CD/CD-R AUDIO OUT jacks.

Recording onto a recording media

1 Press the input button of the playback component.

You can also use INPUT SELECTOR +/- on the receiver.

2 Prepare the playback component for playing.

For example, insert the video tape you want to copy into the VCR.

3 Prepare the recording component.

Insert a blank video tape, etc. into the recording component (connected to VIDEO 1 OUT jacks) for recording.

4 Start recording on the recording component, then start playback on the playback component.

Notes

- Some sources contain copy guards to prevent recording. In this case, you may not be able to record from the source.
- Only analog input signals are output from the analog output jack (for recording).
- HDMI sound cannot be recorded.

Tuner Operations

Listening to FM/AM radio

You can listen to FM and AM broadcasts through the built-in tuner. Before operation, make sure you have connected the FM and AM antennas (aerials) to the receiver (page 35).

Tip

The tuning scale for direct tuning differs depending on the area code as shown in the following table. For details on area codes, see page 4.

Area code	FM	AM
U2, CA2	100 kHz	10 kHz*
CEK, ECE, AU1, TW2	50 kHz	9 kHz

* The AM tuning scale can be changed (page 55).

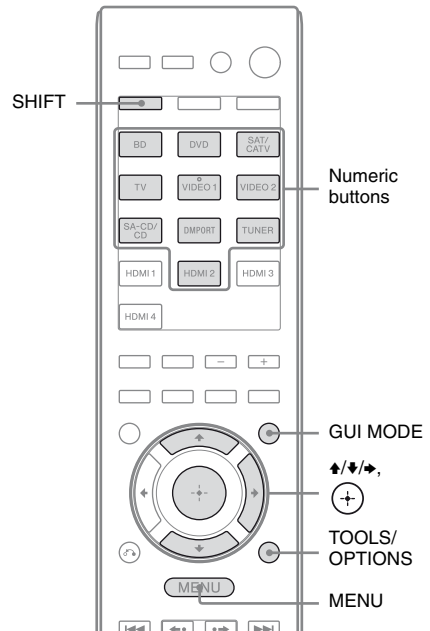

Tuning into a station automatically (Auto Tuning)

1 Press GUI MODE.

After “MENU ON” appears on the display for a while, “GUI” appears and the GUI menu appears on the TV screen. Press MENU if the GUI menu does not appear on the TV screen.

2 Press \uparrow/\downarrow repeatedly to select “FM” or “AM”, then press \oplus or \blacktriangleright .

The FM or AM menu list appears on the TV screen.

3 Press \uparrow/\downarrow repeatedly to select “Auto Tuning”, then press \oplus or \blacktriangleright .

4 Press \uparrow/\downarrow .

Press \uparrow to scan from low to high, press \downarrow to scan from high to low.

The receiver stops scanning whenever a station is received.

If in case of poor FM stereo reception

1 Tune in the station you want to listen to using Auto Tuning, Direct Tuning (page 54), or select the preset station you want (page 55).

2 Press TOOLS/OPTIONS.

3 Press \uparrow/\downarrow repeatedly to select “FM Mode”, then press \oplus or \blacktriangleright .

4 Press \uparrow/\downarrow repeatedly to select “MONO”, then press \oplus .

Tuning into a station directly (Direct Tuning)

You can enter the frequency of a station directly by using the numeric buttons.

1 Press GUI MODE.

After “MENU ON” appears on the display for a while, “GUI” appears and the GUI menu appears on the TV screen. Press MENU if the GUI menu does not appear on the TV screen.

2 Press \uparrow/\downarrow repeatedly to select “FM” or “AM”, then press \oplus or \blacktriangleright .

The FM or AM menu list appears on the TV screen.

3 Press \uparrow/\downarrow repeatedly to select “Direct Tuning”, then press \oplus or \blacktriangleright .

4 Press SHIFT, then press numeric buttons to enter the frequency.

Example 1: FM 102.50 MHz

Select 1 \rightarrow 0 \rightarrow 2 \rightarrow 5 (\rightarrow 0*)

Example 2: AM 1,350 kHz

Select 1 \rightarrow 3 \rightarrow 5 \rightarrow 0

* Press 0 for models of area code CEK, ECE, AU1, TW2 only.

Tip

If you have tuned in an AM station, adjust the direction of the AM loop antenna (aerial) for optimum reception.

5 Press \oplus .

If you cannot tune in a station

“--- -- MHz” appears and then the screen returns to the current frequency.

Make sure you have entered the right frequency. If not, repeat step 4. If you still cannot tune in a station, the frequency is not used in your area.

Changing the AM tuning scale

(Models of area code U2, CA2 only)

You can change the AM tuning scale to either 9 kHz or 10 kHz on the receiver.

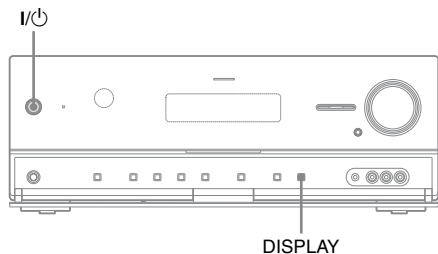

- 1 Press I/⏻ to turn off the receiver.**
- 2 While holding down DISPLAY, press I/⏻ on the receiver.**
- 3 Change the current AM tuning scale to 9 kHz (or 10 kHz).**

To reset the scale to 10 kHz (or 9 kHz), repeat the procedure above.

Note

All preset stations will be erased when you change the tuning scale.

Presetting FM/AM radio stations (Preset Tuning)

You can preset up to 30 FM and 30 AM stations. Then you can easily tune in the stations you often listen to.

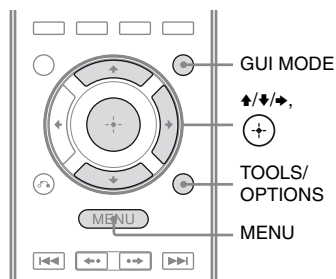

- 1 Press GUI MODE.**

After “MENU ON” appears on the display for a while, “GUI” appears and the GUI menu appears on the TV screen. Press MENU if the GUI menu does not appear on the TV screen.
- 2 Press \uparrow/\downarrow repeatedly to select “FM” or “AM”, then press \oplus or \rightarrow .**

The FM or AM menu list appears on the TV screen.
- 3 Tune in the station that you want to preset using Auto Tuning (page 54) or Direct Tuning (page 54).**

In case of poor FM stereo reception, switch the FM reception mode (page 54).
- 4 Press TOOLS/OPTIONS.**

The option menu appears.
- 5 Press \uparrow/\downarrow repeatedly to select “Memory”, then press \oplus or \rightarrow .**

- 6 Press **▲/▼** repeatedly to select a preset number, then press **⊕**.

The station is stored as the selected preset number.

- 7 Repeat steps 3 to 6 to preset another station.

You can store station as follows:

- AM band: AM 1 to AM 30
- FM band: FM 1 to FM 30

Tuning to preset stations

- 1 Repeat steps 1 and 2 of “Presetting FM/AM radio stations (Preset Tuning)”.

- 2 Press **▲/▼** repeatedly to select the preset station you want.

Preset numbers from 1 to 30 are available.

Naming preset stations (Name Input)

- 1 On “FM” or “AM” screen, press **▲/▼** repeatedly to select the preset number on which you have stored the station and which you want to name.

- 2 Press **TOOLS/OPTIONS**.

The option menu appears.

- 3 Press **▲/▼** repeatedly to select “Name Input”, then press **⊕** or **→**.

- 4 Press **▲/▼/←/→** to select a character, then press **⊕**.

The name you entered is registered.

Using the Radio Data System (RDS)

(Models of area code CEK, ECE, AU1, TW2 only)

This receiver allows you to use Radio Data System (RDS), which enables radio stations to send additional information along with the regular program signal. This receiver offers convenient RDS features, such as Program Service name display.

Notes

- RDS is operable only for FM stations.
- Not all FM stations provide RDS service, nor do they provide the same type of services. If you are not familiar with the RDS services in your area, check with your local radio stations for details.

Receiving RDS broadcasts

Simply select a station on the FM band using **Direct Tuning (page 54)**, **Auto Tuning (page 54)**, or **Preset Tuning (page 55)**.

When you tune in a station that provides RDS services, “RDS” lights up and the program service name appears on the display.

Note

RDS may not work properly if the station you tuned to is not transmitting the RDS signal properly or if the signal strength is weak.

Tip

When a Program Service name is displayed, you can check the frequency by pressing **DISPLAY** repeatedly (page 47).

Listening to Satellite Radio

(Models of area code U2, CA2 only)

To listen to Satellite Radio, you'll need to connect a SIRIUS Satellite Radio tuner (sold separately) to your Sirius-Ready receiver. SIRIUS Satellite Radio is available to residents of the US (except Alaska and Hawaii) and Canada.

Satellite Radio delivers a variety of commercial-free music from categories ranging from Pop, Rock, Country, R&B, Dance, Jazz, Classical and many more plus coverage of all the top professional and college sports including play by play games from select leagues and teams. Additional programming includes expert sports talk, uncensored entertainment, comedy, family programming, local traffic and weather and news from your most trusted sources.

Once you've purchased a SIRIUS tuner you'll need to activate it and subscribe to begin enjoying the service. Easy to follow installation and setup instructions are provided with the SIRIUS tuner. There are a variety of programming packages available, including the option of adding "The Best of XM" programming to the SIRIUS service. The "Best of XM" service is not available to SIRIUS Canada subscribers at this time. Please check with SIRIUS Canada for any updates using the numbers and web address below.

Family friendly packages are also available to restrict channels featuring content that may be inappropriate for children.

To subscribe to SIRIUS, U.S. and Canadian customers can call 1-888-539-SIRI (1-888-539-7474) or visit sirius.com (US) or siriuscanada.ca (Canada).

SIRIUS and all related marks and logos are trademarks of Sirius XM Radio Inc. and its subsidiaries. All other marks and logos are the property of their respective owners. All rights reserved. SIRIUS subscription sold separately. Taxes and a one-time activation fee may apply. SIRIUS tuner required (sold separately) to receive the SIRIUS service. All programming and fees subject to change. It is prohibited to copy, decompile, disassemble, reverse engineer, hack, manipulate or otherwise make available any technology or software incorporated in receivers compatible with the SIRIUS Satellite Radio System. **Service not available in Alaska or Hawaii.**

Connecting the SIRIUS Satellite Radio

Connect the SiriusConnect Home tuner. When you use the SiriusConnect Home tuner with this receiver, be sure to connect the AC power adaptor supplied with the tuner to a wall outlet.

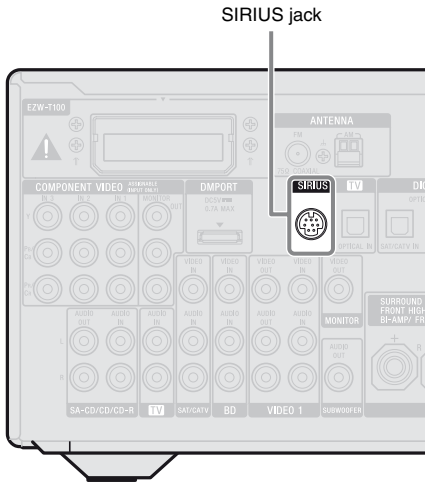

Note

Keep the SiriusConnect Home tuner, antenna, and AC power adaptor away from the speaker cords and the power cord to avoid picking up noise.

Preparing to listen to the SIRIUS Satellite Radio

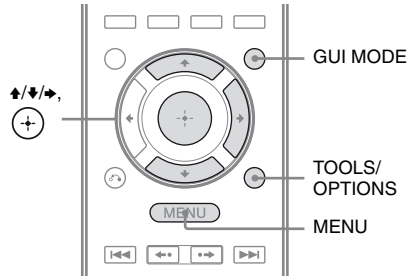

Checking the SIRIUS Radio ID

- 1 Press GUI MODE.**
After “MENU ON” appears on the display for a while, “GUI” appears and the GUI menu appears on the TV screen. Press MENU if the GUI menu does not appear on the TV screen.
- 2 Press \uparrow/\downarrow repeatedly to select “SR”, then press \oplus or \rightarrow .**
- 3 Press TOOLS/OPTIONS, then press \uparrow/\downarrow repeatedly to select “Sirius ID”, then press \oplus or \rightarrow .**
- 4 Check the SIRIUS ID on the TV screen and write it in the space provided here.**
ID: _____

You can also check the SIRIUS ID using the display on the receiver.

Checking receiving conditions (Antenna Aiming)

- 1 Press GUI MODE.**

After “MENU ON” appears on the display for a while, “GUI” appears and the GUI menu appears on the TV screen. Press MENU if the GUI menu does not appear on the TV screen.
- 2 Press \uparrow/\downarrow repeatedly to select “SR”, then press \oplus or \rightarrow .**
- 3 Press TOOLS/OPTIONS, then press \uparrow/\downarrow repeatedly to select “Antenna”, then press \oplus or \rightarrow .**
- 4 While checking the quality of the reception, adjust the direction of the antenna to obtain the best reception.**

To exit the menu

Press MENU.

Selecting a channel of the SIRIUS Satellite Radio

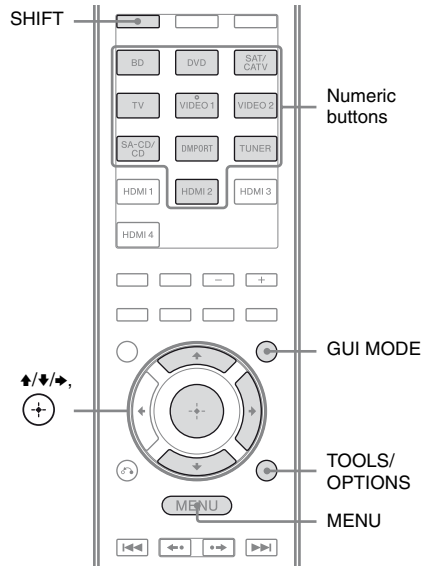

Selecting a channel by category (Category Mode)

You can select a channel from one category or all the categories.

- 1 Press GUI MODE.**

After “MENU ON” appears on the display for a while, “GUI” appears and the GUI menu appears on the TV screen. Press MENU if the GUI menu does not appear on the TV screen.
- 2 Press \uparrow/\downarrow repeatedly to select “SR”, then press \oplus or \rightarrow .**

3 Press **▲/▼** repeatedly to select the category, then press **(+)** or **▶**.

- All: You can select a channel from all the categories.
- (category name): You can select a channel from one category.

Note

When the “Preset Mode” screen is displayed, press **TOOLS/OPTIONS**, then press **▲/▼** repeatedly to select “Category Mode”.

4 Press **▲/▼** repeatedly to select the channel, then press **(+)**.

The selected channel is being received.
The channel information is displayed on the TV screen.

Note

When you select a channel in the “Category Mode”, the channel you selected may not be the one in the category you want. This is because one channel may belong to more than one category.

Selecting a channel by inputting the channel number directly (Direct Tuning)

1 Press **GUI MODE**.

After “MENU ON” appears on the display for a while, “GUI” appears and the GUI menu appears on the TV screen. Press **MENU** if the GUI menu does not appear on the TV screen.

2 Press **▲/▼** repeatedly to select “SR”, then press **(+)** or **▶**.

3 Press **TOOLS/OPTIONS**.

The option menu appears.

4 Press **▲/▼** repeatedly to select “Direct Tuning”, then press **(+)** or **▶**.

5 Press **SHIFT**, then press the numeric buttons to enter the channel number.

6 Press **(+)**.

The selected channel is tuned in.

Presetting SIRIUS Satellite Radio channels

You can select the channels you want directly by presetting them using the preset numbers. You can preset up to 30 SIRIUS Satellite Radio channels.

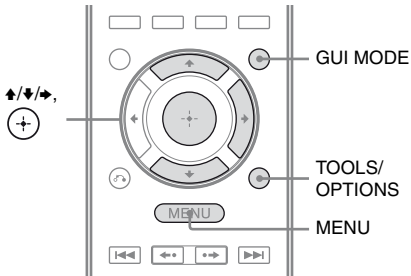

Presetting channels using the preset numbers

- 1 Press GUI MODE.**
After “MENU ON” appears on the display for a while, “GUI” appears and the GUI menu appears on the TV screen. Press MENU if the GUI menu does not appear on the TV screen.
- 2 Press \uparrow/\downarrow repeatedly to select “SR”, then press \oplus or \rightarrow .**
- 3 Select a channel you want to preset using Category Tuning (page 59) or Direct Tuning (page 60).**
- 4 Press TOOLS/OPTIONS.**
The option menu appears.
- 5 Press \uparrow/\downarrow repeatedly to select “Memory”, then press \oplus or \rightarrow .**

- 6 Press \uparrow/\downarrow repeatedly to select the preset channel you want, then press \oplus .**

Preset channels from 1 to 30 are available, and a default channel is preset for all the preset channels when you purchase the receiver.

The selected channel is registered as the preset channel you selected in step 3.

- 7 Repeat steps 3 to 6 to preset another channel.**

Selecting the channel by using the preset numbers

- 1 Repeat steps 1 and 2 of “Presetting channels using the preset numbers” (page 61).**
- 2 Press \uparrow/\downarrow repeatedly to select the preset number from the preset list, then press \oplus .**

You can select stored preset channels from 1 to 30.

Notes

- The channel information you have preset may be changed if SIRIUS Satellite Radio Inc. change their channel programming.
- When the “Category Mode” screen is displayed, press TOOLS/OPTIONS, then press \uparrow/\downarrow repeatedly to select “Preset Mode”.

Restricting access to specific channels (Parental Lock)

You can restrict access to certain channels using your own lock code. The lock code is set to “0000” as the default. Change the lock code before you use this function for the first time. See “To change the lock code (Lock Code)” (page 62).

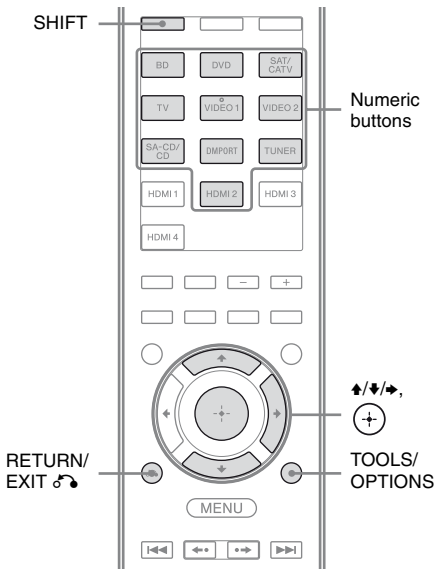

- 1** Select a channel you want to lock using **Category Mode** (page 59) or **Direct Tuning** (page 60).
- 2** Press **TOOLS/OPTIONS**.
The option menu appears.
- 3** Press **▲/▼** repeatedly to select “**Parental Lock**”, then press **⊕** or **➡**.

- 4** Press **▲/▼** repeatedly to select “**ON**”, then press **⊕**.
“Enter your 4-digit lock code.” appears.

- 5** Press **SHIFT**, then press the **numeric buttons** to enter your **4-digit lock code**.
“The channel has been locked.” appears and the Parental Lock is set.
To delete the numbers you have entered, go back to step 2 by pressing **RETURN/EXIT** **↶**, and then repeat the procedure above from step 2.

To change the lock code (Lock Code)

- 1** Select a channel you want to change the lock code using **Category Mode** (page 59) or **Direct Tuning** (page 60).
- 2** Press **TOOLS/OPTIONS**.
The option menu appears.
- 3** Press **▲/▼** repeatedly to select “**Lock Code**”, then press **⊕**.
“Enter your 4-digit lock code.” appears.
- 4** Press **SHIFT**, then press the **numeric buttons** to enter your 4-digit lock code.
“Enter a new lock code.” appears.
- 5** Enter a new 4-digit lock code using the **numeric buttons**.
“To confirm, enter your new lock code again.” appears.
- 6** Reenter the new lock code with the **numeric buttons**.
“The lock code has been changed.” appears.

To listen to the locked channels

- 1 Select a locked channel you want to listen to using Direct Tuning (page 60).
“Enter your 4-digit lock code.” appears.
- 2 Press SHIFT, then press the numeric buttons to enter your 4-digit lock code.
The channel is tuned in.

To cancel the Parental Lock

- 1 Select a channel you want to unlock using Direct Tuning (page 60).
- 2 Press TOOLS/OPTIONS.
The option menu appears.
- 3 Press ▲/▼ repeatedly to select “Parental Lock”, then press ⊕ or ►.
- 4 Press ▲/▼ repeatedly to select “OFF”, then press ⊕.
“Enter your 4-digit lock code.” appears.
- 5 Press SHIFT, then press the numeric buttons to enter your 4-digit lock code.
“The channel has been unlocked.” appears and the channel is unlocked.

Notes

- When you select a channel using Category Mode, locked channels are skipped.
- When the receiver is reset to the initial settings, the lock code returns to the default (0000), but the Parental Lock settings are not removed.
- You cannot preset locked channels. If you set the Parental Lock for a preset channel, the preset information for that channel returns to the default.
- You cannot set the Parental Lock for channel 0 and channel 184.
- You can set only one lock code on the receiver. You cannot set individual lock codes for each channel.

SIRIUS Satellite Radio message list

Message appears on TV screen [Display]	Explanation	Remedies
Antenna [ANTENNA]	The antenna is not connected properly.	Check the connection between the SiriusConnect Home tuner and the antenna.
Acquiring [ACQUIRING]	The receiving condition is not good.	Try moving the antenna to another location. For details about the antenna location, refer to the operating instructions supplied with the SiriusConnect Home tuner.
UNSUB CH [CALL 888, 539-SIRI]*	You have not subscribed for the selected channel.	—
SR Tuner [SR TUNER]	The SiriusConnect Home tuner is not connected properly.	Check all the connections, and then turn the system on again. Also make sure if the AC adaptor supplied with the SiriusConnect Home tuner is connected to a wall socket.
Invalid [INVALID]	You have entered an invalid channel number.	The channel to be tuned-in is void due to the change by the broadcast service, or the receiving condition is not good.
Locked CH [LOCKED CH]	The selected channel is locked.	—
SUB UPDT [SUB UPDT]	The subscription information has been updated.	—
Updating [UPDATING]	Channel information is being updated.	—
FW UPDT [FW UPDT]	The SiriusConnect Home tuner firmware is being updated.	—
----	There is no text information in the channel.	This is not an error. The text information may not be displayed depending on the system condition, for example, right after the system has received a channel.

* “CALL 888” and “539-SIRI” appears on the display alternately.

Enjoying Surround Sound

Selecting the sound field

This receiver can create multi channel surround sound. You can select one of the optimized sound fields from the receiver's preprogrammed sound fields.

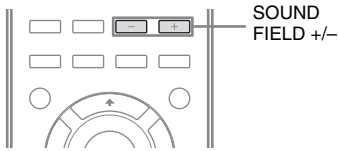

Press SOUND FIELD +/- repeatedly to select the sound field you want.

You can also use 2CH/A.DIRECT, A.F.D., MOVIE or MUSIC on the receiver.

2 channel sound mode

You can switch the output sound to 2 channel sound regardless of the recording formats of the software you are using, the playback component connected, or the sound field settings of the receiver.

■ 2CH ST. (2ch Stereo)

The receiver outputs the sound from the front left/right speakers only. There is no sound from the subwoofer.

Standard 2 channel stereo sources completely bypass the sound field processing and multi channel surround formats are downmixed to 2 channel.

■ A. DIRECT (Analog Direct)

You can switch the audio of the selected input to 2 channel analog input. This function enables you to enjoy high quality analog sources without any adjustment.

When using this function, only the volume and front speaker level can be adjusted.

Note

You cannot select "Analog Direct" when you select DVD, DMPORT and HDMI 1-4 as input.

Auto Format Direct (A.F.D.) mode

The Auto Format Direct (A.F.D.) mode allows you to listen to high fidelity sound and select the decoding mode for listening to a 2 channel stereo sound as multi channel sound.

■ A.F.D. AUTO (A.F.D. Auto)

Presets the sound as it was recorded/encoded without adding any surround effects.

■ MULTI ST. (Multi Stereo)

Outputs 2 channel left/right signals from all speakers. However, sound may not be output from certain speakers depending on the speaker settings.

Movie mode

You can take advantage of surround sound simply by selecting one of the receiver's preprogrammed sound fields. They bring the exciting and powerful sound of movie theaters into your home.

■ C.ST.EX A (Cinema St EX A DCS)

Reproduces the sound characteristics of the Sony Pictures Entertainment "Cary Grant Theater" cinema production studio. This is a standard mode, great for watching almost any type of movie.

■ C.ST.EX B (Cinema St EX B DCS)

Reproduces the sound characteristics of the Sony Pictures Entertainment "Kim Novak Theater" cinema production studio. This mode is ideal for watching science-fiction or action movies with lots of sound effects.

■ C.ST.EX C (Cinema St EX C DCS)

Reproduces the sound characteristics of the Sony Pictures Entertainment scoring stage. This mode is ideal for watching musicals or films where orchestra music is featured in the soundtrack.

■ V.MULTI DIM. (V.M. Dimension DCS)

Creates many virtual speakers from a single pair of actual surround speakers.

■ PLII MV (PLII Movie)

Performs Dolby Pro Logic II Movie mode decoding. This setting is ideal for movies encoded in Dolby Surround. In addition, this mode can reproduce sound in 5.1 channel for watching videos of overdubbed or old movies.

■ PLIIx MV (PLIIx Movie)

Performs Dolby Pro Logic IIx Movie mode decoding. This setting expands Dolby Pro Logic II Movie or Dolby Digital 5.1 to discrete 7.1 movie channels.

■ PLIIz (PLIIz Height)

Performs Dolby Pro Logic IIz mode decoding. This setting increases flexibility to expand a 5.1 to a 7.1 channel system. Its vertical component gives a dimension of presence and depth.

■ NEO6 CIN (Neo:6 Cinema)

Performs DTS Neo:6 Cinema mode decoding. A source recorded in 2 channel format is decoded into 7 channels.

Music mode

You can take advantage of surround sound simply by selecting one of the receiver's preprogrammed sound fields. They bring the exciting and powerful sound of concert halls into your home.

■ HALL (Hall)

Reproduces the acoustics of a classical concert hall.

■ JAZZ (Jazz Club)

Reproduces the acoustics of a jazz club.

■ CONCERT (Live Concert)

Reproduces the acoustics of a 300-seat live house.

■ STADIUM (Stadium)

Reproduces the feeling of a large open-air stadium.

■ SPORTS (Sports)

Reproduces the feeling of sports broadcasting.

■ PORTABLE (Portable Audio)

Reproduces a clear enhanced sound image from your portable audio device. This mode is ideal for MP3 and other compressed music.

■ PLII MS (PLII Music)

Perform Dolby Pro Logic II Music mode decoding. This setting is ideal for normal stereo sources such as CDs.

■ PLIIx MS (PLIIx Music)

Performs Dolby Pro Logic IIx Music mode decoding. This setting is ideal for normal stereo sources such as CDs.

■ PLIIz (PLIIz Height)

Performs Dolby Pro Logic IIz mode decoding. This setting increases flexibility to expand a 5.1 to a 7.1 channel system. Its vertical component gives a dimension of presence and depth.

■ NEO6 MUS (Neo:6 Music)

Performs DTS Neo:6 Music mode decoding. A source recorded in 2 channel format is decoded into 7 channels. This setting is ideal for normal stereo sources such as CDs.

When headphones are connected

You can only select this sound field if the headphones are connected to the receiver.

■ HP 2CH (HP (2 ch))

This mode is selected automatically if you use headphones (except Analog Direct). Standard 2 channel stereo sources completely bypass the sound field processing and multi channel surround formats are downmixed to 2 channels except LFE signals.

Note

When headphones are connected to the S-AIR surround amplifier, the sound field is automatically set to “HP (2 ch)”.

■ HP DIRECT (HP (Direct))

This mode is selected automatically if you use headphones when “Analog Direct” is selected. Outputs the analog signals without processing by the equalizer, sound field, etc.

If you connect a subwoofer

This receiver will generate a low frequency signal for output to the subwoofer when there is no LFE signal, which is a low-pass sound effect output from a subwoofer to a 2 channel signal. However, the low frequency signal is not generated for “Neo:6 Cinema” or “Neo:6 Music” when all speakers are set to “Large”. In order to take full advantage of the Dolby Digital bass redirection circuitry, we recommend setting the subwoofer’s cut off frequency as high as possible.

Notes on sound fields

- Depending on the speaker pattern settings, some sound fields may not be available.
- You cannot select PLIIX and PLIIZ at the same time.
 - PLIIX is available only when the speaker pattern is set to a setting with surround back speaker(s).
 - PLIIZ is available only when the speaker pattern is set to a setting with front high speakers.

- The sound fields for music and movies do not work in the following cases.
 - Signals with a sampling frequency of more than 48 kHz are being received.
 - Signals with more than 5.1 channel are being received (except PLIIZ).
- When one of the sound fields for music is selected, no sound is output from the subwoofer if all the speakers are set to “Large” on the Speaker Settings menu. However, the sound will be output from the subwoofer if
 - the digital input signal contains LFE signals.
 - the front or surround speakers are set to “Small”.
 - the sound field for movie is selected.
 - “Portable Audio” is selected.
- The effects provided by the virtual speakers may cause increased noise in the playback signal.
- When listening with sound fields that employ the virtual speakers, you will not be able to hear any sound coming directly from the surround speakers.

Tips

- You can identify the encoding format of DVD software, etc., by looking at the logo on the package.
- Dolby Pro Logic IIX and Dolby Pro Logic IIZ decoding are effective when multi channel signals are input.
- Sound fields with **DCS** marks use DCS technology. For details on Digital Cinema Sound (DCS), see “Glossary” (page 117).

To turn off the surround effect for movie/music

Press SOUND FIELD +/- repeatedly to select “2CH ST.” or “A.F.D. AUTO”.

You can also press 2CH/A.DIRECT repeatedly on the receiver to select “2CH ST.” or press A.F.D. repeatedly on the receiver to select “A.F.D. AUTO”.

When connecting Blu-ray disc players and other next generation HD players

Digital audio formats that this receiver can decode depend on digital audio input jacks for the components connected. This receiver supports the following audio formats.

Audio format	Maximum number of channels	Connection of the playback component and the receiver	
		COAXIAL/OPTICAL	HDMI
Dolby Digital	5.1	○	○
Dolby Digital EX	6.1	○	○
Dolby Digital Plus ^{a)}	7.1	×	○
Dolby TrueHD ^{a)}	7.1	×	○
DTS	5.1	○	○
DTS-ES	6.1	○	○
DTS 96/24	5.1	○	○
DTS-HD High Resolution Audio ^{a)}	7.1	×	○
DTS-HD Master Audio ^{a)b)}	7.1	×	○
Multi channel Linear PCM ^{a)}	7.1	×	○

^{a)} Audio signals are output in another format if the playback component does not correspond to the format. For details, refer to the operating instructions of the playback component.

^{b)} Signals with a sampling frequency of more than 96 kHz are played back at 96 kHz or 88.2 kHz.

Enjoying the surround effect at low volume levels

(NIGHT MODE)

This function allows you to retain a theater like environment at low volume levels. This function can be used with other sound fields. When watching a movie late at night, you will be able to hear the dialog clearly even at a low volume level.

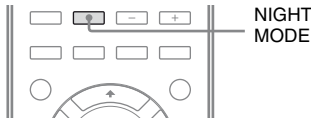

Press NIGHT MODE to select “NIGHT ON”.

The NIGHT MODE function is activated. The NIGHT MODE is set to on and off as you press NIGHT MODE.

Note

This function does not work in the following cases.

- Sound Field is set to “Analog Direct”.
- Signals with a sampling frequency of more than 48 kHz are being received.

Tip

While this function is on, the Bass, Treble, and Effect Levels increase, and “D.Range Comp” is automatically set to “MAX”.

Resetting sound fields to the initial settings

Be sure to use the buttons on the receiver for this operation.

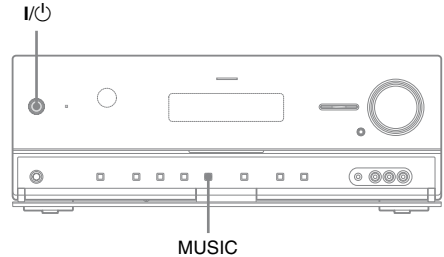

- 1** Press I/⏻ to turn off the receiver.
- 2** While holding down MUSIC, press I/⏻.

“S.F. CLEAR” appears on the display and all sound fields are reset to their initial setting.

What is “BRAVIA” Sync?

“BRAVIA” Sync is compatible with Sony TV, Blu-ray disc/DVD player, AV amplifier, etc., that is equipped with the Control for HDMI function.

By connecting Sony components that are compatible with the “BRAVIA” Sync with an HDMI cable (not supplied), operation is simplified as follows:

- One-Touch Play (page 72)
- System Audio Control (page 72)
- System Power Off (page 73)
- Theater/Theatre Mode Sync (page 73)
- Audio Return Channel (page 74)

Control for HDMI is a mutual control function standard used by HDMI CEC (Consumer Electronics Control) for HDMI (High-Definition Multimedia Interface).

We recommend that you connect the receiver to products featuring “BRAVIA” Sync.

Note

Depending on the connected component, the Control for HDMI function may not work. Refer to the operating instructions of the component.

Preparing for the “BRAVIA” Sync

The receiver is compatible with the “Control for HDMI-Easy Setting” function.

- If your TV is compatible with the “Control for HDMI-Easy Setting” function, you can set the Control for HDMI function of the receiver and playback components automatically by setting the TV (page 70).
- If your TV is not compatible with the “Control for HDMI-Easy Setting” function, set the Control for HDMI function of the receiver, playback components and TV individually (page 71).

If your TV is compatible with the “Control for HDMI-Easy Setting” function

The Control for HDMI function of the receiver can be turned on simultaneously by turning on the Control for HDMI function of the TV.

- 1** Connect the receiver, TV and playback components via HDMI connection (page 27).
(The respective components must be compatible with the Control for HDMI function).
- 2** Turn on the receiver, TV and playback components.
- 3** Turn the Control for HDMI function of the TV on.
The Control for HDMI function of the receiver and all the connected components are turned on simultaneously. When the setup is completed, “COMPLETE” will appear.

For details on setup of the TV, refer to the operating instructions of your TV.

If your TV is not compatible with the “Control for HDMI-Easy Setting” function

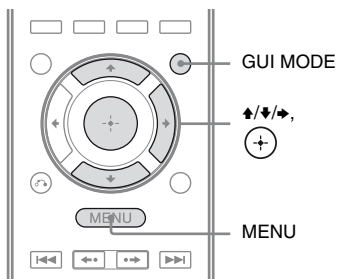

Notes

- Before you do the “Control for HDMI-Easy Setting” from the TV, be sure to turn on the TV, connected components and receiver.
- If the playback components cannot function after you have made the settings for “Control for HDMI-Easy Setting”, check the Control for HDMI setting on your TV.
- If the connected components do not support “Control for HDMI-Easy Setting”, you need to set the Control for HDMI function for the connected components to on before you perform the “Control for HDMI-Easy Setting” from the TV.

- 1 Perform the steps given in “If your TV is compatible with the “Control for HDMI-Easy Setting” function” (page 70).
- 2 Press GUI MODE.
After “MENU ON” appears on the display for a while, “GUI” appears and the GUI menu appears on the TV screen.
Press MENU if the GUI menu does not appear on the TV screen.
- 3 Press \uparrow/\downarrow repeatedly to select “Settings”, then press \oplus or \rightarrow .
The Settings menu list appears on the TV screen.
- 4 Press \uparrow/\downarrow repeatedly to select “HDMI”, then press \oplus or \rightarrow .
- 5 Press \uparrow/\downarrow repeatedly to select “Ctrl for HDMI”, then press \oplus or \rightarrow .
- 6 Press \uparrow/\downarrow repeatedly to select “ON”, then press \oplus .
The Control for HDMI function is set to on.
- 7 Set the Control for HDMI function of the connected component to on.
If the Control for HDMI function for the connected component is already set to on, you do not need to change the setting.
For details on setting the TV and connected components, refer to the operating instructions of the respective components.

Playing back components with one-touch operation (One-Touch Play)

By a simple operation (one-touch), components connected to the receiver with HDMI connections start automatically. You can enjoy the sound/image using connected components. When you set “Pass Through” to “AUTO” or “ON”, sound and image can be output only from the TV while the receiver remains in standby mode.

When you start playback a connected component, the receiver and TV operation are simplified as follow:

Receiver and TV

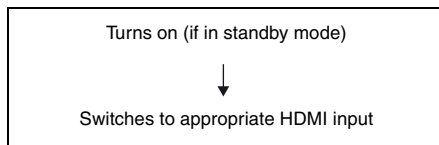

Notes

- Depending on the TV, the start of the content may not be output.
- Depending on the settings, the receiver may not turn on when “Pass Through” is set to “AUTO” or “ON”.

Tip

You can also select a connected component, such as DVD/Blu-ray disc player using the TV menu. The receiver and TV will automatically switch to the appropriate HDMI input.

Enjoying the TV sound from the speakers connected to the receiver (System Audio Control)

You can enjoy the TV sound from the speakers connected to the receiver by a simple operation.

You can operate System Audio Control function using the TV menu. For details, refer to the operating instructions of the TV.

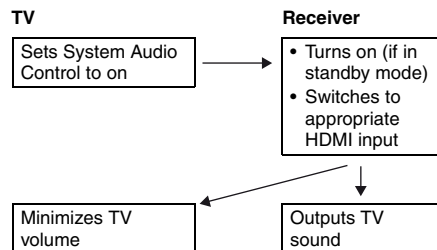

You can also use the System Audio Control function as follows.

- If you turn on the receiver while the TV is turned on, the System Audio Control function will automatically be set to on and the TV sound will output from the speakers connected to the receiver. However, if you turn off the receiver, the sound will output from the TV speakers.
- When you adjust the TV volume, the receiver’s volume is adjusted simultaneously.

Notes

- If System Audio Control does not function according to your TV setting, refer to the operating instructions of the TV.
- When “Ctrl for HDMI” is set to “ON”, the “Audio Out” settings in the HDMI Settings menu will set automatically depending on the System Audio Control settings.
- When you connect a TV that does not have System Audio Control function, the System Audio Control function does not work.
- If the TV is turned on before turning on the receiver, the TV sound will not be output for a moment.

Turning off the receiver with the TV

(System Power Off)

When you turn the TV off by using the POWER button on the TV's remote, the receiver and the connected components turn off automatically.

You can also use the receiver's remote to turn off the TV.

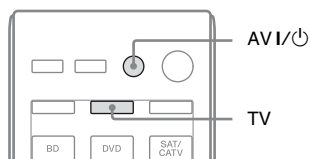

Press TV, then press AV I/⏻.

The TV, receiver and the components connected via HDMI are turned off.

Notes

- Set the TV Standby Synchro to "ON" before using the System Power Off function. For details, refer to the operating instructions of the TV.
- Depending on the status, the connected components may not be turned off. For details, refer to the operating instructions of the connected components.

Enjoying movies with the optimum sound field (Theater/Theatre Mode Sync)

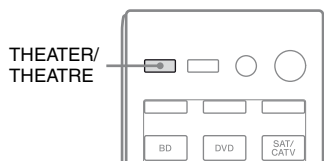

Press THEATER or THEATRE on the remote of the receiver, TV, or the Blu-ray disc player, while pointing the remote towards the TV.

The sound field switches to "C.ST.EX B". To return to the previous sound field, press THEATER or THEATRE again.

Note

The sound field may not switch depending on the TV.

Tip

The sound field may be changed back to the previous one when you change the TV's input.

Enjoying the TV sound via an HDMI cable

(Audio Return Channel)

The Audio Return Channel (ARC) function enables the TV outputs the audio signals to the receiver via an HDMI cable connected to the HDMI TV OUT jack.

You can enjoy the TV sound from the speakers connected to the receiver without connecting the TV AUDIO IN or TV OPTICAL IN jack.

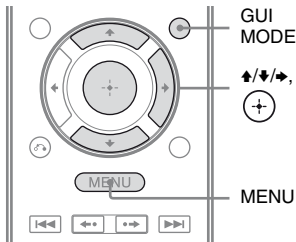

Notes

- This function does not work when you set “Ctrl for HDMI” to “OFF” in the HDMI Settings menu.
- This function is only available when
 - your TV is compatible with Audio Return Channel (ARC) function.
 - INPUT MODE is set to “AUTO”.

1 Press GUI MODE.

After “MENU ON” appears on the display for a while, “GUI” appears and the GUI menu appears on the TV screen. Press MENU if the GUI menu does not appear on the TV screen.

2 Press \uparrow/\downarrow repeatedly to select “Settings”, then press \oplus or \rightarrow .

The Settings menu list appears on the TV screen.

3 Press \uparrow/\downarrow repeatedly to select “HDMI”, then press \oplus or \rightarrow .

4 Press \uparrow/\downarrow repeatedly to select “ARC”, then press \oplus or \rightarrow .

5 Press \uparrow/\downarrow repeatedly to select “ON”, then press \oplus .

S-AIR Operations

About S-AIR products

This receiver is compatible with the S-AIR function (page 119), which allows wireless sound transmission between S-AIR products.

There are two types of S-AIR product.

- S-AIR main unit (this receiver):
The S-AIR main unit is for transmitting sound.
You can use up to 3 S-AIR main units. (The number of usable S-AIR main unit depends on the use environment.)
- S-AIR sub unit (not supplied):
The S-AIR sub unit is for receiving sound.
 - Surround amplifier: You can enjoy surround and surround back speakers sound wirelessly. For details, refer to the operating instructions supplied with the surround amplifier.
 - S-AIR receiver: You can enjoy system sound in another room.

These S-AIR products can be purchased as an option (the S-AIR product lineup differs depending on the area).

See the notes or instructions for the S-AIR sub unit in this manual only when the S-AIR sub unit is used.

Notes

- The S-AIR menu and parameters only available when you have inserted the wireless transmitter.
- When the speaker pattern is set to a setting with front high speakers, the surround back speakers sound is not output from surround amplifier even if the surround amplifier is used.

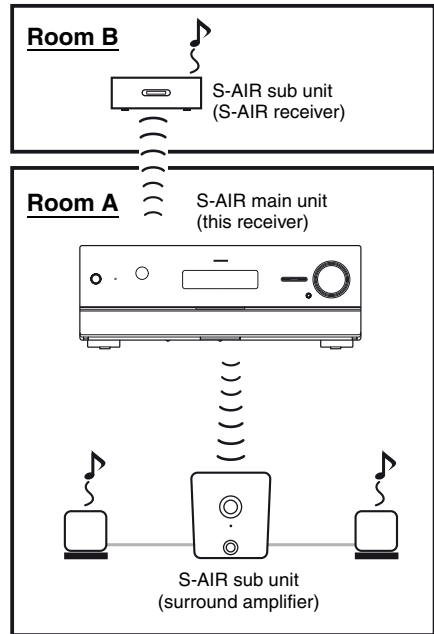

About environments where S-AIR products (S-AIR main unit and sub unit) are used

S-AIR products use a radio frequency of 2.4 GHz. Certain electronic equipment or other factors may cause lost connection or instability in S-AIR reception.

- Electronic equipment influence
The following may cause interference or cross talk.
 - Cellular phones, cordless phones
 - Wireless LAN, personal computers
 - Game machines using radio signals
 - Microwave ovens



- Other factors
The following may cause poor reception.
 - Materials or structures, such as walls and floors
 - The location where an S-AIR product is placed

When using S-AIR products, place them as far as possible from the above electronic equipment, or place where S-AIR reception is stable.

Setting up an S-AIR product

Before using an S-AIR product, be sure to perform the following settings to establish the sound transmission.

- Inserting the wireless transmitter/transceiver (page 35).
- Establishing sound transmission between the S-AIR main unit and S-AIR sub unit (ID setting) (page 77).
- Pairing the S-AIR main unit with a specific S-AIR sub unit (Pairing operation) (page 78).

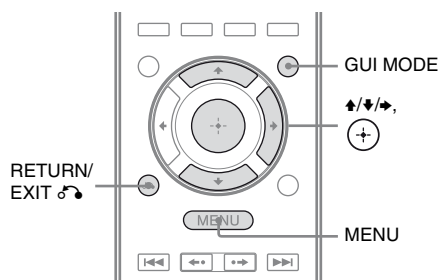

Establishing sound transmission between the S-AIR main unit and S-AIR sub unit (ID setting)

When you match the ID of the S-AIR main unit and the S-AIR sub unit, you can establish sound transmission. You can use multiple S-AIR main unit by setting a different ID for each unit.

To set the ID of the S-AIR main unit

1 Press GUI MODE.

After "MENU ON" appears on the display for a while, "GUI" appears and the GUI menu appears on the TV screen.

Press MENU if the GUI menu does not appear on the TV screen.

2 Press \uparrow/\downarrow repeatedly to select "Settings", then press \oplus or \blacktriangleright .

The Settings menu list appears on the TV screen.

3 Press \uparrow/\downarrow repeatedly to select "S-AIR", then press \oplus or \blacktriangleright .

Note

When the S-AIR transmitter (not supplied) is not inserted into the S-AIR main unit, "S-AIR" cannot be selected.

4 Press \uparrow/\downarrow repeatedly to select "S-AIR ID", then press \oplus or \blacktriangleright .

The S-AIR ID menu appears.

5 Press \uparrow/\downarrow repeatedly to select the ID (A, B or C) you want, then press \oplus .

The ID of the S-AIR main unit is set. "Set S-AIR ID of the sub unit to the same as that of the main unit" appears.

6 Press \oplus .

7 Press GUI MODE.

The GUI menu turns off.

8 Set the S-AIR sub unit to the same ID.

Sound transmission is established as follows (example):

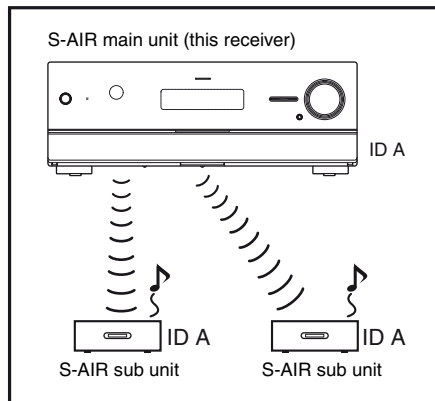

Tip

To confirm the current ID, perform steps 1 to 3 above. When you pair the S-AIR main unit with the S-AIR sub unit (page 78), "(Pairing)" appears beside the ID on the TV screen in the GUI menu.

To exit the menu

Press MENU.

To set the ID of the S-AIR sub unit

Be sure to match the ID on S-AIR sub unit you want to the S-AIR main unit.

For details on setting the ID of the surround amplifier and S-AIR receiver, refer to the operating instructions supplied with the surround amplifier and S-AIR receiver.

To use multiple S-AIR main units

You can use multiple S-AIR main units by setting a different ID for each component. Sound transmission is established as follows (example):

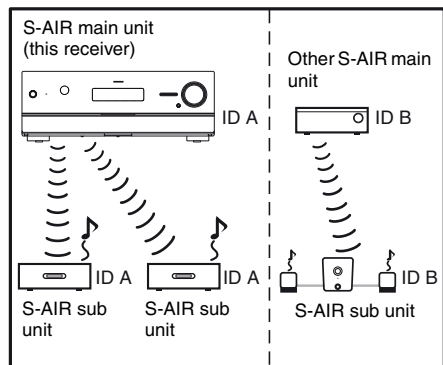

Notes

- Sources with copyright protection may not be playable on S-AIR sub unit.
- If you have connected surround amplifier, surround sound will not be output from S-AIR main unit.

Pairing the S-AIR main unit with a specific S-AIR sub unit (Pairing operation)

To establish sound transmission, you need to set the same ID for your S-AIR main unit and S-AIR sub unit.

However, if your neighbors have S-AIR products and their IDs are the same as yours, your neighbors could receive the sound of your S-AIR main unit or vice versa.

To prevent this, you can pair the S-AIR main unit with a specific S-AIR sub unit by performing the pairing operation.

■ Before pairing

Sound transmission is established by the ID (example).

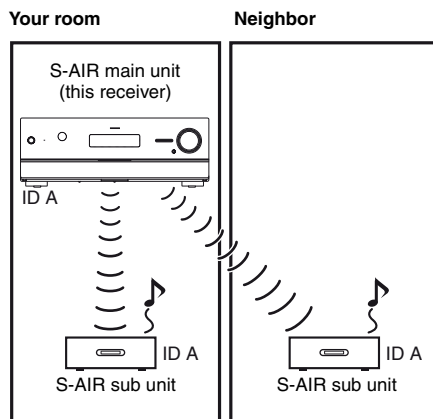

■ After pairing

Sound transmission is established between the paired S-AIR main unit and S-AIR sub unit(s) only.

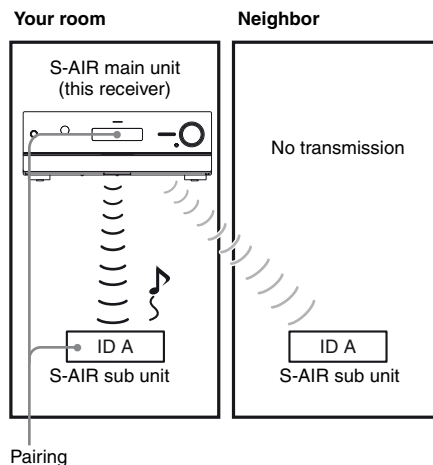

To perform pairing

1 Place the S-AIR sub unit that you want to pair near the S-AIR main unit.

2 Match the IDs of the S-AIR main unit and the S-AIR sub unit.

- To set the ID of the S-AIR main unit, see “To set the ID of the S-AIR main unit” (page 77).
- To set the ID of the S-AIR sub unit, refer to the operating instructions supplied with the S-AIR sub unit.

3 Press GUI MODE.

After “MENU ON” appears on the display for a while, “GUI” appears and the GUI menu appears on the TV screen. Press MENU if the GUI menu does not appear on the TV screen.

4 Press \uparrow/\downarrow repeatedly to select “Settings”, then press \oplus or \rightarrow .

The Settings menu list appears on the TV screen.

5 Press \uparrow/\downarrow repeatedly to select “S-AIR”, then press \oplus or \rightarrow .

Note

When the S-AIR transmitter (not supplied) is not inserted into the S-AIR main unit, “S-AIR” cannot be selected.

6 Press \uparrow/\downarrow repeatedly to select “Pairing”, then press \oplus or \rightarrow .

“Put the S-AIR sub unit near the S-AIR main unit. Turn on power and start pairing.” appears on the TV screen. The S-AIR main unit is ready to start pairing.

7 Press \leftarrow/\rightarrow repeatedly to select “Yes”, then press \oplus .

The S-AIR main unit starts pairing. “Pairing. Do the pairing operation with the S-AIR sub unit.” appears.

8 Start pairing of the S-AIR sub unit.

Refer to the operating instructions of the S-AIR sub unit.

Notes

- Perform pairing within 5 minutes in step 7. If you do not, pairing is recognized as failed, and the screen changes accordingly. In this case, see “If pairing fails” (page 79).
- When sound transmission is established, “Pairing complete. To do the pairing another one, select “Continue.”” appears.

9 Press \leftarrow/\rightarrow repeatedly to select “Finish” or “Continue”, then press \oplus .

- “Finish”: Finishes pairing.
- “Continue”: Continues to perform pairing to another S-AIR sub unit.

Tip

You can confirm the pairing completion or the current ID by checking the “S-AIR Settings” screen. “Pairing” appears beside the current S-AIR ID.

10 Press GUI MODE.

The GUI menu turns off.

Note

After you have performed pairing, if you select the “S-AIR ID” menu, the ID setting (“A”, “B” or “C”) that you last used is displayed.

If pairing fails

“Pairing failed. Retry?” appears.

To perform pairing again, select “Yes”.

To finish pairing, select “No”.

To quit pairing during setting

Press RETURN/EXIT \rightarrow .

To cancel pairing

Perform the ID setting of the main unit according to the procedure of “To set the ID of the S-AIR main unit” (page 77). If you reset the ID (even the same ID again), pairing is canceled.

Enjoying the system's sound in another room

(For the S-AIR receiver only (not supplied))

You can enjoy the system's sound in another room by using the S-AIR receiver. The S-AIR receiver can be placed in another room for enjoying the system's sound there.

For details of the S-AIR receiver, refer to the operating instructions supplied with the S-AIR receiver.

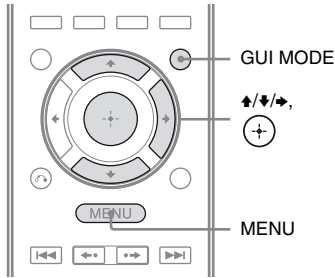

1 Set the ID of the S-AIR receiver to match the ID of the S-AIR main unit.

- To set the ID of the S-AIR main unit, see “To set the ID of the S-AIR main unit” (page 77).
- To set the ID of the S-AIR receiver, refer to the operating instructions supplied with the S-AIR receiver.

Notes

- When you are using another S-AIR sub unit, such as a surround amplifier, do not change the ID of the S-AIR main unit. Set the ID of the S-AIR receiver to match the ID of the S-AIR main unit.
- When you pair the S-AIR main unit and another S-AIR sub unit, such as a surround amplifier, you also need to pair the S-AIR main unit and the S-AIR receiver. For details, see “Pairing the S-AIR main unit with a specific S-AIR sub unit (Pairing operation)” (page 78).

2 Press GUI MODE.

After “MENU ON” appears on the display for a while, “GUI” appears and the GUI menu appears on the TV screen. Press MENU if the GUI menu does not appear on the TV screen.

3 Press \uparrow/\downarrow repeatedly to select “Settings”, then press \oplus or \rightarrow .

The Settings menu list appears on the TV screen.

4 Press \uparrow/\downarrow repeatedly to select “S-AIR”, then press \oplus or \rightarrow .

Note

When the S-AIR transmitter (not supplied) is not inserted into the S-AIR main unit, “S-AIR” cannot be selected.

5 Press \uparrow/\downarrow repeatedly to select “S-AIR Mode”, then press \oplus or \rightarrow .

6 Press \uparrow/\downarrow repeatedly to select the setting you want, then press \oplus .

- Party: The S-AIR receiver outputs sound according to the input selected on the S-AIR main unit.
- Separate: You can select the input you want for the S-AIR receiver while the input of the S-AIR main unit remain unchanged. When “Separate” is selected, you can only select “SA-CD/CD”, “DMPORT”, “FM TUNER”, “AM TUNER”, “SIRIUS”* and the input that is currently selected on the S-AIR main unit.

Note

When the input selected on the S-AIR receiver is same as S-AIR main unit, the input of the S-AIR receiver will change according to the S-AIR main unit.

7 Press GUI MODE.

The GUI menu turns off.

8 Select the desired input on the S-AIR receiver.

■ When “Party” is set

The S-AIR receiver’s input changes sequentially as you change the input on the S-AIR main unit or S-AIR receiver.

■ When “Separate” is set

The S-AIR receiver’s input changes by pressing S-AIR CH of the S-AIR receiver.

Note

When TUNER (FM/AM band) is selected on the S-AIR main unit, you can only select the same band for the tuner on the S-AIR receiver. However, you can select input other than TUNER on the S-AIR receiver.

9 Adjust the volume on the S-AIR receiver.

* Models of area code U2, CA2 only.

Notes

- The sound of the S-AIR receiver may be cut off by operation of the S-AIR main unit.
- When the sound is other than 2 channel stereo, multi channel sound is downmixed to 2 channel.
- Signals with a sampling frequency of more than 96 kHz cannot output to the S-AIR receiver.

To control the system from the S-AIR receiver

You can control the system from the S-AIR receiver by using the following buttons.

Press	Operation
	Share the same operations on the remote
S-AIR CH	Change the function of the system

For details, refer to the operating instructions of the S-AIR receiver.

Changing the channel for better sound transmission

If you use multiple wireless systems which share the 2.4 GHz band, such as wireless LAN or Bluetooth, the transmission of S-AIR products or other wireless systems may be unstable. In this case, transmission may be improved by changing the “RF Change” setting.

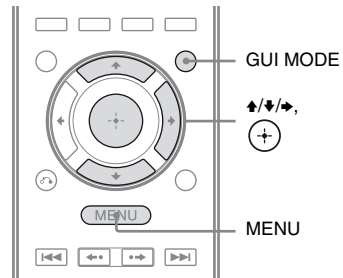

1 Press GUI MODE.

After “MENU ON” appears on the display for a while, “GUI” appears and the GUI menu appears on the TV screen. Press MENU if the GUI menu does not appear on the TV screen.

2 Press \uparrow/\downarrow repeatedly to select “Settings”, then press \oplus or \rightarrow .

The Settings menu list appears on the TV screen.

3 Press \uparrow/\downarrow repeatedly to select “S-AIR”, then press \oplus or \rightarrow .

Note

When the S-AIR transmitter (not supplied) is not inserted into the S-AIR main unit, “S-AIR” cannot be selected.

4 Press **▲/▼** repeatedly to select “RF Change”, then press **⊕** or **➔**.

5 Press **▲/▼** repeatedly to select the setting you want, then press **⊕**.

- **AUTO:** Normally select this. The system changes “RF Change” to “ON” or “OFF” automatically.
- **ON:** The system transmits sound by searching for a better channel for transmitting.
- **OFF:** The system transmits sound by fixing the channel for transmitting.

6 Press **GUI MODE**.

The GUI menu turns off.

7 When you set “RF Change” to “OFF”, select the ID so that sound transmission is most stable.

Notes

- In most cases, you will not need to change this setting.
- If “RF Change” is set to “OFF”, transmission between the S-AIR main unit and S-AIR sub unit can be performed using one of the following channels.
 - S-AIR ID A: equivalent channel for IEEE 802.11b/g channel 1
 - S-AIR ID B: equivalent channel for IEEE 802.11b/g channel 6
 - S-AIR ID C: equivalent channel for IEEE 802.11b/g channel 11
- The transmission may be improved by changing the transmission channel (frequency) of the other wireless system(s). For details, refer to the operating instructions of the other wireless system(s).

Stabilizing S-AIR reception

Check the following when S-AIR reception is poor or unstable.

- Confirm the wireless adapters are inserted correctly (page 35).
- Confirm that the S-AIR IDs of the S-AIR main unit and sub unit are the same (page 77).

When S-AIR reception is poor

Check the following.

- Keep cords that are connected to the S-AIR product (AC power cord (mains lead), speaker cords, or other cords) away from the wireless adapter and slot.

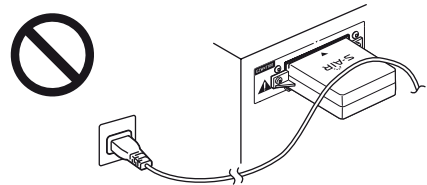
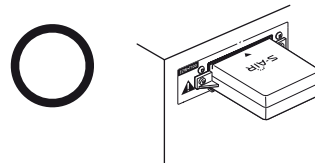

- Keep as much space as possible around S-AIR products.
 - Avoid placing S-AIR products on top of or directly below other electronic equipment.
 - Avoid placing S-AIR products in a closed rack, metal rack or under a table.

- Adjust the location (height, orientation, and place in the room) of S-AIR products until reception is the most stable.

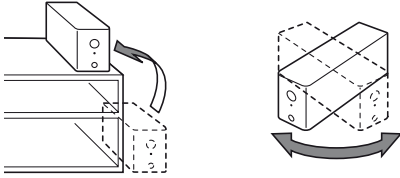

- Place so that the wireless adapters of the S-AIR main unit and sub unit are closer.



- Place so that S-AIR products are separated from other wireless devices.

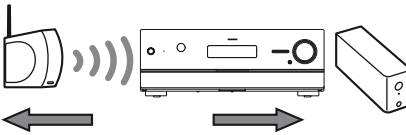

- Place so that S-AIR products are separated from metal doors or tables.

If you still cannot improve S-AIR reception, change the “RF Change” setting (page 81).

Enjoying the S-AIR receiver while the S-AIR main unit is in standby mode

(For the S-AIR receiver only (not supplied))

You can enjoy the S-AIR receiver while the S-AIR main unit is in standby mode by setting “S-AIR Stby” to “ON”.

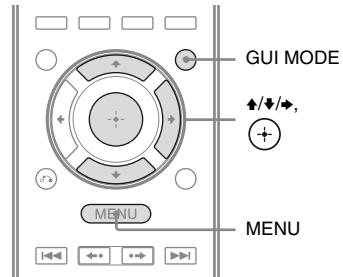

1 Press GUI MODE.

After “MENU ON” appears on the display for a while, “GUI” appears and the GUI menu appears on the TV screen. Press MENU if the GUI menu does not appear on the TV screen.

2 Press \uparrow/\downarrow repeatedly to select “Settings”, then press \oplus or \rightarrow .

The Settings menu list appears on the TV screen.

3 Press \uparrow/\downarrow repeatedly to select “S-AIR”, then press \oplus or \rightarrow .

Note

When the S-AIR transmitter (not supplied) is not inserted into the S-AIR main unit, “S-AIR” cannot be selected.

4 Press \uparrow/\downarrow repeatedly to select “S-AIR Stby”, then press \oplus or \rightarrow .

5 Press \uparrow/\downarrow repeatedly to select the setting you want.

- ON: You can enjoy the S-AIR receiver while the S-AIR main unit is in standby mode or turned on.
- OFF: You cannot enjoy the S-AIR receiver while the S-AIR main unit is in standby mode.

To exit the menu

Press MENU.

Notes

- When you set “S-AIR Stby” to “ON”, the power consumption increases during the standby mode.
- When the wireless transmitter is removed from the S-AIR main unit, “S-AIR Stby” is set to “OFF” automatically.
- If you have selected TUNER (FM/AM band) on the S-AIR main unit before you turn it off and “S-AIR Stby” is set to “ON”, you can only select the same band for the tuner on the S-AIR receiver. However, you can select input other than TUNER on the S-AIR receiver.
- The sound of the S-AIR receiver may be cut off by operation of the S-AIR main unit.
- When the receiver is in standby mode, “A.STANDBY” appears on the display if “S-AIR Stby” is set to “ON”.

Advanced Operations

Switching between digital and analog audio (INPUT MODE)

When you connect components to both digital and analog audio input jacks on the receiver, you can fix the audio input mode to either of them, or switch from one to the other, depending on the type of material you intend to watch.

1 Press INPUT SELECTOR $+/-$ on the receiver to select the input.

You can also use the input buttons on the remote.

2 Press INPUT MODE repeatedly on the receiver to select the audio input mode.

The selected audio input mode appears on the display.

Audio input modes

■ AUTO

Gives priority to digital audio signals when there are both digital and analog connections. If there are no digital audio signals, analog audio signals are selected.

■ ANALOG

Specifies the analog audio signals input to the AUDIO IN (L/R) jacks.

Notes

- Some audio input modes may not be set up depending on the input.
- When either the HDMI 1-4 input, DMPORT input or SIRIUS* is selected, “-----” appears on the display, and you cannot select other modes. Select an input mode other than the HDMI 1-4 input, DMPORT input or SIRIUS* then set the audio input mode.
- When “Analog Direct” is being used, audio input is automatically set to “ANALOG”. You cannot select other modes.

* Models of area code U2, CA2 only.

Enjoying the sound/ images from other inputs

You can reassign audio and/or video signals to another input when they are not currently being used.

For example when you want to connect your DVD player but cannot find an unused input:

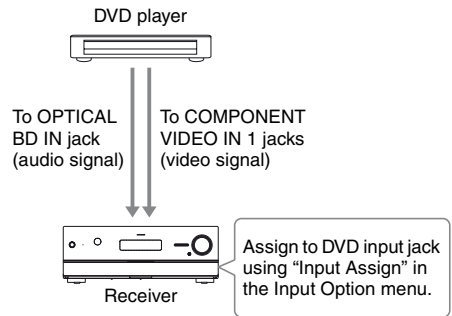

1 Press GUI MODE.

After “MENU ON” appears on the display for a while, “GUI” appears and the GUI menu appears on the TV screen. Press MENU if the GUI menu does not appear on the TV screen.

2 Press \uparrow/\downarrow repeatedly to select “Input”, then press \oplus or \rightarrow .

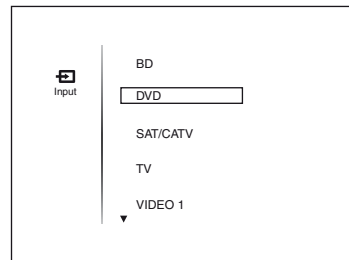

3 Press \uparrow/\downarrow repeatedly to select the input name you want to assign.

4 Press TOOLS/OPTIONS.

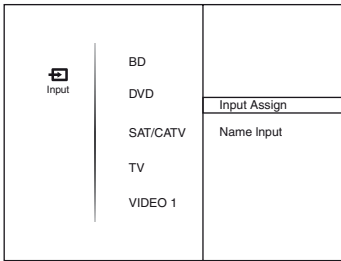

5 Press \uparrow/\downarrow repeatedly to select "Input Assign", then press \oplus or \rightarrow .

The "Input Assign" screen appears.

6 Select the audio and/or video signals you want to assign to the input which you selected in step 3 using $\uparrow/\downarrow/\leftarrow/\rightarrow$.

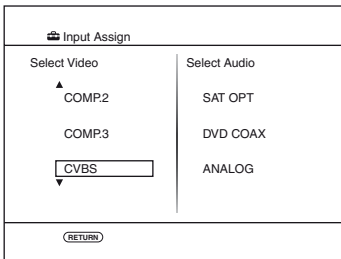

7 Press \oplus to enter the setting.

Input name	BD	DVD	SAT/CATV	VIDEO 1	VIDEO 2	SA-CD/CD/ CD-R
Assignable video input jacks	COMP.1	○*	○	○	○	○
	COMP.2	○	○*	○	○	○
	COMP.3	○	○	○*	○	○
	CVBS	○	–	○	○*	○*
	HDMI1	○	○	○	○	○
	HDMI2	○	○	○	○	○
	HDMI3	○	○	○	○	○
	HDMI4	○	○	○	○	○
	NONE	–	○	–	–	–
Assignable audio input jacks	BD OPT	○*	○	–	○	○
	SAT OPT	–	○	○*	○	○
	DVD COAX	○	○*	○	○	○
	ANALOG	○	–	○	○*	○*

* Initial setting

Notes

- You cannot assign optical signals from an input source to the optical input jacks on the receiver.
- When you assign the digital audio input, the INPUT MODE setting may change automatically.
- You cannot reassign more than one HDMI input to the same input.
- You cannot reassign more than one digital audio input to the same input.
- You cannot reassign more than one component video input to the same input.

Using a bi-amplifier connection

1 Press GUI MODE.

After “MENU ON” appears on the display for a while, “GUI” appears and the GUI menu appears on the TV screen. Press MENU if the GUI menu does not appear on the TV screen.

2 Press \uparrow/\downarrow repeatedly to select “Settings” then press \oplus or \rightarrow .

The Settings menu list appears on the TV screen.

3 Press \uparrow/\downarrow repeatedly to select “Speaker”, then press \oplus or \rightarrow .

4 Press \uparrow/\downarrow repeatedly to select “SP Pattern”, then press \oplus or \rightarrow .

5 Press \uparrow/\downarrow repeatedly to select the appropriate speaker pattern so that there are no surround back speakers and front high speakers, then press \oplus .

6 Press \uparrow/\downarrow repeatedly to select “SB Assign”, then press \oplus or \rightarrow .

7 Press \uparrow/\downarrow repeatedly to select “BI-AMP”, then press \oplus .

The same signals output from the SPEAKERS FRONT A terminals can be output from the SPEAKERS SURROUND BACK/FRONT HIGH/BI-AMP/FRONT B terminals.

To exit the menu

Press MENU.

Notes

- Set “SB Assign” to “BI-AMP” before you perform Auto Calibration.
- If you set “SB Assign” to “BI-AMP”, the speaker level and distance settings of the surround back speakers and front high speakers become invalid, and those of the front speakers are used.
- If you set “SP Pattern” to a setting with surround back speakers or front high speakers, you cannot set “SB Assign” to “BI-AMP”.

Using the setting menu

You can adjust various settings for speakers, surround effects, etc. using the setting menu. To display the menu of the receiver on the TV screen, make sure that the receiver is in “GUI MODE” by following the steps in “To turn “GUI MODE” on and off” (page 44).

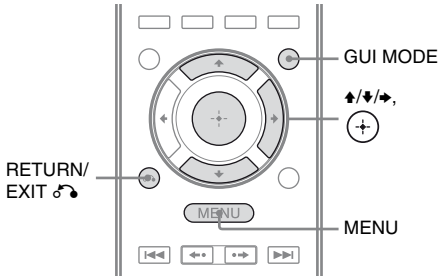

1 Press GUI MODE.

After “MENU ON” appears on the display for a while, “GUI” appears and the GUI menu appears on the TV screen. Press MENU if the GUI menu does not appear on the TV screen.

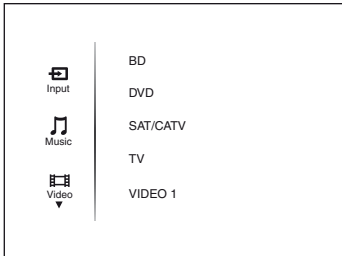

2 Press \uparrow/\downarrow repeatedly to select “Settings”, then press \oplus or \rightarrow to enter the menu mode.

The Setting menu list appears on the TV screen.

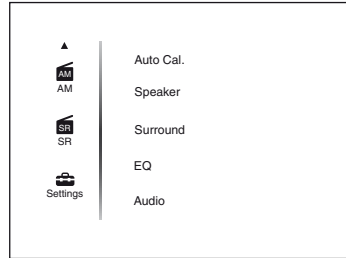

3 Press \uparrow/\downarrow repeatedly to select the menu item you want, then press \oplus or \rightarrow .

Example: When you select “Auto Cal.”.

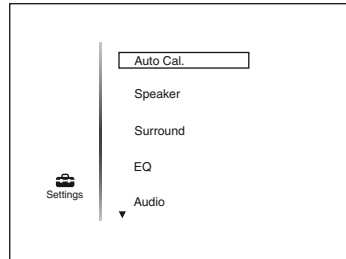

4 Press \uparrow/\downarrow repeatedly to select the parameter you want, then press \oplus or \rightarrow .

To return to the previous screen
Press RETURN/EXIT \curvearrowright .

To exit the menu
Press MENU.

Note

appears for models of area code U2, CA2 only.

Setting menu list

Menu	Description
Auto Cal.	Sets the speaker level or distance and makes the measurement automatically (page 90).
Speaker	Sets the speaker position manually (page 91).
Surround	Adjusts the sound field (surround effect) you choose (page 95).
EQ	Adjusts the equalizer (bass/treble sound) (page 96).
Audio	Sets various sound items (page 96).
Video	Adjusts the resolution of analog video signals (page 97).
HDMI	Makes settings for sound/images from components connected to the HDMI jacks (page 98).
System	Sets the receiver switch to standby mode automatically (page 100).
S-AIR	Makes settings for S-AIR operations (page 75).

Auto Calibration menu

You can make settings for the Auto Calibration function to suit your preference.

Auto Cal. Start (Auto Calibration start)

Lets you perform Auto Calibration. For details, see “2: Performing Auto Calibration” (page 40).

Auto Cal. Type (Auto Calibration type)

Lets you select the Auto Calibration type for each seating position. For details, see step 4 of “3: Confirming/saving the measurement results” (page 41).

Note

You can select this parameter only when you have performed the Auto Calibration and saved the measurement result.

Position

You can register 3 patterns as Position 1, 2, and 3, depending on the listening position, listening environment, and measurement conditions.

To register settings for the listening environment

You can select the seating position you want and register the measurement results of the Auto Calibration for that seating position.

- 1 Press \uparrow/\downarrow repeatedly to select “Position”, then press \oplus or \rightarrow .
- 2 Press \uparrow/\downarrow repeatedly to select the position (Position 1, 2, 3) for which you want to register the measurement result, then press \oplus .
- 3 Press \uparrow/\downarrow repeatedly to select “Auto Cal. Start”, then press \oplus or \rightarrow .
The measurement results is registered as the position you selected in step 2.
- 4 Press \oplus to select “START”.
- 5 Repeat step 1 to 3 to register another seating position.

To select the registered seating position

- 1 Press \uparrow/\downarrow repeatedly to select “Position”, then press \oplus or \rightarrow .
- 2 Press \uparrow/\downarrow repeatedly to select the position (Position 1, 2, 3) you want, then press \oplus .
The registered seating position is selected.

Name Input (Naming position)

You can rename the position name.

- 1 Select the “Position” for which you want to name.
- 2 Press \uparrow/\downarrow repeatedly to select “Name Input”, then press \oplus or \rightarrow .
- 3 Press $\uparrow/\downarrow/\leftarrow/\rightarrow$ to select a character, then press \oplus .
The name you entered is registered.

Speaker Settings menu

You can adjust each speaker manually.
You can also adjust the speaker levels after the Auto Calibration is completed.

Note

The speaker settings are only for the current seating position.

SP Pattern (Speaker pattern)

Select “SP Pattern” according to the speaker system which you are using. You do not need to select the speaker pattern after Auto Calibration.

- 1 Press \uparrow/\downarrow repeatedly to select “SP Pattern”, then press \oplus or \rightarrow .
The “SP Pattern” screen appears.
- 2 Press \uparrow/\downarrow repeatedly to select the speaker pattern you want, then press \oplus .
- 3 Press RETURN/EXIT \rightarrow .

SB Assign (Surround back speaker assign)

You can make settings for the surround back speaker(s) or front high speaker(s). Before you change “SB Assign” to “BI-AMP” or “Speaker B”, be sure you have set “SP Pattern” to a setting without surround back speakers or front high speakers.

- Speaker B
If you connect an additional front speaker system to the SPEAKERS SURROUND BACK/FRONT HIGH/BI-AMP/FRONT B terminals, select “Speaker B”.
- BI-AMP
If you connect front speakers to the SPEAKERS SURROUND BACK/FRONT HIGH/BI-AMP/FRONT B terminals using a bi-amplifier connection, select “BI-AMP”.

- OFF

If you do not use “Speaker B” or “BI-AMP”, select “OFF”.

Note

Set “SB Assign” to “OFF”, then connect the surround back speakers to this receiver when you want to change the connection from a bi-amplifier connection or speakers front B connection to a surround back speakers connection. Re-set up the speakers after you connect the surround back speakers. See “Calibrating the appropriate speaker settings automatically (Auto Calibration)” (page 38).

Manual Setup

You can adjust each speaker manually on the “Manual Setup” screen. You can also adjust the speaker levels after the Auto Calibration is completed.

To adjust the speaker level

You can adjust each speaker’s level (front left/right, front left/right high, center, surround left/right, surround back left/right, subwoofer).

- 1 Press $\uparrow/\downarrow/\leftarrow/\rightarrow$ repeatedly to select the speaker on the screen for which you want to adjust the level, then press \oplus .
- 2 Press \leftarrow/\rightarrow repeatedly to select “Lvl:”.
- 3 Press \uparrow/\downarrow repeatedly to set the level of the selected speaker, then press \oplus .
For front left/right speakers, you can adjust the level from -10.0 dB to $+10.0$ dB in 0.5 dB steps. For other speakers, you can adjust the level from -20.0 dB to $+10.0$ dB in 0.5 dB steps.

Note

When one of the sound fields for music is selected, no sound is output from the subwoofer if all the speakers are set to “Large”. However, the sound will be output from the subwoofer if

- the digital input signal contains LFE signals.
- the front or surround speakers are set to “Small”.
- the sound field for movie is selected.
- “Portable Audio” is selected.

To adjust the distance from the seating position to each speaker

You can adjust the distance from the listening position to each speaker (front left/right, front left/right high, center, surround left/right, surround back left/right, subwoofer).

- 1 Press $\uparrow/\downarrow/\leftarrow/\rightarrow$ repeatedly to select the speaker on the screen for which you want to adjust the distance from the seating position, then press \oplus .
- 2 Press \leftarrow/\rightarrow repeatedly to select “Dist:”.
- 3 Press \uparrow/\downarrow repeatedly to set the distance of the selected speaker, then press \oplus .

You can adjust the distance from 3 feet 3 inches to 32 feet 9 inches (1.00 meter to 10.00 meters) in 1 inch (0.01 meter) steps.

Notes

- Depending on the speaker pattern setting, some parameters may not be available.
- This function does not work in the following cases.
 - Sound Field is set to “Analog Direct”.
 - Signals with a sampling frequency of more than 96 kHz are being received.

To adjust the size of each speaker

You can adjust each speaker’s (front left/right, front left/right high, center, surround left/right, surround back left/right) size.

- 1 Press $\uparrow/\downarrow/\leftarrow/\rightarrow$ repeatedly to select the speaker on the screen for which you want to adjust the size, then press \oplus .
- 2 Press \leftarrow/\rightarrow repeatedly to select “Size:”.

3 Press **▲/▼** repeatedly to set the size of the selected speaker, then press **⊕**.

- Large

If you connect large speakers that will effectively reproduce bass frequencies, select “Large”. Normally, select “Large”.

- Small

If the sound is distorted, or you feel a lack of surround effects when using multi channel surround sound, select “Small” to activate the bass redirection circuitry and output the bass frequencies of each channel from the subwoofer or other “Large” speakers.

Note

This function does not work when “Analog Direct” is being used.

Tips

- The “Large” and “Small” settings for each speaker determine whether the internal sound processor will cut the bass signal from that channel.

When the bass is cut from a channel, the bass redirection circuitry sends the corresponding bass frequencies to the subwoofer or other “Large” speakers.

However, since bass sound has a certain amount of directionality, it is best not to cut it, if possible.

Therefore, even when using small speakers, you can set them to “Large” if you want to output the bass frequencies from that speaker. On the other hand, if you are using a large speaker, but prefer not to have bass frequencies output from that speaker, set it to “Small”.

If the overall sound level is lower than you prefer, set all speakers to “Large”. If there is not enough bass, you can use the equalizer to boost the bass levels.

- The surround back speakers will be set to the same setting as that of the surround speakers.

- When the front speakers are set to “Small”, the center, surround, and front high speakers are also automatically set to “Small”.

- If you do not use the subwoofer, the front speakers are automatically set to “Large”.

Crossover Frequency (Speaker crossover frequency)

Lets you set the bass crossover frequency of speakers that the speaker size has been set to “Small” in the Speaker Settings menu.

Measured speaker crossover frequency is set for each speaker after the Auto Calibration.

1 Press **▲/▼** repeatedly to select the speaker on the screen you want to adjust, then press **⊕**.

2 Press **▲/▼** repeatedly to adjust the value, then press **⊕**.

Test Tone

You can select the test tone type on the “Test Tone” screen.

Tips

- To adjust the level of all speakers at the same time, press MASTER VOL +/- . You can also use MASTER VOLUME on the receiver.

- The adjusted value is shown on the TV screen during adjustment.

To output test tone from each speaker

You can output test tone from the speakers in sequence.

1 Press **◀/▶** repeatedly to select “Test Tone”, then press **⊕**.

2 Press **▲/▼** repeatedly to adjust the parameter, then press **⊕**.

- OFF

- AUTO

The test tone is output from each speaker in sequence.

- FL, CNT, FR, SR, SB, SBR, SBL, SL, LH, RH, SW

You can select which speakers will output the test tone.

3 Press **▲/▼** repeatedly to adjust the speaker level, then press **⊕**.

continued

To output test tone from adjacent speakers

You can output test tone from adjacent speakers so that you can adjust the balance between the speakers.

- 1 Press **◀/▶** repeatedly to select “Phase Noise”, then press **⊕**.
- 2 Press **▲/▼** repeatedly to adjust the parameter, then press **⊕**.
 - OFF
 - LH/FR, LH/RH, FL/RH, FL/SR, SL/FL, SB/SL, SBL/SL, SBR/SBL, SR/SB, SR/SBR, SR/SL, FR/SR, FR/SL, CNT/FR, FL/CNTLets you output the test tone sequentially from adjacent speakers.
Some items may not be displayed, depending on the setting of the speaker pattern.
- 3 Press **▲/▼** repeatedly to adjust the speaker level, then press **⊕**.

To output the source sound from adjacent speakers

You can output the source sound from adjacent speakers so that you can adjust the balance between the speakers.

- 1 Press **◀/▶** repeatedly to select “Phase Audio”, then press **⊕**.
- 2 Press **▲/▼** repeatedly to adjust the parameter, then press **⊕**.
 - OFF
 - LH/FR, LH/RH, FL/RH, FL/SR, SL/FL, SB/SL, SBL/SL, SBR/SBL, SR/SB, SR/SBR, SR/SL, FR/SR, FR/SL, CNT/FR, FL/CNTLets you output front 2 channel source sound (instead of the test tone) sequentially from adjacent speakers.
Some items may not be displayed, depending on the setting of the speaker pattern.
- 3 Press **▲/▼** repeatedly to adjust the speaker level, then press **⊕**.

When a test tone is not output from the speakers

- The speaker cords may not be connected securely. Check to see if they are connected securely and cannot be disconnected by pulling on them slightly.
- The speaker cords may have the short-circuit problem.

When a test tone is output from a different speaker than the speaker displayed on the TV screen

The speaker pattern to the connected speaker is not set up correctly. Make sure the speaker connection and the speaker pattern match.

D.Range Comp (Dynamic range compression)

Lets you compress the dynamic range of the soundtrack. This may be useful when you want to watch movies at low volumes late at night. Dynamic range compression is possible with Dolby Digital sources only.

■ MAX

The dynamic range is compressed dramatically.

■ STD

The dynamic range is compressed as intended by the recording engineer.

■ AUTO

The dynamic range is applied automatically with Dolby TrueHD source or other source is set to “OFF”.

■ OFF

The dynamic range is not compressed.

Tips

- Dynamic range compressor lets you compress the dynamic range of the soundtrack based on the dynamic range information included in the Dolby Digital signal.
- “STD” is the standard setting, but it only enacts light compression. Therefore, we recommend using the “MAX” setting. This greatly compresses the dynamic range and lets you view movies late at night at low volumes. Unlike analog limiters, the levels are predetermined and provide a very natural compression.

Distance Unit

Lets you select the unit of measure for setting distances.

■ FEET

The distance is displayed in feet.

■ METER

The distance is displayed in meters.

Surround Settings menu

You can adjust the sound effect on the “S.F. Select” screen.

Note

The setup items you can adjust on each menu vary depending on the sound field.

S.F. Select (Sound field select)

You can select the surround sound field and adjust the effect level on the “S.F. Select” screen.

For details on the sound field, see “Enjoying Surround Sound” (page 65).

To select the surround sound field

- 1 Press \uparrow/\downarrow repeatedly to select “S.F. Select”, then press \oplus or \rightarrow .
- 2 Press \uparrow/\downarrow repeatedly to select surround sound you want, then press \oplus .

To adjust the effect level

- 1 Press \uparrow/\downarrow repeatedly to select “S.F. Select”, then press \oplus or \rightarrow .
- 2 Press \uparrow/\downarrow repeatedly to select surround sound you want, then press \oplus or \rightarrow .

Note

Effect Level adjustment is valid only when “Cinema St EX **DCS**” is selected.

- 3 Press \uparrow/\downarrow repeatedly to select effect level you want, then press \oplus .
 - MAX
 - STD
 - MIN

EQ Settings menu

You can use the following parameters to adjust the tonal quality (bass/treble level) of front speakers.

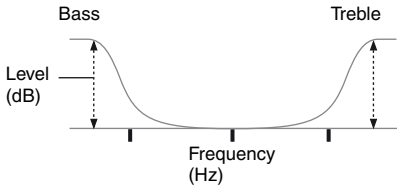

Notes

- This function does not work in the following cases.
 - Sound Field is set to “Analog Direct”.
 - Signals with a sampling frequency of more than 48 kHz are being received.
- If the equalizer is adjusted while the receiver is receiving signals with a sampling frequency of more than 96 kHz, the signals will always be played back at 96 kHz.

To adjust the equalizer on the EQ screen

- 1 Press \leftarrow/\rightarrow repeatedly to select “Bass” or “Treble”.
- 2 Press \uparrow/\downarrow repeatedly to adjust the gain, then press \oplus .

Audio Settings menu

You can make settings for the audio to suit your preference.

A/V Sync (Synchronizes audio with video output)

Lets you delay the output of audio to minimize the time gap between audio output and visual display. You can adjust the delay from 0 ms to 300 ms in 10 ms steps.

Notes

- This parameter is useful when you use a large LCD or plasma monitor or a projector.
- This function does not work in the following cases.
 - Sound Field is set to “Analog Direct”.
 - Signals with a sampling frequency of more than 96 kHz are being received.

Dual Mono (Digital broadcast language selection)

Lets you select the language you want to listen to during digital broadcast. This feature only functions for Dolby Digital sources.

■ Main/Sub

Sound of the main language will be output through the front left speaker and sound of the sub language will be output through the front right speaker simultaneously.

■ Main

Sound of the main language will be output.

■ Sub

Sound of the sub language will be output.

Dec. Priority (Digital audio input decoding priority)

Lets you specify the input mode for the digital signal input to the DIGITAL IN jacks or HDMI IN jacks.

■ AUTO

Automatically switches the input mode between DTS, Dolby Digital, or PCM.

■ PCM

When signals from the DIGITAL IN jack are selected, PCM signals are given priority (to prevent interruption when playback starts). However, when other signals are input, there may be no sound, depending on the format. In this case, set this item to "AUTO". When signals from the HDMI IN jack are selected, only PCM signals are output from the connected player. When signals other than PCM are received, set this item to "AUTO".

Notes

- Even when "Dec. Priority" is set to "PCM", the sound may be interrupted at the very beginning of the first track depending on the CD being played back.
- When playback a DTS CD, set "Dec. Priority" to "AUTO".

Video Settings menu

You can make settings for video.

Resolution (Converting video signals)

Lets you convert the resolution of analog video input signals (component video and video) and output from the HDMI TV OUT jack.

■ AUTO

The resolution is set automatically, depending on the connected TV.

■ 480/576p

The resolution is set to 480p/576p. Video signals are upconverted and output through the receiver.

■ 720p

The resolution is set to 720p. Video signals are upconverted and output through the receiver.

■ 1080i

The resolution is set to 1080i. Video signals are upconverted and output through the receiver.

■ 1080p

The resolution is set to 1080p. Video signals are upconverted and output through the receiver.

Note

If you select a resolution that the connected TV does not support in "Resolution" menu, the images from the TV will not be output correctly.

Comp.Dec. (Component video decoder)

If the image is distorted when you connect to video game, set “Comp.Dec.” to “ON”. This setting is only applicable for component video input signals.

■ ON

■ OFF

HDMI Settings menu

You can make the required settings for components connected to the HDMI jack.

Ctrl for HDMI (Control for HDMI)

Lets you turn the Control for HDMI function on or off. For details, see “Preparing for the “BRAVIA” Sync” (page 70).

■ ON

■ OFF

Note

When you set “Ctrl for HDMI” to “ON”, “Audio Out” may be changed automatically.

Pass Through

Lets you output the HDMI signals to the TV even when the receiver is in standby mode.

■ ON

When the receiver is in the standby mode, the receiver continuously outputs HDMI signals from the receiver’s HDMI TV OUT jack.

■ AUTO

When the TV is turned on while the receiver is in the standby mode, the receiver outputs HDMI signals from the receiver’s HDMI TV OUT jack. Sony recommends this setting if you use a TV that is compatible with “BRAVIA” Sync. This setting saves power in the standby mode compared with the “ON” setting.

■ OFF

The receiver does not output HDMI signals when in the standby mode.

Turn on the receiver to enjoy the connected component’s source on the TV. This setting saves power in the standby mode compared with the “ON” setting.

Notes

- This parameter is not available when “Ctrl for HDMI” is set to “OFF”.
- When “AUTO” is selected, it may take a little more time for the image and sound to be output to the TV than when “ON” is selected.
- When the receiver is in standby mode, “A.STANDBY” appears on the display if “Pass Through” is set to “AUTO” or “ON”. However, “A.STANDBY” will disappear when “Pass Through” is set to “AUTO” and no signals are detected.

Audio Out (Setting HDMI audio input)

Lets you set the audio output for HDMI from the playback component connected to the receiver via an HDMI connection.

■ AMP

The HDMI audio signals from the playback component is only output to the speakers connected to the receiver. Multi channel sound can be played back as it is.

Note

Audio signals are not output from the TV speakers when “Audio Out” is set to “AMP”.

■ TV+AMP

The sound is output from TV’s speaker and the speakers connected to the receiver.

Notes

- The sound quality of the playback component depends on the TV’s sound quality, such as the number of channels, and the sampling frequency, etc. When the TV has stereo speakers, the sound output from the receiver is also stereo as that of the TV, even if you play back multi channel source.
- When you connect the receiver to an image display component (projector, etc.), sound may not be output from the receiver. In this case, select “AMP”.
- When you select the input that you have assigned the HDMI input, sound does not output from the TV.

SW Level (Subwoofer level for HDMI)

Lets you set the level of the subwoofer to 0 dB or +10 dB when PCM signals are input via an HDMI connection. You can set the level for each HDMI input independently.

■ AUTO

Automatically sets the level to 0 dB or +10 dB depending on the frequency.

■ +10 dB

■ 0 dB

SW L.P.F. (Subwoofer Low Pass Filter for HDMI)

Lets you set the low pass filter of the subwoofer when multi channel Linear PCM signals are input via an HDMI connection. Set the “SW L.P.F.” if your connected subwoofer’s crossover frequency do not have low pass filter.

■ ON

The low pass filter of the subwoofer’s cut off frequency is set to 120 Hz.

■ OFF

The low pass filter of the subwoofer is turned off.

ARC (Audio Return Channel)

Lets you enjoy the TV sound from the speakers connected to the receiver via an HDMI cable. For details, see “Enjoying the TV sound via an HDMI cable” (page 74).

■ ON

Audio signal is input to the HDMI TV OUT jack.

■ OFF

Audio signal is input to the TV OPTICAL IN or TV AUDIO IN jack.

Note

This parameter is not available when “Ctrl for HDMI” is set to “OFF”.

System Settings menu

You can customize the settings of the receiver.

Auto Standby

Lets you set the receiver switch to standby mode automatically when you do not operate the receiver or when there is no signals input to the receiver.

■ ON

Switches to standby mode after approximately 30 minutes.

■ OFF

Does not switch to standby mode.

Notes

- This function does not work in the following cases.
 - TUNER input is selected.
 - S-AIR receiver or surround amplifier is used.
- If you use the Auto standby mode and the Sleep Timer at the same time, the Sleep Timer has priority.

Operating without connecting to a TV

You can operate this receiver using the display even if you do not use a GUI when a TV is not connected.

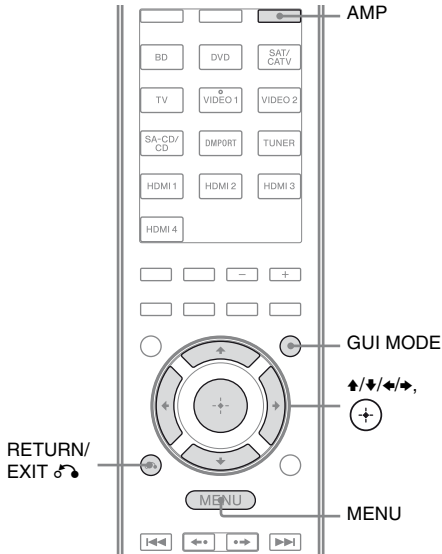

4 Press **↑/↓** repeatedly to select the parameter you want to adjust, then press **+** or **→**.

5 Press **↑/↓** repeatedly to select the setting you want, then press **+**.

To return to the previous display

Press **←** or RETURN/EXIT .

To exit the menu

Press MENU.

Note

Some parameters and settings may appear dimmed on the display. This means that they are either unavailable or fixed and unchangeable.

Using the menu in the display

Press GUI MODE repeatedly to select “MENU OFF”.

When “GUI” is displayed on the display, the menu is set to display on the TV screen using a GUI.

1 Press AMP.

2 Press MENU.

3 Press **↑/↓** repeatedly to select the menu you want, then press **+** or **→**.

Overview of the menus

The following options are available in each menu. For details on navigating through menus, see page 101.

Menu [Display]	Parameters [Display]	Settings	Initial setting
Auto Calibration settings [<AUTO CAL>]	Auto Calibration start [A.CAL START]		
	Calibration type [CAL TYPE]	FULL FLAT, ENGINEER, FRONT REF, OFF	FULL FLAT
	Position [POSITION]	POS 1, POS 2, POS 3	POS 1
	Naming position [NAME IN]	For details, see “Name Input (Naming position)” (page 91).	
Level settings [<LEVEL>]	Test tone ^{a)} [TEST TONE]	OFF, FIX ■■■■ ^{b)} , AUTO ■■■■ ^{b)}	OFF
	Phase noise ^{a)} [P. NOISE]	OFF, LH/FR, LH/RH, FL/RH, FL/SR, SL/FL, SB/SL, SBL/SL, SBR/SBL, SR/SB, SR/SBR, SR/SL, FR/SR, FR/SL, CNT/FR, FL/CNT	OFF
	Phase audio ^{a)} [P. AUDIO]	OFF, LH/FR, LH/RH, FL/RH, FL/SR, SL/FL, SB/SL, SBL/SL, SBR/SBL, SR/SB, SR/SBR, SR/SL, FR/SR, FR/SL, CNT/FR, FL/CNT	OFF
	Front left speaker level ^{a)} [FL LEVEL]	FL -10.0 dB to FL +10.0 dB (0.5 dB per step)	FL 0 dB
	Front right speaker level ^{a)} [FR LEVEL]	FR -10.0 dB to FR +10.0 dB (0.5 dB per step)	FR 0 dB
	Center speaker level ^{a)} [CNT LEVEL]	CNT -20.0 dB to CNT +10.0 dB (0.5 dB per step)	CNT 0 dB
	Surround left speaker level ^{a)} [SL LEVEL]	SL -20.0 dB to SL +10.0 dB (0.5 dB per step)	SL 0 dB
	Surround right speaker level ^{a)} [SR LEVEL]	SR -20.0 dB to SR +10.0 dB (0.5 dB per step)	SR 0 dB
	Surround back speaker level ^{a)} [SB LEVEL]	SB -20.0 dB to SB +10.0 dB (0.5 dB per step)	SB 0 dB
	Surround back left speaker level ^{a)} [SBL LEVEL]	SBL -20.0 dB to SBL +10.0 dB (0.5 dB per step)	SBL 0 dB
	Surround back right speaker level ^{a)} [SBR LEVEL]	SBR -20.0 dB to SBR +10.0 dB (0.5 dB per step)	SBR 0 dB
	Front left high speaker level ^{a)} [LH LEVEL]	LH -20.0 dB to LH +10.0 dB (0.5 dB step)	LH 0 dB
	Front right high speaker level ^{a)} [RH LEVEL]	RH -20.0 dB to RH +10.0 dB (0.5 dB step)	RH 0 dB

Menu [Display]	Parameters [Display]	Settings	Initial setting
	Subwoofer level ^{a)} [SW LEVEL]	SW -20.0 dB to SW +10.0 dB (0.5 dB per step)	SW 0 dB
	Dynamic range compression [D. RANGE]	COMP. MAX, COMP. STD, COMP. AUTO, COMP. OFF	COMP. AUTO
Speaker settings [<SPEAKER>]	Speaker pattern [SP PATTERN]	5/2.1, 5/2, 4/2.1, 4/2, 3/4.1, 3/4, 2/4.1, 2/4, 3/3.1, 3/3, 2/3.1, 2/3, 3/2.1, 3/2, 2/2.1, 2/2, 3/0.1, 3/0, 2/0.1, 2/0	3/4.1
	Front speakers size ^{a)} [FRT SIZE]	LARGE, SMALL	LARGE
	Center speaker size ^{a)} [CNT SIZE]	LARGE, SMALL	LARGE
	Surround speakers size ^{a)} [SUR SIZE]	LARGE, SMALL	LARGE
	Front high speakers size ^{a)} [FH SIZE]	LARGE, SMALL	LARGE
	Surround back speaker assign ^{c)} [SB ASSIGN]	SPK B, BI-AMP, OFF	OFF
	Front left speaker distance ^{a)} [FL DIST.]	FL 3'3" to FL 32'9" (FL 1.00 m to FL 10.00 m) (1 inch (0.01 m) step)	FL 9'10" (FL 3.00 m)
	Front right speaker distance ^{a)} [FR DIST.]	FR 3'3" to FR 32'9" (FR 1.00 m to FR 10.00 m) (1 inch (0.01 m) step)	FR 9'10" (FR 3.00 m)
	Center speaker distance ^{a)} [CNT DIST.]	CNT 3'3" to CNT 32'9" (CNT 1.00 m to CNT 10.00 m) (1 inch (0.01 m) step)	CNT 9'10" (CNT 3.00 m)
	Surround left speaker distance ^{a)} [SL DIST.]	SL 3'3" to SL 32'9" (SL 1.00 m to SL 10.00 m) (1 inch (0.01 m) step)	SL 9'10" (SL 3.00 m)
	Surround right speaker distance ^{a)} [SR DIST.]	SR 3'3" to SR 32'9" (SR 1.00 m to SR 10.00 m) (1 inch (0.01 m) step)	SR 9'10" (SR 3.00 m)
	Surround back speaker distance ^{a)} [SB DIST.]	SB 3'3" to SB 32'9" (SB 1.00 m to SB 10.00 m) (1 inch (0.01 m) step)	SB 9'10" (SB 3.00 m)
	Surround back left speaker distance ^{a)} [SBL DIST.]	SBL 3'3" to SBL 32'9" (SBL 1.00 m to SBL 10.00 m) (1 inch (0.01 m) step)	SBL 9'10" (SBL 3.00 m)
	Surround back right speaker distance ^{a)} [SBR DIST.]	SBR 3'3" to SBR 32'9" (SBR 1.00 m to SBR 10.00 m) (1 inch (0.01 m) step)	SBR 9'10" (SBR 3.00 m)
	Front left high speaker distance ^{a)} [LH DIST.]	LH 3'3" to LH 32'9" (LH 1.00 m to LH 10.00 m) (1 inch (0.01 m) step)	LH 9'10" (LH 3.00 m)
	Front right high speaker distance ^{a)} [RH DIST.]	RH 3'3" to RH 32'9" (RH 1.00 m to RH 10.00 m) (1 inch (0.01 m) step)	RH 9'10" (RH 3.00 m)

continued

Menu [Display]	Parameters [Display]	Settings	Initial setting
	Subwoofer distance ^{a)} [SW DIST.]	SW 3'3" to SW 32'9" (SW 1.00 m to SW 10.00 m) (1 inch (0.01 m) step)	SW 9'10" (SW 3.00 m)
	Distance unit [DIST. UNIT]	FEET, METER	FEET ^{d)}
	Front speaker crossover frequency ^{e)} [FRT CROSS]	CROSS 40 Hz to CROSS 200 Hz (10 Hz step)	CROSS 120 Hz
	Center speaker crossover frequency ^{e)} [CNT CROSS]	CROSS 40 Hz to CROSS 200 Hz (10 Hz step)	CROSS 120 Hz
	Surround speaker crossover frequency ^{e)} [SUR CROSS]	CROSS 40 Hz to CROSS 200 Hz (10 Hz step)	CROSS 120 Hz
	Front high speaker crossover frequency ^{e)} [FH CROSS]	CROSS 40 Hz to CROSS 200 Hz (10 Hz step)	CROSS 120 Hz
Surround settings [<SURROUND>]	Sound field selection [S.F. SELECT]	For details, see "Enjoying Surround Sound" (page 65).	MULTI ST. ^{j)}
	Effect level ^{f)} [EFFECT]	EFCT. MAX, EFCT. STD, EFCT. MIN	EFCT. STD
EQ settings [<EQ>]	Front speakers bass level [BASS]	BASS -10 dB to BASS +10 dB (1 dB per step)	BASS 0 dB
	Front speakers treble level [TREBLE]	TREBLE -10 dB to TREBLE +10 dB (1 dB per step)	TREBLE 0 dB
Tuner settings [<TUNER>]	FM station receiving mode [FM MODE]	STEREO, MONO	STEREO
	Naming preset stations [NAME IN]	For details, see "Naming preset stations (Name Input)" (page 56).	
	Parental lock ^{g)} [PARENTAL]	LOCK ON, LOCK OFF	LOCK OFF
	Lock code edit ^{g)} [CODE EDIT]	For details, see "Restricting access to specific channels (Parental Lock)" (page 62).	
	SIRIUS antenna aiming mode ^{g)} [SR ANT AIM]	For details, see "Checking receiving conditions (Antenna Aiming)" (page 59).	
	SIRIUS radio ID ^{g)} [SIRIUS ID]	For details, see "Checking the SIRIUS Radio ID" (page 58).	

Menu [Display]	Parameters [Display]	Settings	Initial setting
Audio settings [<AUDIO>]	Synchronizes audio with video output [A/V SYNC]	0 ms to 300 ms (10 ms per step)	0 ms
	Digital broadcast language selection [DUAL MONO]	MAIN/SUB, MAIN, SUB	MAIN
	Digital audio input decoding priority [DEC. PRIO.]	DEC. AUTO, DEC. PCM	DEC. AUTO
	Digital audio input assignment [A. ASSIGN]	For details, see “Enjoying the sound/ images from other inputs” (page 85).	
Video settings [<VIDEO>]	Resolution [RESOLUTION]	AUTO, 480/576p, 720p, 1080i, 1080p	AUTO
	Video input assignment [V. ASSIGN]	For details, see “Enjoying the sound/ images from other inputs” (page 85).	
	Switching component signals [COMP. DEC.]	DEC. ON, DEC. OFF	DEC. OFF
HDMI settings [<HDMI>]	Control for HDMI [CTRL:HDMI]	CTRL ON, CTRL OFF	CTRL ON
	HDMI Signal Pass Through [PASS THRU]	ON, AUTO, OFF	OFF
	Setting HDMI audio input [AUDIO OUT]	AMP, TV+AMP	AMP
	Subwoofer level for HDMI ^{h)} [SW LEVEL]	SW AUTO, SW +10 dB, SW 0 dB	SW AUTO
	Subwoofer Low Pass Filter for HDMI ^{h)} [SW L.P.F.]	L.P.F. ON, L.P.F. OFF	L.P.F. ON
	Audio Return Channel [ARC]	ARC ON, ARC OFF	ARC ON
System settings [<SYSTEM>]	Brightness of the display [DIMMER]	DIM MAX, DIM MID, DIM OFF	DIM OFF
	Auto standby mode [AUTO STBY]	STBY ON, STBY OFF	STBY ON
	Naming inputs [NAME IN]	For details, see “Name Input” (page 47).	

Menu [Display]	Parameters [Display]	Settings	Initial setting
S-AIR settings [<S-AIR>]	S-AIR ID ⁱ⁾ [S-AIR ID]	ID: A, ID: B, ID: C	ID: A
	Pairing ⁱ⁾ [PAIRING]	START, CONDITION	START
	S-AIR mode ⁱ⁾ [S-AIR MODE]	PARTY, SEPARATE	PARTY
	RF Change ⁱ⁾ [RF CHANGE]	RF AUTO, RF ON, RF OFF	RF AUTO
	S-AIR Standby ⁱ⁾ [S-AIR STBY]	STBY ON, STBY OFF	STBY OFF

a) Depends on the speaker pattern setting, some parameters or settings may not be available.

b) ■■■ represent a speaker channel (FL, FR, CNT, SL, SR, SB, SBL, SBR, LH, RH, SW).

c) You can only select this parameter if “SP PATTERN” is not set to a setting with surround back or front high speakers (page 91).

d) “METER” for models of area code CEK, ECE, AU1 and TW2.

e) You can only select this parameter if your speaker is set to “SMALL”.

f) You can only select this parameter if you select Cinema Studio A/B/C as sound field.

g) This parameter is only available if the SiriusConnect Home tuner is connected to the SIRIUS jack on the receiver.

h) This parameter is only available when HDMI input is selected.

i) This parameter is only available if the S-AIR transmitter (not supplied) is inserted to the EZW-T100 slot on the receiver.

j) “A.F.D. AUTO” for models of area code CEK, ECE, AU1 and TW2.

Performing Auto Calibration

For details on the Auto Calibration, see “Calibrating the appropriate speaker settings automatically (Auto Calibration)” (page 38). See “Before you perform Auto Calibration” (page 38) before performing the Auto Calibration.

To operate on the receiver

- 1 Press GUI MODE repeatedly to select “MENU OFF”.
- 2 Press AMP.
Receiver operation is enabled.
- 3 Press MENU.
- 4 Press \uparrow/\downarrow repeatedly to select “<AUTO CAL>”, then press \oplus or \rightarrow .
- 5 Press \uparrow/\downarrow repeatedly to select “A.CAL START”, then press \oplus to start the measurement.
Measurement starts in 5 seconds. A count down is displayed.

Note

While the time is counting down, stand away from the measurement area to avoid measurement error.

- 6 Measurement starts.
The measurement process will take approximately 30 seconds. Wait until the measurement process completes.

To cancel Auto Calibration

The Auto Calibration function will be canceled when you do the following during the measurement process:

- Press I/⏻.
- Press the input buttons on the remote or press the INPUT SELECTOR +/– repeatedly on the receiver.
- Press MUTING (RM-AAP051 only) or \times (RM-AAP052 only) on the remote. You can also use MUTING on the receiver.
- Press SPEAKERS on the receiver.
- Change the volume level.
- Connect the headphones.

Tips

- Operations other than turning the receiver on or off are deactivated during Auto Calibration.
- The measurements may not be performed correctly or Auto Calibration cannot be performed when special speakers, such as dipole speakers are used.

To confirm/save Auto Calibration results when GUI function is turned off

- 1 Confirm the measurement result.
When the measurement ends, a beep sounds and the measurement result appears on the display.

Measurement process [Display]	Explanation
Completes properly [SAVE EXIT]	Proceed to step 2.
Fails [E - ■■■ ^a :■■■ ^b]	See “Message list after Auto Calibration measurement” (page 43).

a) ■■■ represent a speaker channel.

F Front

S Surround

SB Surround back

FH Front high

Depending on the error code, the speaker channel may not appear.

b) ■■ represent an error code.

- 2** View the measurement result.
Press AMP and then press $\blacktriangle/\blacktriangledown$ repeatedly to select the item. Then press \oplus .

Item and explanation

EXIT

Exits the setting process without saving the measurement results.

LEVEL INFO.

Displays the measurement result for speaker level.

DIST. INFO.

Displays the measurement result for speaker distance.

PHASE INFO.

Displays the phase of each speaker (in phase/out of phase). See “When you select “PHASE INFO.”” (page 108).

WARN CHECK

Displays warning concerning the measurement results. See “Message list after Auto Calibration measurement” (page 43).

SAVE EXIT

Saves the measurement results and exits the setting process.

RETRY

Performs the Auto Calibration again.

- 3** Save the measurement result.
Select “SAVE EXIT” in step 2.
“COMPLETE” appears on the display and the settings are registered as selected position number.
- 4** Select the calibration type.
Press $\blacktriangle/\blacktriangledown$ repeatedly to select CAL TYPE, then press \oplus .

Calibration type and explanation

FULL FLAT

Makes the measurement of frequency from each speaker flat.

ENGINEER

Sets the frequency characteristics to a set that matches that of the Sony listening room standard.

FRONT REF

Adjusts the characteristics of all the speakers to match the characteristics of the front speaker.

OFF

Set the Auto Calibration to off.

- 5** Disconnect the optimizer microphone after you have finished.

Note

If you have reposition your speaker, we recommend that you perform Auto Calibration again to enjoy the surround sound.

Tip

The size of a speaker (LARGE/SMALL) is determined by the low frequency characteristics. The measurement results may vary, depending on the position of the optimizer microphone and speakers, and the shape of the room. It is recommended that you follow the measurement results. However, you can change those settings in the Speaker Settings menu. Save the measurement results first, then try to change the settings if you want.

When you select “PHASE INFO.”

You can check the phase of each speaker (in phase/out of phase).

- 1** Press $\blacktriangle/\blacktriangledown$ repeatedly to select a speaker you want to check.

Display and explanation

■■■■* : IN

The speaker is in phase.

■■■■* : OUT

The speaker is out of phase. The “+” and “-” terminals of the speaker may be connected the other way around. However, depending on the speakers, “■■■■:OUT” appears on the display even though the speakers are connected properly. This is because of the speakers’ specifications. In this case, you can continue to use the receiver.

* ■■■■ represent a speaker channel.

FL	Front left
FR	Front right
CNT	Center
SL	Surround left
SR	Surround right
SBL	Surround back left
SBR	Surround back right
LH	Front left high
RH	Front right high
SW	Subwoofer

Depending on the measurement result, the speaker channel may not appear.

- 2 Press **+** to return to step 2 in “To confirm/save Auto Calibration results when GUI function is turned off” (page 107).

Tip

Depending on the position of the subwoofer, the measurement results for polarity may vary. However, there will be no problems even if you continue to use the receiver with that value.

Selecting a sound field type

For details on each sound field type, see “Enjoying Surround Sound” (page 65).

Listening to the FM/AM radio

For details on the tuner function, see “Tuner Operations” (page 53).

Tuning radio stations

- 1 Press TUNER repeatedly to select the FM or AM band.
You can also use INPUT SELECTOR +/- on the receiver.
- 2 Press TUNING + or TUNING –.
Press TUNING + to scan from low to high frequencies, press TUNING – to scan from high to low frequencies. The receiver stops scanning whenever a station is received.

Selecting a frequency directly (Direct Tuning)

- 1 After selecting the FM or AM band, press D.TUNING.
- 2 Press SHIFT, then press numeric buttons to enter the frequency.
- 3 Press **+**.

Presetting radio stations

- 1 **Tune in the station that you want to preset.**

For details on the operation, see “Tuning radio stations” (page 109).

- 2 **Press SHIFT, then press MEMORY.**

“MEM” lights up for a few seconds. Perform steps 3 and 4 before “MEM” disappears.

- 3 **Press PRESET + or PRESET – to select a preset number.**

30 FM and 30 AM preset numbers are available. If “MEM” disappears before you select the preset number, start again from step 2.

- 4 **Press ENTER.**

If SHIFT indicator is light off before you press ENTER, press SHIFT. The station is stored as the selected preset number. If “MEM” disappears before you press ENTER, start again from step 2.

- 5 **Repeat steps 1 to 4 to preset another station.**

Selecting a preset station

- 1 Press TUNER repeatedly to select the FM or AM band.
- 2 Press PRESET + or PRESET – repeatedly to select the preset station you want.
You can also press SHIFT, then press numeric buttons to select the preset station you want. Then, press **+** to enter the selection.

Listening to satellite tuner (Models of area code U2, CA2 only)

For details on SIRIUS Radio service, see “Listening to Satellite Radio” (page 57) in “Tuner Operations”.

Aiming the SIRIUS Antenna

You can use “SR ANT AIM” in the Tuner Settings menu to help you aim the antenna for optimal signal reception.

- 1 Press TUNER repeatedly to select “SIRIUS”.
You can also use INPUT SELECTOR +/- on the receiver.
- 2 Press AMP.
- 3 Press MENU.
- 4 Press \uparrow/\downarrow repeatedly to select “<TUNER>”.
- 5 Press \oplus or \rightarrow to enter the menu.
- 6 Press \uparrow/\downarrow repeatedly to select “SR ANT AIM”.
- 7 Press \oplus or \rightarrow to enter the parameter.
- 8 While checking the parameter, aim your antenna to where the best reception will be received.
For details on the parameter, see “SIRIUS Signal strength” below.

SIRIUS Signal strength

Signal strength	Signal type	
	Satellite	Terrestrial
EXC (excellent)	S:3	T:3
GOOD	S:2	T:2
WEAK	S:1	T:1
NONE	S:0	T:0

Checking the SIRIUS Radio ID

- 1 Press TUNER repeatedly to select “SIRIUS”.
You can also use INPUT SELECTOR +/- on the receiver.
- 2 Press TUNING + or TUNING – to select channel 0.
- 3 Check the SIRIUS ID on the display and write it in the space provided here.
SIRIUS ID: _____

Selecting channels from a category (CATEGORY TUNING)

- 1 Press TUNER repeatedly to select “SIRIUS”.
You can also use INPUT SELECTOR +/- on the receiver.
- 2 Press CATEGORY MODE repeatedly to select “ONE CAT”.
 - ALL CAT: You can select a channel from all the categories. The initial setting is “ALL CAT”.
 - ONE CAT: You can select a channel from one category. “CAT” lights up on the display when you set to “ONE CAT” mode.
- 3 Press CATEGORY + or CATEGORY – to select the category you want.
The category is selected and the channel with the lowest number in the specified category is selected.
- 4 Press TUNING + or TUNING – to select the channel.

Selecting a channel number directly (Direct Tuning)

- 1 After selecting satellite tuner, press D.TUNING.
- 2 Press SHIFT, then press numeric buttons to enter the channel number.
- 3 Press \oplus .

Presetting satellite tuner channels (Models of area code U2, CA2 only)

1 Select a channel you want to preset.

For details on this operation, see “Selecting channels from a category (CATEGORY TUNING)” (page 110).

2 Press SHIFT, then press MEMORY.

“MEM” lights up on the display.

3 Press PRESET + or PRESET – to select a preset number.

You can also select the number by pressing SHIFT, then numeric buttons. Preset numbers from 1 to 30 are available. Channel 1 is preset for the preset numbers when you purchase the receiver.

4 Press MEMORY.

If SHIFT indicator is light off before you press MEMORY, press SHIFT. “MEM” lights off.

5 Repeat steps 1 to 4 to preset another channel.

Selecting a preset channel

1 Press TUNER repeatedly to select “SIRIUS”.

2 Press PRESET + or PRESET – repeatedly to select the preset channel you want.

You can also press SHIFT, then numeric buttons to select the preset channel you want. Then, press ⊕ to enter the selection.

Changing the brightness of the front panel display (DIMMER)

You can change the brightness of the front panel display.

1 Press AMP.

2 Press MENU.

3 Press ▲/▼ repeatedly to select “SYSTEM”, then press ⊕ or ➔.

4 Press ▲/▼ repeatedly to select “DIMMER”, then press ⊕ or ➔.

5 Press ▲/▼ repeatedly to select the setting you want, then press ⊕.

The front panel display will change the brightness according to the setting you have selected.

Tip

You can also use DIMMER on the receiver to change the brightness of the front panel display.

Programming the remote

You can customize the remote to match the components connected to your receiver. You can even program the remote to control non-Sony components and also Sony components that the remote is normally unable to control. Before you begin, note that:

- You cannot change the settings of DMPORT input buttons.
- The remote can control only components that accept infrared wireless control signals.

Be sure to turn on the receiver and point the remote towards the receiver when performing the following procedure.

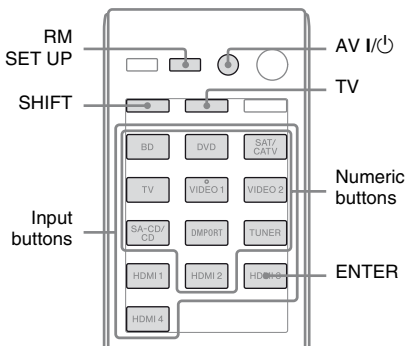

1 Press and hold **RM SET UP**, then press **AV I/⏻**.

The RM SET UP indicator flashes slowly.

2 Press the input button for the component you want to control.

For example, if you are going to control a VCR connected to VIDEO 1 IN, press VIDEO 1.

The RM SET UP and SHIFT indicator light up.

3 Press numeric buttons to enter the numeric code (or one of the codes if more than one code exists) corresponding to the component and the maker of the component you want to control (including TV button).

See the tables on page 113–116 for information on the numeric code(s).

Note

For a TV remote code value, only numbers in the 500's are valid.

4 Press **ENTER**.

Once the numeric code has been verified, the RM SET UP indicator slowly flashes twice and the remote automatically exits the programming mode.

5 Repeat steps 1 to 4 to control other components.

Notes

- The indicator turns off while a valid button is pressed.
- In step 2, if you press TUNER, you can only program the button to control a tuner (page 113).
- For the numeric codes, only the last three numbers entered are valid.

To cancel programming

Press RM SET UP during any step. The RM SET UP indicator flashes 5 times in quick succession. The remote automatically exits the programming mode.

To activate the input after programming

Press the programmed button to activate the input you want.

If programming is unsuccessful, check the following:

- If the indicator does not light up in step 1, the batteries are weak. Replace both batteries.
- If the indicator flashes 5 times in quick succession while entering the numeric code, an error has occurred. Start again from step 1.

The numeric codes corresponding to the component and the maker of the component

Use the numeric codes in the tables below to control non-Sony components and also Sony components that the remote is normally unable to control. Since the remote signal that a component accepts differs depending on the model and year of the component, more than one numeric code may be assigned to a component. If you fail to program your remote using one of the codes, try using other codes.

Notes

- The numeric codes are based on the latest information available for each brand. There is a chance, however, that your component will not respond to some or all of the codes.
- All of the input buttons on this remote may not be available when used with your particular component.

To control a tuner

Maker	Code(s)
SONY	005

To control a CD player

Maker	Code(s)
SONY	101, 102, 103
DENON	104, 123
JVC	105, 106, 107
KENWOOD	108, 109, 110
MAGNAVOX	111, 116
MARANTZ	116
ONKYO	112, 113, 114
PANASONIC	115
PHILIPS	116
PIONEER	117
TECHNICS	115, 118, 119
YAMAHA	120, 121, 122

To control a DAT deck

Maker	Code(s)
SONY	203
PIONEER	219

To control a tape deck

Maker	Code(s)
SONY	201, 202
DENON	204, 205
KENWOOD	206, 207, 208, 209
NAKAMICHI	210
PANASONIC	216
PHILIPS	211, 212
PIONEER	213, 214
TECHNICS	215, 216
YAMAHA	217, 218

To control an MD deck

Maker	Code(s)
SONY	301
DENON	302
JVC	303
KENWOOD	304

To control an HDD recorder

Maker	Code(s)
SONY	307, 308, 309

To control a Blu-ray disc player/recorder

Maker	Code(s)
SONY	310, 311, 312
PANASONIC	335
SAMSUNG	336
LG	337

To control a PSX

Maker	Code(s)
SONY	313, 314, 315

To control a DVD player

Maker	Code(s)
SONY	401, 402, 403
BROKSONIC	424
DENON	405
HITACHI	416
JVC	415, 423
MITSUBISHI	419
ORITRON	417
PANASONIC	406, 408, 425
PHILIPS	407
PIONEER	409, 410
RCA	414
SAMSUNG	416, 422
TOSHIBA	404, 421
ZENITH	418, 420

To control a DVD recorder

Maker	Code(s)
SONY	401, 402, 403

To control a DVD/VCR COMBO

Maker	Code(s)
SONY	411

To control a DVD/HDD COMBO

Maker	Code(s)
SONY	401, 402, 403

To control a TV

Maker	Code(s)
SONY	501, 502
AIWA	501, 536, 539
AKAI	503
AOC	503
CENTURION	566
CORONADO	517
CURTIS-MATHES	503, 551, 566, 567
DAYTRON	517, 566
DAEWOO	504, 505, 506, 507, 515, 544
FISHER	508, 545
FUNAI	548
FUJITSU	528
GOLDSTAR/LG	503, 512, 515, 517, 534, 544, 556, 568
GRUNDIG	511, 533, 534
HITACHI	503, 513, 514, 515, 517, 519, 544, 557, 571
ITT/NOKIA	521, 522
J.C.PENNY	503, 510, 566
JVC	516, 552
KMC	517
MAGNAVOX	503, 515, 517, 518, 544, 566
MARANTZ	527
MITSUBISHI/MGA	503, 519, 527, 544, 566, 568

Maker	Code(s)
NEC	503, 517, 520, 540, 544, 554, 566
NORDMENDE	530, 558
NOKIA	521, 522, 573, 575
PANASONIC	509, 524, 553, 559, 572
PHILIPS	515, 518, 557, 570, 571
PHILCO	503, 504, 514, 517, 518
PIONEER	509, 525, 526, 540, 551, 555
PORTLAND	503
QUASAR	509, 535
RADIO SHACK	503, 510, 527, 565, 567
RCA/PROSCAN	503, 510, 523, 529, 544
SAMSUNG	503, 515, 517, 531, 532, 534, 544, 556, 557, 562, 563, 566, 569
SAMPO	566
SABA	530, 537, 547, 549, 558
SANYO	508, 545, 546, 560, 567
SCOTT	503, 566
SEARS	503, 508, 510, 517, 518, 551
SHARP	517, 535, 550, 561, 565
SYLVANIA	503, 518, 566
THOMSON	530, 537, 547, 549
TOSHIBA	535, 539, 540, 541, 551
TELEFUNKEN	530, 537, 538, 547, 549, 558
TEKNIKA	517, 518, 567
WARDS	503, 517, 566
YORK	566
ZENITH	542, 543, 567
GE	503, 509, 510, 544
LOEWE	515, 534, 556

To control an LD player

Maker	Code(s)
SONY	601, 602, 603
PIONEER	606

To control a Video CD player

Maker	Code(s)
SONY	605

To control a VCR

Maker	Code(s)
SONY	701, 702, 703, 704, 705, 706
AIWA*	710, 750, 757, 758
AKAI	707, 708, 709, 759
BLAUPUNKT	740
EMERSON	711, 712, 713, 714, 715, 716, 750
FISHER	717, 718, 719, 720
GENERAL ELECTRIC (GE)	721, 722, 730
GOLDSTAR/LG	723, 753
HITACHI	722, 725, 729, 741
ITT/NOKIA	717
JVC	726, 727, 728, 736
MAGNAVOX	730, 731, 738
MITSUBISHI/MGA	732, 733, 734, 735
NEC	736
PANASONIC	729, 730, 737, 738, 739, 740
PHILIPS	729, 730, 731
PIONEER	729
RCA/PROSCAN	722, 729, 730, 731, 741, 747
SAMSUNG	742, 743, 744, 745
SANYO	717, 720, 746
SHARP	748, 749
TOSHIBA	747, 756
ZENITH	754

* If an AIWA VCR does not work even though you enter the code for AIWA, enter the code for Sony instead.

To control a satellite tuner

Maker	Code(s)
SONY	801, 802, 803, 804, 824, 825, 865
AMSTRAD	845, 846
BskyB	862
GENERAL ELECTRIC (GE)	866
GRUNDIG	859, 860
HUMAX	846, 847
THOMSON	857, 861, 864, 876
PACE	848, 849, 850, 852, 862, 863, 864
PANASONIC	818, 855
PHILIPS	856, 857, 858, 859, 860, 864, 874
NOKIA	851, 853, 854, 864
RCA/PROSCAN	866, 871
BITA/HITACHI	868
HUGHES	867
JVC/Echostar/Dish Network	873
MITSUBISHI	872
SAMSUNG	875
TOSHIBA	869, 870

To control a cable box

Maker	Code(s)
SONY	821, 822, 823
HAMLIN/REGAL	836, 837, 838, 839, 840
JERROLD/G.I./MOTOROLA	806, 807, 808, 809, 810, 811, 812, 813, 814, 819
JERROLD	830, 831
OAK	841, 842, 843
PANASONIC	816, 826, 832, 833, 834, 835
PHILIPS	830, 831
PIONEER	828, 829
RCA	805
SCIENTIFIC ATLANTA	815, 816, 817, 844
TOCOM/PHILIPS	830, 831
ZENITH	826, 827

Clearing all the contents of the remote's memory

- 1 While holding down **MASTER VOL – (RM-AAP051 only)** or **◀ – (RM-AAP052 only)**, press and hold **I/⏻**, then press **AV I/⏻**.

The RM SET UP indicator flashes 3 times.

- 2 **Release all buttons.**

All the contents of the remote's memory (i.e., all the programmed data) are cleared.

Glossary

■ Cinema Studio EX

A surround sound mode that can be regarded as the compilation of Digital Cinema Sound technology, delivers the sound of a dubbing theater using three technologies: “Virtual Multi Dimensions”, “Screen Depth Matching”, and “Cinema Studio Reverberation”.

“Virtual Multi Dimensions”, the virtual speaker technology, creates a virtual multi-surround environment with actual speakers up to 7.1 channel, and brings the surround sound experience of a theater with the latest facilities into your home.

“Screen Depth Matching” reproduces treble attenuation, fullness, and depth of sound usually created in a theater using sound emission from behind the screen. This is then added to the front and center channels.

“Cinema Studio Reverberation” reproduces the sound characteristics of state-of-the-art dubbing theaters and recording studios, including Sony Pictures Entertainment’s dubbing studios. There are three modes, A/B/C, available according to the studio type.

■ Component video

A format for transmitting video signal information consisting of three separate signals: luminance Y, chrominance Pb, and chrominance Pr. High quality pictures, such as DVD video or HDTV pictures, are transmitted more faithfully. The three jacks are color-coded green, blue and red.

■ Composite video

A standard format for transmitting video signal information. The luminance signal Y and chrominance signal C are combined and transmitted together.

■ Crossover frequency

The frequency at which two speaker’s frequencies intersect.

■ Deep Color (Deep Colour)

Video signals for which the color depth of signals passing through an HDMI jack have been raised.

The number of colors that could be expressed by 1 pixel was 24 bits (16,777,216 colors) with the current HDMI jack. However, the number of colors which can be expressed by 1 pixel will be 36, etc., bits when the receiver corresponds to Deep Color (Deep Colour). Since the gradation of the depth of a color can be expressed more finely with more bits, continuous color changes can be more smoothly expressed.

■ Digital Cinema Sound (DCS)

Unique sound reproduction technology for home theater developed by Sony, in cooperation with Sony Pictures Entertainment, for enjoying the exciting and powerful sound of movie theaters at home. With this “Digital Cinema Sound” developed by integrating a DSP (Digital Signal Processor) and measured data, the ideal sound field intended by filmmakers can be experienced at home.

■ Dolby Digital

Digital audio encoding/decoding technology developed by Dolby Laboratories, Inc. It consists of front (left/right), center, surround (left/right) and subwoofer channels. It is a designated audio standard for DVD video and also known as 5.1 channel surround. Since surround information is recorded and reproduced in stereo, more realistic sound with fuller presence is delivered than with Dolby surround.

■ Dolby Digital Plus

Dolby Digital Plus provides the flexibility and efficiency to deliver more channels of compelling surround sound for high-definition video media. Its superior coding efficiencies enable up to 7.1 channel of high-quality multi channel audio without negatively impacting bit budgets allocated for video performance or additional feature sets.

■ Dolby Digital Surround EX

Acoustic technology developed by Dolby Laboratories, Inc. Surround back information is matrixed into regular left and right surround channels so that the sound can be reproduced in 6.1 channel. Active scenes, especially, are recreated with a more dynamic and realistic sound field.

■ Dolby Pro Logic II

This technology converts 2 channel stereo recorded audio into 5.1 channel for playback. There is a MOVIE mode for movies and MUSIC mode for stereo sources such as music. Old movies encoded in the traditional stereo format can be enhanced with 5.1 channel surround sound.

■ Dolby Pro Logic IIx

Technology for 7.1 channel (or 6.1 channel) playback. Along with audio encoded in Dolby Digital Surround EX, 5.1 channel Dolby Digital encoded audio can be reproduced in 7.1 channel (or 6.1 channel). Furthermore, existing stereo recorded content can also be reproduced in 7.1 channel (or 6.1 channel).

■ Dolby Pro Logic IIz

Dolby Pro Logic IIz brings a vertical aspect to the sound field through the addition of left and right front high speakers. It decodes nondirectional elements in the audio mix and reproduces them from the high speakers, giving an enhanced sense of depth and airiness to the sound field.

■ Dolby Surround (Dolby Pro Logic)

Audio processing technology developed by Dolby Laboratories, Inc. Center and mono surround information is matrixed into two stereo channels. When reproduced, audio is decoded and output in 4 channels surround sound. This is the most common audio processing method for DVD video.

■ Dolby TrueHD

Dolby TrueHD is Dolby's lossless audio technology developed for high-definition optical discs. Dolby TrueHD audio is bit-for-bit identical to the original studio masters and provides supreme-quality audio up to 8 channel at 96 kHz/24 bit and up to 6 channel at 192 kHz/24 bit. Together with high-definition video, it offers an unprecedented home theater experience.

■ DTS 96/24

A high sound quality digital signal format. It records audio at a sampling frequency and bit rate of 96 kHz/24bit which is the highest possible for DVD video. The number of playback channels varies depending on the software.

■ DTS Digital Surround

Digital audio encoding/decoding technology for theaters developed by DTS, Inc. It compresses audio less than Dolby Digital, delivering a higher quality sound reproduction.

■ DTS-ES

Format for 6.1 channel playback with surround back information. There are two modes, "Discrete 6.1" which records all channels independently, and "Matrix 6.1" which matrixes surround back channel into surround left and surround right channels. It is ideal for playback of motion picture soundtracks.

■ DTS-HD

Audio format which extends the conventional DTS Digital Surround format.

This format consists of a core and an extension, and the core part has DTS Digital Surround compatibility. There are two kinds of DTS-HD, DTS-HD High Resolution Audio and DTS-HD Master Audio. DTS-HD High Resolution Audio has a maximum transmission rate of 6 Mbps, with lossy compression (Lossy), and DTS-HD High Resolution Audio corresponds to a maximum sampling frequency of 96 kHz, and a maximum of 7.1 channel. DTS-HD Master Audio has the maximum transmission rate of 24.5 Mbps, and uses lossless compression (Lossless), and DTS-HD Master Audio corresponds to a maximum sampling frequency of 192 kHz, and a maximum of 7.1 channel.

■ DTS Neo:6

This technology converts 2 channel stereo recorded audio for 7 channel playback. There are two modes to select according to the playback source or your preference, CINEMA for movies, and MUSIC for stereo sources such as music.

■ HDMI (High-Definition Multimedia Interface)

HDMI (High-Definition Multimedia Interface) is an interface that supports both video and audio on a single digital connection, allowing you to enjoy high quality digital picture and sound. The HDMI specification supports HDCP (High-bandwidth Digital Contents Protection), a copy protection technology that incorporates coding technology for digital video signals.

■ High Bitrate Audio

It refers to the audio formats of the compression method (DTS-HD Master Audio, Dolby TrueHD, etc.) which is a high bitrate format recorded mainly on Blu-ray disc etc.

■ Interlace

A scanning method which completes a picture by displaying half of the lines on a tube surface of a TV or monitor each 1/60 second. First, all the odd-numbered lines are drawn, leaving spaces between each line, then all the even-numbered lines are drawn to fill the spaces. “i” of “480i” stands for “Interlace”.

■ LFE (Low Frequency Effects)

Sound effects of low frequencies which are output from a subwoofer in Dolby Digital or DTS, etc. By adding a deep bass with a frequency between 20 to 120 Hz, audio becomes more powerful.

■ PCM (Pulse Code Modulation)

A method of converting analog audio to digital audio for easy enjoyment of digital sound.

■ Progressive

A scanning method that draws all scanning lines sequentially, as opposed to interlaced scanning where all the odd and then all the even lines are drawn.

“p” of “480p” stands for “Progressive”.

■ S-AIR (Sony Audio Interactive Radio frequency)

Recent times have seen the rapid spread of DVD media, Digital Broadcasting, and other high quality media.

To ensure that the subtle nuances of these high quality media are transmitted with no deterioration, Sony has developed a technology called “S-AIR” for the radio transmission of digital audio signals with no compression, and has incorporated this technology into the EZW-RT10/EZW-T100. This technology transfers digital audio signals with no compression using the 2.4 GHz band range of ISM band (Industrial, Scientific, and Medical band), such as wireless LANs and Bluetooth applications.

■ Sampling frequency

To convert analog audio to digital, analog data should be quantified. This process is called sampling, and the number of times per second the analog data is quantified is called the sampling frequency. A standard music CD stores data quantified at 44,100 times per second, which is expressed as a sampling frequency of 44.1 kHz. Generally speaking, a higher sampling frequency means better sound quality.

■ TSP (Time Stretched Pulse)

A TSP signal is a highly precise measuring signal that utilizes impulse energy, measuring a wide band, from low to high, in a short period.

The amount of energy used to measure signals is important to ensure measurement accuracy in a normal indoor environment. Using TSP signals make it possible to measure signals effectively.

■ x.v.Color (x.v.Colour)

x.v.Color (x.v.Colour) enables the more faithful reproduction of various colors such as the brilliant colors of flowers and the turquoise blue of the southern ocean.

Precautions

On safety

Should any solid object or liquid fall into the cabinet, unplug the receiver and have it checked by qualified personnel before operating it any further.

On power sources

- Before operating the receiver, check that the operating voltage is identical with your local power supply.
The operating voltage is indicated on the nameplate on the back of the receiver.
- The unit is not disconnected from the AC power source (mains) as long as it is connected to the wall outlet, even if the unit itself has been turned off.
- If you are not going to use the receiver for a long time, be sure to disconnect the receiver from the wall outlet. To disconnect the AC power cord (mains lead), grasp the plug itself; never pull the cord.
- (Models of area code U2, CA2 only)
One blade of the plug is wider than the other for the purpose of safety and will fit into the wall outlet only one way. If you are unable to insert the plug fully into the outlet, contact your dealer.
- The AC power cord (mains lead) must be changed only at a qualified service shop.

On heat buildup

Although the receiver heats up during operation, this is not a malfunction. If you continuously use this receiver at a large volume, the cabinet temperature of the top, side and bottom rises considerably. To avoid burning yourself, do not touch the cabinet.

On placement

- Place the receiver in a location with adequate ventilation to prevent heat buildup and prolong the life of the receiver.
- Do not place the receiver near heat sources, or in a place subject to direct sunlight, excessive dust, or mechanical shock.
- Do not place anything on top of the cabinet that might block the ventilation holes and cause malfunctions.
- Do not place the receiver near equipment such as a TV, VCR, or tape deck. (If the receiver is being used in combination with a TV, VCR, or tape deck, and is placed too close to that equipment, noise may result, and picture quality may suffer. This is especially likely when using an indoor antenna (aerial). Therefore, we recommend using an outdoor antenna (aerial).)
- Use caution when placing the receiver on surfaces that have been specially treated (with wax, oil, polish, etc.) as staining or discoloration of the surface may result.

On operation

Before connecting other components, be sure to turn off and unplug the receiver.

On cleaning

Clean the cabinet, panel, and controls with a soft cloth slightly moistened with a mild detergent solution. Do not use any type of abrasive pad, scouring powder, or solvent, such as alcohol or benzine.

On S-AIR function

- As the S-AIR product(s) transmits sound by radio waves, sound may skip when radio waves are obstructed. This is a characteristic of radio waves and is not malfunction.
- As the S-AIR product(s) transmits sound by radio waves, equipment that generates electromagnetic energy, such as a microwave oven, may prevent sound transmission.
- As the S-AIR function uses the radio waves that share the same frequency as other wireless systems, such as wireless LAN or Bluetooth devices, interference or poor transmission may result. In this case, take the following steps:
 - Avoid placing the S-AIR product(s) near other wireless systems.
 - Avoid using the S-AIR product(s) and the other wireless systems spontaneously.
 - The transmission may be improved by changing the transmission channel (frequency) of the other wireless system(s). For details, refer to the operating instructions of the other wireless system(s).
- The transmission distance differs depending on the usage environment. Find a location where transmission between the S-AIR main unit and sub unit is most effective, and install the S-AIR main unit and sub unit there.
- Place the S-AIR product(s) on the stable surface off the floor.
- Poor transmission may occur and the transmission distance may be too short if the following conditions exist:
 - There is a wall/floor made of reinforced concrete or stone between the S-AIR product(s).
 - There is an iron divider/door or furniture/ electric product made of fireproof glass, metal, etc., between the S-AIR product(s).

If you have any questions or problems concerning your receiver, please consult your nearest Sony dealer.

Troubleshooting

If you experience any of the following difficulties while using the receiver, use this troubleshooting guide to help you remedy the problem. Should any problem persist, consult your nearest Sony dealer.

Audio

There is no sound, no matter which component is selected, or only a very low-level sound is heard.

- Check that the speakers and components are connected securely.
- Check that all speaker cords are connected correctly.
- Check that both the receiver and all components are turned on.
- Check that MASTER VOLUME control is not set to “VOL MIN”.
- Check that the SPEAKERS is not set to “SPK OFF” (page 37).
- Check that headphones are not connected to the receiver or S-AIR surround amplifier.
- Press MUTING (RM-AAP051 only) or  (RM-AAP052 only) on the remote to cancel the muting function. You can also use MUTING on the receiver.
- Check that you have selected the correct component with the input buttons (page 46).
- The protective device on the receiver has been activated. Turn off the receiver, eliminate the short-circuit problem, and turn on the power again.

There is no sound from a specific component.

- Check that the component is connected correctly to the audio input jacks for that component.
- Check that the cord(s) used for the connection is (are) fully inserted into the jacks on both the receiver and the component.

There is no sound from one of the front speakers.

- Connect a pair of headphones to the PHONES jack to verify that sound is output from the headphones. If only one channel is output from the headphones, the component may not be connected to the receiver correctly. Check that all the cords are fully inserted into the jacks on both the receiver and the component. If both channels are output from the headphones, the front speaker may not be connected to the receiver correctly. Check the connection of the front speaker which is not outputting any sound.
- Make sure you have connected to both the L and R jacks of an analog component, and not only to either the L or R jack. Use an audio cord (not supplied). However, there will be no sound from the center speaker when a sound field (2ch Stereo, etc.) is selected. When the center speaker is not connected, sound is output only from the front left/right speakers.

There is no sound from analog 2 channel sources.

- Check that the selected digital audio input jack is not assigned to other inputs in “Input Assign” in the Input Option menu (page 85).
- Check that the INPUT MODE is not set to “AUTO” (page 84) and the “Input Assign” function is not used to reassign the audio input of another source to the selected input (page 85).
- Check that the INPUT MODE is not set to “AUTO” (page 84) and the DIGITAL connection is not made for the selected input.

There is no sound from digital sources (from COAXIAL or OPTICAL input jack).

- Check that the INPUT MODE is set to “AUTO” (page 84).
- Check that the “Analog Direct” is not being used.
- Check that the selected digital audio input jack is not assigned to other inputs in “Input Assign” in the Input Option menu (page 85).
- Set “ARC” to “ARC OFF” when no sound is output from TV OPTICAL IN jack during TV input (page 100).

The left and right sounds are unbalanced or reversed.

- Check that the speakers and components are connected correctly and securely.
- Adjust the balance parameters using the Speaker Settings menu in GUI menu.

There is severe hum or noise.

- Check that the speakers and components are connected securely.
- Check that the connecting cords are away from a transformer or motor, and at least 10 feet (3 meters) away from a TV set or fluorescent light.
- Move your audio components away from the TV.
- The plugs and jacks are dirty. Wipe them with a cloth slightly moistened with alcohol.

There is no sound, or only a very low-level sound is heard from the center/surround/surround back/front high speakers.

- Select a Cinema Studio EX mode (page 65, 66).
- Adjust the speaker level (page 92).
- Make sure the center/surround speaker (s) is (are) set to either “Small” or “Large”.
- Check that the speaker settings are appropriate using the Auto Calibration menu or “SP Pattern” in the Speaker Settings menu. Then check that sound is output from each speaker correctly, using “Test Tone” in the Speaker Settings menu.

There is no sound from the surround back speakers.

- Some discs have no Dolby Digital Surround EX flag even though the packages have Dolby Digital Surround EX logos.
- Check the “SP Pattern” setting (page 91).

There is no sound from the subwoofer.

- Check that the subwoofer is connected correctly and securely.
- Make sure you have turned on your subwoofer.
- Depending on the selected sound field, no sound output from the subwoofer.
- When all speakers are set to “Large” and “Neo:6 Cinema” or “Neo:6 Music” is selected, there is no sound from the subwoofer.
- Check the “SP Pattern” setting (page 91).

The surround effect cannot be obtained.

- Make sure you have selected the sound field for movie or music (page 65 or 66).
- Sound fields do not function for signals with a sampling frequency of more than 48 kHz.

Dolby Digital or DTS multi channel sound is not reproduced.

- Check that the DVD, etc. you are playing is recorded in Dolby Digital or DTS format.
- When connecting the DVD player, etc., to the digital input jacks of this receiver, make sure the setting for the digital audio output of the connected component is available. For example, when connecting the “PlayStation 3”, set the BD/DVD audio output format to “Bitstream” on the “PlayStation 3”.
- Set “Audio Out” to “AMP” in the HDMI Settings menu.

Recording cannot be carried out.

- Check that the components are connected correctly.
- Select the source component using the input buttons (page 46).

The MULTI CHANNEL DECODING lamp does not light up in blue.

- Check that the playback component is connected to a digital jack and the input is selected properly on this receiver.
- Check whether the input source of the software being played back corresponds to the multi channel format.
- Check whether the setup on the playback component is set to multi channel sound.
- Check to make sure the selected digital audio input jack is not assigned to other inputs in “Input Assign” in the Input Option menu (page 85).

There is no sound from the component connected to the DIGITAL MEDIA PORT adapter.

- Adjust the volume of this receiver.
- The DIGITAL MEDIA PORT adapter and/or component is not connected correctly. Turn off the receiver, then reconnect the DIGITAL MEDIA PORT adapter and/or component.
- Check the DIGITAL MEDIA PORT adapter and/or component device to make sure it supports this receiver.

Video

There is no picture or an unclear picture appears on the TV screen.

- Select the appropriate input using the input buttons.
- Set your TV to the appropriate input mode.
- Move your audio components away from the TV.
- Assign the component video input correctly.
- The input signal should be same as the input function when you are up-converting an input signal with this receiver (page 34).
- Depending on the DIGITAL MEDIA PORT adapter, video output may not be possible.

Recording cannot be carried out.

- Check that the components are connected correctly.
- Select the source component using the input buttons (page 46).

The GUI menu does not appear on the TV screen.

- Press GUI MODE repeatedly to select “MENU ON”. If the GUI menu still does not appear on the TV screen, press MENU.
 - Check that the TV is connected correctly.
-

HDMI

The source sound input from the HDMI jack on the receiver is not output from the speakers connected to the receiver or TV speaker.

- Check the setting of “Audio Out” in the HDMI Settings menu (page 98).
- Check that the component is connected correctly to the HDMI jack for that component.
- You cannot listen to the Super Audio CD by connecting HDMI.
- Depending on the playback component, you may need to set up the component. Refer to the operating instructions supplied with each component.
- Be sure to use a High Speed HDMI cable when you view images or listen to sound during Deep Color (Deep Colour) or 3D transmission.

The source image input to the HDMI jack on the receiver is not output from the TV.

- Make sure that cables are correctly and securely connected to components.
- Depending on the playback component, you may need to set up the component. Refer to the operating instructions supplied with each component.
- Be sure to use a High Speed HDMI cable when you view images or listen to sound during Deep Color (Deep Colour) or 3D transmission.

The Control for HDMI function does not work.

- Check the HDMI connection (page 27).
- Make sure “Ctrl for HDMI” is set to “ON” in HDMI Settings menu.
- Make sure the connected component is compatible with the Control for HDMI function.
- Check the Control for HDMI settings on the connected component. Refer to the operating instructions of the connected component.
- Repeat the procedures of “Preparing for the “BRAVIA” Sync” if you change the HDMI connection, connect/disconnect the AC power cord (mains lead), or when there is a power failure (page 70).

No sound is output from the receiver and TV speaker while using the System Audio Control function.

- Make sure the TV is compatible with the System Audio Control function.
- If the TV does not have System Audio Control function, set the “Audio Out” settings in HDMI Settings menu to
 - “TV+AMP” if you want to listen to the sound from the TV speaker and receiver.
 - “AMP” if you want to listen to the sound from the receiver.
- When you connect the receiver to a video component (projector, etc.), sound may not be output from the receiver. In this case, select “AMP”.
- If you cannot listen to the sound of a component connected to the receiver while TV input is selected on the receiver
 - Change the input of the receiver to HDMI when you want to watch a program on a component connected via HDMI connection to the receiver.
 - Change the TV channel when you want to watch a TV broadcast.
 - Select the component or input you want to watch when you watch a program on the component connected to the TV. Refer to the operating instructions of the TV on this operation.

continued

The TV's remote cannot be used to control the connected component when using the Control for HDMI function.

- Depending on the connected component and TV, you may need to set up the component and TV. Refer to the operating instructions supplied with each component and TV.
- Change the input of the receiver to the HDMI input connected to the component.

When the receiver is in standby mode, there is no image or sound output from the TV.

- When the receiver is in standby mode, image and sound are output from the HDMI component selected the last time you turned off the receiver. If you are enjoying other component, play the component and perform the One-Touch Play operation, or turn on the receiver to select the HDMI component you want to enjoy.
 - Make sure "Pass Through" is set to "ON" in the HDMI Settings menu if you connect components not compatible with the "BRAVIA" Sync to the receiver (page 98).
-

S-AIR function

S-AIR connection is not established (sound transmission is not established), e.g., the indicator of the S-AIR sub unit turns off, flashes, or turns red.

- If you use another S-AIR main unit, place it more than 26 feet (8 meters) away from this S-AIR main unit.
- Confirm the S-AIR IDs of the S-AIR main unit and S-AIR sub unit are the same (page 77).
- Another S-AIR sub unit is paired to the S-AIR main unit. Pair the desired S-AIR sub unit with the S-AIR main unit (page 78).
- Place the S-AIR main unit and S-AIR sub unit separately from other wireless devices.
- Avoid using any other wireless devices.
- The S-AIR sub unit is turned off. Make sure the AC power cord (mains lead) is connected and turn on the S-AIR sub unit.

No sound is heard from the S-AIR receiver.

- Check that the components are connected to the receiver.

No sound is heard from the S-AIR product.

- If you use another S-AIR main unit, place it more than 26 feet (8 meters) away from this S-AIR main unit.
- Confirm the ID of the S-AIR main unit and S-AIR sub unit are the same (page 77).
- Confirm the pairing setting (page 78).
- Place the S-AIR main unit and S-AIR sub unit closer to each other.
- Avoid using the equipment that generates electromagnetic energy, such as a microwave oven.
- Place the S-AIR main unit and S-AIR sub unit separately from other wireless devices.
- Avoid using any other wireless devices.
- Change the “RF Change” setting (page 81).
- Change the ID settings of the S-AIR main unit and S-AIR sub unit.
- Turn off the system and S-AIR sub unit, then turn them on again.
- Check that headphones are not connected to the S-AIR sub unit.

There is noise or the sound skips.

- If you use another S-AIR main unit, place it more than 26 feet (8 meters) away from this S-AIR main unit.
- Sources with copyright protection may not be playable on S-AIR sub unit.
- Place the S-AIR main unit and S-AIR sub unit closer to each other.
- Avoid using the equipment that generates electromagnetic energy, such as a microwave oven.
- Place the S-AIR main unit and S-AIR sub unit separately from other wireless devices.
- Avoid using any other wireless devices.
- Change the “RF Change” setting (page 81).
- Change the ID settings of the S-AIR main unit and S-AIR sub unit.

“HP NO LINK” and “VOL MIN” appear alternately on the display and the volume of the receiver becomes minimum.

- Volume becomes minimum when you turn off the surround amplifier with headphones connected or if the radio reception is poor. In these cases, check the radio reception and adjust the volume level to restore sound from the headphones.

Tuner

The FM reception is poor.

- Use a 75-ohm coaxial cable (not supplied) to connect the receiver to an outdoor FM antenna (aerial) as shown below. If you connect the receiver to an outdoor antenna (aerial), ground it against lightning. To prevent a gas explosion, do not connect the ground (earth) wire to a gas pipe.

Outdoor FM antenna (aerial)

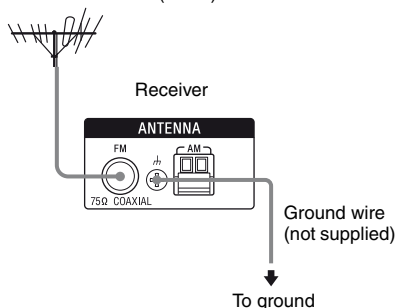

Radio stations cannot be tuned in.

- Check that the antennas (aerials) are connected securely. Adjust the antennas (aerials) and connect an external antenna (aerial), if necessary.
- (Models of area code U2, CA2 only) Keep the satellite radio antenna, away from the speaker cords and the power cord to avoid picking up noise.
- The signal strength of the stations is too weak (when tuning in with automatic tuning). Use direct tuning.
- Make sure you set the tuning interval correctly (when tuning in AM stations with direct tuning).
- No stations have been preset or the preset stations have been cleared (when tuning by scanning preset stations). Preset the stations (page 55).
- Press AMP, then press DISPLAY repeatedly on the remote so that the frequency appears on the display.

The receiver cannot receive satellite channels at all.^{a)}

- The receiving condition is not good. Move the antenna to the place where the condition is good.
- Check that you subscribed to the satellite radio service you want (page 57).

RDS does not work.^{b)}

- Make sure that you are tuned to an FM RDS station.
- Select a stronger FM station.

The RDS information that you want does not appear.^{b)}

- Contact the radio station and find out whether they actually provide the service in question. If so, the service may be temporarily out of order.

^{a)}Models of area code U2, CA2 only.

^{b)}Models of area code CEK, ECE, AU1, TW2 only.

Remote commander

The remote does not function.

- Point the remote at the remote sensor on the receiver.
- Remove any obstacles in the path between the remote and the receiver.
- Replace all the batteries in the remote with new ones, if they are weak.
- Make sure you select the correct input on the remote.
- When you operate a programmed non-Sony component, the remote may not function properly depending on the model and the maker of the component.

Others

The receiver is turned off automatically.

- The “Auto Standby” function is working (page 100).

Error messages

If there is a malfunction, the display shows a message. You can check the condition of the system by the message. See the following table to solve the problem. If any problem persists, consult your nearest Sony dealer.

PROTECTOR

Irregular current is output to the speakers, or upper panel of the receiver is covered with something. The receiver will automatically turn off after a few seconds. Check the speaker connection and turn on the power again.

For other messages, see “Message list after Auto Calibration measurement” (page 43), “DIGITAL MEDIA PORT message list” (page 51) and “SIRIUS Satellite Radio message list” (page 64).

If you are unable to remedy the problem using the troubleshooting guide

Clearing the receiver’s memory may remedy the problem (page 37). However, note that all memorized settings will be reset to their initial settings and you will have to readjust all settings on the receiver.

If the problem persist

Consult your nearest Sony dealer. Note that if service personnel changes some parts during repair, these parts may be retained. In the event of a problem with S-AIR function, have a Sony dealer check the entire system together (S-AIR main unit and S-AIR sub unit).

Reference sections for clearing the receiver’s memory

To clear	See
All memorized settings	page 37
Customized sound fields	page 69

Specifications

AUDIO POWER SPECIFICATIONS

POWER OUTPUT AND TOTAL HARMONIC DISTORTION: (Models of area code U2 only)

With 8 ohm loads, both channels driven, from 20 Hz – 20,000 Hz; rated 100 watts per channel minimum RMS power, with no more than 0.09% total harmonic distortion from 250 milliwatts to rated output.

Amplifier section

Models of area code U2¹⁾

Minimum RMS Output Power
(8 ohms, 20 Hz – 20 kHz, THD 0.09%)
100 W + 100 W

Stereo Mode Output Power
(8 ohms, 1 kHz, THD 1%)
110 W + 110 W

Surround Mode Output Power²⁾
(8 ohms, 1 kHz, THD 10%)
150 W per channel

Models of area code CA2¹⁾

Minimum RMS Output Power
(8 ohms, 20 Hz – 20 kHz, THD 0.09%)
95 W + 95 W

Stereo Mode Output Power
(8 ohms, 1 kHz, THD 1%)
110 W + 110 W

Surround Mode Output Power²⁾
(8 ohms, 1 kHz, THD 10%)
150 W per channel

Models of area code CEK, ECE, AU1, TW2¹⁾

Stereo Mode Output Power
(8 ohms, 1 kHz, THD 1%)
100 W + 100 W

Surround Mode Output Power²⁾
(8 ohms, 1 kHz, THD 10%)
140 W per channel

¹⁾Measured under the following conditions:

Area code	Power requirements
U2, CA2	120 V AC, 60 Hz
CEK, ECE, AU1	230 V AC, 50 Hz
TW2	110 V AC, 60 Hz

²⁾Reference power output for front, center, surround, surround back and front high speakers. Depending on the sound field settings and the source, there may be no sound output.

Frequency response

Analog 10 Hz – 70 kHz,
+0.5 dB/–2 dB (with sound field and equalizer bypassed)

Input

Analog Sensitivity: 500 mV/
50 kohms
S/N³⁾: 96 dB
(A, 500 mV⁴⁾)

Digital (Coaxial) Impedance: 75 ohms
S/N: 100 dB
(A, 20 kHz LPF)

Digital (Optical) S/N: 100 dB
(A, 20 kHz LPF)

Output (Analog)

AUDIO OUT Voltage: 500 mV/10 kohms
SUBWOOFER Voltage: 2 V/1 kohm

Equalizer

Gain levels ±10 dB, 1 dB step

³⁾INPUT SHORT (with sound field and equalizer bypassed).

⁴⁾Weighted network, input level.

FM tuner section

Tuning range 87.5 MHz – 108.0 MHz

Antenna (aerial) FM wire antenna (aerial)

Antenna (aerial) terminals
75 ohms, unbalanced

Intermediate frequency

10.7 MHz

AM tuner section

Tuning range

Area code	Tuning scale	
	10 kHz step	9 kHz step
U2, CA2	530 kHz – 1,710 kHz	531 kHz – 1,710 kHz
CEK, ECE, AU1, TW2	–	531 kHz – 1,602 kHz

Antenna (aerial) Loop antenna (aerial)

Intermediate frequency
450 kHz

Video section

Inputs/Outputs

Video: 1 Vp-p, 75 ohms

COMPONENT VIDEO:

Y: 1 Vp-p, 75 ohms

PB/CB: 0.7 Vp-p, 75 ohms

PR/CR: 0.7 Vp-p, 75 ohms

80 MHz HD Pass Through

HDMI Video

Input/Output (HDMI Repeater block)

640 × 480p@60 Hz

720 × 480p@59.94/60 Hz

1280 × 720p@59.94/60 Hz

1920 × 1080i@59.94/60 Hz

1920 × 1080p@59.94/60 Hz

720 × 576p@50 Hz

1280 × 720p@50 Hz

1920 × 1080i@50 Hz

1920 × 1080p@50 Hz

1920 × 1080p@24 Hz

HDMI Video (3D)

Input/Output (HDMI Repeater block)

1280 × 720p@59.94/60 Hz Frame packing

1920 × 1080i@59.94/60 Hz Frame packing

1920 × 1080i@59.94/60 Hz Side-by-Side (Half)

1920 × 1080p@59.94/60 Hz Side-by-Side (Half)

1280 × 720p@50 Hz Frame packing

1920 × 1080i@50 Hz Frame packing

1920 × 1080i@50 Hz Side-by-Side (Half)

1920 × 1080p@50 Hz Side-by-Side (Half)

1920 × 1080p@24 Hz Frame packing

General

Power requirements

Area code	Power requirements
U2, CA2	120 V AC, 60 Hz
ECE, CEK	230 V AC, 50/60 Hz
AU1	230 V AC, 50 Hz
TW2	110 V AC, 60 Hz

Power output (DIGITAL MEDIA PORT)

DC OUT: 5V, 0.7A MAX

Power consumption

Area code	Power consumption
U2, CA2, CEK, ECE, AU1, TW2	250 W

Power consumption (during standby mode)

0.9 W (When “Ctrl for HDMI” and “S-AIR Stby” are set to “OFF”)

Dimensions (width/height/depth) (Approx.)

17 in × 6 1/4 in × 12 7/8 in
(430 mm × 157.5 mm ×
324.5 mm) including
projecting parts and
controls

Mass (Approx.) 18 lb 16 oz (8.6 kg)

For details on the area code of the component you are using, see page 4.

Design and specifications are subject to change without notice.

Halogenated flame retardants are not used in the certain printed wiring boards.

Index

Numerics

- 2 channel 65
- 5.1 channel 19
- 7.1 channel 19

A

- A.F.D. mode 65
- A/V Sync 96, 105
- AM 53, 109
- Analog Direct 65
- Antenna Aiming 59, 104, 110
- Audio Return Channel 74
- Audio settings 96, 105
- Auto Calibration settings 90, 102
- Auto Tuning 54

B

- BI-AMP 91
- Bi-amplifier connection 88
- Blu-ray disc player 28, 30
- BRAVIA Sync
 - preparing 70

C

- Cable TV tuner 32
- Calibration Type 90, 102
- Camcorder 33
- Category Mode 59, 110
- CD player 24
- Changing the display 47
- Clear
 - memory 37
 - remote 116
 - sound field 69
- Connection
 - antennas 35
 - audio components 24
 - speakers 21
 - TV 23
 - video components 26
- Control for HDMI 98
- Crossover frequency 93, 103

D

- DCAC (Digital Cinema Auto Calibration) 38
- Decode Priority 97, 105
- DIGITAL MEDIA PORT 48
- DIMMER 111
- Direct Tuning 54, 60, 109, 110
- Display 11
- Distance Unit 95, 103
- Dolby Digital EX 68
- Dual Mono 96, 105
- DVD player 28, 31
- DVD recorder 33
- Dynamic range compression 94, 102

E

- Effect level 95
- EQ settings 96, 104
- Error messages 128

F

- FM 53, 109
- FM Mode 54, 104

G

- GUI (Graphical User Interface) 44

H

- HDMI settings 98, 105
- HDMI Signal Pass Through 98, 105

I

- Input Assign 86
- INPUT MODE 84
- iPod 49

L

- Level settings 102
- LFE (Low Frequency Effect) 12
- Lock Code 62

M

- Menu 89, 102
- Message
 - Auto Calibration 43
- DIGITAL MEDIA PORT 51
- Error 128
- SIRIUS 64
- Movie mode 65
- Music mode 66
- Muting 47

N

- Name Input 47, 56
- NIGHT MODE 69

O

- One-Touch Play 72
- Option menu 45

P

- PAIRING 78
- Parental Lock 62, 104
- Party Mode 80
- Phase Audio 94, 102
- Phase Noise 94, 102
- “PlayStation 3” 28
- Position 90, 102
- Preset channels 61, 110
- Preset Mode 60
- Preset stations 55, 109
- PROTECTOR 128

R

Radio ID 58
RDS 56
Recording 52
Remote 14, 112
Reset 37
Resolution 97, 105

S

S-AIR 75
S-AIR settings 106
Satellite tuner 28, 32
Settings menu 89
SIRIUS Satellite Radio 57,
110
Sleep Timer 52
Sound Field 65, 95
Speaker settings 91, 103
Subwoofer Level 99, 105
Super Audio CD player 24
Surround settings 95, 104
System Audio Control 72
System Power Off 73
System settings 105

T

Test Tone 93, 102
Theater/Theatre Mode Sync
73
Tuner 53
Tuner settings 104
Tuning 54, 55
TV 23, 28

U

Up converting 34

V

VCR 33
Video settings 97, 105



* 4 1 7 4 0 6 8 1 2 * (1)