

# ***Home Theatre System***

---

## Operating Instructions

### Owner's Record

The model and serial numbers are located on the rear of the unit. Record the serial number in the space provided below. Refer to them whenever you call upon your Sony dealer regarding this product.

Model No. \_\_\_\_\_ Serial No. \_\_\_\_\_

***HT-DDW670***

# WARNING

**To reduce the risk of fire or electric shock, do not expose this apparatus to rain or moisture.**

To prevent fire, do not cover the ventilation of the apparatus with newspapers, table-cloths, curtains, etc. And don't place lighted candles on the apparatus.

To prevent fire or shock hazard, do not place objects filled with liquids, such as vases, on the apparatus.

Do not install the appliance in a confined space, such as a bookcase or built-in cabinet.



Don't throw away batteries with general house waste; dispose of them correctly as chemical waste.



**Disposal of Old Electrical & Electronic Equipment (Applicable in the European Union and other European countries with separate collection systems)**

This symbol on the product or on its packaging indicates that this product shall not be treated as household waste. Instead it shall be handed over

to the applicable collection point for the recycling of electrical and electronic equipment. By ensuring this product is disposed of correctly, you will help prevent potential negative consequences for the environment and human health, which could otherwise be caused by inappropriate waste handling of this product. The recycling of materials will help to conserve natural resources. For more detailed information about recycling of this product, please contact your local city office, your household waste disposal service or the shop where you purchased the product.

### For customers in the United States

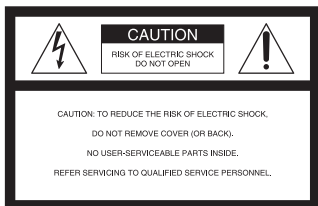

This symbol is intended to alert the user to the presence of uninsulated "dangerous voltage" within the product's enclosure that may be of sufficient magnitude to constitute a risk of electric shock to persons.



This symbol is intended to alert the user to the presence of important operating and maintenance (servicing) instructions in the literature accompanying the appliance.

### WARNING

This equipment has been tested and found to comply with the limits for a Class B digital device, pursuant to Part 15 of the FCC Rules. These limits are designed to provide reasonable protection against harmful interference in a residential installation. This equipment generates, uses, and can radiate radio frequency energy and, if not installed and used in accordance with the instructions, may cause harmful interference to radio communications. However, there is no guarantee that interference will not occur in a particular installation. If this equipment does cause harmful interference to radio or television reception, which can be determined by turning the equipment off and on, the user is encouraged to try to correct the interference by one or more of the following measures:

- Reorient or relocate the receiving antenna.
- Increase the separation between the equipment and receiver.
- Connect the equipment into an outlet on a circuit different from that to which the receiver is connected.
- Consult the dealer or an experienced radio/TV technician for help.

### CAUTION

You are cautioned that any changes or modification not expressly approved in this manual could void your authority to operate this equipment.

### Note to CATV system installer:

This reminder is provided to call CATV system installer's attention to Article 820-40 of the NEC that provides guidelines for proper grounding and, in particular, specifies that the cable ground shall be connected to the grounding system of the building, as close to the point of cable entry as practical.

### For customers in Canada

### CAUTION

TO PREVENT ELECTRIC SHOCK, MATCH WIDE BLADE OF PLUG TO WIDE SLOT, FULLY INSERT.

### For customers in the United States, Canada and Australia



ENERGY STAR® is a U.S. registered mark. As an ENERGY STAR® partner, Sony Corporation has determined that this product meets the ENERGY STAR® guidelines for energy efficiency.

## About This Manual

- The instructions in this manual are for model HT-DDW670. Check your receiver's model number by looking at the lower right corner of the front panel.
- The instructions in this manual describe the controls on the receiver. You can also use the controls on the supplied remote if they have the same or similar names as those on the receiver. For details on the use of your remote, see pages 33–36.

### The HT-DDW670 consists of:

Models of area code CEL, CEK only

- Receiver STR-K670P
- Speaker system
  - Front speaker (left) SS-MSP67LE
  - Front speaker (right) SS-MSP67RE
  - Center speaker SS-CNP87
  - Surround speaker (left) SS-MSP67SLE
  - Surround speaker (right) SS-MSP67SRE
  - Sub woofer SS-WMSP67E

Models of others area code

- Receiver STR-K670P
- Speaker system
  - Front speaker (left) SS-MSP67L
  - Front speaker (right) SS-MSP67R
  - Center speaker SS-CNP67
  - Surround speaker (left) SS-MSP67SL
  - Surround speaker (right) SS-MSP67SR
  - Sub woofer SS-WMSP67

\* Manufactured under license from Dolby Laboratories.

“Dolby”, “Pro Logic” and the double-D symbol are trademarks of Dolby Laboratories.

\*\*“DTS” and “DTS Digital Surround” are registered trademarks of Digital Theater Systems, Inc.

### About area codes

The area code of the receiver you purchased is shown on the lower portion of the rear panel (see the illustration below).

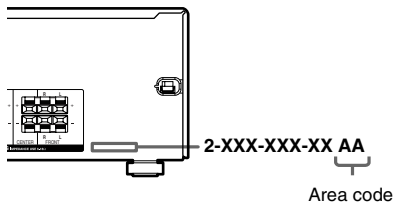

Any differences in operation, according to the area code, are clearly indicated in the text, for example, “Models of area code AA only”.

This receiver incorporates Dolby\* Digital and Pro Logic Surround and the DTS\*\* Digital Surround System.

# Table of Contents

---

## Getting Started

1: Check how to hookup your components .....	5
1a: Connecting components with digital audio output jacks .....	7
1b: Connecting components with only analog audio jacks .....	9
2: Connecting the antennas .....	10
3: Connecting speakers .....	11
4: Connecting the AC power cord .....	14
5: Setting up the speakers .....	15
6: Adjusting the speaker levels and balance .....	17
— TEST TONE	

---

## Amplifier Operation

Selecting the component .....	18
Listening to FM/AM radio .....	19
Storing FM stations automatically .....	20
— AUTOBETICAL (Models of area code CEL, CEK only)	
Presetting radio stations .....	20
Using the Radio Data System (RDS)....	21
(Models of area code CEL, CEK only)	
Changing the display .....	23
About the indications in the display .....	24

---

## Enjoying Surround Sound

Using only the front speakers and sub woofer .....	25
— 2CH STEREO	
Enjoying higher fidelity sound .....	25
— AUTO FORMAT DIRECT	
Selecting a sound field .....	26

---

## Advanced Adjustments and Settings

Switching the audio input mode for digital components .....	28
— INPUT MODE	
Customizing sound fields .....	28
Adjusting the tone .....	30
Advanced settings .....	30

---

## Other Operations

Naming preset stations and inputs .....	32
Using the Sleep Timer .....	32

---

## Operations Using the Remote RM-AAU002

Before you use your remote .....	33
Remote button description .....	33
Changing the factory setting of an input button .....	36

---

## Additional Information

Precautions .....	37
Troubleshooting .....	38
Specifications .....	40
List of button locations and reference pages .....	43
Index .....	Back Cover

# 1: Check how to hookup your components

Steps 1a through 1b beginning on page 7 describe how to hook up your components to this receiver. Before you begin, refer to “Connectable components” below for the pages which describe how to connect each component.

After hooking up all your components, proceed to “2: Connecting the antennas” (page 10).

---

## Connectable components

---

<b>Component to be connected</b>	<b>Page</b>
DVD player	
With digital audio output <sup>a)</sup>	7
With analog audio output only <sup>b)</sup>	9
Satellite tuner	
With analog audio output only <sup>b)</sup>	9
Super Audio CD/CD player	
With digital audio output <sup>a)</sup>	8
With analog audio output only <sup>b)</sup>	9
VCR	9

---

a) Model with a DIGITAL OPTICAL OUTPUT or DIGITAL COAXIAL OUTPUT jack, etc.

b) Model equipped only with AUDIO OUT L/R jacks, etc.

---

## Required cords

The hookup diagrams on the subsequent pages assume the use of the following optional connection cords (**A** to **C**) (not supplied unless indicated).

### **A** Audio cord

White (L)  
Red (R)



### **C** Coaxial digital cord (supplied)

Orange



### **B** Optical digital cord



### Notes

- Turn off the power to all components before making any connections.
- Be sure to make connections firmly to avoid hum and noise.
- When connecting an audio cord, be sure to match the color-coded pins to the appropriate jacks on the components: white (left, audio) to white; and red (right, audio) to red.
- When connecting optical digital cords, insert the cord plugs straight in until they click into place.
- Do not bend or tie optical digital cords.

# 1a: Connecting components with digital audio output jacks

## Hooking up a DVD player

For details on the required cords (**A**–**C**), see page 6.

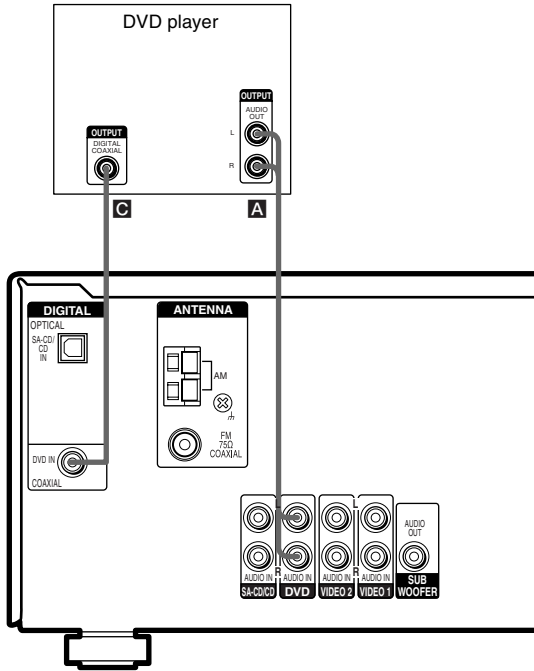

## Hooking up a Super Audio CD/CD player

For details on the required cords (**A**–**C**), see page 6.

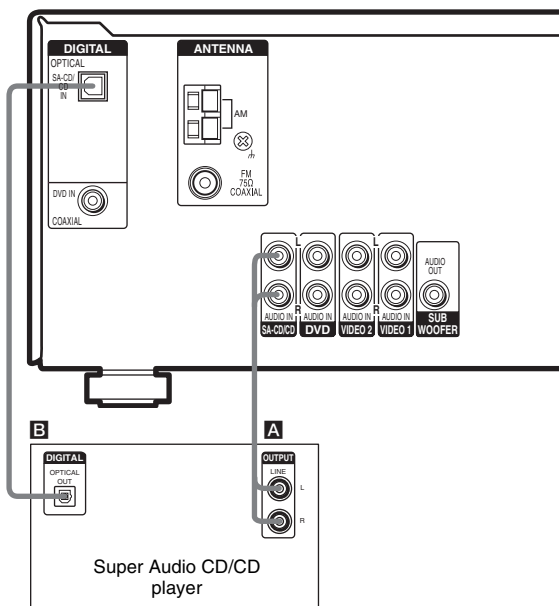

### Tip

All the digital audio jacks are compatible with 32 kHz, 44.1 kHz, 48 kHz and 96 kHz sampling frequencies.

### Note

The sound is not output when you play a Super Audio CD on the Super Audio CD player connected to the SA-CD/CD OPTICAL IN jack on this receiver. Connect to the analog input jacks (SA-CD/CD IN jacks). Refer to the operating instructions supplied with the Super Audio CD player.



# 1b: Connecting components with only analog audio jacks

For details on the required cords (**A-C**), see page 6.

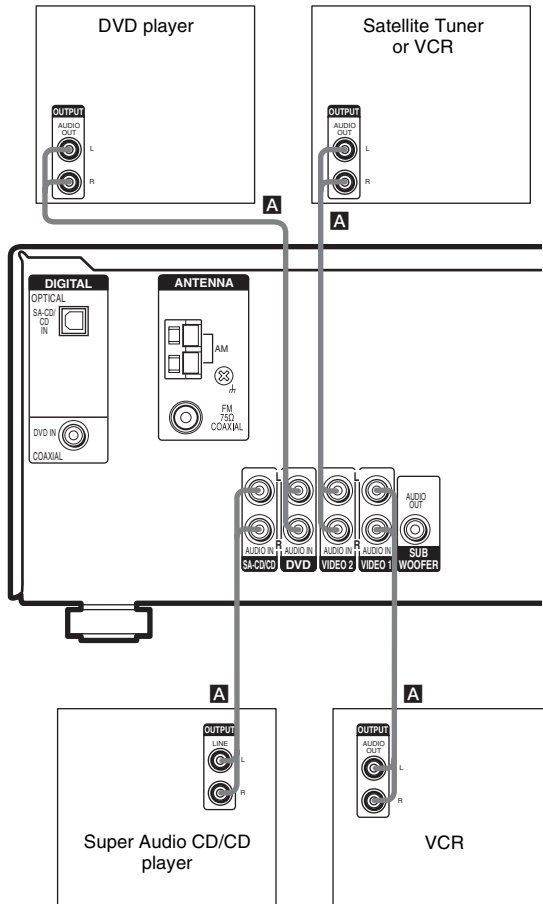

## 2: Connecting the antennas

Connect the supplied AM loop antenna and FM wire antenna.

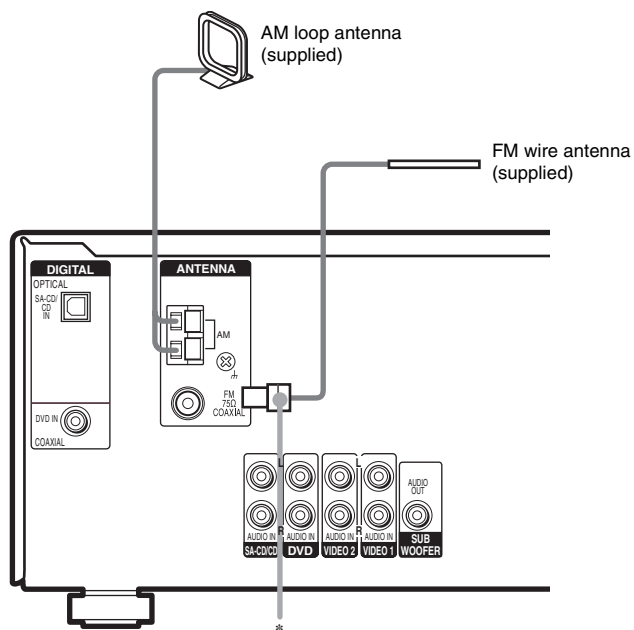

\* The shape of the connector varies depending on the area code.

### Notes

- To prevent noise pickup, keep the AM loop antenna away from the receiver and other components.
- Be sure to fully extend the FM wire antenna.
- After connecting the FM wire antenna, keep it as horizontal as possible.

## 3: Connecting speakers

Connect your speakers to the receiver. This receiver allows you to use a 5.1 channel speaker system. To fully enjoy theater-like multi channel surround sound requires five speakers (two front speakers, a center speaker, and two surround speakers) and a sub woofer (5.1 channel).

### Example of 5.1 channel speaker system configuration

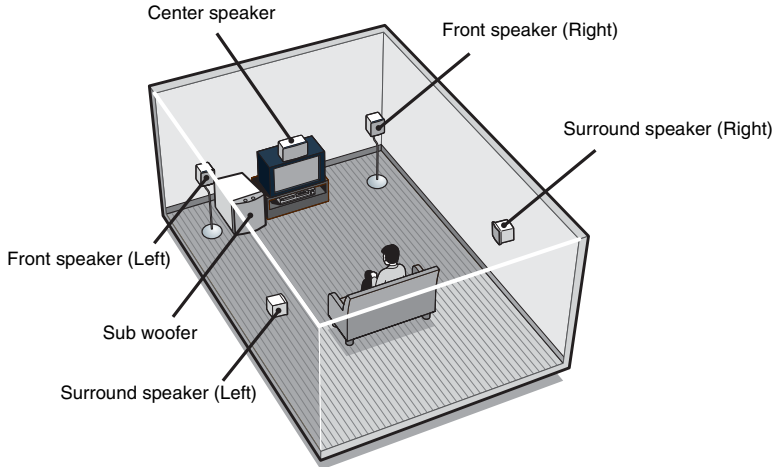

#### Tips

- Since the sub woofer does not emit highly directional signals, you can place it wherever you want.
- For greater flexibility in the positioning of the speakers, use the optional WS-FV11 or WS-FV10D floor stand (available only in certain countries).
- You can also install the front and surround speakers on the wall (page 13).

#### Note

Connect the long speaker connecting cords to the surround speaker terminals and the short speaker connecting cords to the front and center speaker terminals.

### Attaching foot pads

To prevent speaker vibration or movement, attach the supplied foot pads to the speaker as shown in the illustration below.

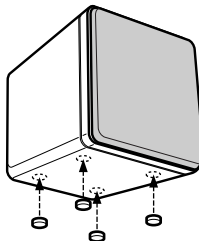

#### Note

Be sure to attach the supplied foot pads to the sub woofer as well.

## Required cords

### A Speaker cords (supplied)

(+)  
(-)



### B Monaural audio cord (not supplied)

Black

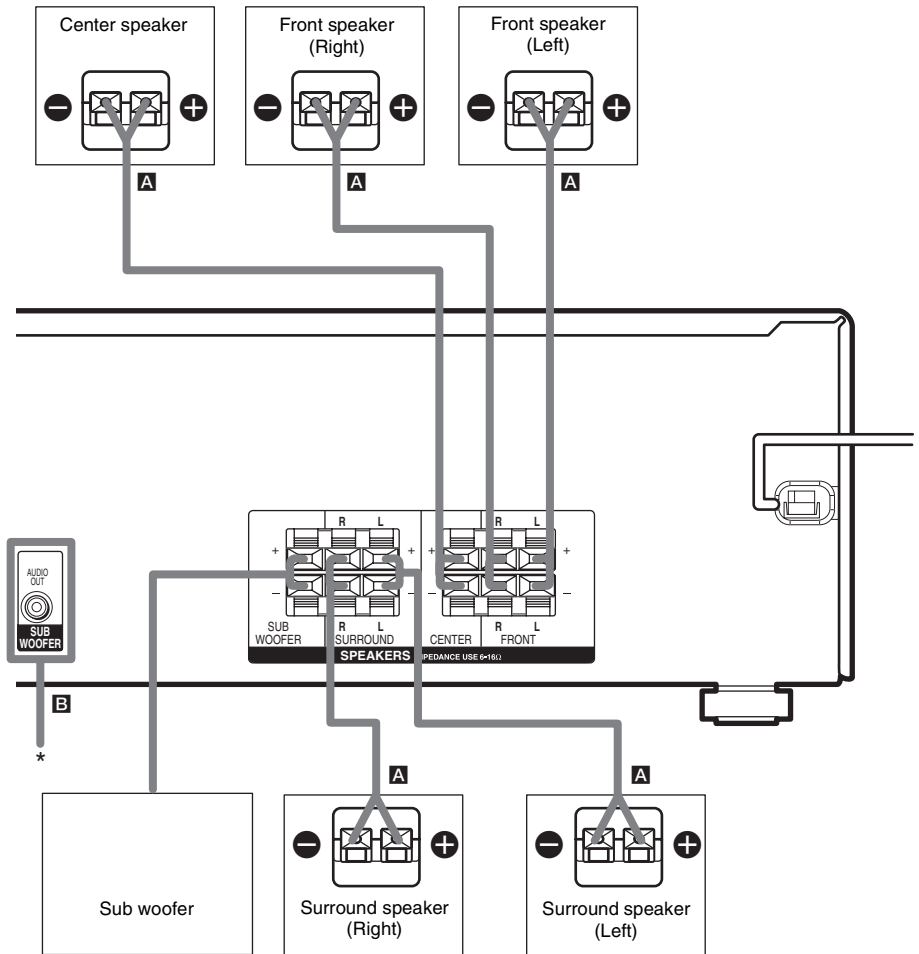

\* If you have an additional active subwoofer, connect it to SUB WOOFER AUDIO OUT jack.

## Installing the speakers on the wall

You can install your front and surround speakers on the wall.

- 1 Prepare screws (not supplied) that are suitable for the hole on the back of each speaker. See the illustrations below.**

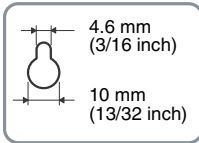
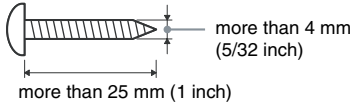

Hole on the back of the speaker

- 2 Fasten the screws to the wall. The screws should protrude 5 to 7 mm (7/32 to 9/32 inch).**

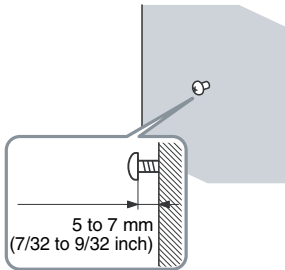

- 3 Hang the speakers on the screws.**

Hole on the back of the speaker

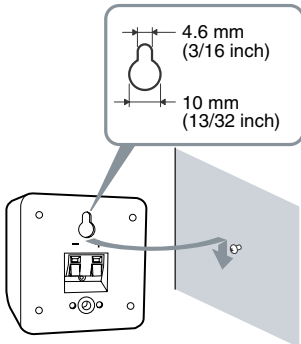

### Notes

- Use screws that are suitable for the wall material and strength. As a plaster board wall is especially fragile, attach the screws securely to a beam and fasten them to the wall. Install the speakers on a vertical and flat wall where reinforcement is applied.
- Contact a screw shop or installer regarding the wall material or screws to be used.
- Sony is not responsible for accident or damage caused by improper installation, insufficient wall strength or improper screw installation, natural calamity, etc.

## 4: Connecting the AC power cord

### Setting the voltage selector

If your receiver has a voltage selector on the rear panel, check that the voltage selector is set to the local power supply voltage. If not, use a screwdriver to set the selector to the correct position before connecting the AC power cord to a wall outlet.

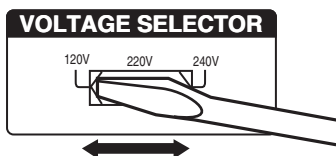

### Connecting the AC power cord

Connect the AC power cord to a wall outlet.

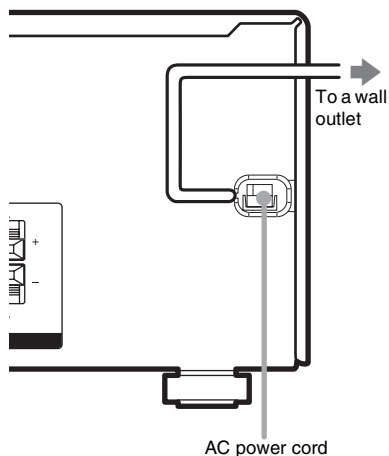

### Performing initial setup operations

Before using the receiver for the first time, initialize the receiver by performing the following procedure.

This procedure can also be used to return settings you have made to their factory defaults. Use the buttons on the receiver for the operation.

**1 Press I/⏻ to turn off the receiver.**

**2 Hold down I/⏻ for 5 seconds.**

"PUSH" and "ENTER" appears in the display alternately.

**3 Press ENTER.**

"CLEARING" appears in the display for a while, then "CLEARED" appears.

The following are reset to their factory settings.

- All settings in the SET UP, LEVEL, TONE and CUSTOMIZE menus.
- The sound field memorized for each input and preset station.
- All sound field parameters.
- All preset stations.
- All index names for inputs and preset stations.
- MASTER VOLUME -/+ is set to "VOL MIN".

## 5: Setting up the speakers

You can use the SET UP menu to set the distance and location of the speakers connected to this receiver.

- 1** Press **I/⏻** to turn on the receiver.
- 2** Press **MAIN MENU** repeatedly to select “<SET UP>”.
- 3** Press **<** or **>** repeatedly to select the parameter you want to adjust.

For details, see “Speaker setup parameters” below.

### Note

Some speaker setup items may appear dimmed in the display. This means that they have been adjusted automatically due to other speaker settings or may not be adjustable.

- 4** Press **+** or **-** repeatedly to select the setting you want.  
The setting is entered automatically.
- 5** Repeat steps 3 and 4 until you have set all of the items that follow.

### Speaker setup parameters

The initial setting is underlined>.

-   DIST. X.X m (XX ft.)\*  
(Front speaker distance)

Initial setting: 3.0 m (10 ft)

Lets you set the distance from your listening position to the front speakers (A). You can adjust from 1.0 meter to 7.0 meters (3 to 23 feet) in 0.1 meter (1 foot) steps.

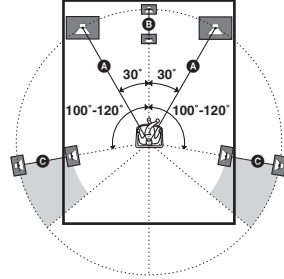

If both front speakers are not placed an equal distance from your listening position, set the distance to the closest speaker.



-  DIST. X.X m (XX ft.)\*  
(Center speaker distance)

Initial setting: 3.0 m (10 ft)

Lets you set the distance from your listening position to the center speaker. Center speaker distance should be set from a distance equal to the front speaker distance (A) to a distance 1.5 meters (5 feet) closer to your listening position (B).

-   DIST. X.X m (XX ft.)\*  
(Surround speaker distance)

Initial setting: 3.0 m (10 ft)

Lets you set the distance from your listening position to the surround speakers. Surround speaker distance should be set from a distance equal to the front speaker distance (A) to a distance 4.5 meters (15 feet) closer to your listening position (C).

If both surround speakers are not placed an equal distance from your listening position, set the distance to the closest speaker.

\* For models of area code U, CA, “XX ft.” is displayed.

**Tip**

The receiver lets you to input the speaker position in terms of distance. However, it is not possible to set the center speaker further than the front speakers. Also, the center speaker cannot be set more than 1.5 meters (5 feet) closer than the front speakers.

Likewise, the surround speakers cannot be set further away from the listening position than the front speakers. And they can be no more than 4.5 meters (15 feet) closer.

This is because incorrect speaker placement is not conducive to the enjoyment of surround sound.

Please note that, setting the speaker distance closer than the actual location of the speakers will cause a delay in the output of the sound from that speaker. In other words, the speaker will sound like it is further away.

For example, setting the center speaker distance 1–2 meters (3–6 feet) closer than the actual speaker position will create a fairly realistic sensation of being “inside” the screen. If you cannot obtain a satisfactory surround effect because the surround speakers are too close, setting the surround speaker distance closer (shorter) than the actual distance will create a larger sound stage. Adjusting these parameter while listening to the sound often results in much better surround sound. Give it a try!

■   XXXX/XX

**(Surround speaker position)**

Lets you specify the location of your surround speakers for proper implementation of the surround effects in the Cinema Studio EX modes (page 26).

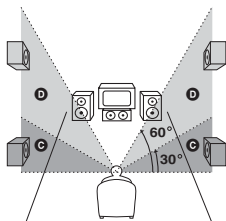
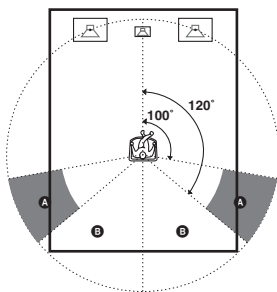

• SIDE/LO

Select if the location of your surround speakers corresponds to section **A** and **C**.

• SIDE/HI

Select if the location of your surround speakers corresponds to section **A** and **D**.

• BEHD/LO

Select if the location of your surround speakers corresponds to section **B** and **C**.

• BEHD/HI

Select if the location of your surround speakers corresponds to section **B** and **D**.

**Tip**

Surround speaker position is designed specifically for implementation of the Cinema Studio EX modes.

For other sound fields, speaker position is not so critical. Those sound fields were designed under the premise that the surround speakers would be located behind the listening position, but presentation remains fairly consistent even with the surround speakers positioned at a rather wide angle. However, if the speakers are pointing toward the listener from the immediate left and right of the listening position, the surround effects becomes unclear unless set to “SIDE/LO” or “SIDE/HI”.

Nevertheless, each listening environment has many variables, such as wall reflections, and you may obtain better results using “BEHD/HI” if your speakers are located high above the listening position, even if they are to the immediate left and right.

Therefore, although it may result in a setting contrary to the above explanation, we recommend that you playback multi channel surround encoded software and select the setting that provides a good sense of spaciousness and that best succeeds in forming a cohesive space between the surround sound from the surround speakers and the sound of the front speakers. If you are not sure which sounds best, select “BEHD/LO” or “BEHD/HI” and then use the speaker distance parameter and speaker level adjustments to obtain proper balance.



## 6: Adjusting the speaker levels and balance

### — TEST TONE

Adjust the speaker levels and balance while listening to the test tone from your listening position. Use the remote for the operation.

#### Tip

The receiver employs a test tone with a frequency centered at 800 Hz.

**1** Press **I/⏻** to turn on the receiver.

**2** Press **TEST TONE**.

“T. TONE” appears in the display and the test tone is output from each speaker in sequence.

Front (left) → Center → Front (right) → Surround (right) → Surround (left) → Sub woofer

**3** **Adjust the speaker levels and balance using the LEVEL menu so that the level of the test tone sounds the same from each speaker.**

For details on the LEVEL menu settings, see page 28.

#### Tips

- To adjust the level of all speakers at the same time, press MASTER VOL +/- on the remote or turn MASTER VOLUME +/- on the receiver.
- The adjusted value are shown in the display during adjustment.

**4** **Press TEST TONE again after adjustment.**

The test tone turns off.

#### Note

Although these adjustments can also be made via the front panel using the LEVEL menu (when the test tone is output, the receiver switches to the LEVEL menu automatically), we recommend you follow the procedure described above and adjust the speaker levels from your listening position using the remote.

## Amplifier Operation

### Selecting the component

#### 1 Press input buttons to select the input.

To select the	Press
VCR	VIDEO 1 or VIDEO 2
Satellite tuner	VIDEO 2
DVD player	DVD
Super Audio CD or CD player	SA-CD/CD
Built-in tuner (FM/AM)	FM or AM

The selected input appears in the display.

#### 2 Turn on the component and start playback.

##### Note

If you select any video components, set the TV's video input to match the component you selected.

#### 3 Turn MASTER VOLUME $-/+$ to adjust the volume.

##### Note

To avoid damaging your speakers, make sure that you turn down the volume before you turn off the receiver.

### To mute the sound

Press MUTING on the remote.

The muting function will be canceled when you do the following.

- Press MUTING on the remote again.
- Turn the power off.
- Increase the volume.

### To use the headphones

Connect the headphones to the PHONES jack.

- When the headphones are connected, speaker output is automatically canceled and "SP" does not light up in the display.
- When the headphones are connected, you can select only the following sound fields (page 27).
  - HP 2CH (HEADPHONE 2CH)
  - HP THEA (HEADPHONE THEATER)

## Listening to FM/AM radio

You can listen to FM and AM broadcasts through the built-in tuner. Before operation, make sure you have connected the FM and AM antennas to the receiver (see page 10).

### Tip

The tuning scale differs depending on the area code as shown in the following table. For details on area codes, see page 3.

Area code	FM	AM
U, CA	100 kHz	10 kHz*
CEL, CEK, SP, AU	50 kHz	9 kHz
MX	50 kHz	10 kHz
E51	50 kHz	10 kHz*

\* The AM tuning scale can be changed (see page 41).

## Automatic tuning

If you do not know the frequency of the station you want, you can let the receiver scan all available stations in your area.

### 1 Press FM or AM to select the FM or AM band.

The last received station is tuned in.

### 2 Press TUNING + or TUNING –.

Press TUNING + to scan from low to high; press TUNING – to scan from high to low.

The receiver stops scanning whenever a station is received.

### Tip

If “STEREO” flashes in the display and the FM stereo reception is poor, press FM MODE to change to monaural (MONO). You will not be able to enjoy the stereo effect, but the sound will be less distorted. To return to stereo mode, press FM MODE again.

## Direct tuning

You can enter the frequency of the station you want directly. Use the remote for the operation.

### 1 Press TUNER repeatedly to select the FM or AM band.

The last received station is tuned in.

### Tip

You can also use FM or AM on the receiver.

### 2 Press D.TUNING.

### 3 Press the numeric buttons to enter the frequency.

Example 1: FM 102.50 MHz

Press 1 → 0 → 2 → 5 → 0

Example 2: AM 1,350 kHz

Press 1 → 3 → 5 → 0

(You do not have to enter the last “0” when the tuning scale is set to 10 kHz.)

If you have tuned in an AM station, adjust the direction of the AM loop antenna for optimum reception.

### If you cannot tune in a station and the entered numbers flash

Make sure you have entered the right frequency. If not, repeat steps 2 and 3. If the entered numbers still flash, the frequency is not used in your area.

## Storing FM stations automatically

### — AUTOBETICAL

#### (Models of area code CEL, CEK only)

This function lets you store up to 30 FM and FM RDS stations in alphabetical order without redundancy. Additionally, it only stores the stations with the clearest signals.

If you want to store FM or AM stations one by one, see “Presetting radio stations” (page 20). Use the buttons on the receiver for the operation.

- 1 Press I/⏻ to turn off the receiver.**
- 2 Hold down MEMORY and press I/⏻ to turn the receiver back on.**

“AUTO-BETICAL SELECT” appears in the display and the receiver scans and stores all the FM and FM RDS stations in the broadcast area.

For RDS stations, the tuner first checks for stations broadcasting the same program, then stores only the one with the clearest signal. The selected RDS stations are sorted alphabetically by their Program Service name, then assigned a 2-character preset code. For more details on RDS, see page 21.

Regular FM stations are assigned 2-character preset codes and stored after the RDS station.

When done, “FINISH” appears in the display momentarily and the receiver returns to the normal operation.

#### Notes

- Do not press any button on the receiver or supplied remote during autobetrical operation, except I/⏻.
- If you move to another area, repeat this procedure to store stations in your new area.
- For details on tuning the stored stations, see “Tuning to preset stations” (page 21).
- If you move the antenna after storing stations with this procedure, the stored settings may no longer be valid. If this happens, repeat this procedure to store the stations again.

## Presetting radio stations

You can preset up to 30 FM or AM stations. Then you can easily tune in the stations you often listen to.

### Presetting radio stations

- 1 Press FM or AM to select the FM or AM band.**

The last received station is tuned in.

- 2 Tune in the station that you want to preset using Automatic Tuning (page 19) or Direct Tuning (page 19).**

- 3 Press MEMORY.**

“MEMORY” appears in the display for a few seconds. Do steps 4 to 5 before the display goes out.

- 4 Press PRESET TUNING + or PRESET TUNING – repeatedly to select a preset station number.**

Each time you press the button, you can select the preset station number as follows:

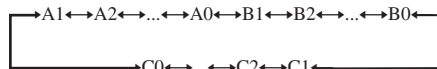

If “MEMORY” goes out before you select the preset station number, start again from step 3.

#### Tip

You can also use the remote to select a preset station number. Press SHIFT repeatedly to select a memory page (A, B or C) and then press the numeric buttons to select a preset number.

- 5 Press MEMORY again.**

The station is stored to the selected preset number.

If “MEMORY” goes out before you press MEMORY, start again from step 3.

- 6 Repeat steps 2 to 5 to preset another station.**

## Tuning to preset stations

- 1 Press FM or AM to select the FM or AM band.

The last received station is tuned in.

- 2 Press PRESET TUNING + or PRESET TUNING – repeatedly to select the preset station you want.

Each time you press the button, you can select the preset station as follows:

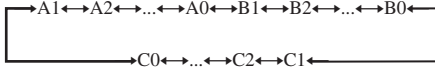

## Using the remote

- 1 Press TUNER repeatedly to select the FM or AM band.
- 2 Press PRESET +/- repeatedly to select the preset station you want.

## To select the preset station directly

Press the numeric buttons on the remote.

The preset station of the selected number in the current memory page is tuned in. Press SHIFT repeatedly on the remote to change the memory page.

## Using the Radio Data System (RDS)

### (Models of area code CEL, CEK only)

This receiver also allows you to use RDS (Radio Data System), which enables radio stations to send additional information along with the regular program signal. You can also display RDS information.

### Notes

- RDS is operable only for FM stations.
- Not all FM stations provide RDS service, nor do they provide the same types of services. If you are not familiar with the RDS services in your area, check with your local radio stations for details.

## Receiving RDS broadcasts

Simply select a station on the FM band using automatic tuning (page 19), direct tuning (page 19), or preset tuning (page 21).

When you tune in a station that provides RDS services, the RDS indicator lights up and the program service name appears in the display.

### Note

RDS may not work properly if the station you tuned to is not transmitting the RDS signal properly or if the signal strength is weak.

## Displaying RDS information

While receiving an RDS station, press DISPLAY repeatedly.

Each time you press the button, RDS information on the display changes cyclically as follows:

Program Service name → Frequency → Program Type indication<sup>a)</sup> → Radio Text indication<sup>b)</sup> → Current Time indication (in 24-hour system) → Sound field currently applied

<sup>a)</sup> Type of program being broadcast (see page 22).

<sup>b)</sup> Text messages sent by the RDS station.

## Notes

- If there is an emergency announcement by government authorities, “ALARM” flashes in the display.
- When the message consists of 9 characters or more, the message scrolls across the display.
- If a station does not provide a particular RDS service, “NO XXXX” (such as “NO TEXT”) appears in the display.

## Description of program types

Program type indication	Description
NEWS	News programs
AFFAIRS	Topical programs that expand on current news
INFO	Programs offering information on a wide spectrum of subjects, including consumer affairs and medical advice
SPORT	Sports programs
EDUCATE	Educational programs, such as “how-to” and advice programs
DRAMA	Radio plays and serials
CULTURE	Programs about national or regional culture, such as language and social concerns
SCIENCE	Programs about the natural sciences and technology
VARIED	Other types of programs such as celebrity interviews, panel games, and comedy
POP M	Popular music programs
ROCK M	Rock music programs
EASY M	Easy Listening
LIGHT M	Instrumental, vocal, and choral music
CLASSICS	Performances of major orchestras, chamber music, opera, etc.
OTHER M	Music that does not fit into any categories above, such as Rhythm & Blues and Reggae
WEATHER	Weather information
FINANCE	Stock market reports and trading, etc.
CHILDREN	Programs for children
SOCIAL	Programs about people and the things that affect them
RELIGION	Programs of religious content

Program type indication	Description
PHONE IN	Programs where members of the public express their views by phone or in a public forum
TRAVEL	Programs about travel. Not for announcements that are located by TP/TA
LEISURE	Programs on recreational activities such as gardening, fishing, cooking, etc.
JAZZ	Jazz programs
COUNTRY	Country music programs
NATION M	Programs featuring the popular music of the country or region
OLDIES	Programs featuring oldies music
FOLK M	Folk music programs
DOCUMENT	Investigative features
NONE	Any programs not defined above

## Changing the display

### Changing the information in the display

You can check the sound field etc. by changing the information in the display.

#### Press **DISPLAY** repeatedly.

Each time you press **DISPLAY**, the display will change cyclically as follows.

Index name of the input\* → Selected input →  
Sound field currently applied

#### When the tuner is selected

Program Service name\*\* or preset station name\*  
→ Frequency → Program Type indication\*\*  
→ Radio Text indication\*\* → Current Time  
indication (in 24-hour system)\*\* → Sound field  
currently applied

\* Index name appears only when you have assigned one to the input or preset station (page 32). Index name does not appear when only blank spaces have been entered, or it is the same as the input name.

\*\* During RDS reception only. (Models of area code CEL, CEK only. See page 21.)

### Adjusting the brightness of the display

#### Press **DIMMER** repeatedly.

The brightness of the display will change in 3 steps.

## About the indications in the display

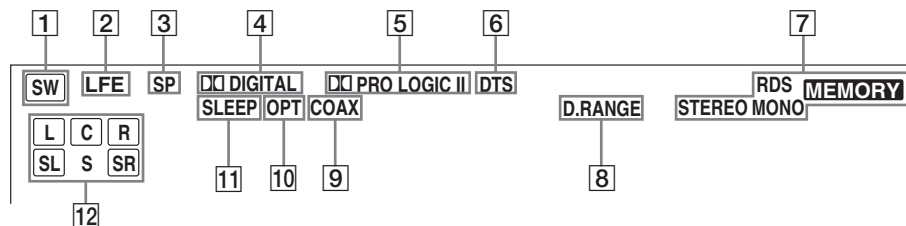

- 1 SW:** Lights up when audio signal is output from the SUB WOOFER jack.
- 2 LFE:** Lights up when the disc being played back contains the LFE (Low Frequency Effect) channel and the LFE channel signal is actually being reproduced.
- 3 SP:** Lights up when you turn on the receiver. Turns off when you connect headphones to the PHONES jack.
- 4  DIGITAL:** Lights up when the receiver is decoding signals recorded in the Dolby Digital format.
- 5  PRO LOGIC II:** “ PRO LOGIC” lights up when the receiver applies Pro Logic processing to 2 channel signals in order to output the center and surround channel signals. “ PRO LOGIC II” lights up when the Pro Logic II Movie/Music decoder is activated.
- 6 DTS:** Lights up when DTS signals are input.
- Note**  
When playing a DTS format disc, be sure that you have made digital connections and that INPUT MODE is not set to “ANALOG” (page 28).
- 7 Tuner indicators:** Lights up when using the receiver to tune in radio stations, etc. See pages 19–22 for tuner operations.
- Note**  
“RDS” appears for models of area code CEL, CEK only.
- 8 D.RANGE:** Lights up when dynamic range compression is activated (page 29).
- 9 COAX:** Lights up when the source signal is a digital signal being input through the COAXIAL terminal.
- 10 OPT:** Lights up when the source signal is a digital signal being input through the OPTICAL terminal.
- 11 SLEEP:** Lights up when sleep timer is activated.
- 12 Playback channel indicators:** The letters (L, C, R, etc.) indicate the channels being played back. The boxes around the letters vary to show how the receiver downmixes the source sound.

L (Front Left), R (Front Right), C (Center (monaural)), SL (Surround Left), SR (Surround Right), S (Surround (monaural or the surround components obtained by Pro Logic processing))

### Example:

Recording format (Front /Surround): 3/2  
Sound Field: A.F.D. AUTO





## Enjoying Surround Sound

### Using only the front speakers and sub woofer

#### — 2CH STEREO

In this mode, the receiver outputs the sound from the front left/right speakers and sub woofer.

When multi channel surround formats are input, the signals are downmixed to 2 channel with bass frequencies being output from the sub woofer.

When standard 2 channel stereo sources are input, the receiver's bass redirection circuitry will be activated. The front channel bass frequencies will be output from the sub woofer.

#### Press 2CH.

"2CH ST." appears in the display and the receiver switches to the 2CH STEREO mode.

## Enjoying higher fidelity sound

#### — AUTO FORMAT DIRECT

The Auto Format Direct (A.F.D.) mode allows you to select the decoding mode you want for your audio sound.

A.F.D. mode (Display)	Decoding mode
A.F.D. AUTO (A.F.D. AUTO)	As encoded
PRO LOGIC (DOLBY PL)	Dolby Pro Logic
PRO LOGIC II MOVIE (PLII MV)	Dolby Pro Logic II
PRO LOGIC II MUSIC (PLII MS)	
MULTI STEREO (MULTI ST.)	

### Decoding the input audio signal automatically

In this mode, the receiver automatically detects the type of audio signal being input (Dolby Digital, DTS, standard 2 channel stereo, etc.) and performs the proper decoding if necessary. This mode presents the sound as it was recorded/encoded, without adding any surround effects. However, if there are no low frequency signals (Dolby Digital LFE, etc.) it will generate a low frequency signal for output to the sub woofer.

#### Press A.F.D. repeatedly to select "A.F.D. AUTO".

The receiver automatically detects the type of audio signal being input and performs the proper decoding if necessary.

## Enjoying stereo sound in multi channel (2 channel decoding mode)

This mode lets you specify the type of decoding for 2 channel audio sources. This receiver can reproduce 2 channel sound in 5 channels through Dolby Pro Logic II; or 4 channels through Dolby Pro Logic.

**Press A.F.D. repeatedly to select the 2 channel decoding mode.**

The selected type of decoding appears in the display.

### ■ DOLBY PL (PRO LOGIC)

Performs Dolby Pro Logic decoding. The source recorded in 2 channel is decoded into 4.1 channels.

### ■ PLII MV (PRO LOGIC II MOVIE)

Performs Dolby Pro Logic II Movie mode decoding. This setting is ideal for movies encoded in Dolby Surround. In addition, this mode can reproduce sound in 5.1 channel when watching videos of overdubbed or old movies.

### ■ PLII MS (PRO LOGIC II MUSIC)

Performs Dolby Pro Logic II Music mode decoding. This setting is ideal for normal stereo sources such as CDs.

### ■ MULTI ST. (MULTI STEREO)

Output the 2 channel L/R signals from all speakers.

## Selecting a sound field

You can take advantage of surround sound simply by selecting one of the receiver's pre-programmed sound fields. They bring the exciting and powerful sound of movie theaters and concert halls into your home.

## Selecting a sound field for movies

**Press MOVIE repeatedly to select the sound field you want.**

The selected sound field appears in the display.

Sound field	Display
CINEMA STUDIO EX A <b>DCS</b>	C.ST.EX A
CINEMA STUDIO EX B <b>DCS</b>	C.ST.EX B
CINEMA STUDIO EX C <b>DCS</b>	C.ST.EX C

## About DCS (Digital Cinema Sound)

Sound fields with **DCS** marks use DCS technology.

DCS is the concept name of the surround technology for home theater developed by Sony. DCS uses the DSP (Digital Signal Processor) technology to reproduce the sound characteristics of an actual cinema cutting studio in Hollywood.

When played at home, DCS will create a powerful theater effect that mimics the artistic combination of sound and action as envisioned by the movie director.

### ■ C.ST.EX A (CINEMA STUDIO EX A) **DCS**

Reproduces the sound characteristics of the Sony Pictures Entertainment "Cary Grant Theater" cinema production studio. This is a standard mode, great for watching most any type of movies.

### ■ C.ST.EX B (CINEMA STUDIO EX B) **DCS**

Reproduces the sound characteristics of the Sony Pictures Entertainment "Kim Novak Theater" cinema production studio. This mode is ideal for watching science-fiction or action movies with lots of sound effects.

■ **C.ST.EX C (CINEMA STUDIO EX C) DCS**

Reproduces the sound characteristics of the Sony Pictures Entertainment scoring stage. This mode is ideal for watching musicals or films where orchestra music is featured in the soundtrack.

**About CINEMA STUDIO EX modes**

CINEMA STUDIO EX modes are suitable for watching motion picture DVDs (etc.), with multi channel surround effects. You can reproduce the sound characteristics of Sony Pictures Entertainment’s dubbing studio in your home.

The CINEMA STUDIO EX modes consist of the following three elements.

- **Virtual Multi Dimension**  
Creates 5 sets of virtual speakers from a single pair of actual surround speakers.
- **Screen Depth Matching**  
Creates the sensation that the sound is coming from inside the screen like in theaters.
- **Cinema Studio Reverberation**  
Reproduces the type of reverberation found in theaters.

The CINEMA STUDIO EX modes integrate these three elements simultaneously.

**Notes**

- The effects provided by the virtual speakers may cause increased noise in the playback signal.
- When listening with sound fields that employ the virtual speakers, you will not be able to hear any sound coming directly from the surround speakers.

**Selecting a sound field for music**

Press **MUSIC** repeatedly to select the sound field you want.

The selected sound field appears in the display.

Sound field	Display
HALL	HALL
JAZZ CLUB	JAZZ
LIVE CONCERT	CONCERT

■ **HALL**

Reproduces the acoustics of a classical concert hall.

■ **JAZZ (JAZZ CLUB)**

Reproduces the acoustics of a jazz club.

■ **CONCERT (LIVE CONCERT)**

Reproduces the acoustics of a 300-seat live house.

**When the headphones are connected**

You can select only from the following sound fields.

■ **HP 2CH (HEADPHONE 2CH)**

Outputs the sound in 2 channel (stereo). Standard 2 channel stereo sources completely bypass the sound field processing and multi channel surround formats are downmixed to 2 channels.

■ **HP THEA (HEADPHONE THEATER) DCS**

Allows you to experience a theater-like environment while listening through a pair of headphones.

**Note**



If you connect a pair of headphones while a sound field is operating, the system will automatically switch to HEADPHONE 2CH if using a sound field selected with the 2CH or A.F.D. button, or to HEADPHONE THEATER if using a sound field selected with the MOVIE or MUSIC button.

**To turn off the surround effect**

Press 2CH to select “2CH ST.” or press A.F.D. repeatedly to select “A.F.D. AUTO”.

**Tips**

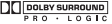
- The receiver lets you apply the last selected sound field to an input whenever it is selected (Sound Field Link). For example, if you select HALL for the SA-CD/CD input, then change to a different input and then return to SA-CD/CD, HALL will automatically be applied again.
- You can identify the encoding format of DVD software, etc. by looking at the logo on the package.

-  : Dolby Digital discs
-  : Dolby Surround encoded programs
-  : DTS Digital Surround encoded programs

**Note**

Sound fields do not function for the signals with a sampling frequency of more than 48 kHz.

# Switching the audio input mode for digital components

### — INPUT MODE

You can switch the audio input mode for components which have digital audio input jacks.

- 1 Press input buttons to select the input.**
- 2 Press INPUT MODE repeatedly to select the audio input mode.**

The selected audio input mode appears in the display.

### Audio input modes

- **AUTO IN**  
Gives priority to digital signals when there are both digital and analog connections. If there are no digital signals, analog is selected.
- **COAX IN**  
Specifies the digital audio signals input to the DIGITAL COAXIAL input jack.
- **OPT IN**  
Specifies the digital audio signals input to the DIGITAL OPTICAL input jacks.
- **ANALOG**  
Specifies the analog audio signals input to the AUDIO IN (L/R) jacks.

### Notes

- When signals with a sampling frequency of more than 48 kHz is input, the tone and sound field cannot be used.
- Some audio input modes may be dimmed depending on the input. This means that the selected input is unavailable.

## Customizing sound fields

By adjusting the LEVEL menu, you can customize the sound fields to suit your particular listening situation.

### Note on the displayed items

The setup items you can adjust in each menu vary depending on the sound field. Certain setup parameters may be dimmed in the display. This means that the selected parameter is either unavailable or fixed and unchangeable.

## Adjusting the LEVEL menu

You can adjust the balance and level of each speaker. These settings are applied to all sound fields except for effect level parameter. The effect level parameter settings are stored individually for each sound field.

- 1 Start playing a source encoded with multi channel surround effects (DVD, etc.).**
- 2 Press MAIN MENU repeatedly to select “<LEVEL>”.**
- 3 Press < or > repeatedly to select the parameter you want to adjust.**  
For details, see “LEVEL menu parameters” below.
- 4 While monitoring the sound, press + or – repeatedly to select the setting you want.**  
The setting is entered automatically.
- 5 Repeat steps 3 and 4 to adjust the other parameters.**

### LEVEL menu parameters

The initial setting is underlined.

-   **BAL. L/R XX**  
(Front speaker balance)

Initial setting: BALANCE (0)

Lets you adjust the balance between front left and right speakers. You can adjust in the range of BAL. L (+1 to +8), BALANCE (0), BAL. R (+1 to +8) in 17 steps.

■ **CTR XXX dB**  
(Center speaker level)

■ **SUR.L. XXX dB**  
(Surround speaker (left) level)

■ **SUR.R. XXX dB**  
(Surround speaker (right) level)

■ **S.W. XXX dB**  
(Sub woofer level)

Initial setting: 0 dB

You can adjust from -10 dB to +10 dB in 1 dB steps.

■ **COMP. XXX**  
(Dynamic range compressor)

Lets you compress the dynamic range of the sound track. This may be useful when you want to watch movies at low volumes late at night.

• OFF

The dynamic range is not compressed.

• STD

The dynamic range is compressed as intended by the recording engineer.

• MAX

The dynamic range is compressed dramatically.

**Tip**

Dynamic range compressor lets you compress the dynamic range of the soundtrack based on the dynamic range information included in the Dolby Digital signal. “STD” is the standard setting, but it only enacts light compression. Therefore, we recommend using the “MAX” setting. This greatly compresses the dynamic range and lets you view movies late at night at low volumes. Unlike analog limiters, the levels are predetermined and provide a very natural compression.

**Note**

Dynamic range compression is possible with Dolby Digital sources only.

■ **EFCT. XXX (Effect level)**

Initial setting: STD

Lets you adjust the “presence” of the surround effect in 3 levels - MIN (minimum effect), STD (standard effect) and MAX (maximum effect).

**Note**

This parameter is valid only when you use a sound field selected with the MOVIE or MUSIC button.

## Resetting sound fields to the initial settings

Use the buttons on the receiver for the operation.

- 1** Press I/⏻ to turn off the power.
- 2** While holding down 2CH, press I/⏻.

“SF. CLR.” appears in the display and all sound fields are reset to the initial setting.

## Adjusting the tone

You can adjust the tonal quality (bass, treble level) of the front speakers using the TONE menu.

- 1 Start playing a source encoded with multi channel surround effects (DVD, etc.).**
- 2 Press MAIN MENU repeatedly to select “<TONE>”.**
- 3 Press < or > repeatedly to select the parameter you want to adjust.**  
For details, see “TONE menu parameters” below.
- 4 While monitoring the sound, press + or – repeatedly to select the setting you want.**  
The setting is entered automatically.
- 5 Repeat steps 3 and 4 to adjust the other items.**

### Note

You cannot adjust the tone when the receiver is decoding signals with a sampling frequency of more than 48 kHz.

## TONE menu parameters

- **BASS XX dB**  
(Front speaker bass level)
- **TREB. XX dB**  
(Front speaker treble level)

Initial setting: 0 dB

You can adjust from –6 dB to +6 dB in 1 dB steps.

## Advanced settings

### Using the CUSTOMIZE menu to adjust the receiver

You can adjust various receiver settings using the CUSTOMIZE menu.

- 1 Press MAIN MENU repeatedly to select “<CUSTOM>”.**
- 2 Press < or > repeatedly to select the parameter you want to adjust.**  
For details, see “CUSTOMIZE menu parameters” below.
- 3 Press + or – repeatedly to select the setting you want.**  
The setting is entered automatically.
- 4 Repeat steps 2 and 3 to adjust the other items.**

### CUSTOMIZE menu parameters

The initial settings are underlined.

#### ■ A.V.SYNC. X (Time alignment)

- Y (Yes) (delay time : 68 ms)  
The audio output is delayed so that the time gap between the audio output and visual display is minimized.
- N (No) (delay time : 0 ms)  
The audio output is not delayed.

#### Notes

- This parameter is useful when you use a large LCD or Plasma monitor or projection TV.
- This parameter is only valid when you use a sound field selected with the 2CH or A.F.D. buttons.
- This parameter is not valid when PCM 96 kHz or DTS 2048 signals are input.

## ■ DEC. XXXX (Digital audio input decoding priority)

Lets you specify the input mode for the digital signal input to the DIGITAL IN jacks.

- **AUTO**  
Automatically switches the input mode between DTS, Dolby Digital, or PCM.
- **PCM**  
PCM signals are given priority (to prevent the interruption when playback starts). Even when other signals are input, the sound is output. However, this receiver cannot decode DTS-CD when set to “DEC. PCM”.

### **Note**

When set to “DEC. AUTO” and the sound from the digital audio jacks (for CD, etc.) is interrupted when playback starts, set to “DEC. PCM”.

## ■ DUAL XXX (Digital broadcast language selection)

Lets you select the language you want to listen to during digital broadcast. This feature only functions for Dolby Digital sources.

- **M/S (Main/Sub)**  
Sound of the main language will be output through the front left speaker and sound of the sub language will be output through the front right speaker simultaneously.
- **M (Main)**  
Sound of the main language will be output.
- **S (Sub)**  
Sound of the sub language will be output.
- **M+S (Main + Sub)**  
Mixed sound of both the main and sub languages will be output.

## ■ NAME IN (Naming preset stations and inputs)

Lets you set the name of preset stations and inputs selected with input buttons. For details, see “Naming preset stations and inputs” on page 32.

# Naming preset stations and inputs

You can enter a name of up to 8 characters for preset stations and inputs selected with input buttons, and display it in the receiver's display.

## 1 To index a preset station

**Press FM or AM to select the FM or AM band, then tune in the preset station you want to create an index name for (page 21).**

### To index an input

**Press the input button to select the input you want to create an index name for.**

**2 Press MAIN MENU repeatedly to select "<CUSTOM>".**

**3 Press < or > repeatedly to select "NAME IN".**

**4 Press ENTER.**

The cursor flashes and you can select a character.

**5 Use < or > and + or – to create an index name.**

Press + or – repeatedly to select a character, then press > to move the cursor to the next position.

### Tips

- You can select the character type as follows by pressing + or – repeatedly.  
Alphabet (upper case) → Numbers → Symbols
- To enter a blank space, press + or – repeatedly until a blank space appears in the display.
- If you made a mistake, press < or > repeatedly until the character you want to change flashes, then press + or – repeatedly to select the correct character.

**6 Press ENTER to store the index name.**

### Note (Models of area code CEL, CEK only)

When you name an RDS station and tune in the station, the Program Service name appears instead of the name you entered. (You cannot change the name of a Program Service name. The name you entered will be overwritten by the Program Service name.)

## Using the Sleep Timer

You can set the receiver to turn off automatically at a specified time. Use the remote for the operation.

### Press SLEEP while the power is on.

Each time you press SLEEP, the display changes cyclically as follows:

2-00-00 → 1-30-00 → 1-00-00 →  
0-30-00 → OFF

While using Sleep Timer, "SLEEP" lights up in the display.

### Tip

To check the remaining time before the receiver turns off, press SLEEP. The remaining time appears in the display. If you press SLEEP again, the sleep timer will be canceled.



## Operations Using the Remote RM-AAU002

You can use the remote RM-AAU002 to operate the components in your system.

### Before you use your remote

#### Inserting batteries into the remote

Insert R6 (size-AA) batteries with the + and – properly oriented in the battery compartment. When using the remote, point it at the remote sensor  on the receiver.

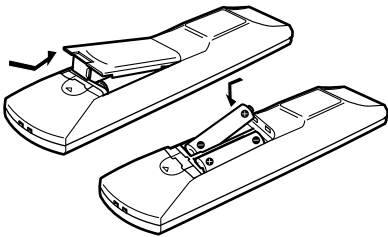

#### Tip

Under normal conditions, the batteries should last for about 6 months. When the remote no longer operates the receiver, replace all batteries with new ones.

#### Notes

- Do not leave the remote in an extremely hot or humid place.
- Do not use a new battery with an old one.
- Do not expose the remote sensor to direct sunlight or lighting apparatuses. Doing so may cause a malfunction.
- If you don't use the remote for an extended period of time, remove the batteries to avoid possible damage from battery leakage and corrosion.

### Remote button description

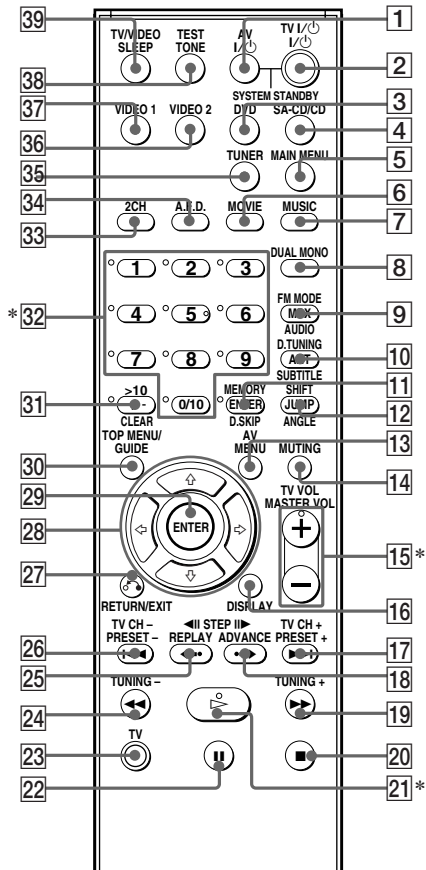

- \* The MASTER VOL +, numeric button 5 and  buttons have a tactile dot. Use the tactile dot as a reference when operating the receiver and other audio/video components.

The tables below show the settings of each button.

Remote Button	Operations	Function
A.F.D. <b>34</b>	Receiver	Selects the decoding mode for audio sound.
ANGLE <b>12</b>	DVD player	Selects viewing angle or changes the angles.
ANT <b>10</b>	VCR/ Satellite tuner	Selects output signal from the antenna terminal: TV signal or VCR program.
AUDIO <b>9</b>	DVD player/ Satellite tuner	Changes the sound to Multiplex or Bilingual or Multi channel TV sound.
AV MENU <b>13</b>	VCR/ DVD player/ Satellite tuner	Displays menu.
AV I/⏻ <b>1</b>	VCR/ CD player/ DVD player/ Satellite tuner/ MD deck	Turns the audio and video components on or off.
CLEAR <b>31</b>	DVD player/ Satellite tuner	Clears a mistake when you press the incorrect numeric buttons or returns to continuous playback etc.
DISPLAY <b>16</b>	Receiver/ CD player/ VCR/ DVD player/ Satellite tuner/ MD deck	Selects information displayed on the TV screen.
D.SKIP <b>11</b>	CD player/ DVD player	Skips discs (multi-disc changer only).
D.TUNING <b>10</b>	Receiver	Enters direct tuning mode.
DUAL MONO <b>8</b>	Receiver	Selects the language you want during digital broadcast.
DVD <b>3</b>	Receiver	To watch DVD.
ENTER <b>11</b>	TV/VCR/ Satellite tuner	After selecting a channel, disc or track using the numeric buttons, press to enter the value.

Remote Button	Operations	Function
ENTER <b>29</b>	Receiver/ VCR/ DVD player/ Satellite tuner/ CD player/ MD deck	Enters the selection.
FM MODE <b>9</b>	Receiver	Selects FM monaural or stereo reception.
JUMP <b>12</b>	Satellite tuner	Toggles between the previous and the current channels.
MAIN MENU <b>5</b>	Receiver	Selects the menu of the receiver.
MASTER VOL +/- <b>15</b>	Receiver/TV	Adjusts the master volume of the receiver.
MEMORY <b>11</b>	Receiver	Stores the radio stations.
MOVIE <b>6</b>	Receiver	Selects the pre-programmed sound fields for movie.
MPX <b>9</b>	VCR	Select main or sub language.
MUSIC <b>7</b>	Receiver	Selects the pre-programmed sound fields for music.
MUTING <b>14</b>	Receiver	Mutes the sound from the receiver.
PRESET +/- <b>17 26</b>	Receiver	Selects preset stations.
	TV/VCR/ Satellite tuner	Select preset channel.
RETURN/ EXIT <b>27</b>	DVD player	Returns to the previous menu or exits the menu.
	Satellite tuner	Exits the menu.
SA-CD/CD <b>4</b>	Receiver	To listen to Super Audio CD or compact disc.
SHIFT <b>12</b>	Receiver	Selects a memory page for presetting radio stations or tuning to preset stations.

Remote Button	Operations	Function
SLEEP <b>39</b>	Receiver	Activates the sleep function and the duration which the receiver turns off automatically.
SUBTITLE <b>10</b>	DVD player	Changes the subtitles.
SYSTEM STANDBY (Press AV I/⏻ <b>1</b> and I/⏻ <b>2</b> at the same time)	Receiver/ TV/VCR/ CD player/ DVD player/ Satellite tuner/ MD deck	Turns off the receiver and other Sony audio/video components.
TEST TONE <b>38</b>	Receiver	Outputs test tone.
TOP MENU/ GUIDE <b>30</b>	DVD player  Satellite tuner	Displays DVD title.  Display guide menu.
TUNER <b>35</b>	Receiver	To listen to radio programs.
TUNING +/- <b>19</b> <b>24</b>	Receiver	Scans radio station.
TV <b>23</b>	TV	To watch TV programs.
TV CH +/- <b>17</b> <b>26</b>	TV	Selects preset TV channels.
TV/VIDEO <b>39</b>	TV	Selects input signal: TV input or video input.
TV VOL +/- <b>15</b>	TV	Adjusts the volume of the TV.
TV I/⏻ <b>2</b>	TV	Turns the TV on or off.
VIDEO 1 <b>37</b>	Receiver	To watch VCR. (VTR mode 3)
VIDEO 2 <b>36</b>	Receiver	To watch VCR. (VTR mode 1)

Remote Button	Operations	Function
1-9 and 0/10 <b>32</b>	Receiver	Use with SHIFT to preset radio station or tuning to preset stations and with D.TUNING for direct tuning.
	CD player/ DVD player/ MD deck	Selects track numbers. 0/10 selects track 10.
	TV/ VCR/ Satellite tuner	Selects channel numbers.
2CH <b>33</b>	Receiver	Selects 2CH STEREO mode.
>10 <b>31</b>	VCR/ CD player/ DVD player/ Satellite tuner/ MD deck	Selects track numbers over 10.
-/-- <b>31</b>	TV	Selects the channel entry mode, either one or two digit.
I/⏻ <b>2</b>	Receiver	Turns the receiver on or off.
◀◀ STEP ▶▶ REPLAY ◀◀/ ADVANCE ▶▶ <b>25</b> <b>18</b>	VCR/ DVD player	Replay the previous scene or fast forward the current scene.
◀◀/▶▶ <b>26</b> <b>17</b>	VCR/ CD player/ DVD player	Skips tracks.
◀◀/▶▶ <b>24</b> <b>19</b>	DVD player	Searches tracks in the forward or backward direction.
	VCR/ CD player/ MD deck/ Tape deck	Fastforwards or rewinds.
▷ <b>21</b>	VCR/ CD player/ DVD player/ MD deck/ Tape deck	Starts playback.

Remote Button	Operations	Function
II [22]	VCR/ CD player/ DVD player/ MD deck/ Tape deck	Pauses playback or recording. (Also starts recording with components in recording standby.)
■ [20]	VCR/ CD player/ DVD player/ MD deck/ Tape deck	Stops playback.
♂↶ [27]	DVD player	Returns to the previous menu or exits the menu.
↑/↓ [28]	Receiver	Selects a menu item.
←/→ [28]	Receiver	Adjusts or changes the setting.
↑/↓/←/→ [28]	VCR/ Satellite tuner/ DVD player	Selects a menu item.

### Notes

- Some functions explained in this section may not work depending on the model.
- The above explanation is intended to serve as an example only. Therefore, depending on the component the above operation may not be possible or may operate differently than described.
- When you press input buttons (VIDEO 1, VIDEO 2 or DVD), the input mode of the TV might not switch to the corresponding input mode that you want. In this case, press TV/VIDEO button to switch the input mode of the TV.
- To activate the buttons with orange printing, press TV and the button you want simultaneously.

## Changing the factory setting of an input button

If the factory settings of the input buttons do not match your system components, you can change them. For example, if you have a CD player and you do not have a DVD player, you can assign the DVD button to your CD player.

**1 Hold down the input button whose input you want to change (for example, DVD).**

**2 Press the corresponding button of the component you want to assign to the input button (for example, 5 – CD player).**

The following buttons are assigned to select the input:

To operate	Press
VCR (command mode VTR 3*)	1
VCR (command mode VTR 2*)	2
DVD player or DVD recorder (command mode DVD 1)	3
DVD recorder (command mode DVD 3)	4
CD player	5
MD deck	6
Tape deck B	7
Tuner (this receiver)	8
DSS (Digital Satellite Receiver)	9
DCS (Digital CS Tuner)	0/10
BSD (Digital BS Tuner)	-/-

\*Sony VCRs are operated with a VTR 2 or 3 setting. These correspond to 8 mm and VHS respectively.

Now you can use the DVD button to control the CD player.

### To reset a button to its factory setting

Repeat the above procedure.

### To reset all the input buttons to their factory setting

Press I/⏪, TEST TONE and MASTER VOL – at the same time.

## Additional Information

### Precautions

#### On safety

Should any solid object or liquid fall into the cabinet, unplug the receiver and have it checked by qualified personnel before operating it any further.

#### On power sources

- Before operating the receiver, check that the operating voltage is identical with your local power supply. The operating voltage is indicated on the nameplate at the rear of the receiver.
- The receiver is not disconnected from the AC power source (mains) as long as it is connected to the wall outlet, even if the receiver itself has been turned off.
- If you are not going to use the receiver for a long time, be sure to disconnect the receiver from the wall outlet. To disconnect the AC power cord, grasp the plug itself; never pull the cord.
- (Models of area code U, CA only)  
One blade of the plug is wider than the other for the purpose of safety and will fit into the wall outlet only one way. If you are unable to insert the plug fully into the outlet, contact your dealer.
- AC power cord must be changed only at the qualified service shop.

#### On heat buildup

Although the receiver heats up during operation, this is not a malfunction. If you continuously use this receiver at a large volume, the cabinet temperature of the top, side and bottom rises considerably. To avoid burning yourself, do not touch the cabinet.

#### On placement

- Place the receiver in a location with adequate ventilation to prevent heat buildup and prolong the life of the receiver.
- Do not place the receiver near heat sources, or in a place subject to direct sunlight, excessive dust or mechanical shock.
- Do not place anything on top of the cabinet that might block the ventilation holes and cause malfunctions.
- Use caution when placing the receiver or speakers on surfaces that have been specially treated (with wax, oil, polish, etc.) as staining or discoloration of the surface may result.

#### On operation

Before connecting other components, be sure to turn off and unplug the receiver.

#### If you encounter color irregularity on a nearby TV screen

The front and center speakers and the sub woofer are magnetically shielded to allow it to be installed near a TV set. However, color irregularities may still be observed on certain types of TV sets. As the surround speakers are not magnetically shielded, we recommend that you place the surround speakers slightly further away from TV set (page 11).

#### If color irregularity is observed...

Turn off the TV set once, then turn it on again after 15 to 30 minutes.

#### If color irregularity is observed again...

Place the speaker further away from the TV set.

#### If howling occurs

Reposition the speakers or turn down the volume on the receiver.

#### On cleaning

Clean the cabinet, panel and controls with a soft cloth slightly moistened with a mild detergent solution. Do not use any type of abrasive pad, scouring powder or solvent such as alcohol or benzene.

If you have any question or problem concerning your receiver, please consult your nearest Sony dealer.

## Troubleshooting

If you experience any of the following difficulties while using the receiver, use this troubleshooting guide to help you remedy the problem.

---

### **There is no sound or only a very low-level sound no matter which component is selected.**

- Check that the speakers and components are connected securely and correctly.
- Check that both the receiver and all components are turned on.
- Check that you have selected the correct component on the receiver.
- Check that MASTER VOLUME -/+ is not set at “VOL MIN”.
- Check that the headphones are not connected.
- Press MUTING on the remote to cancel the muting function.

---

### **There is no sound from a specific component.**

- Check that the component is connected correctly to the audio input jacks for that component.
- Check that the cord(s) used for the connection is (are) fully inserted into the jacks on both the receiver and the component.
- Check that you have selected the correct component on the receiver.

---

### **There is no sound from one of the front speakers.**

- Connect a pair of headphones to the PHONES jack to verify that sound is output from the headphones. If only one channel is output from the headphones, the component may not be connected to the receiver correctly. Check that all the cords are fully inserted into the jacks on both the receiver and the component. If both channels are output from the headphones, the front speaker may not be connected to the receiver correctly. Check the connection of the front speaker which is not outputting any sound.

---

### **There is no sound from analog 2 channel sources.**

- Check that the INPUT MODE is not set to “COAX IN” or “OPT IN” (page 28).

---

### **There is no sound from digital sources (from COAXIAL or OPTICAL input jack).**

- Check that the INPUT MODE is not set to “ANALOG” (page 28). Check that the INPUT MODE is not set to “COAX IN” for the sources from OPTICAL input jack, or set to “OPT IN” for the sources from COAXIAL input jack.

---

### **The left and right sounds are unbalanced or reversed.**

- Check that the speakers and components are connected correctly and securely.
- Adjust balance parameters in the LEVEL menu.

---

### **There is severe hum or noise.**

- Check that the speakers and components are connected securely.
- Check that the connecting cords are away from a transformer or motor, and at least 3 meters away from a TV set or fluorescent light.
- Move your TV away from the audio components.
- The plugs and jacks are dirty. Wipe them with a cloth slightly moistened with alcohol.

---

### **There is no sound or only a very low-level sound is heard from the center or/and surround speakers.**

- Select a CINEMA STUDIO EX mode (page 26).
- Adjust the speaker level (page 17).

---

### **There is no sound from the sub woofer.**

- Check that the sub woofer is connected correctly and securely.

---

### **The surround effect cannot be obtained.**

- Make sure the sound field function is on (press MOVIE or MUSIC).
- Sound fields do not function for the signals with a sampling frequency of more than 48 kHz.

### The FM reception is poor.

- Use a 75-ohm coaxial cable (not supplied) to connect the receiver to an outdoor FM antenna as shown below. If you connect the receiver to an outdoor antenna, ground it against lightning. To prevent a gas explosion, do not connect the ground wire to a gas pipe.

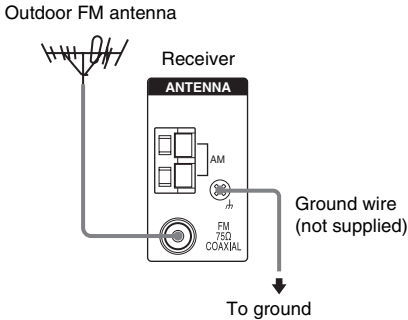

### Radio stations cannot be tuned in.

- Check that the antennas are connected securely. Adjust the antennas and connect an external antenna if necessary.
- The signal strength of the stations is too weak (when tuning in with automatic tuning). Use direct tuning.
- Make sure you set the tuning interval correctly (when tuning in AM stations with direct tuning).
- No stations have been preset or the preset stations have been cleared (when tuning by scanning preset stations). Preset the stations (page 20).
- Press DISPLAY repeatedly so that the frequency appears in the display.

### RDS does not work.\*

- Make sure that you are tuned to an FM RDS station.
- Select a stronger FM station.



### The RDS information that you want does not appear.\*

- Contact the radio station and find out whether they actually provide the service in question. If so, the service may be temporarily out of order.

\* Models of area code CEL, CEK only.

## Remote control

### The remote does not function.

- Point the remote at the remote sensor  on the receiver.
- Remove any obstacles in the path between the remote and the receiver.
- Replace all the batteries in the remote with new ones, if they are weak.
- Make sure you select the correct input on the remote.
- To activate the buttons with orange printing, press TV and the button you want simultaneously.
- Before you use the  button for receiver operation, press MAIN MENU. To operate other components, press TOP MENU/GUIDE or AV MENU after pressing the input button.

## Error messages

If there is a malfunction, the display shows a message. You can check the condition of the receiver by the message. Refer to the following table to solve the problem.

### DEC. ERROR

Appears when the signal which the receiver cannot decode (ex. DTS-CD) is input when "DEC. XXXX" is set to "DEC. PCM". Set to "DEC. AUTO".

### PROTECT

Irregular current is output from the speakers. The receiver will automatically turn off after a few seconds. Check the speaker connection and turn on the power again. If this problem persists, consult your nearest Sony dealer.

## If you are unable to remedy the problem using the troubleshooting guide

Clearing the receiver's memory may remedy the problem (page 14). However, note that all memorized settings will be reset to their factory settings and you will have to readjust all settings on the receiver.

## If the problem persists

Consult your nearest Sony dealer.

## Reference sections for clearing the receiver's memory

To clear	See
All memorized settings	page 14
Customized sound fields	page 29

## Specifications

### AUDIO POWER SPECIFICATIONS

#### POWER OUTPUT AND TOTAL HARMONIC DISTORTION: (Models of area code U only)

With 6 ohm loads, both channels driven, from 120 – 20,000 Hz; rated 60 watts per channel minimum RMS power, with no more than 0.7% total harmonic distortion from 250 milliwatts to rated output.

#### Amplifier section

Power Output<sup>1)</sup>

Models of area code U

(6 ohms 1 kHz, THD 10%)

FRONT<sup>2)</sup>: 100 W/ch

CENTER<sup>2)</sup>: 100 W

SURR<sup>2)</sup>: 100 W/ch

(6 ohms 100 Hz, THD 10%)

SUB WOOFER<sup>2)</sup>: 100 W

Models of area code CA

(6 ohms 1 kHz, THD 0.7%)

FRONT<sup>2)</sup>: 60 W/ch

CENTER<sup>2)</sup>: 60 W

SURR<sup>2)</sup>: 60 W/ch

(6 ohms 100 Hz, THD 0.7%)

SUB WOOFER<sup>2)</sup>: 60 W

(6 ohms 1 kHz, THD 10%)

FRONT<sup>2)</sup>: 100 W/ch

CENTER<sup>2)</sup>: 100 W

SURR<sup>2)</sup>: 100 W/ch

(6 ohms 100 Hz, THD 10%)

SUB WOOFER<sup>2)</sup>: 100 W

Models of area code MX, SP, E51, CEL, CEK

(6 ohms 1 kHz, THD 0.7%)

FRONT<sup>2)</sup>: 50 W/ch

CENTER<sup>2)</sup>: 50 W

SURR<sup>2)</sup>: 50 W/ch

(6 ohms 100 Hz, THD 0.7%)

SUB WOOFER<sup>2)</sup>: 50 W

(6 ohms 1 kHz, THD 10%)

FRONT<sup>2)</sup>: 85 W/ch

CENTER<sup>2)</sup>: 85 W

SURR<sup>2)</sup>: 85 W/ch

(6 ohms 100 Hz, THD 10%)

SUB WOOFER<sup>2)</sup>: 85 W



**Models of area code AU**

(6 ohms 120 Hz – 20 kHz, THD 0.09%)

FRONT<sup>2)</sup>: 40 W/ch  
 CENTER<sup>2)</sup>: 40 W  
 SURR<sup>2)</sup>: 40 W/ch

(6 ohms 100 Hz, THD 0.09%)

SUB WOOFER<sup>2)</sup>: 40 W

(6 ohms 1 kHz, THD 0.7%)

FRONT<sup>2)</sup>: 50 W/ch  
 CENTER<sup>2)</sup>: 50 W  
 SURR<sup>2)</sup>: 50 W/ch

(6 ohms 100 Hz, THD 0.7%)

SUB WOOFER<sup>2)</sup>: 50 W

(6 ohms 1 kHz, THD 10%)

FRONT<sup>2)</sup>: 85 W/ch  
 CENTER<sup>2)</sup>: 85 W  
 SURR<sup>2)</sup>: 85 W/ch

(6 ohms 100 Hz, THD 10%)

SUB WOOFER<sup>2)</sup>: 85 W

1) Measured under the following conditions:

Area code	Power requirements
U, CA	120 V AC, 60 Hz
CEL, CEK, SP	230 V AC, 50 Hz
AU, E51	240 V AC, 50 Hz
MX	127 V AC, 60 Hz

2) Depending on the sound field settings and the source, there may be no sound output.

**Inputs (Analog)**

SA-CD/CD, DVD, VIDEO 1, 2	Sensitivity: 800 mV Impedance: 50 k ohms
---------------------------	---

**Inputs (Digital)**

DVD (Coaxial)	Sensitivity: – Impedance: 75 ohms
SA-CD/CD (Optical)	Sensitivity: – Impedance: –

**Output (Analog)**

SUB WOOFER	Voltage: 2 V Impedance: 1 k ohm
------------	------------------------------------

**Reproduction frequency range:**

28 – 20,000 Hz

**Tone**

Gain levels	±6 dB, 1 dB step
-------------	------------------

**FM tuner section**

Tuning range	87.5 - 108.0 MHz
Antenna	FM wire antenna
Antenna terminals	75 ohms, unbalanced
Intermediate frequency	10.7 MHz

**AM tuner section**

Tuning range	
Models of area code U, CA	
With 10-kHz tuning scale:	530 – 1,710 kHz <sup>3)</sup>
With 9-kHz tuning scale:	531 – 1,710 kHz <sup>3)</sup>
Models of area code CEL, CEK, AU, SP	
With 9-kHz tuning scale:	531 – 1,602 kHz
Model of area code E51	
With 10-kHz tuning scale:	530 – 1,610 kHz <sup>3)</sup>
With 9-kHz tuning scale:	531 – 1,602 kHz <sup>3)</sup>
Models of area code MX	
With 10-kHz tuning scale:	530 – 1,610 kHz
Antenna	Loop antenna
Intermediate frequency	450 kHz

3) You can change the AM tuning scale to 9 kHz or 10 kHz. After tuning in any AM station, turn off the receiver. While holding down PRESET TUNING + or TUNING +, press I/⏏. All preset stations will be erased when you change the tuning scale. To reset the scale to 10 kHz (or 9 kHz), repeat the procedure.

**General**

**Power requirements**

Area code	Power requirements
U, CA	120 V AC, 60 Hz
CEL, CEK	230 V AC, 50/60 Hz
AU	240 V AC, 50 Hz
E51	120/220/240 V AC, 50/60 Hz
SP	220-230 V AC, 50/60 Hz
MX	127 V AC, 60 Hz

**Power consumption**

Area code	Power consumption
U, SP, E51, AU, CEL, CEK, MX	160 W
CA	220 VA

Power consumption (during standby mode)  
0.2 W

Dimensions (w/h/d) (Approx.)  
430 × 145 × 301.5 mm  
(17 × 5 6/8 × 11 7/8 inches)  
including projecting parts  
and controls

Mass (Approx.) 6.5 kg (14 lb 6 oz)

## Speaker section

### Models of area code CEL, CEK

#### Front speakers (SS-MSP67LE/ SS-MSP67RE)

##### Center speaker (SS-CNP87)

#### Surround speakers (SS-MSP67SLE/ SS-MSP67SRE)

Front/center speakers Full range, magnetically  
shielded

Surround speakers Full range

Speaker units 80 mm cone type

Enclosure type Bass reflex

Rated Impedance 6 ohms

Dimension (w/h/d) (Approx.)

Front/surround speakers 120 × 122 × 100 mm  
(4 6/8 × 4 7/8 × 4 inches)

Center speaker 225 × 102 × 126 mm  
(8 7/8 × 4 × 5 inches)

Mass (Approx.)

Front speakers 0.8 kg (1 lb 13 oz)

Center speaker 1.0 kg (2 lb 4 oz)

Surround speaker 0.6 kg (1 lb 6 oz)

### Models of other area code

#### Front speakers (SS-MSP67L/ SS-MSP67R)

##### Center speaker (SS-CNP67)

#### Surround speakers (SS-MSP67SL/ SS-MSP67SR)

Front/center speakers Full range, magnetically  
shielded

Surround speakers Full range

Speaker units 70 mm cone type

Enclosure type Closed type

Rated Impedance 6 ohms

Dimension (w/h/d) (Approx.)

Front/surround speakers 91 × 96 × 102 mm  
(3 1/2 × 3 3/4 × 4 inches)

Center speaker 155 × 96.2 × 102 mm  
(6 1/8 × 3 3/4 × 4 inches)

Mass (Approx.)

Front speaker 0.65 kg (1 lb 7 oz)

Center speaker 0.75 kg (1 lb 11 oz)

Surround speaker 0.6 kg (1 lb 6 oz)

## Sub woofer

### SS-WMSP67E (Models of area code CEL, CEK)

Speaker system Magnetically shielded

Speaker unit 160 mm cone type

Enclosure type Bass reflex

Dimensions (w/h/d) (Approx.)

200 × 380 × 334.3 mm  
(7 7/8 × 15 × 13 1/4 inches)  
including front panel

Mass (Approx.) 6.0 kg (13 lb 4 oz)

### SS-WMSP67 (Models of other area code)

Speaker system Magnetically shielded

Speaker unit 200 mm cone type

Enclosure type Bass reflex

Dimensions (w/h/d) (Approx.)

270 × 325 × 333 mm  
(10 6/8 × 12 7/8 × 13 1/8  
inches)  
including front panel

Mass (Approx.) 6.0 kg (13 lb 4 oz)

## Supplied accessories

FM wire antenna (1)

AM loop antenna (1)

Speaker connecting cord, long (2)

Speaker connecting cord, short (3)

Coaxial digital cord (1)

Foot pads (speakers) (20)

Foot pads (subwoofer) (4)

Remote commander (1)

R6 (size-AA) batteries (2)

Speakers

- Front speakers (2)

- Center speaker (1)

- Surround speakers (2)

- Sub woofer (1)

For details on the area code of the component you  
are using, see page 3.

Design and specifications are subject to change  
without notice.

# List of button locations and reference pages

## How to use this page

Use this page to find the location of buttons that are mentioned in the text.

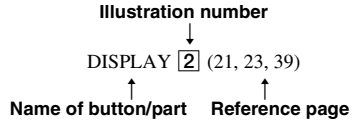

## Main unit

### ALPHABETICAL ORDER

#### A - H

A.F.D. **9** (25, 26, 27)  
AM **16** (18, 19, 32, 41)  
DIMMER **3** (23)  
DISPLAY **2** (21, 23, 39)  
Display **5** (21, 23)  
DVD **19** (18)  
ENTER **7** (14, 32)  
FM **17** (18, 19, 32, 41)  
FM MODE **25** (19)

#### I - O

INPUT MODE **13** (28)  
IR (receptor) **4** (33, 39)  
MAIN MENU **6** (15, 28, 30, 32)  
MASTER VOLUME  $-/+$  **12** (14, 17, 18, 38)  
MEMORY **24** (20)  
MOVIE **10** (26, 27, 38)  
MUSIC **11** (27, 38)

#### P - Z

PHONES (jack) **26** (18, 38)  
PRESET TUNING  $-/+$  **22** (20)  
SA-CD/CD **18** (18)  
TUNING  $-/+$  **23** (19)  
VIDEO 1 **21** (18)  
VIDEO 2 **20** (18)

### NUMBERS AND SYMBOLS

2CH **8** (25, 27, 29)  
I/⏻ (power) **1** (14, 20, 29)  
</> **14** (15, 28, 30, 32)  
+/- **15** (15, 28, 30, 32)

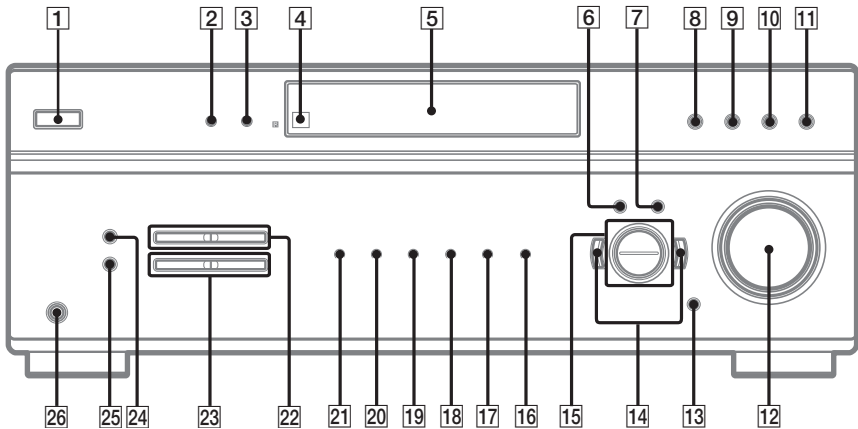

# Index

## A

### Adjusting

- CUSTOMIZE parameters 30
- LEVEL parameters 28
- SET UP parameters 15
- speaker levels and balance 17
- TONE parameters 30

### Automatic tuning 19

## C

### Changing

- display 23

### Clearing receiver's memory 14

### CUSTOMIZE menu 30

## D

### Digital Cinema Sound 26

### Direct tuning 19

### Dual Mono 31

## I

### Indexing. *See* Naming

### Installing the speakers 13

## L

### Labeling. *See* Naming

### LEVEL menu 28

## N

### Naming 32

## P

### Preset stations

- how to 20
- how to tune 21

## R

### RDS 21

## S

### Selecting

- component 18
- sound field 26–27

### SET UP menu 15

### Sleep Timer 32

### Sound field

- customizing 28
- pre-programmed 26–27
- resetting 29
- selecting 26–27

### Speakers

- adjusting speaker levels and balance 17
- connection 11
- installing 13
- placement 11

### Supplied accessories 42

## T

### Test tone 17

### TONE menu 30

### Tuning

- automatically 19
- directly 19
- to preset stations 20