

## DVD Recorder

Operating Instructions

 To find out useful hints, tips and information about Sony products and services please visit: [www.sony-europe.com/myproduct](http://www.sony-europe.com/myproduct)

RDR-HX680/HX780/HX980



## WARNING

To reduce the risk of fire or electric shock, do not expose this apparatus to rain or moisture. To avoid electrical shock, do not open the cabinet. Refer servicing to qualified personnel only. The mains lead must be changed only at a qualified service shop. Batteries or batteries installed apparatus shall not be exposed to excessive heat such as sunshine, fire or the like.

CLASS 1 LASER PRODUCT  
LASER KLASSE 1  
LUOKAN 1 LASERLAITE  
KLASS 1 LASERAPPARAT

This appliance is classified as a CLASS 1 LASER product. The CLASS 1 LASER PRODUCT MARKING is located on the rear of the unit.

## CAUTION

The use of optical instruments with this product will increase eye hazard. As the laser beam used in this DVD recorder is harmful to eyes, do not attempt to disassemble the cabinet. Refer servicing to qualified personnel only.

CAUTION CLASS 3B VISIBLE AND INVISIBLE LASER RADIATION WHEN OPEN. AVOID DIRECT EXPOSURE TO THE BEAM.  
VORSICHT KLASSE 3B BEWIRKT SICH UND UNSICHTBARE LASERSTRALUNG WENN GEÖFFNET. DIREKTEN KONTAKT MIT DEM STRAHLEN VERMEIDEN.  
ADVARSEL SYNLIG OG USYNLIG LASERSTRÅLING AF KLASSE 3B VED ÅBNING. UNDGÅ DIREKTE UDSETTELSE FOR STRÅLING NÅR DEKSEL ÅPNES.  
VARNING KLASSE 3B SYNLIG OCH OSYNLIG LASERSTRÅLNING NÄR BEHÅLLET ÄR ÖPPNAD. UNDGÅ ATT DIREKT EXPONERAS FÖR STRÅLNINGEN.  
VARO! AVATTUNA LUOKAN 3B NÄKYYVÄÄ JA NÄKYMÄTTÖN LASERSTRÄLÄÄ. VÄLTÄ SUORAA ALTETIJÄMISTÄ SATELLE.

This label is located on the laser protective housing inside the enclosure.

## Notice for customers in the United Kingdom and Republic of Ireland

A molded plug complying with BS1363 is fitted to this equipment for your safety and convenience. Should the fuse in the plug supplied need to be replaced, a 5 AMP fuse approved by ASTA or BSI to BS1362, (i.e., marked with ⚡ or ⚡ mark) must be used. If the plug supplied with this equipment has a detachable fuse cover, be sure to attach the fuse cover after you change the fuse. Never use the plug without the fuse cover. If you should lose the fuse cover, please contact your nearest Sony service station.

## Precautions

- This unit operates on 220 – 240 V AC, 50/60 Hz. Check that the unit's operating voltage is identical with your local power supply.
- To prevent fire or shock hazard, do not place objects filled with liquids, such as vases, on the apparatus.
- Install this system so that the mains lead can be unplugged from the wall socket immediately in the event of trouble.



## Disposal of Old Electrical & Electronic Equipment (Applicable in the European Union and other European countries with separate collection systems)

This symbol on the product or on its packaging indicates that this product shall not be treated as household waste. Instead it shall be handed over to the applicable collection point for the recycling of electrical and electronic equipment. By ensuring this product is disposed of correctly, you will help prevent potential negative consequences for the environment and human health, which could otherwise be caused by inappropriate waste handling of this product. The recycling of materials will help to conserve natural resources. For more detailed information about recycling of this product, please contact your local Civic Office, your household waste disposal service or the shop where you purchased the product.

Europe Only



**Pb**

**Disposal of waste batteries (applicable in the European Union and other European countries with separate collection systems)**

This symbol on the battery or on the packaging indicates that the battery provided with this product shall not be treated as household waste.

By ensuring these batteries are disposed of correctly, you will help prevent potentially negative consequences for the environment and human health which could otherwise be caused by inappropriate waste handling of the battery. The recycling of the materials will help to conserve natural resources.

In case of products that for safety, performance or data integrity reasons require a permanent connection with an incorporated battery, this battery should be replaced by qualified service staff only.

To ensure that the battery will be treated properly, hand over the product at end-of-life to the applicable collection point for the recycling of electrical and electronic equipment.

For all other batteries, please view the section on how to remove the battery from the product safely. Hand the battery over to the applicable collection point for the recycling of waste batteries.

For more detailed information about recycling of this product or battery, please contact your local Civic Office, your household waste disposal service or the shop where you purchased the product.

The manufacturer of this product is Sony Corporation, 1-7-1 Konan Minato-ku Tokyo, 108-0075 Japan. The Authorized Representative for EMC and product safety is Sony Deutschland GmbH, Hedelfinger Strasse 61, 70327 Stuttgart, Germany.

For any service or guarantee matters please refer to the addresses given in separate service or guarantee documents.

## Precautions

This equipment has been tested and found to comply with the limits set out in the EMC Directive using a connection cable shorter than 3 metres.

### On safety

Should any solid object or liquid fall into the cabinet, unplug the recorder and have it checked by qualified personnel before operating it any further.

### About the hard disk drive

The hard disk has a high storage density, which enables long recording durations and quick access to the written data.

However, it can easily be damaged by shock, vibration or dust, and should be kept away from magnets. To avoid losing important data, observe the following precautions.

- Do not apply a strong shock to the recorder.
- Do not place the recorder in a location subject to mechanical vibrations or in an unstable location.
- Do not place the recorder on top of a hot surface, such as a VCR or amplifier (receiver).
- Do not use the recorder in a place subject to extreme changes in temperature (temperature gradient less than 10 °C/hour).
- Do not move the recorder with its mains lead connected.
- Do not disconnect the mains lead while the power is on.
- When disconnecting the mains lead, turn off the power and make sure that the hard disk drive is not operating (the clock is displayed in the front panel display for at least 30 seconds and all recording or dubbing has stopped).
- Do not move the recorder for one minute after you have unplugged the mains lead.

- Do not attempt to replace or upgrade the hard disk by yourself, as this may result in malfunction.

If the hard disk drive should malfunction, you cannot recover lost data. The hard disk drive is only a temporary storage space.

## About repairing the hard disk drive

- The contents of the hard disk drive may be checked in case of repair or inspection during a malfunction or modification. However, the contents will not be backed up or saved by Sony.
- If the hard disk needs to be formatted or replaced, it will be done at the discretion of Sony. All contents of the hard disk drive will be erased, including contents that violate copyright laws.

## On power sources

- The recorder is not disconnected from the AC power source (mains) as long as it is connected to the wall outlet, even if the recorder itself has been turned off.
- If you are not going to use the recorder for a long time, be sure to disconnect the recorder from the wall outlet. To disconnect the AC power cord (mains lead), grasp the plug itself; never pull the cord.

## On placement

- Place the recorder in a location with adequate ventilation to prevent heat build-up in the recorder.
- Do not place the recorder on a soft surface such as a rug that might block the ventilation holes.
- Do not place the recorder in a confined space such as a bookshelf or similar unit.

- Do not place the recorder in a location near heat sources, or in a place subject to direct sunlight, excessive dust, or mechanical shock.
- Do not place the recorder in an inclined position. It is designed to be operated in a horizontal position only.
- Keep the recorder and discs away from equipment with strong magnets, such as microwave ovens, or large loudspeakers.
- Do not place heavy objects on the recorder.

## On recording

Make trial recordings before making the actual recording.

## On compensation for lost recordings

Sony is not liable and will not compensate for any lost recordings or relevant losses, including when recordings are not made due to reasons including recorder failure, or when the contents of a recording are lost or damaged as a result of recorder failure or repair undertaken to the recorder. Sony will not restore, recover, or replicate the recorded contents under any circumstances.

## Copyrights

- Television programmes, films, video tapes, discs, and other materials may be copyrighted. Unauthorized recording of such material may be contrary to the provisions of the copyright laws. Also, use of this recorder with cable television transmission may require authorization from the cable television transmitter and/or programme owner.

- This product incorporates copyright protection technology that is protected by U.S. patents and other intellectual property rights. Use of this copyright protection technology must be authorized by Macrovision, and is intended for home and other limited viewing uses only unless otherwise authorized by Macrovision. Reverse engineering or disassembly is prohibited.
- This Product includes FontAvenue® fonts licenced by NEC corporation. FontAvenue is a registered trademark of NEC corporation.
- "X" and x-Application are trademarks of Sony Corporation.

## Copy guard function

Since the recorder has a copy guard function, programmes received through an external tuner (not supplied) may contain copy protection signals (copy guard function) and as such may not be recordable, depending on the type of signal.

### IMPORTANT NOTICE

Caution: This recorder is capable of holding a still video image or on-screen display image on your television screen indefinitely. If you leave the still video image or on-screen display image displayed on your TV for an extended period of time you risk permanent damage to your television screen. Plasma display panels and projection televisions are especially susceptible to this.

If you have any questions or problems concerning your recorder, please consult your nearest Sony dealer.

## About this manual

### Check your model name

The instructions in this manual are for 3 models: RDR-HX680, RDR-HX780, and RDR-HX980. Check your model name by looking at the front panel of the recorder.

- In this manual, the internal hard disk drive is written as “HDD;” and “disc” is used as a general reference for the HDD, DVDs, or CDs unless otherwise specified by the text or illustrations.
- Icons, such as , listed at the top of each explanation indicate what kind of media can be used with the function being explained. For details, see “Recordable and Playable Discs” on page 125.
- Instructions in this manual describe the controls on the remote. You can also use the controls on the recorder if they have the same or similar names as those on the remote.
- The on-screen display illustrations used in this manual may not match the graphics displayed on your TV screen.
- The explanations regarding DVDs in this manual refer to DVDs created on this recorder. The explanations do not apply to DVDs that are created on other recorders and played back on this recorder.

# Table of Contents

WARNING .....	2
Precautions .....	3
Guide to Parts and Controls .....	10

## **Hookups and Settings ..... 15**

Hooking Up the Recorder .....	15
Step 1: Connecting the Aerial Cable .....	16
Step 2: Connecting the Video Cords/HDMI Cord .....	17
About the SMARTLINK features (for SCART connections only) .....	19
About the "Control for HDMI" functions for 'BRAVIA' Sync (for HDMI connections only) .....	19
Step 3: Connecting the Audio Cords/HDMI Cord .....	20
Step 4: Connecting the Mains Lead .....	21
Step 5: Preparing the Remote .....	22
Controlling TVs with the remote .....	22
If you have a Sony DVD player or more than one Sony DVD recorder .....	23
Changing programme positions of the recorder using the remote .....	23
Step 6: Easy Setup .....	24
Connecting a VCR or Similar Device .....	26
Connecting to the LINE 1/DECODER jack .....	26
Connecting to the LINE 2 IN jacks on the front panel .....	27
Connecting to a Satellite or Digital Tuner .....	28
Connecting an External Decoder .....	29
Connecting a decoder .....	29
Setting external decoder (PAY-TV/Canal Plus analogue decoder) programme positions .....	30

## **Seven Basic Operations — Getting to Know Your DVD Recorder**

1. Inserting a Disc .....	31
2. Recording a Programme .....	31
Checking the disc status while recording .....	33
3. Playing the Recorded Programme (Title List) .....	33
Displaying the playing time and play information .....	36
4. Changing the Name of a Recorded Programme .....	37
5. Labelling and Protecting a Disc .....	38
Labelling a disc .....	38
Protecting a disc .....	38
6. Playing the Disc on Other DVD Equipment (Finalise) .....	39
Unfinalising a disc .....	41
7. Reformatting a Disc .....	42

<b>Recording</b> .....	<b>43</b>
Timer Recording .....	43
Using the Quick Timer function .....	45
Recording stereo and bilingual programmes .....	45
Creating chapters in a title .....	45
Checking/Changing/Canceling Timer Settings (Timer List) .....	46
Recording from Connected Equipment .....	47
Recording from connected equipment with a timer (Synchro Rec.) ..	47
Recording from connected equipment without a timer .....	48
<hr/>	
<b>Playback</b> .....	<b>49</b>
Playing .....	49
Playback options .....	51
Playing a specific portion repeatedly (A-B Repeat) .....	53
Playing repeatedly (Repeat) .....	53
Creating your own programme (Programme) .....	54
Advanced Playback Functions .....	55
Pausing a TV broadcast (TV Pause/Pause Live TV) .....	55
Playing from the beginning of the programme you are recording (Chase Play) .....	55
Playing a previous recording while making another (Simultaneous Rec and Play) .....	56
Searching for a Time/Title/Chapter/Track, etc. ....	56
<hr/>	
<b>Erasing and Editing</b> .....	<b>58</b>
Before Editing .....	58
Erasing and Editing a Title .....	59
Editing multiple titles (Multi-Mode) .....	59
Erasing a section of a title (A-B Erase) .....	60
Dividing a title (Divide) .....	60
Erasing and Editing a Chapter .....	61
Dividing a chapter (Divide) .....	62
Erasing a chapter (Erase) .....	62
Combining multiple chapters (Combine) .....	62
Creating and Editing a Playlist .....	63
Moving a Playlist title (Move) .....	63
Combining multiple Playlist titles (Combine) .....	63
Dividing a Playlist title (Divide) .....	63
Moving a chapter (Move) .....	64
<hr/>	
<b>Dubbing (HDD ↔ DVD)</b> .....	<b>65</b>
Before Dubbing .....	65
HDD/DVD Dubbing .....	66
Dubbing Using Dubbing List .....	66
Making a Backup Disc (DVD Backup) .....	69

<b>HDD Camcorder Dubbing</b> .....	<b>70</b>
Before HDD Camcorder Dubbing .....	70
Preparing for HDD camcorder dubbing. ....	71
One-Touch Dubbing from HDD Camcorder (ONE-TOUCH DUB) .....	72
Dubbing from HDD Camcorder Using the On-Screen Display (HDD-Cam Dubbing) .....	72
<hr/>	
<b>DV Camcorder Dubbing</b> .....	<b>74</b>
Before DV Camcorder Dubbing .....	74
Preparing for DV camcorder dubbing .....	74
Dubbing an Entire DV Format Tape (DV One-Touch Dubbing) .....	76
Dubbing Selected Scenes (DV Manual Dubbing) .....	76
Playing from a DV Camcorder .....	77
<hr/>	
<b>Music Jukebox</b> .....	<b>78</b>
About Jukebox .....	78
Preparing for Using Jukebox .....	78
Connecting the USB device .....	78
Copying tracks or albums (USB → HDD) .....	78
Copying audio tracks (DISC → HDD) .....	79
Copying tracks or albums on the HDD (HDD ↔ HDD) .....	79
Playing Audio Tracks Using Jukebox/USB Device .....	80
Adding audio tracks to a Playlist (HDD only) .....	81
Playback options .....	81
Playing repeatedly (Repeat) .....	81
Creating your own programme (Programme) (USB device only) .....	82
Managing Audio Tracks on the Music Jukebox (HDD only) .....	83
<hr/>	
<b>Photo Album</b> .....	<b>84</b>
About the “Photo Album” Function .....	84
Preparing for Using the “Photo Album” Function .....	84
Connecting the USB device .....	84
Copying JPEG image files to the HDD (DISC/USB → HDD) .....	84
Copying all JPEG image files from the connected USB device (USB → DVD-RW/DVD-R) .....	85
Copying JPEG image files or albums on the HDD (HDD ↔ HDD) .....	86
Copying JPEG image albums to a disc (HDD → DVD-RW/DVD-R) .....	86
Copying JPEG image files to a disc (HDD → DVD-RW/DVD-R) .....	87
Using the “Photo Album” List .....	88
Playing a slideshow .....	90
Creating a Slideshow with Your Favourite Music and Graphic Effects (x-Pict Story) (HDD only) .....	91
Managing JPEG Image Files on the HDD .....	93
Printing JPEG Image Files .....	94



<b>Settings and Adjustments</b> .....	<b>96</b>
Adjusting Picture Quality .....	96
Using the Setup Menus .....	99
Disc Settings (Disc Setup) .....	99
Recorder Settings (Basic) .....	100
Aerial Reception Settings (Tuner) .....	102
Video Settings (Video In/Out) .....	105
Audio Input Settings (Audio In) .....	106
Audio Output Settings (Audio Out) .....	107
Language Settings (Language) .....	109
Recording Settings (Recording) .....	110
Playback Settings (Playback) .....	111
HDMI Settings (HDMI Output) .....	113
Other Settings (Options) .....	115
Other Settings (Options 2) .....	117
<hr/>	
<b>Additional Information</b> .....	<b>118</b>
Troubleshooting .....	118
Resetting the Recorder .....	124
Recordable and Playable Discs .....	125
Playable Discs .....	127
About Recording/Dubbing Mode .....	128
Language Code List .....	132
Country/Area Code .....	132
Notes About This Recorder .....	133
Notes on MP3 Audio Tracks, JPEG Image Files, DivX Video Files, and i.Link .....	134
Specifications .....	136
Index .....	137

# Guide to Parts and Controls

For more information, see the pages in parentheses.

## Remote

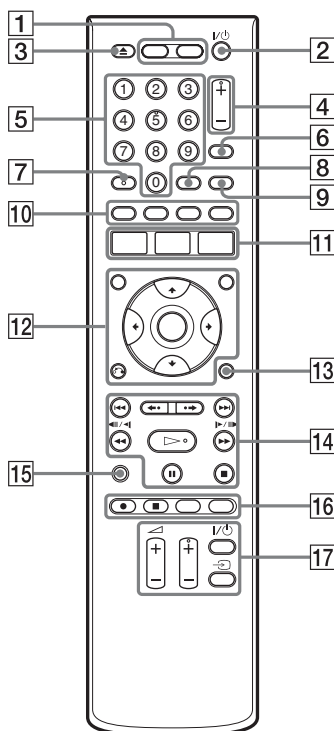

- 1 HDD (31)**  
Records to or plays titles on HDD.
- DVD (31)**  
Records to or plays titles on DVD.
- 2 I/⏻ (on/standby) (24)**  
Turns the recorder on or off.
- 3 ▲ (open/close) (31)**  
Opens or closes the disc tray.
- 4 PROG (programme) +/- (31)**  
The + button has a tactile dot\*.
- 5 Number buttons (56)**  
The number 5 button has a tactile dot\*.
- 6 INPUT (input select) (47)**  
Selects an input source.
- 7 AUDIO (51)**  
The AUDIO button has a tactile dot\*.
- 8 CLEAR (37, 53, 54)**
- 9 TV/DVD (22)**  
Switches between TV mode and DVD mode.
- 10 SUBTITLE (51)**  
Selects a subtitle language.
- ANGLE (51, 90)**  
Changes the angles or rotates an image during slideshow.
- PLAY MODE (53, 56)**
- ZOOM (90)**  
Zooms an image during a slideshow.
- 11 SYSTEM MENU (96)**
- TITLE LIST (33, 49, 59)**
- TIMER (43)**
- 12 TOP MENU (49)**
- MENU (49)**  
Displays the disc's menu.
- ←/↑/↓/→/ENTER (24)**  
Selects a desired item.
- ↶ RETURN (24)**
- 13 DISPLAY (36)**  
Displays the playing status or disc information.
- 14 ◀◀/▶▶ (previous/next) (51, 81)**  
**◀•/•▶ (instant replay/instant advance) (51)**  
**◀◀◀◀||◀|▶▶▶▶ (search/slow/freeze frame) (51, 81)**  
**▷ (play) (49, 90)**  
**|| (pause) (32, 51, 81, 90)**  
**■ (stop) (49, 80, 90)**  
The ▷ button has a tactile dot\*.

**15 TV PAUSE (55)**

**16 ● REC (31)**

**■ REC STOP (31)**

**HDD/DVD DUB (66)**

Starts dubbing the current playing title or cancels the dubbing.

**REC MODE (31)**

Selects the recording mode.

**17 TV I/⏻ (on/standby) (22)**

**TV ↻ (input select) (22)**

**TV ▲ (volume) +/- (22)**

**TV PROG (programme) +/- (22)**

The + button has a tactile dot\*.

\* Use the tactile dot as a reference when operating the recorder.

## Front panel

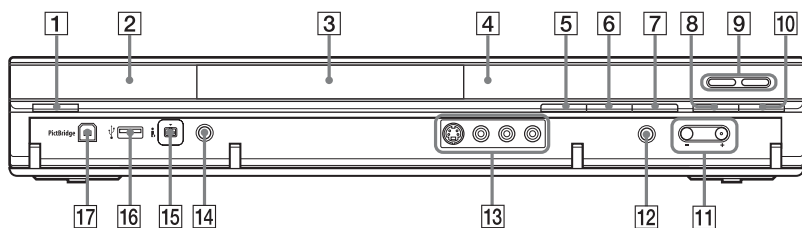

**1** **I/⏻ (on/standby) (24)**

Turns the recorder on or off.

**2** **Ⓜ (remote sensor) (22)**

**3** **Disc tray (31)**

**4** **Front panel display (13)**

**5** **⏮ (open/close) (31)**

Opens or closes the disc tray.

**6** **▶ (play) (49, 90)**

The ▶ button has a tactile dot\*.

**7** **■ (stop) (49, 80, 90)**

**8** **● REC (31)**

**9** **HDD (31)**

Records to or plays titles on HDD. The HDD indicator lights up when the HDD is selected.

**DVD (31)**

Records to or plays titles on DVD. The DVD indicator lights up when the DVD is selected.

**10** **■ REC STOP (31)**

**11** **PROGRAM +/- (31)**

The + button has a tactile dot\*.

**12** **INPUT (input select) (47)**

Selects an input source.

**13** **LINE 2 IN (S VIDEO/VIDEO/  
L(MONO) AUDIO R) jacks (27)**

Connect a VCR or similar recording device to these jacks.

**14** **ONE-TOUCH DUB (72, 76)**

Starts dubbing from a connected digital video camera.

**15** **📹 DV IN jack (74)**

Connect a DV camcorder to this jack.

**16** **📶 USB jack (type A) (78, 84)**

Connect a USB device to this jack.

**17** **PictBridge USB jack (type B)  
(94)**

Connect a PictBridge-compatible printer to this jack.

\* Use the tactile dot as a reference when operating the recorder.

### To lock the recorder (Child Lock)

You can lock all of the buttons on the recorder so that the settings are not cancelled by mistake.

When the recorder is turned off, hold down ■ (stop) on the recorder until “LOCKED” appears in the front panel display. The recorder does not work except for timer recordings and Synchro-Recording while the Child Lock is set.

To unlock the recorder, hold down ■ (stop) on the recorder until “UNLOCKED” appears in the front panel display.

## Front panel display

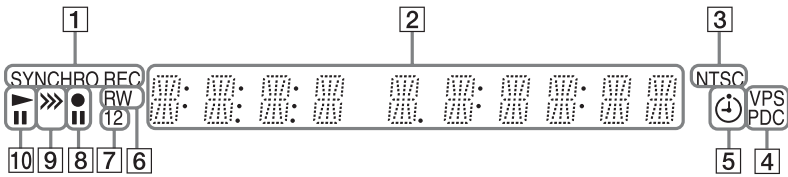

**1 SYNCHRO REC indicator (47)**

Lights up when the recorder is set to stand by for Synchro-Recording.

**2 Displays the following:**

- Playing time
- Current title/chapter/track/index number
- Recording time/recording mode
- Clock
- Programme position
- TV Direct Rec. indication (31)  
“TV” appears in the right most two digits.

**3 NTSC indicator (101, 106)**

Lights up when NTSC colour system is selected.

**4 VPS/PDC indicator (44)**

**5 Timer indicator (43)**

Lights up when the timer for recording is set.

**6 Disc type**

Lights up when a recordable DVD-R or DVD-RW disc is loaded.

**7 Command Mode indicator (115)**

Displays the Command Mode of the remote.

When the Command Mode for the recorder is set to “3 (Default setting),” either “1” or “2” does not appear.

**8 Recording status**

**9 Dubbing direction indicator**

**10 Playing status**

## Rear panel

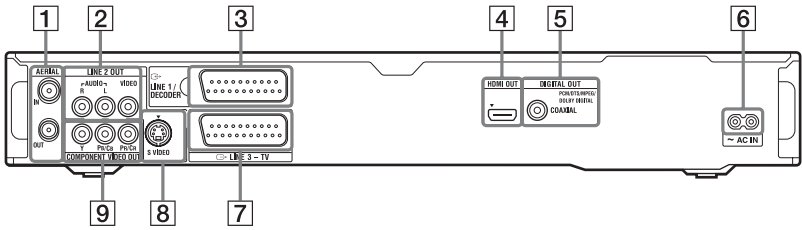

- 1** AERIAL IN/OUT jacks (16)
- 2** LINE 2 OUT (R-AUDIO-L/VIDEO) jacks (17, 20)
- 3** LINE 1 / DECODER jack (26)
- 4** HDMI OUT (high-definition multimedia interface out) jack (17, 20)

- 5** DIGITAL OUT (COAXIAL) jack (20)
- 6** AC IN terminal (21)
- 7** LINE 3 – TV jack (17)
- 8** LINE 2 OUT (S VIDEO) jack (17)
- 9** COMPONENT VIDEO OUT (Y, Pb/Cb, Pr/Cr) jacks (17)

# Hooking Up the Recorder

Follow steps 1 through 6 to hook up and adjust the settings of the recorder. Do not connect the mains lead until you reach “Step 4: Connecting the Mains Lead” on page 21.

### Notes

- See “Specifications” (page 136) for a list of supplied accessories.
- Plug in cords securely to prevent unwanted noise.
- Refer to the instructions supplied with the components to be connected.
- You cannot connect this recorder to a TV that does not have a SCART or video input jack.
- Be sure to disconnect the mains lead of each component before connecting.

# Step 1: Connecting the Aerial Cable

Connect the aerial cable by following the steps below.

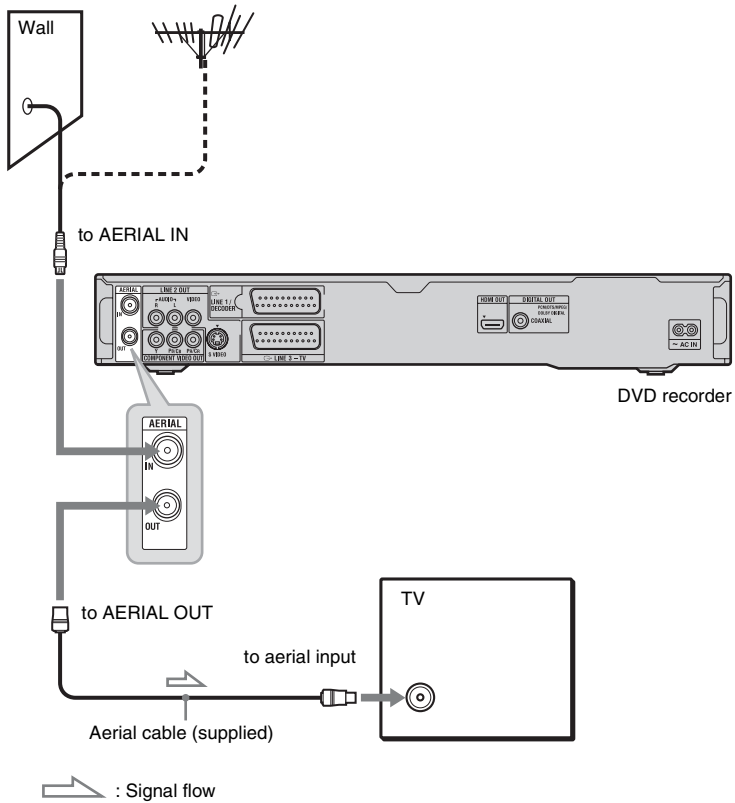

- 1** Disconnect the aerial cable from your TV, and connect it to AERIAL IN on the rear panel of the recorder.
- 2** Connect AERIAL OUT of the recorder to the aerial input of your TV using the supplied aerial cable.



# Step 2: Connecting the Video Cords/HDMI Cord

Select one of the following patterns, **A** through **E**, according to the input jack on your TV monitor, projector, or audio component such as an AV amplifier (receiver). This will enable you to view pictures.

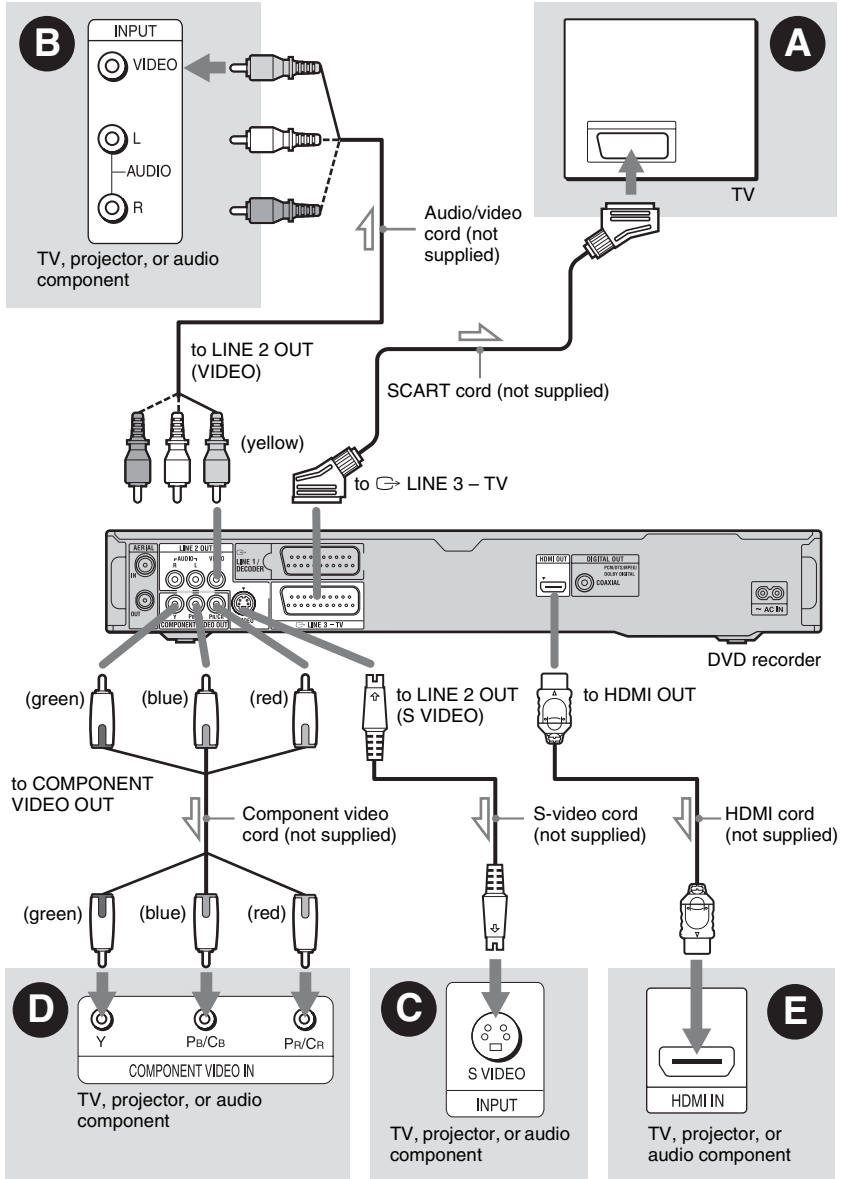

### A SCART input jack

When setting “LINE 3 Out” to “S-Video” or “RGB” in the “Video In/Out” setup (page 105), use a SCART cord that conforms to the selected signal.

### B Video input jack

You will enjoy standard quality images.

### C S VIDEO input jack

You will enjoy high quality images.

### D Component video input jacks (Y, Pb/Cb, Pr/Cr)

You will enjoy accurate colour reproduction and high quality images.

If your TV accepts progressive 525p/625p format signals, use this connection and set “Progressive” to “Compatible” in the “Easy Setup” setup (page 24). Then set “Component Video Out” to “Progressive” in the “Video In/Out” setup to send progressive video signals. For details, see “Component Video Out” on page 105.

### E HDMI input jack

Use a certified HDMI cord (not supplied) to enjoy high quality digital picture and sound through the HDMI OUT jack.

When connecting a Sony TV that is compatible with the “Control for HDMI” function, see page 19.

To see the signals from the connected set top box receiver when the set top box receiver is connected to the recorder using a SCART cord only, turn the recorder on.

### When connecting to the HDMI jack

Follow the steps below. Improper handling may damage the HDMI jack and the connector.

- 1 Carefully align the HDMI jack on the rear of the recorder and the HDMI connector by checking their shapes. Make sure the connector is not upside down or tilted.



- 2 Insert the HDMI connector straight into the HDMI jack. Do not bend or apply pressure to the HDMI connector.

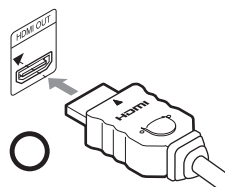

### Notes

- Be sure to disconnect the HDMI cord when moving the recorder.
- Do not apply too much pressure to the cabinet wall, if you place the recorder on the cabinet with the HDMI cord connected. It may damage the HDMI jack or the HDMI cord.
- Do not twist the HDMI connector while connecting to or disconnecting from the HDMI jack to avoid damaging the HDMI jack and connector.

### When playing “wide screen” images

Some recorded images may not fit your TV screen. To change the picture size, see page 111.

### If you are connecting to a VCR

Connect your VCR to the LINE 1/ DECODER jack on the recorder (page 26).

## ⚡ Notes

- Do not connect more than one type of video cord between the recorder and your TV at the same time.
- Do not make connections **A** and **E** at the same time.
- When you connect the recorder to your TV via the SCART jacks, the TV's input source is set to the recorder automatically when you start playback. If necessary, press the TV  button on the remote to return the input to the TV.
- If you connect the recorder to a TV with SMARTLINK, set "LINE 3 Out" to "Video" in the "Video In/Out" setup.
- You cannot connect the HDMI OUT jack (connection **E**) to DVI jacks that are not HDCP compliant (e.g., DVI jacks on PC displays).
- Component video and RGB signals are not output when using the HDMI connection.

\* This DVD recorder incorporates High-Definition Multimedia Interface (HDMI™) technology.

HDMI, the HDMI logo and High-Definition Multimedia Interface are trademarks or registered trademarks of HDMI Licensing LLC.

## About the SMARTLINK features (for SCART connections only)

If the connected TV (or other connected equipment such as a set top box receiver) complies with SMARTLINK, NexTVView Link<sup>\*3</sup>, MEGALOGIC<sup>\*1</sup>, EASYLINK<sup>\*2</sup>, CINEMALINK<sup>\*2</sup>, Q-Link<sup>\*3</sup>, EURO VIEW LINK<sup>\*4</sup>, or T-V LINK<sup>\*5</sup>, you can enjoy the following SMARTLINK features.

- TV Direct Rec. (page 32)
- One-Touch Play (page 50)
- Preset Download  
You can download the tuner preset data from your TV to this recorder, and tune the recorder according to that data in "Easy Setup."
- NexTVView Download  
You can easily set the timer by using the NexTVView Download function on your TV.

**To prepare for the SMARTLINK features**  
Set "LINE 3 Out" to "Video" in the "Video In/Out" setup (page 105) and "SMARTLINK" to "This Recorder Only" in the "Options" setup (page 116).

## ⚡ Notes

- For correct SMARTLINK connection, you will need a SCART cord that has the full 21 pins. Refer as well to your TV's instruction manual for this connection.
- Not all TVs respond to the functions above.

\*1 "MEGALOGIC" is a registered trademark of Grundig Corporation.

\*2 "EASYLINK" and "CINEMALINK" are trademarks of Philips Corporation.

\*3 "Q-Link" and "NexTVView Link" are trademarks of Panasonic Corporation.

\*4 "EURO VIEW LINK" is a trademark of Toshiba Corporation.

\*5 "T-V LINK" is a trademark of JVC Corporation.

## About the "Control for HDMI" functions for 'BRAVIA' Sync (for HDMI connections only)

By connecting Sony components that are compatible with the "Control for HDMI" function with an HDMI cord (not supplied), operation is simplified as below:

- One-Touch Play (page 50)
- System Power-Off  
When you turn the TV off using the power button on the TV's remote, the recorder and components compatible with the "Control for HDMI" function turn off automatically. However, the recorder does not turn off while recording or dubbing even if you turn off the TV.
- 'BRAVIA' Sync display  
You can control the recorder by pressing the SYNC MENU button on the TV's remote.

## ⚡ Notes

- Depending on the connected component, the "Control for HDMI" function may not work. Refer to the operating instructions supplied with the component.
- You can use the 'BRAVIA' Sync display feature only when the connected TV has the SYNC MENU button. For details on 'BRAVIA' Sync, refer to the operating instructions supplied with the TV.
- To use the 'BRAVIA' Sync features, set "Control for HDMI" to "On" (default) in the "HDMI Output" setup (page 115).

# Step 3: Connecting the Audio Cords/HDMI Cord

Select one of the following patterns, **A** or **B**, according to the input jack on your TV monitor, projector, or audio component such as an AV amplifier (receiver). This will enable you to listen to sound.

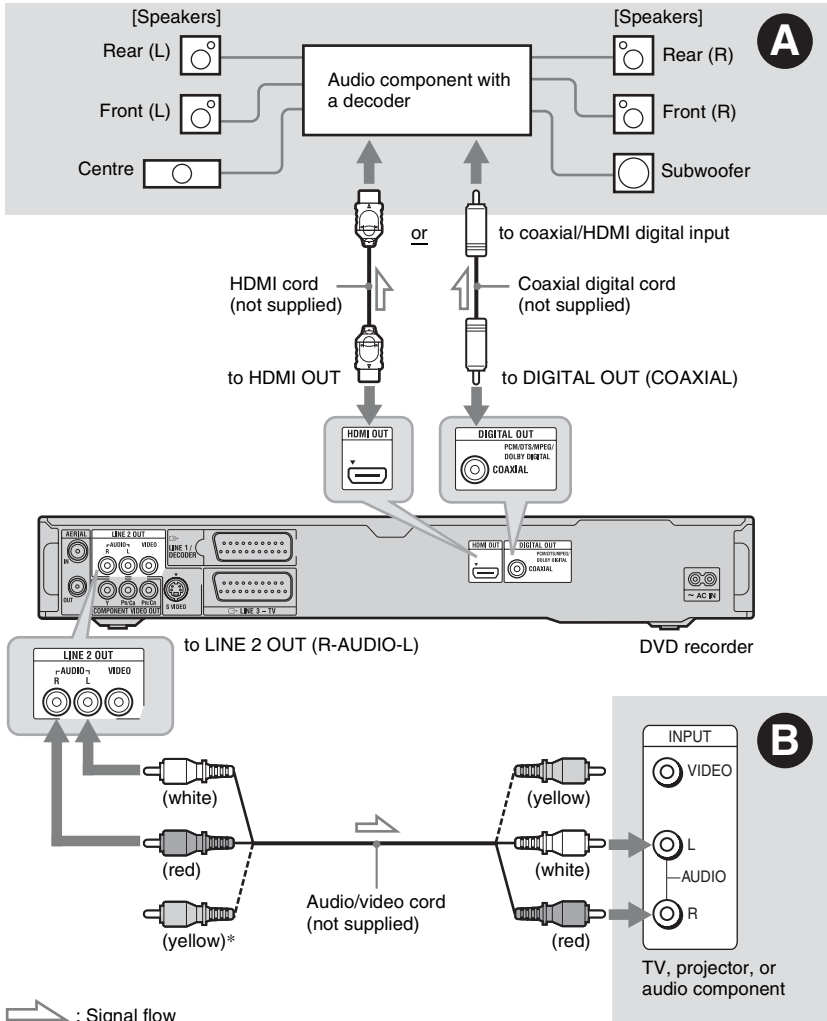

\* The yellow plug is used for video signals (page 17).

## **A** Digital audio input jack

If your audio component has a Dolby<sup>®</sup> Digital, DTS<sup>®</sup>\*, or MPEG audio decoder and a digital input jack, use this connection. You can enjoy Dolby Digital (5.1ch), DTS (5.1ch), and MPEG audio (5.1ch) surround effects.

If you connect a Sony audio component that is compatible with the "Control for HDMI" function, refer to the operating instructions supplied with the audio component.

## B Audio L/R (left/right) input jacks

This connection will use your TV's or audio component's two speakers for sound.

### 💡 Hint

For correct speaker location, refer to the operating instructions supplied with the connected components.

### ⚡ Notes

- Do not connect your TV's audio output jacks to the LINE IN (R-AUDIO-L) jacks at the same time. This will cause unwanted noise to come from your TV's speakers.
- With connection B, do not connect the LINE IN (R-AUDIO-L) and LINE 2 OUT (R-AUDIO-L) jacks to your TV's audio output jacks at the same time. This will cause unwanted noise to come from your TV's speakers.
- With connection A, after you have completed the connection, make the appropriate settings in the "Audio Out" setup (page 107). Otherwise, no sound or a loud noise will come from your speakers.
- When you connect the recorder to an audio component using an HDMI cord, you will need to do one of the following:
  - Connect the audio component to the TV with the HDMI cord, or
  - Connect the recorder to the TV with a video cord other than HDMI cord (component video cord, S-video cord, or audio/video cord).

\*1 Manufactured under license from Dolby Laboratories.  
Dolby and the double-D symbol are trademarks of Dolby Laboratories.

\*2 Manufactured under license under U.S. Patent #: 5,451,942 & other U.S. and worldwide patents issued & pending. DTS and DTS Digital Out are registered trademarks and the DTS logos and Symbol are trademarks of DTS, Inc. © 1996-2007 DTS, Inc. All Rights Reserved.

## Step 4: Connecting the Mains Lead

Connect the supplied mains lead to the AC IN terminal of the recorder. Then plug the recorder and TV mains leads (AC power cords) into the mains. After you connect the mains lead, **you must wait for a short while before operating the recorder.**

You can operate the recorder once the front panel display lights up and the recorder enters standby mode.

If you connect additional equipment to this recorder (page 26), be sure to connect the mains lead after all connections are complete.

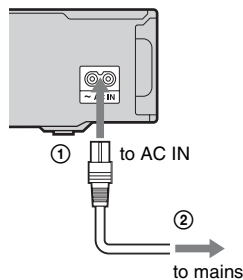

## Step 5: Preparing the Remote

You can control the recorder using the supplied remote. Insert two R6 (size AA) batteries by matching the ⊕ and ⊖ ends on the batteries to the markings inside the battery compartment. When using the remote, point it at the remote sensor  on the recorder.

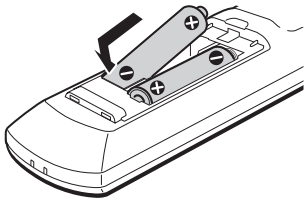

### Notes

- If the supplied remote interferes with your other Sony DVD recorder or player, change the command mode number for this recorder (page 23).
- Use the batteries correctly to avoid possible leakage and corrosion. Should leakage occur, do not touch the liquid with bare hands. Observe the following:
  - Do not use a new battery with an old battery, or batteries of different manufacturers.
  - Do not attempt to recharge the batteries.
  - If you do not intend to use the remote for an extended period of time, remove the batteries.
  - If battery leakage occurs, wipe out any liquid inside the battery compartment, and insert new batteries.
- Do not expose the remote sensor (marked  on the front panel) to strong light, such as direct sunlight or a lighting apparatus. The recorder may not respond to the remote.
- When you replace the batteries of the remote, the code number and Command Mode may be reset to the default setting. Set the appropriate code number and Command Mode again.

## Controlling TVs with the remote

You can adjust the remote's signal to control your TV.

### Notes

- Depending on the connected unit, you may not be able to control your TV with some or all of the buttons below.
- If you enter a new code number, the code number previously entered will be erased.

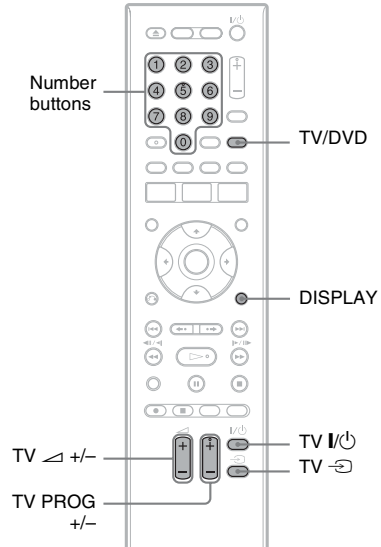

### 1 Hold down TV I/O located at the bottom of the remote.

Do not press the I/O button at the top of the remote.

### 2 With TV I/O pressed down, enter the TV's manufacturer code using the number buttons.



For instance, to enter "09," press "0" then "9." After you enter the last number, release the TV I/O button.

## Code numbers of controllable TVs

If more than one code number is listed, try entering them one at a time until you find the one that works with your TV.

Manufacturer	Code number
Sony	01 (default)
Hitachi	24
JVC	33
LG/Goldstar	76
Panasonic	17, 49
Philips	06, 08, 72
Samsung	71
Sharp	29
Toshiba	38

The remote performs the following:

Buttons	Operations
TV 	Turns your TV on or off.
TV  (volume) +/-	Adjusts the volume of your TV.
TV PROG +/-	Selects the programme position on your TV.
TV  (input select)	Switches your TV's input source.

## To operate the TV/DVD button (for SCART connections only)

The TV/DVD button switches between TV mode and DVD mode. Press the TV/DVD button when in stop mode or no menu appears on the TV screen. Point your remote at the recorder when using this button.

TV mode: switch to this when you use the TV's tuner mainly. When you start playback, the input source for the TV is set to the recorder automatically.

DVD mode: switch to this when you use the recorder's tuner mainly.

To check the current mode, press DISPLAY (page 36).

## If you have a Sony DVD player or more than one Sony DVD recorder

If the supplied remote interferes with your other Sony DVD recorder or player, set the command mode number for this recorder and the supplied remote to one that differs from the other Sony DVD recorder or player after you have completed "Step 6: Easy Setup."

The default command mode setting for this recorder and the supplied remote is "3 (Default setting)."

You can check the current Command Mode in the front panel display. For details, see page 115.

The default command mode setting for this recorder and the supplied remote is "3 (Default setting)."

The remote does not function if different command modes are set for the recorder and remote. Set the same command mode.

## Changing programme positions of the recorder using the remote

You can change programme positions of the recorder using the number buttons.

Example: for channel 50

Press "5," "0," then press ENTER.

## Step 6: Easy Setup

Make the basic adjustments by following the on-screen instructions in “Easy Setup.” Be careful not to disconnect the cables or exit the “Easy Setup” function during this procedure.

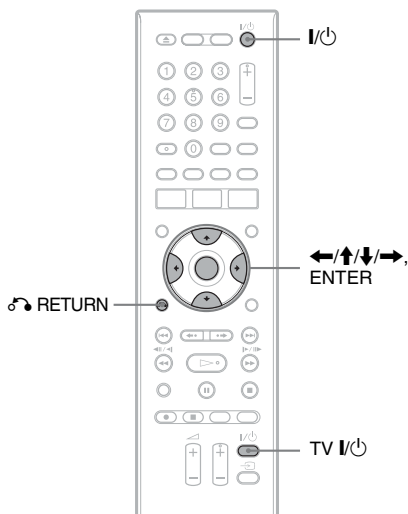

### 1 Turn on the recorder and your TV. Then switch the input selector on your TV so that the signal from the recorder appears on your TV screen.

The “Language” display appears.

- If the “Language” display does not appear, select “Easy Setup” in the “Basic” setup from “Initial Setup” in the System Menu (page 101).

### 2 Select a language for the on-screen displays using $\leftarrow/\uparrow/\downarrow/\rightarrow$ , and press ENTER.

The initial settings message appears.

### 3 Select “Start” using $\uparrow/\downarrow$ , and press ENTER.

Follow the on-screen instructions to make the following settings.

#### ◆ Auto Channel Setting

- If you connect a TV to this recorder not using SMARTLINK, select “Auto Scan.” Then select your country/region using  $\leftarrow/\rightarrow$ , and press ENTER. The programme position order will be set according to the country/region you select.
- If you connect a TV to this recorder with SMARTLINK, select “Download from TV.” Then select your country/region using  $\leftarrow/\rightarrow$ , and press ENTER. The tuner preset data will be downloaded from your TV to this recorder. (For details, refer to the operating instructions supplied with your TV.)
- To skip this setting, select “Do not set.”  
To set the programme positions manually, see page 102.

#### ◆ Clock Setting

- Select “Auto” when a programme position in your local area broadcasts a time signal. The “Auto Clock Setting” display appears.  
Select a programme position that carries a time signal and then “Start” using  $\leftarrow/\rightarrow/\downarrow$ , and press ENTER. If a clock signal cannot be found, press  $\hookrightarrow$  RETURN, and set the clock manually.
- Select “Manual” to set the clock manually. The “Manual Clock Setting” display appears.
  - 1 Select the time zone for your area or GMT (Greenwich Mean Time) using  $\leftarrow/\rightarrow$ , and press  $\downarrow$ .
  - 2 Select “On” using  $\leftarrow/\rightarrow$  if you are now on summer time, and press ENTER.
  - 3 Set the day, month, year, hour and minutes using  $\leftarrow/\uparrow/\downarrow/\rightarrow$ , and press ENTER to start the clock.

#### ◆ TV Type (page 111)

- If you have a wide-screen TV, select “Wide (16:9).”
- If you have a standard TV, select “Standard (4:3).” This will determine how “wide-screen” images are displayed on your TV.



**◆ Progressive**

When you connect a progressive format TV to this recorder using the COMPONENT VIDEO OUT jacks, select “Compatible.”

**◆ HDD caution messages**

Read the HDD caution messages, and press ENTER.

**4 Select “Finish Setup” using /, and press ENTER.**

“Easy Setup” is completed.

---

**To return to the previous step**

Press  RETURN.

** Hint**

If you want to run “Easy Setup” again, select “Easy Setup” in the “Basic” setup from “Initial Setup” in the System Menu (page 101).

# Connecting a VCR or Similar Device

After disconnecting the recorder's mains lead from the mains, connect a VCR or similar recording device to the LINE IN jacks of this recorder.

Use the DV IN jack on the front panel if the equipment has a DV output jack (i.LINK jack) (page 74).

For details, refer to the instruction manual supplied with the connected equipment.

To record on this recorder, see "Recording from Connected Equipment" on page 47.

## Connecting to the LINE 1/DECODER jack

Connect a VCR or similar recording device to the LINE 1/DECODER jack of this recorder.

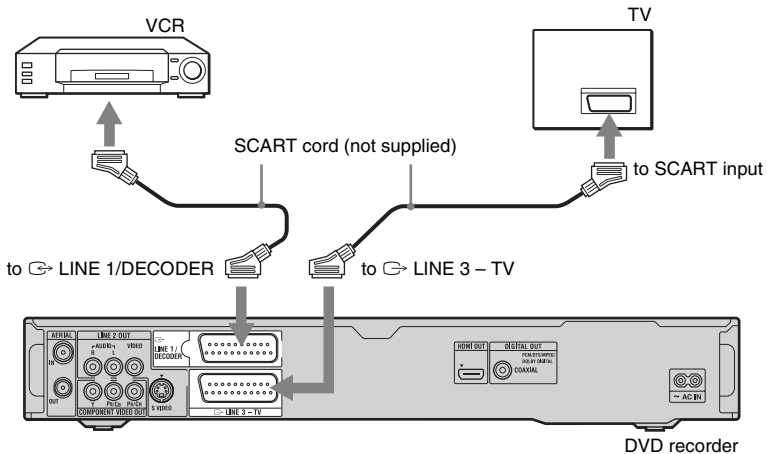

### Notes

- Pictures containing copy protection signals that prohibit any copying cannot be recorded.
- If you pass the recorder signals through a VCR, you may not receive a clear image on your TV screen.

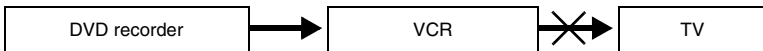

Be sure to connect your VCR to the DVD recorder and to your TV in the order shown below. To watch video tapes, watch the tapes through a second line input on your TV.

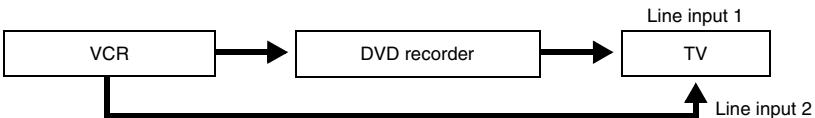

- The SMARTLINK features are not available for devices connected via the DVD recorder's LINE 1/DECODER jack.
- To watch the connected VCR or similar device's pictures through the recorder while the recorder is in standby mode, set "Power Save" to "Off" (default) in the "Basic" setup (page 101).
- When you record to a VCR from this DVD recorder, do not switch the input source to TV by pressing the TV/DVD button on the remote.
- If you disconnect the recorder's mains lead, you will not be able to view the signals from the connected VCR.

## Connecting to the LINE 2 IN jacks on the front panel

Connect a VCR or similar recording device to the LINE 2 IN jacks of this recorder. If the equipment has an S-video jack, you can use an S-video cord instead of an audio/video cord.

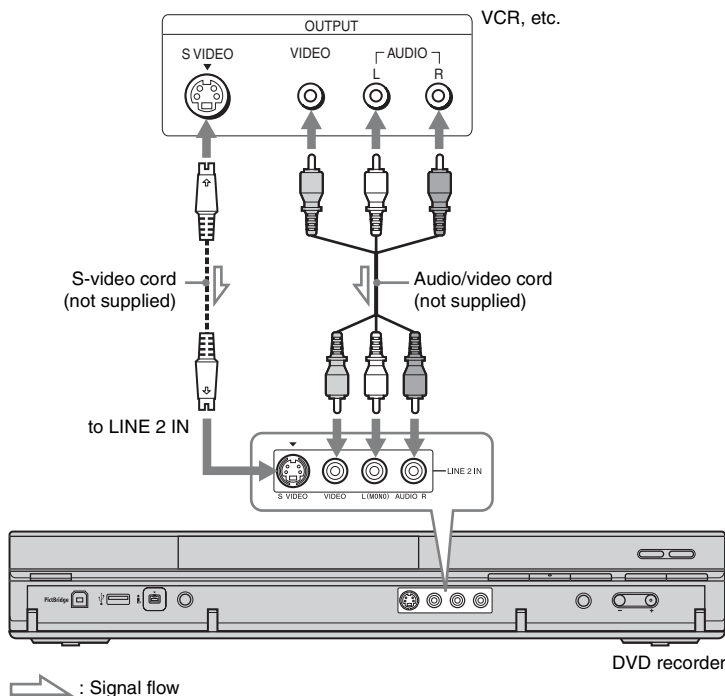

### **Hint**

When the connected equipment outputs only monaural sound, connect to only the L(MONO) and VIDEO input jacks on the front of the recorder. Do not connect the R input jack.

### **Notes**

- Do not connect the yellow LINE IN (VIDEO) jack when using an S-video cord.
- Do not connect the output jack of this recorder to another equipment's input jack with the other equipment's output jack connected to the input jack of this recorder. This may cause noise (feedback).
- Do not connect more than one type of video cord between the recorder and your TV at the same time.

## Connecting to a Satellite or Digital Tuner

Connect a satellite or digital tuner to this recorder using the LINE 1/DECODER jack.

Disconnect the recorder's mains lead from the mains when connecting the tuner.

To use the Synchro Rec function, see below.

Do NOT set "LINE 1 In" to "Decoder" in the "Video In/Out" setup (page 106) when making this connection.

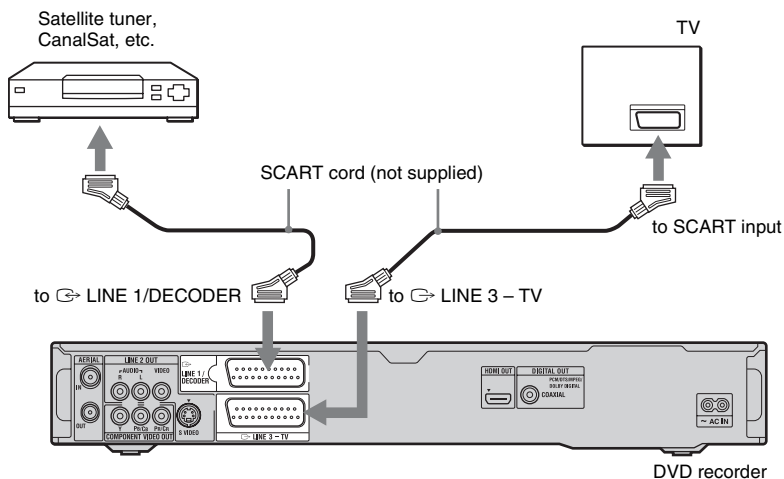

### If the satellite tuner can output RGB signals

This recorder accepts RGB signals. If the satellite tuner can output RGB signals, connect the TV SCART connector on the satellite tuner to the LINE 1/DECODER jack, and set "LINE 1 In" to "RGB" in the "Video In/Out" setup (page 106). Refer to the instructions supplied with the set top box receiver.

### If you want to use the Synchro Rec function

This connection is necessary to use the Synchro-Recording function. See "Recording from connected equipment with a timer (Synchro Rec.)" on page 47. Set "LINE 1 In" in the "Video In/Out" setup (page 106) according to the specifications of your satellite tuner. Refer to your satellite tuner's instructions for more information.

### Notes

- Synchro-Recording does not work with some tuners. For details, refer to the tuner's operating instructions.
- If you disconnect the recorder's mains lead, you will not be able to view the signals from the connected tuner.

# Connecting an External Decoder

You can watch or record external decoder (PAY-TV/Canal Plus analogue decoder) programmes if you connect a decoder (not supplied) to the recorder. Disconnect the recorder's mains lead from the mains when connecting the decoder. Note that when you set "LINE 1 In" to "Decoder" in step 7 of "Setting external decoder (PAY-TV/Canal Plus analogue decoder) programme positions" (page 30), you will not be able to select "L1" because Line 1 will become a dedicated line for the decoder.

## Connecting a decoder

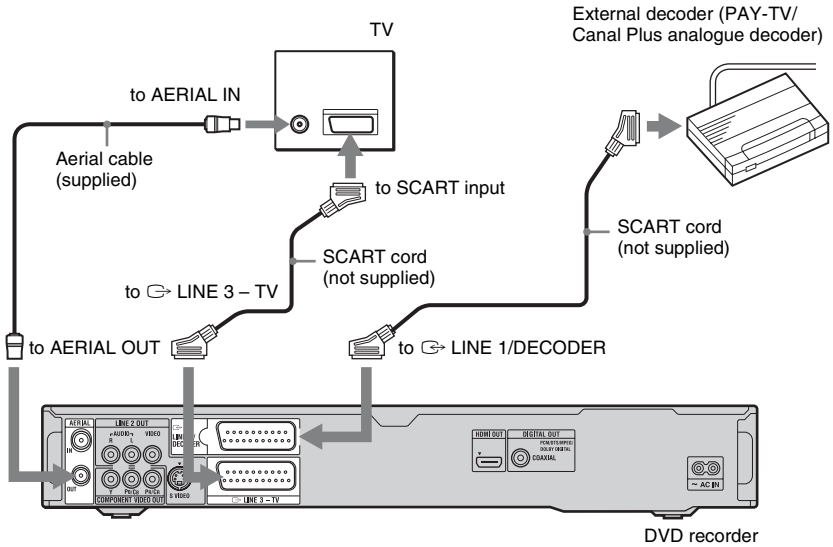

## Setting external decoder (PAY-TV/Canal Plus analogue decoder) programme positions

To watch or record PAY-TV/Canal Plus analogue programmes, set your recorder to receive the programme positions using the on-screen display.

In order to set the programme positions correctly, be sure to follow all of the steps below.

- 1 Press SYSTEM MENU.**  
The System Menu appears.
- 2 Select "Initial Setup," and press ENTER.**
- 3 Select "Video In/Out," and press ENTER.**
- 4 Select "LINE 3 Out," and press ENTER.**

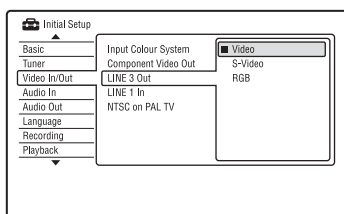

- 5 Press  $\uparrow/\downarrow$  to select "Video" or "RGB," and press ENTER.**
- 6 Select "LINE 1 In," and press ENTER.**
- 7 Press  $\uparrow/\downarrow$  to select "Decoder," and press ENTER.**
- 8 Press  $\curvearrowright$  RETURN to return the cursor to the left column.**
- 9 Select "Tuner," and press ENTER.**
- 10 Select "Manual CH Setting," and press ENTER.**
- 11 Select "Next Screen," and press ENTER.**

- 12 Select your country/region, and press ENTER.**

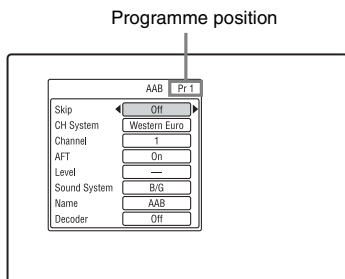

- 13 Select the desired programme position using PROG +/- or number buttons.**
- 14 Select "Channel" using  $\uparrow/\downarrow$ , and select the external decoder programme position using  $\leftarrow/\rightarrow$ .**
- 15 Select "Sound System" using  $\uparrow/\downarrow$ , and select an available TV system, B/G, D/K, I, or L using  $\leftarrow/\rightarrow$ .**  
To receive broadcasts in France, select "L."
- 16 Select "Decoder" using  $\uparrow/\downarrow$ , and select "On" using  $\leftarrow/\rightarrow$ .**
- 17 Press SYSTEM MENU to exit the menu.**

### To return to the previous step

Press  $\curvearrowleft$  RETURN.

### Notes

- If you disconnect the recorder's mains lead, you will not be able to view the signals from the connected decoder.
- To watch the connected external decoder (PAY-TV/Canal Plus analogue decoder) programmes during recording, press the PROGRAM + button on the recorder ("SCART THRU" appears on the front panel display). To return to the previous display, press the PROGRAM - button on the recorder ("SCART NORM" appears on the front panel display). The recorder automatically switches to the programme tuned by the recorder's tuner after the recording has finished. To watch the connected external decoder (PAY-TV/Canal Plus analogue decoder) programmes while the recorder is in standby mode, set "Power Save" to "Off" (default) in the "Basic" setup (page 101).

## Seven Basic Operations

— Getting to Know Your DVD Recorder

### 1. Inserting a Disc

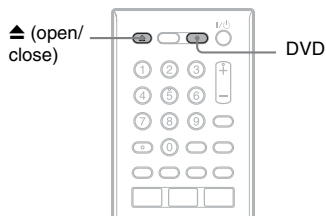

- 1 Press **DVD**.
- 2 Press **▲ (open/close)**, and place a disc on the disc tray.

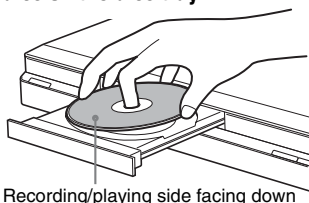

- 3 Press **▲ (open/close)** to close the disc tray.

Wait until “LOAD” disappears from the front panel display.

Unused DVDs are formatted automatically.

- For DVD-RW discs  
DVD-RWs are formatted in the recording format (VR mode or Video mode) set by “Format DVD-RW” of “Basic” in the “Disc Setup” setup (page 99).
- For DVD-R discs  
DVD-Rs are automatically formatted in Video mode. To format an unused DVD-R in VR mode, format the disc in the “Format” setup (page 42) **before** you make a recording.

If the disc is recordable on this recorder, you can manually re-format the disc to make a blank disc (page 42).

### 2. Recording a Programme



This section introduces the basic operation to record a current TV programme to the hard disk (HDD) or to a disc (DVD). For an explanation of how to make timer recordings, see page 43.

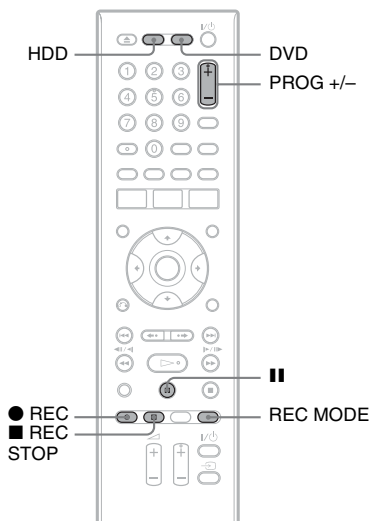

- 1 Press **HDD** or **DVD**.  
If you want to record to a DVD, insert a recordable DVD.
- 2 Press **PROG +/-** to select the programme position or input source you want to record.

### 3 Press REC MODE repeatedly to select the recording mode.

Each time you press the button, the display on the TV screen changes as follows:

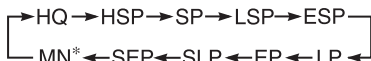

\* Available when “Manual Rec. Mode” is set to “On (go to setup)” in the “Recording” setup (page 110).

For more details about the recording mode, see page 128.

### 4 Press ● REC.

Recording starts.

#### To stop recording

Press ■ REC STOP.

#### To pause recording

Press ■■.

To resume recording, press ■■ again.

#### To watch another TV programme while recording

If your TV is connected to the ⇨ LINE 3 – TV jack, set your TV to the TV input using the TV/DVD button and select the programme you want to watch. If your TV is connected to the LINE 2 OUT or COMPONENT VIDEO OUT jacks, set the TV to TV input using the TV ⇨ button (page 22).

#### TV Direct Rec. (for SMARTLINK connections only)

When the TV is turned on and the recorder is turned off, press TV PAUSE. The recorder automatically turns on and starts recording what you are watching on the TV to the HDD.

Set “TV Pause” to “TV’s Tuner” in the “Options 2” setup (page 117).

#### Notes

- To turn off the TV Direct Rec. function, set “SMARTLINK” to “Pass Through” in the “Options” setup (page 116).
- Some buttons, such as the TITLE LIST button or ▷ button, do not work when “TV” appears in the front panel display.
- If you press the I/⏸ button while recording, the recorder stops recording and turns off.
- After pressing the ● REC button, it may take a short while to start recording.
- It may take a short while for recorder to stop or pause recording.
- You cannot change the recording mode while recording.
- Programmes are recorded in the following aspect ratio.
  - In the original aspect ratio, when recording to the HDD (when “HDD Recording Format” is set to “Video Mode Off” in the “Recording” setup (page 111))/DVD-RWs/DVD-Rs (VR mode).
  - In 4:3 when recording to DVD+RWs/DVD+Rs.
- When recording to DVD-R DLs (Video mode), the title is divided when the layer switches.
- If there is a power failure, the programme you are recording may be erased.
- You cannot watch a PAY-TV/Canal Plus programme while recording another PAY-TV/Canal Plus programme.
- To use the TV Direct Rec. function, you must first correctly set the recorder’s clock.



## Checking the disc status while recording

You can check the recording information such as recording time or disc type.

### Press DISPLAY during recording.

The recording information appears.

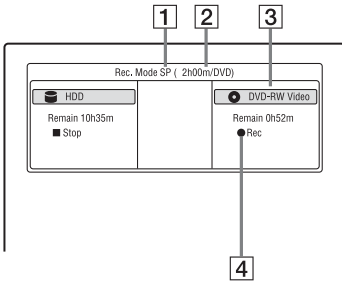

- 1 Recording mode
- 2 Recording time
- 3 Disc type/format
- 4 Recording status

### To turn off the display

Press DISPLAY repeatedly.

## 3. Playing the Recorded Programme (Title List)



To play a recorded title, select the title from the Title List.

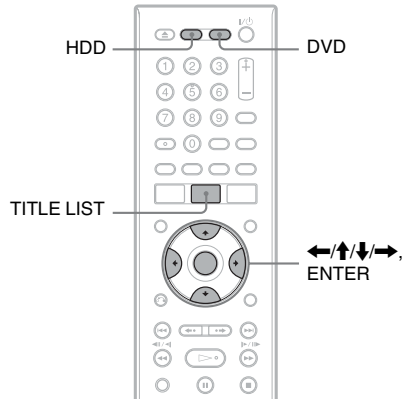

### 1 Press HDD or DVD.

If you select DVD, insert a DVD (see "1. Inserting a Disc" on page 31). Playback starts automatically depending on the disc.

### 2 Press TITLE LIST.

Example: 4-Title List for HDD

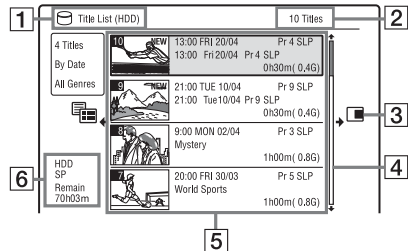

- 1 Disc type:  
Displays the media type, HDD or DVD.
- 2 Total number of titles
- 3 Sub-menu:  
Press **→** to display the sub-menu.  
The sub-menu displays options applicable only to the selected item. The displayed options differ depending upon the model, situation, and disc type.

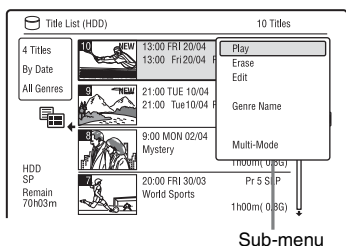

- 4 Scroll bar:  
Appears when all of the titles do not fit on the list. To view the hidden titles, press **↑/↓**.
  - 5 Title information:  
"Recording": Indicates that the title is currently being recorded.  
🔒: Indicates protected title.  
"NEW": Indicates that the title is newly recorded (not played back) (HDD only).  
COPY: Press DISPLAY to display "COPY". "COPY" indicates titles containing "Copy-Once" copy protection signals (HDD only) (page 131).  
🔄: Indicates that the title is recorded using the Update function.  
Genre icons: Indicates the title's genre (HDD only).
  - 6 Remaining time of the current disc in the current recording mode (example: SP mode)
- 3 Select a title using **↑/↓**, and press ENTER.**  
Playback starts from the selected title.

**To stop playback**  
Press **■** (stop).

**To scroll the list display by page (Page mode)**  
Press **◀◀/▶▶** while the Title List is displayed. Each time you press **◀◀/▶▶**, the Title List changes to the previous/next page of titles.

### About the Title List for DVD-RWs/DVD-Rs (VR mode)

You can switch the Title List to show Original or Playlist titles.

- 1 Press **←** while the Title List is displayed.
- 2 Select "Play List" using **↑/↓**, and press ENTER.
- 3 Select "Original" or "Play List" using **↑/↓**, and press ENTER.

### To change the title order for HDD (Sort Titles)

- 1 Press **←** while the Title List is displayed.
- 2 Select "Sort Titles" using **↑/↓**, and press ENTER.
- 3 Select the item using **↑/↓**, and press ENTER.

Order	Sorted
By Date	In order of when the titles were recorded. The title that is recorded most recently is listed at the top.
Unseen Title	In order of when the titles were recorded. The title that is recorded most recently and has not been played is listed at the top.
By Title	In alphabetical order.
By Number	In order of recorded title number.

**To search for a title by genre (HDD only)**

- 1 Press **←** while the Title List is displayed.
- 2 Select “Genre” using **↑/↓**, and press ENTER.
- 3 Select a genre using **↑/↓**, and press ENTER.

**To change a title thumbnail picture (Thumbnail)**

After recording, the first scene of the recording (the title) is automatically set as the thumbnail picture.

You can select a favourite scene for the thumbnail picture shown in the Title List.

- 1 Press TITLE LIST.  
For DVD-RWs/DVD-Rs (VR mode), switch the Title List to show Original or Playlist titles, if necessary.
- 2 Select a title using **↑/↓**, and press **→**.  
The sub-menu appears.
- 3 Select “Edit” using **↑/↓**, and press ENTER.
- 4 Select “Set Thumbnail” using **↑/↓**, and press ENTER.  
The display for setting the thumbnail point appears and the title starts to play.
- 5 While watching the playback picture, press **▷**, **⏏**, **◀◀**, **◀**, **▶**, **▶▶** or PLAY MODE to select the scene you want to set for a thumbnail picture, and press **⏏**.  
Playback pauses.
- 6 Select “OK” using **↑/↓**, and press ENTER.  
The scene is set for the title’s thumbnail picture.  
To return to the Title List, press **↶** RETURN.

**To change the thumbnail preview mode (Set Preview) (HDD only)**

You can select “Quick Preview” or “Normal” for the thumbnail preview mode in the Title List. Set “Set Preview” in the “Options” setup (page 116).

**To switch to the 8 Title List**

- 1 Press **←** while the Title List is displayed.
- 2 Select “Title View” using **↑/↓**, and press ENTER.
- 3 Select “8 Titles” using **↑/↓**, and press ENTER.

Detailed information, including the resumption time, for the selected title is shown below the list.

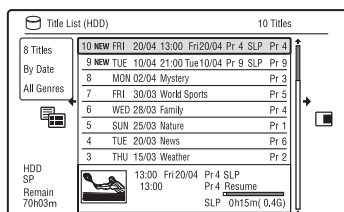
**To turn off the Title List**

Press TITLE LIST.

**Notes**

- The title names may not appear for DVDs created on other DVD recorders.
- It may take a few seconds for the thumbnail pictures to be displayed.
- After editing, the title thumbnail picture may change to the first scene of the recording (title).
- After dubbing, the title thumbnail picture set on the source recording is cancelled.
- When the Title List does not appear by pressing the TITLE LIST button, the DVD has no Title List. In this case, try pressing the TOP MENU button to display the DVD’s menu.

## Displaying the playing time and play information

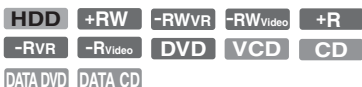

You can check the playing time of the current title, chapter, track, or disc. Also, you can check the disc name recorded on the DVD/CD.

### Press DISPLAY repeatedly.

The displays differ depending on the disc type or playing status.

### In stop mode

Example: DVD-RW in VR mode

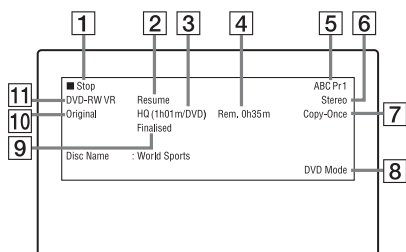

### During playback

Example: DVD-R in Video mode

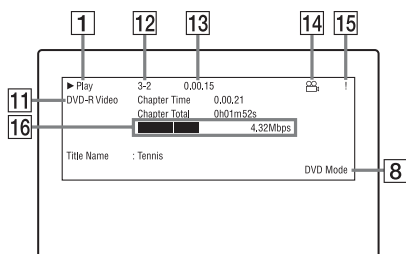

- 1 Playing status
- 2 Shows that the Resume Play is available (page 50).
- 3 Current selected recording mode (maximum DVD recording time) (page 128)
- 4 Remaining time

- 5 Station name and programme position number
- 6 Audio setting for the current programme
- 7 Recording restrictions for the current programme
- 8 TV mode or DVD mode (page 23)
- 9 Disc information
- 10 Title type (Original or Playlist) for DVD-RW/DVD-R in VR mode
- 11 Disc type/format (page 125)  
Displays the finalised disc in Video mode as "DVD-VIDEO."
- 12 Title number-Chapter number (page 56)
- 13 Playing time
- 14 Multi-angles indicator (page 51)
- 15 Copy-protected indicator (page 131)
- 16 Data transfer bar and rate

### To turn off the display

Press DISPLAY repeatedly.

### ⚙️ Hints

- When "On Screen Display" is set to "On" (default) in the "Options" setup (page 115), information automatically appears on the screen when the recorder is operated.
- To increase disc space, see "To open up disc space" (page 58).

### 📌 Note

Playing time of MP3 audio tracks may not be displayed correctly.

## 4. Changing the Name of a Recorded Programme



You can label a DVD, title, or programme by entering characters. You can enter up to 64 characters for a title recorded in the HDD/DVD-RW/DVD-R (VR mode), 40 characters for a title recorded in the DVD+RW/DVD-RW (Video mode)/DVD+R/DVD-R (Video mode), but the actual number of characters displayed in the menus such as the Title List will vary. The steps below explain how to change the name of the recorded programme.

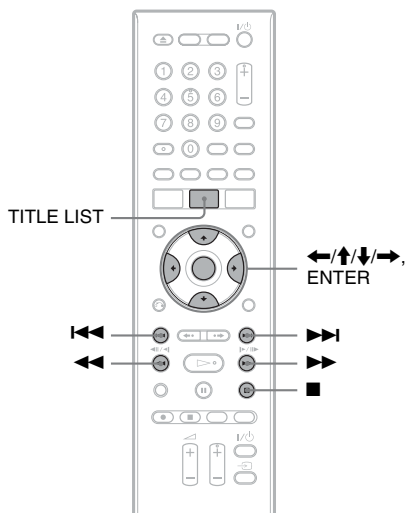

- 1 Press **TITLE LIST**.
- 2 Select a title using **↑/↓**, and press **→**.  
The sub-menu appears.
- 3 Select **"Edit"** using **↑/↓**, and press **ENTER**.

- 4 Select **"Title Name"** using **↑/↓**, and press **ENTER**.

The display for entering characters appears.

The current name is displayed at the input row.

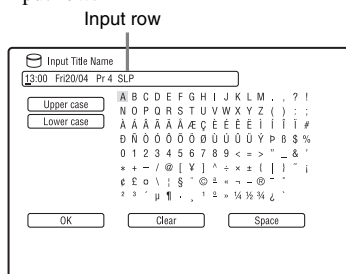

- 5 Move the cursor to the point where you want to insert the character using **←/→**.

To erase all of the characters, press and hold **CLEAR** for 2 seconds or more.

- 6 Select **"Upper case"** or **"Lower case"** using **←/→**.

The characters for the selected type are displayed.

- 7 Press **←/↑/↓/→** to select the character you want to enter, and press **ENTER**.

The selected character appears at the input row.

To insert a space, press **||** (or select **"Space,"** and press **ENTER**).

- 8 Repeat steps 6 and 7 to enter the remaining characters.

To erase a character, move the cursor to the character at the input row, and press **CLEAR** (or select **"Clear,"** and press **ENTER**).

To insert a character, move the cursor to the right of the point where you want to insert the character. Then select the character, and press **ENTER**.

To erase all of the characters, press and hold **CLEAR** for 2 seconds or more.

- 9 Press **■** (or select **"OK,"** and press **ENTER**).

To cancel the setting, press **↶** RETURN.

## 5. Labelling and Protecting a Disc

You can execute options effective for the entire disc in the “Disc Setup” setup.

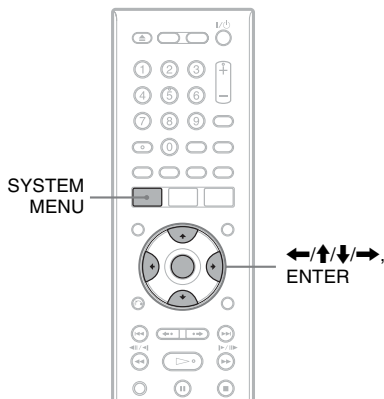

### Labelling a disc



- 1 Insert a disc.**  
See “1. Inserting a Disc” on page 31.
- 2 Press SYSTEM MENU.**  
The System Menu appears.
- 3 Select “Disc Setup,” and press ENTER.**

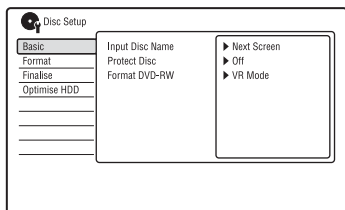

- 4 Select “Basic,” and press ENTER.**

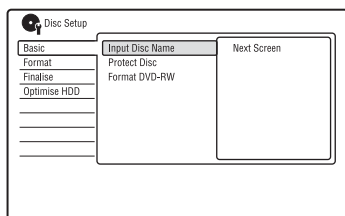

- 5 Select “Input Disc Name,” and press ENTER.**
- 6 Select “Next Screen,” and press ENTER.**

Enter the disc name (page 37).  
You can enter up to 64 characters for a DVD-RW/DVD-R (VR mode) disc name, and 40 characters for a DVD+RW/DVD-RW (Video mode)/DVD+R/DVD-R (Video mode) disc name.

### Note

The disc name may not appear when the disc is played on other DVD equipment.

### Protecting a disc



- 1 Insert a disc.**  
See “1. Inserting a Disc” on page 31.
- 2 Press SYSTEM MENU.**  
The System Menu appears.
- 3 Select “Disc Setup,” and press ENTER.**

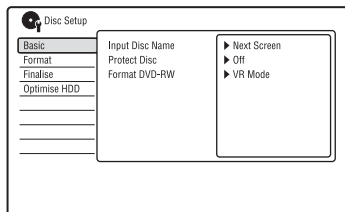

## 4 Select “Basic,” and press ENTER.

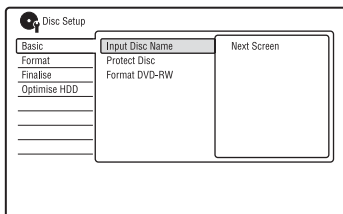

## 5 Select “Protect Disc,” and press ENTER.

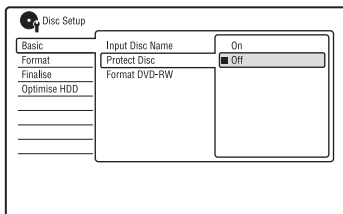

## 6 Select “On,” and press ENTER.

## 7 Press SYSTEM MENU to exit.

### To cancel the protection

Select “Off” in step 6.

#### Hint

You can set protection for individual titles (page 59).

## 6. Playing the Disc on Other DVD Equipment (Finalise)



Finalising is necessary when you play discs recorded with this recorder on other DVD equipment.

When you finalise a DVD+RW, DVD-RW (Video mode), DVD+R, or DVD-R (Video mode), a DVD menu will be automatically created, which can be displayed on other DVD equipment.

Before finalising, check the differences between the disc types in the table below.

### Differences between disc types

**+RW** Discs are automatically finalised when removed from the recorder. However, you may need to finalise the disc for certain DVD equipment, or if the recording time is short. You can edit or record on the disc even after finalising.

**-RWVR** Finalising is unnecessary when playing a disc on VR format compatible equipment. Even if your other DVD equipment is VR format compatible, you may need to finalise the disc, especially if the recording time is short. You can edit or record on the disc even after finalising.

**-RWVideo** Finalising is necessary when playing on any equipment other than this recorder. After finalising, you cannot edit or record on the disc. If you want to record on it again, unfinalise (page 41) or reformat the disc (page 42). However, if you reformat the disc, all recorded contents will be erased.

-RVR

Finalising is necessary. The disc can be played only on equipment that supports DVD-R in VR mode. You can edit or record on the disc even after finalising (except DVD-R DL in VR mode).

+R

-RVideo

Finalising is necessary when playing on any equipment other than this recorder. After finalising, you cannot edit or record on the disc.

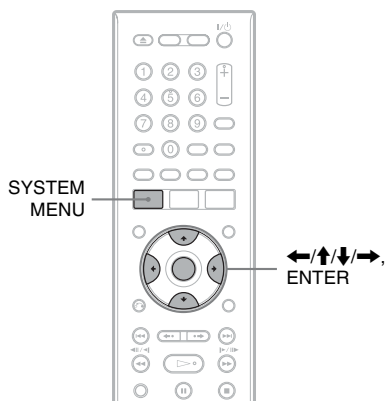

- 1** Insert a disc.  
See "1. Inserting a Disc" on page 31.
- 2** Press **SYSTEM MENU**.  
The System Menu appears.
- 3** Select "Disc Setup," and press **ENTER**.

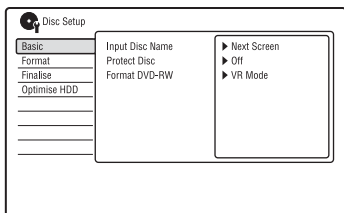

- 4** Select "Finalise," and press **ENTER**.

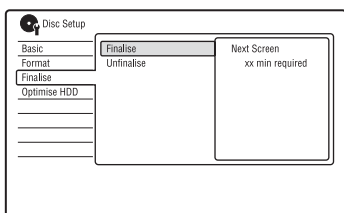

- 5** Select "Finalise," and press **ENTER**.

- 6** Select "Next Screen," and press **ENTER**.

For DVD-RW/DVD-R (VR mode), the recorder starts finalising the disc. Go to step 9.

- 7** (DVD+RW/DVD-RW (Video mode)/DVD+R/DVD-R (Video mode) only) Select a title menu style, and press **ENTER**.

The menu appears in the selected title menu style when the "top menu" (or "menu" for a DVD+RW/DVD+R) is selected on the DVD equipment.

- 8** (DVD+RW/DVD-RW (Video mode)/DVD+R/DVD-R (Video mode) only) Select "Yes," and press **ENTER**.

The recorder starts finalising the disc.

- 9** Press **SYSTEM MENU** to exit.

#### Hint

You can check whether the disc has been finalised or not. Press **DISPLAY** after step 1 (page 36).

#### Notes

- Depending on the condition of the disc, recording, or the DVD equipment, discs may not play even if the discs are finalised.
- The recorder may not be able to finalise the disc if it was recorded on another recorder.
- Inserting an unfinalised disc into other DVD equipment may damage the recorded contents.
- When using a DVD+RW, you can edit or record on the disc even after finalising. However, the title menu will not be displayed. Finalise the disc again to display the title menu.



## Unfinalising a disc

-RWVR -RW<sub>video</sub>

### For DVD-RWs (Video mode)

DVD-RWs (Video mode) that have been finalised to prohibit additional recording or editing can be unfinalised to allow further recording or editing.

### For DVD-RWs (VR mode)

If you cannot record or edit on a DVD-RW (VR mode) that has been finalised with other DVD equipment, unfinalise the disc.

#### Note

The recorder is not able to unfinalise DVD-RWs (Video mode) that have been finalised on another recorder.

### 1 Insert a disc.

See “1. Inserting a Disc” on page 31.

### 2 Press SYSTEM MENU.

The System Menu appears.

### 3 Select “Disc Setup,” and press ENTER.

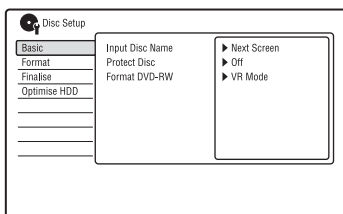

### 4 Select “Finalise,” and press ENTER.

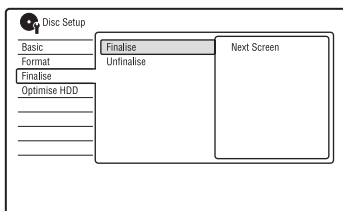

### 5 Select “Unfinalise,” and press ENTER.

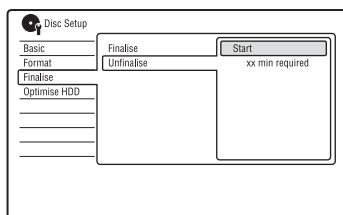

### 6 Select “Start,” and press ENTER.

The recorder starts unfinalising the disc. Unfinalising may take several minutes.

## 7. Reformatting a Disc

+RW   -RWVR   -RWVideo   -RVR   -RVideo

New discs are automatically formatted when inserted. If necessary, you can manually reformat a DVD+RW, DVD-RW, or DVD-R disc to make a blank disc. For DVD-RWs or DVD-Rs, you can select a recording format (VR mode or Video mode) according to your needs.

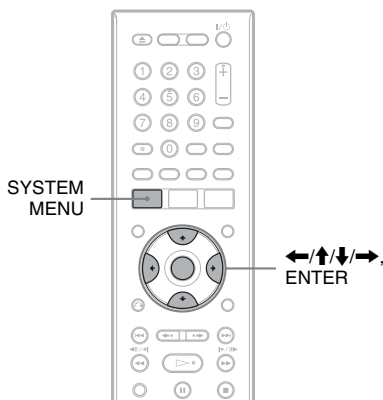

### 1 Insert a disc.

See "1. Inserting a Disc" on page 31.

### 2 Press SYSTEM MENU.

The System Menu appears.

### 3 Select "Disc Setup," and press ENTER.

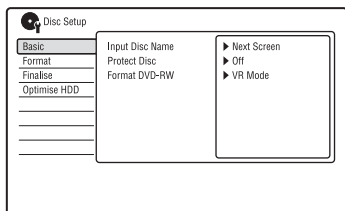

### 4 Select "Format," and press ENTER.

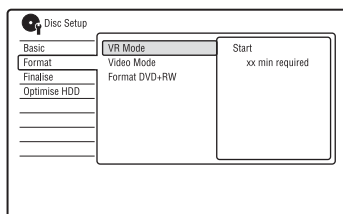

### 5 Select an item, and press ENTER.

"VR Mode": Formats DVD-RWs/DVD-Rs in VR mode.

"Video Mode": Formats DVD-RWs/DVD-Rs in Video mode.

"Format DVD+RW": Formats DVD+RWs.

### 6 Select "Start," and press ENTER.

All contents on the disc are erased.

#### Hint

By reformatting, you can change the recording format on DVD-RWs, or record again on DVD-RWs that have been finalised.

#### Note

You cannot reformat recorded DVD-Rs.

## Recording

## Timer Recording



You can set the timer for a total of 32 programmes (8 programmes when using the VPS/PDC function), up to 30 days in advance.

Set the date, time, and programme position of the programme manually.

## Before you start recording...

- Check that the disc has enough available space for the recording (page 36). For the HDD, DVD+RWs, and DVD-RWs, you can free up disc space by erasing titles (page 58).
- Adjust the recording picture quality if necessary (page 96).

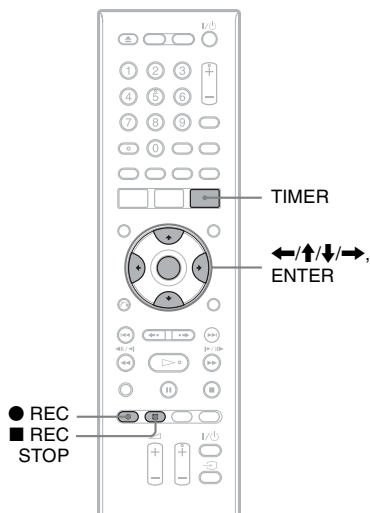
1 Press **TIMER**.

The “Timer List” display appears.

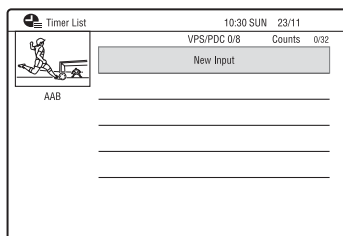
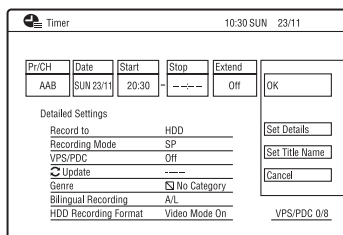
2 Select the “New Input” row, and press **ENTER**.3 Select an item using ←/→ and adjust using ↑/↓. Then press **ENTER**.

The adjustable items are listed below.

“Pr/CH”: Sets the programme position.

“Date”: Sets the date (up to 30 days later). Select a recording pattern by pressing ↑ repeatedly to set the timer for the same daily or weekly programmes.

“Start”: Sets the start time.

“Stop”: Sets the stop time.

“Extend”: Sets duration when a timer recording is in progress. If the programme set to be recorded daily or weekly is extended, the manually extended time set here will be added to the subsequent timer recording times. Note that when “VPS/PDC” is set to “On,” you cannot make the “Extend” setting.

- If you make a mistake, select the item and change the setting.

## 4 Select “OK,” and press ENTER.

The “Timer List” display appears (page 46).

The timer recording indicator lights up on the front panel display and the recorder is ready to start recording. Unlike a VCR, there is no need to turn off the recorder before the timer recording starts.

- To record a satellite programme, turn on the satellite tuner and select the satellite programme you want to record. Leave the satellite tuner turned on until the recorder finishes recording. If you connect equipment with a timer function, you can use the Synchro Rec function (page 47).

---

### To stop recording during timer recording

Press **■ REC STOP**.

Note that it may take a few seconds for the recorder to stop recording.

On-screen instructions may appear after pressing **■ REC STOP**. In this case, follow the on-screen instructions.

### To make the detailed settings

1 Select “Set Details” in step 3 above, and press ENTER.

2 Select an item using **↑/↓** and set using **←/→**.

“Record to”: Sets the recording destination. If there is not enough available DVD disc space for the recording, the recorder automatically records the programme to the HDD even if you select “DVD” (Recovery Recording).

“Recording Mode”: Sets the recording mode (page 128).

“VPS/PDC”: Sets the VPS/PDC function. See “About the VPS/PDC function” below.

“Update”: Sets the recorder automatically replacing the previous timer recording with the new one.

“Genre”: Sets the genre.

“Bilingual Recording”: Sets the sound to be recorded (page 107).

“HDD Recording Format”: Sets the recording format of HDD (page 111).

### To enter a title name

Select “Set Title Name” in step 3 above, and press ENTER (page 37).

### About the VPS/PDC function

VPS/PDC signals are transmitted with TV programmes in some broadcast systems. These signals ensure that timer recordings are made regardless of any broadcast delays, early starts, or broadcast interruptions.

#### ◆ To use the VPS/PDC function

Set “VPS/PDC” to “On” (see “To make the detailed settings” on page 44).

When you turn on this function, the recorder starts scanning the channels before the timer recording starts.

### Rec. Mode Adjust

If there is not enough available disc space for the recording, the recorder automatically adjusts the recording mode to enable the entire programme to be recorded. Set “Rec. Mode Adjust” to “On” in the “Recording” setup (page 110).

#### 💡 Hint

When you select “AUTO” for recording mode, the recorder automatically maximises the recording quality for the available DVD or HDD space.

#### 📌 Notes

- If a message indicating that the HDD is full appears on the screen, change the recording destination to “DVD,” or make available space for the recording (page 59).
- Check that the clock is correctly set before setting the timer recording. If not, the timer recording cannot be made.
- Even if the timer is set for the same daily or weekly programme, the timer recording cannot be made if it overlaps with a programme that has priority. “Overlap” will appear next to the overlapped setting in the Timer List. Check the priority order of the settings (page 46).
- Even if the timer is set, timer recordings cannot be made while recording a programme that has priority.
- The “Rec. Mode Adjust” function only works with a timer recording and the VPS/PDC function set to off. It does not function with Quick Timer or Synchro Rec.
- The beginning of some recordings may not be made when using the VPS/PDC function.
- The recording mode cannot be set to “AUTO” when “VPS/PDC” is set to “On.”

## Using the Quick Timer function

You can set the recorder to record in 30-minute increments.

### Press ● REC repeatedly to set the duration.

Each press advances the time in 30-minute increments. The maximum duration is six hours.

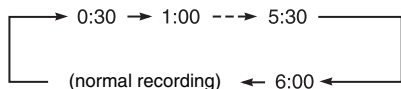

The time counter decreases minute by minute to 0:00, then the recorder stops recording (the power turns off).

### To cancel the Quick Timer

Press ● REC repeatedly until “0:00” appears in the front panel display. The recorder returns to normal recording mode. To stop recording, press ■ REC STOP.

### Note

If you turn off the recorder during recording, recording is stopped.

## Recording stereo and bilingual programmes

The recorder automatically receives and records stereo and bilingual programmes based on the ZWEITON system or the NICAM system.

The HDD (when “HDD Recording Format” is set to “Video Mode Off” in the “Recording” setup (page 111)) and a DVD-RW (VR mode) or DVD-R (VR mode) can record both main and sub sounds. You can switch between main and sub when playing the disc.

The HDD (when “HDD Recording Format” is set to “Video Mode On” in the “Recording” setup (page 111)) and a DVD+RW, DVD+R, DVD-RW (Video mode), or DVD-R (Video mode) can record only one sound track (main or sub) at a time.

Before recording starts, set “Bilingual Recording” to “A/L” (default) or “B/R” in the “Audio In” setup (page 107).

About HDD Recording format, see page 111.

### ZWEITON (German stereo) system

When a stereo-based programme is received, “Stereo” appears.

When a bilingual ZWEITON-based programme is received, “L,” “R,” or “L+R” appears.

### NICAM system

To record a NICAM programme, be sure to set “NICAM Select” to “NICAM” (default) in the “Audio In” setup. If the sound is not clear when listening to NICAM broadcasts, set “NICAM Select” to “Standard” (page 106).

## Creating chapters in a title

The recorder can automatically divide a recording (a title) into chapters by inserting chapter marks. To select chapter mark intervals or disable this function, see “Auto Chapter (HDD/VR),” “Auto Chapter (Video),” or “Auto Chapter (DVD+R/+RW)” in the “Recording” setup (page 110). When recording to the HDD, a DVD-R (VR mode) or a DVD-RW (VR mode), you can edit chapter marks (page 61).

# Checking/Changing/ Cancelling Timer Settings (Timer List)

HDD +RW -RWVR -RWVideo +R  
-RVR -RVideo

You can check, change, or cancel timer settings using the Timer List.

## 1 Press **TIMER**.

The “Timer List” display appears. When all of the timer settings are not visible on the display, press **↑/↓** to view the hidden timer settings.

## 2 Select the timer setting you want to check/change/cancel, and press **→**.

The sub-menu appears.

## 3 Select an option, and press **ENTER**.

“Modify”:

Changes the timer setting.

Select an item using **←/→** and adjust using **↑/↓**. Select “OK,” and press **ENTER**.

Pr/CH	Date	Start	Stop	Extend	
DEF	SUN 23/11	20:30	21:30	Off	OK

Detailed Settings

Record to: HDD

Recording Mode: SP

VPS/PDC: Off

Update: ---

Genre:  No Category

Bilingual Recording: A/L

HDD Recording Format: Video Mode On

VPS/PDC 0/8

Buttons: Set Details, Set Title Name, Cancel

“Erase”:

Erases the timer setting. Select “Yes,” and press **ENTER**.

“Skip Once”:

Cancels the daily or weekly recordings only once. After cancelling the timer setting, “Skip Once” appears next to the timer setting in the Timer List.

To change or cancel the setting, repeat steps 2 and 3 above.

## When the timer settings overlap

- The programme that starts first has priority and the entire programme is recorded.
- After finishing the previous recording, the other recording starts with several tens-of-second’s delay (when the end-time of one recording and the start-time of another are the same).
- When the recordings start at the same time, only one of them will be recorded. Cancel the timer setting for the programme that you are not going to record.

## Hint

You can move to the first row/bottom row of the Timer List using **◀◀/▶▶** while the list is displayed.

## Notes

- When “VPS/PDC” is set to “On” for one or more timer recordings, the start times may change in the event of a broadcast delay or early start.
- Even if the timer is set, timer recordings cannot be made while recording a programme that has priority.

## Recording from Connected Equipment

### Recording from connected equipment with a timer (Synchro Rec.)

#### HDD

You can set the recorder to automatically record programmes from connected equipment that has a timer function (such as a satellite tuner). Connect the equipment to the LINE 1/DECODER jack of the recorder (page 28).

When the connected equipment turns on, the recorder starts recording a programme from the LINE 1/DECODER jack.

The recording destination is HDD only.

#### 1 Press REC MODE repeatedly to select the recording mode.

For details about recording mode, see page 128.

#### 2 Select the desired audio signal when recording a bilingual programme.

Set "External Audio" to "Bilingual" and "Bilingual Recording" to "A/L" or "B/R" in the "Audio In" setup (page 106). For details about the bilingual recording, see page 45.

#### 3 Set the timer on the connected equipment to the time of the programme you want to record, and turn it off.

#### 4 Press down ■ REC STOP on the recorder for more than 3 seconds.

The SYNCHRO REC indicator lights up in the front panel display and the recorder turns off. The recorder is ready to start Synchro-Recording.

You can also set the recorder to stand by for Synchro-Recording by setting "Synchro Rec." of "Timer Recording" to "Yes" from the System Menu.

#### To cancel Synchro Rec before recording starts

Press **I/O**.

The SYNCHRO REC indicator in the front panel display turns off.

#### To cancel Synchro Rec during recording

Press down ● REC for more than 3 seconds.

The Synchro Rec is cancelled, and the recording continues.

#### To stop recording

Press ■ REC STOP. Then select "Yes" in the confirmation display, and press ENTER.

#### Notes

- The recorder starts recording only after detecting a video signal from the connected equipment. The beginning of the programme may not be recorded.
- The Synchro Rec function does not work when "LINE 1 In" is set to "Decoder" in the "Video In/Out" setup (page 106).
- The Synchro Rec function does not work with some tuners. For details, refer to the tuner's operating instructions.
- While the recorder is standing by for Synchro-Recording, the Auto Clock Set function (page 100) does not work.
- To use the Synchro Rec function, you must first set the recorder's clock correctly.
- For a bilingual programme, only the audio signal selected in step 2 can be played back.

#### If the timer settings of a Synchro-Recording and another timer recording overlap

Timer recordings always have priority. The Synchro-Recording starts only after the timer recording has finished.

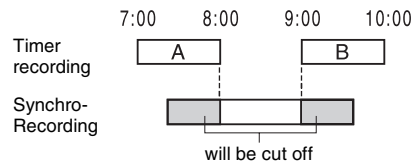

## Recording from connected equipment without a timer



You can record from a connected VCR or similar device. To connect a VCR or similar device, see “Connecting a VCR or Similar Device” on page 26.

### 1 Press **HDD** or **DVD**.

If you select DVD, insert a recordable DVD (see “1. Inserting a Disc” on page 31).

### 2 Press **INPUT** to select an input source according to the connection you made.

The front panel display changes as follows:

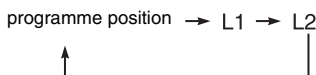

### 3 Select the desired audio signal when recording a bilingual programme to the **HDD** or **DVD+RWs/DVD+Rs/DVD-RWs/DVD-Rs (Video mode)**.

Set “External Audio” to “Bilingual” and “Bilingual Recording” to “A/L” or “B/R” in the “Audio In” setup (page 106).

### 4 Press **REC MODE** repeatedly to select the recording mode.

For details about the recording mode, see page 128.

### 5 Insert the source tape into the connected equipment and set to playback pause.

### 6 Press **● REC**.

This recorder starts recording.

### 7 Press the **pause (or play)** button on the connected equipment to cancel the playback pause status.

The connected equipment starts playback and the playback image is recorded by this recorder.

To stop recording, press **■ REC STOP** on this recorder.

### If you connect a **DV camcorder with a DV IN jack**

See “DV Camcorder Dubbing” on page 74.

### If you connect an **HDD camcorder with a USB jack**

See “HDD Camcorder Dubbing” on page 70.

### Notes

- When recording a video game image, the screen may not be clear.
- Any programme that contains a Copy-Never copy guard signal cannot be recorded.
- When “Bilingual Recording” is set to “A/L” or “B/R” in step 3, you cannot select the sound when playing in the following cases.
  - When recording to the HDD (“HDD Recording Format” is set to “Video Mode Off” in the “Recording” setup (page 111))/DVD-RW/DVD-R (VR mode) in PCM mode.
  - When recording to the HDD (“HDD Recording Format” is set to “Video Mode On” in the “Recording” setup (page 111))/DVD+RW/DVD+R/DVD-RW/DVD-R (Video mode).
- You cannot select “L1” in step 2 if “LINE 1 In” is set to “Decoder” in the “Video In/Out” setup (page 106).



# Playback

## Playing

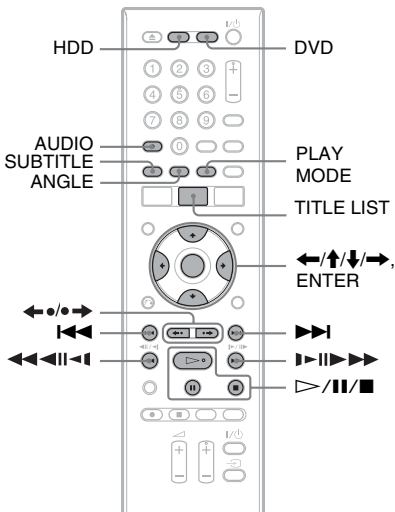

### 1 Press HDD or DVD.

- If you select DVD, insert a disc (see “1. Inserting a Disc” on page 31).
- If you insert a DVD VIDEO, VIDEO CD, DATA DVD or DATA CD, press  $\triangleright$ . Playback starts.

### 2 Press TITLE LIST.

If the Title List is already displayed, skip this step.  
Example: HDD

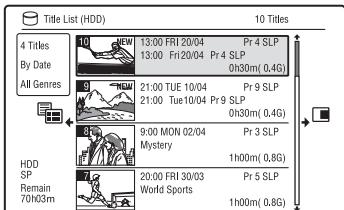

### 3 Select a title using $\uparrow/\downarrow$ , and press ENTER.

Playback starts from the selected title.

#### Hint

You can also use the  $\triangleright$  button in step 3 to start playback.

#### Note

When any video titles are recorded on a DATA DVD, the MP3 audio tracks on that DATA DVD cannot be played.

#### To use the DVD's Menu

When you play a DVD VIDEO, or a finalised DVD+RW, DVD-RW (Video mode), DVD+R, or DVD-R (Video mode), you can display the disc's menu by pressing TOP MENU or MENU.

#### Note

The  $\triangleright$  button is not available in the disc's menu.

#### To play VIDEO CDs/Super VIDEO CDs with PBC functions

PBC (Playback Control) allows you to play VIDEO CDs/Super VIDEO CDs interactively using the menu on your TV screen.

When you start playing a VIDEO CD/Super VIDEO CD with PBC functions, the menu appears.

Select an item using the number buttons, and press ENTER. Then, follow the instructions in the menu (press  $\triangleright$  when “Press SELECT” appears).

#### Note

Some playback options such as search, repeat play or programme play cannot be played with PBC function. To play with playback options, start playback without PBC functions using the Title List.

## To play DivX video files or audio tracks in a disc containing both file types

- 1 Press **←** while the Title List (DVD/CD) is displayed.
- 2 Select "Data Format" using **↑/↓**, and press **ENTER**.
- 3 Select "CD," "MP3" or "DivX" using **↑/↓**, and press **ENTER**.
- 4 Return to the Title List, then select an album, title or track, and press **ENTER** or **▷**.

## To stop playback

Press **■**.

## To resume playback from the point where you stopped (Resume Play)

When you press **▷** again after you stop playback, the recorder resumes playback from the point where you pressed **■**.

To start from the beginning, press **■** again, and press **▷**. Playback starts from the beginning of the title/track/scene.

### Notes

- You cannot resume playback during TV Pause.
- Resume Play is not available for Super VIDEO CDs.
- The point where you stopped playing is cleared from memory when:
  - you open the disc tray (except HDD).
  - you play another title (except HDD).
  - you start playback using the Title List (except HDD).
  - you edit the title after stopping playback.
  - you change the settings on the recorder.
  - you make a recording (except HDD).
  - you disconnect the mains lead.

## To play restricted DVDs (Parental Control)

If you play a restricted DVD, the display for entering your password appears on your TV screen.

Enter your four-digit password using the number buttons, and press **ENTER**.

The recorder starts playback.

To register or change the password, see "Parental Control (DVD VIDEO only)" on page 112.

## One-Touch Play (for SCART/HDMI connections only)

Press **▷**. With one touch of the **▷** button, the recorder and your TV automatically turn on and the TV's input is switched to the recorder. Playback starts automatically.











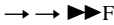
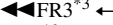
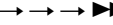
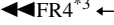
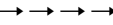

### Notes

- When using the HDMI connection, there may be a delay, before the playback picture appears on the TV screen, and the beginning portion of the playback picture may not be displayed.
- To use the One-Touch Play function, set "Control for HDMI" to "On" (default) in the "HDMI Output" setup (page 115).

## Playback options

To check the position of the buttons below, see the illustration on page 49.

Buttons	Operations
<b>ANGLE</b> 	Changes the angles for a scene when pressed during playback. When the disc has various angles (multi-angles) recorded, “” appears on the screen. To switch the angle mark indicator to off, set “Angle Indicator” to “Off” in the “Playback” setup (page 113).
<b>AUDIO</b>   	Selects one of the audio tracks recorded on the disc when pressed repeatedly in normal playback mode. <sup>*1</sup> <sup>*1</sup> : Selects the language. : Selects the main or sub sound. <sup>*2</sup> <sup>*2</sup> : Selects stereo or monaural audio tracks. <sup>*1</sup> DivX video file only <sup>*2</sup> MP3 audio track only
<b>SUBTITLE</b> <sup>*</sup> <sup>*</sup> * DivX video file only	Selects a subtitle language when pressed repeatedly.
(instant replay/instant advance)   <sup>*</sup> <sup>*</sup> * DivX video file only	Each time you press , replays the scene for the following duration. 5 seconds → 15 seconds → 30 seconds → 1 minute → 2 minutes → 3 minutes → 5 minutes → 10 minutes → 20 minutes → advances the time in 10-minute increments → 2 hours  Each time you press , briefly fast forwards the current scene for the following duration. 30 seconds → 1 minute → 1 minute 30 seconds → 2 minutes → 3 minutes → 5 minutes → 10 minutes → 20 minutes → advances the time in 10-minute increments → 2 hours
(previous)/ (next)	Goes to the beginning of the previous/next title/chapter/scene/track when pressed during playback. Goes to the beginning of the first title/track when pressed in stop mode.

Buttons	Operations
 (fast reverse/fast forward)	<p>Fast reverses/fast forwards the disc when pressed during playback.</p> <p>Search speed changes as follows:</p> <p style="text-align: center;"> fast reverse      fast forward   FR1*<sup>1</sup> ←      →  FF1*<sup>2</sup>   FR2 ← ←      → →  FF2   FR3*<sup>3</sup> ← ← ←      → → →  FF3*<sup>3</sup>   FR4*<sup>3</sup> ← ← ← ←      → → → →  FF4*<sup>3</sup> </p>
	<p>When you press and hold the button, fast forward/fast reverse continues at the selected speed until you release the button.</p>
	<p>*<sup>1</sup> When you press  once during playback, you can play Reverse play (not available for VIDEO CDs/Super VIDEO CDs/DivX video files/audio tracks).</p>
	<p>*<sup>2</sup> When you press  once during playback, you can play quickly with sound (Scan Audio) (not available for VIDEO CDs/Super VIDEO CDs).</p>
	<p>*<sup>3</sup> Not available for VIDEO CDs/Super VIDEO CDs/audio tracks.</p>
	<p>To resume normal playback, press .</p>
 (slow, freeze frame)	<p>Plays in slow motion when pressed for more than one second in pause mode.</p> <p>Plays one frame at a time when pressed briefly in pause mode.</p> <p>To resume normal playback, press .</p>
	
<p>*<sup>1</sup> Playback direction only  *<sup>2</sup> DivX video file only</p>	
 (pause)	<p>Pauses playback.</p> <p>To resume normal playback, press .</p>

### Notes

- Angles and subtitles cannot be changed with titles recorded on this recorder.
- JPEG image files made with a DVD camcorder can only be played as a slideshow. For video files containing JPEG image files and movies, the recorder can play movie parts only.

### Notes on playing DVDs with a DTS sound track

DTS audio signals are output only through the DIGITAL OUT (COAXIAL) jack.

When you play a DVD with DTS sound tracks, set “DTS Output” to “On” in the “Audio Out” setup (page 107).

### Notes on playing DTS sound tracks on a CD

- When playing DTS-encoded CDs, excessive noise will be heard from the LINE 3-TV/LINE 1/DECODER/LINE 2 OUT (R-AUDIO-L) jacks. To avoid possible damage to the audio system, the user should take proper precautions when the LINE 3-TV/LINE 1/DECODER/LINE 2 OUT (R-AUDIO-L) jacks of the recorder are connected to an amplification system. To enjoy DTS Digital Surround™ playback, an external DTS decoder must be connected to the DIGITAL OUT jack of the recorder.
- Set the sound to “Stereo” using the AUDIO button when you play DTS sound tracks on a CD (page 51).

## Playing a specific portion repeatedly (A-B Repeat)

### 1 Press PLAY MODE during playback.

For audio tracks on a CD, press **→** while the Title List is displayed, and select “Play Mode.”

The “Play Mode” menu appears.

### 2 Select “A-B Repeat,” and press ENTER.

“Set point A” is selected.

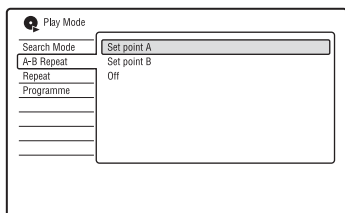

### 3 While monitoring the sound, press ENTER at the starting point (point A) of the portion to be played repeatedly.

“Set point B” is selected.

### 4 Continue playing to locate the ending point (point B), and press ENTER.

A-B Repeat starts.

### To cancel A-B Repeat

Press CLEAR. Or, set “A-B Repeat” to “Off” in the “Play Mode” menu.

### ⚡ Notes

- When playing an HDD/DVD VIDEO/DVD-RW (Video mode)/DVD-R (Video mode), set the start and stop points within the same title.
- “A-B Repeat” is not available for MP3 audio tracks.

## Playing repeatedly (Repeat)

You can repeatedly play all the titles/tracks/files or a single title/chapter/track on the HDD, a disc or an album.

### 1 Press PLAY MODE during playback.

For audio tracks on a DATA DVD/ DATA CD/CD, press **→** while the Title List is displayed, and select “Play Mode.”

The “Play Mode” menu appears.

### 2 Select “Repeat,” and press ENTER.

### 3 Select an item to be repeated using ↑/↓.

“Repeat Title” (for HDD/DVDs/DATA DVDs<sup>\*1</sup>/DATA CDs<sup>\*1</sup>): repeats the current title.

“Repeat Chapter” (for HDD/DVDs): repeats the current chapter.

“Repeat Track” (for VIDEO CDs<sup>\*2</sup>/CDs/DATA DVDs/DATA CDs): repeats the current track.

“Repeat Programme”: repeats the current programme (page 54).

“Repeat Disc” (for VIDEO CDs<sup>\*2</sup>/DVD-RWs/DVD-Rs (VR mode)/CDs/DATA DVDs/DATA CDs): repeats the entire disc.

“Repeat Album” (for DATA DVDs<sup>\*3</sup>/DATA CDs<sup>\*3</sup>): repeats the current album.

<sup>\*1</sup> DivX video file only

<sup>\*2</sup> Available only when playing without PBC functions

<sup>\*3</sup> Audio tracks only

### 4 Press ENTER.

Repeat play starts.

### To cancel Repeat play

Press CLEAR. Or, set “Repeat” to “Repeat Off” in the “Play Mode” menu.

### ⚡ Note

You can select “Repeat Programme” only during Programme play.

## Creating your own programme (Programme)



\*1 finalised disc only

\*2 MP3 audio tracks only

You can play the contents of the HDD or a disc in the order you want by arranging the order of the titles/chapters/albums/tracks on the HDD or disc to create your own programme. You can make a programme of up to 24 chapters/tracks, etc.

### 1 Press **PLAY MODE** during playback.

For audio tracks on a DATA DVD/DATA CD/CD, press **→** while the Title List is displayed, and select “Play Mode.”

The “Play Mode” menu appears.

### 2 Select “Programme,” and press **ENTER**.

### 3 Select “Input/Edit Programme,” and press **ENTER**.

The “Input/Edit Programme” display differs depending upon the disc type. Example: DVD

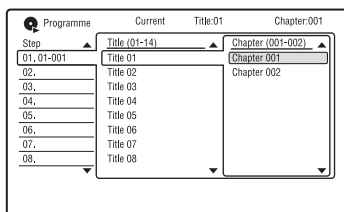

### 4 Select a title or album (example: Title 01) using **↑/↓**, and press **→**.

### 5 Select a chapter or track (example: Chapter 001) using **↑/↓**, and press **ENTER**.

The chapter or track is programmed.

If you make a mistake, select the step number (example: 01.) using **←/↑/↓**, and press **CLEAR**.

### 6 To programme other chapters or tracks, press **←/↑/↓/→** to select a step number, and repeat steps 4 and 5.

### 7 Press **▷**.

Programme play starts.

### To stop Programme play

Press **■** (stop).

### To cancel Programme play

Press **CLEAR** during playback. Or, set “Programme” to “Cancel Programme Play” in the “Play Mode” menu.

### To erase the programme

Press **CLEAR** in stop mode. Or, set “Programme” to “Erase Programme List” in the “Play Mode” menu.

### 🔧 Hints

- The programme you made remains after Programme play finishes. To play the same programme again, set “Programme” to “Start Programme Play” in the “Play Mode” menu. However, the programme is cleared after you remove the disc or press **⏏**.
- You can repeat Programme play. During Programme play, set “Repeat” to “Repeat Programme” in the “Play Mode” menu (page 53).

# Advanced Playback Functions

## Pausing a TV broadcast (TV Pause/Pause Live TV)

### HDD

You can pause a current TV broadcast, and record it on the HDD, then continue watching the programme at a later time. This is useful when you receive an unexpected phone call or visitor while watching TV. When connecting the recorder to your TV using the SCART jack, do the following.

- set “SMARTLINK” to “This Recorder Only” in the “Options” setup (page 116).
- set “TV Pause” to “TV’s Tuner” in the “Options 2” setup (page 117).
- preset programme positions by downloading from your TV using “Download from TV” of “Auto Channel Setting” in the “Tuner” setup (page 102).

If you do not make the SCART connection, set “TV Pause” to “Recorder’s Tuner” in the “Options 2” setup (page 117).

### 1 While viewing a TV broadcast, press TV PAUSE.

The picture pauses, and the recorder starts recording the current TV channel to the HDD.

It may take up to 10 seconds to start recording.

### 2 Press ▷ to resume watching the programme.

You can fast forward/fast reverse, pause, or stop the programme using ◀◀/▶▶, ⏸ and ■ without affecting the recording.

### 3 Press ■ REC STOP to stop recording.

### ⚙ Notes

- The picture does not pause and the recorder starts only recording in the following cases.
  - when the programme positions are preset differently between the recorder and the connected TV.
  - when watching the programme from the external equipment connected to your TV.
- The picture tuned by the recorder pauses when “TV Pause” is set to “Recorder’s Tuner” in the “Options 2” setup (page 117).
- You may not be able to use the “TV Pause” function depending on some TVs. For details, refer to the operating instructions supplied with your TV.
- The “TV Pause” function will not work correctly when watching TV via the connected component such as a VCR or digital tuner. The “TV Pause” function works only with the channel selected on the TV.
- You cannot use the “TV Pause” function as a recording feature from the component (VCR, etc.) connected to the LINE 1/DECODER jack.
- The “TV Pause” function will not work if the connected TV does not comply with SMARTLINK. To check whether your TV complies with SMARTLINK, refer to the operating instructions supplied with your TV.

## Playing from the beginning of the programme you are recording (Chase Play)

### HDD

“Chase Play” allows you to view the recorded part of a programme on the HDD while the recording is being made. You do not need to wait until the recording finishes.

### Press ▷ while recording.

Playback starts from the beginning of the programme you are recording.

When you fast forward to the point that you are recording, “Chase Play” returns to normal playback.

## Playing a previous recording while making another (Simultaneous Rec and Play)

HDD +RW -RWVR -RWVideo +R  
-RVR -RVideo DVD VCD DATA DVD  
DATA CD

“Simultaneous Rec and Play” allows you to view a previously recorded programme while recording programmes. Playback continues even if a timer recording starts. Use this function as follows:

- While recording to the HDD:  
Play another title on the HDD.  
Play a previously recorded programme on a DVD by pressing the DVD button.
- While recording to a DVD:  
Play a previously recorded programme on the HDD by pressing the HDD button.

You can also play a DVD VIDEO, VIDEO CD, Super VIDEO CD, DATA DVD, or DATA CD while recording on the HDD.

### Example: Play another title on the HDD while recording to the HDD.

- 1 While recording, press TITLE LIST to display the HDD Title List.
- 2 Select the title you want to play, and press ENTER.  
Playback starts from the selected title.

### Example: Play a DVD while recording to the HDD.

- 1 While recording, press DVD and insert the DVD into the recorder.
- 2 Press TITLE LIST to display the DVD Title List.
- 3 Select the title you want to play, and press ENTER.  
Playback starts from the selected title.

#### Note

You cannot play a DVD, DivX video or VIDEO CD recorded in the NTSC colour system while recording on the HDD in the PAL/SECAM colour system.

## Searching for a Time/Title/Chapter/Track, etc.

HDD +RW -RWVR -RWVideo +R  
-RVR -RVideo DVD VCD DATA DVD<sup>\*</sup>  
DATA CD<sup>\*</sup>

\* DivX video file only

You can search a disc by title, chapter, scene or track. As titles and tracks are assigned individual numbers, select the title or track by entering its number. You can also search for a scene using the time code.

- 1 Press **PLAY MODE** during playback. The “Play Mode” menu appears.
- 2 Select “Search Mode,” and press **ENTER**.
- 3 Select a search method, and press **ENTER**.

“Time Search” (for HDD/DVDs/DATA DVDs<sup>\*1</sup>/DATA CDs<sup>\*1</sup>/VIDEO CDs<sup>\*2\*3</sup>): Searches for a starting point by entering the time code.

“Title Search” (for HDD/DVDs/DATA DVDs<sup>\*1</sup>/DATA CDs<sup>\*1</sup>)

“Chapter Search” (for HDD/DVDs)

“Track Search” (for VIDEO CDs<sup>\*3</sup>)

<sup>\*1</sup> DivX video file only

<sup>\*2</sup> Except Super VIDEO CDs

<sup>\*3</sup> Available only when playing without PBC functions

The display for entering the number appears.

- 4 Press the number buttons to select the number of the title, chapter, time code, etc., you want.

For example: Time Search

To find a scene at 2 hours, 10 minutes, and 20 seconds, enter “21020.”

If you make a mistake, select another number.



## 5 Press ENTER.

Playback starts from the selected number.

---

### **Hint**

You can search for a title/track/chapter by entering the title/track/chapter number using the number buttons during playback.

## Before Editing

This recorder offers various edit options for various disc types.

### Notes

- You may lose the edited contents if you remove the disc or a timer recording starts while editing.
- DVD discs created by DVD camcorders cannot be edited on this recorder.
- If a message appears and indicates that the disc's control information is full, erase or edit unnecessary titles.
- The remaining disc space displayed on the screen may differ from the actual remaining disc space.
- When editing a DVD+R or DVD-R, finish all editing before finalising the disc. You cannot edit a finalised disc.

### To open up disc space

To open up disc space on a DVD+RW or DVD-RW (Video mode), erase the title with the largest number in the title list.

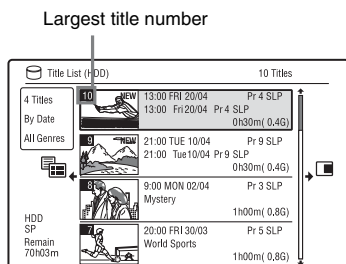

To open up disc space on the HDD or a DVD-RW (VR mode), you can erase any title.

See “Erasing and Editing a Title” on page 59.

For DVD-Rs and DVD+Rs, the available disc space does not increase even if you erase titles.

### To switch between the Playlist and Original Title List (DVD-RW/DVD-R in VR mode only)

You can display the Playlist titles in the Title List (Playlist), or the Original titles in the Title List (Original).

- 1 Press **←** while the Title List is displayed.
- 2 Select “Play List” using **↑/↓**, and press **ENTER**.
- 3 Select “Original” or “Play List” using **↑/↓**, and press **ENTER**.

### About editing accuracy

When editing the titles recorded on the HDD, you can select the type of editing. “Video Mode Compatible Editing”: Recommended if you are going to dub the titles to DVD-RWs/DVD-Rs (Video mode) or DVD+RWs/DVD+Rs afterward by High-speed dubbing. The editing points and chapter marks may be slightly different from those you selected.

“Frame Accurate Editing”:

Recommended when you want to edit titles precisely. However, the editing points may be slightly different from the point you selected when you dub the titles by High-speed dubbing.

# Erasing and Editing a Title



This section explains the basic edit functions. Note that editing is irreversible. To edit DVD-RWs/DVD-Rs (VR mode) without changing the original recordings, create a Playlist title (page 63).

## 1 Press TITLE LIST.

For DVD-RWs/DVD-Rs in VR mode, switch the Title List (Original or Playlist), if necessary.

## 2 Select a title, and press →.

The sub-menu appears.

## 3 Select an option, and press ENTER.

You can make the following edits to the title.

“Erase”: Erases the selected title. Select “Yes” when asked for confirmation.

“Edit”: Allows you to make the following edits.

- “Title Name”: Allows you to enter or re-enter a title name (page 37).
- “Set Thumbnail”: Changes the title’s thumbnail picture that appears in the Title List (page 35).
- “A-B Erase”: Erases a section of the title (page 60).
- “Divide”: Divides a title into two titles (page 60).
- “Chapter Edit”: Edits chapters in a title (page 61).
- “Set Genre”: Assigns a genre to a title.
- “Protect”: Protects the title. “” appears next to the protected title.
- “Move”: Changes the title’s playing order (page 63).
- “Combine”: Combines two titles into one (page 63).

“Genre Name”: Allows you to enter a genre name (up to 12 characters) (page 37).

“Multi-Mode”: Allows you to select and edit multiple titles at one time (page 59).

“Create”: Creates a Playlist (page 63).

“Undo”: Undoes the last edit you made.

## Hint

You can label or re-label DVDs (page 38).

## Editing multiple titles (Multi-Mode)

### HDD

You can select and edit up to 24 titles at one time.

## 1 Press TITLE LIST.

## 2 Press →.

The sub-menu appears.

## 3 Select “Multi-Mode,” and press ENTER.

The display for selecting titles to be edited appears.

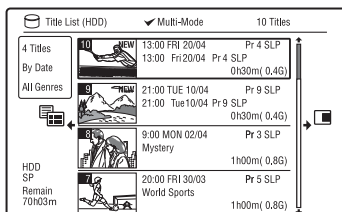

## 4 Select a title, and press ENTER.

A check mark appears in the check box. To clear the check mark, press ENTER again.

## 5 Repeat step 4 to select all of the titles you want to edit.

## 6 When you finish selecting titles, press →.

The sub-menu appears.

## 7 Select an option, and press ENTER.

“Erase”: Erases the selected titles.

“Protect”: Protects the titles. “” appears next to the protected title.

“Unprotected”: Unprotects the titles.

“Change Genre”: Changes the genre of the titles.

## Hint

You can exit “Multi-Mode” by pressing **→** and selecting “Single-Mode” while selecting titles.

## Erasing a section of a title (A-B Erase)

**HDD** **-RWVR** **-RVR**

You can select a section (scene) in a title and erase it. Note that erasing scenes in a title cannot be undone.

**1** After step 2 of “Erasing and Editing a Title,” select “Edit,” and press **ENTER**.

**2** Select “A-B Erase,” and press **ENTER**.

For the HDD, select a type of editing, and press **ENTER**. For details, see page 58.

The display for setting point A appears. The title starts to play.

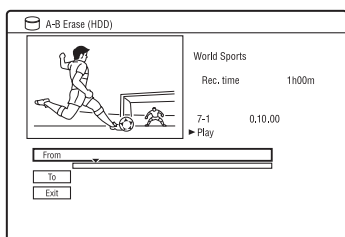

**3** Select point A using **◀/▶** or **▷**, and press **II**.

• To return to the beginning of the title, press **II** and then press **◀◀**.

**4** Select “From,” and press **ENTER**. The position of point A is displayed.

**5** Press **▷**.

**6** Select point B using **◀/▶** or **▷**, and press **II**.

**7** Select “To,” and press **ENTER**. The position of point B is displayed.

**8** Select “Yes,” and press **ENTER**. The scene is erased.

## To cancel “A-B Erase”

Press **↶** RETURN. The Title List appears.

## Hint

A chapter mark is inserted after the scene is erased. The chapter mark divides the title into separate chapters on either side of the mark.

## Notes

- Images or sound may be momentarily interrupted at the point where you erase a section of a title.
- Sections shorter than five seconds may not be erased.

## Dividing a title (Divide)

**HDD** **-RWVR** \* **-RVR** \*

If you want to dub a long title to a disc but do not want to reduce the picture quality, divide the title into two shorter titles. Note that dividing a title cannot be undone.

\* Only playlist titles can be divided for DVD-RWs/DVD-Rs in VR mode.

**1** After step 2 of “Erasing and Editing a Title,” select “Edit,” and press **ENTER**.

**2** Select “Divide,” and press **ENTER**.

For the HDD, select a type of editing, and press **ENTER**. For details, see page 58.

The display for setting the dividing point appears.

The title starts to play.

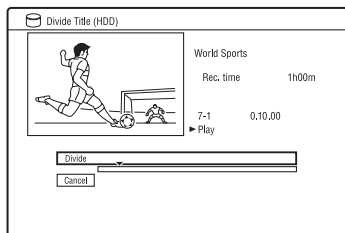

**3** Select the dividing point using **◀/▶** or **▷**, and press **II**.

• To return to the beginning of the title, press **II** and then press **◀◀**.

#### **4 Press ENTER.**

For the HDD, the display asks for confirmation.

#### **5 Select “Yes,” and press ENTER (HDD only).**

The title is divided into two.

---

## **Erasing and Editing a Chapter**

**HDD** **-RW/VR** **-RVR**

You can edit individual chapters within a title. To edit DVD-RWs/DVD-Rs (VR mode) without changing the original recordings, create a Playlist (page 63).

#### **1 Press TITLE LIST.**

For DVD-RWs/DVD-Rs in VR mode, switch the Title List (Original or Playlist), if necessary.

#### **2 Select a title containing the chapter you want to edit, and press →.**

The sub-menu appears.

#### **3 Select “Edit,” and press ENTER.**

#### **4 Select “Chapter Edit,” and press ENTER.**

For the HDD, select a type of editing, and press ENTER. For details, see page 58.

#### **5 Select an option, and press ENTER.**

You can make the following edits to the chapter.

“Divide”: Divides a chapter into two (page 62).

“Erase/Move”

- “Erase”: Erases the selected chapter (page 62).
  - “Move” (for Playlist titles on DVD-RWs/DVD-Rs in VR mode): Changes the chapter’s playing order (page 64).
- “Combine”: Combines two chapters into one (page 62).

## Dividing a chapter (Divide)

- 1 After step 4 of “Erasing and Editing a Chapter,” select “Divide.”

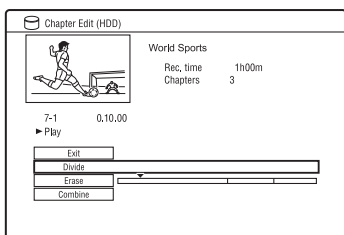

- 2 Select a chapter using  $\leftarrow/\rightarrow$ .
- 3 Select the dividing point using  $\lll/ \ggg$  or  $\triangleright$ , and press **II**.
  - To return to the beginning of the chapter, press **II** and then press  $\lll$ .
- 4 Press **ENTER**.  
The chapter is divided into two.

## Erasing a chapter (Erase)

- 1 After step 4 of “Erasing and Editing a Chapter,” select “Erase.”

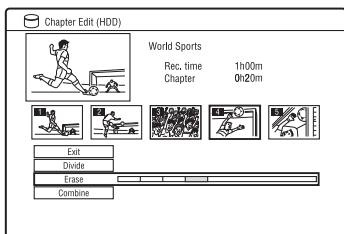

- 2 Select a chapter using  $\leftarrow/\rightarrow$ , and press **ENTER**.
- 3 (For a Playlist chapter only)  
Select “Erase,” and press **ENTER**.  
The display asks for confirmation.
- 4 Select “Yes,” and press **ENTER**.  
The chapter is erased.

## Combining multiple chapters (Combine)

- 1 After step 4 of “Erasing and Editing a Chapter,” select “Combine.”

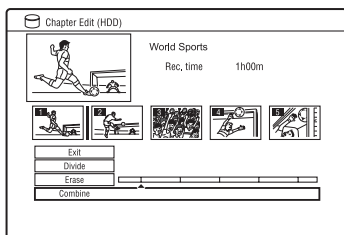

- 2 Move the combining bar using  $\leftarrow/\rightarrow$ , and press **ENTER**.  
The two adjacent chapters of the combining bar are combined.

### Note

Chapters cannot be combined if they are automatically created from an HDD camcorder dubbing.

## Creating and Editing a Playlist

**-RWVR** **-RVR**

Playlist edit allows you to edit or re-edit without changing the actual recordings. You can create up to 99 Playlist titles.

### ⚡ Note

Playlist titles containing titles recorded with the “Copy-Once” copy protection signal cannot be dubbed or moved (page 131).

- 1 Press **TITLE LIST**, and switch to the **Playlist**.  
For details on switching to the Playlist, see page 58.
- 2 Press **→**.  
The sub-menu appears.
- 3 Select **“Create,”** and press **ENTER**.  
The original titles in the Title List appear.
- 4 Select an original title to add to the **Playlist**, and press **ENTER**.  
The selected title is added to the Playlist.
- 5 Repeat steps 3 and 4 to select all of the titles you want to add to the **Playlist**.

### Moving a Playlist title (Move)

- 1 Press **TITLE LIST**, and switch to the **Playlist**.  
For details on switching to the Playlist, see page 58.
- 2 Select a **Playlist title**, and press **→**.  
The sub-menu appears.
- 3 Select **“Edit,”** and press **ENTER**.

- 4 Select **“Move,”** and press **ENTER**.

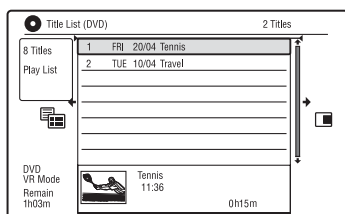

- 5 Select a new location for the title using **↑/↓**, and press **ENTER**.  
The title moves to the new location.
  - To move more titles, repeat from step 2.

### Combining multiple Playlist titles (Combine)

- 1 Press **TITLE LIST**, and switch to the **Playlist**.  
For details on switching to the Playlist, see page 58.
- 2 Select a **Playlist title**, and press **→**.  
The sub-menu appears.
- 3 Select **“Edit,”** and press **ENTER**.
- 4 Select **“Combine,”** and press **ENTER**.

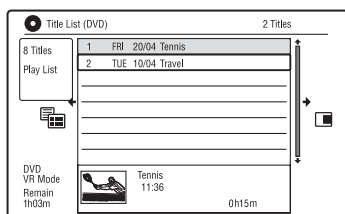

- 5 Select a title you want to combine, and press **ENTER**.
- 6 Select **“Yes,”** and press **ENTER**.  
The titles are combined.

### Dividing a Playlist title (Divide)

You can divide a Playlist title. For instructions, see page 60.

## Moving a chapter (Move)

- 1 Press TITLE LIST, and switch to the Playlist.**

For details on switching to the Playlist, see page 58.

- 2 Select a Playlist title containing the chapter you want to edit, and press →.**

The sub-menu appears.

- 3 Select “Edit,” and press ENTER.**

- 4 Select “Chapter Edit,” and press ENTER.**

- 5 Select “Erase/Move.”**

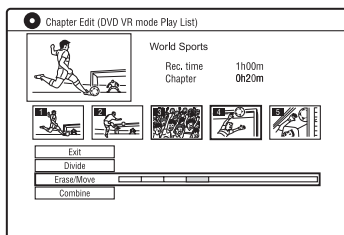

- 6 Select a chapter using ←/→, and press ENTER.**

- 7 Select “Move,” and press ENTER.**

- 8 Select a new location for the chapter using ←/→, and press ENTER.**

The chapter moves to the new location.



## Before Dubbing

In this section, “dubbing” refers to “copying a recorded title on the internal hard disk drive (HDD) to another disc, or vice versa.” You can dub a playing title using the HDD/DVD DUB button (see “HDD/DVD Dubbing” on page 66) or you can select to dub multiple titles all at once (see “Dubbing Using Dubbing List” on page 66). You can also dub an entire DVD disc to make a backup copy (see “Making a Backup Disc (DVD Backup)” on page 69). Before you start, read the following precautions, which are common to all dubbing methods.

### Before you start...

- You cannot record both the main and sub sound on the HDD (when “HDD Recording Format” is set to “Video Mode On” in the “Recording” setup), DVD+RWs, DVD-RWs (Video mode), DVD+Rs, or DVD-Rs (Video mode). For bilingual programmes, set “Bilingual Recording” to either “A/L” (default) or “B/R” in the “Audio In” setup (page 107). About HDD Recording format, see page 111.
- A title name in the dubbing source is dubbed. However, only up to 40 characters of a title name are dubbed when dubbing from the HDD to a DVD+RW/DVD-RW (Video mode)/DVD+R/DVD-R (Video mode).
- The chapter marks in the dubbing source are dubbed. The position of chapter marks may be slightly changed from the original. However, the chapter marks in the dubbing source are not retained in the dubbed title when dubbing to a DVD-RW/DVD-R (Video mode), DVD+RW, or DVD+R at normal speed. The chapter marks are automatically inserted according to the “Auto Chapter (Video)” and “Auto Chapter (DVD+R/+RW)” settings in the “Recording” setup (page 110).

- The “Set Thumbnail” setting in the dubbing source is dubbed as a thumbnail picture marker (except when dubbing from a DVD+RW/DVD-RW (Video mode)/DVD+R/DVD-R (Video mode)). The position of thumbnail picture markers may be slightly changed from the original.

### Hint

When you dub a Playlist title, it is recorded as an Original title.

### Notes

- You cannot make a recording while dubbing.
- Before playing a dubbed disc on other DVD equipment, finalise the disc (page 39, 67).
- You cannot dub from DVD VIDEOS to the HDD.
- Titles containing mixed aspect ratios cannot be dubbed to a DVD+RW/DVD+R/DVD-RW/DVD-R (Video mode) using the HDD/DVD DUB button.
- Titles over 8 hours cannot be dubbed to single-layer DVD+RWs/DVD+Rs.
- Low resolution (SEP through LP modes) 16:9 size titles cannot be dubbed to a DVD+RW/DVD+R/DVD-RW/DVD-R (Video mode).
- Titles recorded in Dolby Digital 5.1 ch audio are down-converted to 2-channel audio when dubbed at normal speed (“Real time” dubbing).
- About the “Move” function, see page 131.

## HDD/DVD Dubbing



You can dub a single title by pressing the HDD/DVD DUB button during playback. You can also dub from finalised DVD-RWs/DVD-Rs (Video mode) to the HDD.

### 1 Start playback of a title.

For playing a title, see “Playing” on page 49.

### 2 Press HDD/DVD DUB.

The recorder starts dubbing the current playing title from the beginning. The recorder turns off automatically when you do not use the recorder for more than 20 minutes after the dubbing has finished.

### To cancel dubbing

Press and hold HDD/DVD DUB for more than one second.

When dubbing is stopped partway, no part of the title will be moved to the dubbing target. However, note that this will decrease the free space for DVD+Rs/DVD-Rs.

### About dubbing mode

Titles on the HDD are dubbed to a disc at high speed (“High-Speed” dubbing). Titles on a disc are dubbed to the HDD at normal speed (“Real time” dubbing).

For the minimum required time for “High-Speed” dubbing, see page 131.

### To convert the recording mode (only when dubbing from a disc to the HDD)

Before step 1, press REC MODE to select the recording mode.

#### Note

You cannot use the HDD/DVD DUB button in the following cases. Dub the title using Dubbing List (page 66).

- When dubbing the title recorded in MN6 mode or longer duration mode to a DVD+RW/DVD+R.
- When dubbing the title recorded in HQ+ mode to a DVD.

## Dubbing Using Dubbing List



You can select the titles you want to dub using Dubbing List. You can also edit titles before dubbing without changing the original titles.

### 1 Press SYSTEM MENU.

The System Menu appears.

### 2 Select “Dubbing,” and press ENTER.

### 3 Select a dubbing direction, and press ENTER.

To dub titles from the HDD to a disc, select “HDD -> DVD.”

To dub titles from a disc to the HDD, select “DVD/CD -> HDD.”

### 4 Select “Create New Dubbing List,” and press ENTER.

The Dubbing List appears.

- If you have previously saved a Dubbing List and want to resume editing it, select “Use Previous Dubbing List,” and go to step 7.

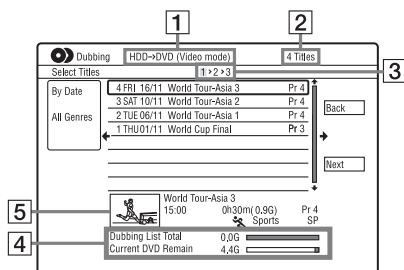

1 Direction of dubbing

2 Total number of titles to be dubbed

- 3** Dubbing step number  
 Display 1: Select a title you want to dub (the “Select Titles” display).  
 Display 2: Edit a title (the “Title Edit” display).  
 Display 3: Confirm the settings and start dubbing (the “Start Dubbing” display).

- 4** Total size of the selected titles and available space on the disc to be dubbed (approximate)

- 5** Selected title’s thumbnail picture

## 5 Select a title, and press ENTER.

The selected title changes colour. When you select “HDD -> DVD” in step 3, you can change the title order or search for a title by genre (see “3. Playing the Recorded Programme (Title List)” on page 33).

## 6 Repeat step 5 to select all of the titles in the order you want to dub.

## 7 Select “Next” using →, and press ENTER.

The “Title Edit” display appears. For details about editing, see “To edit titles on the Dubbing List” on page 68.

## 8 Select “Next” using →, and press ENTER.

The “Start Dubbing” display appears.

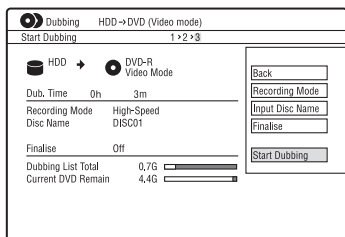

## 9 Select an option using ↑/↓, and press ENTER.

The options differ depending on the dubbing direction or disc type.  
 “Recording Mode”: Changes the dubbing mode of all selected titles at a time using ↑/↓ (page 128).  
 “Input Disc Name”: Changes the disc name (page 37).  
 “Finalise”: Select “Yes” to finalise a disc automatically after dubbing (DVD-RW/DVD-R (Video mode), or DVD+R).

## 10 Select “Start Dubbing,” and press ENTER.

When you set “Finalise” to “Yes” in step 9, select the title menu style, and press ENTER.

The recorder turns off automatically when you do not use the recorder for more than 20 minutes after the dubbing has finished.

### To cancel dubbing

Press and hold HDD/DVD DUB for more than one second.

When dubbing (Move) is stopped partway, no part of the title will be moved to the dubbing target. However, note that this will decrease the free space for DVD+Rs/DVD-Rs.

### About dubbing mode

“” appears next to the title that can be dubbed at high speed (“High-Speed” dubbing) in the “Title Edit” display. The following titles are dubbed at normal speed (“Real time” dubbing).

- Titles containing both main and sub sounds (except DVD-RWs/DVD-Rs (VR mode)).
- Titles recorded in mixed picture size (4:3 and 16:9, etc.) (except for DVD-RWs/DVD-Rs (VR mode)).
- Titles recorded on DVD+RWs/DVD-RWs (Video mode)/DVD+R/DVD-R (Video mode).

For the minimum required time for “High-Speed” dubbing, see page 131.

## To edit titles on the Dubbing List

- 1 Follow steps 1 to 7 of “Dubbing Using Dubbing List” on page 66. The “Title Edit” display appears.

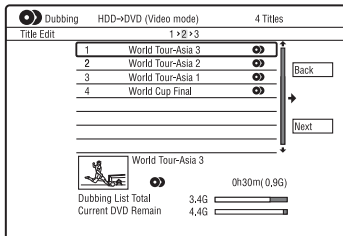

- 2 Select a title you want to edit, and press ENTER. The sub-menu appears.

- 3 Select an option, and press ENTER. The options differ depending on the dubbing direction or disc type.
  - “Erase”: Erases the selected title.
  - “Title Name”: Names or renames a title (page 37).
  - “A-B Erase”: Erases the section of the title (page 60).
  - “Move”: Changes the order of titles (page 63).
  - “Preview”: Allows you to check the content of a title.
  - “Divide”: Divides a title into two titles (page 60).
  - “Combine”: Combines two titles (page 63).
  - “Chapter Edit”: Edits chapters (page 61).
  - “Set Thumbnail”: Changes the title’s thumbnail frame that appears in the Title List (page 35).
  - “Recording Mode”: Sets the picture quality of the dubbing.
  - “Bilingual”: Sets how a bilingual audio programme is dubbed.
  - “Cancel”: Exits the sub-menu.

- 4 Repeat steps 2 and 3 to edit all of the titles.

- 5 Go to step 8 of “Dubbing Using Dubbing List” on page 66 to dub edited titles.

## Notes

- The Dubbing List you created remains after dubbing. To edit the existing Dubbing List, select “Use Previous Dubbing List” in step 4. The Dubbing List is cleared when:
  - you change “Input Line System” setting in the “Basic” setup (page 101).
  - you reset the recorder (page 124).
  - you open the disc tray (except when dubbing from the HDD).
  - you edit the titles on a disc (except when dubbing from the HDD).
  - you switch the Title List to Original or Playlist (when dubbing from DVD-RWs/DVD-Rs in VR mode only).
  - you finalise the disc.
- The “seams” that are left over from editing may remain on the disc after dubbing to DVD+RWs/ DVD-RWs (Video mode)/DVD+Rs/DVD-Rs (Video mode).
- Finalisation is cancelled if a timer recording starts, even if you set “Finalise” to “Yes” in step 9.

# Making a Backup Disc (DVD Backup)

+RW -RWVideo +R -RVideo

You can dub all of the contents on a finalised DVD+RW/DVD+R or finalised DVD-RW/DVD-R (Video mode) to another recordable DVD+RW/DVD-RW or unused DVD+R/DVD-R via the HDD as a backup copy.

## Note

Backup discs of unfinalised discs cannot be made.

### 1 Press SYSTEM MENU.

The System Menu appears.

### 2 Select “Dubbing,” and press ENTER.

### 3 Select “DVD Backup,” and press ENTER.

### 4 Select “Start new DVD Backup,” and press ENTER.

- If you have previously dubbed backup data to the HDD, select “Resume writing data,” and go to step 7.

### 5 Insert the DVD you are going to make a backup of.

### 6 Select “Start,” and press ENTER.

The recorder starts dubbing all of the contents on a DVD to the HDD.

### 7 Press $\blacktriangle$ (open/close), and replace the DVD with a recordable DVD+RW/DVD-RW or an unused DVD+R/DVD-R.

To make a backup disc of DVD+RWs/DVD+Rs, insert a recordable DVD+RW or unused DVD+R.

To make a backup disc of DVD-RWs/DVD-Rs, insert a recordable DVD-RW or unused DVD-R.

### 8 Select “Start,” and press ENTER.

The recorder starts “High-Speed” dubbing the contents that were dubbed to the HDD in step 6.

### 9 Select “Cancel,” and press ENTER.

The disc is automatically finalised.

- To make another backup disc, replace discs, select “Start,” and press ENTER.

### 10 Select “Yes” or “No,” and press ENTER.

To erase the backup data on the HDD, select “Yes.”

To make another backup disc later, select “No.”

The recorder turns off automatically when you do not use the recorder for more than 20 minutes after the dubbing has finished.

### To display the dubbing information

Press DISPLAY while dubbing.

### To cancel DVD backup during dubbing

Press and hold HDD/DVD DUB for more than one second.

### To erase backup data on the HDD

#### 1 Select “Erase back-up data” in step 4, and press ENTER.

The display asks for confirmation.

#### 2 Select “Yes,” and press ENTER.

## Notes

- When dubbing to a DVD+R/DVD-R is stopped partway in step 8, you cannot play or record on the disc. However, a DVD+RW/DVD-RW can be used again after it is reformatted.
- You cannot make a backup disc of DVD+R DLs/DVD-R DLs.
- You may not use the “DVD Backup” function depending on the recording quality or physical condition of the disc, or characteristics of the recording device and authoring software.

# Before HDD Camcorder Dubbing

You can dub the contents of a Sony HDD camcorder to the hard disk drive of the recorder via the USB jack on the front panel. Methods to dub from the HDD camcorder include:

- One-Touch Dubbing (Incremental Dubbing)
- Dubbing using the on-screen display (Incremental Dubbing/Full Dubbing)

Follow the instructions in “Preparing for HDD camcorder dubbing,” and then move on to the section on dubbing.

### Hints

- If you want to dub by way of the LINE IN jacks, see “Recording from Connected Equipment” on page 47.
- If you want to record the contents of the HDD camcorder on a DVD, dub them to the HDD of the recorder first, and then edit the title on the HDD and dub it to a DVD.
- Parts finished dubbing remain on the recorder when the HDD space of the recorder becomes full or you stop dubbing partway.
- Dolby Digital 5.1 ch audio recorded in the HDD camcorder can be dubbed to the recorder in the same format, without down-conversion.

### Notes

- No timer recordings or other operations are available when dubbing from the HDD camcorder.
- The supported device is Sony HDD SD (standard definition) camcorder released in or before April 2008.
- The recorder does not support the AVCHD format (HD (high definition) image quality). You can dub MPEG-2 format images (SD (standard definition) images) only.
- When the HDD camcorder contains still images and moving images, only moving images can be dubbed to the recorder.
- Playlist made with the HDD camcorder cannot be dubbed to the recorder.
- You cannot set the recording mode for HDD camcorder dubbing.
- When dubbing from the HDD camcorder, the recorder recognises and uses the shooting date and time information of the HDD camcorder. If the HDD camcorder’s clock is incorrect, the recorder may not dub the contents properly. Set the HDD camcorder’s clock correctly before shooting.
- Images of the HDD camcorder are not displayed when dubbing.
- You cannot record date, time, or the contents of the HDD camcorder memory onto the recorder.
- If you dub the contents recorded in high quality mode in the HDD camcorder to the recorder, it may take longer to finish dubbing than the recording.
- Set the recorder and HDD camcorder to the same colour system.

### How titles and chapters are created

In each dubbing operation, the contents dubbed to the recorder are divided into titles by the shooting date. If the date has been changed to the next day during one shooting session, the shot image is included in the title of the date when the shooting session started. The title is divided into chapters. Each shooting session on the HDD camcorder becomes a chapter.

### Hint

The title names are automatically labelled as “USB \*\*\* (start time of the first shooting session).”

### Note

The dubbed contents are divided into titles in the following cases, even if they were all recorded in the same day:

- When the total recording time exceeds 12 hours.
- When the total number of scenes exceeds 99.

## Preparing for HDD camcorder dubbing

Connect an HDD camcorder to the USB jack on the recorder.

Refer as well to the instruction manual supplied with the HDD camcorder before connecting.

- 1 Turn on your HDD camcorder and the recorder.
- 2 Connect your HDD camcorder to the USB jack on the front panel.

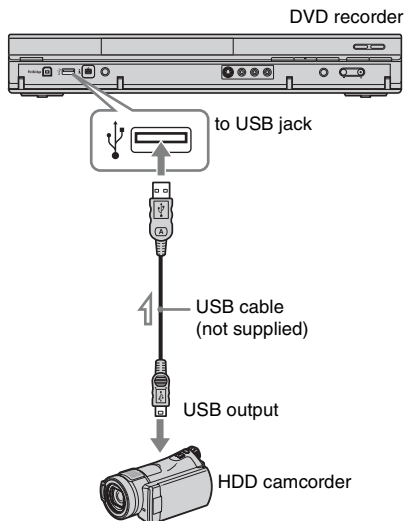

 : Signal flow

- 3 Set your HDD camcorder to the USB connection mode (example: “COMPUTER” or “USB CONNECT”).

For details, refer to the operating instructions supplied with the HDD camcorder.

### Notes

- Connect the HDD camcorder directly to the recorder.
- Do not disconnect the USB cable while dubbing.
- When signal input to the USB jack (type A) on the front panel or recorder operation cannot be performed correctly when using an HDD camcorder, connect the HDD camcorder to the LINE IN jack and follow the instructions of “Recording from Connected Equipment” on page 47.
- The recorder can recognise and store the shooting date and time information of up to 10 HDD camcorders. If you connect 11 or more HDD camcorders, one-touch dubbing and “Incremental Dubbing” cannot be made properly.

### To restart the connected USB device

Select “Restart USB Device” of “USB” in the “Options 2” setup (page 117).

---

## One-Touch Dubbing from HDD Camcorder (ONE-TOUCH DUB)

### HDD

You can dub contents of your HDD camcorder onto the HDD of the recorder with a single press of the ONE-TOUCH DUB button on the recorder.

When dubbing from the HDD camcorder for the first time, all of the contents are dubbed to the recorder. The next time, only newly shot sessions that have not been dubbed yet are dubbed to the recorder.

**Follow steps 1 to 3 of “Preparing for HDD camcorder dubbing” on page 71, and press ONE-TOUCH DUB on the recorder.**

The recorder starts dubbing the contents on the HDD camcorder to the HDD Title List of the recorder.

The recorder turns off automatically if you do not use the recorder for more than 20 minutes after the dubbing has finished.

---

### To stop during dubbing

Press **■** REC STOP more than 3 seconds. Note that it may take a few seconds for the recorder to stop dubbing.

### Notes

- The one-touch dubbing button on the HDD camcorder does not function with the recorder.
- In One-Touch Dubbing, the contents that have already been dubbed to the recorder cannot be dubbed again, even after you erase them from the recorder. To dub the same contents to the recorder again, dub the entire contents of the HDD camcorder (see “Dubbing from HDD Camcorder Using the On-Screen Display (HDD-Cam Dubbing)” on page 72).
- Data about the dubbed contents are all cleared when you reset the recorder (page 124).
- If the USB jack and the DV jack on the recorder are both connected to a compatible digital video camera, One-Touch Dubbing is performed via the USB jack.

---

## Dubbing from HDD Camcorder Using the On-Screen Display (HDD-Cam Dubbing)

### HDD

You can dub the contents of your HDD camcorder onto the HDD of the recorder using the on-screen display. Methods to dub from the HDD camcorder include:

- **Incremental Dubbing**  
The recorder automatically detects the contents recorded on the connected HDD camcorder, and starts dubbing from the contents following the last dubbed contents if there are contents that have already been dubbed.
- **Full Dubbing**  
The recorder dubs all contents of the HDD camcorder, including the contents that have already been dubbed to the recorder.

- 1 Follow steps 1 to 3 of “Preparing for HDD camcorder dubbing” on page 71.**
- 2 Press SYSTEM MENU.**  
The System Menu appears.
- 3 Select “HDD-Cam/DV,” and press ENTER.**
- 4 Select “HDD-Cam Dubbing,” and press ENTER.**
- 5 Select “Incremental Dubbing” or “Full Dubbing,” and press ENTER.**  
To dub newly shot contents only, select “Incremental Dubbing.”  
To dub all contents of the HDD camcorder, select “Full Dubbing.”  
The display asks for confirmation.



## **6** Select “Yes,” and press ENTER.

The recorder starts dubbing the contents on the HDD camcorder to the HDD Title List of the recorder.

The recorder turns off automatically if you do not use the recorder for more than 20 minutes after the dubbing has finished.

---

### **To stop dubbing**

Press and hold **■** REC STOP for more than three seconds. Or, select “Exit” in step 6, and press ENTER.

### **Note**

With “Incremental Dubbing,” the contents that have already been dubbed to the recorder are not dubbed again, even after you erase them from the recorder. You can dub only newly shot contents.

# Before DV Camcorder Dubbing

This section explains dubbing with a DV camcorder and playing the contents of a DV camcorder via the DV IN jack on the front panel. If you want to dub by way of the LINE IN jacks, see “Recording from Connected Equipment” on page 47. The DV IN jack on this recorder conforms to the i.LINK standard.

Follow the instructions in “Preparing for DV camcorder dubbing,” and then move on to the section on dubbing. For more information about i.LINK, see “About i.LINK” on page 135.

### How chapters are created

The contents dubbed to the HDD or DVD become a single title. This title is divided into chapters. When dubbing to the HDD or a DVD-RW/DVD-R (VR mode) and when “Auto Chapter (HDD/VR)” is set to “On” in the “Recording” setup (page 110), each shooting session on the tape becomes a chapter on the disc. For other discs, the recorder divides the title into chapters according to the “Auto Chapter (Video)” or “Auto Chapter (DVD+R/+RW)” setting in the “Recording” setup (page 110).

### Preparing for DV camcorder dubbing

You can connect a DV camcorder to the DV IN jack on the recorder to record or edit from a DV/Digital8 format tape. Operation is straightforward because the recorder will fast forward and rewind the tape for you – you do not need to operate your DV camcorder.

Refer as well to the instruction manual supplied with the DV camcorder before connecting.

### Hint

If you plan to do additional editing on a disc after the initial dub, use the DV IN jack and record on a DVD-RW/DVD-R (VR mode) or HDD.

### Notes

- You cannot make a recording while DV camcorder dubbing.
- The DV IN jack is for input only. It will not output signals.
- You cannot use the DV IN jack when:
  - signal input to the DV IN jack on the front panel or recorder operation cannot be performed correctly when using a digital video camera (see “About i.LINK” on page 135). Connect the camera to the LINE IN jack and follow the instructions of “Recording from Connected Equipment” on page 47.
  - the input signal is not in DVC-SD format. Do not connect a MICRO MV format digital video camera even if it has an i.LINK jack.
  - the images on the tape contain copy protection signals, which limit recording.
- If you want to play DVDs dubbed from a DV camcorder on other DVD equipment, finalise the disc (page 39).
- Set the recorder and DV camcorder to the same colour system (page 101).

### Hookups

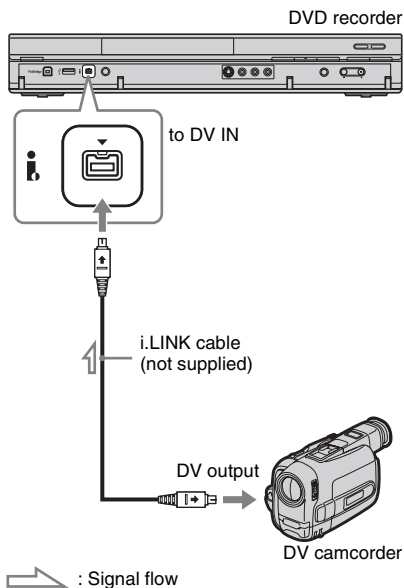

# 1 Press HDD or DVD to select the recording destination.

If you select DVD, insert a disc (see “1. Inserting a Disc” on page 31).

# 2 Insert the source DV/Digital8 format tape into your DV camcorder.

For the recorder to record or edit, your DV camcorder must be set to video playback mode.

# 3 Press REC MODE on the remote repeatedly to select the recording mode.

The recording mode changes as follows:

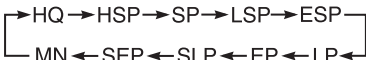

For details about the recording mode, see page 128. Note that you cannot select further manual recording mode options.

# 4 Set the “External Audio” setting in the “Audio In” setup (page 106).

# 5 Set the “DV Input” setting in the “Audio In” setup (page 107).

You are ready to start dubbing. Select one of the dubbing methods on the following pages.

## To playback DV/Digital8 format tape

You can check the contents of DV/Digital8 format tape before dubbing. For details, see “Playing from a DV Camcorder” on page 77.

## Notes

- You cannot connect more than one piece of digital video equipment to the recorder.
- You cannot control the recorder using another device or another recorder of the same model.
- You cannot record date, time, or the contents of the cassette memory onto the disc.
- If you record from a DV/Digital8 format tape that is recorded in multiple sound tracks, such as a tape with multiple sampling frequencies (48 kHz, 44.1 kHz, or 32 kHz), no sound or an unnatural sound will be output when playing back the sampling frequency switch point on the disc.
- In order to use this recorder’s “Auto Chapter” setting (page 74), be sure to correctly set the clock on your digital video camera before shooting.
- The recorded picture may be momentarily affected or the start and end points of a title may be different from what you have set if the source DV/Digital8 format tape is in any of the following conditions. In this case, connect your DV camcorder to the LINE IN jack and follow the instructions of “Recording from Connected Equipment” (page 47).
  - There is a blank space in the recorded portion of the tape.
  - The tape’s time code is not sequential.
  - If the picture size or the recording mode on the tape being dubbed changes.
- A blank or black coloured screen will be dubbed when the recorder is set to a different colour system from the DV tape contents’ system. Set “Input Line System” in the “Basic” setup to the same colour system as the DV tape contents’ system (page 101).

---

## Dubbing an Entire DV Format Tape (DV One-Touch Dubbing)



You can record the entire contents of a DV/Digital8 format tape onto a disc with a single press of the ONE-TOUCH DUB button on the recorder. The recorder controls the DV camcorder for the whole process, and completes the recording.

**Follow steps 1 to 5 of “Preparing for DV camcorder dubbing” on page 74, and press ONE-TOUCH DUB on the recorder.**

The recorder rewinds the tape and then starts recording the tape contents.

After the recording is finished, the recorder rewinds the tape in the DV camcorder, and finalises the recorded disc (except DVD-RW/DVD-R (VR mode)) automatically.

---

### To stop during recording

Press and hold **■ REC STOP** for more than 3 seconds.

Note that it may take a few seconds for the recorder to stop recording.

### ⚡ Notes

- When a blank space between the recordings on the tape continues for more than two minutes, DV One-Touch Dubbing ends automatically.
- The recorder will pause recording when there is a blank space or an image containing copy protection signals on the tape. The recorder will resume recording automatically when receiving a recordable signal.
- Finalisation is cancelled if a timer recording starts (except for DVD-RW/DVD-R (VR mode)).
- DV One-Touch Dubbing ends automatically when there are images containing copy protection signals at the beginning of the tape.
- When connecting digital video cameras to both DV IN jack and USB jack, pressing the ONE-TOUCH DUB button starts dubbing from the HDD camcorder. Disconnect the HDD camcorder from the USB jack to dub from the DV camcorder.

---

## Dubbing Selected Scenes (DV Manual Dubbing)



You can select and dub scenes while playing a DV/Digital8 format tape.

- 1 Follow steps 1 to 5 of “Preparing for DV camcorder dubbing” on page 74.**
  - 2 Press SYSTEM MENU.**  
The System Menu appears.
  - 3 Select “HDD-Cam/DV,” and press ENTER.**
  - 4 Select “DV Manual Dubbing,” and press ENTER.**
  - 5 Select the recording destination, “Record to Hard Disk Drive” or “Record to DVD,” and press ENTER.**
  - 6 Press  $\blacktriangle$ .**  
The scene starts to play.
  - 7 Find the point on the DV/Digital8 format tape that you want to start dubbing from using  $\blacktriangleleft/\blacktriangleright$  or  $\blacktriangleleft/\blacktriangleright$ , and press **III**.**
  - 8 Select “Start Rec.,” and press ENTER.**  
The recorder starts dubbing.
  - 9 Select “Pause Rec.,” and press ENTER.**  
The recorder pauses dubbing.
  - 10 Repeat steps 6 to 9 to dub more scenes.**
  - 11 Select “Stop Rec.,” and press ENTER.**  
The selected scenes are dubbed as a single title.
- 

### To exit “DV Manual Dubbing”

Press SYSTEM MENU.

### **Hint**

You can turn off the dubbing menu by pressing the DISPLAY button during dubbing. Press the DISPLAY button again to display the dubbing menu.

### **Note**

You cannot set a scene to be shorter than one second.

---

## Playing from a DV Camcorder

- 1 Connect your DV camcorder to the DV IN jack on the front panel.**
  - 2 Press SYSTEM MENU.**  
The System Menu appears.
  - 3 Select “HDD-Cam/DV,” and press ENTER.**
  - 4 Select “DV Playback,” and press ENTER.**
  - 5 Start playback on the DV camcorder.**  
Images from the DV camcorder appear on your TV screen.
- 

### To cancel playback

Press SYSTEM MENU.

### **Hint**

You can dub the playing tape contents. During playback, press HDD or DVD to select the dubbing destination, and press ● REC. To stop dubbing, press ■ REC STOP.

## About Jukebox

There are two methods to use Jukebox: connecting the USB device or copying audio tracks to the HDD.

When using Jukebox, you can do following:

- Store audio tracks on the HDD.
- Play audio tracks using various play modes.
- Label tracks, albums, or artists.
- Create a Playlist.

### Notes on copying

- You cannot copy audio tracks on the HDD to discs or USB devices.
- Some audio tracks may not be copied depending on the file size.
- An artist name, album name, and MP3 audio track name are copied, and albums and MP3 tracks are stored in each artist folder. However, albums and MP3 audio tracks are stored in the "Unknown" folder when their artist name cannot be copied.
- Audio tracks from a CD are stored in the artist folder labelled "Unknown." Names are automatically labelled; "A\_\*\*\*\*\*\_F\_\*\*\*\*\*" for album, "A\_\*\*\*\*\*\_F\_\*\*\*\*\*\_T\_\*\*\*\*\*" for audio tracks.
- When copying is stopped partway, tracks that have finished copying before you stop will remain copied onto the HDD as an album. You can check which albums have been copied in the Music Jukebox list (page 80).
- No other operations are available when copying audio tracks.
- While copying audio tracks, timer recordings are unavailable. If the timer is set during copying, the recorder starts the timer recording after copying is finished.
- Copy-protected CDs cannot be copied to the HDD.

## Preparing for Using Jukebox

Connect a USB device to the USB jack on the recorder, or copy audio tracks from the connected USB device or CDs/DATA CDs/DATA DVDs to the HDD.

### Connecting the USB device

You can connect a USB device to the USB jack on the recorder to listen to the MP3 audio tracks or copy to the HDD. Refer to the operating instructions supplied with the USB device before connecting.

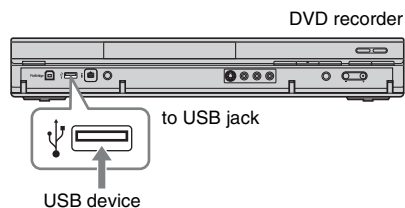

### Note

Some USB devices may not work with this recorder.

### Copying tracks or albums (USB → HDD)

You can copy up to 99 albums or 999 audio tracks on the USB device to the HDD.

- 1 Connect the USB device to the USB jack on the recorder (page 78).**
- 2 Press SYSTEM MENU.**  
The System Menu appears.
- 3 Select "Music Jukebox," and press ENTER.**
- 4 Select "Listen to Music from USB Device," and press ENTER.**  
The "Music Jukebox (USB)" appears.
- 5 Select an album to copy using ↑/↓, and press →.**  
The sub-menu appears.

- 6** Select “Edit” using **↑/↓**, and press **ENTER**.
- 7** Select an item using **↑/↓**, and press **ENTER**.  
To copy all albums, select “Copy all to HDD.”  
To copy the selected albums, select “Copy to HDD.”  
The display asks for confirmation.
- 8** Select “Yes” using **←/→**, and press **ENTER**.

The albums are copied to the HDD.

- To copy more albums, repeat from step 5.

---

#### To cancel copying

Press **ENTER**.

### Copying audio tracks (DISC → HDD)

- 1** Insert a disc that you are going to copy to the HDD.
- 2** Press **SYSTEM MENU**.  
The System Menu appears.
- 3** Select “Dubbing,” and press **ENTER**.
- 4** Select “DVD/CD → HDD” using **↑/↓**, and press **ENTER**.  
The copying starts.

---

#### To cancel copying

Press **ENTER**.

#### Note

Before copying, select “CD” or “MP3” under “Data Format” in the Title List (DVD/CD) (page 50).

### Copying tracks or albums on the HDD (HDD ↔ HDD)

- 1** Press **SYSTEM MENU**.  
The System Menu appears.
- 2** Select “Music Jukebox,” and press **ENTER**.
- 3** Select “Listen to Music / Edit,” and press **ENTER**.  
The “Music Jukebox (HDD)” appears.
- 4** Select an artist using **↑/↓**, and press **ENTER**.
- 5** Select an album using **↑/↓**, and press **ENTER**.  
If you want to copy the album, press **→** instead of **ENTER**, then go to step 7.
- 6** Select a track to copy using **↑/↓**, and press **→**.  
The sub-menu appears.
- 7** Select “Edit” using **↑/↓**, and press **ENTER**.
- 8** Select “Copy Album” or “Copy Track” using **↑/↓**, and press **ENTER**.
- 9** Select a copy destination (an artist or album) using **↑/↓**, and press **ENTER**.  
The display asks for confirmation.
- 10** Select “Yes” using **←/→**, and press **ENTER**.  
The albums or tracks are copied to the HDD.
  - To copy more tracks or albums, repeat from step 4.

---

#### To cancel copying

Press **ENTER**.

# Playing Audio Tracks Using Jukebox/USB Device

- 1 Press **SYSTEM MENU**.  
The System Menu appears.
- 2 Select “Music Jukebox,” and press **ENTER**.
- 3 Select “Listen to Music / Edit” or “Listen to Music from USB Device,” and press **ENTER**.  
To listen to the audio tracks on the HDD, select “Listen to Music / Edit.”  
To listen to the MP3 audio tracks from the connected USB device, select “Listen to Music from USB Device.”  
The Music Jukebox list appears.

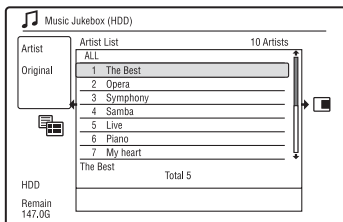

- 4 Select an artist, album, or track, and press **▷**.  
(HDD only) To display an album list, select an artist using **↑/↓**, and press **ENTER**.  
To display a track list, select an album using **↑/↓**, and press **ENTER**.  
Playback starts.

## To stop playback

Press **■** (stop).

## To return to the previous display

Press **↶** RETURN. If you cannot return to the artist list or album list using **↶** RETURN, see “To change the display mode (Original list only)” on page 80.

## To scroll the list display by page (Page mode)

Press **SUBTITLE** (previous)/**ANGLE** (next) while the Music Jukebox list is displayed. Each time you press **SUBTITLE** (previous)/**ANGLE** (next), the Music Jukebox list changes to the previous/next page of the list.

## To change the play information (HDD only)

Press **DISPLAY** repeatedly. Each time you press the button, information below the artist/album/track list is changed.

## About the Playlist and Original list (HDD only)

You can switch the “Music Jukebox (HDD)” to show tracks in Original list or Playlist.

- 1 Press **◀** while the “Music Jukebox (HDD)” is displayed.
- 2 Select “Play List” using **↑/↓**, and press **ENTER**.
- 3 Select an item using **↑/↓**, and press **ENTER**.

Item	Display
Original	Tracks in the Original list.
Play List 1 Play List 2 Play List 3 Play List 4	Tracks in each Playlist.
Favourites	Tracks in order of playback frequency. The track that is most often played is listed at the top.

## To change the display mode (Original list only)

- 1 Press **◀** while the “Music Jukebox (HDD)” is displayed.
- 2 Select “Display Mode” using **↑/↓**, and press **ENTER**.
- 3 Select an item using **↑/↓**, and press **ENTER**.

Item	Display
Artist (HDD only)	Artist list appears.
Album	Album list appears.
Track	Track list appears.



## Adding audio tracks to a Playlist (HDD only)

You can add audio tracks on the HDD to the Playlist. You can add up to 25 audio tracks to each Playlist.

### 1 After step 2 of “Playing Audio Tracks Using Jukebox/USB Device,” select “Listen to Music / Edit,” and press ENTER.

Switch the display to the Original list (page 80).

### 2 Select a track to add to the Playlist, and press →.

The sub-menu appears.

### 3 Select “Add to Play List,” and press ENTER.

### 4 Select a Playlist, and press ENTER.

The track is added to the selected Playlist.

### 5 Repeat steps 2 to 4 to select all of the tracks you want to add to the Playlist.

- To check the Playlist tracks, switch to the Playlist.

## Playback options

Buttons	Operations
⏪/⏩	Goes to the next or previous track when pressed during playback.
⏮/⏭	Fast reverses/fast forwards the disc when pressed during playback. Search speed changes as follows: fast reverse    fast forward ⏮FR1 ← → ⏭FF1 ⏮FR2 ← ← → → ⏭FF2
	When you press and hold the button, fast forward/fast reverse continues at the selected speed until you release the button. To resume normal playback, press ▷.

Buttons	Operations
⏸ (pause)	Pauses playback. To resume normal playback, press ▷.

## Playing repeatedly (Repeat)

You can repeatedly play tracks or a single track.

### 1 Press → during playback.

If you are playing tracks on the HDD, go to step 3.

### 2 (USB device only) Select “Play Mode” using ↑/↓, and press ENTER.

The “Play Mode” menu appears.

### 3 Select “Repeat” using ↑/↓, and press ENTER.

### 4 Select an item using ↑/↓.

“Repeat Artist” (HDD only): repeats tracks of the current artist.

“Repeat Album”: repeats the current album.

“Repeat Track”: repeats the current track.

“Repeat Play List” (HDD only): repeats the current Playlist.

“Repeat Programme” (USB device only): repeats the current programme (page 82).

### 5 Press ENTER.

Repeat play starts.

## To cancel Repeat play

Set “Repeat” to “Repeat Off” in step 4.

### Note

You can select “Repeat Programme” only during Programme play.

## Creating your own programme (Programme) (USB device only)

You can play the contents of the connected USB device in the order you want by arranging the order of the tracks on the connected USB device to create your own programme. You can make a programme of up to 24 tracks.

- 1 Press **→** while the “Music Jukebox (USB)” is displayed.
- 2 Select “Play Mode” using **↑/↓**, and press **ENTER**.  
The “Play Mode” menu appears.
- 3 Select “Programme,” and press **ENTER**.
- 4 Select “Input/Edit Programme,” and press **ENTER**.
- 5 Select an album (example: Album 01) using **↑/↓**, and press **→**.

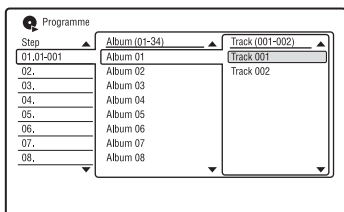

- 6 Select a track (example: Track 001) using **↑/↓**, and press **ENTER**.  
The track is programmed.  
If you make a mistake, select the step number (example: 01.) using **←/↑/↓**, and press **CLEAR**.
- 7 To programme other tracks, press **←/↑/↓/→** to select a step number, and repeat steps 5 and 6.
- 8 Press **▷**.  
Programme play starts.

### To stop Programme play

Press **■** (stop).

### To cancel Programme play

Set “Programme” to “Cancel Programme Play” in the “Play Mode” menu during playback.

### To erase the programme

Set “Programme” to “Erase Programme List” in the “Play Mode” menu.

### 💡 Hints

- The programme you made remains after Programme play finishes. To play the same programme again, set “Programme” to “Start Programme Play” in the “Play Mode” menu. However, the programme is cleared after you press **I/⏻**.
- You can repeat Programme play. During Programme play, set “Repeat” to “Repeat Programme” in the “Play Mode” menu (page 81).

# Managing Audio Tracks on the Music Jukebox (HDD only)

You can erase or label artists/albums/tracks on the HDD.

## 1 Press SYSTEM MENU.

The System Menu appears.

## 2 Select “Music Jukebox,” and press ENTER.

## 3 Select “Listen to Music / Edit,” and press ENTER.

The “Music Jukebox (HDD)” appears.

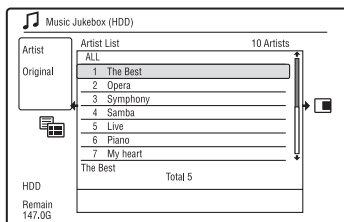

## 4 Select an artist, album, or track, and press →.

To display an album list, select an artist using ↑/↓, and press ENTER.

To display a track list, select an album using ↑/↓, and press ENTER.

## 5 Select an option, and press ENTER.

“Erase”: Erases the selected artist/album/track. Select “Yes” when asked for confirmation.

“Edit”: Allows you to make the following edits.

- “Artist Name”: Allows you to enter or re-enter an artist name (page 37).
- “Album Name”: Allows you to enter or re-enter an album name (page 37).
- “Track Name”: Allows you to enter or re-enter a track name (page 37).
- “Copy Album”: Allows you to copy an album (page 79).
- “Copy Track”: Allows you to copy a track (page 79).

“Repeat”: Repeats playback of artist/album/track (page 81).

“Add to Play List”: Allows you to add tracks to a Playlist (page 81).

“Play List Name”: Allows you to enter or re-enter a Playlist name (up to 12 characters) (page 37).

### Note

You cannot edit audio tracks on the connected USB device.

## About the “Photo Album” Function

The “Photo Album” function enables you to do following.

- Store JPEG image files on the HDD.
- View JPEG image files on the HDD, DATA DVDs (DVD-RWs/DVD-Rs)/ DATA CDs, or connected USB device.
- Edit JPEG image files.
- Print JPEG image files.
- Copy JPEG image files and slideshow to DVD-RWs/DVD-Rs.
- Create a slideshow with your favourite music and graphic effects (x-Pict Story).

## Preparing for Using the “Photo Album” Function

Connect a USB device to the USB jack on the recorder, or copy JPEG image files from DATA CDs/DATA DVDs or the connected USB device to the HDD.

### Connecting the USB device

You can connect a USB device (digital still camera, Memory card reader, and USB memory) to the USB jack on the recorder to view JPEG image files or copy to the HDD. Refer to the operating instructions supplied with the USB device before connecting.

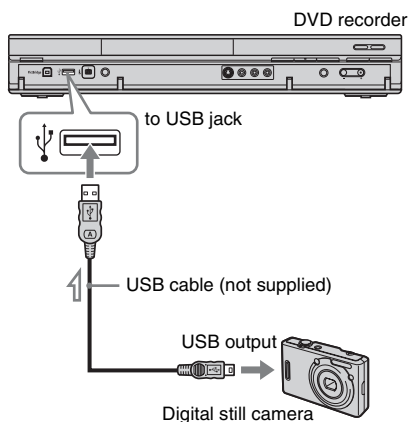

 : Signal flow

### Note

Some USB devices may not work with this recorder.

### Copying JPEG image files to the HDD (DISC/USB → HDD)

- 1** Insert a disc that you are going to copy to the HDD or connect the USB device to the USB jack on the recorder.
- 2** Press **SYSTEM MENU**.  
The System Menu appears.

**3** Select “Photo Album,” and press ENTER.

The “Photo Album” menu appears.

**4** Select the item, and press ENTER.

To copy from DATA CDs/DATA DVDs (DVD-RWs/DVD-Rs), select “View Photos on a DVD/CD.”

To copy from the connected USB device, select “View Photos on a USB Device.”

The “Photo Album” list appears.

Example: DVD/CD

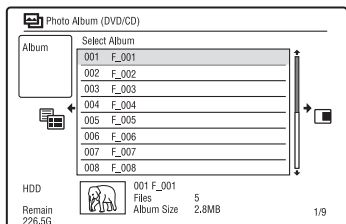

**5** Select an album or JPEG image file using ↑/↓, and press →.

The sub-menu appears.

**6** Select “Multi-Mode” using ↑/↓, and press ENTER.

- To copy all the albums and JPEG image files, select “Copy all to HDD,” and go to step 11.
- To copy the album or file selected in step 5 only, select “Copy to HDD,” and go to step 11.

**7** Select an album or JPEG image file, and press ENTER.

A check mark appears in the check box by the selected item.

- To clear the check mark, press ENTER again.
- To clear all check marks, press → to select “Single-Mode” from the sub-menu.

**8** Repeat step 7 to select all of the albums or JPEG image files you want to copy.

**9** Press →.

The sub-menu appears.

**10** Select “Copy to HDD,” and press ENTER.

The display asks for confirmation.

**11** Select “Yes,” and press ENTER.

- To cancel, select “No.”

## Copying all JPEG image files from the connected USB device (USB → DVD-RW/DVD-R)

**1** Connect the USB device to the USB jack on the recorder.

**2** Insert a blank DVD-RW/DVD-R (Video mode).

**3** Press SYSTEM MENU.

The System Menu appears.

**4** Select “Photo Album,” and press ENTER.

The “Photo Album” menu appears.

**5** Select “Copy Photos from a Digital Camera,” and press ENTER.

The display asks for confirmation.

**6** Select “Yes,” and press ENTER.

- To cancel, select “No.”

**Hint**

See “7. Reformatting a Disc” (page 42) to format DVD-RWs/DVD-Rs in Video mode.

**Notes**

- During copying, other operations cannot be performed.
- While copying JPEG image files, timer recordings are unavailable. If the timer is set during copying, the recorder starts the timer recording after copying is finished.

## Copying JPEG image files or albums on the HDD (HDD ↔ HDD)

- 1 Press SYSTEM MENU.**

The System Menu appears.
- 2 Select “Photo Album,” and press ENTER.**

The “Photo Album” menu appears.
- 3 Select “View/Edit Photos on the HDD,” and press ENTER.**

The “Photo Album” list appears.
- 4 Select an album using ↑/↓.**

To copy the selected album, go to step 6.  
To copy a JPEG image file, go to step 5.
- 5 Press ENTER, and select a JPEG image file using ↑/↓.**
- 6 Press →.**

The sub-menu appears.
- 7 Select “Multi-Mode” using ↑/↓, and press ENTER.**
  - To copy the selected album, select “Copy Album Contents” in “Album Options,” and go to step 12.
  - To copy the selected files, select “Copy” in “File Options,” and go to step 12.
- 8 Select an album or JPEG image file, and press ENTER.**

A check mark appears in the check box by the selected item.

  - To clear the check mark, press ENTER again.
  - To clear all check marks, press → to select “Single-Mode” from the sub-menu.
- 9 Repeat step 8 to select all of the albums or JPEG image files you want to copy.**
- 10 Press →.**

The sub-menu appears.
- 11 Select “Copy,” and press ENTER.**

- 12 Select the destination album using ↑/↓, and press ENTER.**

The display asks for confirmation.

- 13 Select “Yes,” and press ENTER.**
  - To cancel, select “No.”

### Note

Albums or JPEG image files are not copied to the HDD in the following cases.

- when the HDD disc space is insufficient for copying.
- when there are already the maximum number of files and/or albums on the HDD.

## Copying JPEG image albums to a disc (HDD → DVD-RW/DVD-R)

You can copy the edited JPEG image albums to a DVD-RW/DVD-R (Video mode). A slideshow is also recorded to the disc as a video file. You can play the slideshow on other DVD equipment that may not be compatible with the playback of JPEG image files.

- 1 Insert a DVD-RW/DVD-R (in Video mode).**
- 2 Press SYSTEM MENU.**

The System Menu appears.
- 3 Select “Photo Album,” and press ENTER.**

The “Photo Album” menu appears.
- 4 Select “View/Edit Photos on the HDD,” and press ENTER.**

The “Photo Album” list appears.
- 5 Select an album using ↑/↓, and press →.**

The sub-menu appears.
- 6 Select “Multi-Mode,” and press ENTER.**

To copy the album selected in step 5 only, go to step 10.

## 7 Select an album, and press ENTER.

A check mark appears in the check box by the selected item.

- To clear the check mark, press ENTER again.
- To clear all check marks, press → to select “Single-Mode” from the sub-menu.

## 8 Repeat step 7 to select all of the albums you want to copy.

## 9 Press →.

The sub-menu appears.

## 10 Select “Copy to DVD,” and press ENTER.

The display asks for confirmation.

## 11 Select “Yes,” and press ENTER.

The selected JPEG image albums are copied in the “PICTURE” folder on the disc.

The JPEG image album names are automatically labelled as “\*\*\*ALBUM.”

If you want to play the disc on other DVD equipment, finalise the disc (page 39).

- To cancel, select “No.”

### Hints

- See “7. Reformatting a Disc” (page 42) to format DVD-RWs/DVD-Rs in Video mode.
- See the “Photo Album” list to check which albums have been copied (page 88).

### Notes

- You may not be able to play the slideshow depending on DVD equipment.
- You cannot copy JPEG image files to a recordable DVD which has been recorded using other recorders/devices.
- DATA DVDs finalised on this recorder may not be able to play on other equipment.
- You can record up to 99 slideshows to a disc.
- When copying an album containing more than 99 JPEG image files to a disc, slideshows will be created with every 99 JPEG image files and recorded to a disc.
- For DVD-Rs, the available disc space does not increase even if you erase slideshows.

## Copying JPEG image files to a disc (HDD → DVD-RW/DVD-R)

You can copy the edited JPEG image files to a DVD-RW/DVD-R (Video mode).

A slideshow is also recorded to the disc as a video file. You can play the slideshow on other DVD equipment that may not be compatible with the playback of JPEG image files.

## 1 Follow steps 1 to 4 of “Copying JPEG image albums to a disc (HDD → DVD-RW/DVD-R)” on page 86.

The “Photo Album” list appears.

## 2 Select an album using ↑/↓, and press ENTER.

The photo list appears.

## 3 Select a JPEG image file using ↑/↓, and press →.

The sub-menu appears.

## 4 Select “Multi-Mode,” and press ENTER.

To copy the JPEG image file selected in step 3 only, go to step 8.

## 5 Select a JPEG image file, and press ENTER.

A check mark appears in the check box by the selected item.

- To clear the check mark, press ENTER again.
- To clear all check marks, press → to select “Single-Mode” from the sub-menu.

## 6 Repeat step 5 to select all of the JPEG image files you want to copy.

## 7 Press →.

The sub-menu appears.

## 8 Select “Copy to DVD,” and press ENTER.

The display asks for confirmation.

## 9 Select “Yes,” and press ENTER.

The selected JPEG image files are copied in the “PICTURE” folder on the disc.

The JPEG image file names are automatically labelled as “PHOT\*\*\*\*.”

If you want to play the disc on other DVD equipment, finalise the disc (page 39).

- To cancel, select “No.”

---

### To select a JPEG image file from a different album

- 1 Switch to the album list in step 5.  
For instructions, see “To switch between the album list and JPEG image file list” on page 90.
- 2 Select an album using **↑/↓**, and press **←**.
- 3 Switch to the JPEG image file list.  
For instructions, see “To switch between the album list and JPEG image file list” on page 90.
- 4 Select a JPEG image file using **↑/↓**, and press ENTER.

#### Hints

- See “7. Reformatting a Disc” (page 42) to format DVD-RWs/DVD-Rs in Video mode.
- See the “Photo Album” list to check which JPEG image files have been copied (page 88).

#### Notes

- You may not be able to play the slideshow depending on DVD equipment.
- You cannot copy JPEG image files to a recordable DVD which has been recorded using other recorders/devices.
- DATA DVDs finalised on this recorder may not be able to play on other equipment.
- You can record up to 99 slideshows to a disc.
- For DVD-Rs, the available disc space does not increase even if you erase slideshows.

---

## Using the “Photo Album” List

You can play JPEG image files on the HDD, DATA DVDs/DATA CDs, or connected USB device using the “Photo Album” list.

### 1 Press SYSTEM MENU.

The System Menu appears.

### 2 Select “Photo Album,” and press ENTER.

The “Photo Album” menu appears.

### 3 Select the item, and press ENTER.

To play JPEG image files on the HDD, select “View/Edit Photos on the HDD.”

To play JPEG image files on DATA CDs/DATA DVDs, select “View Photos on a DVD/CD.”

To play JPEG image files on the connected USB device, select “View Photos on a USB Device.”

The “Photo Album” list appears.

### 4 Select an album using **↑/↓**, and press ENTER.

To show the 4-Photo List or 1-Photo List, press **←** to select “Title View,” and press ENTER, then select “4 Photos” or “1 Photo” using **↑/↓**, and press ENTER.



## 12-Photo List (Example: HDD)

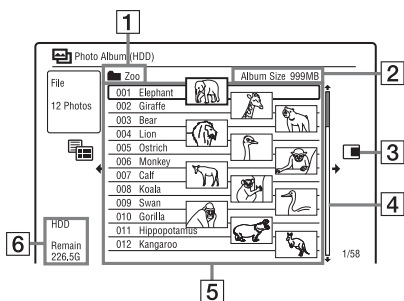

## 4-Photo List

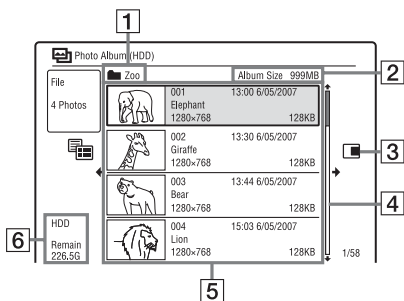

## 1-Photo List

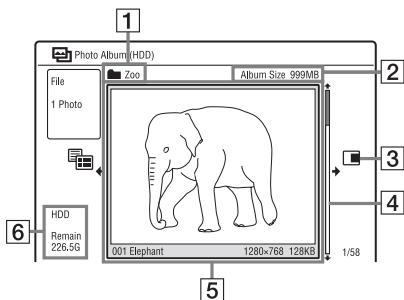

1 Album name

2 Album size

3 Sub-menu:

Press **→** to display the sub-menu.

The sub-menu displays options applicable only to the selected item. The displayed options differ depending upon the model, situation, and disc type.

For details about the sub-menu options, see "Managing JPEG Image Files on the HDD" on page 93.

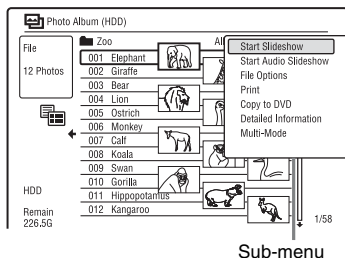

4 Scroll bar:

Appears when all of the JPEG image files do not fit on the list. To view the hidden JPEG image files, press **↑/↓**.

5 Album and JPEG image file information:

Displays the image, JPEG image file number, recording date and time, JPEG image file name, and JPEG image file size. "**⏏**" appears for protected JPEG image files.

6 Remaining space on the HDD

## To scroll the list display by page (Page mode)

Press **⏪/⏩** while the "Photo Album" list is displayed. Each time you press **⏪/⏩**, the "Photo Album" list changes to the previous/next page of albums/JPEG image files.

## To switch between the album list and JPEG image file list

- 1 Press **←** while the “Photo Album” list is displayed.
- 2 Select “Display Mode” using **↑/↓**, and press ENTER.
- 3 Select “File” or “Album” using **↑/↓**, and press ENTER.

### Hints

- You can switch the thumbnail picture on the album list among the JPEG image files in the selected album by pressing **◀/▶**.
- You can switch to the previous or next album by pressing **◀◀/▶▶** on the JPEG image file list.

## To turn off the “Photo Album” list

Press SYSTEM MENU.

## To display the detailed information

- 1 Select a JPEG image file, and press **→**.
- 2 Select “Detailed Information,” and press ENTER.  
The detailed information for the selected JPEG image file appears.

## To reload the files or folders

When a disc or the connected USB device contains 1,000 or more files and/or 100 or more folders, select “Read next” in the “Photo Album” list, and press ENTER to view unloaded files or folders.

It may take a few minutes to load files or folders.

### Note

The thumbnail for a file that cannot be playable on the recorder is displayed as “.

## Playing a slideshow

- 1 Follow steps 1 to 4 of “Using the “Photo Album” List.”  
The “Photo Album” list appears.  
Switch between the album list and JPEG image file list, if necessary.
- 2 Select an album or JPEG image file using **↑/↓**, and press **▷**.  
The slideshow starts.

### Hint

You can start a slideshow by selecting “Start Slideshow” from the sub-menu.

### Notes

- Depending on the aspect ratio, some pictures may be displayed with black bands at top and bottom, or left and right.
- Large picture files may take a few seconds to display. This is not a malfunction.

## To stop a slideshow

Press **■** (stop) or **↶** RETURN.

## To pause a slideshow

Press **⏸** (pause).

## To view the previous/next image during a slideshow

Press **◀◀/▶▶**.

## To zoom an image

Press ZOOM repeatedly during a slideshow. Each time you press ZOOM, the magnification changes as shown below.  
2× → 4× → normal magnification  
You can move the area you want to zoom using **←/↑/↓/→**.

## To rotate an image

Press ANGLE repeatedly during a slideshow.

Each time you press ANGLE, the image turns clockwise by 90°.

## To play a slideshow with the sound (HDD only)

You can enjoy a slideshow while listening to the sound stored in the HDD. First prepare Music Playlists by adding audio tracks using Jukebox (see “Adding audio tracks to a Playlist (HDD only)” on page 81).

- 1 Select “View/Edit Photos on the HDD” in step 3 of “Using the “Photo Album” List” on page 88.  
The “Photo Album” list appears.  
Switch between the album list and JPEG image file list, if necessary.
- 2 Select an album or JPEG image file using **↑/↓**, and press **→**.
- 3 Select “Start Audio Slideshow,” and press ENTER.
- 4 Select the desired Music Playlist or “Favourites” using **←/→**.
- 5 Select “Start,” and press ENTER.  
The slideshow and the playback from the first track of the selected Music Playlist start.

### Notes

- While playing a slideshow with the sound, you cannot do the following:
  - Zoom, rotate, skip or pause an image.
  - Display information on the screen by pressing DISPLAY.
- If there is no audio track in the selected Music Playlist, the slideshow is played back with no sound.

---

## Creating a Slideshow with Your Favourite Music and Graphic Effects (x-Pict Story) (HDD only)

You can easily create and play your own slideshow with your favourite music in Music Playlist and graphic effects using the JPEG image files on the HDD (x-Pict Story). First prepare Music Playlists by adding audio tracks using Jukebox (see “Adding audio tracks to a Playlist (HDD only)” on page 81). The created x-Pict Story is automatically stored in the Title List (HDD) and you can copy it onto a recordable disc.

- 1 **Press SYSTEM MENU.**  
The System Menu appears.
- 2 **Select “Photo Album,” and press ENTER.**  
The “Photo Album” menu appears.
- 3 **Select “View/Edit Photos on the HDD,” and press ENTER.**  
The “Photo Album (HDD)” list appears.
- 4 **Select an album, and press →.**  
The sub-menu appears.
- 5 **Select “Create x-Pict Story” using ↑/↓, and press ENTER.**

## 6 Select a graphic effect and a Music Playlist using ←/↑/↓/→, and press ENTER.

- “Theme”: Select a theme. The recorder adds graphic effects according to the theme you set from the following:
  - “Happy moments (1)”: with simple graphic effects
  - “Happy moments (2)”: with simple graphic effects rapidly changing
  - “Nostalgic memories”: in monochrome
  - “Sweetest recollections”: with moving graphic effects
  - “Blissful life”: with moving graphic effects rapidly changing
  - “Normal”: no graphic effects
- “Play List”: Select the desired Music Playlist or “Favourites.” For an explanation of how to make a Music Playlist, see “Adding audio tracks to a Playlist (HDD only)” on page 81.

## 7 Select “Next,” and press ENTER.

The copyright message appears on the screen.

## 8 Select “Yes” using ←/→, and press ENTER.

The x-Pict Story is saved as a video file in the Title List on the HDD.

The title names are automatically labelled as “x-Pict\_Story \*\*\*” using the name of the selected album folder.

---

### To stop creating x-Pict Story

Press and hold ■ REC STOP for more than 3 seconds.

### Hints

- The order of audio tracks in the created x-Pict Story is followed by that of Music Playlist. If you want to change its order, change the order of Music Playlist before creating an x-Pict Story.
- If the selected folder has no name, the title names are automatically labelled with the date when the x-Pict Story was created.
- An x-Pict Story is created in the HQ mode.
- To edit x-Pict Story titles, see “Erasing and Editing” on page 58.

### Notes

- You cannot make a recording while creating an x-Pict Story.
- If there is no JPEG image file in the selected folder, you cannot create an x-Pict Story.
- If there is no audio track in the selected Music Playlist, the x-Pict Story is created with no sound.
- The selected Music Playlist may not be played back to the end depending on the number of JPEG image files.
- If the HDD is full, a warning message appears and you cannot create an x-Pict Story.
- While creating an x-Pict Story, you cannot do the following:
  - Zoom, rotate, skip or pause an image.
  - Display information on the screen by pressing DISPLAY.
- The order of graphic effects changes at random every time you create an x-Pict Story in the same theme.
- Do not disconnect or connect the USB cable or i.LINK cable while creating an x-Pict Story. This may cause the x-Pict Story to be created incorrectly.
- The graphic effect may not show a smooth motion or not appear correctly on the created x-Pict Story depending on conditions, such as size of the image files.

### To play an x-Pict Story

You can play a created x-Pict Story from the Title List on the HDD.

For details, see “3. Playing the Recorded Programme (Title List)” on page 33.

### To dub an x-Pict Story

You can dub a created x-Pict Story to DVDs. For details, see “Dubbing (HDD ↔ DVD)” on page 65. If you want to play the disc on other DVD equipment, finalise the disc (page 39).

---

# Managing JPEG Image Files on the HDD

## 1 Press SYSTEM MENU.

The System Menu appears.

## 2 Select “Photo Album,” and press ENTER.

The “Photo Album” menu appears.

## 3 Select “View/Edit Photos on the HDD,” and press ENTER.

The “Photo Album (HDD)” list appears.

## 4 Select an album or JPEG image file, and press →.

The sub-menu appears.

## 5 Select an option, and press ENTER.

You can make the following edits to the album/JPEG image file.

“Start Slideshow”: Starts a slideshow (page 90).

“Start Audio Slideshow” (HDD only): Starts a slideshow with the sound (page 91).

“Create x-Pict Story”: Creates a new x-Pict Story (page 91).

“New Album”: Creates a new album.

“Album Options”

- “Erase Album”: Erases the selected album.
- “Copy Album Contents”: Copies all JPEG image files in the selected album to the HDD (page 86).
- “Rename Album”: Changes the selected album name (page 37).
- “Protect Album Contents”: Protects all JPEG image files in the selected album.
- “Cancel Protection”: Cancels protection of all JPEG image files in the selected album.

“Copy to DVD”: Copies the selected album or JPEG image file to a DVD (page 86).

“Multi-Mode”: Selects multiple albums or JPEG image files to edit.

“Copy all to HDD”: Copies all the albums and JPEG image files to the HDD (page 84).

“Copy to HDD”: Copies the selected album or JPEG image file to the HDD (page 84).

“File Options”

- “Erase”: Erases the selected JPEG image file.
- “Copy”: Copies the selected JPEG image file (page 86).
- “Rename File”: Changes the selected JPEG image file name (page 37).
- “Protect”: Protects the selected JPEG image file. Select again to cancel the protection.

“Print”: Prints the selected JPEG image file (page 94).

“Detailed Information”: Displays the detailed information for the selected JPEG image file (page 90).

“Single-Mode”: Cancels “Multi-Mode.”

# Printing JPEG Image Files

You can print JPEG image files on the HDD, DATA DVDs/DATA CDs, or connected USB device by connecting a PictBridge-compatible printer to the USB jack on the recorder.

Refer to the instructions supplied with the printer.

## 1 Connect a PictBridge-compatible printer to the USB jack on the recorder.

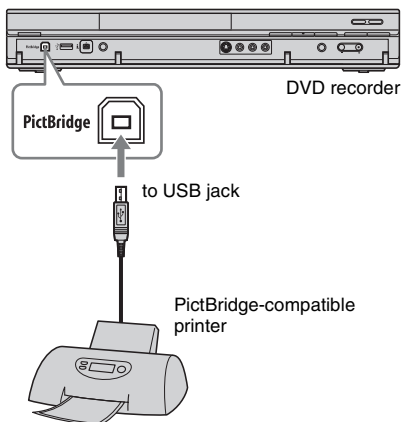

## 2 Connect the USB device to the USB jack on the recorder.

When printing JPEG image files on the HDD or DATA DVDs/DATA CDs, skip this step.

## 3 Press SYSTEM MENU.

The System Menu appears.

## 4 Select "Photo Album," and press ENTER.

The "Photo Album" menu appears.

## 5 Select the item, and press ENTER.

To print JPEG image files on the HDD, select "View/Edit Photos on the HDD." To print JPEG image files on a DATA DVD/DATA CD, select "View Photos on a DVD/CD."

To print JPEG image files from the connected USB device, select "View Photos on a USB Device."

The "Photo Album" list appears.

## 6 Select an album, and press ENTER.

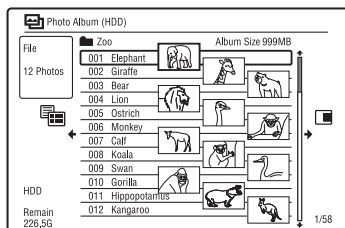

## 7 Select a file using ↑/↓, and press →.

The sub-menu appears.

## 8 Select the item, and press ENTER.

To print two or more files, select "Multi-Mode."

To print the file selected in step 7 only, go to step 12.

## 9 Select a file, and press ENTER.

A check mark appears in the check box by the selected item.

- To clear the check mark, press ENTER again.
- To clear all check marks, select "Single-Mode."

## 10 Repeat step 9 to select all files you want to print.

## 11 Press →.

The sub-menu appears.

## 12 Select "Print," and press ENTER.

The display asks for confirmation.

## 13 Select "Start," and press ENTER.

You can set the paper size and layout. Refer to the operating instructions supplied with the printer.

**To cancel printing**

Press ENTER.

**To display the connected printer**

Select “Confirm Printer” of “USB” in the “Options 2” setup (page 117).

**To restart the connected USB device**

Select “Restart USB Device” of “USB” in the “Options 2” setup (page 117).

 **Hint**

Printing options, such as paper size or layout, differ depending on the printer. For details, refer to the instructions supplied with the printer.

## Adjusting Picture Quality



\* DivX video file only

You can adjust the picture quality from the connected equipment, such as a TV or VCR, and also the picture quality of broadcasts that the recorder can receive by selecting a preset setting. You can also adjust the picture quality by changing detailed settings, and store up to three settings in the memory.

### 1 Press SYSTEM MENU in stop mode.

For adjusting playback picture quality, press SYSTEM MENU during playback.

The System Menu appears.

### 2 Select "Picture Adjustment," and press ENTER.

### 3 Select a preset setting using ←/→, and press ENTER.

#### For recording

Tuner	TV broadcast
VCR	Video cassettes
DTV	Digital broadcast
Memory1/ Memory2/ Memory3	Your own settings. To create your own settings, see "To create your own setting" on page 96.

#### For playback

Dynamic	Produces a bold dynamic picture by increasing the picture contrast and the colour intensity.
Standard	Displays a standard picture.
Professional	Displays an original picture.
Memory1/ Memory2/ Memory3	Your own settings. To create your own settings, see "To create your own setting" on page 96.

To check the detailed settings for the selected preset, press DISPLAY.

### 4 Press SYSTEM MENU to exit.

#### To create your own setting

1 Select "Memory1," "Memory2," or "Memory3" in step 3.

2 Select "Detailed Settings," and press ENTER.

The display for adjusting detailed settings appears.

3 Select an item using ↑/↓, and adjust settings using ←/→.

For explanation of each setting, see the tables below.

4 Press SYSTEM MENU to exit.

The setting is automatically stored as the setting you selected in step 1.



### ◆ Setting options for recording picture quality

For details about each setting, see the explanation of the display.

Prog. Motion	Adjusts the progressive video signal when “Component Video Out” is set to “Progressive” (page 105) or when using the HDMI connection. Select “Motion” for a picture, including subjects that move dynamically. Select “Still” for a picture with little movement.
Cinema	Converts the progressive video signal to match the type of DVD software that you are watching when “Component Video Out” is set to “Progressive” (page 105) or when using the HDMI connection. Select “Auto” to detect the software type (Film-based or Video-based) automatically and select the appropriate conversion mode. Normally select this position. Select “Off” to fix the conversion mode to the mode for Video-based software.
3-D Y/C	Adjusts the brightness/colour separation for the video signals. Select “Motion” for a picture, including subjects that move dynamically. Select “Still” for a picture with little movement.
YNR (luminance noise reduction)	Reduces noise contained in the luminance element of the video signal.
CNR (chroma noise reduction)	Reduces noise contained in the chroma element of the video signal.
Detail	Adjusts the sharpness of images outlines.
White AGC	Turn on for automatic white level adjustment.

White Enhancer	Adjusts the intensity of white.
Black Enhancer	Adjusts the intensity of black.
Black Level	Selects the black level (setup level) for the NTSC video signals. Select “ON” to set the black level of the input signals to the standard level. Normally, select “OFF” position.
Hue	Adjusts the colour balance.
Chroma Level	Makes the colours deeper or lighter.

### ◆ Setting options for playback picture quality

For details about each setting, see the explanation of the display.

Prog. Motion	Adjusts the progressive video signal when “Component Video Out” is set to “Progressive” (page 105) or when “Screen Resolution” is set to other than “720 x 576i” (or “720 x 480i”) (page 113). Select “Motion” for a picture, including subjects that move dynamically. Select “Still” for a picture with little movement.
Cinema	Converts the progressive video signal to match the type of DVD software that you are watching when “Component Video Out” is set to “Progressive” (page 105) or when “Screen Resolution” is set to other than “720 x 576i” (or “720 x 480i”) (page 113). Select “Auto1” to automatically detect the software type (Film-based or Video-based) and select the appropriate conversion mode. Normally select this position. If the picture appears unnatural, select “Auto2,” “On,” or “Off.”

YNR (luminance noise reduction)	Reduces noise contained in the luminance element of the video signal.
BNR (block noise reduction)	Reduces "block noise" or mosaic-like patterns in the picture.
MNR (mosquito noise reduction)	Reduces the faint noise appearing around the outlines of the images. The noise reduction effects are automatically adjusted within each setting range according to the video bit rate and other factors.
Sharpness	Sharpens the outlines of the images.
Detail	Adjusts the sharpness of images outlines.
White Enhancer	Adjusts the intensity of white.
Black Enhancer	Adjusts the intensity of black.
Black Level	Selects the black level (setup level) for the video signals. Select "ON" to raise the black level. Select this when the picture appears too dark. Select "OFF" to set the black level of the input signals to the standard level. Normally, select this position.
Gamma Correction	Adjusts how dark areas look.
Hue	Adjusts the colour balance.
Chroma Level	Makes the colours deeper or lighter.

## 🔊 Notes

- If the outlines of the images on your screen become blurred, set "BNR" and/or "MNR" to "Off."
- Depending on the disc or the scene being played, the above BNR or MNR effects may be hard to discern. Also, these functions may not work with some screen sizes.
- The following settings are not available for the signals output from the HDMI jack.
  - "Sharpness"
  - "White Enhancer"
  - "Black Enhancer"
  - "Black Level"
  - "Gamma Correction"
  - "Hue"
  - "Chroma Level"

## Using the Setup Menus

You can change the settings of the recorder, such as picture quality settings, audio settings, etc.

- 1** Press **SYSTEM MENU** while the recorder is in stop mode.
- 2** Select “Disc Setup” or “Initial Setup” using **↑/↓**, and press **ENTER**.
- 3** Select the desired setup item using **↑/↓**, then press **ENTER**.

See the explanations in the following sections.

The default settings are underlined.

## Disc Settings (Disc Setup)

You can adjust DVD related settings.

### Basic

#### Input Disc Name

You can label a disc.

For details, see page 38.

#### Protect Disc

You can protect a disc against erasure.

For details, see page 38.

#### Format DVD-RW (DVD-RW only)

The recorder automatically starts formatting in VR mode or Video mode, whichever is selected below, when a new, unformatted DVD-RW is inserted.

<u>VR Mode</u>	Automatically formats the disc in VR mode.
Video Mode	Automatically formats the disc in Video mode.

### Format

You can manually re-format a DVD+RW, DVD-RW, or DVD-R disc to make a blank disc.

For details, see page 42.

### Finalise

Finalises a disc to play it on other DVD equipment.

For details, see page 39.

## Optimise HDD

As you record, erase and edit recordings repeatedly, the HDD file system gradually becomes fragmented. To 'clean up' all the fragmented files, optimise the HDD periodically. When the HDD needs optimising, a message recommending optimisation will appear automatically. To cancel optimisation, press ENTER. The HDD will be partly optimised.

### 🔌 Notes

- It will take about eight hours to optimise the HDD. During optimisation, other operations, such as recording or playback, cannot be performed.
- You cannot optimise the HDD when the HDD disc space is insufficient for optimising. Erase titles to open up disc space (page 59).

## Format HDD.

You can format the HDD and resolve the problem when the hard disk error occurred. "Format HDD." can be selected only when the hard disk needs formatting. Note that all of the recorded content on the HDD will be erased.

## Recorder Settings (Basic)

You can make clock and other recorder-related settings.

### Clock Setting

#### Auto (Auto Clock Set)

Turns on the Auto Clock Set function when a programme position in your local area broadcasts a time signal.

- 1 Press **←/→** repeatedly until the programme position of the station that carries a time signal appears.
- 2 Press **↓** to select "Start," and press ENTER.
  - If the recorder does not receive a time signal from any station, press **↶** RETURN and set the clock manually.
  - If the Auto Clock Set function did not set the clock correctly for your local area, try another station for the Auto Clock Set function or set the clock manually.

### 🔌 Note

The Auto Clock Set function does not work while the recorder is standing by for Synchro-Recording.

#### Manual (Manual Clock Set)

Set the clock manually.

- 1 Press **←/→** to select the time zone for your area or GMT (Greenwich Mean Time), and press **↓**.
- 2 Select "On" using **←/→** if you are now on summer time, and press ENTER.
- 3 Set the day, month, year, hour, and minutes using **←/↑/↓/→**, and press ENTER to start the clock.

To change the numbers, press **←** to return to the item to be changed, and press **↑/↓**.

## Input Line System

Selects the colour system when recording from the connected equipment.

NTSC	Records in NTSC or PAL-60 colour system.
<u>PAL/SECAM</u>	Records in PAL or SECAM colour system.

### Notes

- When picture noise appears after you change the “Input Line System” setting, change the “Input Colour System” setting (page 105). If picture noise still appears, hold down **■** (stop) on the recorder, and press INPUT on the recorder.
- When you change the “Input Line System” setting, the Dubbing List is erased.

## Power Save

Selects whether this recorder is in power save mode when the power is turned off (standby).

Mode 1	Only aerial input signals are output to the connected TV when the recorder is in standby.
Mode 2	No input signals are output when the recorder is in standby.
<u>Off</u>	Does not set to power save mode. Normally, select this setting.

### Note

Power Save mode does not function in the following cases, even when “Power Save” is set to “Mode 1” or “Mode 2.”

- Synchro-Recording is set.
- There is a timer setting with “VPS/PDC” set to “On” in the Timer List.
- The SMARTLINK features are not available when “Power Save” is set to “Mode 1” or “Mode 2.”

## HELP Setting

<u>On</u>	Displays Help information for GUI displays.
Off	Does not set to HELP setting mode.

## Easy Setup (Resetting the Recorder)

Select this to run the “Easy Setup” programme.

Follow the instructions for “Easy Setup” (page 24) from step 2.

# Aerial Reception Settings (Tuner)

You can make tuner and programme position settings for the recorder.

## Auto Channel Setting

### Auto Scan

If you connect a TV to this recorder not using SMARTLINK, you can preset programme positions automatically using “Auto Scan.”

Select your country/region using  $\leftarrow/\rightarrow$ , and press ENTER.

The programme position order will be set according to the country/region you set. If any programme positions are unused or contain unwanted channels, you can disable them (page 102).

### Download from TV

If you connect a TV to this recorder with SMARTLINK, you can preset programme positions by downloading from your TV. For details, refer to the operating instructions supplied with your TV.

Select your country/region using  $\leftarrow/\rightarrow$ , and press ENTER.

The tuner preset data will be downloaded from your TV to this recorder.

If any programme positions are unused or contain unwanted channels, you can disable them (page 102).

## Manual CH Setting

Presets programme positions manually.

If some programme positions could not be set using the “Easy Setup” function, you can set them manually.

If there is no sound or if the picture is distorted, the wrong tuner system may have been preset during “Easy Setup.” Set the correct tuner system manually in the steps below.

- 1 Select your country/region using  $\leftarrow/\rightarrow$ , and press ENTER.

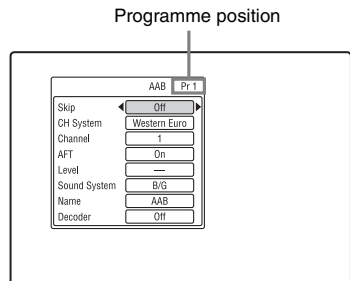

- 2 Press PROG +/- to select the programme position.
- 3 Select the item you want to change using  $\uparrow/\downarrow$ , and change the settings using  $\leftarrow/\rightarrow$ , then press ENTER.
  - To preset another programme position, repeat from step 2.

### Skip

On	Select this when the programme position is unused or contains unwanted programme positions. The selected position will be skipped when you press PROG +/-.
Off	Does not skip the selected programme position.

## CH System

Select the region to get the best broadcast reception.

FR	Select this when in France.
Western Euro	Select this when in West European countries.
UK & IE	Select this when in Great Britain/Ireland.
Eastern Euro	Select this when in East European countries.

## Channel

Press  $\leftarrow/\rightarrow$  repeatedly until the programme position you want is displayed.

- To select a cable or satellite programme position, press  $\leftarrow/\rightarrow$  until the programme position you want is displayed.

## ◆ Receivable channels

TV system	Channel coverage
BG (West European Countries, except those listed below)	E2 – E12 VHF
	Italian A – H VHF
	E21 – E69 UHF
	S1 – S20 CATV
	S21 – S41 HYPER
	S01 – S05 CATV
DK (East European Countries)	R1 – R12 VHF
	R21 – R69 UHF
	S1 – S20 CATV
	S21 – S41 HYPER
	S01 – S05 CATV
I (Great Britain/Ireland)	Ireland A – J VHF
	South Africa 4 – 11, 13 VHF
	B21 – B69 UHF
	S1 – S20 CATV
	S21 – S41 HYPER
	S01 – S05 CATV
L* (France)	F2 – F10 VHF
	F21 – F69 UHF
	B – Q CATV
	S21 – S41 HYPER

\* To receive broadcasts in France, select “L.”

## ◆ Tuning the French CATV channels

This recorder can scan the CATV channels B to Q and the HYPER frequency channels S21 to S41. On the Channel Set menu, the channels are indicated as CC1 to CC44. For example, channel B is indicated by Channel Set number CC1, and channel Q is indicated by Channel Set number CC23 (see the table below). If the CATV channel you want to preset is indicated by its frequency (for example, 152.75 MHz), refer to the table below to find the corresponding channel number.

Corresponding channel	Channel Set number	Receivable Frequency range (MHz)
B	CC1	116.75–124.75
C	CC2	124.75–132.75
D	CC3	132.75–140.75
D	CC4	140.75–148.75
E	CC5	148.75–156.75
F	CC6	156.75–164.75
F	CC7	164.75–172.75
G	CC8	172.75–180.75
H	CC9	180.75–188.75
H	CC10	188.75–196.75
I	CC11	196.75–204.75
J	CC12	204.75–212.75
J	CC13	212.75–220.75
K	CC14	220.75–228.75
L	CC15	228.75–236.75
L	CC16	236.75–244.75
M	CC17	244.75–252.75
N	CC18	252.75–260.75
N	CC19	260.75–268.75
O	CC20	268.75–276.75
P	CC21	276.75–284.75
P	CC22	284.75–292.75
Q	CC23	292.75–300.75
S21	CC24	299.25–307.25
S22	CC25	307.25–315.25
S23	CC26	315.25–323.25
S24	CC27	323.25–331.25

Corresponding channel	Channel Set number	Receivable Frequency range (MHz)
S25	CC28	331.25–339.25
S26	CC29	339.25–347.25
S27	CC30	347.25–355.25
S28	CC31	355.25–363.25
S29	CC32	363.25–371.25
S30	CC33	371.25–379.25
S31	CC34	379.25–387.25
S32	CC35	387.25–395.25
S33	CC36	395.25–403.25
S34	CC37	403.25–411.25
S35	CC38	411.25–419.25
S36	CC39	419.25–427.25
S37	CC40	427.25–435.25
S38	CC41	435.25–443.25
S39	CC42	443.25–451.25
S40	CC43	451.25–459.25
S41	CC44	459.25–467.25

## AFT

On	Turns on the Auto Fine Tuning function. Normally select this position.
Off	Allows you to adjust the picture manually.

- If the Auto Fine Tuning function does not work effectively, select “Off” and press  $\downarrow$ . Press  $\leftarrow/\rightarrow$  to obtain a clearer picture, and press ENTER.

## Sound System

Select an available TV system (page 103).

B/G	Select this when in West European countries, except those listed in “Receivable channels” on page 103.
D/K	Select this when in East European countries.
I	Select this when in Great Britain/Ireland.
L	Select this when in France.

## Name

Changes or enters a new station name (up to 5 characters). The recorder must receive programme position information (e.g., SMARTLINK information) for station names to appear automatically.

Press  $\rightarrow$ , then press  $\leftarrow/\rightarrow$  repeatedly to select a character.

To change the characters, press  $\uparrow/\downarrow$  to move the cursor, and press  $\leftarrow/\rightarrow$ .

## Decoder

Sets the external decoder (PAY-TV/Canal Plus analogue decoder) channels.

For details, see page 30.

## Channel Swapping

After the programme positions have been set, you can change the order of each programme position in the display list.

- 1 Press  $\uparrow/\downarrow$  to select the programme position number you want to swap, and press  $\rightarrow$ .
  - To display other pages, press  $\leftarrow/\rightarrow$  repeatedly.
- 2 Press  $\uparrow/\downarrow$  to select the programme position number to swap for the one selected in step 1, and press ENTER. The programme position numbers are swapped.
  - To swap the programme position number of another station, repeat from step 1.



## Video Settings (Video In/Out)

You can adjust items related to the image, such as size and colour, according to the type of TV, tuner, or decoder connected to the recorder.

### Input Colour System

Selects the colour system when picture noise appears after you change the “Input Line System” setting (page 101).

<u>Auto</u>	Recorder automatically detects signals of colour systems and selects the appropriate colour system.
PAL	Selects the PAL colour system when “Input Line System” is set to “PAL/SECAM.”
SECAM	Selects the SECAM colour system when “Input Line System” is set to “PAL/SECAM.”

#### Hint



When “Input Line System” is set to “NTSC,” you can select “Auto,” “3.58NTSC,” or “PAL-60.”

### Component Video Out

Selects the signal format in which the recorder outputs video signals: interlace or progressive, from the COMPONENT VIDEO OUT jacks.

<u>Normal(Inter-lace)</u>	Outputs signals in the interlace format.
Progressive	Outputs signals in the progressive format. Select this when you want to view progressive signals.

#### Notes

- When you set “LINE 3 Out” to “RGB,” you cannot set “Component Video Out.”
- When you connect the recorder to a monitor or projector via only the COMPONENT VIDEO OUT jacks, do not set “LINE 3 Out” to “RGB.” If you set “LINE 3 Out” to “RGB,” in this case, the picture may not appear.
- When picture noise appears after you set the recorder to progressive format, hold down  (stop) on the recorder, and press  (open/close) on the recorder.
- No video signals are output when using the HDMI connection.

### LINE 3 Out

Selects a method of outputting video signals for the LINE 3 – TV jack.

<u>Video</u>	Outputs video signals.
S-Video	Outputs S-video signals.
RGB	Outputs RGB signals.

#### Notes

- If your TV does not accept S-video or RGB signals, the image will not be displayed in the selected method on the TV screen even if you select “S-Video” or “RGB.” Refer to the instructions supplied with your TV.
- SMARTLINK is available only when “Video” is selected.
- RGB signals are not output when using the HDMI connection.

## LINE 1 In

Selects a method of inputting video signals for the LINE 1/DECODER jack. The picture will not be clear if this setting does not match the type of video input signal.

<u>Video</u>	Inputs video signals.
S-Video	Inputs S-video signals.
RGB	Inputs RGB signals.
Decoder	Select this when connecting to an external decoder (PAY-TV/Canal Plus analogue decoder). If you connect to a cable box/satellite receiver such as CanalSat, do not select this option.

## NTSC on PAL TV

Sets the recorder to convert signals of the NTSC colour system to the PAL colour system to play NTSC discs on PAL-only TVs. Refer to the operating instructions supplied with your TV.

<u>On</u>	Plays NTSC discs on PAL-only TVs.
<u>Off</u>	Select this if the connected TV is a multi-system (NTSC-compatible) TV.

## Audio Input Settings (Audio In)

You can adjust the sound according to the playback and connection conditions.

### NICAM Select

For details on NICAM system, see page 45.

<u>NICAM</u>	Normally select this position.
Standard	Select this if the sound from NICAM broadcasts is not clear.

### Tuner Level

If the playback sound is distorted, set this item to "Compression." The recorder reduces the audio output level.

This function affects the output of the following jacks:

- LINE 2 OUT R-AUDIO-L jacks
- LINE 3 – TV jack
- LINE 1/DECODER jack

<u>Normal</u>	Normally select this position.
Compression	Select this when the playback sound from the speakers is distorted.

### External Audio

<u>Stereo</u>	Select this when receiving stereo programmes from connected equipment.
Bilingual	Select this when receiving bilingual programmes from connected equipment.

## Note

When receiving audio input signals from the DV input jack, the recorder automatically selects “Stereo” or “Bilingual” regardless of the “External Audio” setting.

## Bilingual Recording

Selects the sound to be recorded.

<u>A/L</u>	Records the main sound for the bilingual programme.
B/R	Records the sub sound for the bilingual programme.

## Note

When recording a bilingual audio signal to the HDD (when “HDD Recording Format” is set to “Video Mode Off” (page 111) (except in PCM mode)) or a DVD-RW/DVD-R in VR mode (except in PCM mode), both audio channels are recorded and you can select the sound when playing.

## DV Input

Select the setting for the audio input when DV camcorder dubbing.

Select “Mix (Stereo 1: 75 %)”/“Mix (Stereo 1: 50 %)”/“Mix (Stereo 1: 25 %)” or “Stereo 2” only if you have added a second audio when recording with your digital video camera.

<u>Stereo 1</u>	Records original sound only. Normally select this when dubbing a DV format tape.
Stereo 2	Records additional audio only.
Mix (Stereo 1: 75 %)	Records both stereo 1 and 2.
Mix (Stereo 1: 50 %)	
Mix (Stereo 1: 25 %)	

## Audio Output Settings (Audio Out)

You can switch the method of outputting audio signals when you connect a component such as an amplifier (receiver) with a digital input jack.

## Note

If you connect a component that does not accept the selected audio signal, a loud noise (or no sound) will come from the speakers, and may affect your ears or cause speaker damage.

## Dolby Digital Output (HDD/ DVDs only)

Selects the type of Dolby Digital signal.

<u>Dolby Digital</u>	Select this when the recorder is connected to an audio component with a built-in Dolby Digital decoder.
Dolby Digital -> PCM	Select this when the recorder is connected to an audio component lacking a built-in Dolby Digital decoder.

## Note

If the HDMI OUT jack is connected to equipment not compatible with Dolby Digital signals, the PCM signals will be automatically output even when you select “Dolby Digital.”

## DTS Output (DVD VIDEOS only)

Selects whether or not to output DTS signals.

<u>On</u>	Select this when the recorder is connected to an audio component with a built-in DTS decoder.
Off	Select this when the recorder is connected to an audio component without a built-in DTS decoder.

### Note

When HDMI output is performed to equipment not compatible with DTS signals, the signals will not be output regardless of the “DTS Output” setting.

## 96 kHz PCM Output (DVD VIDEOS only)

Selects the sampling frequency of the audio signal.

<u>96 kHz -&gt;</u> <u>48 kHz</u>	The audio signals of DVD VIDEOS are converted to 48 kHz and output.
96 kHz	All signals containing 96 kHz are output without conversion. However, the signals are output at 48 kHz if copyright-protected signals are contained.

### Notes

- “96 kHz PCM Output” setting has no effect when audio signals are output from the LINE 2 OUT (R-AUDIO-L) jacks or LINE 3 – TV/LINE 1/DECODER jack. If the sampling frequency is 96 kHz, signals are simply converted to analogue signals and output.
- If the HDMI OUT jack is connected to equipment not compatible with 96 kHz signals, 48 kHz PCM will be automatically output even when you select “96 kHz.”

## MPEG Output (DVD VIDEOS only)

Selects the type of MPEG audio signal.

MPEG	Select this when the recorder is connected to an audio component with a built-in MPEG decoder.
<u>MPEG -&gt;</u> <u>PCM</u>	Select this when the recorder is connected to an audio component without a built-in MPEG decoder. If you play MPEG audio sound tracks, the recorder outputs stereo signals via the DIGITAL OUT (COAXIAL) jack.

### Note

If the HDMI OUT jack is connected to equipment not compatible with MPEG audio signals, the PCM signals will be automatically output even when you select “MPEG.”

## Audio DRC (Dynamic Range Control) (DVDs only)

Selects the dynamic range (difference between soft and loud sounds) setting when playing a DVD that conforms to “Audio DRC.” This affects the output from the following jacks:

- LINE 2 OUT R-AUDIO-L jacks
- LINE 3 – TV jack
- LINE 1/DECODER jack
- DIGITAL OUT (COAXIAL)/HDMI OUT jack only when “Dolby Digital Output” is set to “Dolby Digital -> PCM” (page 107).

On	Makes low sounds clear even if you turn the volume down.
<u>Off</u>	Normally select this position.

## Language Settings (Language)

You can make language settings.

### OSD Language

Switches the display language on the screen.

### Audio Language (DVD VIDEO only)

Switches the language of the sound track.

### Subtitle Language (DVD VIDEO only)

Switches the language of the subtitles recorded on the disc.

### Auto Language

The “Auto Language” function is available when “Audio Language” and “Subtitle Language” are set to the same language, and “Subtitle Display” is set to “On.”

<u>On</u>	For DVD VIDEOS whose main audio track is the language you set in “Audio Language” and “Subtitle Language,” the recorder plays the main audio track without subtitles. For DVD VIDEOS whose main audio track is not the language you set in “Audio Language” and “Subtitle Language,” the recorder plays the main audio track with subtitles in the language you set.
Off	Turns off the function.

### DVD Menu Language (DVD VIDEO only)

Switches the language for the DVD menu. Select “w/Subtitle Language” to set the same language as the language you set in “Subtitle Language.”

### Subtitle Display

<u>On</u>	Displays subtitles.
Off	Does not display subtitles.
Assist Subtitle	Displays special assistive subtitles, where available.

#### Hint

If you select “Others” in “Audio Language,” “Subtitle Language,” or “DVD Menu Language,” press **↓**, and enter a language code from “Language Code List” on page 132.

#### Note

If you select a language in “DVD Menu Language,” “Subtitle Language,” or “Audio Language” that is not recorded on the DVD VIDEO, one of the recorded languages will be automatically selected.

## Recording Settings (Recording)

You can adjust recording settings.

### Manual Rec. Mode

You can select further options for recording mode (manual recording mode). The default setting is "Off" (standard recording mode). You can check the approximate recording times for the HDD and the different DVD types in each recording mode on page 129.

- 1 Select "On (go to setup)" using  $\uparrow/\downarrow$ , and press ENTER.
- 2 Select a recording mode using  $\leftarrow/\rightarrow$ , and press ENTER.  
To easily select a manual recording mode, press REC MODE repeatedly to display "MN," and select a manual recording mode using  $\leftarrow/\rightarrow$ .

### Rec. Mode Adjust

On	Automatically adjusts the recording mode to enable the entire programme to be recorded (page 44).
<u>Off</u>	Turns off the function.

### Set Thumbnail

Selects a scene for the thumbnail picture shown in the Title List.

<u>0 seconds</u>	The first frame of the title is set for the thumbnail picture.
30 seconds	The frame at 30 seconds from the first frame is set for the thumbnail picture.
3 minutes	The frame at 3 minutes from the first frame is set for the thumbnail picture.

### Auto Chapter (HDD/VR) (HDD/DVD-RW/DVD-R in VR mode only)

<u>On</u>	The recorder detects changes in the picture and sound and automatically inserts chapter marks (up to 99 chapters for one title recorded on the HDD).
Off	No chapter mark is inserted.

#### Notes

- The actual chapter mark interval may vary depending on the amount of information contained in the video to be recorded.
- Chapter marks are automatically inserted, where the date or time information changes on the tape, when "Auto Chapter (HDD/VR)" is set to "On" during DV dubbing to the HDD or a DVD-RW/DVD-R (VR mode).

### Auto Chapter (Video) (DVD-RW/DVD-R in Video mode only)

No Separation	No chapter mark is inserted.
<u>10 minutes</u>	Inserts chapter marks at approximately 10-minute intervals.
15 minutes	Inserts chapter marks at approximately 15-minute intervals.

## Auto Chapter (DVD+R/+RW) (DVD+RW/DVD+R only)

No Separation	No chapter mark is inserted.
<u>10 minutes</u>	Inserts chapter marks at approximately 10-minute intervals.
15 minutes	Inserts chapter marks at approximately 15-minute intervals.

## HDD Recording Format

Selects the HDD recording format.

Video Mode Off	Records to the HDD in VR mode. When recording stereo and bilingual programmes, both main and sub sounds can be recorded.
<u>Video Mode On</u>	Records to the HDD in Video mode. When recording stereo and bilingual programmes, only one sound track (main or sub) can be recorded. Set "Bilingual Recording" to "A/L" (default) or "B/R" in the "Audio In" setup (page 107).

### Hint

The HDD contents recorded in Video mode can be dubbed to a disc at high speed (page 65).

## Playback Settings (Playback)

You can adjust playback settings.

### TV Type

Select the playback picture size according to the type of connected TV (wide-screen/wide mode TV or conventional 4:3 screen TV).

4:3 Letter Box	Select this when connecting to a 4:3 screen TV. Displays a wide picture with bands on the upper and lower portions of the screen.
4:3 Pan Scan	Select this when connecting to a 4:3 screen TV. Automatically displays a wide picture on the entire screen and cuts off the portions that do not fit.
<u>16:9</u>	Select this when connecting to a wide-screen TV or TV with a wide mode function.

4:3 Letter Box



4:3 Pan Scan



16:9



### Note

Depending on the disc, "4:3 Letter Box" may be selected automatically instead of "4:3 Pan Scan" or vice-versa.

## Pause Mode

Selects the picture quality in pause mode.

Field	Outputs a stable, generally shake-free image.
Frame	Outputs a sharp image, but may be prone to shake.
Auto	Outputs a generally less sharp but more stable still image.

## Seamless Playback (HDD/DVD-RW/DVD-R in VR mode only)

On	Playback is smooth, but with a trade-off against the accuracy of the edit points.
Off	You may notice momentary interruption at edited points during playback of a VR mode Playlist.

## Parental Control (DVD VIDEO only)

Playback of some DVD VIDEOS can be limited according to a predetermined level, such as the age of the users. Scenes may be blocked or replaced with different scenes.

- 1 Select "Parental Control" in "Playback," and press ENTER.

When you have already registered a password, go to step 4.

- 2 Select "Set Password," and press ENTER.

The display for registering a new password appears.

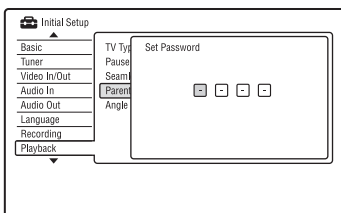

- 3 Enter your four-digit password using the number buttons, and press ENTER.

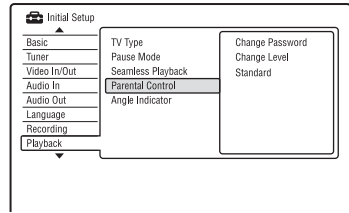

- 4 Select "Standard," and press ENTER. The "Parental Control : Standard" display appears.

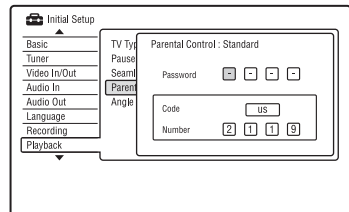

- 5 Enter your four-digit password using the number buttons, and press ENTER.

- 6 Select "Code" (geographic area) as the playback limitation level, and press ENTER.

The area is selected.

- When you select "Number," press the number buttons to select and enter a country/area code in the table (page 132), and press ENTER.

- 7 Select "Change Level," and press ENTER.

The "Parental Control : Change Level" display appears.

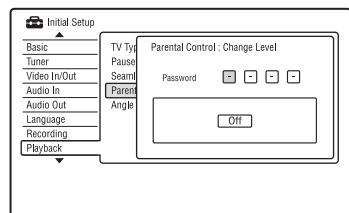

- 8 Enter your four-digit password using the number buttons, and press ENTER.

- 9 Select the level.

The lower the value, the stricter the limitation.

Discs rated higher than the selected level will be restricted.



## 10 Press ENTER.

The Parental Control setting is complete.

To cancel the Parental Control setting for the disc, select “Off” in step 9.

### Change Password

- 1 Select “Parental Control” in “Playback,” and press ENTER.
- 2 Select “Change Password,” and press ENTER.
- 3 Enter your four-digit password in the “Current Password” row using the number buttons, and press ENTER.
- 4 Enter a new password in the “New Password” row using the number buttons, and press ENTER.

#### ⚡ Notes

- If you forget your password, reset the recorder (page 124).
- When you play discs which do not have the Parental Control function, playback cannot be limited on this recorder.
- Depending on the disc, you may be asked to change the Parental Control level while playing the disc. In this case, enter your password, then change the level.

### Angle Indicator (DVD VIDEOS only)

On	Displays “  <h2>HDMI Settings (HDMI Output)</h2>
----	--

You can adjust items related to the HDMI connection.

#### ⚡ Note

You can select “HDMI Output” only when connecting equipment to the HDMI OUT jack.

### Screen Resolution

Selects the type of video signals output from the HDMI OUT jack. If the picture is not clear, natural or to your satisfaction, try another option that suits the disc and your TV/projector, etc. For details, refer also to the instruction manual supplied with the TV/projector, etc.

1920 x 1080p	Sends 1920x1080p video signals.
1920 x 1080i	Sends 1920x1080i video signals.
1280 x 720p	Sends 1280x720p video signals.
720 x 576p <sup>*1</sup>	Sends 720x576p video signals.
720 x 480p <sup>*2</sup>	Sends 720x480p video signals.
720 x 576i <sup>*1</sup>	Sends 720x576i video signals.
720 x 480i <sup>*2</sup>	Sends 720x480i video signals.

<sup>\*1</sup> Can be selected only when “Input Line System” is set to “PAL/SECAM” in the “Basic” setup (page 101).

<sup>\*2</sup> Can be selected only when “Input Line System” is set to “NTSC” in the “Basic” setup (page 101).

## Notes

- When picture noise appears after you change the “Screen Resolution” setting, hold down **■** (stop) on the recorder, and press **▲** (open/close) on the recorder.
- When “Colour” is set to “YCbCr 4:2:2” in the “HDMI Output” setup, you cannot select “720 x 576i” (or “720 x 480i”).

## 4:3 Video Output

This setting is effective only when you set “TV Type” to “16:9” in the “Playback” setup.

Adjust this setting to watch 4:3 aspect ratio signals. If you can change the aspect ratio on your TV, change the setting on your TV, not this recorder.

Note that this setting is effective only for HDMI connection.

Full	Select this when you can change the aspect ratio on your TV.
Normal	Select this when you cannot change the aspect ratio on your TV. Shows a 4:3 size video with the aspect ratio as it is.

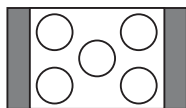

16:9 aspect ratio TV

## Colour

Selects the method of outputting video signals for the HDMI jack.

RGB (0-255)	Outputs RGB (0-255) signals. Select this when connecting to an RGB (0-255) device.
RGB (16-235)	Outputs RGB (16-235) signals. Select this if colours appear overly rich and the black appears too deep.
YCbCr 4:2:2	Outputs 10-bit YCbCr 4:2:2 component signals.
YCbCr 4:4:4	Outputs 8-bit YCbCr 4:4:4 component signals.

## Notes

- Some settings may not be available depending on the connected device.
- When a DVI device is connected, you cannot select “YCbCr 4:2:2” or “YCbCr 4:4:4.”
- When “Screen Resolution” is set to “720 x 576i” (or “720 x 480i”) in the “HDMI Output” setup, you cannot select “YCbCr 4:2:2.”

## Audio Output

Selects the type of audio signal output from the HDMI OUT jack.

<u>Auto</u>	Outputs Dolby Digital, MPEG and DTS audio signals as a bitstream signal. Normally select this position.
PCM	Converts all audio signals except for DTS signals to PCM.
Bitstream Priority	Select this if the connected device is compatible with bitstream audio.

## Notes

- The PCM signals may not be output even when you select “Auto” depending on the “Audio Out” settings, number of audio channels, and the HDMI-connected device.
- The “Audio Output” function is not available when a DVI device is connected.

## Control for HDMI

<u>On</u>	Allows you to use the “Control for HDMI” function (page 19).
Off	Turns off the function.

## Other Settings (Options)

You can make other operation settings.

### On Screen Display

<u>On</u>	Automatically displays information on the screen when the recorder is turned on, etc.
Off	Displays information only when DISPLAY is pressed.

### Front Panel Display

Adjusts the lighting of the front panel display.

<u>On</u>	Bright lighting.
Off	Turns off the lighting when the power is off.

### Command Mode

Changes the Command Mode of the recorder to avoid interference with your other Sony DVD recorder or player.

- 1 Select a Command Mode (“1,” “2,” or “3 (Default setting)”), and press ENTER.

#### Note

The default command mode setting for this recorder and the supplied remote is “3 (Default setting).”

The remote does not function if different command modes are set for the recorder and remote. Set the same command mode.

- 2** Set the Command Mode for the remote so it matches the Command Mode for the recorder you set above.
- Follow the steps below to set the Command Mode on the remote.
- ① Hold down ENTER.
  - ② While holding down ENTER, enter the Command Mode code number using the number buttons.
  - ③ Hold down both the number and ENTER buttons at the same time for more than three seconds.

 **Hint**

You can check the Command Mode for the recorder in the front panel display (page 13). When the Command Mode is set to “3 (Default setting),” “1” or “2” does not appear.

## SMARTLINK

<u>This Recorder Only</u>	Allows you to use the SMARTLINK function with the recorder when the recorder is in standby mode.
Pass Through	Allows you to use the SMARTLINK function with the connected equipment when the recorder is in standby mode.

 **Note**

Set “Power Save” to “Off” in the “Basic” setup (page 101) to set “SMARTLINK” to “Pass Through.”

## DivX

### Registration Code

Displays the registration code of DivX video files for this recorder.

For more information, go to <http://www.divx.com/vod> on the Internet.

## Set Preview (HDD only)

Selects the thumbnail type shown in the Title List.

<u>Quick Preview</u>	Plays short excerpts from throughout the selected title.
Normal	Plays the selected title from the beginning.

---

## Other Settings (Options 2)

You can make other operation settings.

### USB

#### Restart USB Device

Restarts the connected USB device if it does not respond to the recorder. If the connected USB device still does not work properly, try following:

- Turn the connected USB device off and on again.
- Disconnect and then connect the USB cable.

#### Confirm Printer

Displays the manufacturer and model name of the printer connected to the recorder. Note that this function may not work depending on the printer.

### TV Pause

Selects the tuner for the TV Pause (page 55).

TV's Tuner	Selects this when connecting the recorder to your TV using the SCART jack.
<u>Recorder's Tuner</u>	Selects this when connecting the recorder to your TV not using the SCART jack.

## Additional Information

# Troubleshooting

If you experience any of the following difficulties while using the recorder, use this troubleshooting guide to help remedy the problem before requesting repairs. Should any problem persist, consult your nearest Sony dealer.

## Power

### The power does not turn on.

- ➔ Check that the mains lead is connected securely.

### The power of the recorder turns off at the same time as the TV is turned off.

- ➔ This is caused by the 'BRAVIA' Sync features. Set "Control for HDMI" to "Off" in the "HDMI Output" setup to cancel this function (page 115).

## Picture

### There is no picture.

- ➔ Re-connect all connecting cords securely.
- ➔ The connecting cords are damaged.
- ➔ Check the connection to your TV (page 16).
- ➔ Switch the input selector on your TV (such as "VCR" and "AV 1") so that the signal from the recorder appears on the TV screen.
- ➔ Check that the "Video In/Out" setup is set to the appropriate item that conforms to your system (page 105).
- ➔ If you connect the recorder to your TV via only the COMPONENT VIDEO OUT jacks, set "Component Video Out" in the "Video In/Out" setup to "Progressive" (page 105).
- ➔ When playing a double-layer DVD, the video and audio may be momentarily interrupted at the point where the layers switch.

### Picture noise appears.

- ➔ If the picture output signal from your recorder passes through your VCR to get to your TV, or if you are connected to a combination TV/VIDEO player, the copy-protection signal applied to some DVD programmes could affect picture quality. If you still experience this problem even when you connect your recorder directly to your TV, try connecting your recorder to your TV's S VIDEO input.
- ➔ You have set the recorder to progressive format even though your TV cannot accept the progressive signal. In this case, hold down ■ (stop) on the recorder, and press ▲ (open/close) on the recorder.
- ➔ Even if your TV is compatible with progressive format (525p/625p) signals, the image may be affected when you set the recorder to progressive format. In this case, hold down ■ (stop) on the recorder, and press ▲ (open/close) on the unit and the recorder is set to normal (interlace) format.
- ➔ You are playing a title recorded in a colour system that is different from your TV.
- ➔ Noise may appear in the pictures recorded on the HDD, which is due to the characteristics of HDD, and is not a malfunction.
- ➔ When playing a double-layer DVD, the video and audio may be momentarily interrupted at the point where the layers switch.

### There is no picture or picture noise appears when connected to the DV IN jack.

- ➔ Try the following: ① Turn the recorder off and on again. ② Turn the connected equipment off and on again. ③ Disconnect and then connect the i.LINK cable again.

### There is no picture or picture noise appears when connected to the HDMI OUT jack.

- ➔ Try the following: ① Turn the recorder off and on again. ② Turn the connected equipment off and on again. ③ Disconnect and then connect the HDMI cord again.

- ➔ If the HDMI OUT jack is used for video output, changing the “Screen Resolution” setting in the “HDMI Output” setup may solve the problem (page 113). Connect the TV and the recorder using a video jack other than HDMI OUT, and switch the TV’s input to the connected video input so that you can see the on-screen displays. Change the “Screen Resolution” setting in the “HDMI Output” setup, and switch the TV’s input back to HDMI. If the picture still does not appear, repeat the steps and try other options.
- ➔ The recorder is connected to an input device that is not HDCP compliant (page 17).
- ➔ When picture noise appears after you change the “Screen Resolution” setting, hold down ■ (stop) on the recorder, and press ▲ (open/close) on the recorder.

---

### TV programme reception does not fill the screen.

- ➔ Set the channel manually in “Manual CH Setting” in the “Tuner” setup (page 102).
- ➔ Select the correct source using the INPUT button, or select a channel of any TV programme using the PROG +/- buttons.

---

### TV programme pictures are distorted.

- ➔ Reorient the TV aerial.
- ➔ Adjust the picture (refer to the TV’s instruction manual).
- ➔ Place the recorder and TV farther apart.
- ➔ Place the TV and any bunched aerial cables farther apart.
- ➔ The aerial cable is connected to the AERIAL OUT jack on the recorder. Connect the cable to the AERIAL IN jack.
- ➔ The recorder’s colour system is different from your TV. Hold down ■ (stop) on the recorder, and press INPUT on the recorder to change the recorder’s colour system.

---

### TV channels cannot be changed.

- ➔ The channel is skipped (page 102).
- ➔ A timer recording started, which changed the channels.

---

### The picture from equipment connected to the recorder’s input jack does not appear on the screen.

- ➔ If the equipment is connected to the LINE 1/DECODER jack, select “L1” in the front panel display by pressing INPUT. If the equipment is connected to the LINE 2 IN jacks, select “L2” in the front panel display by pressing INPUT.

---

### The playback picture or TV programme from the equipment connected through the recorder is distorted.

- ➔ If the playback picture output from a DVD player, VCR, or tuner goes through your recorder before reaching your TV, the copy-protection signal applied to some programmes could affect picture quality. Disconnect the playback equipment in question and connect it directly to your TV.

---

### The picture does not fill the screen.

- ➔ Set “TV Type” in the “Playback” setup in accordance with the screen size of your TV (page 111).

---

### The picture does not fill the screen, even though the picture size is set in “TV Type” in the “Playback” setup.

- ➔ The picture size of the title is fixed.

---

### The picture is black and white.

- ➔ Check that “LINE 3 Out” in the “Video In/Out” setup is set to the appropriate item that conforms to your system (page 105).
- ➔ If you are using a SCART cord, be sure to use one that is fully wired (21 pins).

---

## Sound

### There is no sound.

- ➔ Re-connect all connections securely.
- ➔ The connecting cord is damaged.
- ➔ The input source setting on the audio component or the connection to the audio component is incorrect.
- ➔ The recorder is in reverse play, fast-forward, slow motion, or pause mode.

- ➔ If the audio signal does not come through the DIGITAL OUT (COAXIAL)/HDMI OUT jacks, check the “Audio Out” setup (page 107).
- ➔ The recorder supports only MP3 audio, Dolby Digital and MPEG audio for DivX video files. Press AUDIO and select MP3 audio or MPEG audio.

---

### No sound is output from the HDMI OUT jack.

- ➔ Try the following: ①Turn the recorder off and on again. ②Turn the connected equipment off and on again. ③Disconnect and then connect the HDMI cord again.
- ➔ The HDMI OUT jack is connected to a DVI device (DVI jacks do not accept audio signals).
- ➔ The equipment connected to the HDMI OUT jack does not conform to the audio signal format. In this case, set “Audio Output” to “PCM” in the “HDMI Output” setup (page 114).

---

### Sound distortion occurs.

- ➔ Set “Tuner Level” in the “Audio In” setup to “Compression” (page 106).

---

### Sound is noisy.

- ➔ When playing a CD with DTS sound tracks, noise will come from the LINE 2 OUT R-AUDIO-L jacks, LINE 3 – TV jack, or LINE 1/DECODER jack (page 52).

---

### The sound volume is low.

- ➔ The sound volume is low on some DVDs. The sound volume may improve if you set “Audio DRC” in the “Audio Out” setup to “On” (page 108).
- ➔ Set “Tuner Level” in the “Audio In” setup to “Normal” (page 106).

---

### An alternate audio track cannot be recorded or played.

- ➔ When recording from connected equipment, set “External Audio” to “Bilingual” in the “Audio In” setup (page 106).

- ➔ Multilingual tracks (main and sub) cannot be recorded on the HDD (when Video Mode On), DVD+RWs, DVD-RWs (Video mode), DVD+Rs, or DVD-Rs (Video mode). To record the language, set “Bilingual Recording” in the “Audio In” setup to “A/L” or “B/R” before recording (page 107). To record both the main and sub sounds on a disc, record on DVD-RWs/DVD-Rs (VR mode). To record on the HDD, set “HDD Recording Format” to “Video Mode Off” in the “Recording” setup (page 111).
- ➔ If you have connected an audio component to the DIGITAL OUT (COAXIAL) jack and want to change the audio track for the HDD (when “HDD Recording Format” is set to “Video Mode Off” in the “Recording” setup (page 111))/DVD-RWs/DVD-Rs (VR mode) during playback, set “Dolby Digital Output” in the “Audio Out” setup to “Dolby Digital -> PCM” (page 107).

## Recording/Timer recording/ Editing

### The programme position cannot be changed from the programme position you are recording.

- ➔ Set the TV’s input source to “TV.”

---

### Recording does not start immediately after you press ● REC.

- ➔ Operate the recorder only after “LOAD,” “FORMAT,” or “INFO WRITE” disappears from the front panel display.

---

### Nothing was recorded even though you set the timer setting correctly.

- ➔ There was a power failure during recording.
- ➔ The recorder’s internal clock stopped due to a power failure that lasted for more than 1 hour. Reset the clock (page 100).
- ➔ The channel was disabled after the timer recording was set. See “Manual CH Setting” on page 102.
- ➔ Disconnect the mains lead from the mains, and connect it again.
- ➔ The programme contains copy protection signals that restrict copying.



- ➔ Another timer setting overlapped the timer setting (page 46).
- ➔ There is no DVD inside the recorder.
- ➔ There is not enough disc space for the recording.
- ➔ The recorder was in the process of dubbing.

---

### **Recording does not stop immediately after you press ■ REC STOP.**

- ➔ It will take a few seconds for the recorder to input disc data before recording can stop.
- ➔ On-screen instructions may appear after pressing ■ REC STOP. In this case, follow the on-screen instructions.

---

### **Recording does not stop after you press ■.**

- ➔ Press ■ REC STOP.

---

### **Timer recording is not complete or did not start from the beginning.**

- ➔ There was a power failure during recording. If the power recovers when there is a timer recording, the recorder resumes recording.  
Should the power failure continue for more than 1 hour, reset the clock (page 100).
- ➔ Another timer setting overlapped the timer setting (page 46).
- ➔ Disc space was not sufficient.
- ➔ The VPS/PDC function is working.

---

### **Contents previously recorded were erased.**

- ➔ Data that is not playable on this recorder but was recorded on a DVD with a PC will be erased from the disc when the disc is inserted.

---

### **The VPS/PDC function does not operate.**

- ➔ Check that the clock and date are set correctly.
- ➔ Check that the VPS/PDC time you set is correct (there might be a mistake in the TV programme guide). If the broadcast you wanted to record did not send the correct VPS/PDC information, the recorder will not start recording.

- ➔ If the reception is poor, the VPS/PDC signal might be altered and the recorder might not start recording.

## **Playback**

---

### **The recorder does not play any type of disc (except HDD).**

- ➔ The disc is upside down. Insert the disc with the labelled side facing up.
- ➔ The disc is not correctly inserted.
- ➔ Moisture has condensed inside the recorder. In this case, if the recorder is on, leave it on (if it is off, leave it off) for about an hour until the moisture evaporates.
- ➔ If the disc was recorded on another recorder and was not finalised (page 39), the recorder cannot play the disc.

---

### **The recorder does not start playback from the beginning.**

- ➔ Resume play was activated (page 50).
- ➔ You have inserted a DVD whose Title menu or DVD menu automatically appears on the TV screen when it is first inserted. Use the menu to start playback.

---

### **The recorder starts playing automatically.**

- ➔ The DVD VIDEO features an auto playback function.

---

### **Playback stops automatically.**

- ➔ If the DVD has an auto pause signal, the recorder stops playback at the auto pause signal.

---

### **Some functions such as Stop, Search, or Slow-motion Play cannot be performed.**

- ➔ Depending on the DVD, you may not be able to do some of the operations above. Refer to the instruction manual supplied with the disc.

---

### **The language for the sound track cannot be changed.**

- ➔ Multilingual tracks are not recorded on the DVD being played.
- ➔ The DVD VIDEO prohibits the changing of the language for the sound track.

- ➔ Try changing the language using the DVD VIDEO's menu.

---

### The subtitle language cannot be changed or turned off.

- ➔ Multilingual subtitles are not recorded on the DVD VIDEO.
- ➔ The DVD VIDEO prohibits changing of the subtitles.
- ➔ Try changing the subtitle using the DVD VIDEO's menu.
- ➔ The subtitles cannot be changed for the titles recorded on this recorder.

---

### The angles cannot be changed.

- ➔ Multi-angles are not recorded on the DVD VIDEO being played.
- ➔ You are trying to change the angles when "004" does not appear on the TV screen (page 51). To display "004" if various angles (multi-angles) for a scene are recorded on the disc, set "Angle Indicator" to "On" in the "Playback" setup (page 113).
- ➔ The DVD VIDEO prohibits changing angles.
- ➔ Try changing the angle using the DVD VIDEO's menu.
- ➔ The angles cannot be changed for the titles recorded on this recorder.
- ➔ The angles cannot be changed during slow motion playback or when playback is paused.

---

### The DivX video files do not play.

- ➔ The file is not created in DivX format.
- ➔ The file has an extension other than ".avi" or ".divx."
- ➔ The DATA CD (DivX video)/DATA DVD (DivX video) is not created in a DivX format that conforms to ISO9660 Level 1/Level 2, Romeo, Joliet, or UDF (Universal Disk Format) 1.02, 1.50, 2.00, or 2.01.
- ➔ The DivX video file format is larger than 720 (width) × 576 (height).

---

### The MP3 audio tracks do not play.

- ➔ The MP3 audio tracks are not recorded in a format that the recorder can play (page 134).

---

### The JPEG image files do not play.

- ➔ The JPEG image files are not recorded in a format that the recorder can play (page 134).
- ➔ Progressive JPEG images cannot be played.

---

### TV Pause does not work.

- ➔ You are recording to the HDD or the HDD is full.

## Recording from the connected equipment with a timer

### Nothing was recorded even though you set the Synchro-Recording setting correctly.

- ➔ You forgot to turn off the connected equipment. Turn off the connected equipment and set the recorder to Synchro-Recording standby mode (page 47).
- ➔ The recorder was not set to the Synchro-Recording standby mode. Set the recorder to stand by for Synchro-Recording. Make sure the SYNCHRO REC indicator lights up in the front panel display (page 47).
- ➔ The equipment is not connected to the LINE 1/DECODER jack of the recorder.
- ➔ The recorder is connected to the TV output jack of the connected equipment.
- ➔ The Synchro-Recording and another timer recording overlap (page 47).

---

### Synchro-Recording does not complete.

- ➔ The timer setting for the connected equipment overlapped the recorder's timer setting (page 47).
- ➔ There was a power failure during the recording.
- ➔ The  button was pressed before Synchro-Recording started.

---

### The recorder automatically starts recording when the satellite receiver is turned on.

- ➔ The Synchro Rec function was activated. Turn off the satellite receiver and cancel the Synchro Rec function (page 47).

## Dubbing

### You dubbed a title, but the title did not appear in the HDD Title List.

- ➔ The title contained a copy protection signal, so it was moved (page 131).

### High-speed dubbing is not possible.

- ➔ The title cannot be dubbed at high speed (page 67). Even if A-B erasure is performed so that a title does not contain mixed picture sizes, it is still treated as a title with mixed picture sizes.

### HDD/DVD Dubbing is not possible.

- ➔ The title cannot be dubbed (page 66).

### HDD camcorder dubbing is not possible.

- ➔ An HDD camcorder which is not supported by this recorder is connected (page 70).
- ➔ The HDD camcorder is not set to the USB connection mode (page 71).
- ➔ The HDD camcorder contains only the contents that have already been dubbed to the recorder when you are dubbing using the ONE-TOUCH DUB button or “Incremental Dubbing.”

## Display

### The clock has stopped.

- ➔ Set the clock again (page 100).

### The clock is wrong.

- ➔ Set the clock again (page 100). If you cannot set the clock, wait until the clock data is received and the clock is automatically adjusted.

### The timer indicator is flashing.

- ➔ The disc does not have enough space.
- ➔ Insert a recordable disc into the recorder.
- ➔ The inserted DVD is protected (page 38).

### The clock does not appear in the front panel display when the recorder is turned off.

- ➔ “Front Panel Display” is set to “Off” in the “Options” setup (page 115).

## Remote control

### The remote does not function.

- ➔ Different command modes are set for the recorder and remote. Set the same command mode (page 115). The default command mode setting for this recorder and the supplied remote is “**3 (Default setting)**.” You can check the current command mode in the front panel display (page 115).
- ➔ The batteries are weak.
- ➔ The remote is too far from the recorder.
- ➔ The remote’s manufacturer code returned to the default setting when you replaced the batteries. Reset the code (page 22).
- ➔ The remote is not pointed at the remote sensor on the recorder.

## Others

### The recorder does not detect a USB device connected to the recorder.

- ➔ Make sure that the USB device is securely connected to the recorder (page 117).
- ➔ Check if the USB device or a cable is damaged.
- ➔ Check if the USB device is on.
- ➔ The USB device is connected via a USB hub. Connect the USB device directly to the recorder.

### Display language on the screen switches automatically.

- ➔ When “Control for HDMI” is set to “On” (default) in the “HDMI Output” setup (page 115), the display language on the screen automatically switches, according to the language setting of the connected TV, if you change the language settings on your TV, etc.

### The ‘BRAVIA’ Sync features do not operate.

- ➔ Your TV is not compatible with the ‘BRAVIA’ Sync features.
- ➔ “Control for HDMI” is set to “Off” in the “HDMI Output” setup (page 115).
- ➔ The recorder is connected to the TV via an amplifier. Connect the recorder directly to the TV.

---

**The recorder does not operate properly.**

- ➔ Press down **I/⏻** on the recorder for more than five seconds until the recorder turns off. Then, press **I/⏻** again to turn on the recorder.
- ➔ When static electricity, etc., causes the recorder to operate abnormally, turn off the recorder and wait until the clock appears in the front panel display. Then, unplug the recorder and after leaving it off for a while, plug it in again.

---

**The disc tray does not open after you press **⏏** (open/close).**

- ➔ It may take a few seconds for the disc tray to open after you have recorded or edited a DVD. This is because the recorder is adding disc data to the disc.

---

**Any buttons do not function and “LOCKED” appears in the front panel display.**

- ➔ The recorder is locked. Cancel the Child Lock (page 12).

---

**The disc tray does not open and “TRAYLOCKED” appears in the front panel display.**

- ➔ Contact your Sony dealer or local authorized Sony service facility.

---

**“REPAIR” appears in the front panel display.**

- ➔ The recorder's repair function is activated to repair the hard disk drive or disc. Leave the recorder on until “REPAIR” disappears from the front panel display. Some data may be lost even if the repair function is activated.

---

**“E01” appears in the front panel display.**

- ➔ There is a problem in the HDD. Contact your nearest Sony dealer. Note that contents on the HDD may be erased when servicing this unit.

---

**“E02” appears in the front panel display.**

- ➔ The HDD information is incorrect. You cannot make a new recording to the HDD. Format the HDD following the instructions of “Format HDD.” (page 100). Note that all of the recorded contents on the HDD will be erased. If this does not fix the problem, contact your nearest Sony dealer.

---

**Mechanical sounds are heard when the recorder is off.**

- ➔ While the recorder is adjusting the clock for the Auto Clock Set function, operational noises may be heard, even when the power is off. This is not a malfunction.

















---

## Resetting the Recorder

You can reset the recorder to all its factory settings.

- 1 Make sure that the recorder is turned on and remove the disc.**
- 2 Hold down **■** (stop) on the recorder and press **I/⏻** on the recorder.** All settings are reset and the recorder turns off.

# Recordable and Playable Discs

Type		Disc Logo	Icon used in this manual	Formatting (new discs)	Compatibility with other DVD players (finalising)
Hard disk drive (internal)	VR mode			Select "Video Mode Off" in "HDD Recording Format" (page 111)	Dub HDD contents to a DVD (VR mode) to play on other DVD players
	Video mode			Select "Video Mode On" (default) in "HDD Recording Format" (page 111)	Dub HDD contents to a DVD (Video mode) to play on other DVD players
DVD+RW		 DVD+ReWritable  DVD+ReWritable High Speed		Automatically formatted in +VR mode (DVD+RW VIDEO)	Playable on DVD+RW compatible players (automatically finalised)
DVD-RW	VR mode			Format in VR mode (page 31)	Playable only on VR mode compatible players (finalisation unnecessary)
	Video mode	 		Format in Video mode (page 31)	Playable on most DVD players (finalisation necessary) (page 39)
DVD+R	DVD+R DL			Automatically formatted in +VR mode (DVD+R VIDEO)	Playable on most DVD players (finalisation necessary) (page 39)
					
DVD-R	VR mode			Format in VR mode (page 31) <sup>*1</sup> Formatting is performed in the "Format" setup (page 42).	Playable only on DVD-R in VR mode compatible players (finalisation necessary) (page 39)
DVD-R DL	Video mode	 R DL 4X/2X		Automatically formatted in Video mode	Playable on most DVD players (finalisation necessary) (page 39)

## Usable disc versions (as of April 2008)

- 8x-speed or slower DVD+RWs
- 6x-speed or slower DVD-RWs (Ver.1.1, Ver.1.2 with CPRM<sup>\*2</sup>)
- 16x-speed or slower DVD+Rs
- 8x-speed or slower DVD-Rs (Ver.2.0, Ver.2.1 with CPRM<sup>\*2</sup>)
- 8x-speed or slower DVD+R DL (Double Layer) discs
- 8x-speed or slower DVD-R DL (Dual Layer) discs (Ver.3.0 with CPRM<sup>\*2</sup>)

“DVD+RW,” “DVD-RW,” “DVD+R,” “DVD+R DL,” “DVD-R,” and “DVD-R DL” are trademarks.

<sup>\*1</sup> When an unformatted DVD-R is inserted into this recorder, it is automatically formatted in Video mode. To format a new DVD-R in VR mode, format in the “Format” setup (page 42).

<sup>\*2</sup> CPRM (Content Protection for Recordable Media) is a coding technology that protects copyrights for images.

## Discs that cannot be recorded on

- DVD-RAMs

## Maximum recordable number of titles









Disc	Number of titles
HDD*	999
DVD-RW/DVD-R	99
DVD+RW/DVD+R	49
DVD+R DL	49
DVD-R DL	99

\* The maximum length for one title is 12 hours.

## Notes

- You cannot mix VR mode and Video mode on the same DVD-RW. To change the disc’s format, reformat the disc (page 42). Note that the disc’s contents will be erased after reformatting.
- You cannot shorten the time required for recording even with high-speed discs.
- It is recommended that you use discs with “For Video” printed on their packaging.
- You cannot add new recordings to DVD+Rs, DVD-Rs, or DVD-RWs (Video mode) that contain recordings made on other DVD equipment.
- In some cases, you may not be able to add new recordings to DVD+RWs that contain recordings made on other DVD equipment. If you do add a new recording, note that this recorder will rewrite the DVD menu.
- You cannot edit recordings on DVD+RWs, DVD-RWs (Video mode), DVD+Rs, or DVD-Rs that are made on other DVD equipment.
- If the disc contains PC data unrecognisable by this recorder, the data may be erased.
- You may not be able to record, edit, or dub on some recordable discs, depending on the disc.
- Do not insert any discs that cannot be recorded or played on this recorder. This may cause the recorder to malfunction.

# Playable Discs

Type	Disc Logo	Icon used in this manual	Characteristics
DVD VIDEO			Discs such as movies that can be purchased or rented This recorder also recognises DVD-RAMs* as DVD Video compatible discs.
VIDEO CD			VIDEO CDs or CD-Rs/CD-RWs in VIDEO CD/Super VIDEO CD format
CD			Music CDs or CD-Rs/CD-RWs in music CD format
DATA DVD	—		DVD+RWs/DVD+Rs/DVD-RAMs* containing MP3 audio tracks or DivX video files DVD-RWs/DVD-Rs/DVD-ROMs containing MP3 audio tracks, JPEG image files or DivX video files
DATA CD	—		CD-ROMs/CD-Rs/CD-RWs containing either MP3 audio tracks, JPEG image files or DivX video files

“DVD VIDEO” and “CD” are trademarks.

DivX, DivX Certified, and associated logos are trademarks of DivX, Inc. and are used under license.

DivX<sup>®</sup> is a video file compression technology, developed by DivX, Inc.

\* If the DVD-RAM has a removable cartridge, remove the cartridge before playback.

## Discs that cannot be played

- PHOTO CDs
- CD-ROMs/CD-Rs/CD-RWs that are recorded in a format different from the formats mentioned in the table above.
- Data part of CD-Extras
- BDs (Blu-ray Discs)
- HD DVDs
- Discs recorded with an AVCHD-compatible DVD video camera

- DVD-ROMs/DVD+RWs/DVD-RWs/DVD+Rs/DVD-Rs that do not contain DVD Video, DivX video, JPEG image files, or MP3 audio tracks.
- DVD Audio discs
- Cartridge-only type DVD-RAMs.
- HD layer on Super Audio CDs
- DVD VIDEOS with a different region code (page 128).
- DVDs that were recorded on a different recorder and not correctly finalised.

## Note on playback operations of DVD VIDEOS/VIDEO CDs

Some playback operations of DVD VIDEOS/VIDEO CDs may be intentionally set by software producers. Since this recorder plays DVD VIDEOS/VIDEO CDs according to the disc contents the software producers designed, some playback features may not be available. Refer to the instructions supplied with the DVD VIDEOS/VIDEO CDs.

## Region code (DVD VIDEO only)

Your recorder has a region code printed on the rear of the unit and will only play DVD VIDEOS (playback only) labelled with identical region codes. This system is used to protect copyrights.

DVD VIDEOS labelled  will also play on this recorder.

If you try to play any other DVD VIDEO, the message "Playback prohibited by region code." will appear on the TV screen.

Depending on the DVD VIDEO, no region code indication may be labelled even though playing the DVD VIDEO is prohibited by area restrictions.

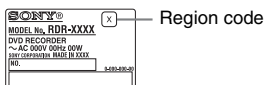

## Music discs encoded with copyright protection technologies

This product is designed to play back discs that conform to the Compact Disc (CD) standard.

Various music discs encoded with copyright protection technologies are being marketed by some record companies. Please be aware that among those discs, there are some that do not conform to the CD standard and may not be playable by this product.

## Note on DualDiscs

A DualDisc is a two sided disc product which mates DVD recorded material on one side with digital audio material on the other side.

However, since the audio material side does not conform to the Compact Disc (CD) standard, playback on this product is not guaranteed.

## Notes

- Some DVD+RWs/DVD+Rs, DVD-RWs/DVD-Rs, DVD-RAMs, or CD-RWs/CD-Rs cannot be played on this recorder due to the recording quality or physical condition of the disc, or the characteristics of the recording device and authoring software. The disc will not play if it has not been correctly finalised. For more information, refer to the operating instructions for the recording device.
- If the disc contains PC data unrecognisable by this recorder, the data may be erased.
- Do not insert any discs that cannot be recorded or played on this recorder. This may cause the recorder to malfunction.

## About Recording/ Dubbing Mode



Like the standard ×3 recording modes of video tapes, you can select the desired recording mode using the REC MODE button.

Recording modes with higher quality provide a more beautiful recording, but the large data volume also results in a shorter recording time.

Conversely, a longer duration provides a longer recording time, but the lower data volume results in a coarser picture quality.

To select further options for recording mode (manual recording mode), set "Manual Rec. Mode" to "On (go to setup)" in the "Recording" setup (page 110). To record pictures in higher quality than HQ mode on the HDD, set "Manual Rec. Mode" to "On (go to setup)," and then select "HQ+." The table on the following pages shows the approximate recording times for the HDD and the different DVD types in each manual recording mode, as well as the standard recording mode equivalents.

## Hint

To easily select a manual recording mode, press REC MODE repeatedly to display "MN," and select a manual recording mode using / .



## Recording time in each recording mode

Bold lines indicate noticeable level differences in recording picture quality.

Recording mode	Approx. recording time (hours)					
	HDD			DVD+RW/ DVD-RW/ DVD+R/ DVD-R	DVD+R DL/ DVD-R DL	
	RDR- HX680	RDR- HX780	RDR- HX980			
HQ+ <sup>*1</sup>	17	23	36	–	–	
PCM <sup>*2</sup>	25	34	53	1 hr. 1 min.	1 hr. 51 min.	
<b>HQ</b>	MN32	25	34	53	1 hr. 1 min.	1 hr. 51 min.
	MN31	27	36	57	1 hr. 5 min.	1 hr. 57 min.
	MN30	29	39	61	1 hr. 10 min.	2 hr. 6 min.
	MN29	31	42	66	1 hr. 15 min.	2 hr. 15 min.
	MN28	33	45	70	1 hr. 20 min.	2 hr. 24 min.
	MN27	36	48	75	1 hr. 25 min.	2 hr. 33 min.
<b>HSP</b>	MN26	37	50	79	1 hr. 30 min.	2 hr. 41 min.
	MN25	39	53	84	1 hr. 35 min.	2 hr. 50 min.
	MN24	42	56	88	1 hr. 40 min.	2 hr. 59 min.
	MN23	44	59	92	1 hr. 45 min.	3 hr. 8 min.
	MN22	46	62	97	1 hr. 50 min.	3 hr. 17 min.
<b>SP</b>	MN21	51	68	105	2	3 hr. 35 min.
	MN20	54	73	115	2 hr. 10 min.	3 hr. 53 min.
	MN19	59	79	120	2 hr. 20 min.	4 hr. 11 min.
<b>LSP</b>	MN18	63	84	130	2 hr. 30 min.	4 hr. 29 min.
	MN17	67	90	140	2 hr. 40 min.	4 hr. 47 min.
	MN16	72	96	150	2 hr. 50 min.	5 hr. 5 min.
<b>ESP</b>	MN15	75	100	155	3	5 hr. 23 min.
	MN14	78	105	165	3 hr. 10 min.	5 hr. 41 min.
	MN13	82	110	175	3 hr. 20 min.	5 hr. 59 min.
	MN12	86	115	185	3 hr. 30 min.	6 hr. 17 min.
	MN11	90	120	190	3 hr. 40 min.	6 hr. 35 min.
	MN10	93	125	200	3 hr. 50 min.	6 hr. 53 min.
<b>LP</b>	MN9	100	135	210	4	7 hr. 11 min.
	MN8	110	150	235	4 hr. 30 min.	8 hr. 4 min.
	MN7	120	165	265	5	8 hr. 58 min.
<b>EP</b>	MN6 <sup>*3</sup>	150	200	315	6	10 hr. 46 min.
	MN5 <sup>*3</sup>	175	235	370	7	12 hr. 34 min.

Recording mode		Approx. recording time (hours)				
		HDD			DVD+RW/ DVD-RW/ DVD+R/ DVD-R	DVD+R DL/ DVD-R DL
		RDR- HX680	RDR- HX780	RDR- HX980		
<b>SLP</b>	MN4 <sup>*3</sup>	200	270	425	8	14 hr. 21 min.
<b>SEP</b>	MN3 <sup>*3*4</sup>	255	340	530	10	17 hr. 57 min.
	MN2 <sup>*3*4</sup>	300	405	635	12	21 hr. 32 min.
	MN1 <sup>*3*4</sup>	340	455	710	13 hr. 22 min.	24

\*1 Records in higher quality (15 Mbps).

When recording to the HDD in HQ+ mode, recordings are made in “Video Mode Off” format regardless of the “HDD Recording Format” setting (page 111).

HQ+ mode is not available for DVDs. When recording to DVDs, the recording mode automatically switches to HQ mode even if you set to HQ+ mode.

\*2 Audio signals are recorded in 48 kHz PCM format, and video signals are recorded in HQ mode. When recording a bilingual programme, select the sound to be recorded (page 107).

\*3 Titles recorded in MN6 or lower mode cannot be dubbed to DVD+RWs/DVD+Rs at high speed.

\*4 SEP, MN1, MN2, or MN3 mode is not available for DVD+RWs/DVD+Rs/DVD+R DLs. When recording to DVD+RWs/DVD+Rs, the recording mode automatically switches to SLP mode even if you set to SEP, MN1, MN2, or MN3 mode.

## Resolution

The first figure refers to when “Input Line System” is set to “NTSC”; the second when set to “PAL/SECAM” in the “Basic” setup (page 101).

### ◆ For the HDD (“HDD Recording Format” is set to “Video Mode Off”)/DVD-RW (VR mode)/DVD-R (VR mode)

HQ+, PCM, MN32 to MN16: 720 × 480 / 720 × 576

MN15 to MN12: 544 × 480 / 544 × 576

MN11 to MN9: 480 × 480 / 544 × 576

MN8 and MN7: 352 × 480 / 352 × 576

MN6 to MN1: 352 × 240 / 352 × 288

### ◆ For the HDD (“HDD Recording Format” is set to “Video Mode On”)/DVD+RW/DVD-RW (Video mode)/DVD+R/DVD-R (Video mode)

PCM, MN32 to MN9: 720 × 480 / 720 × 576

MN8 and MN7: 352 × 480 / 352 × 576

MN6 to MN1: 352 × 240 / 352 × 288

## 🔔 Hint

Audio signals are recorded in Dolby Digital 2 ch format (except for PCM mode).

## 📌 Notes

- The maximum continuous recording time to the HDD is 12 hours for a single title. A title longer than 12 hours is divided.
- Situations below may cause slight inaccuracies with the recording time.
  - Recording a programme with poor reception, or a programme or video source of low picture quality.
  - Recording on a disc that has already been edited.
  - Recording only a still picture or just sound.

## About “High-Speed” dubbing

Required times (approximate) for “High-Speed” dubbing from HDD to DVD (for 60-minute programme)<sup>\*1</sup>

Speed <sup>*2</sup>	6x	2.4x	2x
Rec. mode	High-speed DVD+RW/ DVD-RW/ DVD+R/ DVD-R	DVD+R (Double Layer)	DVD-R (Dual Layer)
HQ	Approx. 10 min.	Approx. 25 min.	Approx. 30 min.
HSP	Approx. 6 min. 40 sec.	Approx. 16 min. 40 sec.	Approx. 20 min.
SP	Approx. 5 min.	Approx. 12 min. 30 sec.	Approx. 15 min.
LSP	Approx. 4 min.	Approx. 10 min.	Approx. 12 min.
ESP	Approx. 3 min. 20 sec.	Approx. 8 min. 20 sec.	Approx. 10 min.
LP	Approx. 2 min. 30 sec.	Approx. 6 min. 15 sec.	Approx. 7 min. 30 sec.
EP	Approx. 1 min. 40 sec. <sup>*3</sup>	Approx. 60 min. <sup>*3</sup>	Approx. 5 min.
SLP	Approx. 1 min. 15 sec. <sup>*3</sup>	Approx. 60 min. <sup>*3</sup>	Approx. 3 min. 45 sec.
SEP	Approx. 1 min. <sup>*3</sup>	Approx. 60 min. <sup>*3</sup>	Approx. 3 min. <sup>*3</sup>

<sup>\*1</sup> The values in the above table are for reference only. Actual times for dubbing also require time for creating disc’s control information and other data.

<sup>\*2</sup> This is the maximum recording speed of this recorder. The recording speed cannot exceed the value indicated in the above table even when using discs that support higher recording speeds. In addition, depending on the disc condition, the recorder may be unable to record at the maximum recording speed indicated in the table.

<sup>\*3</sup> “High-Speed” dubbing is not available when dubbing titles recorded in SEP, SLP, or EP mode to DVD+RWs and DVD+Rs.



## About Copy Protection

Pictures with copy protection cannot be recorded on this recorder.

### Dubbing restriction

You cannot dub movies and other DVD VIDEOS to the HDD. Also, when dubbing from a DVD to the HDD, scenes that contain a copy protection signal cannot be recorded. Titles containing “Copy-Once” copy protection signals can be moved only from the HDD to a DVD-RW/DVD-R (VR mode)\* (after the title is moved, the original title in the HDD is erased). The “Move” function is performed using Dubbing List. Titles containing “Copy-Once” copy protection signals are indicated with .

### Discs that can be used for protected signals

Copy protection signals	Usable discs
Copy-Free (No copy protection signal)	
Copy-Once	
Copy-Never	None

\* CPRM-compatible DVD-RWs/DVD-Rs (VR mode) only.

The recorded disc can be played only on CPRM compatible equipment (page 126).

CPRM (Content Protection for Recordable Media) is a coding technology that protects copyrights for images.

### Notes

- Protected titles in the HDD cannot be moved.
- The “Move” function is not available for HDD/DVD DUB dubbing.
- Even if you erase a scene that contains a copy protection signal, the recording restrictions on that title are retained.

---

# Language Code List

For details, see page 109.

The language spellings conform to the ISO 639: 1988 (E/F) standard.

---

## Number, Language (Code)

---

0101, Afar (aa)	0701, Irish (ga)	1307, Malagasy (mg)	1912, Slovenian (sl)
0102, Abkhazian (ab)	0704, Scots Gaelic (gd)	1309, Maori (mi)	1913, Samoan (sm)
0106, Afrikaans (af)	0712, Galician (gl)	1311, Macedonian (mk)	1914, Shona (sn)
0113, Amharic (am)	0714, Guarani (gn)	1312, Malayalam (ml)	1915, Somali (so)
0118, Arabic (ar)	0721, Gujarati (gu)	1314, Mongolian (mn)	1917, Albanian (sq)
0119, Assamese (as)	0801, Hausa (ha)	1315, Moldavian (mo)	1918, Serbian (sr)
0125, Aymara (ay)	0809, Hindi (hi)	1318, Marathi (mr)	1919, Siswati (ss)
0126, Azerbaijani (az)	0818, Croatian (hr)	1319, Malay (ms)	1920, Sesotho (st)
0201, Bashkir (ba)	0821, Hungarian (hu)	1320, Maltese (mt)	1921, Sundanese (su)
0205, Byelorussian (be)	0825, Armenian (hy)	1325, Burmese (my)	1922, Swedish (sv)
0207, Bulgarian (bg)	0901, Interlingua (ia)	1401, Nauru (na)	1923, Swahili (sw)
0208, Bihari (bh)	0905, Interlingue (ie)	1405, Nepali (ne)	2001, Tamil (ta)
0209, Bislama (bi)	0911, Inupiak (ik)	1412, Dutch (nl)	2005, Telugu (te)
0214, Bengali (bn)	0914, Indonesian (in)	1415, Norwegian (no)	2007, Tajik (tg)
0215, Tibetan (bo)	0919, Icelandic (is)	1503, Occitan (oc)	2008, Thai (th)
0218, Breton (br)	0920, Italian (it)	1513 (Afan)Oromo (om)	2009, Tigrinya (ti)
0301, Catalan (ca)	0923, Hebrew (iw)	1518, Oriya (or)	2011, Turkmen (tk)
0315, Corsican (co)	1001, Japanese (ja)	1601, Panjabi (pa)	2012, Tagalog (tl)
0319, Czech (cs)	1009, Yiddish (ji)	1612, Polish (pl)	2014, Setswana (tn)
0325, Welsh (cy)	1023, Javanese (jw)	1619, Pashto (ps); Push-to (ps)	2015, Tonga (to)
0401, Danish (da)	1101, Georgian (ka)	1620, Portuguese (pt)	2018, Turkish (tr)
0405, German (de)	1111, Kazakh (kk)	1721, Quechua (qu)	2019, Tsonga (ts)
0426, Bhutani (dz)	1112, Greenlandic (kl)	1813, Rhaeto-Romance (rm)	2020, Tatar (tt)
0512, Greek (el)	1113, Cambodian (km)	1814, Kirundi (rn)	2023, Twi (tw)
0514, English (en)	1114, Kannada (kn)	1815, Romanian (ro)	2111, Ukrainian (uk)
0515, Esperanto (eo)	1115, Korean (ko)	1821, Russian (ru)	2118, Urdu (ur)
0519, Spanish (es)	1119, Kashmiri (ks)	1823, Kinyarwanda (rw)	2126, Uzbek (uz)
0520, Estonian (et)	1121, Kurdish (ku)	1901, Sanskrit (sa)	2209, Vietnamese (vi)
0521, Basque (eu)	1125, Kirghiz (ky)	1904, Sindhi (sd)	2215, Volapük (vo)
0601, Persian (fa)	1201, Latin (la)	1907, Sangho (sg)	2315, Wolof (wo)
0609, Finnish (fi)	1214, Lingala (ln)	1908, Serbo-Croatian (sh)	2408, Xhosa (xh)
0610, Fiji (fj)	1215, Laothian (lo)	1909, Sinhalese (si)	2515, Yoruba (yo)
0615, Faroese (fo)	1220, Lithuanian (lt)	1911, Slovak (sk)	2608, Chinese (zh)
0618, French (fr)	1222, Latvian (lv); Lettish		2621, Zulu (zu)

---

# Country/Area Code

For details, see page 112.

## Number, Area (Code)

---

0118, Argentina (ar)	0609, Finland (fi)	1325, Malaysia (my)	1907, Singapore (sg)
0121, Australia (au)	0618, France (fr)	1324, Mexico (mx)	0519, Spain (es)
0120, Austria (at)	0405, Germany (de)	1412, Netherlands (nl)	1905, Sweden (se)
0205, Belgium (be)	0811, Hong Kong (hk)	1426, New Zealand (nz)	0308, Switzerland (ch)
0218, Brazil (br)	0914, India (in)	1415, Norway (no)	2023, Taiwan (tw)
0301, Canada (ca)	0904, Indonesia (id)	1611, Pakistan (pk)	2008, Thailand (th)
0312, Chile (cl)	0920, Italy (it)	1608, Philippines (ph)	0702, United Kingdom (gb)
0314, China (cn)	1016, Japan (jp)	1620, Portugal (pt)	2119, USA (us)
0411, Denmark (dk)	1118, Korea (kr)	1821, Russia (ru)	

---

## Notes About This Recorder

### On operation

- If the recorder is brought directly from a cold to a warm location, or is placed in a very damp room, moisture may condense on the lenses inside the recorder. Should this occur, the recorder may not operate properly. In this case, if the recorder is on, leave it on (if it is off, leave it off) for about an hour until the moisture evaporates.
- When you move the recorder, take out any discs and do not apply shock or vibration to the hard disk drive to avoid damaging the disc or hard disk drive (page 3).

### On adjusting volume

Do not turn up the volume while listening to a section with very low level inputs or no audio signals. If you do, the speakers may be damaged when a peak level section is played.

### On cleaning

Clean the cabinet, panel, and controls with a soft cloth slightly moistened with a mild detergent solution. Do not use any type of abrasive pad, scouring powder or solvent such as alcohol or benzene.

### On cleaning discs, disc/lens cleaners

**Do not use cleaning discs or disc/lens cleaners (including wet or spray types). These may cause the recorder to malfunction.**

### Notes about the discs

- To keep the disc clean, handle the disc by its edge. Do not touch the surface. Dust, fingerprints, or scratches on the disc may cause it to malfunction.



- Do not expose the disc to direct sunlight or heat sources such as hot air ducts, or leave it in a car parked in direct sunlight as the temperature may rise considerably inside the car.
- After playing, store the disc in its case.
- Clean the disc with a cleaning cloth. Wipe the disc from the centre out.



- Do not use solvents such as benzene, thinner, commercially available cleaners, or anti-static spray intended for vinyl LPs.
- Do not use the following discs.
  - A disc that has a non-standard shape (e.g., card, heart).
  - A disc with a label or sticker on it.
  - A disc that has cellophane tape or sticker adhesive on it.

### On replacement of parts

In the event that this unit is repaired, repaired parts may be collected for reuse or recycling purposes.

# Notes on MP3 Audio Tracks, JPEG Image Files, DivX Video Files, and i.Link

## About MP3 audio tracks, JPEG image files, and DivX video files

MP3 is an audio compression technology that satisfies certain ISO/MPEG regulations. JPEG is an image compression technology. You can play MP3 (MPEG1 Audio Layer 3) format audio tracks on the HDD, DATA CDs (CD-ROMs/CD-Rs/CD-RWs) or DATA DVDs (DVD-ROMs/DVD-RWs/DVD-Rs/DVD+RWs/DVD+Rs/DVD-RAMs) or play JPEG image files on the HDD, DATA CDs (CD-ROMs/CD-Rs/CD-RWs) or DATA DVDs (DVD-ROMs/DVD-RWs/DVD-Rs).

DivX<sup>®</sup> is a video file compression technology, developed by DivX, Inc. This product is an official DivX<sup>®</sup> Certified product. You can play DATA CDs (CD-ROMs/CD-Rs/CD-RWs) and DATA DVDs (DVD-ROMs/DVD+RWs/DVD+Rs/DVD-RWs/DVD-Rs/DVD-RAMs) that contain DivX video files.

DATA DVDs must be recorded according to ISO9660 Level 1, Level 2, Romeo, Joliet, or UDF (Universal Disk Format) 1.02, 1.50, 2.00\*, or 2.01 format for the recorder to recognise the MP3 tracks, JPEG image files, and DivX video files.

DATA CDs must be recorded according to ISO9660 Level 1, Level 2, Romeo, or Joliet format for the recorder to recognise the MP3 tracks, JPEG image files, and DivX video files.

You can also play discs recorded in MultiSession/Border.

Refer to the instructions supplied with the disc drives and the recording software (not supplied) for details on the recording format.

\* Not available for MP3 audio tracks.

## Note on MultiSession/Border discs

If audio tracks and images in Music CD format or Video CD format are recorded in the first session/border, only the first session/border will be played back.

## MP3 audio tracks, JPEG image files, or DivX video files that the recorder can play

The recorder can play the following tracks and files:

- MP3 audio tracks with the extension “.mp3.”
- JPEG image files with the extension “.jpeg” or “.jpg.”
- Baseline JPEG image files that conform to the Exif 2.2\* image files format, and Y:C:B:Cr is 4:4:4, 4:2:2, or 4:2:0.
- DivX video files with the extension “.avi” or “.divx.”

\* “Exchangeable Image File Format”: The file format used by digital still cameras.

### Hint

Since a disc with many trees takes longer to start playback, it is recommended that you create albums with no more than two trees.

### Notes

- The recorder will play any data with the extension “.mp3,” “.jpeg,” “.jpg,” “.avi,” or “.divx” even if they are not in MP3, JPEG, or DivX format. Playing these data may generate a loud noise which could damage your speaker system.
- Depending on the disc, normal playback may not be possible. For example, the picture may be unclear, playback may not appear smooth, the sound may skip, and so on.
- Depending on the disc, playback may take some time to start.
- Some files cannot be played.
- For MP3 audio tracks and DivX video files, the recorder can play up to 99 albums each on a DATA CD or DATA DVD. Up to 99 tracks and files under an album can be played.
- For JPEG image files, the recorder can load up to 99 albums and/or up to 999 files under an album on a DATA CD/DATA DVD or the connected USB device at a time. To view unloaded albums, reload them.

- Proceeding to the next or another album may take some time.
- The image size that can be displayed is limited. The following image sizes can be displayed: width 160–5,120 pixels by height 120–3,840 pixels.
- This recorder supports MP3 audio tracks recorded with a sampling frequency of 32 kHz, 44.1 kHz, and 48 kHz.
- No more than a 1 GB MP3 audio track can be played.
- The recorder does not conform to audio tracks in mp3PRO format.
- The recorder cannot play a DivX video file of a size larger than 720 (width) × 576 (height)/4 GB.
- The recorder may not play a DivX video file when the file has been combined from two or more DivX video files.

### Notes on copying JPEG image files/MP3 audio tracks

- You cannot copy JPEG image files/MP3 audio tracks to the HDD if:
  - The total number of JPEG image albums on the HDD exceeds 999.
  - The total number of JPEG image files/MP3 audio tracks under an album exceeds 999.
  - The MP3 audio tracks are 1 GB or larger.
- Note that the size of JPEG image files copied to the HDD may be automatically increased to fit the TV screen.
- You cannot copy JPEG image files onto a DATA DVD finalised on other recorders or devices.
- If a warning message indicating that the HDD is full appears, erase several albums or files to make space. For details on erasing tracks or files, see page 83 or 93.

## About i.LINK

The DV IN jack on this recorder is i.LINK-compliant for digital video cameras.

i.LINK is a more familiar term for IEEE 1394 data transport bus proposed by SONY, and is a trademark approved by many corporations.

IEEE 1394 is an international standard standardized by the Institute of Electrical and Electronics Engineers.

For details on how to dub when this recorder is connected to other video equipment having DV jacks, see page 74.

The DV jack on this recorder can only input DVC-SD signals. It cannot output signals. The DV jack will not accept MICRO MV signals from equipment such as a MICRO MV digital video camera with an i.LINK jack.

For further precautions, see the notes on page 74.

For details on precautions when connecting this recorder, also refer to the instruction manuals for the equipment to be connected.

### Note

Normally, only one piece of equipment can be connected to this recorder by the i.LINK cable (DV connecting cable). When connecting this recorder to i.LINK-compatible equipment having two or more i.LINK jacks (DV jacks), refer to the instruction manual of the equipment to be connected.

i.LINK and  are trademarks.

---

# Specifications

## System

**Laser:** Semiconductor laser

### Channel coverage:

PAL (B/G, D/K, I)/SECAM (L)

VHF: E2 to E12, R1 to R12, F2 to F10, Italian A to H, Ireland A to J, South Africa 4 to 11, 13

UHF: E21 to E69, R21 to R69, B21 to B69, F21 to F69

CATV: S01 to S05, S1 to S20, France B to Q

HYPER: S21 to S41

The above channel coverage merely ensures the channel reception within these ranges. It does not guarantee the ability to receive signals in all circumstances. The channels that can be received differ depending on the country/region.

**Video reception:** Frequency synthesizer system

**Audio reception:** Split carrier system

**Aerial out:** 75-ohm asymmetrical aerial socket

**Timer:** Clock: Quartz locked/Timer indication: 24-hour cycle (digital)

**Video recording format:** MPEG-2, MPEG-1

### Audio recording format/applicable

**bit rate:** Dolby Digital 2 ch

256 kbps/128 kbps (in EP, SLP, and SEP mode), PCM

## Inputs and outputs

### LINE 2 OUT

**(AUDIO):** Phono jack/2 V<sub>rms</sub>/10 kilohms

**(VIDEO):** Phono jack/1.0 V<sub>p-p</sub>

**(S VIDEO):** 4-pin mini DIN/Y: 1.0 V<sub>p-p</sub>, C: 0.3 V<sub>p-p</sub> (PAL)

### LINE 2 IN

**(AUDIO):** Phono jack/2 V<sub>rms</sub>/more than 22 kilohms

**(VIDEO):** Phono jack/1.0 V<sub>p-p</sub>

**(S VIDEO):** 4-pin mini DIN/Y: 1.0 V<sub>p-p</sub>, C: 0.3 V<sub>p-p</sub> (PAL)

### LINE 3 – TV: 21-pin

CVBS OUT

S-Video/RGB OUT (upstream)

### LINE 1/DECODER: 21-pin

CVBS IN/OUT

S-Video/RGB IN

Decoder

### DV IN: 4-pin/i.LINK S100

**DIGITAL OUT (COAXIAL):** Phono jack/0.5 V<sub>p-p</sub>/75 ohms

### COMPONENT VIDEO OUT

**(Y, P<sub>B</sub>/C<sub>B</sub>, P<sub>R</sub>/C<sub>R</sub>):**

Phono jack/Y: 1.0 V<sub>p-p</sub>,

P<sub>B</sub>/C<sub>B</sub>: 0.7 V<sub>p-p</sub>, P<sub>R</sub>/C<sub>R</sub>: 0.7 V<sub>p-p</sub>

### HDMI OUT: HDMI™ Connector

### USB:

USB jack Type A (For connecting digital still camera, Memory card reader, USB memory and HDD camcorder)

USB jack Type B (For connecting PictBridge-compatible printers)

## General

**Power requirements:** 220-240 V AC, 50/60 Hz

**Power consumption:** 43 W

### Dimensions (approx.):

430 × 66.5 × 286.5 mm (width/height/depth) incl. projecting parts

### Hard disk drive capacity:

RDR-HX680: 120 GB

RDR-HX780: 160 GB

RDR-HX980: 250 GB

**Mass (approx.):** 4.4 kg

**Operating temperature:** 5°C to 35°C

**Operating humidity:** 25% to 80%

### Supplied accessories:

Mains lead (1)

Aerial cable (1)

Remote commander (remote) (1)

R6 (size AA) batteries (2)

Specifications and design are subject to change without notice.



---

# Index

Words in quotations appear in the on-screen displays.

## Numerics

“96 kHz PCM Output”  
108

## A

“A-B Erase” 60  
“A-B Repeat” 53  
“Add to Play List” 81  
Adjusting  
    playback picture 96  
    recording picture 96  
Aerial 16  
“AFT” 104  
“Album Name” 83  
ANGLE 51, 90  
“Angle Indicator” 51, 113  
“Artist Name” 83  
AUDIO 51  
Audio cord 20  
“Audio DRC” 108  
“Audio In” 106  
Audio input 21  
“Audio Language” 109  
“Audio Out” 107  
“Auto” 100  
“Auto Channel Setting”  
24, 102  
“Auto Chapter (DVD+R/  
+RW)” 111  
“Auto Chapter (HDD/  
VR)” 110  
“Auto Chapter (Video)”  
110  
Auto Clock Set 24, 100  
“Auto Language” 109  
“Auto Scan” 24, 102

## B

“Basic” 99, 100  
Batteries 22  
“Bilingual Recording”  
107  
Bilingual recording 45  
‘BRAVIA’ Sync 19

## C

Canal Plus 29  
“Cancel Protection” 93  
CD 127  
“CH System” 103  
“Change Genre” 59  
“Channel” 103  
“Channel Swapping” 104  
Chapter 36, 45  
“Chapter Edit” 61  
Chapter number 36  
“Chapter Search” 56  
“Chase Play” 55  
Checking/changing/  
cancelling timer settings  
46  
Child Lock 12  
“Clock Setting” 24, 100  
“Combine” 62, 63  
“Command Mode” 23,  
115  
COMPONENT VIDEO  
OUT 18  
“Component Video Out”  
105  
“Confirm Printer” 117  
Connecting  
    a printer 94  
    the aerial cable 16  
    the audio cords 20  
    the HDMI cord 17,  
    20  
    the USB device 78,  
    84  
    the video cords 17

Controlling TVs with the  
remote 22  
“Copy” 86  
“Copy Album” 79  
“Copy Album Contents”  
86  
“Copy all to HDD” 84  
“Copy Photos from a  
Digital Camera” 85  
Copy protection signals  
131  
“Copy to DVD” 86, 87  
“Copy to HDD” 84  
“Copy Track” 79  
Copy-Free 131  
Copying  
    albums 78  
    audio tracks 78  
    JPEG image files 84  
Copy-Never 131  
Copy-Once 131  
Country/Area code 132  
CPRM 126  
“Create x-Pict Story” 91  
Creating a Playlist 63

## D

DATA CD 127  
DATA DVD 127  
“Decoder” 30, 104  
DIGITAL OUT  
(COAXIAL) 20  
Disc settings 38, 39, 42,  
99  
“Disc Setup” 38, 39, 42,  
99  
Disc space 58  
Disc types 125, 127  
“Divide” 60, 62, 63  
DivX  
    “Registration Code”  
    116  
DivX video files 49

Dolby Digital 20, 107  
“Download from TV” 24, 102  
DTS 20, 107  
Dubbing  
    Dubbing List 66  
    HDD/DVD DUB 66  
    “High-Speed” 131  
    Move 131  
DV camcorder 74  
DV camcorder dubbing 74  
    “DV Manual Dubbing” 76  
    “DV One-Touch Dubbing” 76  
    “DV Playback” 77  
DV IN 74  
“DV Input” 75, 107  
“DV Manual Dubbing” 76  
“DV One-Touch Dubbing” 76  
“DV Playback” 77  
“DVD Backup” 69  
“DVD Menu Language” 109  
DVD VIDEO 127  
DVD+R 125  
DVD+RW 125  
DVD-R 125  
DVD-RAM 127  
DVD-RW 125

## E

Easy Setup 24, 101  
“Edit” 59, 83  
Editing 58  
    chapters 61  
    Playlist 63  
    titles 59  
Enter characters 37  
“Erase” 46, 59, 62, 83, 93  
“Erase Album” 93  
“External Audio” 106

## F

“Finalise” 39  
Finalising 39  
“Format” 42  
“Format DVD-RW” 99  
“Format HDD.” 100  
Formatting 42  
“Frame Accurate Editing” 58  
Freeze Frame 52  
Front panel 12  
“Front Panel Display” 115  
Front panel display 13  
“Full Dubbing” 72

## G

“Genre Name” 59

## H

Handling discs 133  
HDD camcorder 70  
HDD camcorder dubbing 70  
    “Full Dubbing” 72  
    “HDD-Cam Dubbing” 72  
    One-Touch Dubbing 72  
“HDD Recording Format” 111  
“HDD-Cam Dubbing” 72  
HDMI  
    “4:3 Video Output” 114  
    “Audio Output” 114  
    “Colour” 114  
    “Control for HDMI” 115  
    “Screen Resolution” 113  
HDMI cord 17, 20  
HDMI OUT 18, 20  
“HDMI Output” 113  
“HELP Setting” 101

## I

i.LINK 135  
INPUT 48  
“Input Colour System” 105  
“Input Line System” 101

## J

Jukebox 78

## L

Labelling 38  
“Language” 109  
“LINE 1 In” 106  
LINE 1/DECODER 26  
LINE 2 IN 27  
“LINE 3 Out” 105

## M

Main sound 45, 107  
Mains lead 21  
Making a backup disc 69  
Managing  
    audio tracks on the Music Jukebox 83  
    JPEG image files 93  
“Manual” 100  
“Manual CH Setting” 102  
Manual Clock Set 24, 100  
“Manual Rec. Mode” 110  
Manual recording mode 110  
MENU 49  
Menu  
    DVD’s Menu 49  
    Top menu 49  
“Modify” 46  
“Move” 63, 64  
MP3 audio tracks 49  
MPEG 20, 108  
“Multi-Mode” 59, 93  
“Music Jukebox” 78

## N

- “Name” 104
- “New Album” 93
- NICAM 45
- “NICAM Select” 106
- “NTSC on PAL TV” 106
- Number buttons 56

## O

- “On Screen Display” 115
- ONE-TOUCH DUB 72, 76
- One-Touch Play 19, 50
- “Optimise HDD” 100
- “Options” 115
- “Options 2” 117
- “Original” 34, 58, 80
- “OSD Language” 109

## P

- Page mode 34, 80, 89
- “Parental Control” 50, 112
- Parts and controls 10
- Pause Live TV 55
- “Pause Mode” 112
- PAY-TV 29
- PBC 49
- PDC 44
- “Photo Album” 84, 88
- “Picture Adjustment” 96
- Picture quality 96
- “Play List Name” 83
- PLAY MODE 53, 54
- Play mode
  - “A-B Repeat” 53
  - “Programme” 54, 82
  - “Repeat” 53
- Playable discs 125, 127
- “Playback” 111

Playback 49, 80, 88, 125, 127

- “A-B Repeat” 53
- DivX video files 49
- DV camcorder 77
- fast forward 52, 81
- fast reverse 52, 81
- freeze frame 52
- instant advance 51
- instant replay 51
- JPEG image files 88
- Jukebox 80
- MP3 audio tracks 49
- “Programme” 54, 82
- “Repeat” 53, 81
- resume play 50
- rotate 90
- scan audio 52
- slow-motion play 52
- zoom 90

- Playlist 34, 58, 80
- “Power Save” 101
- Printing JPEG image files 94
- “Programme” 54, 82
- “Progressive” 25
- “Protect” 59, 93
- “Protect Album Contents” 93
- “Protect Disc” 38
- Protection
  - album 93
  - disc 38
  - JPEG image file 93
  - title 59

## Q

- Quick Timer 45

## R

- Rear panel 14
- REC 31
- REC MODE 128
- REC STOP 31, 72, 76
- “Rec. Mode Adjust” 44, 110
- Recordable discs 125
- “Recording” 110
- Recording 43
  - picture adjustment 96
  - recording format 125
  - recording mode 33, 128
  - recording time 33, 128
  - while watching
    - another programme 32
- Recording mode 33, 128
- Recording time 33, 128
- Recovery Recording 44
- Region code 128
- Remaining time 36
- Remote 10, 22
- “Rename Album” 93
- “Rename File” 93
- “Repeat” 53, 81
- “Repeat Album” 53, 81
- “Repeat Artist” 81
- “Repeat Chapter” 53
- “Repeat Disc” 53
- “Repeat Play List” 81
- “Repeat Programme” 53, 81
- “Repeat Title” 53
- “Repeat Track” 53, 81
- Resetting the recorder 101, 124
- “Restart USB Device” 117
- Resume Play 50
- Rotate 90

## S

S VIDEO 18  
Satellite tuner 28  
Scan Audio 52  
“Seamless Playback” 112  
Searching  
    audio track 81  
    by genre 35  
    fast reverse/fast  
        forward 52, 81  
    JPEG image file 90  
    locating the  
        beginning of the  
        title/chapter/  
        track 51, 81  
    scan audio 52  
“Set Genre” 59  
“Set Preview” 116  
“Set Thumbnail” 59, 110  
Simultaneous Rec and  
Play 56  
“Skip” 102  
“Skip Once” 46  
Slideshow 90  
    x-Pict Story 91  
Slow-motion play 52  
SMARTLINK 19, 116  
“Sort Titles” 34  
“Sound System” 104  
Sub sound 45, 107  
SUBTITLE 51  
“Subtitle Display” 109  
“Subtitle Language” 109  
Super VIDEO CD 127  
Synchro Rec 47

## T

Thumbnail picture 35  
    preview mode 35,  
        116  
“Time Search” 56  
TIMER 43  
Timer List 46  
Timer recording  
    check/change/cancel  
        46  
    “Rec. Mode Adjust”  
        44  
    Synchro Rec 47  
Title 36  
Title List 33  
    “Genre” 35  
    “Sort Titles” 34  
    Thumbnail 35  
“Title Name” 59  
Title number 36  
“Title Search” 56  
TOP MENU 49  
“Track Name” 83  
“Track Search” 56  
Troubleshooting 118  
“Tuner” 102  
“Tuner Level” 106  
TV Direct Rec. 19, 32  
TV PAUSE 55  
“TV Pause” 55, 117  
TV system 104  
TV  $\Rightarrow$  22, 32  
“TV Type” 24, 111  
TV/DVD 23, 32

## U

“Undo” 59  
“Unfinalise” 41  
Unfinalising 41  
“Unprotected” 59  
Usable discs 125, 127  
USB 71  
Using the setup menus 99

## V

VIDEO CD 127  
Video cord 17  
“Video In/Out” 105  
Video input 18  
Video mode 125  
“Video Mode Compatible  
Editing” 58  
VPS 44  
VR mode 125

## X

x-Pict Story 91  
    “Play List” 92  
    “Theme” 92

## Z

Zoom 90  
ZWEITON 45



Printed on 70% or more recycled paper.



\*1-3293880113\*

3-293-880-11(1)