

SONY®

Digital Still Camera

Operating Instructions

Before operating the unit, please read this manual thoroughly, and retain it for future reference.

Owner's Record

The model and serial numbers are located on the bottom. Record the serial number in the space provided below. Refer to these numbers whenever you call upon your Sony dealer regarding this product.

Model No. DSC-F828

Serial No. _____

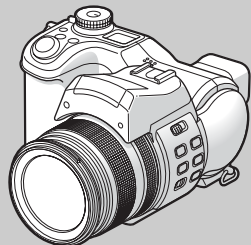

DSC-F828

Cyber-shot
Digital Still Camera



3-084-996-15(1)

Getting started _____

Shooting still images _____

Viewing still images _____

Deleting still images _____

Before advanced operations _____

Advanced still image shooting _____

Advanced still image viewing _____

Still image editing _____

Still image printing
(PictBridge printer) _____

Enjoying movies _____

Enjoying images on your computer _____

Troubleshooting _____

Additional information _____

Index _____

WARNING

To prevent fire or shock hazard, do not expose the unit to rain or moisture.

CAUTION

The use of optical instruments with this product will increase eye hazard. Use of controls or adjustments or performance of procedures other than those specified herein may result in hazardous radiation exposure.

For the Customers in the U.S.A.

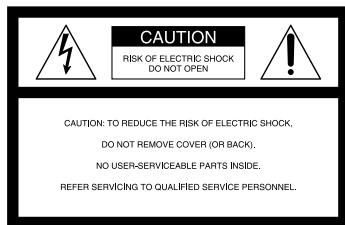

This symbol is intended to alert the user to the presence of uninsulated “dangerous voltage” within the product’s enclosure that may be of sufficient magnitude to constitute a risk of electric shock to persons.



This symbol is intended to alert the user to the presence of important operating and maintenance (servicing) instructions in the literature accompanying the appliance.

If you have any questions about this product, you may call:

Sony Customer Information Services Center
1-800-222-SONY (7669)

The number below is for the FCC related matters only.

Regulatory Information

Declaration of Conformity

Trade Name: SONY
Model No.: DSC-F828
Responsible Party: Sony Electronics Inc.
Address: 16450 W. Bernardo Dr,
San Diego, CA 92127
U.S.A.
Telephone No.: 858-942-2230

This device complies with Part 15 of the FCC Rules. Operation is subject to the following two conditions: (1) This device may not cause harmful interference, and (2) this device must accept any interference received, including interference that may cause undesired operation.

CAUTION

You are cautioned that any changes or modifications not expressly approved in this manual could void your authority to operate this equipment.

Note:

This equipment has been tested and found to comply with the limits for a Class B digital device, pursuant to Part 15 of the FCC Rules. These limits are designed to provide reasonable protection against harmful interference in a residential installation. This equipment generates, uses, and can radiate radio frequency energy and, if not installed and used in accordance with the instructions, may cause harmful interference to radio communications. However, there is no guarantee that interference will not occur in a particular installation. If this equipment does cause harmful interference to radio or television reception, which can be determined by turning the equipment off and on, the user is encouraged to try to correct the interference by one or more of the following measures:

- Reorient or relocate the receiving antenna.
- Increase the separation between the equipment and receiver.
- Connect the equipment into an outlet on a circuit different from that to which the receiver is connected.
- Consult the dealer or an experienced radio/TV technician for help.

The supplied interface cable must be used with the equipment in order to comply with the limits for a digital device pursuant to Subpart B of Part 15 of FCC Rules.

For the Customers in the U.S.A. and Canada

RECYCLING LITHIUM-ION BATTERIES

Lithium-Ion batteries are recyclable.

You can help preserve our environment by returning your used rechargeable batteries to the collection and recycling location nearest you.



For more information regarding recycling of rechargeable batteries, call toll free 1-800-822-8837, or visit <http://www.rbc.org/>



Caution: Do not handle damaged or leaking Lithium-Ion batteries.

CAUTION

TO PREVENT ELECTRIC SHOCK,
MATCH WIDE BLADE OF PLUG TO
WIDE SLOT, FULLY INSERT.

Notice for the customers in the United Kingdom

A moulded plug complying with BS 1363 is fitted to this equipment for your safety and convenience.

Should the fuse in the plug supplied need to be replaced, a fuse of the same rating as the supplied one and approved by ASTA or BSI to BS 1362, (i.e., marked with  or  mark) must be used.

If the plug supplied with this equipment has a detachable fuse cover, be sure to attach the fuse cover after you change the fuse. Never use the plug without the fuse cover. If you should lose the fuse cover, please contact your nearest Sony service station.

For the Customers in Europe

This product has been tested and found compliant with the limits sets out in the EMC Directive for using connection cables shorter than 3 meters (9.8 feet).

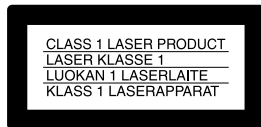

Attention

The electromagnetic fields at the specific frequencies may influence the picture and sound of this digital camera.

Notice

If static electricity or electromagnetism causes data transfer to discontinue midway (fail), restart the application or disconnect and connect the USB cable again.

Certain countries or regions may regulate disposal of the battery used to power this product. Please consult with your local authority.

Before using your camera

Trial recording

Before you record one-time events, you may want to make a trial recording to make sure that the camera is working correctly.

No compensation for contents of the recording

Contents of the recording cannot be compensated for if recording or playback is not possible due to a malfunction of your camera or recording medium, etc.

Back up recommendation

To avoid the potential risk of data loss, always copy (back up) data to a disk.

Notes on image data compatibility

- This camera conforms with the Design rule for Camera File system universal standard established by the JEITA (Japan Electronics and Information Technology Industries Association).
- Playback of images recorded with your camera on other equipment and playback of images recorded or edited with other equipment on your camera are not guaranteed.

Precaution on copyright

Television programs, films, video tapes, and other materials may be copyrighted. Unauthorized recording of such materials may be contrary to the provision of the copyright laws.

Do not shake or strike the camera

In addition to malfunctions and inability to record images, this may render the recording medium unusable or image data breakdown, damage or loss may occur.

LCD screen, LCD finder (only models with an LCD finder) and lens

- The LCD screen and the LCD finder are manufactured using extremely high-precision technology so over 99.99% of the pixels are operational for effective use. However, there may be some tiny black points and/or bright points (white, red, blue or green in color) that constantly appear on the LCD screen and the LCD finder. These points are normal in the manufacturing process and do not affect the recording in any way.
- Be careful when placing the camera near a window or outdoors. Exposing the LCD screen, the finder or the lens to direct sunlight for long periods may cause malfunctions.
- Do not press the LCD screen hardly. The screen may be uneven and that may cause a malfunction.
- Images may be trailed on the LCD screen in a cold location. This is not a malfunction.

The zoom lens

This camera is equipped with zoom lens. Be careful not to bump the lens, and be careful not to apply force to it.

Remove dirt from the surface of the flash

If the dirt changes color or sticks to the surface of the flash due to the heat of the flash, sufficient light may not be emitted.

Do not get the camera wet

When taking pictures outdoors in the rain or under similar conditions, be careful not to get the camera wet. If water gets inside of the camera, it may cause the camera to malfunction, sometimes beyond repair. If moisture condensation occurs, see page 143 and follow the instructions on how to remove it before using the camera.

Do not expose the camera to sand or dust

Using the camera in sandy or dusty locations may cause a malfunction.

Do not aim the camera at the sun or other bright light

This may cause irrecoverable damage to your eyes or the malfunction of your camera.

Note on locations where you can use the camera

Do not use the camera near a location that generates strong radio waves or emits radiation. The camera may not be able to record or play back properly.

The pictures used in this manual

The photographs used as examples of pictures in this manual are reproduced images, and are not actual images shot using this camera.

About the Carl Zeiss lens

This camera is equipped with a Carl Zeiss lens which is capable of reproducing fine images. The lens for this camera uses the MTF[#] measurement system for cameras developed jointly by Carl Zeiss, in Germany, and Sony Corporation, and offers the same quality as other Carl Zeiss lenses. The lens for your camera is also T*[#]-coated to suppress unwanted reflection and faithfully reproduce colors.

[#] MTF is an abbreviation of Modulation Transfer Function, a numeric value indicating the amount of light from a specific part of the subject gathered at the corresponding position in the image.

Trademarks

- “Memory Stick,” , and “MagicGate Memory Stick” are trademarks of Sony Corporation.
- “Memory Stick Duo” and **MEMORY STICK DUO** are trademarks of Sony Corporation.
- “Memory Stick PRO” and **MEMORY STICK PRO** are trademarks of Sony Corporation.
- “MagicGate” and **MAGICGATE** are trademarks of Sony Corporation.
- “InfoLITHIUM” is a trademark of Sony Corporation.
- Microsoft and Windows are registered trademarks of the U.S. Microsoft Corporation in the United States and other countries.
- Macintosh, Mac OS and QuickTime are trademarks or registered trademarks of Apple Computer, Inc.
- Pentium is a trademark or a registered trademark of Intel Corporation.
- CompactFlash is a trademark of SanDisk Corporation.
- Microdrive is a registered trademark of Hitachi Global Storage Technologies in the United States and/or other countries.
- In addition, system and product names used in this manual are, in general, trademarks or registered trademarks of their respective developers or manufacturers. However, the TM or © marks are not used in all cases in this manual.

Table of contents

Before using your camera	4
Identifying the parts	9

Getting started

Charging the battery pack	14
Using the AC Adaptor	17
Using your camera abroad	17
Turning your camera on/off	18
How to use the multi-selector	18
Setting the date and time	19

Shooting still images

Inserting and removing a recording medium	21
Switching the recording medium	21
Inserting and removing a “Memory Stick”	22
Inserting and removing a Microdrive/CF card	23
Setting the still image size	24
Image size and quality	25
Basic still image shooting	
– Using auto mode	27
Checking the last image shot	
– Quick Review	29
Shooting images with the finder	29
Indicators on the screen during shooting	30
Using the zoom feature	30

Changing the lens orientation	32
Shooting close-ups – Macro	33
Using the self-timer	34
Using the flash	34
Inserting the date and time on a still image	36
Shooting according to scene conditions – Scene Selection	37

Viewing still images

Viewing images on the screen of your camera	39
Viewing images on a TV screen	41

Deleting still images

Deleting images	43
Formatting a recording medium	45

Before advanced operations

How to setup and operate your camera	47
Changing menu settings	47
Changing items in the SET UP screen	48
How to use the command dial	48
Deciding the still image quality	49
Creating or selecting a folder	50
Creating a new folder	50

Selecting the recording folder	51
--------------------------------------	----

Advanced still image shooting

Manual features to photo-shooting situations	52
--	----

Exposure (shutter speed, aperture, and ISO sensitivity)	
Shooting with Program auto	54
Program Shift	54
Shooting with shutter speed priority mode	55
Shooting with aperture priority mode	56
Shooting with manual exposure mode	57
Selecting the metering mode	58
Adjusting the exposure	
– EV adjustment	59
Displaying a histogram	60
Shooting with the exposure fixed	
– AE LOCK	62
Shooting three images with the exposure shifted – Exposure Bracket	63
Selecting the ISO sensitivity – ISO	64
Focus	
Choosing an auto focus method	65
Choosing a focus range finder frame	
– AF range finder	65

Choosing a focus operation	
– AF Mode	66
Focusing manually	67
Flash	
Selecting a flash mode	68
Adjusting the flash level – Flash Level... ..	70
Using an external flash.....	71
Using the Sony Flash	72
Using a commercially available external flash	72
Color	
Adjusting color tones – White Balance... ..	73
Selecting color reproduction – Color.....	74
Burst	
Shooting images in succession.....	75
Shooting in Multi Burst mode	
– Multi Burst.....	76
Others	
Shooting in the dark	77
NightShot.....	77
NightFraming.....	78
Shooting with special effects	
– Picture Effect	79
Shooting still images in RAW mode	
– RAW	79
Shooting still images in TIFF mode	
– TIFF	80
Shooting still images for e-mail	
– E-Mail.....	81

Shooting still images with audio files	
– Voice	81

Advanced still image viewing

Selecting the folder and playing back images – Folder	83
Enlarging a portion of a still image	84
Enlarging an image	
– Playback zoom	84
Recording an enlarged image	
– Trimming.....	85
Playing back successive images	
– Slide show	85
Rotating still images – Rotate.....	86
Playing back images shot in Multi Burst mode	87
Playing back continuously.....	87
Playing back frame by frame	87

Still image editing

Protecting images – Protect	89
Changing image size – Resize	90
Choosing images to print	
– Print (DPOF) mark.....	91

Still image printing (PictBridge printer)

Connecting to a PictBridge printer.....	93
Preparing the camera.....	93
Connecting the camera to the printer	93
Printing images.....	94
Printing index-images	96

Enjoying movies

Shooting movies.....	100
Viewing movies on the screen	101
Deleting movies.....	102
Editing movies.....	103
Cutting movies.....	104
Deleting unnecessary portions of movies	104

Enjoying images on your computer

Copying images to your computer	
– For Windows users	105
Installing the USB driver	106
Installing “Image Transfer”	107
Installing “ImageMixer”	108
Connecting the camera to your computer	109

Copying images using “Image Transfer”	110
Changing “Image Transfer” settings	111
Copying images without using “Image Transfer”	111
Viewing the images on your computer	113
Image file storage destinations and file names	114
Viewing an image previously copied to a computer	116
Copying images to your computer	
– For Macintosh users	117

Troubleshooting

Troubleshooting	119
Warnings and messages	130
Self-diagnosis display – If a code starting with an alphabet letter appears	133

Additional information

The number of images that can be saved/shooting time	134
Menu items	137
SET UP items	140
Precautions	143
The “Memory Stick”	144
The Microdrive	145

On “InfoLITHIUM” battery pack	146
Specifications	147
Display window	149
The LCD/finder screen	150
Quick reference chart	155

Index

Index	158
-------------	-----

Identifying the parts

See the pages in parentheses for details of operation.

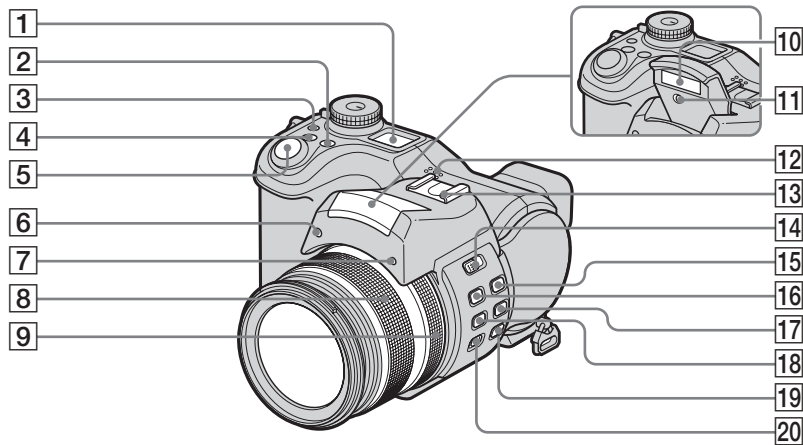

- 1 **Display window**
- 2 **WB (White balance) button** (73)
- 3 **☼ (Display window backlight) button**
- 4 **☑ (Exposure) button** (57, 59)
- 5 **Shutter button** (27)
- 6 **Hologram AF emitter** (35, 140)
- 7 **Self-timer lamp** (34)
- 8 **Zoom ring** (30)
- 9 **Manual focus ring** (67)

- 10 **Flash emitter** (34)
- 11 **Infrared ray emitter** (77)
- 12 **Speaker**
- 13 **Advanced accessory shoe** (71)
- 14 **▶ OPEN (FLASH) switch** (69)
- 15 **◼ (Metering mode) button** (58)
- 16 **⚡ (Flash) button** (68)
- 17 **⏏/BRK (Burst/Bracket) button** (63, 75, 76)
- 18 **🌸 (Macro) button** (33)

- 19 **NIGHTSHOT/NIGHTFRAMING button** (77)
- 20 **FOCUS (AUTO/MANUAL) switch** (67)

- Pressing the ☼ (Display window backlight) button turns on the backlight in the display window for about seven seconds.

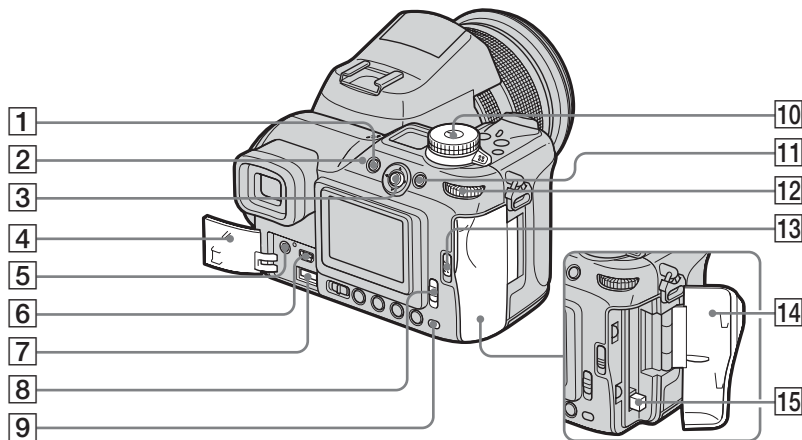

- 1 MENU button (47, 137)
- 2 (Flash) lamp (68)
- 3 Multi-selector () (18)
- 4 Jack cover (14, 17)
- 5 A/V OUT (MONO) jack (41)
- 6 (USB) jack (109)
- 7 DC IN jack (14, 17)
- 8 /CF ("Memory Stick"/CF card) switch (21)
- 9 Access lamp (22)

- 10 Mode dial (27)
 - :To shoot still images in auto adjustment mode
 - P: To shoot still images in program auto mode
 - S: To shoot in shutter speed priority mode
 - A: To shoot in aperture priority mode
 - M: To shoot in manual exposure mode
 - SCN: To shoot in Scene Selection mode

SET UP: To set the SET UP items

:To shoot movies

:To view or edit images

- 11 AE LOCK/ (Delete) button (43, 62)
- 12 Command dial (48)
- 13 OPEN (CF) lever (23)
- 14 CF card cover (23)
- 15 CF card eject lever (24)

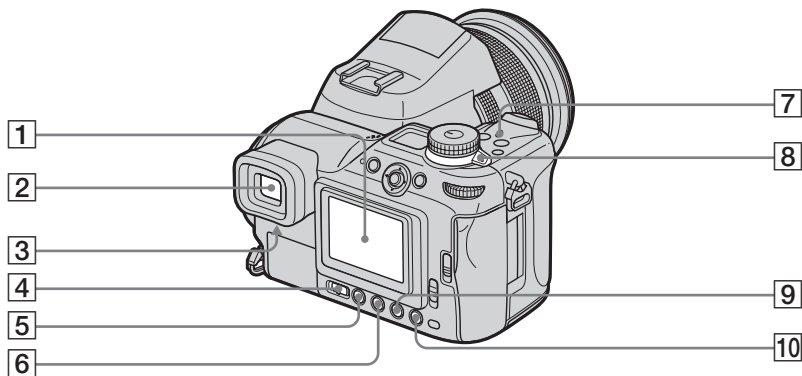

- 1** LCD screen
- 2** Finder (29)
- 3** Finder adjustment lever (29)
- 4** FINDER/LCD switch (29)
- 5**  (Screen status) button (30)
- 6**  (Self-timer/Index) button
(34, 40)
- 7** POWER lamp (18)
- 8** POWER switch (18)
- 9** Q (Digital zoom/Playback zoom)
button (30, 84)
- 10**  (Quick review) button (29)

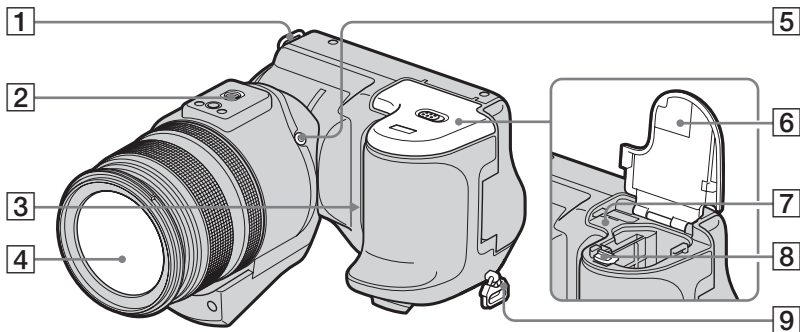

- 1 Hook for shoulder strap
- 2 Tripod receptacle
- 3 Microphone
- 4 Lens
- 5 ACC (Accessory) jack
- 6 Battery/"Memory Stick" cover (14)
- 7 RESET button (119)
- 8 Battery eject lever (15)
- 9 Hook for shoulder strap

- Use the ACC (accessory) jack to connect an external flash or the remote control tripod.
- Use a tripod with a screw length of less than 5.5 mm ($7/32$ inch). You will be unable to firmly secure the camera to tripods having longer screws, and may damage the camera.

Attaching the lens cap and the shoulder strap

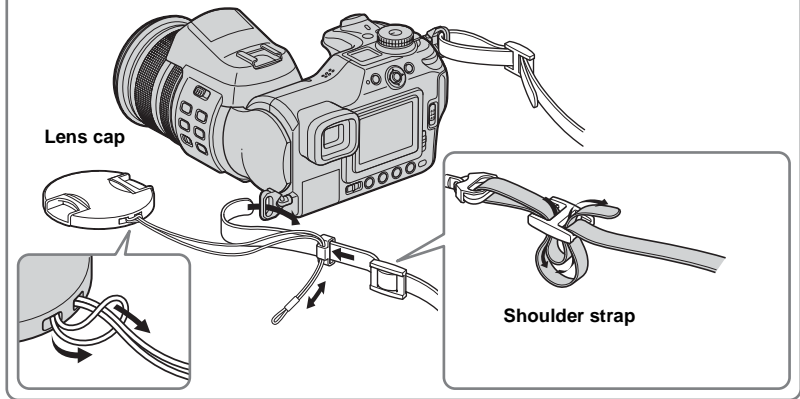

Attaching the lens hood

When you shoot in bright lighting conditions, such as outdoors, we recommend that you use the lens hood to reduce the image quality deterioration caused by unnecessary light.

- 1 Position the lens hood as shown below, by aligning the **U** mark on the lens hood and the **■** mark on the lens, and attach the hood to the lens.

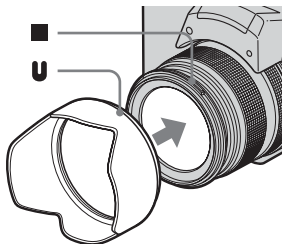

- 2 Turn the lens hood clockwise until it clicks.

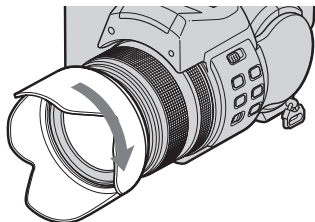

Storing the lens hood

The lens hood can be attached in the reverse direction to store it with the camera when it is not in use.

- 1 Position the lens hood as shown below, by aligning the **●** mark on the lens hood and the **■** mark on the lens, and attach the hood to the lens.

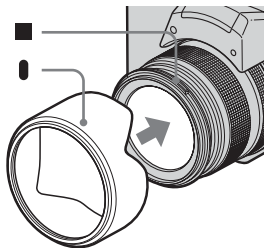

- 2 Turn the lens hood clockwise until it clicks.

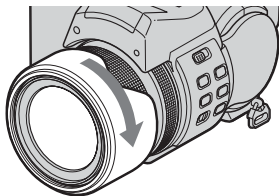

- You can attach the lens cap with the lens hood attached.
- When the lens hood is attached, it may block flashlight, hologram AF light, or infrared ray.

Charging the battery pack

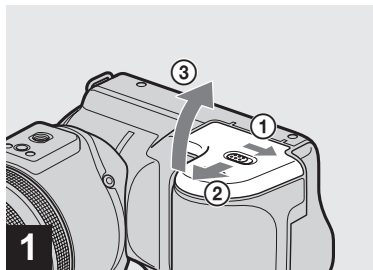

- ➔ **Open the battery/“Memory Stick” cover.**

Slide the cover in the direction of the arrow.

- **Be sure to turn off your camera when charging the battery pack (page 18).**
- Your camera operates with the “InfoLITHIUM” NP-FM50 battery pack (M Series) (supplied). You can use only M Series battery pack (page 146).

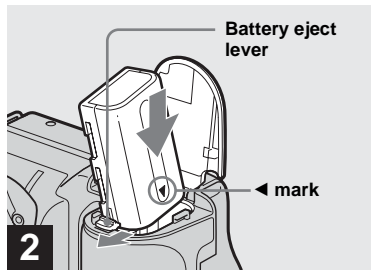

- ➔ **Install the battery pack, then close the battery/“Memory Stick” cover.**

Insert the battery pack with the ◀ mark facing toward the battery compartment as illustrated.

Make sure the battery pack is firmly inserted all the way, then close the cover.

- The battery pack is easily inserted by pushing the battery eject lever at the front of the battery compartment to the front side.

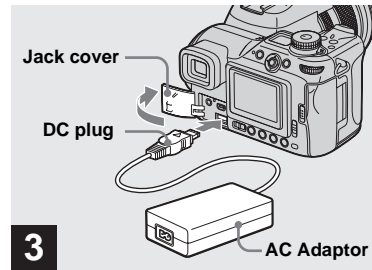

- ➔ **Open the jack cover and connect the AC Adaptor (supplied) to the DC IN jack of your camera.**

Open the cover in the arrow direction as illustrated above. Connect the plug with the ▲ mark facing up.

- Do not short the DC plug of the AC Adaptor with a metallic object, as this may cause a malfunction.
- Clean the DC plug of the AC Adaptor with a dry cotton bud. Do not use the dirty plug. Use of the dirty plug may not properly charge the battery pack.

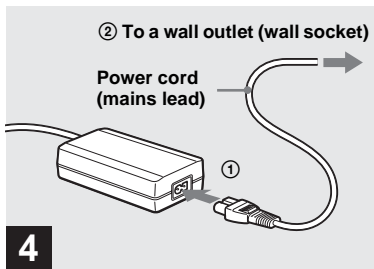

- ➔ **Connect the power cord (mains lead) to the AC Adaptor and then to a wall outlet (wall socket).**

During charging, the battery mark in the display window flashes, and after charging is completed, “Full” appears.

The available shooting time is indicated

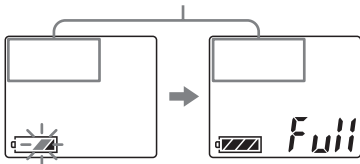

- The available shooting time on the display window is calculated as if the camera were used under the following conditions:
 - The mode dial is set to

- [LCD Backlight] or [EVF Backlight] is set to [Normal]
- Using a “Memory Stick”
- Not using the NightShot or NightFraming function.
- After charging the battery pack, disconnect the AC Adaptor from the DC IN jack of your camera and the wall outlet (wall socket).

To remove the battery pack

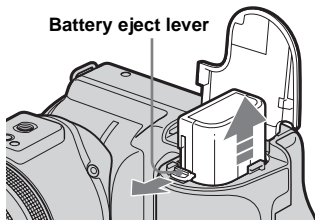

Open the battery/“Memory Stick” cover. Slide the battery eject lever in the direction of the arrow, and remove the battery pack.

- Be careful not to drop the battery pack when removing it.

Battery remaining indicators

The battery remaining indicators on the screen or on the display window show the remaining shooting or viewing time.

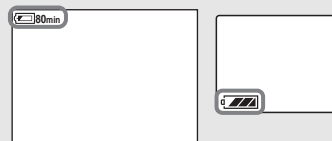

LCD screen/Finder

Display window

- The battery remaining time on the screen or on the display window may not be correct under certain circumstances or conditions.
- When you switch the FINDER/LCD switch or /CF switch, it takes about one minute for the correct battery remaining time to appear.

Charging time

Approximate time to charge a completely discharged battery pack using the AC Adaptor at a temperature of 25°C (77°F).

Battery pack	Charging time (min.)
NP-FM50 (supplied)	Approx. 150

Number of images and battery life that can be recorded/ viewed

The tables show the approximate number of images and the battery life that can be recorded/ viewed when you shoot images in normal mode with a fully charged battery pack at a temperature of 25°C (77°F). The numbers of images that can be recorded or viewed take into account changing the optional “Memory Stick” or Microdrive as necessary. Note that the actual numbers may be less than indicated depending on the conditions of use.

Shooting still images Under the average conditions¹⁾

Recording medium	NP-FM50 (supplied)	
	No. of images	Battery life (min.)
“Memory Stick”	Approx. 370	Approx. 185
Microdrive	Approx. 350	Approx. 175

¹⁾ Shooting in the following situations:

-  (P. Quality) is set to [Fine]
- [AF Mode] is set to [Monitor]
- Shooting one time every 30 seconds
- The zoom is switched alternately between the W and T ends
- The flash strobos once every two times
- The power turns on and off once every ten times

Viewing still images²⁾

Recording medium	NP-FM50 (supplied)	
	No. of images	Battery life (min.)
“Memory Stick”	Approx. 9400	Approx. 470
Microdrive	Approx. 5800	Approx. 290

²⁾ Viewing single images in order at about three second intervals

Shooting movies³⁾

	NP-FM50 (supplied)	
	“Memory Stick”	Microdrive
Continuous shooting	Approx. 200	Approx. 160

³⁾ Shooting continuously at [160] image size

- The number of images and the battery life that can be recorded/ viewed are decreased under the following conditions:
 - The surrounding temperature is low
 - The flash is used
 - The camera has been turned on and off many times
 - The zoom is used frequently
 - The NightShot or NightFraming function is activated
 - [LCD Backlight] or [EVF Backlight] is set to [Bright] in the SET UP settings
 - The battery power is low.The battery capacity decreases as you use it more and more and as time passes (page 147).

- The battery life and the number of images recordable or viewable does not depend on the image size setting.
- The number of images is almost the same whether you use the finder or the LCD screen for shooting/ viewing images.
- When using a CF card, the battery life and the number of images recordable or viewable may differ.

Using the AC Adaptor

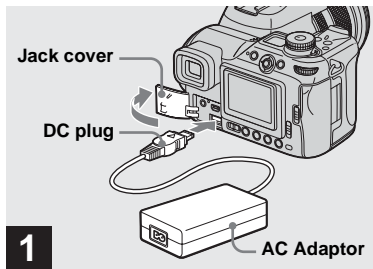

- ➔ **Open the jack cover, then connect the AC Adaptor (supplied) to the DC IN jack of the camera.**

Open the jack cover in the arrow direction as illustrated above. Connect the plug with the ▲ mark facing up.

- Connect the AC Adaptor to an easily accessible wall outlet (wall socket) close by. If any trouble occurs while using the adaptor, immediately shut off the power by disconnecting the plug from the wall outlet (wall socket).

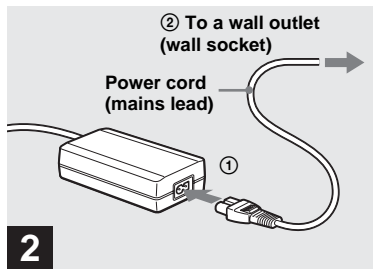

- ➔ **Connect the power cord (mains lead) to the AC Adaptor and to a wall outlet (wall socket).**

- When you have finished using the AC Adaptor, disconnect it from the DC IN jack of the camera and the wall outlet (wall socket).
- The set is not disconnected from the AC power source (mains) as long as it is connected to the wall outlet (wall socket), even if the unit itself has been turned off.

Using your camera abroad

Power sources

You can use your camera in any country or region with the supplied AC Adaptor within 100 V to 240 V AC, 50/60 Hz. Use a commercially available AC plug adaptor [a], if necessary, depending on the design of the wall outlet (wall socket) [b].

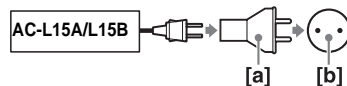

- Do not use an electrical transformer (travel converter), as this may cause a malfunction.

Turning your camera on/off

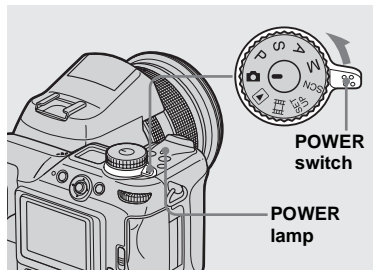

➔ **Slide the POWER switch in the direction of the arrow.**

The POWER lamp lights in green and the power is on. When you turn on the camera for the first time, the Clock Set screen appears (page 19).

To turn off the power

Slide the POWER switch in the direction of the arrow again, the POWER lamp goes out, and the camera turns off.

The Auto Power Off function

If no tasks are performed for about three minutes when shooting, viewing images, or setting up the camera while using the battery pack, power is automatically shut off to preserve battery power.

However, in the following circumstances, even if the battery pack is being used to power the camera, the Auto Power Off function will not work.

- Movies are being played back
- A slide show is being shown
- A cable is connected to the Ψ (USB) jack or the A/V OUT (MONO) jack

How to use the multi-selector

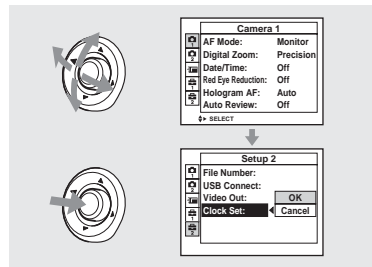

To change the current settings of the camera, bring up the menu or the SET UP screen (pages 47, 48), and use the multi-selector to make the changes.



When setting up the menu, move the multi-selector to $\blacktriangle/\blacktriangledown/\blacktriangleleft/\blacktriangleright$ to select the item or the setting and make the setting.

When setting up the SET UP, move the multi-selector to $\blacktriangle/\blacktriangledown/\blacktriangleleft/\blacktriangleright$ to select the item or the setting and press the center of the multi-selector to make the setting.

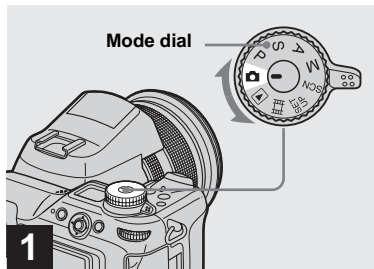
Setting the date and time



1 → Set the mode dial to .

- You can carry out this operation even when the mode dial is set to P, S, A, M, SCN,  or .
- To set the time and the date again, set the mode dial to SET UP, select [Clock Set] in  (Setup 2) (pages 48, 142), then proceed from Step **3**.

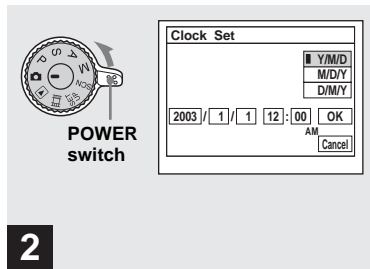

2 → Slide the POWER switch in the direction of the arrow to turn on the power.

The POWER lamp lights in green and the Clock Set screen appears on the screen.

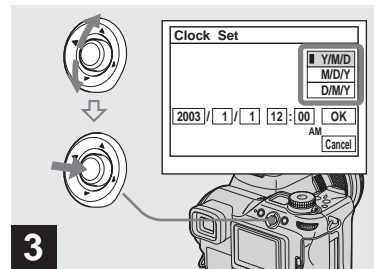

3 → Select the desired date format by moving the multi-selector to , then press the center.

You can select from [Y/M/D] (year/month/day), [M/D/Y], and [D/M/Y].

- If the rechargeable button battery, which provides the power for saving the time data, is ever fully discharged (page 144), the Clock Set screen will appear again. When this happens, reset the date and time by starting from Step **3** above.

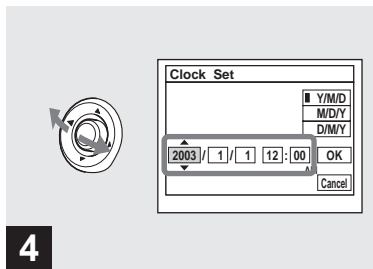

4 → Select the year, month, day, hour, or minute item you want to set by moving the multi-selector to ◀/▶.

▲ is shown above and ▼ is shown below the selected item.

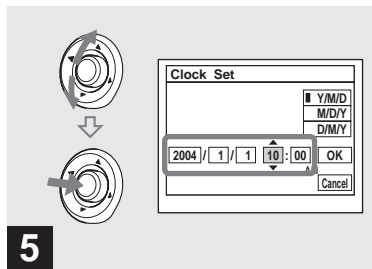

5 → Set the desired numerical value by moving the multi-selector to ▲/▼, then press the center.

After setting the current numerical value, set the next item. Repeat Steps **4** and **5** until all of the items have been set.

- If you select [D/M/Y] in Step **3**, set the time on a 24- hour cycle.
- 12:00 AM stands for midnight and 12:00 PM stands for noon.

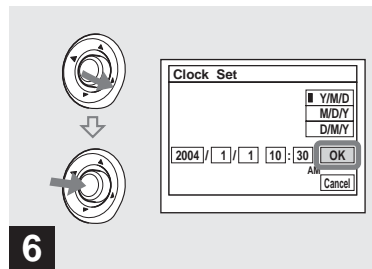

6 → Move the multi-selector to ▶ to select [OK], then press the center.

The date and time are set and the clock will start to keep time.

- To cancel the setting process, select [Cancel], then press the center.

Inserting and removing a recording medium

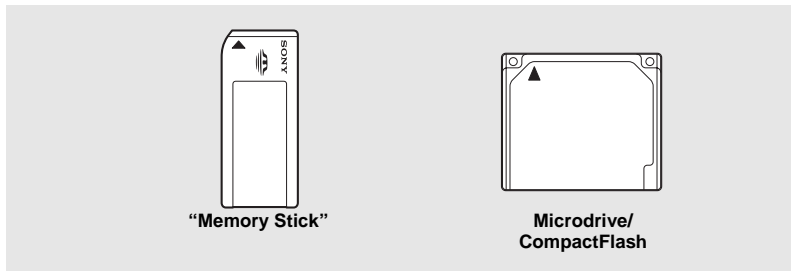

You can use a "Memory Stick," Microdrive, or CompactFlash card (CF card) as a recording medium.

Microdrive

Hitachi Global Storage Technologies, Inc.
DSCM-11000 (1 GB)
HMS360402D5CF00 (2 GB)
HMS360404D5CF00 (4 GB)

We have checked the compatibility of CF cards compliant with CompactFlash Type I and Type II, however, we cannot guarantee proper operation of all CF cards.

- Copying between media cannot be done with this camera.
- For more information about the "Memory Stick," see page 144.
- The Microdrive is a compact and lightweight hard disk drive that complies with CompactFlash Type II standards. For more information about the Microdrive, see page 145.
- Before using a Microdrive/CF card, be sure to format it using this camera. Otherwise, satisfactory performance may not be obtained (page 45).

Switching the recording medium

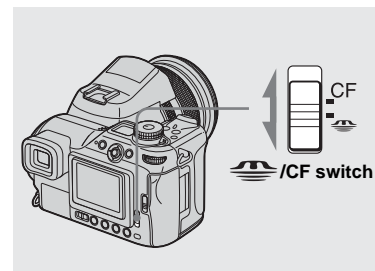

➔ **Select the recording medium with the  /CF switch.**

-  : When recording images onto a "Memory Stick" or playing back images from a "Memory Stick."
- CF** : When recording images onto a Microdrive/CF card or playing back images from a Microdrive/CF card.

Inserting and removing a "Memory Stick"

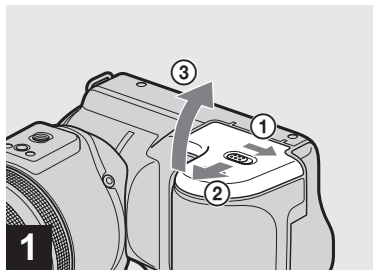

➔ **Open the battery/"Memory Stick" cover.**

Slide the cover in the direction of the arrow.

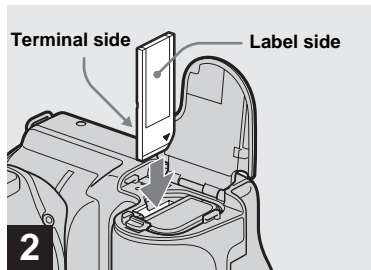

➔ **Insert the "Memory Stick."**

Insert the "Memory Stick" all the way in until it clicks as shown in the illustration.

- Whenever you insert a "Memory Stick," push it as far as it can go. If you do not insert it correctly, a proper recording or playback may not be carried out.

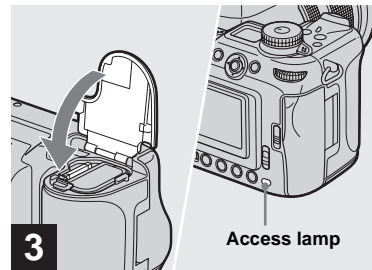

➔ **Close the battery/"Memory Stick" cover.**

To remove the "Memory Stick"

Open the battery/"Memory Stick" cover, then push the "Memory Stick" to pop it out.

- **Whenever the access lamp is lit, the camera is recording or reading out an image. Never remove the "Memory Stick" or turn off the power at this time. The data may be corrupted.**

Inserting and removing a Microdrive/CF card

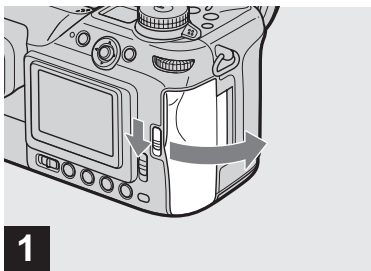

➔ Open the CF card cover.

Slide the  OPEN (CF) lever in the direction of the arrow.

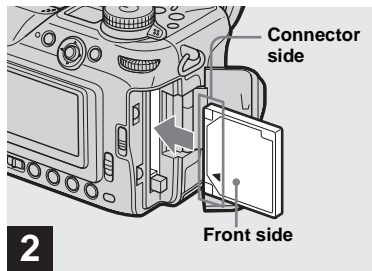

➔ Insert the Microdrive/CF card.

Insert the Microdrive/CF card all the way in from the connector side as shown in the illustration.

- If you cannot insert the Microdrive/CF card all the way in, do not push it forcefully. Also, check the direction of the Microdrive/CF card. If you try to insert it in the wrong direction, the camera or Microdrive/CF card may be damaged.

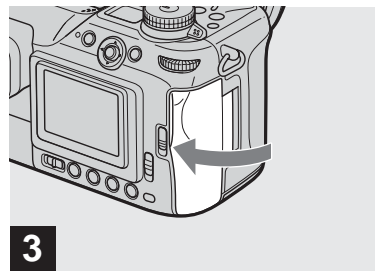

➔ Close the CF card cover.

- Close the CF card cover properly, otherwise you cannot record or play back images using the Microdrive/CF card.

Setting the still image size

To remove the Microdrive/CF card

Open the CF card cover, then push the CF card eject lever so that the Microdrive/CF card is ejected.

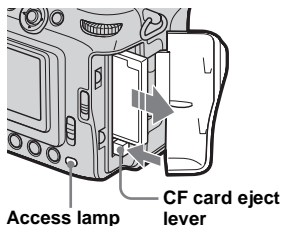

- Note that the Microdrive may be heated right after using the camera.
- **Whenever the access lamp is lit, the camera is recording or reading out an image. Never remove the Microdrive/CF card or turn off the power at this time. The data may be corrupted or the Microdrive/CF card may become unusable.**

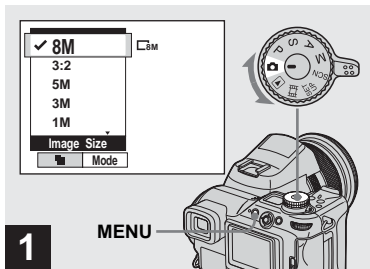

- Set the mode dial to and turn on the power, then press MENU.

The menu appears.

- You can carry out this operation even when the mode dial is set to P, S, A, M, SCN.

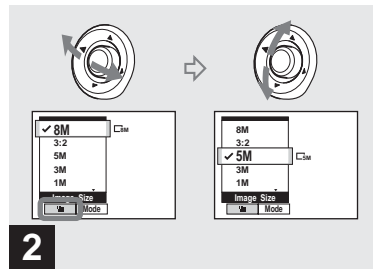

- Select (Image Size) by moving the multi-selector to , then select the desired image size by moving the multi-selector to .

The image size is set.



After the setting is completed, press MENU. The menu disappears from the screen.

- For more information about the image size, see page 25.
- This setting is maintained even when the power is turned off.

Image size and quality

You can choose image size (number of pixels) and image quality (compression ratio) based on the kind of images you want to shoot. The larger you make the image size and the higher you make the image quality, the better your image, but also the larger the amount of data needed to preserve your image. This means you can save fewer images in your recording medium.

Choose an image size and quality level appropriately for the kind of images you want to shoot.

Image size		Examples
8M ¹⁾ (3264×2448)	Larger   Smaller	<ul style="list-style-type: none"> • For storing important images or printing A3 size or fine A4 size images. • For printing A4 size or fine A5 size images. • For printing postcard size images. • For shooting a lot of images, attaching images to e-mail, or posting images to your home page.
3:2 ²⁾ (3264×2176)		
5M (2592×1944)		
3M (2048×1536)		
1M (1280×960)		
VGA (640×480)		

¹⁾The default setting is [8M]. This size can give the highest image quality using this camera.

²⁾This option records images in a horizontal to vertical proportion of 3:2 to match the size of the print paper used.

The number of images that can be saved in a “Memory Stick”³⁾

The number of images that can be saved in Fine (Standard)⁴⁾ mode are shown below. (Units: number of images)

Capacity	16MB	32MB	64MB	128MB	MSX-256	MSX-512	MSX-1G
8M	4 (7)	8 (15)	16 (30)	32 (60)	59 (109)	121 (223)	247 (456)
3:2	4 (7)	8 (15)	16 (30)	32 (60)	59 (109)	121 (223)	247 (456)
5M	6 (11)	12 (23)	25 (48)	51 (96)	92 (174)	188 (354)	384 (723)
3M	10 (18)	20 (37)	41 (74)	82 (149)	148 (264)	302 (537)	617 (1097)
1M	24 (46)	50 (93)	101 (187)	202 (376)	357 (649)	726 (1320)	1482 (2694)
VGA	97 (243)	196 (491)	394 (985)	790 (1975)	1428 (3571)	2904 (7261)	5928 (14821)

³⁾When [Mode] (REC Mode) is set to [Normal]

For the number of images that can be saved in other modes, see pages 134, 135.

⁴⁾For more information about the image quality (compression ratio) mode, see page 49.

The number of images that can be saved in a Microdrive³⁾

The number of images that can be saved in Fine (Standard)⁴⁾ mode are shown below.
(Units: number of images)

Capacity Image size	1G (DSCM-11000)
8M	273 (505)
3:2	273 (505)
5M	426 (801)
3M	684 (1217)
1M	1643 (2988)
VGA	6573 (16434)

³⁾ When [Mode] (REC Mode) is set to [Normal]
For the number of images that can be saved in other modes, see page 136.

⁴⁾ For more information about the image quality (compression ratio) mode, see page 49.

- When the images recorded using other Sony devices are played back, the image size indication may be different from the actual image size.
- When the images are viewed on the screen of the camera, they all look the same size.
- Number of shooting images can differ from these values according to shooting conditions.
- When the remaining number of images recordable is more than 9999, “>9999” is indicated on the screen. And when it is more than 999, “999” is indicated on the display window.
- You can resize the images later (Resize function, see page 90).

Basic still image shooting – Using auto mode

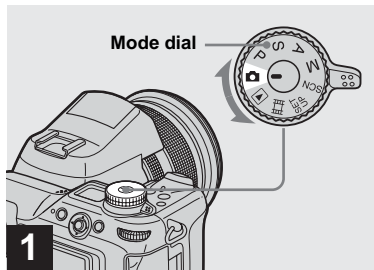

- ➔ **Set the mode dial to , and turn on the camera.**

The recording folder name is indicated on the screen for about five seconds.

Remove the lens cap.

- Select the recording medium using the  / CF switch (page 21).
- You can create a new folder in the recording medium and select the folder for storing images (page 50).



- ➔ **Hold the camera steadily with both hands and position a subject in the center of the focus frame.**

- The minimum focal distance to a subject is 50 cm (19 ³/₄ inches) (W)/60 cm (23 ⁵/₈ inches) (T). To shoot subjects at distances closer than this, use the macro mode (page 33).
- The frame indicated on the screen shows the focus adjustment range. (AF range finder, see page 65.)

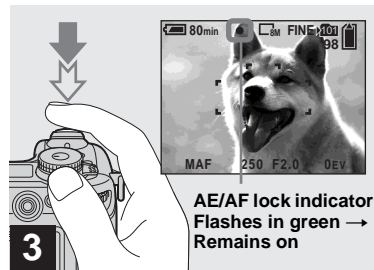

- ➔ **Press and hold the shutter button halfway down.**

The camera beeps. When the AE/AF lock indicator stops flashing and remains on, the camera is ready for shooting. (The screen may be frozen for a split second depending on the subject.)

When the surroundings are dark, the flash automatically pops up and strobes.

- If you release your finger from the shutter button, shooting will be canceled.
- When the camera does not beep, the AF adjustment is not complete. You can continue to shoot, but the focus is not set properly (except in Continuous AF, page 66).

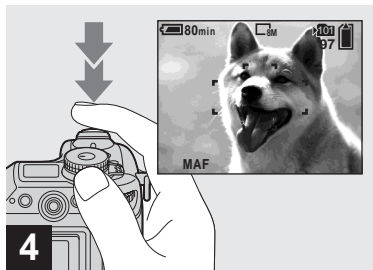

4

➔ **Press the shutter button fully down.**

The shutter clicks, the shooting is completed, and the still image is saved in the recording medium.

- When you are shooting with the battery pack, if no tasks are performed for a while with the camera turned on, power is automatically shut off to preserve battery power (page 18).

Mode dial for still image shooting

When shooting still images with your camera, you can choose from the following shooting methods.

(Auto adjustment mode)

The focus, exposure and white balance are automatically adjusted to allow easy shooting. The image quality is set to [Fine] (page 49).

P (Program auto shooting)

Shooting adjustment is automatically carried out just as in the auto adjustment mode. However, you can intentionally adjust the focus, exposure, etc. In addition, you can set the desired functions using the menu (pages 47 and 137).

S (Shutter speed priority)

You can select the shutter speed (page 55). In addition, you can set the desired shooting functions using menus (pages 47 and 137).

A (Aperture priority)





You can select the aperture value (page 56). In addition, you can set the desired shooting functions using menus (pages 47 and 137).

M (Manual exposure)

You can manually adjust the shutter speed and the aperture value (page 57). In addition, you can set the desired shooting functions using menus (pages 47 and 137).

SCN (Scene Selection)

You can select from the following modes to shoot according to the scene conditions (page 37).

-  (Twilight mode)
-  (Twilight portrait mode)
-  (Landscape mode)
-  (Portrait mode)

In addition, you can set the desired shooting functions using menus (pages 47 and 137).

About Auto Focus

When you try to shoot a subject that is hard to focus on, the AE/AF lock indicator will change to flashing slowly and the AE lock beep does not sound (except in Continuous AF, page 66).

The Auto Focus function may be difficult to use with in the following subjects. In such cases, release the shutter button, then try to recompose the shot and focus again.

- The subject is distant from the camera and dark
- The contrast between the subject and its background is poor
- The subject is seen through glass, such as a window
- A fast-moving subject
- The subject has a reflection, such as that from a mirror, or there is a luminous body and a lustrous subject
- A flashing subject
- A backlit subject.

There are two Auto Focus functions: “AF range finder frame” which sets the focus position according to the subject position and size, and “AF mode” which sets when the camera starts and stops focusing on. See page 65 for details.

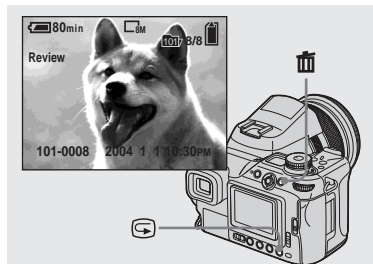

Checking the last image shot – Quick Review



→ Press (quick review).

To return to shooting mode, press the shutter button lightly or press  (quick review) again.

To delete the image displayed on the screen

- 1 Press  (delete).
- 2 Select [Delete] by moving the multi-selector to , then press the center. The image is deleted.

Shooting images with the finder

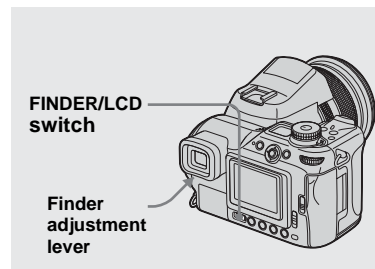

With the FINDER/LCD switch, you can choose to shoot either using the finder or the LCD screen. When you use the finder, the image does not appear on the LCD screen. Adjust the finder adjustment lever until the image appears clearly within the finder, then shoot the image.

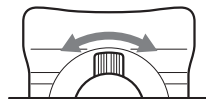

Indicators on the screen during shooting

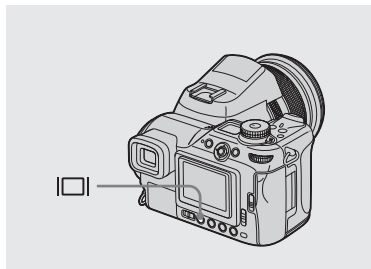

Each time you press  (screen status), the display changes in the following order.

- The status of the screen changes between indicators-on and indicators-off when playing back or shooting movies.
- For a detailed description of the indicators, see page 150.
- For a detailed description of the histogram, see page 60.
- This setting is maintained even when the power is turned off.

Indicators on

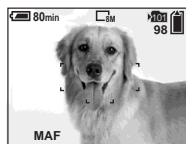

Histogram on

(Image information is displayed during playback)

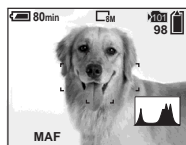

Indicators off

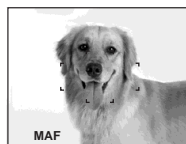

Using the zoom feature

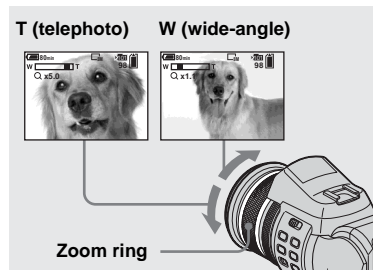

- ➔ Turn the zoom ring to choose the desired image size for shooting.

You can zoom in up to 7.1× using the optical zoom.

The minimum distance needed to focus on a subject

When the zoom is set all the way to the W side:

approximately 50 cm (19 ³/₄ inches) from the end of the lens

When the zoom is set all the way to the T side:

approximately 60 cm (23 ⁵/₈ inches) from the end of the lens

- When not using the camera, retract the lens in by setting the lens to its W-end position to protect it.

Digital zoom

Enlarges the image using digital processing. Pressing **Q** (digital zoom) activates the digital zoom. There are two modes in the digital zoom function. One is “Precision digital zoom” and the other is “Smart zoom.” Because each mode uses different methods and has different magnifying capacity, choose the mode according to your shooting.

The **Q** icon changes as follows according to the zoom mode.

Optical zoom: **Qx**

Precision digital zoom: **PQx**

Smart zoom: **SQx**

- The digital zoom cannot be used when shooting in RAW mode (page 79).
- AF range finder frame is not shown when using the digital zoom. The AF range finder frame indicator flashes and a centrally-located subject has priority when the camera is focusing.

Precision digital zoom

Enlarges the image two times larger than the optical zoom scaling now selected. The maximum zoom scaling is about 14× regardless of the selected image size. Since the precision digital zoom cuts part of the image and enlarges the rest, the image quality deteriorates.

Set [Digital Zoom] to [Precision] in the SET UP settings (page 140).

The default setting is [Precision].

Changing the lens orientation

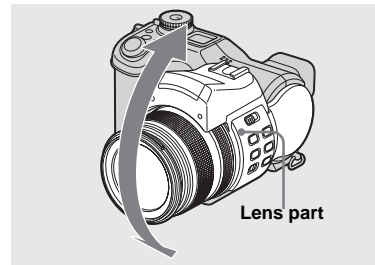

You can adjust the angle by turning the lens part upward up to 70 degrees and downward up to 30 degrees.

Smart zoom

You can zoom in the image with much less image quality deterioration. You can use the smart zoom as though it were the optical zoom.

The zoom scaling becomes the number that multiplies the following smart zoom scaling by the optical zoom scaling now selected.

Set [Digital Zoom] to [Smart] in the SET UP settings (page 140).

The maximum zoom scale is as follows and it depends on the image size. The zoom scale displayed on the screen is an approximate value.

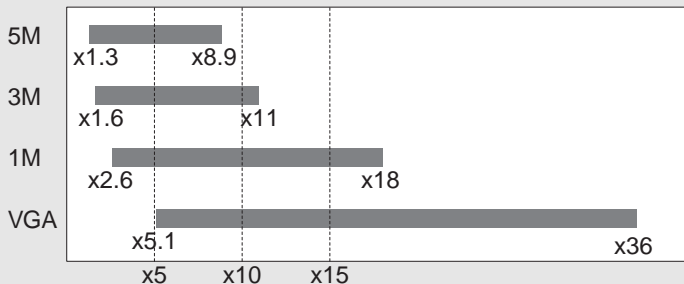

- When the image size is set to [8M] or [3:2], the smart zoom does not work.
- The digital zoom cannot be used when shooting in Multi Burst mode (page 76). When using the smart zoom, selecting (Multi Burst) using the /BRK button cancels the smart zoom.
- When using the smart zoom, the image on the screen may look rough. However, this phenomenon has no effect on the recorded image.

To cancel the digital zoom

Press **Q** (digital zoom) again. The zoom scaling returns to the number that was in effect using the optical zoom.

Shooting close-ups – Macro



For close-ups of subjects like flowers or insects, shoot using the macro feature. You can shoot subjects approaching up to 2 cm ($13/16$ inches) when the zoom is set to its W-end. However, the available focus distance depends on the zoom position. We recommend that you set the zoom to its W-end during shooting.

When the zoom is set all the way to the W side:



Approx. 2 cm ($13/16$ inches) from the end of the lens

When the zoom is set all the way to the T side:

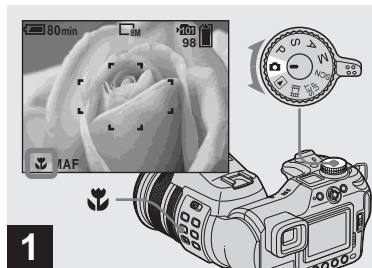

Approx. 60 cm ($23\ 5/8$ inches) from the end of the lens

- We recommend that you use Flexible Spot AF (page 65).



- ➔ Set the mode dial to , and press  (macro).

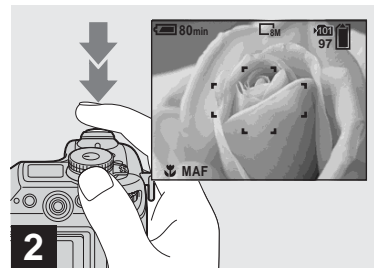

The  (macro) indicator appears on the screen.

- You can carry out this operation even when the mode dial is set to P, S, A, M, SCN (other than  (Twilight mode) or  (Landscape mode)) or .



- ➔ Center the subject in the frame, and press and hold the shutter button halfway down, then press the shutter button fully down.



To return to normal shooting

Press  (macro) again. The  indicator disappears from the screen.

- When shooting in macro mode, the focus range is very narrow and you may not be able to focus on the whole of the subject.
- When shooting in macro mode, the focus adjustment becomes slower to accurately focus on a close subject.

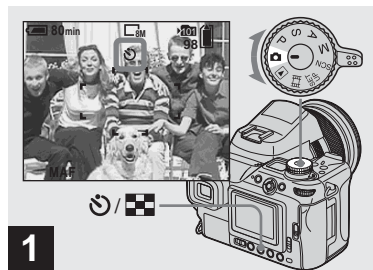
Using the self-timer



- ➔ Set the mode dial to , and press /  (self-timer).

The  (self-timer) indicator appears on the screen.

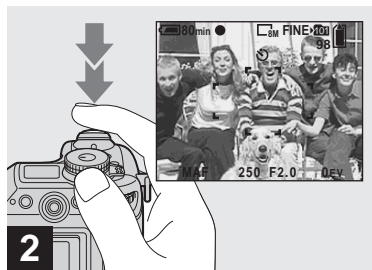

- You can carry out this operation even when the mode dial is set to P, S, A, M, SCN or .



- ➔ Center the subject in the frame, and press and hold the shutter button halfway down, then press the shutter button fully down.

The self-timer lamp (page 9) will flash, and you will hear a beeping sound. The image will be shot after approximately 10 seconds.

To cancel the self-timer during the operation



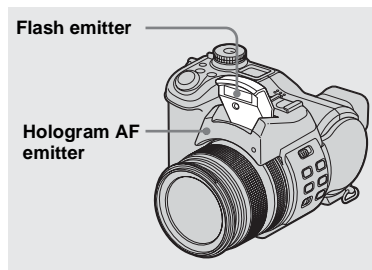

Press /  (self-timer) again. The  indicator disappears from the screen.

- If you stand in front of the camera and press the shutter button, the focus and the exposure may not be correctly set.

Using the flash



The flash automatically pops up and strobes when the surroundings are dark. Close the flash by hand after using it.

- When [ISO] is set to [Auto] in the menu settings, the recommended shooting distance using the flash is approx. 0.5 m to 4.5 m (19 ³/₄ inches to 14 feet 9 ¹/₄ inches) (W)/0.6 m to 3.3 m (23 ⁵/₈ inches to 10 feet 10 inches) (T).
- Attaching the supplied lens hood blocks the flash light.
- While the flash is being charged, the  (flash) lamp flashes. After charging is completed, the lamp goes out.
- You can also select the following flash modes:  (Forced flash),  SL (Slow synchro), and  (No flash). For details on these modes, see page 68.

Recording images with the hologram AF

The hologram AF is fill light to focus more easily on a subject in dark surroundings.



CONF appears on the screen and the hologram AF emits red light when the shutter button is pressed halfway until the focus is locked.



When not using this function, set [Hologram AF] to [Off] in the SET UP settings (page 140).

- If hologram AF light does not reach the subject sufficiently or the subject has weak contrast, focus will not be achieved. (An approximate distance of 0.5 m to 5.0 m (19 3/4 inches to 16 feet 4 7/8 inches) (W)/0.6 m to 3.5 m (23 5/8 inches to 11 feet 5 7/8 inches) (T) is recommended.)
- Focus is achieved as long as hologram AF light reaches the subject, even if the light is slightly off the center of the subject.
- When adjusting the focus manually (page 67), the hologram AF does not function.
- If the hologram AF emitter is dirty, the hologram AF light may be dimmed and focus

may not be achieved. In this case, wipe the hologram AF emitter with a dry cloth.

- Do not block the hologram AF emitter during recording.
- The AF range finder frame is not displayed. AF range finder frame indicator flashes and the centrally-located subject has priority to focus on.
- When you attach the supplied lens hood to the camera, the hologram AF light is blocked.
- The hologram AF does not function when [SCN] (Scene) is set to  (Twilight mode) or  (Landscape mode).

About Hologram AF

“Hologram AF (Auto-Focus)” is an AF fill light system that applies laser holograms to enable you to shoot still images in dark places. The Hologram AF system uses gentler radiation than conventional high-brightness LEDs or lamps, thus satisfying Laser Class 1* specifications and maintaining higher safety for human eyes. No safety problems will be caused by looking directly into the hologram AF emitter at a close range. However, it is not recommended to do so, because you may experience such effects like several minutes of residual image and dazzling, that you encounter after looking into a flashlight.

- * Hologram AF satisfies Class 1 (time base 30 000 seconds), specified in JIS (Japan), IEC (EU), and FDA (US) industry standards. Complying with these standards identifies the laser product as safe, under the condition that a human can look at the laser light either directly or focused through a lens for 30 000 seconds.

Inserting the date and time on a still image

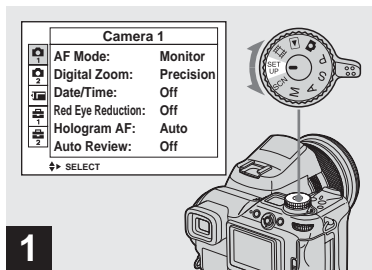

➔ Set the mode dial to SET UP.

The SET UP screen appears.

- The date and time cannot be inserted in Multi Burst mode.
- When images are shot with the date and time inserted, the date and time cannot be removed later.
- When shooting images with the date and time inserted, the actual date and time are not displayed on the screen, and **DATE** is displayed on the screen instead. The actual date and time are indicated in red on the lower-right corner when the image is played back.

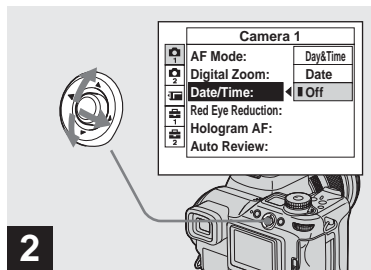

- ### ➔ Select (Camera 1) by moving the multi-selector to ▲, then move to ►.
- ### Select [Date/Time] by moving the multi-selector to ▲/▼, then move to ►.

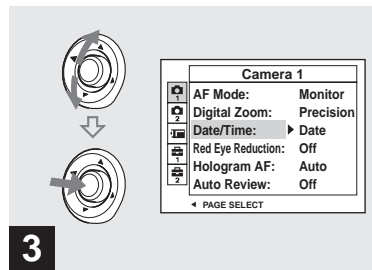

- ### ➔ Select the date and time setting by moving the multi-selector to ▲/▼, then press the center.

Day&Time: Inserts the date and the time of shooting into the image

Date: Inserts the year, the month and the date of shooting into the image

Off: Does not insert date/time data into the image

After the setting has been completed, set the mode dial to  to shoot your image.

- You can shoot even when the mode dial is set to P, S, A, M or SCN.
- When you chose [Date], the date will be inserted in the order set in "Setting the date and time" (page 19).
- This setting is maintained even when the power is turned off.

Twilight mode



When shooting night scenes, shooting people at night, shooting landscapes, or shooting portraits, use the modes listed below to increase the quality of your images.

Twilight mode

Under dark lighting conditions, you can shoot a distant night view. However, because the shutter speed is slower under these conditions, we recommend you use a tripod.

- You cannot use the following functions in Twilight mode:
 - Macro mode shooting
 - Shooting with the flash
 - Exposure Bracket
 - Burst mode shooting
 - Multi Burst mode shooting

Twilight portrait mode





Twilight portrait mode

Use this mode when shooting people in the foreground at night. This mode allows you to shoot images of people in the foreground with distinct outlines without losing the feeling that you are shooting at night. Because the shutter speed is slow, it is recommended that you use a tripod.

- The flash is set to  SL (Slow synchro).
- You cannot shoot in Exposure Bracket, Burst, or Multi Burst mode.

Landscape mode

Focuses on images far away, so is convenient for shooting landscapes at a distance.

- You cannot shoot in macro mode.
- The flash is set to  (Forced flash) or  (No flash).

Landscape mode

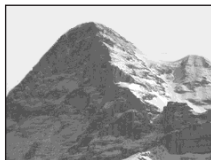

Portrait mode



Portrait mode

Backgrounds blur away, and the subject is sharpened.

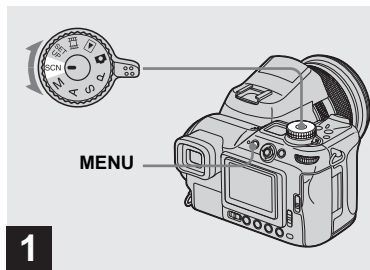

1 → Set the mode dial to SCN, then press MENU.

The menu appears.

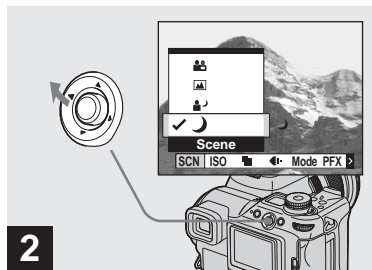

2 → Select [SCN] (Scene) by moving the multi-selector to ◀.

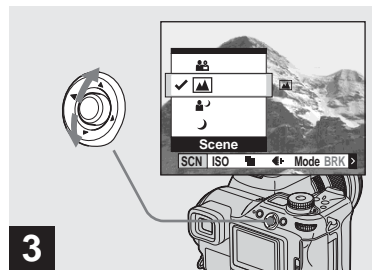

3 → Select the desired mode by moving the multi-selector to ▶/▼.

The mode is set.

When the setting is complete, press MENU so that the menu disappears from the screen.

To cancel the Scene Selection

Set the mode dial to a different mode.

- When the shutter speed becomes slower than particular time, the NR slow shutter function (page 55) activates automatically. In such cases, shooting may take some time.
- This setting is maintained even when the power is turned off.

Viewing images on the screen of your camera

Single screen



Index screen



You can view images shot with the camera almost immediately on the screen. You can select the following two methods for viewing images.

Single screen

You can view one image at a time, occupying the entire screen.

Index screen

Nine images are displayed simultaneously in separate panels on the screen.

- You can easily view the next/previous image by turning the command dial.
- For details on the movies, see page 101.
- For a detailed description of the screen indicators, see page 153.

Viewing on the single-image screen

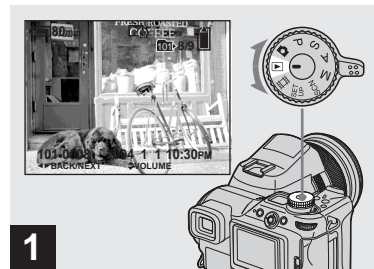

➔ **Set the mode dial to , and turn on the camera.**

The newest image in the selected recording folder (page 83) is displayed.

- The image may be too rough for image processing right after it is displayed.
- To select the recording medium, use the  / CF switch (page 21).

Viewing on the index screen

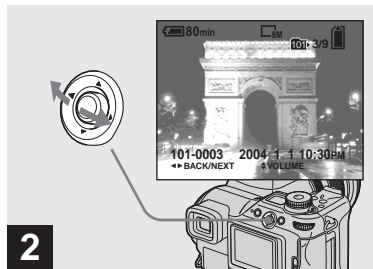

➔ **Select the desired still image by moving the multi-selector to ◀▶.**

◀ : Displays the previous image.

▶ : Displays the next image.

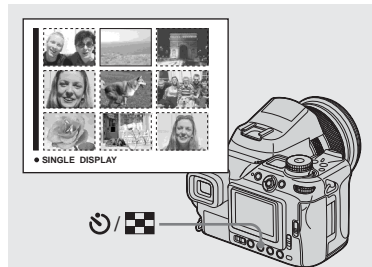

➔ **Press ⏪/⏩ (index).**

The display switches to the **Index screen**.

To display the next (previous) Index screen

Move the multi-selector to ▲/▼/◀/▶ to move the yellow frame up/down/left/right.

To return to the single-image screen

Press ⏪/⏩ (index) again, or press the center of the multi-selector.

Viewing images on a TV screen

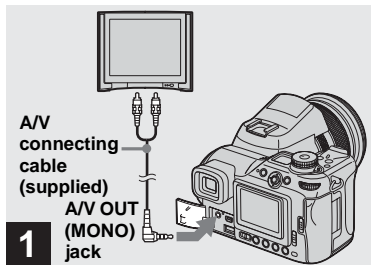

- ➔ **Connect the supplied A/V connecting cable to the A/V OUT (MONO) jack of the camera and the audio/video input jacks of the TV.**

If your TV has stereo type input jacks, connect the audio plug (black) of the A/V connecting cable to the Lch audio input jack.

- Turn off both the camera and the TV before connecting the camera and the TV with the A/V connecting cable.

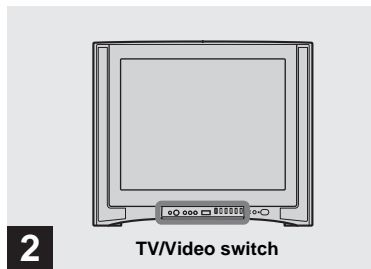

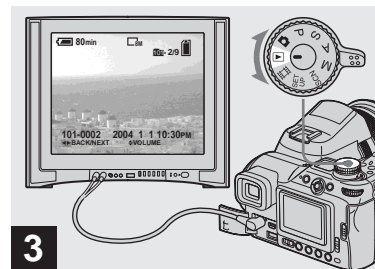

- ➔ **Turn on the TV, and set the TV/Video switch to “Video.”**

- The name and location of this switch may differ depending on your TV. For details, refer to the operating instructions supplied with the TV.



- ➔ **Set the mode dial to , and turn on the camera.**

Move the multi-selector to  to select the desired image.

- When using the camera abroad, it may be necessary to switch the video output signal to match that of your TV system (page 142).
- To select the recording medium, use the  / CF switch (page 21).

Watching images on a TV screen

If you want to view images on a TV, you need a TV having a video input jack and the A/V connecting cable (supplied).

The color system of the TV must match as that of your digital still camera. Check the following list:

NTSC system

Bahama Islands, Bolivia, Canada, Central America, Chile, Colombia, Ecuador, Jamaica, Japan, Korea, Mexico, Peru, Surinam, Taiwan, the Philippines, the U.S.A., Venezuela, etc.

PAL system

Australia, Austria, Belgium, China, Czech Republic, Denmark, Finland, Germany, Holland, Hong Kong, Hungary, Italy, Kuwait, Malaysia, New Zealand, Norway, Poland, Portugal, Singapore, Slovak Republic, Spain, Sweden, Switzerland, Thailand, United Kingdom, etc.

PAL-M system

Brazil

PAL-N system



Argentina, Paraguay, Uruguay

SECAM system

Bulgaria, France, Guiana, Iran, Iraq, Monaco, Russia, Ukraine, etc.

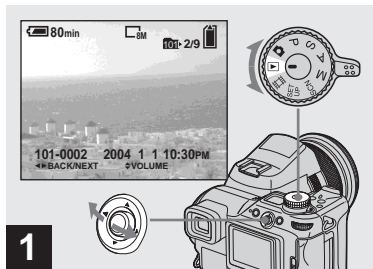
Deleting images



- 1** → Set the mode dial to , and turn on the camera.
Select the image you want to delete by moving the multi-selector to .

- To select the recording medium, use the  / CF switch (page 21).
- Note that the images once deleted cannot be recovered.

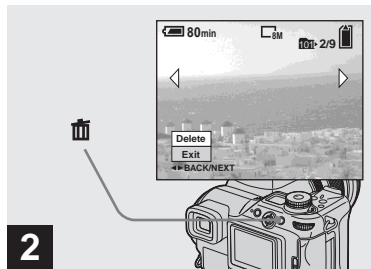

- 2** → Press  (delete).

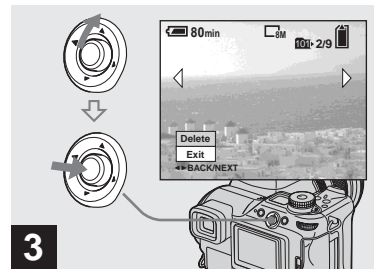

The image has not yet been deleted at this point.

- You cannot delete protected images (page 89).



- 3** → Select [Delete] by moving the multi-selector to , then press the center.

“Access” appears on the screen and the image will be deleted.

To delete other images continuously
Select the image you want to delete by moving the multi-selector to . Next, select [Delete] by moving the multi-selector to , then press the center.

To cancel the deletion

Select [Exit] by moving the multi-selector to , then press the center.

Deleting on the Index screen

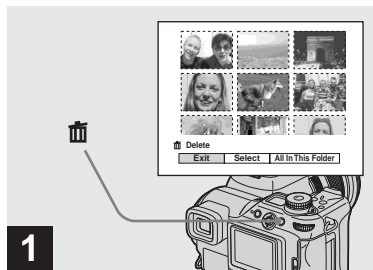



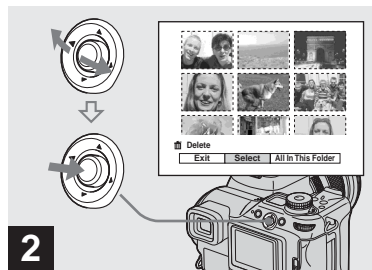

→ While an Index screen (page 40) is displayed, press  (delete).

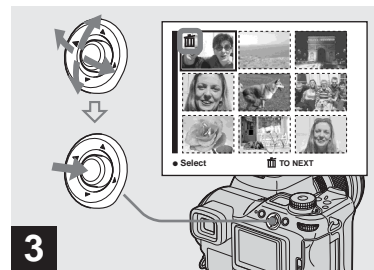

- Note that the images once deleted cannot be recovered.



→ Select [Select] by moving the multi-selector to , then press the center.





→ Select the image you want to delete by moving the multi-selector to , then press the center.

The  (delete) mark is indicated on the selected image. The image has not yet been deleted at this point. Put the  mark on all of the images you want to delete.

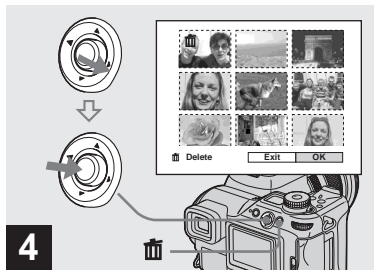
- To cancel your selection, select images you want to cancel and press the center of the multi-selector again. The  mark disappears.



- 4** → Press  (delete).
Select [OK] by moving the multi-selector to , then press the center.

“Access” appears on the screen and all of the images with  marks will be deleted.

To cancel the deletion

Select [Exit] by moving the multi-selector to , then press the center.

To delete all the images in the folder

In Step **2**, Select [All In This Folder] by moving the multi-selector to , then press the center. Next, select [OK], then press the center. All of the unprotected images in the folder are deleted. To cancel the deletion, select [Cancel], then press the center.

Formatting a recording medium

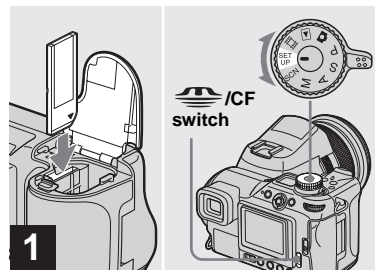

- 1** → Insert the recording medium you want to format into the camera. Select the recording medium with the  /CF switch. Set the mode dial to SET UP, and turn on the camera.

- The term “formatting” means preparing a recording medium to record images; this process is also called “initialization.”
- The “Memory Stick” is already formatted, and can be used immediately.
- Be sure to format the Microdrive/CF card using this camera. Otherwise, satisfactory performance may not be obtained.
- **When you format a recording medium, be aware that all of the data in the recording medium will be permanently erased. Protected images are also erased.**

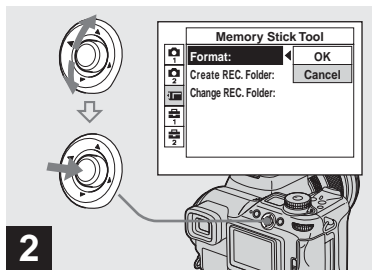

- 2** → When you format a “Memory Stick,” select (Memory Stick Tool) by moving the multi-selector to ▲/▼. When you format a Microdrive/CF card, select (CF Card Tool) by moving the multi-selector to ▲/▼. Select [Format] by moving the multi-selector to ►, then move to ►.

- When formatting a recording medium, we recommend that you use the AC Adaptor to prevent the camera turning off.

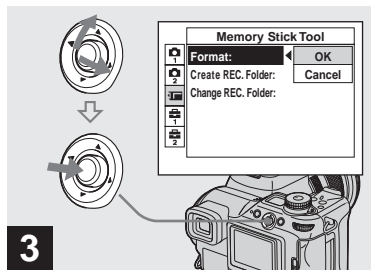

- 3** → Select [OK] by moving the multi-selector to ▲, then press the center.

To cancel the formatting

Select [Cancel] by moving the multi-selector to ▼, then press the center.

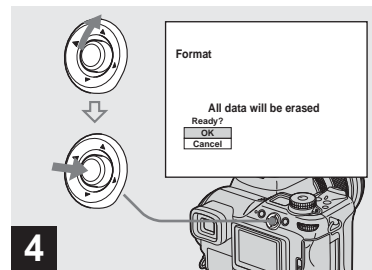

- 4** → Select [OK] by moving the multi-selector to ►, then press the center.

The “Formatting” message appears on the screen. When this message disappears, the format is complete.

How to setup and operate your camera

This section describes how to operate the menu and the SET UP screen. The multi-selector is used for these operation.

Multi-selector (▲/▼/◀/▶)

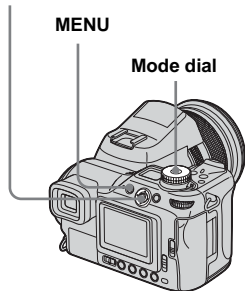

- For details on the mode dial, see page 28.

Changing menu settings

1 Press MENU.

The menu appears.

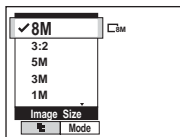

2 Select the setting item you want to change by moving the multi-selector to ◀/▶.

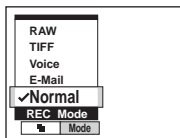

3 Select the desired setting by moving the multi-selector to ▲/▼.

The frame of the selected setting is scaled up, and the setting is entered.

When the ▲ mark is indicated above the item or the ▼ mark is indicated below the item

All of the available items are not displayed on the screen. Moving the multi-selector to ▲/▼ displays the hidden items.

To turn off the menu display

Press MENU.

- You cannot select the dim items.
- For details on the menu items, see page 137.

Changing items in the SET UP screen

1 Set the mode dial to SET UP.

The SET UP screen appears.

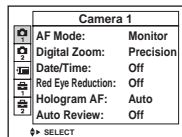

2 Select the setting item you want to change by moving the multi-selector to ▲/▼/◀/▶.

The frame of the item you select turns yellow.

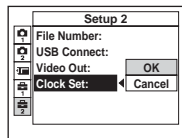

3 Press the center of the multi-selector to enter the setting.

To turn off the SET UP screen display

Set the mode dial to any position other than SET UP.

- For details on the SET UP items, see page 140.

How to use the command dial

There are two methods for operating the command dial. One is using only the command dial and the other is using the command dial in combination with other buttons. This section describes the method used when operating the command dial in combination with other buttons.

This method is used for the following functions.

- Manual exposure (page 57)
- Metering mode (page 58)
- Exposure adjustment (page 59)
- Exposure Bracket (page 63)
- Flash mode (page 68)
- White balance (page 73)
- Burst (page 75)
- Multi Burst (page 76)
- Nightshot/Nightframing (page 77)

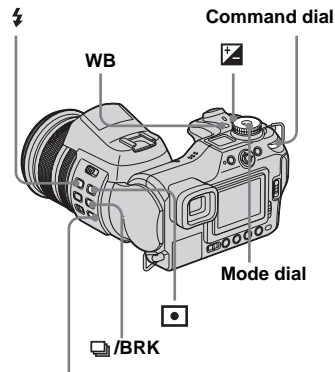

NIGHTSHOT/NIGHTFRAMING

1 Set the mode dial to P, S, A, M, SCN or .

2 Press and hold the button you want to operate and turn the command dial.



The value or setting that is indicated on the screen is entered.

3 Release the button.

The indicators disappears from the screen.

- The following functions can be set by simply turning the command dial.
 - Program shift (page 54)
 - Shutter speed priority mode (page 55)
 - Aperture priority mode (page 56)
- You can view the next/previous image during playback.

Deciding the still image quality

Mode dial: P/S/A/M/SCN

You can select the still image quality from [Fine] or [Standard].

This camera is equipped with other methods to select the image quality. You can select these settings using the [Mode] (REC Mode) item in the menu. These items are as follows: [RAW] which records raw data (page 79), [TIFF] which records uncompressed data (page 80), and [E-Mail] which records data suitable for sending e-mail (page 81).

Multi-selector (▲/▼/◀/▶)

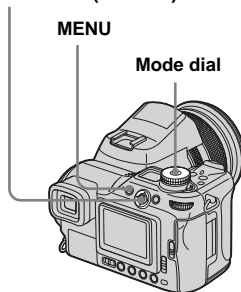

- 1** Set the mode dial to P, S, A, M or SCN.

- 2** Press MENU.

The menu appears.

- 3** Select (P. Quality) with ◀/▶, then select the desired image quality with ▲/▼.

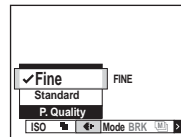

Creating or selecting a folder

Mode dial: SET UP

Your camera can create multiple folders within a recording medium. You can select the folder used to store images. When not creating a new folder, “101MSDCF” folder is selected as the recording folder.

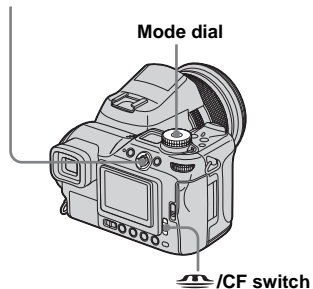

You can create folders up to “999MSDCF.”

Multi-selector (▲/▼/◀/▶)



- Up to 4000 images can be stored in one folder. When the folder capacity is exceeded, a new folder is automatically created.

Creating a new folder

- 1** Set the mode dial to SET UP, and select the recording medium with the /CF switch.
- 2** Select  (Memory Stick Tool) or  (CF Card Tool) with ▲/▼, [Create REC. Folder] with ▶/▲/▼, and [OK] with ▶/▲, then press the center.

The following screen appears.



- 3** Select [OK] with ▲, then press the center.

A new folder is created with a number one higher than the largest number in the recording medium, and the folder becomes the recording folder.



To cancel folder creation

In Step **2** or **3**, select [Cancel].

- Once you create a new folder, you cannot delete the new folder with the camera.

- Images are recorded in the newly created folder until a different folder is created or selected.

Selecting the recording folder

- 1** Set the mode dial to SET UP, and select the recording medium with the /CF switch.
- 2** Select  (Memory Stick Tool) or  (CF Card Tool) with $\blacktriangle/\blacktriangledown$, [Change REC. Folder] with $\blacktriangleright/\blacktriangledown$, and [OK] with $\blacktriangleright/\blacktriangle$, then press the center.

The recording folder selection screen appears.

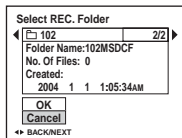

- 3** Select the desired folder with $\blacktriangle/\blacktriangleright$, and [OK] with \blacktriangle , then press the center.

To cancel changing the recording folder

In Step **2** or **3**, select [Cancel].

- You cannot select the “100MSDCF” folder as a recording folder.

- The image is stored in the newly selected folder. You cannot move images to other folders using the camera.

Manual features to photo-shooting situations

After you are familiar with your camera, let's shoot an image in various situations with some settings changed. This section describes some representative manual shooting examples.

Q: To shoot a portrait with its background blurred?



→ Shooting with aperture priority mode (page 56)

When you want to enhance the person with the background blurred, adjust the aperture manually. The more the aperture is opened (the aperture value becomes smaller), the narrower the focus is. The background is blurred accordingly.

Q: To shoot a portrait against light?



→ Selecting a flash mode (page 68)

Shooting a human subject in a bright place can create dim facial shadows. This occurs when the background is brighter than the person. In such cases, set the flash to ⚡ (Forced flash). You can shoot both the person and the background clearly.

- You can use the flash within the reach of the flash light.

Q: To shoot a night scene?



→ Shooting with shutter speed priority mode (page 55)

Using the flash in the auto adjustment mode restricts the shutter speed and the flash light does not reach distant subjects. The image, therefore, is not captured clearly. In such cases, slow the shutter speed manually, set the flash to ⊗ (No flash), and reduce the light using the EV adjustment. You can then shoot a clear night scene.

Q: To shoot without flash?



➔ Selecting the ISO sensitivity (page 64)

When you cannot use the flash or set the shutter speed slower, increase the ISO rating. The higher rated ISO setting helps maximize the effect of the surrounding light to shoot.

Q: To shoot a moving subject?



➔ Shooting with shutter speed priority mode (page 55)

When shooting a moving person or subject, set the shutter speed higher to freeze the motion or set the shutter speed slower to get the flow of motion of the subject. Adjust the shutter speed to express a moment that is beyond the speed of the naked eye.

Q: To shoot the beautiful afterglow of the sunset



➔ Adjusting color tones (page 73)

If the image you shot is not expressed in your favorite colors, change the white balance mode. Setting the white balance mode to  (Daylight) enhances the redness of the sunset.

Shooting with Program auto

Mode dial: P

In program auto mode, the camera automatically adjusts the shutter speed and the aperture according to the brightness of the subject just as in the auto adjustment mode (mode dial: ). In addition, the program auto mode can change the shooting settings in the menu, a feature which the auto adjustment mode does not have (page 137).

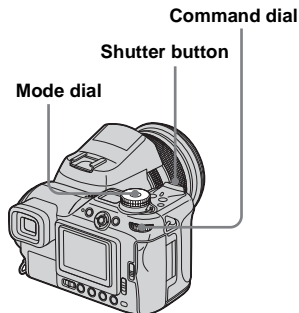

Program Shift

You can change the aperture value and shutter speed combination while keeping the brightness fixed.

- 1 Set the mode dial to P.**
- 2 Select the aperture value and shutter speed combination with the command dial.**

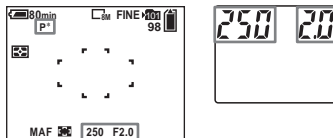

P* is indicated while the aperture value and shutter speed combination is shifted.

- 3 Shoot the image.**

To cancel Program Shift

Turn the command dial to return the indication from P* to P.

- You cannot shift the aperture value and shutter speed combination when the shutter button is pressed halfway down.
- When the brightness changes, the aperture value and shutter speed also change while maintaining the shift amount.

- You may not be able to change the aperture value and shutter speed combination depending on your shooting situations.
- When the flash mode setting is changed, Program Shift is canceled.
- Setting the mode dial to other than P or turning off the power cancels Program Shift.

Shooting with shutter speed priority mode

Mode dial: S

You can adjust the shutter speed manually. If you shoot a moving subject at a higher shutter speed, it appears as if frozen on the image. At a lower shutter speed, the subject appears as if it flowing.

Aperture value is automatically adjusted to attain correct exposure according to the brightness of the subject.



High shutter speed

Slow shutter speed

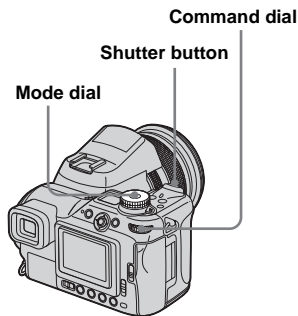

1 Set the mode dial to S.

2 Select a shutter speed with the command dial.

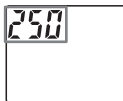
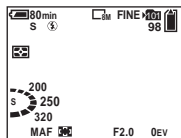

The shutter speed can be selected from 1/2000 to 30 seconds.

If you select 1/25 second or slower shutter speeds, the NR slow shutter function is automatically activated. In such cases, “NR” is indicated at the left of shutter speed indicator.

3 Shoot the image.

- Shutter speeds of one second or longer are indicated with ["] after the value, such as 1".
- If the proper exposure is not obtained after making the settings, the setting value indicators on the screen flashes when the shutter button is pressed halfway down. You can shoot in this condition, but we recommend that you adjust the flashing values again.
- The flash is set to ⚡ (Forced flash) or ⊕ (No flash).
- When the shutter speed is high, the amount of flash light may be insufficient even if you strobes the flash.
- You can adjust the exposure value (page 59).

NR slow shutter

The NR slow shutter mode reduces noise from recorded images, providing clear images. When using shutter speeds of 1/25 second or slower, the camera automatically works the NR slow shutter mode and “NR” is indicated next to the shutter speed indicator.



Press the shutter button fully down.

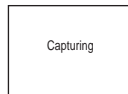

Then the screen turns black.

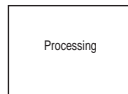

Finally, when “Processing” disappears, the image has been recorded.

- To eliminate the effects of vibration, use of a tripod is recommended.
- When a slow shutter speed is set, the processing may take some time. This is because the camera works to remove noise during the time set by the shutter speed setting.

Shooting techniques

When shooting a moving person, car, or spindrift, etc., using the high shutter speed, you can express moment that is beyond what the human eye can see.



When shooting a subject such as the flow of a river at a slower shutter speed, you can create an image that captures the subject's flowing movement. In such cases, use of a tripod is recommended to prevent camera shake.



- When you hand-hold the camera, adjust the shutter speed in a range where  (Vibration warning indicator) is not indicated.

Shooting with aperture priority mode

Mode dial: A

You can adjust the amount of light that passes through the lens. If you open the aperture (a smaller F-number), the amount of light allowed into the lens increases and the in-focus range becomes narrower. Only the main subject is then in focus. When the aperture is closed (a larger F-number), the amount of light decreases and the in-focus range becomes wider. The whole image is sharpened.

The shutter speed is automatically adjusted to obtain correct exposure according to the brightness of the subject.



Open the aperture



Close the aperture

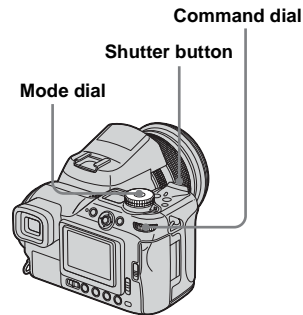

- 1 Set the mode dial to A.
- 2 Select an aperture value with the command dial.

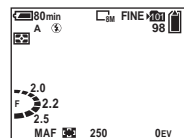

The range of values that can be selected varies, depending on the zoom position. The aperture value can be selected from F2 to F8 (W)/ from F2.8 to F8 (T).

- 3 Shoot the image.

- The shutter speed is automatically adjusted from 1/2000 to 8 seconds. When you set an aperture value of F8, the values start from 1/3200 second.
- If the proper exposure is not obtained after making the settings, the setting value indicators on the screen flashes when the shutter button is pressed halfway down. You can shoot in this condition, but we recommend that you adjust the flashing values again.
- The flash is set to ⚡ (Forced flash), ⚡SL (Slow synchro) or ⓧ (No flash).
- You can adjust the exposure value (page 59).

Shooting techniques

The depth of field is the in-focus range. Opening the aperture makes the depth of field shallower (the in-focus range becomes narrower) and closing the aperture makes the depth of field wider (the in-focus range becomes wider).



Open the aperture

The subject is clear and its background is blurred.



Close the aperture

Both the subject and its background are focused on.

Adjust the aperture to suit your purpose, either to sharpen the specific area of image, or to focus on the entire image.

Shooting with manual exposure mode

Mode dial: M

You can manually adjust the shutter speed and aperture values.

The difference between the set value and the appropriate exposure determined by the camera is displayed on the screen as the EV value (page 59). 0EV indicates the most suitable value set by the camera.

The camera maintains the setting even when the power is turned off. Once you set a value you like, you can reproduce the same exposure by simply setting the mode dial to M.



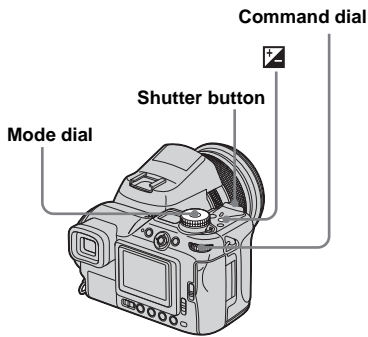

1 Set the mode dial to M.

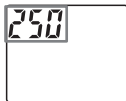
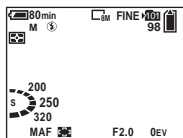

2 Select a shutter speed with the command dial.

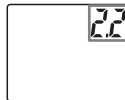
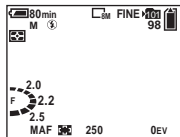

3 Press and hold  (exposure) and select an aperture value with the command dial.



4 Shoot the image.

- If the proper exposure is not obtained after making the settings, the setting value indicators on the screen flashes when the shutter button is pressed halfway down. You can shoot in this condition, but we recommend that you adjust the flashing values again.
- The flash is set to  (Forced flash) or  (No flash).

Selecting the metering mode

Mode dial: P/S/A/M/SCN/

You can select a metering mode to determine the exposure, depending on what part of the subject is used to measure.

Multi-pattern metering ()

The image is split up into multiple zones, each of which are evaluated individually. The camera calculates the best-fit exposure based on the subject's position and background brightness. The default setting is multi-pattern metering.

Center-weighted metering ()

Metering is performed with priority given to the center of the image. The camera determines the exposure based on the brightness of a subject near the center.

Spot metering ()

Spot metering allows you to meter for the subject directly in a small area of the whole image. This lets you adjust the exposure to the subject even when the subject is backlit or there is strong contrast between the subject and the background.

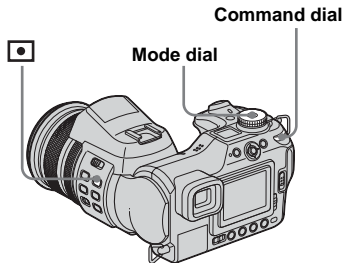

1 Set the mode dial to P, S, A, M, SCN or .

2 Press and hold  (metering mode) and select the desired metering mode with the command dial.

3 When selecting Spot metering in Step 2, position the spot metering cross hair on one point of the subject you want to shoot.

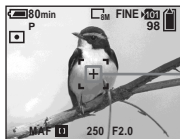

Spot metering cross hair

- When using center-weighted metering or spot metering, to focus on the same spot as used for metering, we recommend using the center weighted AF range finder frame (page 65).
- You cannot select the metering mode when using the NightShot/NightFraming function.

Adjusting the exposure

– EV adjustment

Mode dial: P/S/A/SCN/

You can manually shift the exposure value determined by the camera. Use this mode when you do not get the proper exposure, for instance, the subject and its background have high contrast (light and dark). The value can be set a range from +2.0EV to -2.0EV, in 1/3EV increments.

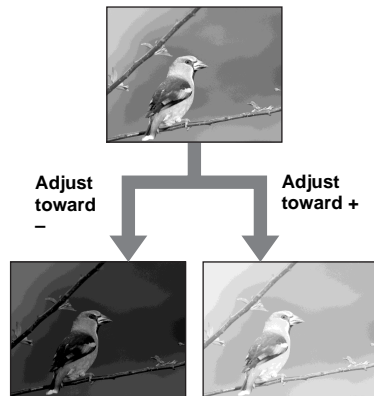

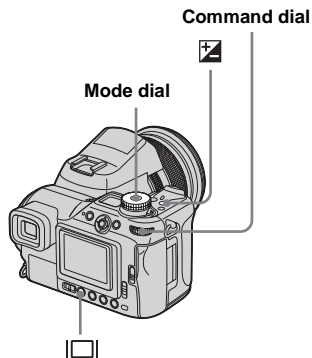

- 1 Set the mode dial to P, S, A, SCN or .
- 2 Press and hold (exposure) and select the desired exposure value with the command dial.

The value of the exposure adjustment is displayed. Adjust the exposure value while checking the brightness of the background.

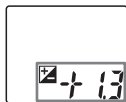
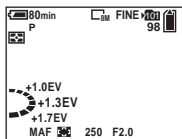

To reactivate auto exposure

In Step 2, select [0EV].

- When the subject is extremely bright or extremely dark, or when you are using the flash, the adjustment may not work.

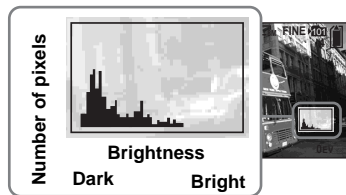

Displaying a histogram

A histogram is a graph showing the brightness of an image. The horizontal axis shows the brightness, and the vertical axis shows the number of pixels. The graph display indicates a dark image when skewed to the left side, and a bright image when skewed to the right side. The histogram is a useful reference for checking the exposure during recording and playback when the screen is hard to be seen.



- 1 Set the mode dial to P, S, A or SCN.
- 2 Press (screen status) to display the histogram.
- 3 Adjust the exposure based on the histogram.

- The histogram also appears when the mode dial is set to or M, but the EV adjustment is deactivated.

- The histogram also appears when you press  (screen status) while playing back a single image (page 39) or during Quick Review (page 29).
- The histogram does not appear in the following cases:
 - When the menu is displayed
 - During Quick Review of an image recorded in Exposure Bracket mode
 - When using playback zoom
 - When shooting or playing back movies
-  appears and the histogram does not appear in the following cases:
 - When recording in the digital zoom range
 - When the image size is [3:2]
 - When playing back Multi Burst mode images
 - When a still image is rotated
- The histogram before recording represents the histogram of the image displayed on the screen at that time. A difference occurs in the histogram before and after you press the shutter button. When this happens, check the histogram while playing back a single-image or during Quick Review.

In particular a large difference may appear in the following cases:

 - When the flash strobes
 - When using the NightFraming function
 - When [PFX] (P.Effect) is set to [Solarize]
 - When the shutter speed is slow or high
- The histogram may not appear for images recorded using other cameras.

Shooting techniques

While shooting images, the camera automatically determines the exposure. When shooting a whitish overall image such as a backlit subject or a snowy scene, the camera judges that the subject is bright and may set a darker exposure for the image. In such cases, adjustment of the exposure in the + plus direction is effective.



Adjust in the + direction



When shooting a darker overall image, the camera judges that the subject is dark and may set a brighter exposure for the image. In such cases, adjustment of the exposure in the – minus direction is effective.



Adjust in the – direction



You can check the exposure referring to the histogram chart. Be careful not to overexpose or underexpose your subject (giving a whitish or darkish image).

You can try to adjust the exposure to suit your taste.

Shooting with the exposure fixed

– AE LOCK

Mode dial: P/S/A/SCN/

You can lock the exposure before recomposing the image. This is useful when the contrast of the subject and its background is extremely high or you shoot a backlit subject.

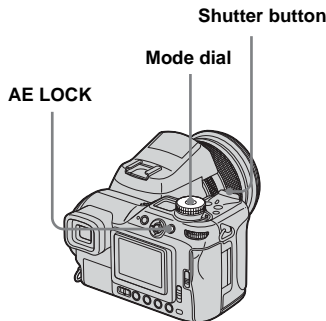

- 1** Set the mode dial to P, S, A, SCN or .

- 2** Target the subject for which you want to meter the exposure, then press AE LOCK.

The exposure is fixed and the * indicator appears.

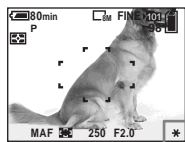

- 3** Recompose the image and press and hold the shutter button halfway down.

The focus is automatically adjusted.

- 4** Press the shutter button fully down.

To release AE LOCK

Carry out one of the followings:

- Press AE LOCK again after Step **2**.
- Release your finger from the shutter button after Step **3**.
- Press down the shutter button in Step **4**.

Shooting techniques

The camera automatically adjusts the exposure according to the subject. If you change the composition of your shot, the exposure may be changed, such as by changes in the brightness of the background. In such cases, use the AE lock function. You can shoot freely, regardless of the brightness of the subject.

To determine the exposure, measure the exposure of the desired portion of the subject using either center-weighted metering or the spot metering function. Press AE LOCK to lock the exposure, and then recompose the picture and shoot.

Portion of the image used to determine the exposure



Shooting three images with the exposure shifted

– Exposure Bracket

Mode dial: P/S/A/M/SCN

In addition to an image with the exposure automatically set by the camera, two other images are recorded with exposure values shifted to the + and – sides.

If you cannot shoot with the proper brightness due to the brightness of the subject, use the Exposure Bracket mode. You can select the image that has a suitable exposure after shooting.

First shot
(Adjusted in the + direction)



Second shot
(Proper exposure set by the camera)



Third shot
(Adjusted in the – direction)

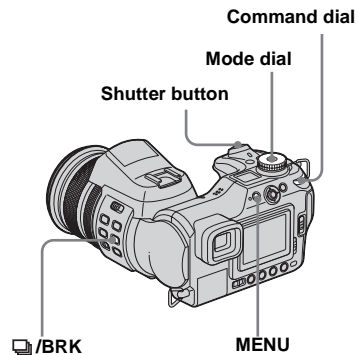
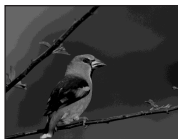

- 1 Set the mode dial to P, S, A, M or SCN.
- 2 Press and hold  /BRK (bracket) and select [BRK] with the command dial.

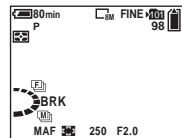

- 3 Press MENU.
The menu appears.

4 Select [BRK] (Bracket Step) with ◀/▶, then select the desired bracket step value with ▲/▼.

±1.0EV: Shifts the exposure value by plus or minus 1.0EV.

±0.7EV: Shifts the exposure value by plus or minus 0.7EV.

±0.3EV: Shifts the exposure value by plus or minus 0.3EV.

5 Shoot the image.

To return to normal mode

In Step **2**, select [Normal].

- When [Mode] (REC Mode) is not set to [Normal], you cannot use the Exposure Bracket mode.
- You may not be able to use the Exposure Bracket mode depending on the Scene Selection mode (page 37).
- You cannot use the flash in this mode.
- During shooting in this mode, the images are not displayed on the screen. Compose the image before pressing the shutter button.
- The focus and white balance are adjusted for the first image, and these settings are also used for the other images.
- When the exposure is manually adjusted (page 59), the exposure is shifted based on the adjusted brightness.
- The recording interval is approximately 0.42 second.

- If the subject is too bright or too dark, you may be unable to shoot properly with the selected bracket step value.
- You cannot select shutter speeds of 1/25 second or slower.

Selecting the ISO sensitivity

– ISO

Mode dial: P/S/A/M

You can change the camera's sensitivity to light. When you select a high-number setting, you can shoot in a dark place. Normally, the ISO sensitivity is set to [Auto]. When set to [Auto], the ISO sensitivity is automatically increased in a dark place.

Multi-selector (▲/▼/◀/▶)

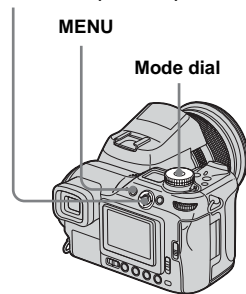

1 Set the mode dial to P, S, A or M.

2 Press MENU.

The menu appears.

3 Select [ISO] with ◀, then select desired setting with ▲/▼.

Choose from [800], [400], [200], [100], [64], or [Auto].

To return to normal mode

In Step 3, select [Auto].

- To reduce camera shake, select a large number. You can shoot a subject with higher shutter speed.
- When selecting a large number, the image becomes noisy. To give priority to image quality, select a small number.

Choosing an auto focus method

You can set the AF range finder frame and the AF mode.

AF range finder frame

The AF range finder frame selects the focus position according to the subject position and size.

AF Mode

The AF mode is set automatically when the camera starts and stops focusing on a subject.

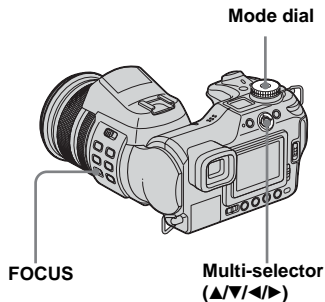

Choosing a focus range finder frame

– AF range finder

Mode dial: P/S/A/M/SCN/

Multipoint AF ()

The camera calculates the distance in five places to the top, the bottom, the left, the right, and in the center of the image, letting you shoot using the auto focus function without worrying about the image composition. This is useful when it is difficult to focus on the subject because it is not in the center of the frame. You can check the position where the focus was adjusted using the green frame. The default setting is Multipoint AF.

Center AF ()

The AF range finder is only the center of the frame. You can shoot in desired image composition using the AF lock method.

Flexible Spot AF (AF)

This is useful when focusing on an extremely small subject or a narrow area. Flexible Spot AF lets you shoot in the desired image composition. This is useful when you shoot using a tripod and the subject is out of the center area. When shooting a moving subject, take care to hold the camera steady so that the subject does not deviate from the range finder frame.

1 Set the mode dial to P, S, A, M, SCN or .

2 Set the FOCUS switch to AUTO.

3 Press the center of the multi-selector repeatedly to select the desired mode.

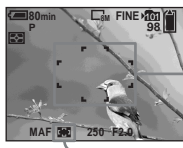

AF range finder frame

AF range finder frame indicator

4 When selecting Flexible Spot AF in Step **3**, move the AF range finder frame to the portion you want to focus on with .

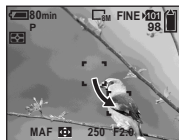

When you press and hold the shutter button halfway down, and the focus is adjusted, the color of the AF range finder frame changes from white to green.

- When you are shooting movies and you choose Multipoint AF, the distance to the center of the screen is estimated as an average, so the AF works even with a certain amount of vibration. The AF range finder frame indicator is . Center AF and Flexible Spot AF automatically focus only on selected frame, so this is convenient when you want to focus only on what you aim at.
- When you use the digital zoom or hologram AF, priority AF movement is given to subjects in or near the center of the frame. In this case, the AF range finder frame indicator flashes and the AF range finder frame is not displayed.

Choosing a focus operation

– AF Mode

Mode dial: SET UP

Single AF (S AF)

This mode is useful for shooting stationary subjects. The focus is not adjusted before you press and hold the shutter button halfway down. After you press and hold the shutter button halfway down and AF lock is complete, the focus is locked.

Monitoring AF (M AF)

This shortens the time needed for focusing. The camera automatically adjusts the focus before you press and hold the shutter button halfway down, letting you compose images with the focus already adjusted. After you press and hold the shutter button halfway down and AF lock is complete, the focus is locked.

The default setting is Monitoring AF.

- Battery consumption may be higher than in Single AF mode.

Continuous AF (C AF)

The camera adjusts the focus before you press and hold the shutter button halfway down, and then continues to adjust the focus even after AF lock is completed. This allows shooting of moving subjects with continued focus. However, focus adjustment may not be able to keep up when shooting fast moving subjects. The AF range finder frame is Center AF.

- The focus is not adjusted after the lock is completed in the following cases, and the “C AF” indicator flashes. The camera operates in Monitoring AF mode.
 - When shooting in the dark place
 - When shooting with a slow shutter speed
 - When using the NightShot/NightFraming functions
- There is no lock sound when the focus is achieved.
- When you press the shutter button all the way down using the self-timer, the focus is locked.
- Battery consumption may be higher than in any other AF mode.

1 Set the mode dial to SET UP.

2 Select  (Camera 1) with ▲, then select [AF Mode] with ►/▲.

3 Select the desired mode with ►/▲/▼, then press the center.

Focusing manually

Mode dial: P/S/A/M/SCN/

Normally the focus is automatically adjusted. However, the auto focus may not work well, such as in the following cases. In these cases, adjust the focus manually.

Subjects that are hard to be focused on

- Subjects with little contrast with backgrounds such as walls, and sky
- Subjects in very dark places
- Metals that have great reflection, or subjects with the light source behind them and that have great reflection.
- Subjects through a chain-link fence or glasses.

Mode dial

Manual focus ring

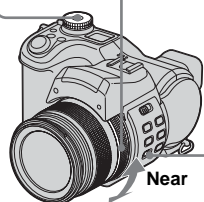

FOCUS

1 Set the mode dial to P, S, A, M, SCN or .

2 Set the FOCUS switch to MANUAL.

The  (manual focus) indicator appears on the screen.

3 Turn the manual focus ring to achieve a sharp focus.

The focus distance information indicator is displayed. You can adjust the focus in the following macro ranges.

T-side: about 60 cm (23 ⁵/₈ inches) to ∞ (infinite)

W-side: 2 cm (¹³/₁₆ inches) to ∞ (infinite).

If [Expanded Focus] in the SET UP settings is set to [On], the image is zoomed to 2× to achieve the focus easily when recording still images. The default setting is [On]. When the focus is adjusted to your requirements, the image returns to normal size and the focus indicator changes from yellow to white.

When the  indicator flashes, the focus distance has reached its limit.

To reactivate auto focusing

Set the FOCUS switch to AUTO.



- The focus distance information indicator is approximate, and should be used as a reference.
- The focus distance information indicator does not appear when using the NightShot function.
- When focusing manually, the following functions cannot be used:
 - Macro mode shooting
 - NightFraming function
- When recording movies, the expanded focus function cannot be used.

Selecting a flash mode

Mode dial: P/S/A/M/SCN

Normally, the flash automatically pops up and strobes when the surroundings are dark. You can intentionally change the flash mode.

Auto (No indicator)

The camera decides to use the flash based on lighting conditions. The default setting is Auto.

Forced flash (⚡)

The flash fires regardless of the amount of ambient light.



Slow synchro (⚡SL)

The flash fires regardless of the amount of ambient light. In this mode, the shutter speed becomes slower under dark conditions, so you can clearly shoot a background that is out of the flash-lit area.

No flash (⊘)

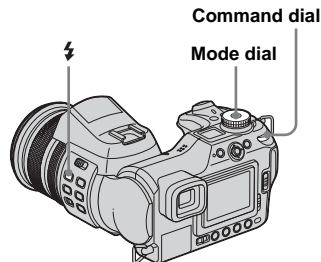
The flash does not fire regardless of the amount of ambient light.



- 1 Set the mode dial to , P, S, A, M or SCN.
- 2 Press and hold  (flash) and select the desired mode with the command dial.

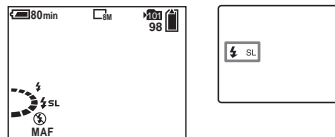

- Note that the surface of the flash emitter may be hot right after you use the flash several times in succession.
- The recommended distance using the flash is about 0.5 m to 4.5 m (19 ³/₄ inches to 14 feet 9 ¹/₄ inches) (W)/0.6 m to 3.3 m (23 ⁵/₈ inches to 10 feet 10 inches) (T) (when [ISO] is set to [Auto]).

- Attaching the supplied lens hood blocks a flash light.
- Because the shutter speed is slower under dark conditions when $\frac{1}{2}$ (Slow synchro) or ⓧ (No flash) is selected, it is recommended that you use a tripod.
- While the flash is being charged, the $\frac{1}{2}$ lamp flashes. After charging is completed, the lamp goes out.
- You can change the brightness of the flash using [Flash Level] in the menu settings (page 70). (Except when the mode dial is set to ⓧ .)
- You can mount an external flash on this camera (page 71).

To pop up the flash manually (Pop-up Flash mode)

Normally, the flash strobos automatically according to lighting conditions. However, you can pop up the flash only when you want to use it. Set [Pop-up Flash] to [Manual] in the SET UP settings (page 140).

To strobe the flash

- 1 Slide the \blacktriangleright OPEN (FLASH) switch in the arrow direction. The flash pops up.
- 2 Set the flash mode to $\frac{1}{2}$ (Forced flash) or $\frac{1}{2}$ (Slow synchro).
- 3 Shoot the image.

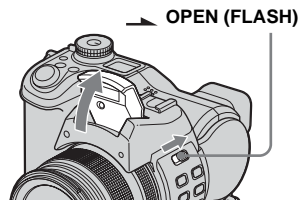

To return to auto mode

Set [Pop-up Flash] to [Auto] in the SET UP settings.

To reduce “red-eye” when shooting live subjects

The flash pre-strobes before shooting to reduce the red-eye phenomenon. Set [Red Eye Reduction] to [On] in the SET UP settings (page 140). ⦿ appears on the screen.



- The amount of red-eye reduction possible varies according to the individual. In addition, the distance to the subject, and whether or not the subject has seen pre-strobe light begin to strobe may also reduce the effectiveness of the red-eye reduction process.

Shooting techniques

Making the best of the flash gives you various options.

When you set the flash mode to ⚡ (Forced flash), you can shoot a back-lit subject brightly. An effect in which the flash light reflects in the subject's eye is also available.



When the flash mode is set to Auto, the flash may strobe regardless of your intentions. In such situations, setting the flash mode to ⊗ (No flash) slows the shutter speed automatically. This is effective when you shoot the trail of a car, the spectrum of a light, or the sunset. We recommend you use a tripod to prevent camera shake.



The ⚡SL (Slow synchro) is effective when you shoot a person during a sunset and the like. You can shoot the person clearly using the flash light and the background using a long exposure. If the camera cannot shoot clearly using the slow shutter, it automatically increases the ISO number. We recommend you use a tripod to prevent camera shake.



Adjusting the flash level

– Flash Level

Mode dial: P/S/A/M/SCN

You can adjust the amount of flash light.

Multi-selector (▲/▼/◀/▶)

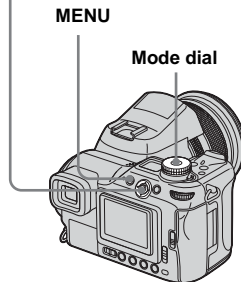

1 Set the mode dial to P, S, A, M or SCN.

2 Press MENU.

The menu appears.

- 3** Select [$\frac{1}{2}$ \pm] (Flash Level) with $\blacktriangle/\blacktriangleright$, then select the desired setting with $\blacktriangle/\blacktriangledown$.

High: Makes the flash level higher than normal.

Normal: Normal setting.

Low: Makes the flash level lower than normal.

Using an external flash

Mode dial:  /P/S/A/M/SCN

You can mount an optional external flash. Using an external flash increases the amount of light and that will allow you to shoot more vivid flash pictures than when using the internal flash.

For details, refer to the operating instructions supplied with your flash.

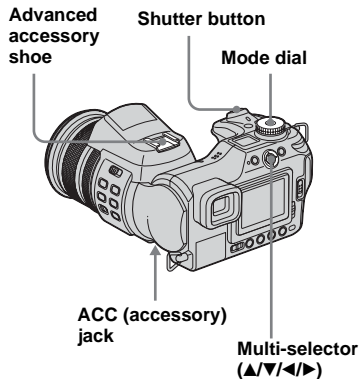

- When an external flash is mounted, the weight prevents the lens portion from becoming steady. We recommend supporting the lens portion with your left hand or using a tripod for recording.

- You cannot have an external flash and the built-in flash strobe at the same time.
- If you use two or more external flashes at the same time, note that the camera may not be able to function properly, or that may cause a malfunction.
- When the proper white balance is not set using an external flash, set the flash mode to $\frac{1}{2}$ (Forced flash) or $\frac{1}{2}$ SL (Slow synchro), then set the white balance using the SET (one-push SET) (page 73).

Using the Sony Flash

You can mount the Sony HVL-F32X or HVL-F1000 flash on the advanced accessory shoe of your camera. The HVL-F32X is also equipped with automatic flash level adjustment and AF fill light shooting functions.

1 Mount the external flash on the advanced accessory shoe.

2 Plug the flash into the ACC (accessory) jack.

When using the HVL-F32X, skip Step 2.

3 Turn on the external flash.

4 Set the mode dial to , P, S, A, M or SCN.

5 Shoot the image.

- Check that [Hot Shoe] is set to [Off] in the SET UP settings (page 140).
- When [ISO] is set to [800], you cannot use the AUTO “B” mode of the HVL-F32X.

Using a commercially available external flash

You can mount a commercially available external flash that supports the advanced accessory shoe.

1 Mount the external flash to the advanced accessory shoe.

2 Set the mode dial to SET UP.

3 Select (Camera 2) with $\blacktriangle/\blacktriangledown$, [Hot Shoe] with $\blacktriangleright/\blacktriangleleft$, [On] with $\blacktriangleright/\blacktriangleleft$, then press the center.

4 Turn on the external flash.

5 Set the mode dial to M or A.

The flash also strobos when the mode dial is set to , P, S or SCN, but we recommend recording with the mode dial set to M or A.

6 Shoot the image.

- If you record with [Hot Shoe] set to [Off] in the SET UP settings, the built-in flash may pop up. If this happens, return the built-in flash to its original position and set [Hot Shoe] to [On] (page 140).
- When you set [Hot Shoe] to [On] in the SET UP settings,  is indicated. In this case, the built-in flash is disabled.

- Set the most appropriate aperture value according to the guide number of the flash used and the distance to the subject.
- The flash guide number varies according to the ISO sensitivity (page 64) of the camera, so be sure to check the ISO number.
- Note that the camera may not function properly or may malfunction when using a flash manufactured by another company for a specific camera (generally a flash with multiple contact points on the advanced accessory shoe), a high-voltage type flash, or a flash accessory.
- Depending on the type of commercially available external flash, you may be unable to use some functions, and other operations may be difficult.

Adjusting color tones

– White Balance

Mode dial: P/S/A/M/SCN/☰

Normally, this camera adjusts color tones automatically, but you can also select the following modes according to your shooting situations. The color of the subject that you see will be captured according to the lighting conditions. When you want to fix the conditions under which the image is captured, or when the color of the entire image seems to be a bit unnatural, it is recommended that you adjust the white balance.

Auto (No indicator)

The white balance is set automatically in response to the condition of the subject. The default setting is Auto. (Color temperature: about 3000-7000 K)

☀ (Daylight)

Used when shooting outdoors, and for shooting at night, under neon lights, for fireworks, sunrise, and twilight gloom. (Color temperature: about 5500 K)

☁ (Cloudy)

Used when shooting under a cloudy sky. (Color temperature: about 6500 K)

☀ (Fluorescent)

Used when shooting under fluorescent lights.

(Color temperature: about 4000 K)

💡 (Incandescent)

- Used when shooting, for example, at a party, where the lighting conditions change often.

- Used in a studio, or under video lights.

(Color temperature: about 3200 K)

⚡WB (Flash)

Adjusts the white balance only to the flash conditions. This mode cannot be used with movies.

(Color temperature: about 6000 K)

☑ (One push)

For adjusting the white balance depending on the light source.

(Color temperature: about 2000-10000 K)

SET (One push SET)

Memorizes the basic white color which will be used in ☑ (One push) mode.

Multi-selector (▲/▼/◀/▶)

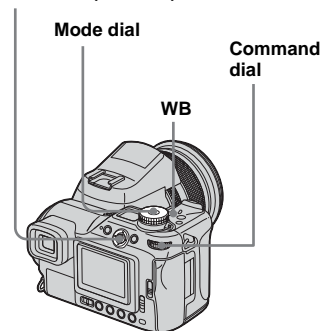

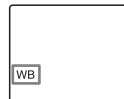
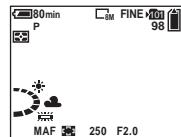

1 Set the mode dial to P, S, A, M, SCN or ☰.

2 Press and hold WB and select the desired setting with the command dial.







To return to automatic settings





In Step **2**, select [Auto].

- Under fluorescent lights that flicker, even if you choose , the white balance may not be properly adjusted.
- When the flash strobes, the manual setting is canceled, and the image is recorded in [Auto] mode (except in  (Flash) mode or  (One push) mode).

To capture the basic white color in SET (one-push SET) mode

This mode memorizes the basic white color in the shooting situation for the  (One push) mode. Use this mode when the other modes cannot set the color properly.

- 1 In Step **2**, select [ SET] (One push SET).
The  SET indicator appears.
- 2 Frame a white object such as a piece of paper filling the screen under the same lighting conditions as you will shoot the subject.
- 3 Press the center of the multi-selector. The screen momentarily turns black and the  SET indicator flashes quickly. When the white balance has been adjusted and stored in the memory, the  indicator lights up.

- When the  indicator flashes slowly, the white balance is not set or was not able to be set. Record in automatic white balance mode.
- Do not shake or strike the camera while the  SET indicator flashes quickly.
- When flash mode is set to  (Forced flash) or  (Slow synchro), the white balance is adjusted to the condition with the flash emitting.

Selecting color reproduction

– Color

Mode dial: P/S/A/M

You can select the color reproduction mode.

Standard (No indicator)

Shoots to make the resulting shot easier on the eyes. The image becomes vivid compared to its real color and the contrast becomes higher.

The default setting is [Standard].

Real (REAL)

Shoots for faithfulness to the actual texture and color, which the contrast, brightness, and saturation become lower. This mode is suitable for modifying the image on a computer.

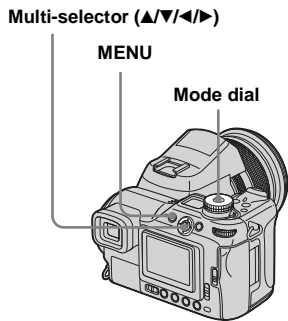

- 1** Set the mode dial to P, S, A or M.
- 2** Press MENU.
The menu appears.
- 3** Select COLOR (Color) with ◀/▶, then select the desired mode with ▲/▼.

Shooting images in succession

Mode dial: /P/S/A/M/SCN

You can shoot up to seven images in succession while pressing the shutter button only once.

Speed Burst ()

The frame interval becomes shorter (about 0.38 second), but the images are not displayed on the screen.

Framing Burst ()

The images are displayed on the screen during Burst shooting, but the frame interval becomes longer (about 0.42 second).

- When the capacity of the recording medium is used up, recording stops even if you press and hold the shutter button.

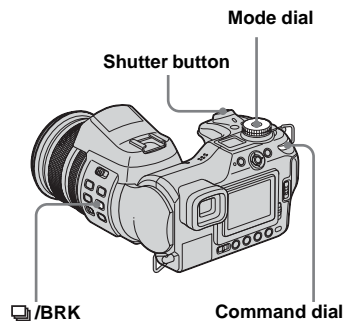

- 1** Set the mode dial to , P, S, A, M or SCN.
- 2** Press and hold /BRK (Burst) and select (Speed Burst) or (Framing Burst) with the command dial.

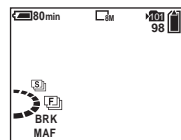

3 Shoot the image.

You can shoot up to seven images when you press and hold the shutter button.

You can do the next shooting after “Recording” disappears from the screen.

To return to normal mode

In Step 2, select [Normal].

- The flash cannot be used.
- When [Mode] (REC Mode) is not set to [Normal], you cannot use the Burst mode.
- You may not be able to use the Burst mode depending on the Scene Selection mode (page 37).
- When using the self-timer, pressing the shutter button records up to seven images in succession.
- You cannot select shutter speeds of 1/25 second or slower.

Shooting in Multi Burst mode

– Multi Burst

Mode dial: /P/S/A/M/SCN

Pressing the shutter button once records 16 frames in a row. This is convenient for checking your form in sports, for example.

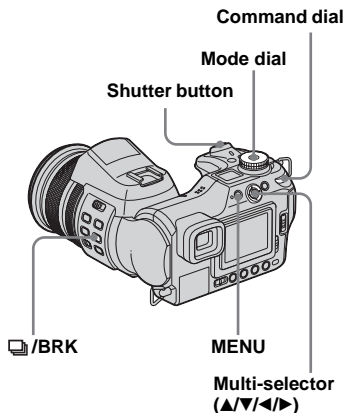

- 1 Set the mode dial to , P, S, A, M or SCN.

- 2 Press and hold /BRK (Burst) and select (Multi Burst) with the command dial.

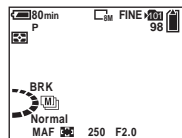

- 3 Press MENU.

The menu appears.

- 4 Select (Interval) with ◀/▶, then select the desired between-frame interval with ▲/▼.

You can choose from [1/7.5], [1/15], [1/30].

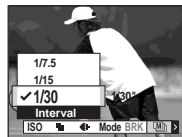

- 5 Shoot the image.

16 frames in a row will be recorded in a single image (image size: 1M).

- When [Mode] (REC Mode) is not set to [Normal], you cannot use the Multi Burst mode.
- The following functions cannot be used in Multi Burst mode:
 - Smart zoom
 - Shooting with the flash
 - Inserting the date and time
 - NightFraming
- When the mode dial is set to , frame interval is automatically set to [1/30].
- You cannot set the shutter speed to lower than the frame interval time.
- For the number of images that can be recorded, see pages 135, 136.
- When you play back images recorded in Multi Burst mode on the camera, see page 87.

Shooting in the dark

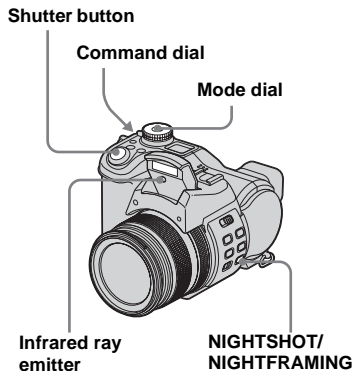

Mode dial:  / P / 



- The infrared ray light covers within approx. 0.5 m to 2.1 m (19 ³/₄ inches to 6 feet 10 ³/₄ inches) (W)/0.6 m to 2.1 m (23 ⁵/₈ inches to 6 feet 10 ³/₄ inches) (T).
- Since the infrared emitter is located below the flash emitter, you have to pop up the flash to shoot in these modes.

NightShot

The NightShot function lets you shoot subjects in dark places without the flash such as camp scenes at night or nocturnal plants and animals. Note that images recorded using the NightShot function become greenish.

- 1 Set the mode dial to , P or .**
- 2 Press and hold NIGHTSHOT/NIGHTFRAMING and select  (Night shot) with the command dial.**

The flash emitter pops up and the  and “Night shot” indicators light for about five seconds.





- 3 Shoot the image.**

To cancel the NightShot function

In Step **2**, select [Off].

- While using the NightShot function:
 - The white balance is set to Auto.
 - The metering mode is set to center weighted.

- If you perform any invalid operation, the  indicator flashes, and the “Night shot” indicator lights for about five seconds.
- While using the NightShot function, you cannot use the following functions:
 - AE LOCK
 - Shooting with hologram AF
 - Shooting with the flash
 - Selecting the color reproduction mode
 - Adjusting the saturation, contrast, and sharpness
- When [Pop-up Flash] is set to [Manual] in the SET UP settings, pop up the flash emitter using the  OPEN (FLASH) switch.
- When attaching the supplied lens hood, infrared ray may be blocked.
- Do not use the NightShot function in bright places (e.g. outdoors in the daytime). This may cause your camera to malfunction.

NightFraming

The NightFraming function enables you to check a subject even at night and then record with natural colors using the flash.

1 Set the mode dial to  or P.

2 Press and hold NIGHTSHOT/ NIGHTFRAMING and select  (Night framing) with the command dial.

The flash emitter pops up and the  and “Night framing” indicators light for about five seconds.

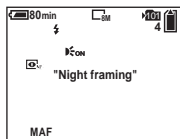

3 Press and hold the shutter button halfway down.



The focus is automatically adjusted.

4 Press the shutter button fully down.

The shutter sounds, the flash strobes and the image is recorded.

To cancel the NightFraming function

In Step **2**, select [Off].

- While using the NightFraming function:
 - The white balance is set to Auto.
 - The metering mode is set to multi-pattern metering.
 - The AF range finder frame is not displayed. The centrally-located subject has priority to focus on.
 - The AE lock cannot be used.
 - If you perform any invalid operation while using the NightFraming function, the  indicator flashes and the “Night framing” indicator lights for about five seconds.
- When [Pop-up Flash] is set to [Manual] in the SET UP settings, pop up the flash emitter using the  OPEN (FLASH) switch.
- When attaching the supplied lens hood, flash light and infrared ray may be blocked.
- When you press the shutter button halfway down, you will hear a sound, but this is not the sound of the shutter releasing. The image is not recorded yet.
- When [Hologram AF] is set to [Off], you may not get a clear focus. Setting [Hologram AF] to [Auto] is recommended (page 35).
- When using the following functions, you cannot use the NightFraming function.
 - Manual focus
 - Exposure Bracket
 - Burst
 - Multi Burst

Shooting with special effects

– Picture Effect

Mode dial: P/S/A/M/SCN/

You can add special effects to bring out the contrast in your images.

Solarize



Like an illustration with clearly delineated bright and dark portions

Sepia



Colored to look like an old photograph

Neg.Art



Made to look like a negative image

Multi-selector (▲/▼/◀/▶) Shutter button

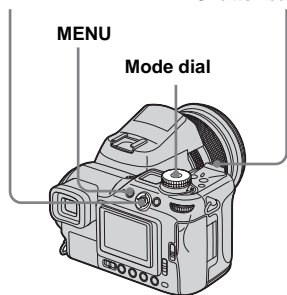

1 Set the mode dial to P, S, A, M, SCN or .

2 Press MENU.

The menu appears.

3 Select [PFX] (P.Effect) with ◀/▶, then select the desired mode with ▲/▼.

4 Shoot the image.

To cancel Picture Effect

In Step **3**, select [Off].

- You cannot select the color reproduction mode when using the picture effect.

Shooting still images in RAW mode

– RAW

Mode dial: P/S/A/M/SCN

Used when you want to record the raw data directly onto the recording medium as it is. The data can be reproduced with much less deterioration in image processing and be displayed using the exclusive software provided. A compressed JPEG format image like that is recorded in normal shooting is recorded at the same time.

Shutter button

Mode dial

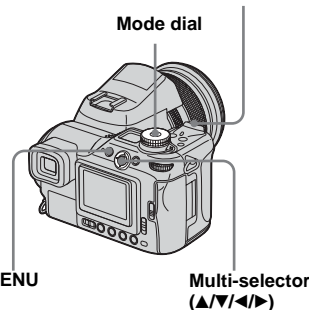

MENU

Multi-selector (▲/▼/◀/▶)

1 Set the mode dial to P, S, A, M or SCN.

2 Press MENU.

The menu appears.

3 Select [Mode] (REC Mode) with $\blacktriangle/\blacktriangleright$, then select [RAW] with \blacktriangle .

4 Shoot the image.

You can do the next shooting after “Recording” disappears from the screen.

To return to normal mode

In Step **3**, select [Normal].

- To reproduce the RAW data file using a computer, the exclusive software is required. Install the exclusive software on the supplied CD-ROM (Image Data Converter) to your computer. Since the RAW data file is a special kind of file, general software cannot open the RAW data file.
- The JPEG image is also recorded in the image size selected by the Image Size setup (page 24). (However, [3:2] cannot be selected.) RAW data images are recorded in [8M] size.
- Writing data takes more time than in normal recording mode.
- Digital zoom cannot be used.
- For the number of images that can be recorded, see pages 134, 136.

Shooting still images in TIFF mode

– TIFF

Mode dial: /P/S/A/M/SCN

Used when you record an image in uncompressed file format. The image quality does not deteriorate. Images recorded in this mode are suitable for fine printing. A compressed JPEG format image like that recorded in normal shooting is recorded at the same time.

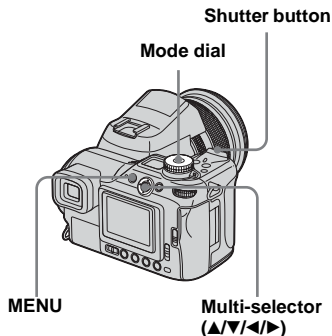

1 Set the mode dial to , P, S, A, M or SCN.

2 Press MENU.

The menu appears.

3 Select [Mode] (REC Mode) with $\blacktriangle/\blacktriangleright$, then select [TIFF] with $\blacktriangle/\blacktriangledown$.

4 Shoot the image.

You can do the next shooting after “Recording” disappears from the screen.

To return to normal mode

In Step **3**, select [Normal].

- JPEG images are also recorded in the image size selected by the Image Size setup (page 24). Uncompressed (TIFF) images are recorded in [8M] size except when [3:2] is selected.
- Writing data takes more time than in normal recording mode.
- For the number of images that can be recorded, see pages 134, 136.

Shooting still images for e-mail

– E-Mail

Mode dial: /P/S/A/M/SCN

You can shoot images and save them in a file that is small enough (320×240) to attach to an e-mail message. The normal mode image that was selected using the Image Size item (page 24) is also recorded.

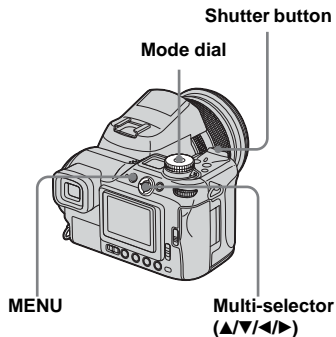

1 Set the mode dial to , P, S, A, M or SCN.

2 Press MENU.

The menu appears.

3 Select [Mode] (REC Mode) with /▶, then select [E-Mail] with ▲/▼.

4 Shoot the image.

You can do the next shooting after “Recording” disappears from the screen.

To return to normal mode

In Step **3**, select [Normal].

- For instructions on how to attach your images to an e-mail message, refer to the Help files of the e-mail software you are using.
- For the number of images that can be recorded, see pages 135, 136.

Shooting still images with audio files

– Voice

Mode dial: /P/S/A/M/SCN

You can record still images with audio files.

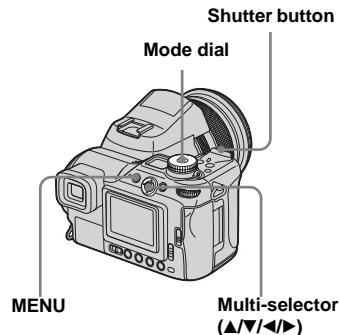

1 Set the mode dial to , P, S, A, M or SCN.

2 Press MENU.

The menu appears.

3 Select [Mode] (REC Mode) with /▶, then select [Voice] with ▲/▼.

4 Shoot the image.

If you press and release the shutter button, sound is recorded for five seconds.

If you hold down the shutter button, sound is recorded until you release the shutter button for up to 40 seconds.

To return to normal mode

In Step **3**, select [Normal].

- To view images recorded in Voice mode, carry out the same procedure described in “Viewing movies on the screen” (page 101).
- Be careful not to touch the microphone (page 12) during shooting.
- For the number of images that can be recorded, see pages 134, 136.

Selecting the folder and playing back images

– Folder

Mode dial: ►

Select the folder that images you want to play back are stored.

Multi-selector (▲/▼/◀/▶)

MENU

Mode dial

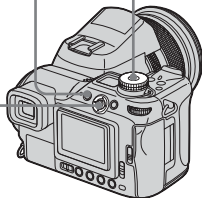

1 Set the mode dial to ►.

2 Press MENU.

The menu appears.

3 Select  (Folder) with ◀, then press the center of the multi-selector.

4 Select the desired folder with

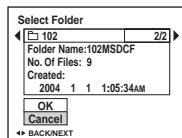

5 Select [OK] with ▲, then press the center of the multi-selector.

To cancel the selection

In Step **5**, select [Cancel].

When multiple folders are created in the recording medium

When the first or last image in the folder is displayed, the following icons are indicated on the screen.



Moves to the previous folder.



Moves to the next folder.



Moves to both the previous and next folders.

On the single screen



On the Index screen



- When no images are stored in the folder, “No file in this folder” appears.
- You can play back images from a last-shot one without selecting the folder.

Enlarging a portion of a still image





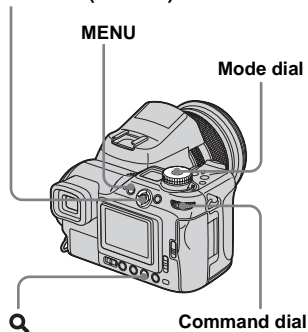

Mode dial:

You can enlarge an image up to five times the size of the original image. You can also record the enlarged image as a new file.

Multi-selector (



Enlarging an image – Playback zoom

- 1** Set the mode dial to .
- 2** Display the image you want to enlarge with .
- 3** Press **Q** (playback zoom).
The image is enlarged twice.
- 4** Select a portion of the image to enlarge with .

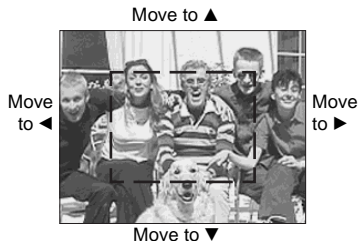

- ▲: To view a portion of the top of the image
- ▼: To view a portion of the bottom of the image
- ◀: To view a portion of the left side of the image
- ▶: To view a portion of the right side of the image

- 5** Adjust the zoom with the command dial.



To cancel enlarged viewing

Press **Q** (playback zoom) again.

- You cannot use Playback zoom with movies or images recorded in Multi Burst mode.
- The images displayed in Quick Review (page 29) can be enlarged using the procedures outlined in Steps **3** to **5**.

Recording an enlarged image – Trimming

- 1** After you have viewed an image using playback zoom, press MENU.
- 2** Select [Trimming] with \blacktriangleright , then press the center of the multi-selector.

The menu appears.

- 3** Select the image size with $\blacktriangle/\blacktriangledown$, then press the center of the multi-selector.

The image is recorded, and the screen image returns to the size it was before enlargement.

- The trimmed image is recorded in the recording folder as the newest file, and the original image is retained.
- The trimmed image may suffer some deterioration in image quality.
- You cannot trim to 3:2-sized image.
- You cannot trim RAW data file/uncompressed (TIFF) images.
- You cannot trim images displayed with Quick Review.

Playing back successive images

– Slide show

Mode dial: \blacktriangleright

You can play back recorded images in succession, one after another. This is useful for checking your images, or for giving a presentation.

Multi-selector ($\blacktriangle/\blacktriangledown/\blacktriangleleft/\blacktriangleright$)

MENU

Mode dial

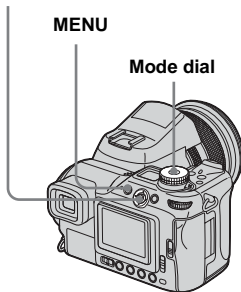

- 1** Set the mode dial to \blacktriangleright .

- 2** Press MENU.

The menu appears.

- 3** Select \blacktriangleright (Slide) with $\blacktriangleleft/\blacktriangleright$, then press the center of the multi-selector.

Set the following items with $\blacktriangle/\blacktriangledown/\blacktriangleleft/\blacktriangleright$.

Interval settings

3 sec/5 sec/10 sec/30 sec/1 min

Image

Folder: Plays back all the images in the selected folder.

All: Plays back all the images in the recording medium.

Repeat

On: Plays the images back repeatedly.

Off: Plays through the images one time and then stops.

- 4** Select [Start] with $\blacktriangledown/\blacktriangleright$, then press the center of the multi-selector.

The slide show begins.

To cancel the slide show setting

In Step **3**, select [Cancel].

To stop slide show playback

Press the center of the multi-selector, select [Exit] with \blacktriangleright , then press the center.

To skip to the next/previous image during slide show

Move the multi-selector to ► (next) or ◀ (previous).

- The interval setting time is approximate, and may vary according to the playback image size.

Rotating still images

– Rotate

Mode dial: ►

Images shot when holding the camera vertically can be rotated and displayed horizontally.



Multi-selector (▲/▼/◀/►)

MENU

Mode dial

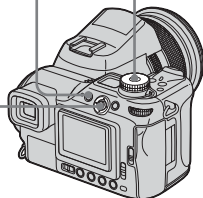

- 1** Set the mode dial to ►, and display the image you want to rotate.
- 2** Press MENU.
The menu appears.
- 3** Select (Rotate) with ◀/►, then press the center of the multi-selector.
- 4** Select with ▲, and rotate the image with ◀/►.
- 5** Select [OK] with ▲/▼, then press the center of the multi-selector.

To cancel the rotation

In Step **4** or **5**, select [Cancel].

- You cannot rotate protected images, movies, Multi Burst mode, RAW data file and uncompressed (TIFF) images.
- You may not be able to rotate images shot with other cameras.
- When viewing images on a computer, the image rotation information may not be reflected depending on the application software.

Playing back images shot in Multi Burst mode

Mode dial:

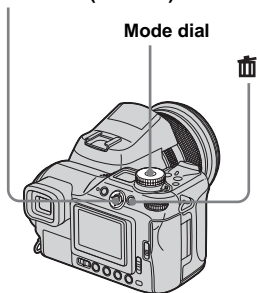

You can play back Multi Burst images continuously or play them back frame by frame. This function is used for checking the images.

Multi-selector ()



- When Multi Burst images are played back on a computer or on a camera without the Multi Burst function, the 16 frames you shot will be displayed at the same time as part of one image.
- You cannot divide the Multi Burst image.

Playing back continuously

- 1** Set the mode dial to .
- 2** Select the Multi Burst image with .



The selected Multi Burst image is played back continuously.



To pause





Press the center of the multi-selector. To resume playback, press the center again. The playback starts from the frame displayed on the screen.

Playing back frame by frame

- 1** Set the mode dial to .
- 2** Select the Multi Burst image with .
- 3** Press the center of the multi-selector when the desired frame is displayed.

“Step” appears.



- 4** Advance the frame with .
- : The next frame is displayed. When you move the multi-selector to  and hold it, the frame advances.
 - : The previous frame is displayed. When you move the multi-selector to  and hold it, the frame advances in the reverse direction.

To return to normal playback

In Step **4**, press the center of the multi-selector. The playback starts from the frame displayed on the screen.



To delete shot images

When using this mode, you cannot delete only certain frames. When you delete images, all 16 of the frames are deleted at the same time.

- 1 Display the Multi Burst image you want to delete.
- 2 Press  (delete).
- 3 Select [Delete], then press the center of the multi-selector.
All of the frames are deleted.

Protecting images

– Protect

Mode dial:



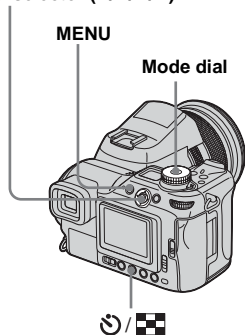

To prevent accidental erasure of an important image, you can protect it.

Multi-selector ()





- Note that formatting the recording medium erases all the data in the recording medium even if images are protected, and these images cannot be recovered.
- It may take some time to protect the images.

On the single screen

- 1** Set the mode dial to .
- 2** Display the image you want to protect with .
- 3** Press MENU.
The menu appears.
- 4** Select  (Protect) with , then press the center of the multi-selector.

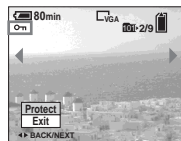
The image currently being displayed is now protected, and the  (Protect) mark is indicated on the screen.









- 5** To protect other images, display the image you want to protect with , then press the center of the multi-selector.

To cancel the protection

In Step **4** or **5**, press the center of the multi-selector again. The  mark disappears.

On the Index screen

- 1** Set the mode dial to , press  (index) to switch to the Index screen.
- 2** Press MENU.
The menu appears.
- 3** Select  (Protect) with , then press the center of the multi-selector.
- 4** Select [Select] with , then press the center of the multi-selector.
- 5** Select the image you want to protect with , then press the center of the multi-selector.
The green  (Protect) mark is indicated on the selected image.



- 6** To protect other images, repeat Step **5**.

7 Press MENU.

8 Select [OK] with ►, then press the center of the multi-selector.

The  mark turns white and the selected image is protected.

To cancel the protection

In Step 4, select [Cancel], or in Step 8, select [Exit].

To release protection

In Step 5, select an image for which you want to release protection with ▲/▼/◀/▶ and press the center of the multi-selector. The  mark turns gray and repeat this operation for all the images for which you want to release protection. Then, press MENU, select [OK], and press the center of the multi-selector.

To protect all the images in the folder

In Step 4, select [All In This Folder], then press the center of the multi-selector. Next, select [On], then press the center.

To release protection of all the images in the folder

In Step 4, select [All In This Folder], and press the center of the multi-selector. Then select [Off], and press the center.

Changing image size

– Resize

Mode dial: 

You can change the image size of a recorded image, and save it as a new file. You can resize to the following sizes. 8M, 5M, 3M, 1M and VGA. The original image is retained even after resizing.

Multi-selector (▲/▼/◀/▶)

MENU

Mode dial

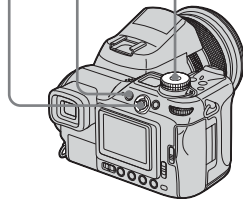

- 1 Set the mode dial to .
- 2 Display the image you want to resize with ◀/▶.
- 3 Press MENU.
The menu appears.

4 Select  (Resize) with **◀/▶**, then press the center of the multi-selector.

5 Select the new size with **▲/▼**, then press the center of the multi-selector.

The resized image is recorded in the recording folder as the newest file.

To cancel the resizing

In Step **5**, select [Cancel].

- You cannot change the size of movies, Multi Burst mode, RAW data file or uncompressed (TIFF) images.
- When images are resized from a smaller to a larger size, the image quality will deteriorate.
- You cannot resize to 3:2-sized image.
- If you resize a 3:2-sized image, black bands will appear at the top and bottom of the image.

Choosing images to print

– Print (DPOF) mark

Mode dial: 

You can designate certain images to be printed.

This function is convenient when you want to print images at a shop or using a printer that conforms with the DPOF (Digital Print Order Format) standard or using PictBridge-compliant printers.

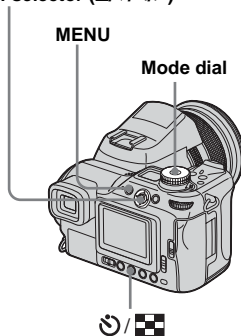

Multi-selector (▲/▼/◀/▶)





- You cannot mark movies or images recorded in RAW mode.

- In E-Mail mode, the print (DPOF) mark is marked on the normal size image that was recorded at the same time.
- When you mark images shot in Multi Burst mode, all the images are printed on one sheet divided into 16 panels.
- If you mark an image shot in TIFF mode with a print (DPOF) mark, only the uncompressed (TIFF) image is printed, and the JPEG image recorded at the same time is not printed.
- You cannot set the number of print sheets.

On the single screen



- 1 Set the mode dial to .
- 2 Display the image you want to print with / .
- 3 Press MENU.

The menu appears.

- 4 Select [DPOF] (DPOF) with / , then press the center of the multi-selector.

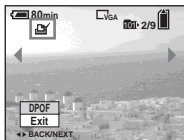
The  mark is indicated on this image.









- 5 To mark other images, display the image you want to mark with / , then press the center of the multi-selector.



To delete the mark

In Step **4** or **5**, press the center of the multi-selector again. The  mark disappears.

On the Index screen

- 1 Set the mode dial to  and press  (index) to switch to the Index screen.
- 2 Press MENU.
The menu appears.
- 3 Select [DPOF] (DPOF) with / , then press the center of the multi-selector.
- 4 Select [Select] with / , then press the center of the multi-selector.

- You cannot mark using the [All In This Folder] option.

- 5 Select the images you want to mark with / / , then press the center of the multi-selector.

The green  mark is indicated on the selected image.







- 6 To mark other images, repeat Step **5** for each of them.

- 7 Press MENU.

- 8 Select [OK] with , then press the center of the multi-selector.

The  mark turns white and the setting is completed.

To delete the mark

In Step **5**, select the image you want to delete the  mark with / / , and press the center of the multi-selector.

To delete all the marks from the images in the folder

In Step **4**, select [All In This Folder], then press the center of the multi-selector. Next, select [Off], then press the center.

To cancel the marking

In Step **4**, select [Cancel], or in Step **8**, select [Exit].

Connecting to a PictBridge printer

Even if you do not have a computer, you can easily print images shot using your camera by connecting the camera to a PictBridge-compliant printer. For preparation, you only need to select the USB connection in the SET UP settings and connect the camera to the printer. Using a PictBridge-compliant printer allows you to easily print the Index prints*.

PictBridge

- * An Index print function may not be provided depending on the printer.
- When printing images, we recommend that you use the AC Adaptor to prevent the camera turning off.

Preparing the camera

Set the USB mode on the camera to connect the camera with a printer.

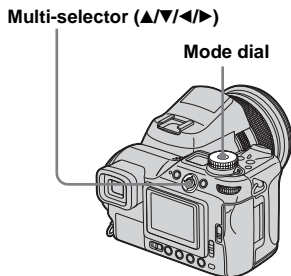

- 1** Set the mode dial to SET UP.
- 2** Select $\frac{2}{2}$ (Setup 2) with ▼, then select [USB Connect] with ▶/▲/▼.
- 3** Select [PictBridge] with ▶/▲, then press the center of the multi-selector.

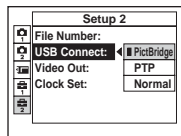

The USB mode is set.

Connecting the camera to the printer

Connect the Ψ (USB) jack on the camera and the USB connector on the printer using a USB cable. The connection can be made regardless of whether the camera is turned on or off.

When the camera is turned on, the camera turns to playback mode regardless of the mode dial position and the newest image in the selected recording folder is displayed on the screen.

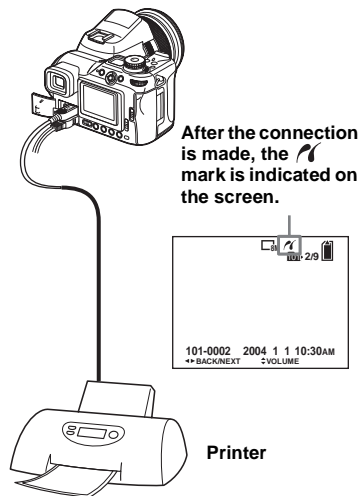

When [USB Connect] is not set to [PictBridge] in the SET UP settings

You cannot use the PictBridge function, even when you turn on the camera. Set [USB Connect] to [PictBridge].

- 1 Press MENU and select [USB Connect], then press the center of the multi-selector.
- 2 Select [PictBridge] with ▲, then press the center.

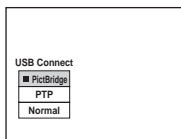

Printing images

You can select an image and print it. Set up the camera following the procedure on page 93, and then connect the printer.

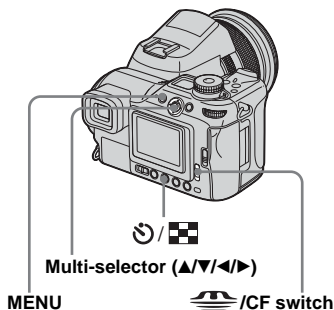

- You cannot print movies and images recorded in RAW mode.
- When printing E-mail mode images or uncompressed (TIFF) images, only their corresponding JPEG files are printed.
- If an error message is sent from the connected printer during the connection, the printer flashes for about five seconds. In such cases, check the printer.
- Note that printing may be canceled if you switch the /CF switch while printing images.

On the single screen

- 1 Select the recording medium with the /CF switch and display the image you want to print with ◀/▶.
- 2 Press MENU.
The menu appears.
- 3 Select  (Print) with ◀/▶, then press the center of the multi-selector.
- 4 Select [This image] with ▲/▼, then press the center of the multi-selector.

The Print screen appears.

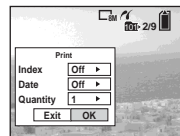

- When using a printer that is not compliant with an index print or a date-insert function, unavailable items are not displayed.

- 5 Select [Quantity] with ▲/▼, select the number of images with ◀/▶.

You can select the number up to 20.

- 6 Select [OK] with ▼/▶, then press the center of the multi-selector.**

The image is printed.

Do not disconnect the USB cable while the  (Not disconnect USB cable) mark is indicated on the screen.



To cancel printing

In Step **4**, select [Cancel] or in Step **6**, select [Exit].

To print other images

After Step **6**, select another image, then select [Print] with ▲.

To print all the images indicated with the mark

In Step **4**, select [DPOF image]. All the images indicated with the  mark are printed in the specified number, regardless of the image displayed.

To insert the date and time on images

In Step **5**, select [Date], then select the date format with ◀/▶. You can select from [Day&Time] or [Date]. When you chose [Date], the date will be inserted in the order set in “Setting the date and time” (page 19). This function may not be provided depending on the printer.

On the Index screen

- 1 Select the recording medium with the  /CF switch and press  (index) to switch to the Index screen.**

The screen turns to the index screen.

- 2 Press MENU.**

The menu appears.

- 3 Select  (Print) with ▶, then press the center of the multi-selector.**

- 4 Select [Select] with ◀/▶, then press the center of the multi-selector.**

- 5 Select the image you want to print with ▲/▼/◀/▶, then press the center of the multi-selector.**

The  mark is indicated on the selected image.



6 To print other images, repeat Step 5.

7 Press MENU.

The Print screen appears.

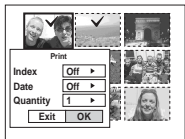

- When using a printer that is not compliant with an index print or a date-insert function, unavailable items are not displayed.

8 Select [Quantity] with ▲/▼, select the number of images with ◀/▶.

You can select the number up to 20. All the images selected are printed in the specified number.

9 Select [OK] with ▼/▶, then press the center of the multi-selector.

The images are printed. Do not disconnect the USB cable while the  mark is indicated on the screen.

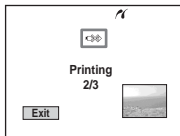

To cancel printing

In Step 4, select [Cancel] or in Step 9, select [Exit].

To print all the images indicated with the  mark

In Step 4, select [DPOF image]. All the images indicated with the  mark are printed in the specified number, regardless of the image displayed.

To print all the images in the folder

In Step 4, select [All In This Folder], then press the center of the multi-selector.

To insert the date and time on images

In Step 8, select [Date], then select the date format with ◀/▶. You can select from [Day&Time] or [Date]. When you chose [Date], the date will be inserted in the order set in “Setting the date and time” (page 19). This function may not be provided depending on the printer.



Printing index-images

You can print some images side-by-side. We refer to this function as an index print*. You can lay single images side-by-side in a specified number and print them, or lay different images side-by-side to make a set by combining multiple different images and print the set in the specified number of copies.



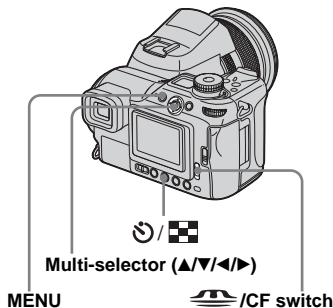





Set up the camera following the procedure on page 93, and connect the printer.

- * An index print function may not be provided depending on a printer.







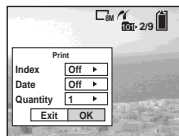

- You cannot print movies and images recorded in RAW mode.
- When printing E-mail mode images or uncompressed (TIFF) images, only their corresponding JPEG files are printed.
- If an error message is sent from the connected printer during the connection,  flashes for about five seconds. In such cases, check the printer.
- Note that printing may be canceled if you switch the /CF switch while printing images.

On the single screen



- 1** Select the recording medium with the /CF switch and display the image you want to print with / .
- 2** Press MENU.
The menu appears.
- 3** Select  (Print) with / , then press the center of the multi-selector.
- 4** Select [This image] with / , then press the center of the multi-selector.
The Print screen appears.



- When using a printer that is not compliant with an index print or a date-insert function, unavailable items are not displayed.
- 5** Select [Index] with  , select [On] with / .

- 6** Select [Quantity] with / , select the number of images laid side-by-side with / .

You can select the number up to 20. You can lay the specified number of images side-by-side.

- 7** Select [OK] with / , then press the center of the multi-selector.

The image is printed. Do not disconnect the USB cable while the  (Not disconnect USB cable) mark is indicated on the screen.

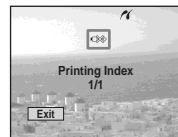

To cancel printing

In Step **4**, select [Cancel] or in Step **7**, select [Exit].



To print other images

After Step **7**, select another image, then select [Print] with  . Then repeat from Step **4**.

To print all the images indicated with the mark

In Step **4**, select [DPOF image]. All the images indicated with the  mark are printed, regardless of the image displayed.

To insert the date and time on images

In Step **6**, select [Date], then select the date format with  . You can select from [Day&Time] or [Date]. When you chose [Date], the date will be inserted in the order set in “Setting the date and time” (page 19). This function may not be provided depending on the printer.



- All the images may not be laid on a sheet depending on the number of images.



On the Index screen





1 Select the recording medium with the /CF switch and press /  (index) to switch to the Index screen.

2 Press MENU.

The menu appears.

3 Select  (Print) with , then press the center of the multi-selector.

4 Select [Select] with  , then press the center of the multi-selector.



5 Select the desired image with    , then press the center of the multi-selector.





The  mark is indicated on the selected image.





6 To print other images, repeat Step **5**.

7 Press MENU.

8 Select [Index] with , then select [On] with  .

9 Select [Quantity] with  , select the number of copies you want to print with  .

You can select the number up to 20.

10 Select [OK] with  , then press the center of the multi-selector.

The images are printed.

Do not disconnect the USB cable while the  mark is indicated on the screen.

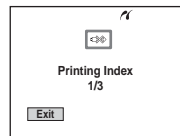

To cancel printing

In Step **4**, select [Cancel] or in Step **10**, select [Exit].



To print all the images indicated with the mark

In Step **4**, select [DPOF image]. All the images indicated with the  mark are printed, regardless of the image displayed.

To print all the images in the folder

In Step **4**, select [All In This Folder], then press the center of the multi-selector.

To insert the date and time on images

In Step **9**, select [Date], then select the date format with /. You can select from [Day&Time] or [Date]. When you chose [Date], the date will be inserted in the order set in “Setting the date and time” (page 19). This function may not be provided depending on the printer.

Shooting movies

Mode dial:

You can shoot movies with audio.

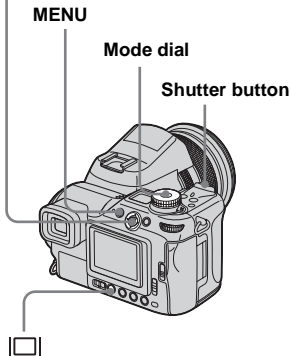

Multi-selector ()



1 Set the mode dial to .

2 Press MENU.

The menu appears.

3 Select  (Image Size) with , then select the desired size with .

You can choose from [640 (Fine)], [640 (Standard)], or [160].

- The [640 (Fine)] image size can be used only when you record the image into the “Memory Stick PRO” or Microdrive.

4 Press the shutter button fully down.

“REC” appears on the screen and the camera starts recording the image and sound.



- When the capacity of the recording medium is used up, recording stops.

5 Press the shutter button fully down again to stop recording.

Indicators on the screen while you are shooting movies

These indicators are not recorded.

Each time you press  (screen status), the status of the screen changes as follows:

Indicators off → Indicators on.

A histogram is not displayed.

See page 152 for a detailed description of the indicated items.

To shoot close-ups (Macro)

Set the mode dial to  and follow the procedure on page 33.

To shoot with a self-timer

Set the mode dial to  and follow the procedure on page 34.

- Be careful not to touch the microphone (page 12) during shooting.
- The following functions cannot be used.
 - Digital zoom
 - Shooting with the flash
 - Inserting date and time
- When you select [640 (Fine)] with the supplied A/V connecting cable plugged in the A/V OUT (MONO) jack, you cannot check the shooting image using the screen. The screen turns blue.
- See pages 135, 136 for the recording time allowed for each image size.

Viewing movies on the screen

Mode dial:

You can view movies on the screen of the camera and hear sounds from the speaker of the camera.

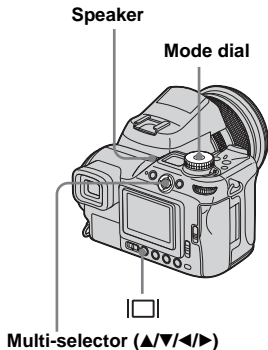

1 Set the mode dial to .

2 Select the desired movie with .

Movies with the image size [640 (Fine)] or [640 (Standard)] are displayed on the full screen.

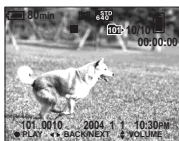

Movies with the image size [160] are displayed a size smaller than still images.

3 Press the center of the multi-selector.

The movie images and sound are played back.

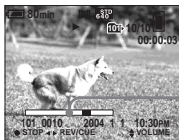

 (playback) appears on the screen while a movie is playing back.





To stop playback

Press the center of the multi-selector again.

To adjust the volume

Adjust the volume with  / .

To fast-forward / rewind

Move the multi-selector to  (next) or  (previous) while playing back a movie.

To return to normal playback, press the center of the multi-selector.

Indicators on the screen while you are viewing movies

Each time you press  (screen status), the status of the screen changes as follows:

Indicators off → Indicators on.

A histogram is not displayed.

See page 154 for a detailed description of the indicated items.

- The procedure for viewing movies on a TV is the same as that for viewing still images (page 41).
- A movie recorded using other Sony devices may be displayed a size smaller than still images.

Deleting movies



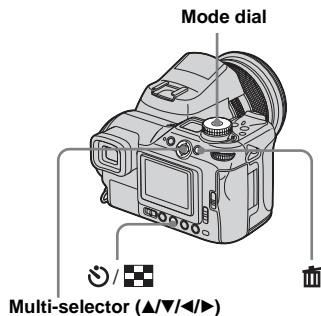

Mode dial: 

You can delete unwanted movies.



- You cannot delete the protected movies.
- Note that the movies once deleted cannot be recovered.





On the single screen

- 1** Set the mode dial to .
- 2** Select the movie you want to delete with .
- 3** Press  (delete).
The movie has not yet been deleted at this point.
- 4** Select [Delete] with , then press the center of the multi-selector.
“Access” appears on the screen and the movie is deleted.
- 5** To delete other movies, display the movie you want to delete with , then repeat Step **4**.

To cancel the deletion

In Step **4** or **5**, select [Exit].

On the Index screen

- 1** Set the mode dial to  and press  (index) button to switch to the Index screen.
- 2** Press  (delete).
- 3** Select [Select] with , then press the center of the multi-selector.
- 4** Select the movies you want to delete with /▼/◀/▶, then press the center of the multi-selector.

The  (delete) mark is indicated on the selected movie.



The movie has not yet been deleted at this point.

- 5** Repeat Step **4** to delete other movies.
- 6** Press  (delete).

7 Select [OK] with **▶**, then press the center of the multi-selector.

“Access” message appears on the screen and the movie will be deleted.

To cancel the deletion

In Step **3** or **7**, select [Exit].

To delete all the images in the folder

In Step **3**, select [All In This Folder], then press the center of the multi-selector. Next, select [OK], then press the center. To cancel the deletion, select [Cancel] with **◀**, then press the center.

Editing movies

Mode dial: **▶**

You can cut movies, or delete unnecessary portions of movies. This is the recommended mode to use when the recording medium capacity is insufficient, or when you attach movies to your e-mail messages.

The file numbers assigned when movies are cut

The cut movies are assigned new numbers and recorded as the newest files in the recording folder. The original movie is deleted and its file number is skipped.

<Example> Cutting the movie numbered 101_0002

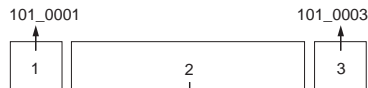

1. Cutting scene A.

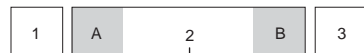

Divide point

2. Cutting scene B.

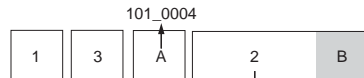

Divide point

3. Deleting scenes A and B if they are unnecessary.

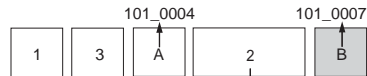

Delete

Delete

4. Only the desired scenes remain.



101_0006

Cutting movies

Multi-selector (▲/▼/◀/▶)

MENU

Mode dial

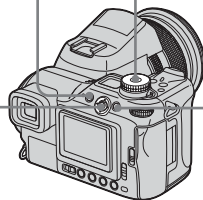

1 Set the mode dial to .

2 Select the movie you want to cut with ◀/▶.

3 Press MENU.

The menu appears.

4 Select  (Divide) with ▶, then press the center of the multi-selector. Next, select [OK] with ▲, then press the center.

The playback of the movie starts.

5 Decide on a cutting point.

Press the center of the multi-selector at the desired cutting point.

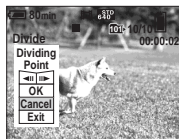

When you want to adjust the cutting point, select [◀/▶] (frame forward/rewind) and adjust the cutting point with ◀/▶. If you want to change the cutting point, select [Cancel]. The playback of the movie starts again.

6 When you have decided on a cutting point, select [OK] with ▲/▼, and press the center of the multi-selector.

7 Select [OK] with ▲, then press the center of the multi-selector.

The movie is cut.

To cancel cutting

In Step **5** or **7**, select [Exit]. The movie appears on the screen again.

- You cannot cut the following images.
 - Still images
 - Movies not long enough to cut
 - Protected movies
- You cannot restore movies once you cut them.
- The original movie is deleted when you cut it.
- The cut movie is recorded in the selected recording folder as the newest file.

Deleting unnecessary portions of movies

1 Cut an unnecessary portion of a movie.

2 Display the portion of the movie you want to delete.

3 Press  (delete).

The movie has not yet been deleted at this point.

4 Select [Delete] with ▲, then press the center of the multi-selector.

The movie currently displayed on the screen is deleted.

Copying images to your computer

– For Windows users

Recommended computer environment

OS: Microsoft Windows 98, Windows 98SE, Windows 2000 Professional, Windows Millennium Edition, Windows XP Home Edition, or Windows XP Professional

The above OS must be installed at the factory. Operation is not assured in an environment upgraded to the operating systems described above or in a multi-boot environment.

CPU: MMX Pentium 200 MHz or faster

USB connector: Provided as standard

Display: 800 × 600 dots or more High Color (16-bit color, 65000 colors) or more

- This camera is compliant with USB 2.0.
- Use with a USB 2.0 (High-Speed USB) compatible computer environment allows high-speed data transfer.
- If you connect two or more USB equipment to a single computer at the same time, some equipment, including your camera, may not operate depending on the type of USB equipment.

- Operations are not guaranteed when using a USB hub.
- Operations are not guaranteed for all the recommended computer environments mentioned above.

USB mode

There are two modes for a USB connection when connecting with a computer, [Normal] and [PTP]* modes. The default setting is the [Normal] mode.

* Compatible only with Windows XP. When connected to a computer, only the data in the folder selected by the camera is copied to the computer. To select the folder, follow the procedure on page 83.

Communication with your computer

When your computer resumes from the suspend or sleep mode, communication between your camera and your computer may not recover at the same time.

When a USB connector is not provided on your computer

When neither a USB connector nor a recording medium slot is provided, you can copy images using an additional device. See the Sony Website for details.

<http://www.sony.net/>

Contents of the CD-ROM

■ USB Driver

This driver is needed in order to connect the camera to a computer.

When using Windows XP, you need not install the USB driver.

■ Image Transfer

This application is used to easily transfer images from the camera to a computer.

■ ImageMixer

This application is used to display and edit images that are stored in a computer.

- The required operations may differ depending on your OS.
- **Close down all applications running on the computer before installing the USB driver and application.**
- When using Windows XP or Windows 2000, log on as Administrators.
- The display settings should be 800 × 600 dots or more and High Color (16-bit color, 65000 colors) or more. When set to less than 800 × 600 dots or 256 colors or less, the install title screen does not appear.



Installing the USB driver

When using Windows XP, you need not install the USB driver.

Once the USB driver is installed, you need not install the USB driver.

- 1 Turn on your computer, and insert the supplied CD-ROM into the CD-ROM drive.

Do not connect your camera to your computer at this time.

The model selection screen appears. If it does not appear, double-click  (My Computer) →  (ImageMixer) in that order.

- 2 Click [Cyber-shot] on the model selection screen.



The installation menu screen appears.

- 3 Click [USB Driver] on the title screen.



The “InstallShield Wizard” screen appears.

- 4 Click [Next]. When the “Information” screen appears, click [Next].



The USB driver installation starts. When the installation is completed, the screen informs you of completion.

- 5 Click [Yes, I want to restart my computer now], then click [Finish].

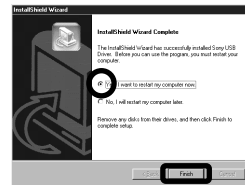

Your computer restarts. Then, you can establish USB connection.

Installing “Image Transfer”

You can use the “Image Transfer” software to copy images to your computer automatically when you connect the camera to your computer.

- 1** Click [Cyber-shot] on the model selection screen.



The installation menu screen appears.

- 2** Click [Image Transfer] on the installation menu screen. Select the desired language, then click [OK].



The “Welcome to the InstallShield Wizard for Image Transfer” screen appears.

- This section describes the English screen.

- 3** Click [Next]. When “License Agreement” screen appears, click [Yes].

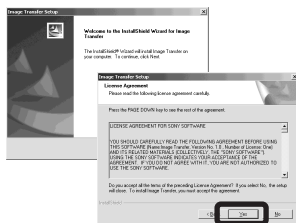

Read the agreement carefully. If you accept the terms of the agreement, proceed with the installation. The “Information” screen appears.

- 4** Click [Next].

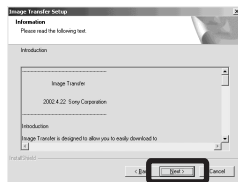

- 5** Select the folder to be installed, then click [Next]. Select the program folder, then click [Next].

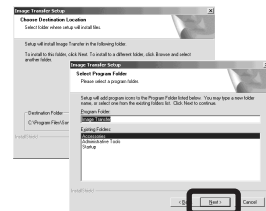

- 6** Confirm if the checkbox is checked on the “Image Transfer Settings” screen, then click [Next].



When the installation is completed, the screen informs you of completion.

7 Click [Finish].

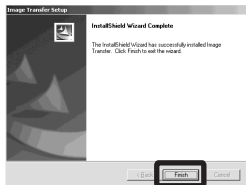

The “InstallShield Wizard” screen closes.

If you wish to continue with the installation of “ImageMixer,” click [ImageMixer] on the installation menu screen and then follow the procedure.

- The USB driver is needed in order to use “Image Transfer.” If the necessary driver is not already installed on your computer, a screen that asks if you want to install the driver will appear. Follow the instructions that appear on the screen.

Installing “ImageMixer”

You can use the “ImageMixer Ver. 1.5 for Sony” software to copy, view and edit images, and create video CDs. For details, see the software’s help files.

- 1 Click [ImageMixer] on the installation menu screen. Select the desired language, then click [OK].



The “Welcome to the InstallShield Wizard” screen appears.

- This section describes the English screen.

- 2 Follow instructions on each succeeding screen.

Install “ImageMixer” according to the screen.

- When you use Windows 2000 or Windows XP, install “WinASPL.”

- If DirectX8.0a or a later version is not installed in your computer, the “Information” screen appears. Follow the procedure on the screen.

- 3 Restart your computer according to the screen.

- 4 Remove the CD-ROM.

Connecting the camera to your computer

- 1** Insert the recording medium with the images you want to copy into the camera. Connect the supplied AC Adaptor, and plug the adaptor into a wall outlet (wall socket).

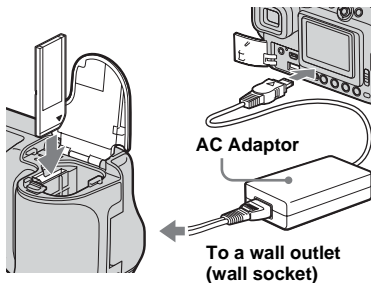

- Select the recording medium with the  /CF switch (page 21).
- When you copy images to your computer using the battery pack, copying may be failed or cause data corruption by battery shutoff. We recommend that you use the AC Adaptor.

- 2** Turn on your computer and the camera.

- 3** Connect the supplied USB cable to the  (USB) jack of the camera.

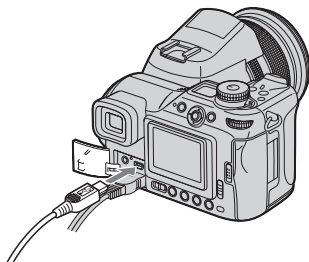

- 4** Connect the USB cable to your computer.

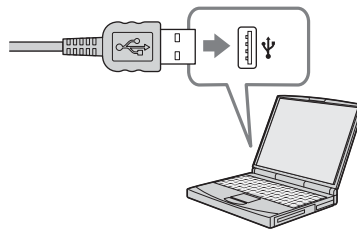

- When using a desktop computer, connect the USB cable to the USB connector on the rear panel.
- When using Windows XP, the AutoPlay wizard automatically appears on the desktop. Proceed to page 112.

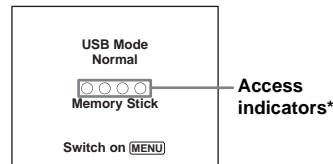

“USB Mode Normal” appears on the screen of the camera. When a USB connection is established for the first time, your computer automatically runs the used program to recognize the camera. Wait for a while.

- * During communication, the access indicators turn red.
- If “USB Mode Normal” does not appear in Step **4**, press MENU, select [USB Connect], and set it to [Normal].
- When using a Microdrive/CF card, opening the CF card cover cancels the USB connection. Do not open the CF card cover during the USB connection.

❗ Disconnecting the USB cable, removing the recording medium, or turning off the camera during a USB connection

For Windows 2000, Me, or XP users

- 1 Double-click  on the tasktray.



Double-click here

- 2 Click  (Sony DSC), then click [Stop].
- 3 Confirm the device on the confirmation window, then click [OK].
- 4 Click [OK].
Step 4 is unnecessary for Windows XP users.
- 5 Disconnect the USB cable, remove the recording medium, or turn off the camera.

For Windows 98 or 98SE users

Confirm that the access indicators (page 109) on the screen are turned white and carry out only Step 5 above.

Copying images using “Image Transfer”

– Windows 98/98SE/2000/Me

Connect the camera and your computer with the USB cable.

“Image Transfer” launches and the images are automatically copied to the computer. When copying is complete, “ImageMixer” automatically launches and images appear.

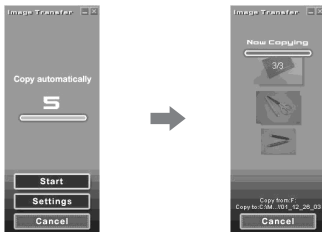

- Normally “Image Transfer” and “Date” folders are created inside the “My Documents” folder, and all of the image files recorded with the camera are copied into these folders.
- You can change the “Image Transfer” settings (page 111).

– Windows XP

Connect the camera and your computer with the USB cable.

“Image Transfer” starts up automatically and the images are automatically copied to the computer.

Windows XP is set so that the OS AutoPlay Wizard activates.

If you want to cancel the setting, follow the procedure below.

- 1 Click [Start], then click [My Computer].
- 2 Right-click [Sony MemoryStick], then click [Properties].
- 3 Cancel the setting.

- ① Click [AutoPlay].
- ② Set [Content type] to [Pictures].
- ③ Check [Select an action to perform] under [Actions], select [Take no action], then click [Apply].
- ④ Set [Content type] to [Video files] and proceed Step ③. Set [Content type] to [Mixed content] and proceed Step ③.
- ⑤ Click [OK].
The [Properties] screen closes.

The OS AutoPlay Wizard does not start up automatically even if the USB connection is made next time.

Changing “Image Transfer” settings

You can change “Image Transfer” settings. Right-click the “Image Transfer” icon on the tasktray, select [Open Settings]. The settings you can set are as follows: [Basic], [Copy], and [Delete].



Right-click here

When the “Image Transfer” starts, the below window appears.



When you select [Settings] from the above window, you can only change the [Basic] setting.

Copying images without using “Image Transfer”

– Windows 98/98SE/2000/Me

If you do not set to launch “Image Transfer” automatically, you can copy images as following procedure.

1 Double-click [My Computer], then double-click [Removable Disk].

The contents of the recording medium inserted in your camera appear.

- This section describes an example of copying images to the “My Documents” folder.
- When the “Removable Disk” icon is not shown, see page 112.
- When using Windows XP, see page 112.

2 Double-click [DCIM], then double-click the folder that the image files you want to copy are stored.

3 Right-click the image file to display the menu, then select [Copy] from the menu.

4 Double-click the “My Documents” folder and right-click on the “My Documents” window to display the menu, then select [Paste] from the menu.

The image files are copied to the “My Documents” folder.

When an image with the same file name exists in the copy destination folder

The overwrite confirmation message appears. When you overwrite the existing image with the new one, the original file data is deleted.

To change the file name

To copy an image file to the computer without overwriting, change the file name to the desired name. However, note that if you change the file name, you may not be able to play back that image with your camera. To play back images with the camera, perform the operation on page 116.

When a removable disk icon is not shown

- 1 Right-click [My Computer] to display the menu, then click [Properties].
The “System Properties” screen appears.
- 2 Display [Device Manager].
 - ① Click [Hardware].
 - ② Click [Device Manager].
 - For Windows 98, 98SE, Me users, Step ① is unnecessary. Click the [Device Manager] tab.
- 3 If [Sony DSC] is displayed, delete it.
 - ① Right-click [Sony DSC].
 - ② Click [Uninstall].
The “Confirm Device Removal” screen appears.
 - For Windows 98, 98SE, Me users, click [Remove].
 - ③ Click [OK].
The device is deleted.

Try the USB driver installation again using the supplied CD-ROM (page 106).

– Windows XP

Copying images using the Windows XP AutoPlay wizard

- 1 **Make a USB connection (page 109). Click [Copy pictures to a folder on my computer using Microsoft Scanner and Camera Wizard], then click [OK].**

The “Scanner and Camera Wizard” screen appears.

- 2 **Click [Next].**

The images stored on the recording medium are displayed.

- 3 **Click the checkbox of images that you do not want to copy to your computer to remove the checkmark, then click [Next].**

The “Picture Name and Destination” screen appears.

- 4 **Select a name and destination for your pictures, then click [Next].**

Image copying starts. When the copying is completed, the “Other Options” screen appears.

5 Select [Nothing. I'm finished working with these pictures], then click [Next].

The “Completing the Scanner and Camera Wizard” screen appears.

6 Click [Finish].

The wizard closes.

- To continue copying other images, follow the procedure given under **4** on page 110 to disconnect the USB cable and reconnect it. Then, perform the procedure from Step **1** again.

Viewing the images on your computer

1 Click [Start], then click [My Documents].

The “My Documents” folder contents are displayed.

- This section describes the procedure for viewing copied images in the “My Documents” folder.
- When not using Windows XP, double-click [My Documents] on the desktop.
- You can use the “ImageMixer Ver. 1.5 for Sony” software to view and edit images on your computer. For details, see the software’s help files.

2 Double-click the desired image file.

The image is displayed.

Image file storage destinations and file names

The image files recorded with your camera are grouped as folders in the recording medium.

Example: when viewing folders on Windows XP (when using a “Memory Stick”)

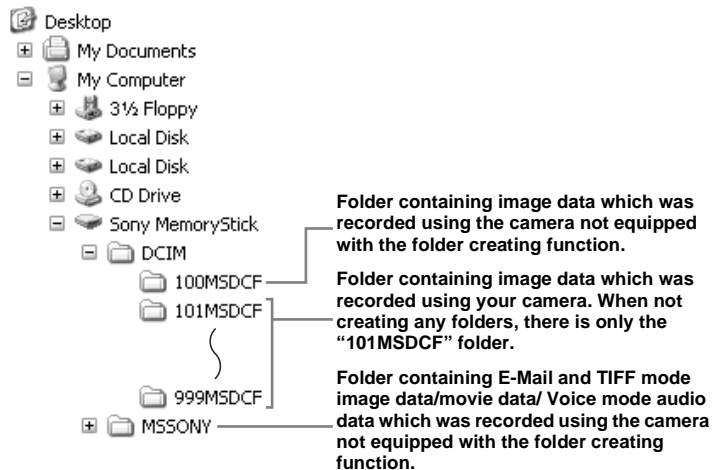

- Even when using a Microdrive/CF card, “Sony MemoryStick” may be displayed, depending on your computer environment.
- You cannot record any images to “100MSDCF” or “MSSONY” folders. The images in these folders are available only for viewing.
- For more information about the folder, see pages 50, 83.

Folder	File name	File meaning
101MSDCF to 999MSDCF	DSC0□□□□.JPG	<ul style="list-style-type: none"> • Still image files shot in <ul style="list-style-type: none"> – Normal mode (page 27) – Exposure Bracket mode (page 63) – Burst mode (page 75) – Multi Burst mode (page 76) • Still image files recorded simultaneously in <ul style="list-style-type: none"> – RAW mode (page 79) – TIFF mode (page 80) – E-Mail mode (page 81) – Voice mode (page 81)
	DSC0□□□□.JPE	• Small-size image files shot in E-Mail mode (page 81)
	DSC0□□□□.MPG	• Audio files shot in Voice mode (page 81)
	DSC0□□□□.TIF	• Uncompressed (TIFF) image file recorded in TIFF mode (page 80)
	DSC0□□□□.SRF	• RAW data file recorded in RAW mode (page 79)
	MOV0□□□□.MPG	• Movie files (page 100)
	MOV0□□□□.THM	• Index image files recorded in movie mode (page 100)

- □□□□ stands for any number within the range from 0001 to 9999.
- The numerical portions of the following files are the same.
 - A RAW data file shot in RAW mode and its corresponding image file
 - An uncompressed image file shot in TIFF mode and its corresponding image file
 - A small-size image file shot in E-Mail mode and its corresponding image file
 - An audio file shot in Voice mode and its corresponding image file
 - A movie file recorded in movie mode and its corresponding index image file
- To view a RAW data file, you have to install exclusive application software from the supplied CD-ROM.

Viewing an image previously copied to a computer

This operation is required for viewing image files that have been copied previously to a computer and already deleted from the recording medium using the camera.

Copy the image files stored on your computer to a recording medium and view them on the camera.

- Skip Step **1** if you have not changed the file name assigned by this camera.
- You may not be able to view the image depending on the image size.
- Images modified with a computer or images shot using other than this camera may not be able to be played back on the camera.
- If the warning message for overwriting the data appears, enter other numbers in Step **1**.
- If there is no folder to store the image file, create a new folder, then copy the image file. For details on how to create the folder, see page 50.

1 Right-click the image file, then click [Rename]. Change the file name to “DSC0□□□□”.

□□□□ stands for any number within the range from 0001 to 9999.

- A file extension may be indicated depending on the setup of the computer. The extension of a still image is “JPG” and that of a movie is “MPG”. Do not change the extension.

2 Copy the image file to a folder on the recording medium.

- ① Right-click the image file, then click [Copy].
- ② Select and double-click the [DCIM] folder from [Removable Disk] or [Sony MemoryStick] in [My Computer].
- ③ Right-click the [□□□MSDCF] folder in the [DCIM] folder, then click [Paste].
□□□ stands for any number within the range from 100 to 999.

Copying images to your computer

– For Macintosh users

Recommended computer environment

OS: Mac OS 9.1, 9.2, or Mac OS X (v10.0/v10.1/v10.2)

The above OS must be installed at the factory.

USB connector: Provided as standard

Display: 800 × 600 dots or more
32000-color mode or more

- If you connect two or more USB equipment to a single computer at the same time, some equipment, including your camera, may not operate depending on the type of USB equipment.
- Operations are not guaranteed when using a USB hub.
- Operations are not guaranteed for all the recommended computer environments mentioned above.

USB mode

There are two modes for a USB connection when connecting with a computer, [Normal] and [PTP]* modes. The default setting is the [Normal] mode.

* Compatible only with Mac OS X. When connected to a computer, only the data in the folder selected by the camera is copied to the

computer. To select the folder, follow the procedure on page 83.

Communication with your computer

When your computer resumes from the suspend or sleep mode, communication between your camera and your computer may not recover at the same time.

When a USB connector is not provided on your computer

When neither a USB connector nor a recording medium slot is provided, you can copy images using an additional device. See the Sony Website for details.

<http://www.sony.net/>

1 Connecting your camera to your computer

For details, see page 109.

Disconnecting the USB cable, removing the recording medium, or turning off the camera during a USB connection

Drag and drop the drive icon or the icon of the recording medium to the “Trash” icon, then remove the USB cable, remove the recording medium, or turn off the camera

- If you are using Mac OS X v10.0, remove the USB cable etc., after you have turned your computer off.

2 Copying images

- 1 Double-click the newly recognized icon on the desktop.

The contents of the recording medium inserted in your camera appear.

- 2 Double-click “DCIM.”
- 3 Double-click the folder that the images you want to copy are stored.
- 4 Drag and drop the image files to the hard disk icon.

The image files are copied to your hard disk.

For details on the storage location of the images and file names, see page 114.

3 Viewing the images on your computer

- 1 Double-click the hard disk icon.
 - 2 Double-click the desired image file in the folder containing the copied files. The image file opens.
- **Close down all applications running on the computer before installing application.**
 - You can use the “ImageMixer Ver. 1.5 for Sony” software to copy images to your computer and to view images on your computer. For details on installing, see operating instructions supplied with the CD-ROM. For details on operation, see the software’s help files.
 - When the image cannot be displayed, increase the virtual memory capacity.
 - “ImageMixer Ver. 1.5 for Sony” cannot be used with Mac OS X.
 - “Image Transfer” cannot be used with Macintosh.

For Mac OS X users

When you click an E-Mail mode image file, “There is no application available to open the document “DSC0□□□□.JPE”.” may be shown. In this case, carry out the following setup. The screen may differ depending on your OS version.

- 1 Click [Choose Application...] on the screen “There is no application available to open the document “DSC0□□□□.JPE”.”
- 2 Change [Recommended Applications] to [All Applications].
- 3 Select [QuickTime Player] from the application list, then click [Open].

Troubleshooting

If you have trouble with your camera, try the following solutions.

- 1 First, check the items on pages 119 to 129. **If the screen shows “C:□□:□□,” the self-diagnosis function is working. Please see page 133.**

- 2 Should your camera still not work properly, press the RESET button located inside the battery/“Memory Stick” cover, then turn on the camera again. (This will clear the date and time settings, etc.)

- 3 Should your camera still not work properly, consult your Sony dealer or local authorized Sony service facility.

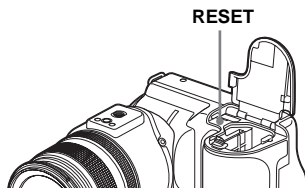







Battery and power







Symptom	Cause	Solution
You cannot charge the battery pack.	<ul style="list-style-type: none">• The camera is turned on.	→ Turn the camera off (page 18).
The battery pack cannot be installed.	<ul style="list-style-type: none">• The battery pack is not installed correctly.	→ Install the battery pack while pushing the battery eject lever down using the front edge of the battery pack (page 14).
The □ on the display window flashes quickly when charging a battery pack.	<ul style="list-style-type: none">• The battery pack is not installed correctly.• The battery pack has malfunctioned.	→ Install the battery pack correctly (page 14). → Consult your Sony dealer or local authorized Sony service facility.
The □ on the display window does not flash when charging a battery pack.	<ul style="list-style-type: none">• The AC Adaptor is disconnected.• The AC Adaptor has malfunctioned.• The battery pack is not installed correctly.• The battery pack is completely charged.	→ Properly connect the AC Adaptor (page 14). → Consult your Sony dealer or local authorized Sony service facility. → Install the battery pack correctly (page 14). —













Symptom	Cause	Solution
The battery remaining indicator is incorrect, or sufficient battery remaining indicator is displayed but the power runs out soon.	<ul style="list-style-type: none"> You have used the camera for a long time in an extremely hot or an extremely cold location. A deviation has occurred in the remaining battery time. The battery pack is discharged. The battery pack is dead (page 147). 	<ul style="list-style-type: none"> → See page 146. → Charge the battery pack after using it completely. The battery remaining indicator displays the correct time (page 15). → Install a charged battery pack (page 14). → Replace the battery pack with a new one.
The battery pack runs down too quickly.	<ul style="list-style-type: none"> You have used the camera in an extremely cold location. The DC plug is dirty so the battery pack is not charged enough. The battery pack is dead (page 147). 	<ul style="list-style-type: none"> → See page 146. → Clean the DC plug with a cotton bud, etc., and charge the battery pack (page 143). → Replace the battery pack with a new one.
You cannot turn on the camera.	<ul style="list-style-type: none"> The battery pack is not installed correctly. The AC Adaptor is disconnected. The AC Adaptor has malfunctioned. The battery pack is discharged. The battery pack is dead (page 147). 	<ul style="list-style-type: none"> → Install the battery pack correctly (page 14). → Properly connect the AC Adaptor (page 17). → Consult your Sony dealer or local authorized Sony service facility. → Install a charged battery pack (page 14). → Replace the battery pack with a new one.
The power turns off suddenly.	<ul style="list-style-type: none"> If you do not operate the camera for about three minutes when using a battery pack, the camera turns off automatically to prevent wearing down the battery (page 18). The battery pack is discharged. 	<ul style="list-style-type: none"> → Turn on the camera again (page 18) or use the AC Adaptor (page 17). → Replace it with a charged battery pack (page 14).

Shooting still images / movies



Symptom	Cause	Solution
The LCD screen is not turned on even when the power is turned on.	<ul style="list-style-type: none"> The FINDER/LCD switch is set to FINDER. 	<ul style="list-style-type: none"> → Set it to LCD (page 29).
The subject is not visible on the finder.	<ul style="list-style-type: none"> The diopter scale is not properly adjusted. 	<ul style="list-style-type: none"> → Adjust the finder adjustment lever (page 29).
The subject is not visible on the screen.	<ul style="list-style-type: none"> The mode dial is not set to , P, S, A, M, SCN or . 	<ul style="list-style-type: none"> → Set it to , P, S, A, M, SCN or  (pages 27 and 100).

Symptom	Cause	Solution
The shooting image is not displayed on the screen during a movie shooting.	<ul style="list-style-type: none"> The image size is set to [640 (Fine)] when the A/V connecting cable is connected to the A/V OUT (MONO) jack. 	<ul style="list-style-type: none"> → Disconnect the A/V connecting cable. → Set the image size to any setting other than [640 (Fine)].
The image is out of focus.	<ul style="list-style-type: none"> The subject is too close.  (Twilight mode) or  (Landscape mode) is selected for the Scene Selection function. Manual focus mode is selected. 	<ul style="list-style-type: none"> → Set the macro recording mode. Make sure to place the lens farther away from the subject than the shortest shooting distance when shooting (page 33). → Set it to other modes (page 37). → Set the FOCUS switch to AUTO (page 67).
Precision digital zoom does not function.	<ul style="list-style-type: none"> [Digital Zoom] is set to [Smart] in the SET UP settings. You are shooting in RAW mode. 	<ul style="list-style-type: none"> → Set [Digital Zoom] to [Precision] (pages 30, 48, 140). → The precision digital zoom cannot be used in RAW mode (pages 30, 79).
Smart zoom does not function.	<ul style="list-style-type: none"> [Digital Zoom] is set to [Precision] in the SET UP settings. The image size is set to [8M] or [3:2]. You are shooting in Multi Burst mode. You are shooting in RAW mode. 	<ul style="list-style-type: none"> → Set [Digital Zoom] to [Smart] (pages 30, 48, 140). → Set image size to other settings except [8M] and [3:2] (page 24). → The smart zoom cannot be used in Multi Burst mode (pages 30, 76). → The smart zoom cannot be used in RAW mode (pages 30, 79).
The image is too dark.	<ul style="list-style-type: none"> You are shooting a subject with a light source behind the subject. The brightness of the screen is too low. 	<ul style="list-style-type: none"> → Select the metering mode (page 58). → Adjust the exposure (page 59). → Set the flash mode to  (Forced flash) (page 68). → Adjust the brightness of the screen (pages 48, 141).
The image is too bright.	<ul style="list-style-type: none"> You are shooting a spot lighted subject in a dark location such as on a stage. The brightness of the screen is too high. 	<ul style="list-style-type: none"> → Adjust the exposure (page 59). → Adjust the brightness of the screen (pages 48, 141).
When looking at the screen in a dark place, some noise may show up on the screen.	<ul style="list-style-type: none"> The camera temporarily brightens the screen to allow you to check the image being displayed while you are using the camera in a dark place. 	<ul style="list-style-type: none"> → This will have no effect on the image you shoot.
Vertical streaks appear when you are shooting a very bright subject.	<ul style="list-style-type: none"> The smear phenomenon is occurring. 	<ul style="list-style-type: none"> → This is not a malfunction.

Symptom	Cause	Solution
You cannot shoot images.	<ul style="list-style-type: none"> • No recording medium is inserted. • The capacity of the recording medium is insufficient. • The /CF switch is not set to the proper position. • The write-protect switch on the “Memory Stick” is set to the LOCK position. • The CF card cover is open. • You cannot shoot while the flash is charging. • The mode dial is not set to , P, S, A, M or SCN when you want to shoot a still image. • The mode dial is not set to  when you want to shoot a movie. • The image size is set to [640 (Fine)] when you shoot a movie. 	<ul style="list-style-type: none"> → Insert a recording medium (pages 22, 23). → Delete the images saved in the recording medium (page 43). → Change the recording medium. → Set the switch to the proper position (page 21). → Set it to the recording position (page 144). → Close the CF card cover (page 23). — → Set the mode dial to , P, S, A, M or SCN (page 27). → Set the mode dial to  (page 100). → Use a “Memory Stick PRO” or Microdrive (pages 100, 144). → Set the image size to any position other than [640 (Fine)].
Recording takes a long time.	<ul style="list-style-type: none"> • NR slow shutter function is activated. 	<ul style="list-style-type: none"> → Set to a faster shutter speed than 1/25 second (page 55).
A sound is made when changing between the NightShot and NightFraming modes, or when the shutter button is lightly pressed while NightFraming is set.	<ul style="list-style-type: none"> • The sound is made by the lens in operation. 	<ul style="list-style-type: none"> → This is not a malfunction.
The image colors are not correct.	<ul style="list-style-type: none"> • The NightShot or NightFraming function is set. • Picture effect is activated. 	<ul style="list-style-type: none"> → Cancel the Nightshot/NightFraming functions (pages 77 and 78). → Cancel Picture Effect (page 79).
NightShot or NightFraming does not function.	<ul style="list-style-type: none"> • The mode dial is set to S, A, M or SCN. • Manual focus mode is selected. 	<ul style="list-style-type: none"> → Set it to , P or  (only for NightShot) (pages 77 and 78). → The NightFraming function cannot be used when manual focus mode is selected. Set the FOCUS switch to AUTO (page 67).

Symptom	Cause	Solution
Cannot shoot images with the flash.	<ul style="list-style-type: none"> The mode dial is set to . The flash is set to  (No flash).  (Twilight mode) is selected for the Scene Selection function.  (Landscape mode) is selected for the Scene Selection function. The camera is in Multi Burst, Burst, or Exposure Bracket mode. [Hot Shoe] in the SET UP settings is set to [On]. When [Pop-up Flash] is set to [Manual] in the SET UP settings, you did not pop the flash up using the  OPEN (FLASH) switch. NightShot is activated. 	<ul style="list-style-type: none"> → Set the mode dial to , P, S, A, M or SCN (page 27). → Set the flash to “Auto” (No indicator),  (Forced flash), or  (Slow synchro) (page 68). → Set it to other settings (page 37). → Set the flash to  (Forced flash) (page 37). → Cancel the Multi Burst, Burst, or Exposure Bracket mode. → Set it to [Off] (pages 48 and 140). → Set [Pop-up Flash] to [Auto] in the SET UP settings (pages 48, 140) or pop the flash up using the  OPEN (FLASH) switch (page 69). → Select the NightFraming function or cancel the NightShot function (pages 77 and 78).
The macro mode does not function.	<ul style="list-style-type: none">  (Twilight mode) or  (Landscape mode) is selected for the Scene Selection function. 	<ul style="list-style-type: none"> → Set it to other settings (page 37).
Cannot record in Multi Burst, Burst, or Exposure Bracket mode.	<ul style="list-style-type: none"> [Mode] (REC Mode) is set to other than [Normal]. 	<ul style="list-style-type: none"> → Set it to [Normal].
The eyes of the subject come out red.	—	<ul style="list-style-type: none"> → Set [Red Eye Reduction] to [On] (page 69).
The date and time are recorded incorrectly.	<ul style="list-style-type: none"> The date and time are not set correctly. 	<ul style="list-style-type: none"> → Set the correct date and time (page 19).
The aperture value and shutter speed flash when you press and hold the shutter button halfway down.	<ul style="list-style-type: none"> The exposure is incorrect. 	<ul style="list-style-type: none"> → Adjust the exposure (page 59).

Viewing images

Symptom	Cause	Solution
The image cannot be played back.	<ul style="list-style-type: none"> The mode dial is not set to . You changed the folder/file name on a computer. You cannot play back the image on the camera if you modify the image on a computer. The camera is in USB mode. The CF card cover is open. 	→ Set the mode dial to  (page 39). → See page 116. — → Cancel USB communication (page 110). → Close the CF card cover (page 23).
The image is coarse right after being played back.	<ul style="list-style-type: none"> The image momentarily becomes rough for image processing. 	→ This is not a malfunction.
The images cannot be played back on a TV.	<ul style="list-style-type: none"> The [Video Out] setting for the camera in SET UP is incorrect. The connection is not correct. 	→ Set [Video Out] to [NTSC] or [PAL] (pages 48 and 142). → Check the connection (page 41).
The images cannot be played back on a computer.	—	→ See page 125.

Deleting/editing an image



Symptom	Cause	Solution
Your camera cannot delete an image.	<ul style="list-style-type: none"> The image is protected. The write-protect switch on the “Memory Stick” is set to the LOCK position. 	→ Cancel the protection (page 89). → Set it to the recording position (page 144).
You have deleted the image by mistake.	<ul style="list-style-type: none"> Once you have deleted an image, you cannot restore it. 	→ Protecting the image can prevent accidental erasure (page 89). → The write-protect switch on the “Memory Stick” will prevent you from deleting images by mistake (page 144).
The resizing function does not work.	<ul style="list-style-type: none"> You cannot resize movies, Multi Burst, RAW data files, and uncompressed (TIFF) images. 	—
You cannot attach a print (DPOF) mark.	<ul style="list-style-type: none"> Print (DPOF) marks cannot be attached to movies or images recorded in RAW mode. 	—
You cannot cut a image.	<ul style="list-style-type: none"> The movie is not long enough to cut. Protected movies cannot be cut. Still images cannot be cut. 	— → Cancel the protection (page 89). —

Computers

Symptom	Cause	Solution
You do not know whether or not your OS can be used with the camera.	—	→ Check “Recommended computer environment” (pages 105, 117).
You cannot install the USB driver.	—	→ In Windows 2000, log on as Administrator (authorized Administrators) (page 105).
Your computer does not recognize your camera.	<ul style="list-style-type: none"> • The camera is turned off. • The battery level is too low. • You are not using the supplied USB cable. • The USB cable is not connected securely. • [USB Connect] is not set to [Normal] in the SET UP settings. • The USB connectors on your computer are connected to other equipment besides the keyboard, the mouse. • The camera is not directly connected to your computer. • The USB driver is not installed. • Your computer does not properly recognize the device because you connected the camera and your computer with the USB cable before you installed the “USB Driver” from the supplied CD-ROM. • The CF card cover is open. 	<ul style="list-style-type: none"> → Turn on the camera (page 18). → Use the AC Adaptor (page 17). → Use the supplied USB cable (page 109). → Disconnect the USB cable, and securely connect it again. Make sure that “USB Mode” is displayed on the screen (page 109). → Set it to [Normal] (page 142). → Disconnect the USB cables except for those connected to the keyboard and the mouse. → Directly connect the camera and your computer without using a USB hub. → Install the USB driver (page 106). → Delete the erroneously recognized device from your computer, then install the USB driver (pages 106, 112). → Close the CF card cover (page 23).
You cannot copy images.	<ul style="list-style-type: none"> • The camera is not correctly connected to your computer. • The copy procedure differs depending on your OS. — — 	<ul style="list-style-type: none"> → Connect the camera and your computer correctly (page 109). → Follow the copy procedure for your OS (pages 110, 111, 117). → If you are using the “Image Transfer” software, see page 110. → If you are using the “ImageMixer Ver. 1.5 for Sony” software, click on HELP.



Symptom	Cause	Solution
After making a USB connection, "Image Transfer" does not automatically start.	— —	→ Select [Launch Image Transfer automatically when the camera, etc., is connected.] at [Basic] setting (page 111). → Make a USB connection when the computer is turned on.
The image cannot be played back on a computer.	• You try to play back the image recorded in the RAW mode. — —	→ Install exclusive software from the supplied CD-ROM (page 79). → If you are using the "ImageMixer Ver. 1.5 for Sony" software, click on HELP. → Consult the computer or software manufacturer.
The image and sound are affected by noise when you play back a movie on a computer.	• You are playing back the movie directly from the recording medium.	→ Copy the movie to the hard disk of the computer and then play the movie file back from the hard disk (pages 110, 111, 117).
You cannot print an image.	— —	→ Check the printer settings. → If you are using the "ImageMixer Ver. 1.5 for Sony" software, click on HELP.
The error message appears when loading the supplied CD-ROM.	• The computer display is not set correctly.	→ Set the display mode of your computer as follows: For Windows, 800 × 600 dots or more, high color (16-bit color, 65000 colors) or more. For Macintosh, 800 × 600 dots or more, 32000 colors or more.

"Memory Stick"

Symptom	Cause	Solution
You cannot insert a "Memory Stick."	• You are inserting it backwards.	→ Insert it from the right side (page 22).
You cannot record on a "Memory Stick."	• The write-protect switch on the "Memory Stick" is set to the LOCK position. • The "Memory Stick" is full. • The  /CF switch is set to CF. • When shooting movies, the image size is set to [640 (Fine)].	→ Set it to the recording position (page 144). → Delete unnecessary images (pages 43, 102). → Set the switch to  (page 21). → Use a "Memory Stick PRO" or the Microdrive (pages 100, 144). → Set the image size to any setting other than [640 (Fine)].
You cannot format a "Memory Stick."	• The write-protect switch on the "Memory Stick" is set to the LOCK position.	→ Set it to the recording position (page 144).



Symptom	Cause	Solution
You have formatted a “Memory Stick” by mistake.	<ul style="list-style-type: none"> All the data on the “Memory Stick” are erased by formatting. You cannot restore them. 	→ We recommend that you set the “Memory Stick” write-protect switch to the LOCK position to protect accidental erasure (page 144).

Microdrive/CF card

Symptom	Cause	Solution
You cannot insert a Microdrive/CF card.	<ul style="list-style-type: none"> You try to insert an unusable CF card. You are inserting it backwards. 	— → Insert it from the right side (page 23).
You cannot record on a Microdrive/CF card.	<ul style="list-style-type: none"> The Microdrive/CF card is full. An unusable CF card is inserted. The CF card cover is open. The /CF switch is set to . When shooting movies using a CF card, the image size is set to [640 (Fine)]. 	→ Delete unnecessary images (pages 43, 102). — → Close the CF card cover (page 23). → Set the switch to CF (page 21). → Use a “Memory Stick PRO” or the Microdrive (pages 100, 144). → Set the image size to any setting other than [640 (Fine)].
The Microdrive is heated.	<ul style="list-style-type: none"> You are using the Microdrive for a long time. 	→ This is not a malfunction.
You have formatted a Microdrive/CF card by mistake.	<ul style="list-style-type: none"> All the data on the Microdrive/CF card are erased by formatting. You cannot restore them. 	—

PictBridge-compliant printer

Symptom	Cause	Solution
The connection cannot be established.	<ul style="list-style-type: none"> The printer is not compliant with the PictBridge standard. The printer does not set for the connection with the camera. [USB Connect] is not set to [PictBridge] in the SET UP settings. 	→ Consult with the printer manufacturer. → Check that the printer is turned on and can connect with the camera. → Set it to [PictBridge] (page 142).

Symptom	Cause	Solution
You cannot print images.	<ul style="list-style-type: none"> The camera does not connect to the printer. The printer is not turned on. Movies and images recorded in RAW mode cannot be printed. Images modified with a computer or images shot using other than this camera may not be able to be printed. 	<p>→ Check that the camera and the printer are properly connected using the USB cable.</p> <p>→ Turn on the printer. For further information, refer to the operating instructions supplied with it.</p> <p>—</p> <p>—</p>
Printing is canceled.	<ul style="list-style-type: none"> You disconnected the USB cable before the  (Not disconnect USB cable) mark disappears. You switched the  /CF switch while printing. 	<p>—</p> <p>—</p>
You cannot insert the date or print images in the index mode.	<ul style="list-style-type: none"> The printer does not provide these functions. The date may not be inserted in the index mode depending on the printer. 	<p>→ Consult with the printer manufacturer whether the printer provides these function or not.</p> <p>→ Consult with the printer manufacturer.</p>
“---- -- --”is printed on the date-inserted part.	<ul style="list-style-type: none"> The recording date data is not recorded on the image. 	<p>→ The images that do not have the recording date data cannot be printed with the date inserted. Set [Date] to [Off] and print it.</p>



Others





Symptom	Cause	Solution
The camera does not work, no operations can be performed.	<ul style="list-style-type: none"> You are not using an “InfoLITHIUM” battery pack. The battery level is low or zero (The  indicator appears.). The AC Adaptor is not connected securely. 	<p>→ Use an “InfoLITHIUM” battery pack (page 146).</p> <p>→ Charge the battery pack (page 14).</p> <p>→ Connect it securely to the DC IN jack of the camera and to a wall outlet (wall socket) (page 17).</p>
The power is on, but the camera does not work.	<ul style="list-style-type: none"> The internal system is not working properly. 	<p>→ Remove, and then, after one minute, reinstall the battery pack and turn on the camera. If this does not work, press the RESET button located inside the battery/“Memory Stick” cover with a pointed object, then turn the power on again. (This will clear the date and time settings, etc.)</p>



Symptom	Cause	Solution
You cannot identify the indicator on the screen.	—	→ Check the indicator (pages 149 to 154).
The lens gets fogged.	• Condensation is occurring.	→ Turn off the camera, leave the camera for about an hour and then try to use it again (page 143).
The camera gets hot if you use it for a long time.	—	→ This is not a malfunction.

Warnings and messages

The following messages appear on the screen.

Message	Meaning/ Corrective Action
No Memory Stick	<ul style="list-style-type: none">• Insert a “Memory Stick” (page 22).• Set the /CF switch to CF and record the image using the Microdrive/CF card.
System error	<ul style="list-style-type: none">• Turn the power off and on again (page 18).
Memory Stick error	<ul style="list-style-type: none">• The inserted “Memory Stick” cannot be used with your camera (page 144).• The “Memory Stick” is damaged, or the terminal section of the “Memory Stick” is dirty.• Insert the “Memory Stick” correctly (page 22).
Memory Stick type error	<ul style="list-style-type: none">• The inserted “Memory Stick” cannot be used with your camera (page 144).
Read only memory	<ul style="list-style-type: none">• You cannot record or delete images on the “Memory Stick” with this camera.
Memory Stick locked	<ul style="list-style-type: none">• The write-protect switch on the “Memory Stick” is set to the LOCK position. Set it to the recording position (page 144).
No memory space	<ul style="list-style-type: none">• The capacity of the “Memory Stick” is insufficient. You cannot record images. Delete unnecessary images or data (pages 43, 102).
No CF card	<ul style="list-style-type: none">• Insert the Microdrive/CF card (page 23).• Set the /CF switch to  and record the image using the “Memory Stick.”
CF card error	<ul style="list-style-type: none">• An unusable CF card is inserted (page 145).• The Microdrive/CF card is damaged, or the terminal section of the Microdrive/CF card is dirty.• Insert the Microdrive/CF card correctly (page 23).
CF card type error	<ul style="list-style-type: none">• The inserted CF card cannot be used with your camera (page 21).
CF card locked	<ul style="list-style-type: none">• The Microdrive/CF card is set to be unrecordable. Consult with the Microdrive/CF card manufacturer.
No CF card space	<ul style="list-style-type: none">• The capacity of the Microdrive/CF card is insufficient. You cannot record images. Delete unnecessary images or data (pages 43, 102)
Cover open	<ul style="list-style-type: none">• Close the CF card cover.
Format error	<ul style="list-style-type: none">• The recording medium format failed. Format the recording medium again (page 45).• When using a Memory Stick Duo Adaptor that is compliant with the CompactFlash slot, the write-protect switch on the “Memory Stick Duo” is set to LOCK position. Set it to the recording position.

Message	Meaning/ Corrective Action
For “InfoLITHIUM” battery only	<ul style="list-style-type: none"> The battery pack is not the “InfoLITHIUM” type.
	<ul style="list-style-type: none"> The battery level is low or zero. Charge the battery pack (page 14). Depending on the conditions of use or the type of battery pack, the indicator may flash even though there are still 5 to 10 minutes of remaining battery time left.
Folder error	<ul style="list-style-type: none"> A folder with the same first three digits number already exists on the recording medium. (For example: 123MSDCF and 123ABCDE) Select other folders, or create a new folder.
Cannot create more folders	<ul style="list-style-type: none"> The folder whose first three digits of the name is “999” exists on the recording medium. You cannot create any more folders.
Cannot record	<ul style="list-style-type: none"> You attempted to select the folder that is available only for viewing with your camera. Select other folders (page 51).
	<ul style="list-style-type: none"> The amount of light is not sufficient, or camera shake may occur because a slower shutter speed is set. Use the flash, or mount the camera on a tripod to steady the camera.
“Night shot”	<ul style="list-style-type: none"> An operation that is not valid while NIGHTSHOT is set was attempted.
“Night framing”	<ul style="list-style-type: none"> An operation that is not valid while NIGHTFRAMING is set is attempted.
Manual focus is invalid	<ul style="list-style-type: none"> The FOCUS switch is set to MANUAL when the mode dial is set to .
The flash is not open	<ul style="list-style-type: none"> Pop the flash up using the  OPEN (FLASH) switch (page 69).
640 (Fine) is not available	<ul style="list-style-type: none"> A recording medium that does not correspond to the [640 (Fine)] size movie is inserted (page 100).
Busy	<ul style="list-style-type: none"> When using the Microdrive, the data writing process was not performed due to a drop in data transmission rate.
Buffer over	<ul style="list-style-type: none"> When using the Microdrive, the data writing process was not performed due to a drop in data transmission rate. (This message is indicated after the “Busy” message appeared.)
Read error	<ul style="list-style-type: none"> The movies stored on the Microdrive cannot be played back due to an internal temperature problem or vibration. The file is corrupted.
File error	<ul style="list-style-type: none"> An error occurred while playing back the image.
File protect	<ul style="list-style-type: none"> The image is protected against erasure. Release the protection (page 89).
Image size over	<ul style="list-style-type: none"> You are playing back an image of a size that cannot be played back on your camera.
No file in this folder	<ul style="list-style-type: none"> No images have been recorded in this folder.
Cannot divide	<ul style="list-style-type: none"> The movie is not long enough to be divided. The file is not a movie.
Invalid operation	<ul style="list-style-type: none"> You are playing back a file that was created on equipment other than your camera.

Message	Meaning/ Corrective Action
Enable printer to connect	<ul style="list-style-type: none"> • [USB Connect] is set to [PictBridge], however the camera is connected to a non-PictBridge-compliant device. Check the device. • Depending on the circumstances, the connection may not be established. Disconnect and connect the USB cable again. If an error message is indicated on the printer, refer to the operating instructions supplied with the printer.
Connect to  device	<ul style="list-style-type: none"> • You tried to print images before the printer connection was established.
No printable image	<ul style="list-style-type: none"> • You tried to execute [DPOF image] without checking the  mark. • You tried to execute [All In This Folder] while selecting the folder that stores only movies or images recorded in RAW mode. You cannot print movies or images recorded in RAW mode.
Printer busy	<ul style="list-style-type: none"> • Since the printer is busy, it cannot receive print requests. Check the printer.
Paper error	<ul style="list-style-type: none"> • A paper error occurred, such as paper-out, paper-jam, etc. Check the printer.
Ink error	<ul style="list-style-type: none"> • An ink error occurred. Check the printer.
Printer error	<ul style="list-style-type: none"> • The camera received an error from the printer. Check the printer, or check the image you want to print is corrupted.
	<ul style="list-style-type: none"> • The data transmission to the printer may not be completed yet. Do not disconnect the USB cable.

Self-diagnosis display

-If a code starting with an alphabet letter appears

Your camera has a self-diagnosis display. This function displays the condition of the camera on the screen using a combination of a letter and four numerical digits. If this occurs, check the following code chart and take the corresponding countermeasure. The last two digits (indicated by □□) will differ depending on the state of the camera.

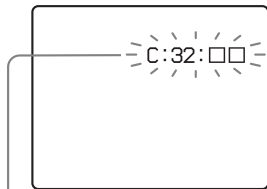

Self-diagnosis display

Code	Cause	Countermeasure
C:32: □□	There is trouble with your camera's hardware.	Turn the power off and on again (page 18).
C:13: □□	The camera cannot read or write data on the recording medium.	Re-insert the recording medium several times.
	An unformatted recording medium is inserted.	Format the recording medium (page 45).
	The inserted recording medium cannot be used with your camera, or the data is damaged.	Insert a new recording medium (pages 21, 22, 23).
E:61: □□ E:91: □□	A camera malfunction that you cannot reverse has occurred.	Press the RESET button (page 119) located inside the battery/"Memory Stick" cover, then turn on the camera again.

If your camera is not still functioning well after trying the countermeasure a couple of times, the camera may need to be repaired. Contact your Sony dealer or local authorized Sony service facility and inform them of the 5-digit code.

The number of images that can be saved/ shooting time

The number of images that can be saved and the shooting time are different, depending on the capacity of the recording medium, the image size, and the image quality. Refer to the following charts when you choose a recording medium.

- The number of images is listed in Fine (Standard) order.
- The values for the number of images that can be saved and the shooting time may vary, depending on the shooting conditions.
- For normal shooting times and numbers of images that can be saved, see pages 25, 26.
- When the remaining number of images recordable is more than 9999, “>9999” is indicated on the screen. And when it is more than 999, “999” is indicated on the display window.

“Memory Stick”

RAW

(Units: images)

	16MB	32MB	64MB	128MB	MSX-256	MSX-512	MSX-1G
8M	0 (0)	1 (1)	3 (3)	6 (6)	10 (11)	22 (24)	45 (49)
3:2	—	—	—	—	—	—	—
5M	0 (0)	1 (1)	3 (3)	6 (6)	11 (12)	23 (25)	48 (51)
3M	0 (0)	1 (1)	3 (3)	6 (7)	12 (12)	25 (26)	51 (53)
1M	0 (0)	1 (1)	3 (3)	7 (7)	12 (13)	26 (26)	53 (54)
VGA	0 (0)	1 (1)	3 (3)	7 (7)	13 (13)	27 (27)	55 (55)

TIFF

(Units: images)

	16MB	32MB	64MB	128MB	MSX-256	MSX-512	MSX-1G
8M	0 (0)	1 (1)	2 (2)	4 (4)	8 (8)	17 (18)	34 (37)
3:2	0 (0)	1 (1)	2 (2)	5 (5)	9 (9)	18 (20)	38 (41)
5M	0 (0)	1 (1)	2 (2)	4 (5)	8 (9)	17 (18)	36 (38)
3M	0 (0)	1 (1)	2 (2)	5 (5)	9 (9)	18 (19)	38 (39)
1M	0 (0)	1 (1)	2 (2)	5 (5)	9 (9)	19 (19)	39 (39)
VGA	0 (0)	1 (1)	2 (2)	5 (5)	9 (9)	19 (19)	40 (40)

Voice*

(Units: images)

	16MB	32MB	64MB	128MB	MSX-256	MSX-512	MSX-1G
8M	3 (7)	8 (14)	16 (29)	32 (58)	58 (106)	119 (216)	242 (442)
3:2	3 (7)	8 (14)	16 (29)	32 (58)	58 (106)	119 (216)	242 (442)
5M	6 (11)	12 (22)	25 (45)	50 (91)	90 (166)	183 (337)	375 (689)
3M	9 (17)	19 (34)	39 (69)	79 (138)	142 (246)	290 (500)	592 (1022)
1M	22 (38)	45 (78)	91 (157)	183 (316)	324 (549)	660 (1117)	1347 (2280)
VGA	69 (121)	140 (245)	281 (492)	564 (987)	1020 (1785)	2074 (3630)	4234 (7410)

* For five-second audio recording

E-mail

(Units: images)

	16MB	32MB	64MB	128MB	MSX-256	MSX-512	MSX-1G
8M	4 (7)	8 (14)	16 (29)	32 (59)	59 (108)	120 (220)	244 (449)
3:2	4 (7)	8 (14)	16 (29)	32 (59)	59 (108)	120 (220)	244 (449)
5M	6 (11)	12 (23)	25 (46)	50 (94)	91 (170)	186 (345)	380 (705)
3M	9 (17)	20 (35)	40 (71)	80 (143)	145 (255)	296 (518)	604 (1058)
1M	23 (42)	47 (85)	96 (171)	192 (343)	340 (595)	691 (1210)	1411 (2470)
VGA	81 (162)	163 (327)	328 (657)	658 (1317)	1190 (2381)	2420 (4841)	4940 (9881)

Multi Burst

(Units: images)

	16MB	32MB	64MB	128MB	MSX-256	MSX-512	MSX-1G
1M	24 (46)	50 (93)	101(187)	202 (376)	357 (649)	726 (1320)	1482 (2694)

Movie

	16MB	32MB	64MB	128MB	MSX-256	MSX-512	MSX-1G
640 (Fine)	—	—	—	—	0:02:57	0:06:02	0:12:20
640 (Standard)	0:00:42	0:01:27	0:02:56	0:05:54	0:10:42	0:21:47	0:44:27
160	0:11:12	0:22:42	0:45:39	1:31:33	2:51:21	5:47:05	11:44:22

The numbers indicate the recording time. For example: “1:31:33” indicates “1 hour, 31 minutes, 33 seconds.”

Microdrive

RAW (Units: images)

1G (DSCM-11000)	
8M	50 (55)
3:2	—
5M	54 (57)
3M	56 (58)
1M	59 (60)
VGA	61 (61)

TIFF (Units: images)

1G (DSCM-11000)	
8M	38 (41)
3:2	42 (45)
5M	40 (42)
3M	42 (43)
1M	43 (44)
VGA	44 (44)

Voice* (Units: images)

1G (DSCM-11000)	
8M	269 (490)
3:2	269 (490)
5M	416 (764)
3M	657 (1133)
1M	1494 (2528)
VGA	4695 (8217)

* For five-second audio recording

E-mail (Units: images)

1G (DSCM-11000)	
8M	271 (498)
3:2	271 (498)
5M	421 (782)
3M	670 (1173)
1M	1565 (2739)
VGA	5478 (10956)

Multi Burst (Units: images)

1G (DSCM-11000)	
1M	1643 (2988)

Movie

1G (DSCM-11000)	
640 (Fine)	0:13:41
640 (Standard)	0:49:13
160	12:42:06

The numbers indicate the recording time. For example: “12:42:06” indicates “12 hours, 42 minutes, 6 seconds.”

- Even when you use a recording medium with a capacity greater than 2 GB, the maximum recordable file size per one continuous shooting is 2 GB.







Menu items

Menu items that can be changed differ depending on the position of the mode dial. The screen shows only the items you can operate based on the current position of the mode dial. Default settings are indicated with ■.









When the mode dial is set to

Item	Setting	Description
 (Image Size)	■ 8M/3:2/5M/3M/1M/VGA	Selects the image size when shooting still images (page 24).
Mode (REC Mode)	RAW TIFF Voice E-Mail ■ Normal	<ul style="list-style-type: none">– Records RAW data file in addition to the JPEG file (page 79).– Records uncompressed (TIFF) file in addition to the JPEG file (page 80).– Records an audio file (with a still image) in addition to the JPEG file (page 81).– Records a small-size (320×240) JPEG file in addition to the selected image size (page 81).– Records an image using the normal recording mode.

When the mode dial is set to P, S, A, M or SCN

Item	Setting	Description
SCN (Scene)	 /  /  / ■ 	Sets the Scene Selection mode (page 37). (This setting can be made only in SCN mode.)
ISO (ISO)	800 / 400 / 200 / 100 / 64 / ■ Auto	Selects the ISO sensitivity. When shooting under dark conditions or shooting a fast-moving subject, use a high-number setting. When recording high-quality images, use a low-number setting (page 64). (This setting cannot be made in SCN mode.)
 (Image Size)	■ 8M/3:2/5M/3M/1M/VGA	Selects the image size when shooting still images (page 24).
 (P.Quality)	■ Fine / Standard	Records images with fine image quality mode. / Records images in the standard image quality mode (page 49).











Item	Setting	Description
Mode (REC Mode)	RAW TIFF Voice E-Mail ■Normal	<ul style="list-style-type: none"> – Records RAW data file in addition to the JPEG file (page 79). – Records uncompressed (TIFF) file in addition to the JPEG file (page 80). – Records an audio file (with a still image) in addition to the JPEG file (page 81). – Records a small-size (320×240) JPEG file in addition to the selected image size (page 81). – Records an image using the normal recording mode.
BRK (Bracket Step)	±1.0EV/■±0.7EV/±0.3EV	Sets the exposure compensation value when recording three images with each exposure value shifted (page 63). (This setting can be made only in Exposure Bracket mode using the  /BRK button.)
 (Interval)	1/7.5 / 1/15 / ■1/30	Selects the Multi Burst between-frame shutter interval (page 76). (This setting can be made only in Multi Burst mode using the  /BRK button.)
± (Flash Level)	High / ■Normal / Low	Selects the amount of flash light (page 70).
PFX (P.Effect)	Solarize / Sepia /Neg.Art / ■Off	Sets the special effects for the image (page 79).
COLOR (Color)	Real/ ■Standard	Selects the color reproduction mode (page 74).
 (Saturation)	+ / ■Normal / –	Adjusts the saturation of the image. The  indicator appears (except when the setting is Normal.) (This setting cannot be made in SCN mode.)
 (Contrast)	+ / ■Normal / –	Adjusts the contrast of the image. The  indicator appears (except when the setting is Normal.) (This setting cannot be made in SCN mode.)
 (Sharpness)	+ / ■Normal / –	Adjusts the sharpness of the image. The  indicator appears (except when the setting is Normal.) (This setting cannot be made in SCN mode.)

When the mode dial is set to

Item	Setting	Description
 (Image Size)	640 (Fine)/ ■ 640 (Standard)/160	Selects the image size when shooting movies (page 100).
PFX (P.Effect)	Solarize / Sepia /Neg.Art / ■Off	Sets the special effects for the image (page 79).

When the mode dial is set to

Item	Setting	Description
 (Folder)	OK/Cancel	Selects the folder that contains the images you want to play back (page 83).
 (Protect)	—	Protects/unprotects images against accidental erasure (page 89).
DPOF (DPOF)	—	Selects still images you want to attach/cancel the print (DPOF) mark (page 91).
 (Print)	—	Prints images using a PictBridge-compliant printer (page 93).
 (Slide)	Interval Image Repeat Start Cancel	<ul style="list-style-type: none"> – Sets the slide show interval (page 85). (For single-image screen only.) <ul style="list-style-type: none"> ■ 3 sec/ 5 sec/ 10 sec/ 30 sec/ 1 min – Selects images from either folder or recording media. <ul style="list-style-type: none"> ■ Folder/All – Repeats the slide show. <ul style="list-style-type: none"> ■ On/Off – Starts the slide show. – Cancels the settings and execution of the slide show.
 (Resize)	8M / 5M / 3M / 1M / VGA / Cancel	Changes the recorded image size (page 90). (For single-image screen only.)
 (Rotate)	 (counter-clockwise) /  (clockwise) / OK / Cancel	Rotates the still image (page 86). (For single-image screen only.)
 (Divide)	OK / Cancel	Divides a movie (page 104). (For single-image screen only.)

SET UP items

Set the mode dial to SET UP. The SET UP screen appears.

Default settings are indicated with **■**.

(Camera 1)

Item	Setting	Description
AF Mode	Single / ■ Monitor / Cont	Selects the focus operation mode (page 66).
Digital Zoom	Smart / ■ Precision	Selects the digital zoom mode (page 30).
Date/Time	Day&Time / Date / ■ Off	Selects whether to insert the date and time into the image (page 36). When shooting movies or images recorded in Multi Burst mode, the date and time cannot be inserted in the image. Also, the date and time will not be displayed when shooting. The date and time will be displayed when the image is played back.
Red Eye Reduction	On / ■ Off	Reduces the red-eye phenomenon when using a flash (page 69).
Hologram AF	■ Auto / Off	Selects whether to emit hologram AF light. Used when it is difficult to focus on the subject in dark conditions (page 35).
Auto Review	On / ■ Off	When shooting still images, selects whether to display the image just after you shoot a still image. Setting this to [On] displays the recorded images for about two seconds. During this time, you cannot shoot the next image.

(Camera 2)

Item	Setting	Description
Expanded Focus	■ On / Off	When focusing manually, the image is enlarged to 2× (page 67).
Hot Shoe	On / ■ Off	Selects whether to use a commercially available external flash (page 72).
Pop-up Flash	■ Auto / Manual	Selects whether to pop up the flash automatically (page 69).

(Memory Stick Tool) (When the /CF switch is set to)

Item	Setting	Description
Format	OK / Cancel	Formats the “Memory Stick.” Note that formatting erases all data on a “Memory Stick,” including even protected images (page 45).
Create REC. Folder	OK / Cancel	Creates a folder for recording images (page 50).
Change REC. Folder	OK / Cancel	Changes a folder for recording images (page 51).

(CF Card Tool) (When the /CF switch is set to CF)

Item	Setting	Description
Format	OK / Cancel	Formats the Microdrive/CF card. Note that formatting erases all data on a Microdrive/CF card, including even protected images (page 45). You cannot format it using the Memory Stick Duo Adaptor that is compliant with the CompactFlash slot (page 145).
Create REC. Folder	OK / Cancel	Creates a folder for recording images (page 50).
Change REC. Folder	OK / Cancel	Changes a folder for recording images (page 51).

(Setup 1)

Item	Setting	Description
LCD Brightness	Bright/ <input type="checkbox"/> Normal/ Dark	Selects the LCD brightness. This has no effect on the recorded images.
LCD Backlight	Bright/ <input type="checkbox"/> Normal	Selects the brightness of the LCD backlight. Selecting [Bright] makes the screen bright and easy to see when using the camera outdoors or in other bright locations, but also uses up the battery charge faster. Displayed only when you are using the camera with the battery pack.
EVF Backlight	Bright/ <input type="checkbox"/> Normal	Selects the brightness of the finder backlight. Selecting [Bright] makes the screen bright and easy to see when using the camera outdoors or in other bright locations, but also uses up the battery charge faster.
Beep	Shutter <input type="checkbox"/> On Off	<ul style="list-style-type: none"> – Turns on the shutter sound when you press the shutter button. – Turns on the beep/shutter sound when you press the center of the multi-selector/the shutter button. – Turns off the beep/shutter sound.



Item	Setting	Description
 Language	—	Displays the menu items, warnings and messages in selected language.

(Setup 2)

Item	Setting	Description
File Number	<input checked="" type="checkbox"/> Series Reset	<ul style="list-style-type: none"> – Assigns numbers to files in sequence even if the recording medium is changed or the recording folder is changed. – Resets the file numbering and starts from 0001 each time the folder is changed. (When the recording folder contains a file, a number one higher than the largest number is assigned.)
USB Connect	PictBridge/PTP/ <input checked="" type="checkbox"/> Normal	Switches the USB mode when connecting with a computer or a PictBridge-compliant printer using the USB cable.
Video Out	NTSC PAL	<ul style="list-style-type: none"> – Sets the video output signal to NTSC mode (e.g., USA, Japan). – Sets the video output signal to PAL mode (e.g., Europe).
Clock Set	OK / Cancel	Sets the date and time (pages 19, 48).

Precautions

Do not leave the camera in the following places

- In extremely hot place, such as in a car parked in the sun. The camera body may become deformed or this may cause a malfunction.
- Under direct sunlight or near a heater. The camera body may become deformed or this may cause a malfunction.
- On rocking vibration
- Near strong magnetic place
- On sandy or in dusty place
Do not let sand get into the camera. Sand or dust may cause the camera to malfunction and sometimes this malfunction cannot be repaired.

Cleaning

Cleaning the LCD screen

Clean the screen surface with an LCD cleaning kit (not supplied) to remove fingerprints, dust, etc.

Cleaning the lens

Wipe the lens with a soft cloth to remove fingerprints, dust, etc.

Cleaning the DC plug

Clean the DC plug of the AC Adaptor with a dry cotton bud. Do not use the dirty plug. Use of the dirty plug may not properly charge the battery pack.

Cleaning the camera surface

Clean the camera surface with a soft cloth slightly moistened with water, then wipe the surface with a dry cloth. Do not pour volatile insecticide on the camera, contact with rubber or vinyl for a long time, or use the following as this may damage the finish or the casing.

- Thinner
- Benzine
- Alcohol
- Disposable cloth

Note on operating temperature

The camera is designed for use within a temperature range of 0°C to 40°C (32°F to 104°F). (When using a Microdrive: 5°C to 40°C (41°F to 104°F)) Shooting in extremely cold or hot locations that exceed this range is not recommended.

On moisture condensation

If the camera is brought directly from a cold to a warm location, or is placed in a very damp room, moisture may condense inside or outside the camera. This moisture condensation may cause a malfunction of the camera.

Moisture condensation occurs easily when:

- The camera is brought from a cold location such as a ski slope into a warmly heated room.
- The camera is taken from an air-conditioned room or car interior to the hot outdoors, etc.

To prevent moisture condensation

When bringing the camera from a cold place to a warm place, seal the camera in a plastic bag and leave it in the new location for about an hour. Remove the plastic bag when the camera has adapted to the new temperature.

If moisture condensation occurs

Turn off the camera and wait about an hour for the moisture to evaporate. Note that if you attempt to shoot with moisture remaining inside the lens, you will be unable to record clear images.

The internal rechargeable button battery

This camera has an internal rechargeable button battery for maintaining the date and time and other settings regardless of whether the power is on or off.

This rechargeable button battery is continually charged as long as you are using the camera. However, if you use the camera for only short periods it discharges gradually, and if you do not use the camera at all for about one month it becomes completely discharged. In this case, be sure to charge this rechargeable button battery before using the camera.

Note that even if this rechargeable button battery is not charged, you can still use the camera as long as you do not record the date and time.

How to charge

Connect the camera to a wall outlet (wall socket) using the AC Adaptor, or install the charged battery pack, and leave the camera for 24 hours or more with the power turned off.

- The rechargeable button battery is located inside the battery/"Memory Stick" cover. Never remove the rechargeable button battery.

The "Memory Stick"

"Memory Stick" is a new compact, portable and versatile IC recording medium with a data capacity that exceeds the capacity of a floppy disk.

The "Memory Stick" that can be used with this camera is as follows. However, we have no guarantee of proper operation.

"Memory Stick"	Recording/playback ⁴⁾
Memory Stick	Yes
Memory Stick Duo ¹⁾	Yes
Memory Stick Duo (MagicGate/higher speed data transmission compatible) ¹⁾	Yes ²⁾³⁾
MagicGate Memory Stick	Yes ²⁾
MagicGate Memory Stick Duo ¹⁾	Yes ²⁾
Memory Stick PRO	Yes ²⁾³⁾
Memory Stick PRO Duo ¹⁾	Yes ²⁾³⁾

¹⁾ When using it with this camera, be sure to insert into the Memory Stick Duo Adaptor.

²⁾ "MagicGate Memory Stick" is equipped with the MagicGate copyright protection technology. MagicGate is copyright protection technology that uses encryption technology. However, because your camera does not support the MagicGate standards, data recorded with your camera is not subject to MagicGate copyright protection.

³⁾ Supports high-speed data transmission using the parallel interface.

⁴⁾ [640 (Fine)] size movies can be recorded or played back only using a "Memory Stick PRO" or Microdrive.

- The "Memory Stick" formatted with a computer is not guaranteed to operate with this camera.
- The data read/write time differs depending on the combination of the "Memory Stick" and a device.

Notes on use of the "Memory Stick"

- You cannot record, edit, or delete images when the write-protect switch is set to LOCK. The position or the shape of the write-protect switch may differ depending on the "Memory Stick" you use.

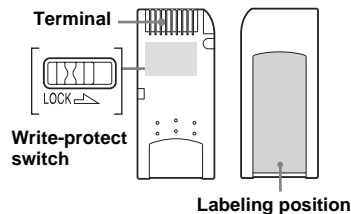

- Do not remove the "Memory Stick" while reading or writing data.
- Data may be damaged in the following cases:
 - Removing the "Memory Stick" or turning off the camera while reading or writing data.
 - Using the camera in a location subject to the effects of static electricity or noise.
- We recommend you back up any important data.
- Do not attach any other material than the supplied label on the labeling position.

- When you attach the supplied label, be sure to attach it to the labeling position. Be careful that the label does not stick out.
- When you carry or store the “Memory Stick,” put it in the case supplied with it.
- Do not touch the terminals of a “Memory Stick” with your hand or a metal object.
- Do not strike, bend or drop a “Memory Stick.”
- Do not disassemble or modify a “Memory Stick.”
- Do not expose the “Memory Stick” to water.
- Avoid using or storing the “Memory Stick” in the following places:
 - In a car parked in the sun, or at a high temperature.
 - Under direct sunlight.
 - In a humid place or near corrosive material.

Notes on use of the “Memory Stick Duo”

- Be sure to insert the “Memory Stick Duo” into the Memory Stick Duo Adaptor when using the “Memory Stick Duo” with the camera. If you insert the “Memory Stick Duo” into the camera without attaching the Memory Stick Duo Adaptor, you may not be able to remove the “Memory Stick Duo.”
- Verify that you are inserting the “Memory Stick Duo” in the proper direction when inserting it into the Memory Stick Duo Adaptor.
- Verify that you are inserting the Memory Stick Duo Adaptor in the proper direction when inserting it into the camera. Inserting it in the wrong direction may cause a malfunction.
- Do not insert a “Memory Stick Duo” that is not inserted into a Memory Stick Duo Adaptor into a “Memory Stick”-compatible unit. This may cause a malfunction of the unit.

- When formatting the “Memory Stick Duo,” insert the “Memory Stick Duo” into the Memory Stick Duo Adaptor and use the “Memory Stick” slot.
- When the “Memory Stick Duo” is equipped with the write protect switch, release its lock.
- You can use the Memory Stick Duo Adaptor that is compliant with the CompactFlash slot, however, you cannot format it using this camera and cannot record [640 (Fine)] movies.

Note on use of the “Memory Stick PRO”

“Memory Stick PRO” with a capacity of up to 1 GB is verified for this camera.

The Microdrive

A Microdrive is a compact and lightweight hard disk drive that complies with Compact Flash TypeII. Camera operations are confirmed using a Microdrive (Hitachi Global Storage Technologies, Inc. DSCM-11000 (1 GB)).

Notes on use of the Microdrive

- Be sure to format the Microdrive using this camera when you use it for the first time.
- The Microdrive is a compact hard disk drive. Since the Microdrive is a rotating disk, the Microdrive is not strong enough to resist vibration and shock compared to a “Memory Stick,” which uses flash memory. Be sure not to transmit vibration or shock to the Microdrive during playback or shooting.
- Data may be damaged in the following cases:
 - Removing the Microdrive while reading or writing data.
 - If you store the Microdrive near corrosive material.
- Note that the use of the Microdrive under 5°C (41°F) may bring performance degradation. Operating temperature range when using the Microdrive: 5° to 40°C (41°F to 104°F)
- Note that the camera cannot be used under low atmospheric pressure (above 3 000 meters above sea-level).
- If the data transmission rate becomes slow in an extremely high or low temperature and writing movie data cannot be done, “Busy” is indicated on the screen and writing data stops (page 131).

- The Microdrive may be hot just after it has been used. Be careful when you handle it.
- Do not write on the label.
- Do not remove the label or attach a new label over the label.
- When you carry or store the Microdrive, put it in the case supplied with it.
- Do not expose the Microdrive to water.
- Do not press on the label strongly.
- Hold the sides of the Microdrive in your hand and do not squeeze the Microdrive.

On “InfoLITHIUM” battery pack



What is the “InfoLITHIUM” battery pack?

The “InfoLITHIUM” battery pack is a lithium-ion battery pack that has functions for communicating information related to operating conditions of your camera.

The “InfoLITHIUM” battery pack calculates the power consumption according to the operating conditions of your camera, and displays the remaining battery time in minutes.

Charging the battery pack

We recommend charging the battery pack in an ambient temperature of between 10°C to 30°C (50°F to 86°F). You may not be able to efficiently charge the battery pack outside of this temperature range.

Effective use of the battery pack

- Battery performance decreases in low-temperature surroundings. So, the time that the battery pack can be used is shorter in cold places. We recommend the following to ensure longer battery pack use:
 - Put the battery pack in a pocket close to your body to warm it up, and insert it in your camera immediately before you start shooting.
- Frequently operating the zoom or flash wears out the battery charge faster.
- We recommend having spare battery packs handy for two or three times the expected shooting time, and making trial shots before taking the actual shots.
- Do not expose the battery pack to water. The battery pack is not water-resistant.

Remaining battery time indicator

The power may go off although the battery remaining indicator shows there is enough power to operate. Use the battery pack up and charge the battery pack fully again so that the indication on the battery remaining indicator is correct. Note, however, that the correct battery indication sometimes will not be restored if the camera is used in high temperatures for a long time or left in a fully charged state, or the battery pack is frequently used.

How to store the battery pack

- If the battery pack is not to be used for a long time, do the following procedure once per year to maintain proper function.

- 1 Fully charge the battery.
- 2 Discharge on your camera.
- 3 Remove the battery from your camera and store it in a dry, cool place.

- To use the battery pack up on your camera, leave the camera to on in slide show playback mode (page 85) until the power goes off.

Battery life

- The battery life is limited. Battery capacity decreases little by little as you use it more and more, and as time passes. When the battery operating time is shortened considerably, a probable cause is that the battery pack has reached the end of its life. Buy a new battery pack.
- The battery life varies according to how it is stored and the operating conditions and environment for each battery pack.

Specifications

■ Camera

[System]

Image device	11 mm (2/3 type) color CCD 4-color filter (RGBE)
Total pixels number of camera	Approx. 8 314 000 pixels
Effective pixels number of camera	Approx. 8 068 000 pixels
Lens	Carl Zeiss Vario-Sonnar T* 7.1× zoom lens f=7.1 to 51 mm (35 mm camera conversion: 28 to 200 mm) F2.0-2.8 Filter diameter: 58 mm (2 ³ / ₈ inches)
Exposure control	Automatic, Shutter speed priority, Aperture priority, Manual exposure, Scene selection (4 modes)
White balance	Automatic, Daylight, Cloudy, Fluorescent, Incandescent, Flash, One-push
File format (DCF compliant)	Still images: Exif Ver. 2.2, JPEG compliant, RAW, TIFF, DPOF compatible Audio with still image: MPEG1 compliant (Monaural) Movies: MPEG1 compliant (Monaural)
Recording medium	“Memory Stick”, Microdrive, CompactFlash card (TypeI/TypeII)

Flash	Recommended distance (when ISO sensitivity is set to Auto) 0.5 to 4.5 m (19 ³ / ₄ inches to 14 feet 9 ¹ / ₄ inches) (W) 0.6 to 3.3 m (23 ⁵ / ₈ inches to 10 feet 10 inches) (T)
Viewfinder	Electric viewfinder (color)

[Output connectors]

A/V OUT (MONO) jack (Monaural)	Minijack Video: 1 Vp-p, 75 Ω, unbalanced, sync negative Audio: 327 mV (at a 47 kΩ load) Output impedance 2.2 kΩ
Accessory jack	Mini-minijack (ø 2.5 mm)
USB jack	mini-B
USB communication	Hi-Speed USB (USB 2.0 High-Speed compliant)

[LCD screen]

LCD panel used	4.6 cm (1.8 type) TFT drive
Total number of dots	134 400 (560×240) dots

[Finder]

LCD panel used	1.1 cm (0.44 type) TFT drive
Total number of dots	235 200 (980×240) dots



[Power, general]

Used battery pack	NP-FM50
Power requirements	7.2 V
Power consumption (during shooting with LCD screen on)	2.2 W
Operating temperature range	0° to +40°C (32° to +104°F) (When using the Microdrive: +5° to +40°C (41° to +104°F))
Storage temperature range	-20° to +60°C (-4° to +140°F)
Dimensions (lens: W-end)	134.4 × 91.1 × 157.2 mm (5 ³ / ₈ × 3 ⁵ / ₈ × 6 ¹ / ₄ inches) (W/H/D, protruding portions not included)
Mass	Approx. 955 g (33.7 oz) (battery pack NP-FM50, "Memory Stick," shoulder strap, lens cap, and so on included)
Microphone	Electret condenser microphone
Speaker	Dynamic speaker
Exif Print	Compatible
PRINT Image Matching II	Compatible
PictBridge	Compatible

■ AC-L15A/L15B AC Adaptor

Power requirements	AC 100 – 240 V, 50/60 Hz
Current consumption	0.35 – 0.18 A
Power consumption	18 W
Output voltage	8.4 V DC, 1.5 A
Operating temperature range	0° to +40°C (32° to +104°F)
Storage temperature range	-20° to +60°C (-4° to +140°F)
Maximum dimensions	Approx. 56 × 31 × 100 mm (2 ¹ / ₄ × 1 ¹ / ₄ × 4 inches) (W/H/D), excluding projecting parts
Mass	Approx. 190 g (6.7 oz) excluding power cord (mains lead)

■ NP-FM50 battery pack

Used battery	Lithium-ion battery
Maximum voltage	DC 8.4 V
Nominal voltage	DC 7.2 V
Capacity	8.5 Wh (1 180 mAh)

Accessories

- AC Adaptor (1)
- Power cord (mains lead) (1)
- USB cable (1)
- Battery pack NP-FM50 (1)
- A/V connecting cable (1)
- Shoulder strap (1)
- Lens cap (1)
- Lens cap strap (1)
- Lens hood (1)
- CD-ROM (USB driver: SPVD-013) (1)
- CD-ROM (Image Data Converter) (1)
- Operating Instructions (1)

Design and specifications are subject to change without notice.

Display window

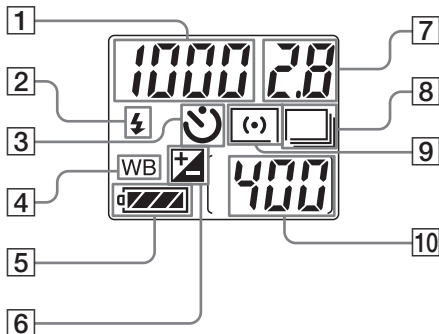

- 1 **Self-diagnosis display** (133)/
Shutter speed indicator (55)/
Available movie recording time indicator (minute) (100)/
Available shooting time indicator (15)/
PLAY indicator
- 2 **Flash mode** (68)
- 3 **Self-timer indicator** (34)
- 4 **White balance indicator*** (73)
- 5 **Battery remaining indicator** (15)

- 6 **EV adjustment indicator*** (59)
- 7 **Aperture value indicator** (56)/
Available movie recording time indicator (second) (100)
- 8 **Burst/Multi Burst/Exposure bracket indicator*** (63, 75, 76)
- 9 **Metering mode indicator** (58)
- 10 **Remaining number of recordable images indicator** (25, 26)

* The selected mode mark or setting value is not displayed on the display window as it is in the LCD screen/finder. Note that the mark on the display window is not changed even when you change the mode or setting value.

The page numbers in parentheses indicate the location of additional important information.

The LCD/finder screen

For shooting still images

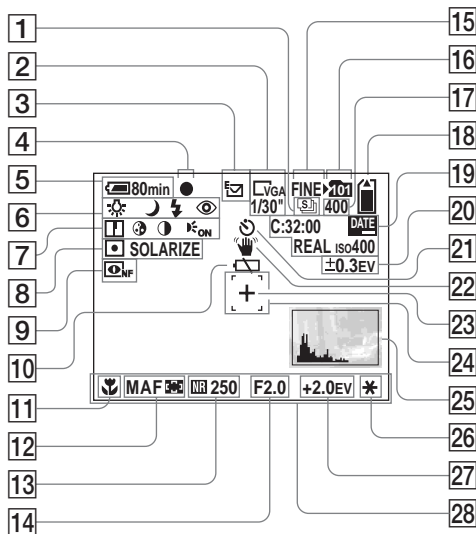

- 1 Burst/Multi Burst indicator (75, 76)
- 2 Image size indicator (24)/ Multi Burst between-frame interval indicator (76)
- 3 Recording mode indicator (79-81)
- 4 AE/AF lock indicator (27)
- 5 Battery remaining indicator (15)
- 6 White balance indicator (73)/ Mode dial indicator/ Scene Selection indicator (37)/ Flash mode (34)/Red-eye reduction (69)
- 7 Sharpness indicator (138)/ Saturation indicator (138)/ Contrast indicator (138)/ Hologram AF indicator (35, 140)
- 8 Metering mode indicator (58)/ Picture effect indicator (79)
- 9 NightShot/NightFraming indicator (77)
- 10 Low battery warning (131)
- 11 Macro (33)
- 12 AF mode (66)/ AF range finder frame indicator (65)/ Focus distance information indicator (67)

- 13 **NR slow shutter indicator** (55)/
Shutter speed indicator (55)
- 14 **Aperture value indicator** (56)
- 15 **Image quality indicator** (49)
- 16 **Recording folder indicator** (50)
- 17 **Remaining number of recordable
images indicator** (25, 26)
- 18 **Remaining recording medium
capacity indicator**
- 19 **Self-diagnosis display** (133)/
Date/time indicator (36)/
Color reproduction indicator
(74)/
ISO sensitivity (64)
- 20 **Bracket step indicator** (63)
- 21 **Self-timer indicator** (34)
- 22 **Vibration warning indicator** (131)
- 23 **Spot metering cross hair** (58)
- 24 **AF range finder frame** (65)
- 25 **Histogram indicator** (60)
- 26 **AE LOCK indicator** (62)
- 27 **EV adjustment indicator** (59)
- 28 **Menu/guide menu** (47)

- Pressing the MENU button switches the menu/
guide menu on/off.

The page numbers in parentheses indicate
the location of additional important
information.

For shooting movies

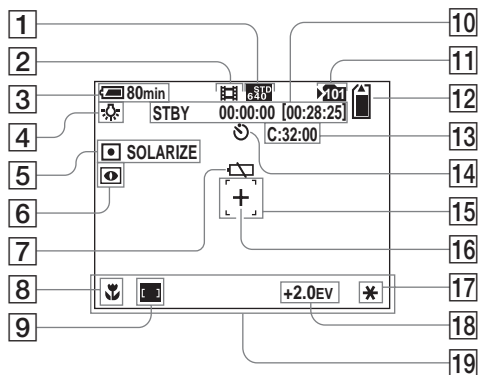

- | | |
|---|---|
| 1 Image size indicator (100) | 12 Remaining recording medium capacity indicator |
| 2 Recording mode indicator (100) | 13 Self-diagnosis display (133) |
| 3 Battery remaining indicator (15) | 14 Self-timer indicator (34) |
| 4 White balance indicator (73) | 15 AF range finder frame (65) |
| 5 Metering mode indicator (58)/
Picture effect indicator (79) | 16 Spot metering cross hair (58) |
| 6 NightShot indicator (77) | 17 AE LOCK indicator (62) |
| 7 Low battery warning (131) | 18 EV adjustment indicator (59) |
| 8 Macro (33) | 19 Menu/guide menu (47) |
| 9 AF range finder frame indicator (65) | |
| 10 Recording time [Maximum recordable time] indicator (100) | |
| 11 Recording folder indicator (50) | |

For still image playback

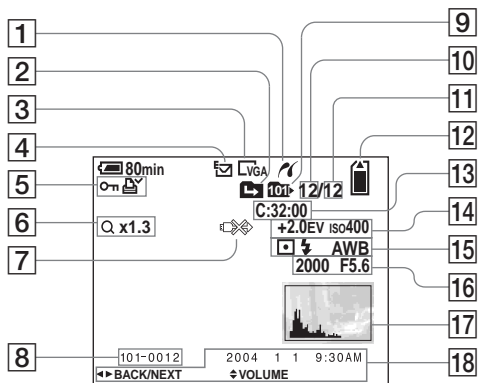

The page numbers in parentheses indicate the location of additional important information.

- | | |
|---|---|
| 1 PictBridge connecting indicator (93) | 10 Image number |
| 2 Change folder indicator (83) | 11 Number of images recorded in the playback folder |
| 3 Image size indicator (24) | 12 Remaining recording medium capacity indicator |
| 4 Recording mode indicator (79–81) | 13 Self-diagnosis display (133) |
| 5 Volume indicator (81)/
Protect mark indicator (89)/
Print (DPOF) mark indicator (91) | 14 EV adjustment indicator (59)/
ISO sensitivity (64) |
| 6 Zoom indicator (30)/
Jog playback indicator (87) | 15 Metering mode indicator (58)/
Flash indicator/
White balance indicator (73) |
| 7 Not disconnect USB cable indicator (93) | 16 Shutter speed indicator (55)/
Aperture value indicator (56) |
| 8 Folder-file number (114) | 17 Histogram indicator (60) |
| 9 Playback folder indicator (83) | 18 Recording date/time of the image (19)/Menu/guide menu (47) |

For movie playback

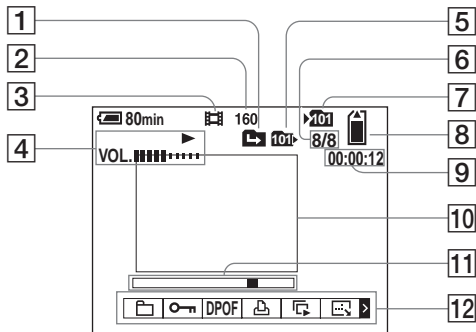

- 1 **Change folder indicator** (83)
- 2 **Image size indicator** (101)
- 3 **Recording mode indicator** (101)
- 4 **Playback indicator** (101)/
Volume indicator (101)
- 5 **Playback folder indicator** (83)
- 6 **Image number/Number of
images recorded in the playback
folder**
- 7 **Recording folder indicator** (50)
- 8 **Remaining recording medium
capacity indicator**
- 9 **Counter** (101)
- 10 **Playback screen** (101)
- 11 **Playback bar** (101)
- 12 **Menu/Guide menu** (47)

The page numbers in parentheses indicate the location of additional important information.

Quick reference chart

This section describes the restrictions in the setup of the following functions, depending on the mode dial position or the setup of some functions : shutter speed, aperture, flash, etc.

Quick chart of exposure, white balance, and auto focus functions (based on the mode dial position)

	Shutter speed (second)	Aperture	ISO	White balance	Metering mode	AF range finder frame
	Auto (1/8 to 1/3200)	Auto (F2 to F8)	Auto (64 to 200)	Auto	Multi-pattern metering	Multipoint
P	Auto (1 to 1/3200)	Auto (F2 to F8)	Auto (64 to 200)/Setup is available from 64 to 800	Setup is available	Setup is available	Setup is available
S	Setup is available from 30 to 1/2000	F2 to F8	Auto (64 fixed)/Setup is available from 64 to 800	Setup is available	Setup is available	Setup is available
A	8 to 1/2000 (aperture value F2 to F7.1)	Setup is available from F2 to F8	Auto (64 fixed)/Setup is available from 64 to 800	Setup is available	Setup is available	Setup is available
	8 to 1/3200 (aperture value F8)					
M	30 to 1/2000 (aperture value F2 to F7.1)	Setup is available from F2 to F8	Auto (64 fixed)/Setup is available from 64 to 800	Setup is available	Setup is available	Setup is available
	30 to 1/3200 (aperture value F8)					

- Note that shutter speed and ISO sensitivity are not as valid for the above table when the flash strobes.
- When using the digital zoom or horogram AF, the AF is automatically set to focus on the centrally-located subject.

Quick chart of flash mode

Mode dial		Normal/E-Mail/Voice/RAW/TIFF	Burst	Exposure Bracket	Multi Burst	NightShot	NightFraming
		Auto///SL					
P		Auto///SL					
S		/				—	—
A		//SL				—	—
M		/				—	—
SCN	Twilight		—	—	—	—	—
	Twilight portrait	SL	—	—	—	—	—
	Landscape	/				—	—
	Portrait	Auto///SL				—	—

- When shooting movies, the flash mode is set to (No flash).
- When [Pop-up Flash] is set to [Manual], the flash mode is set to (Forced flash), SL (Slow synchro), or (No flash).

The relation between the shutter speed and aperture

To shoot clear images, selecting the proper exposure is very important, adding to the chance of achieving the proper focus. The exposure is an amount of light that is determined by the shutter speed and aperture value. The shutter speed is adjusted by the time, longer or shorter. The aperture is adjusted by the scale of the lens hole, larger or smaller. When the shutter speed is faster by one step, the aperture is opened by one step to get the same exposure.

The movement of the program diagram

The program diagram shows the movement of the combination of the shutter speed and aperture value.

The program shift function (page 54) quickly shifts the combination of exposure that the camera has decided upon.

■ Program diagram (example)

■ ■ ■ ■ The movement of the program shift (EV: 10, ISO sensitivity: 100) (example)

- When the EV value remains the same, the brightness of the recorded image is the same.

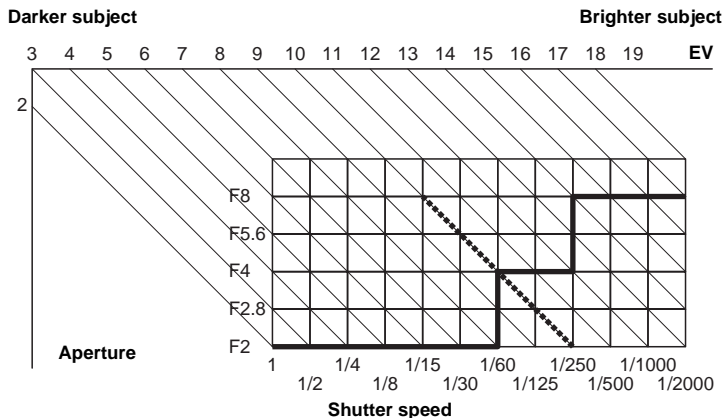

Index

A

A/V connecting cable	41
AC Adaptor	14, 17
Access lamp	22
Advanced accessory shoe	71
AE LOCK	62
AE/AF lock	27, 29
AF	27
AF Mode	66
AF range finder	65
Aperture priority	56
Auto adjustment mode	27
Auto Focus	29, 65
Auto Power Off function	18
Auto Review	140

B

Battery remaining indicator	15
Beep/shutter sound	141
Burst	75

C

CD-ROM	106
Center AF	65
Charging the battery pack	14
Charging time	15
Cleaning	143
Clock Set	19, 48, 142
Color	74
Command dial	48

CompactFlash	21
Continuous AF	67
Contrast	138
Copying images to your computer	110, 111
Cutting movies	104

D

DC plug	14, 17
Deleting movies	102
Deleting still images	43
Digital zoom	31
Display window	149
Divide	104
DPOF	91

E

E-Mail	81
EV adjustment	59
Exposure bracket	63

F

File names	114
File storage destinations	114
Finder	29
Finder adjustment	29
Flash	34, 68
Flash Level	70
Flexible spot AF	66
Folder	50, 83
Format	45
Framing burst	75

H

Histogram	60
Hologram AF	35, 140
Hot Shoe	140

I

Image quality	49
Image size	24, 25
Image Transfer	107
ImageMixer	108
Index screen	39
Indicators on the screen during shooting	30
InfoLITHIUM battery pack	146
Inserting a Memory Stick	22
Inserting a Microdrive	23
Inserting the date and time	36
Installation	106, 107, 108
ISO	64

J

JPG	115
-----------	-----

L

LCD screen brightness	141
LCD screen display	150
Lens hood	13

M

Macro	33
Manual exposure	57
Manual focus	67
Memory Stick	144
Menu	47, 137

Metering mode	58
Microdrive	145
Mode dial	27
Moisture condensation	143
Monitoring AF	66
MPG	115
Multi Burst	76, 87
Multi-pattern metering	58
Multipoint AF	65
Multi-selector	18

N

NightFraming	78
NightShot	77
NR slow shutter	55
NTSC	142
Number of images that can be saved or shooting time	16, 25, 26, 134

P

PAL	142
PictBridge	93
Picture effect	79
Playback zoom	84
Pop-up Flash	69
Power on/off	18
Precautions	143
Precision digital zoom	31
Print (DPOF) mark	91
Program auto shooting	28, 54
Program shift	54
Protect	89

Q

Quick reference chart	155
Quick Review	29

R

RAW	79
Red Eye Reduction	69
RESET button	119
Resize	90
Rotate	86

S

Saturation	138
Scene Selection	37
Self-diagnosis display	133
Self-timer	34
SET UP	48, 140
Sharpness	138
Shooting movies	100
Shooting still images	27
Shutter speed priority	55
Single AF	66
Single screen	39
Slide show	85
Smart zoom	31
Speed burst	75

T

TIFF	80
Trimming	85

U

USB	109, 117
-----------	----------

USB driver	106
Using your camera abroad	17

V

VGA	25
Viewing images on TV	41
Viewing movies on the LCD screen	101
Viewing the images on the LCD screen	39
Voice	81

W

Warnings and messages	130
White balance	73

Z

Zoom	30
------------	----



Printed on 100% recycled paper
using VOC (Volatile Organic
Compound)-free vegetable oil
based ink.

<http://www.sony.net/>

Sony Corporation Printed in Japan

Additional information on this product and answers to frequent
asked questions can be found at our Customer Support Website.