

SONY®

Digital Still Camera

Operating Instructions

Before operating the unit, please read this manual thoroughly, and retain it for future reference.

Owner's Record

The model and serial numbers are located on the bottom. Record the serial number in the space provided below. Refer to these numbers whenever you call upon your Sony dealer regarding this product.

Model No. DSC-W1/W12

Serial No. _____

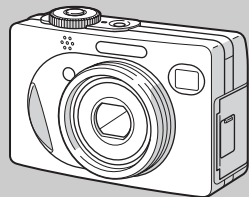

Cyber-shot



MEMORY STICK™

DSC-W1/W12

© 2004 Sony Corporation

3-091-535-11(1)

Getting started _____

Shooting still images _____

Viewing still images _____

Deleting still images _____

Before advanced operations _____

Advanced still image shooting _____

Advanced still image viewing _____

Still image editing _____

Still image printing
(PictBridge printer) _____

Enjoying movies _____

Enjoying images on your computer _____

Troubleshooting _____

Additional information _____

Index _____

WARNING

To prevent fire or shock hazard, do not expose the unit to rain or moisture.

For the Customers in the U.S.A.

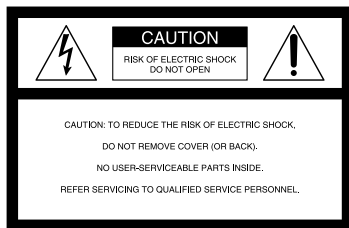

This symbol is intended to alert the user to the presence of uninsulated "dangerous voltage" within the product's enclosure that may be of sufficient magnitude to constitute a risk of electric shock to persons.



This symbol is intended to alert the user to the presence of important operating and maintenance (servicing) instructions in the literature accompanying the appliance.

If you have any questions about this product, you may call:

Sony Customer Information Services Center
1-800-222-SONY (7669)

The number below is for the FCC related matters only.

Regulatory Information

Declaration of Conformity

Trade Name: SONY
Model No.: DSC-W1
Responsible Party: Sony Electronics Inc.
Address: 16450 W. Bernardo Dr,
San Diego, CA 92127
U.S.A.
Telephone No.: 858-942-2230

This device complies with Part 15 of the FCC Rules. Operation is subject to the following two conditions: (1) This device may not cause harmful interference, and (2) this device must accept any interference received, including interference that may cause undesired operation.

CAUTION

You are cautioned that any changes or modifications not expressly approved in this manual could void your authority to operate this equipment.

Note:

This equipment has been tested and found to comply with the limits for a Class B digital device, pursuant to Part 15 of the FCC Rules. These limits are designed to provide reasonable protection against harmful interference in a residential installation. This equipment generates, uses, and can radiate radio frequency energy and, if not installed and used in accordance with the instructions, may cause harmful interference to radio communications. However, there is no guarantee that interference will not occur in a particular installation. If this equipment does cause harmful interference to radio or television reception, which can be determined by turning the equipment off and on, the user is encouraged to try to correct the interference by one or more of the following measures:

- Reorient or relocate the receiving antenna.
- Increase the separation between the equipment and receiver.
- Connect the equipment into an outlet on a circuit different from that to which the receiver is connected.
- Consult the dealer or an experienced radio/TV technician for help.

The supplied interface cable must be used with the equipment in order to comply with the limits for a digital device pursuant to Subpart B of Part 15 of FCC Rules.

For the Customers in the U.S.A. and Canada

RECYCLING NICKEL METAL HYDRIDE BATTERIES

Nickel Metal Hydride batteries are recyclable.

You can help preserve our environment by returning your used rechargeable batteries to the collection and recycling location nearest you.





For more information regarding recycling of rechargeable batteries, call toll free 1-800-822-8837, or visit <http://www.rbc.org/>

Caution: Do not handle damaged or leaking Nickel Metal Hydride batteries.

Notice for the customers in the United Kingdom

A moulded plug complying with BS 1363 is fitted to this equipment for your safety and convenience.

Should the fuse in the plug supplied need to be replaced, a fuse of the same rating as the supplied one and approved by ASTA or BSI to BS 1362, (i.e., marked with  or  mark) must be used.

If the plug supplied with this equipment has a detachable fuse cover, be sure to attach the fuse cover after you change the fuse. Never use the plug without the fuse cover. If you should lose the fuse cover, please contact your nearest Sony service station.

Attention for the Customers in Europe

This product has been tested and found compliant with the limits sets out in the EMC Directive for using connection cables shorter than 3 meters (9.8 feet).

Attention

The electromagnetic field at the specific frequencies may influence the picture and sound of this camera.

Notice

If static electricity or electromagnetism causes data transfer to discontinue midway (fail), restart the application or disconnect and connect the USB cable again.

"Memory Stick"



For the Customers in the U.S.A. and Canada

THIS DEVICE COMPLIES WITH PART 15 OF THE FCC RULES. OPERATION IS SUBJECT TO THE FOLLOWING TWO CONDITIONS:

- (1) THIS DEVICE MAY NOT CAUSE HARMFUL INTERFERENCE, AND
 - (2) THIS DEVICE MUST ACCEPT ANY INTERFERENCE RECEIVED, INCLUDING INTERFERENCE THAT MAY CAUSE UNDESIRE OPERATION.
- THIS CLASS B DIGITAL APPARATUS COMPLIES WITH CANADIAN ICES-003.

Notice

Certain countries and regions may regulate disposal of the battery used to power this product. Please consult with your local authority.

Read this first

Trial recording

Before you record one-time events, you may want to make a trial recording to make sure that the camera is working correctly.

No compensation for contents of the recording

Contents of the recording cannot be compensated for if recording or playback is not possible due to a malfunction of your camera or recording media, etc.

Back up recommendation

To avoid the potential risk of data loss, always copy (back up) data to a disk.

Notes on image data compatibility

- This camera conforms with the Design rule for Camera File system universal standard established by the JEITA (Japan Electronics and Information Technology Industries Association).
- Playback of images recorded with your camera on other equipment and playback of images recorded or edited with other equipment on your camera are not guaranteed.

Precaution on copyright

Television programs, films, video tapes, and other materials may be copyrighted. Unauthorized recording of such materials may be contrary to the provision of the copyright laws.

Do not shake or strike the camera

In addition to malfunctions and inability to record images, this may render the “Memory Stick” unusable or image data breakdown, damage or loss may occur.

LCD screen, LCD finder (only models with an LCD finder) and lens

- The LCD screen and the LCD finder are manufactured using extremely high-precision technology so over 99.99% of the pixels are operational for effective use. However, there may be some tiny black points and/or bright points (white, red, blue or green in color) that constantly appear on the LCD screen and the LCD finder. These points are normal in the manufacturing process and do not affect the recording in any way.
- Be careful when placing the camera near a window or outdoors. Exposing the LCD screen, the finder or the lens to direct sunlight for long periods may cause malfunctions.
- Do not press the LCD screen hardily. The screen may be uneven and that may cause a malfunction.
- Images may be trailed on the LCD screen in a cold location. This is not a malfunction.

The power zoom lens

This camera is equipped with a power zoom lens. Be careful not to bump the lens, and be careful not to apply force to it.

Clean the flash surface before use

The heat of flash emission may cause dirt on the flash surface to become discolored or to stick to the flash surface, resulting in insufficient light emission.

Do not get the camera wet

When taking pictures outdoors in the rain or under similar conditions, be careful not to get the camera wet. Water entering the inside of the camera may cause malfunctions which in some cases may not be repairable. If moisture condensation occurs, see page 116 and follow the instructions on how to remove it before using the camera.

Do not expose the camera to sand or dust

Using the camera in sandy or dusty locations may cause malfunction.

Do not aim the camera at the sun or other bright light

This may cause irrecoverable damage to your eyes. Or it may cause the malfunction of your camera.

Notes on the camera locations

Do not use the camera near a location that generates strong radio wave or emits radiation. The camera may not be able to record or play back properly.

Carl Zeiss lens

This camera is equipped with a Carl Zeiss lens which is capable of reproducing sharp images with excellent contrast.

The lens for this camera has been produced under a quality assurance system certified by Carl Zeiss in accordance with the quality standards of Carl Zeiss in Germany.

The pictures used in this manual

The photographs used as examples of pictures in this manual are reproduced images, and are not actual images shot using this camera.

Trademarks

- **Cyber-shot** is a trademark of Sony Corporation.
- “Memory Stick,”  “Memory Stick PRO”, **MEMORY STICK PRO**, “Memory Stick Duo”, **MEMORY STICK DUO**, “Memory Stick PRO Duo”, **MEMORY STICK PRO DUO**, “MagicGate” and **MAGIC GATE** are trademarks of Sony Corporation.
- Picture Package is a trademark of Sony Corporation.
- Microsoft, Windows, and Windows Media, and DirectX are either registered trademarks or trademarks of Microsoft Corporation in the United States and/or other countries.
- Macintosh, Mac OS, QuickTime, iMac, iBook, PowerBook, Power Mac and eMac are trademarks or registered trademarks of Apple Computer, Inc.

- Macromedia and Flash are trademarks or registered trademarks of Macromedia, Inc. in the United States and/or other countries.
- Intel, MMX, and Pentium are trademarks or registered trademarks of Intel Corporation.
- In addition, system and product names used in this manual are, in general, trademarks or registered trademarks of their respective developers or manufacturers. However, the TM or ® marks are not used in all cases in this manual.

Table of contents

Read this first	4
Identifying the parts	8
Mode dial	10

Getting started

Preparing batteries	11
Charging the batteries	11
Inserting the batteries	13
Using the AC adaptor	16
Using your camera abroad	16
Turning on/off your camera	17
How to use the control button	17
Setting the date and time	18

Shooting still images

Inserting and removing a “Memory Stick”	20
Setting the still image size	21
Image size and quality	22
Basic still image shooting	
— Using auto adjustment mode	24
Checking the last image you shot	
— Quick Review	26
Using the zoom feature	26
Shooting close-ups	
— Macro	28
Using the self-timer	29
Selecting a flash mode	30
Shooting images with the finder	32

Inserting the date and time on a still image	33
Shooting according to scene conditions	34

Viewing still images

Viewing images on the LCD screen of your camera	37
Viewing images on a TV screen	39

Deleting still images

Deleting images	41
Formatting a “Memory Stick”	43

Before advanced operations

How to setup and operate your camera	45
Changing the menu settings	45
Changing the items in the SET UP screen	46
Deciding the still image quality	46
Creating or selecting a folder	47
Creating a new folder	47
Changing the recording folder	47

Advanced still image shooting

Choosing an auto focus method	48
Choosing a focus range finder frame	
— AF range finder	48
Choosing a focus operation	
— AF Mode	49
Setting the distance to the subject	
— Focus preset	50
Shooting with manual shutter speed and aperture settings	
— Manual Exposure	51
Adjusting the exposure	
— EV adjustment	54
Displaying a histogram	55
Selecting the metering method	56
Adjusting color tones	
— White Balance	57
Adjusting the flash level	
— Flash Level	58
Shooting continuously	59
Shooting in Multi Burst mode	
— Multi Burst	60
Shooting with special effects	
— Picture Effect	60

Advanced still image viewing

Selecting the folder and playing back images	
— Folder	62
Enlarging a portion of a still image	63
Enlarging an image	
— Playback zoom	63
Recording an enlarged image	
— Trimming	64
Playing back successive images	
— Slide Show	64
Rotating still images	
— Rotate	65
Playing back images shot in Multi Burst mode	65
Playing back continuously	66
Playing back frame by frame	66

Still image editing

Protecting images	
— Protect	67
Changing image size	
— Resize	68
Choosing images to print	
— Print (DPOF) mark	69

Still image printing (PictBridge printer)

Connecting to a PictBridge compliant printer	71
Printing images	72
Printing index-images	74

Enjoying movies

Shooting movies	77
Viewing movies on the LCD screen	78
Deleting movies	79
Cutting movies	80

Enjoying images on your computer

Copying images to your computer	
— For Windows users	82
Installing the USB driver	83
Connecting the camera to your computer	84
Copying images	85
Viewing the images on your computer	87
Image file storage destinations and file names	87
Viewing image files once copied to a computer with your camera	89
Installing “Picture Package”	89

Copying images using “Picture Package”	91
Using “Picture Package”	92
Copying images to your computer	
— For Macintosh users	93
Using “ImageMixer VCD2”	94

Troubleshooting

Troubleshooting	96
Warnings and messages	106
Self-diagnosis display	108

Additional information

Number of images that can be saved or shooting time	109
Menu items	110
SET UP items	114
Precautions	116
On “Memory Stick”	117
On Nickel-Metal Hydride batteries	118
On the battery charger	119
Specifications	120
The LCD screen	122

Index

Index	126
-------	-----

Identifying the parts

See the pages in parentheses for details of operation.

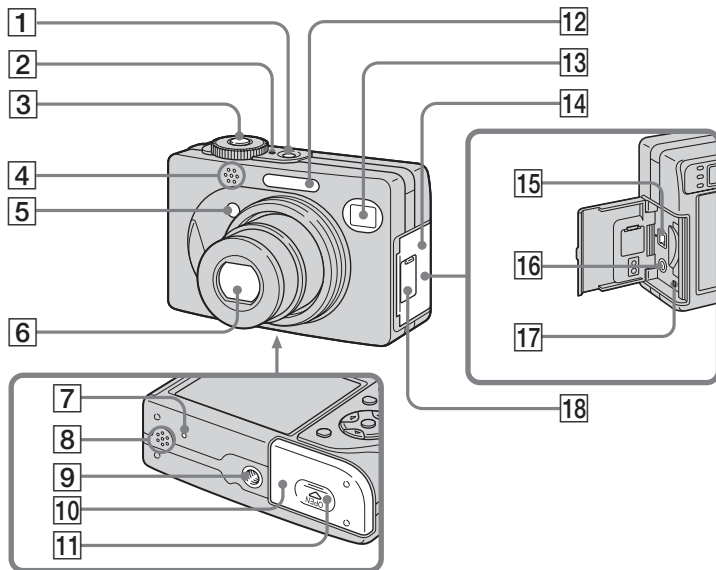





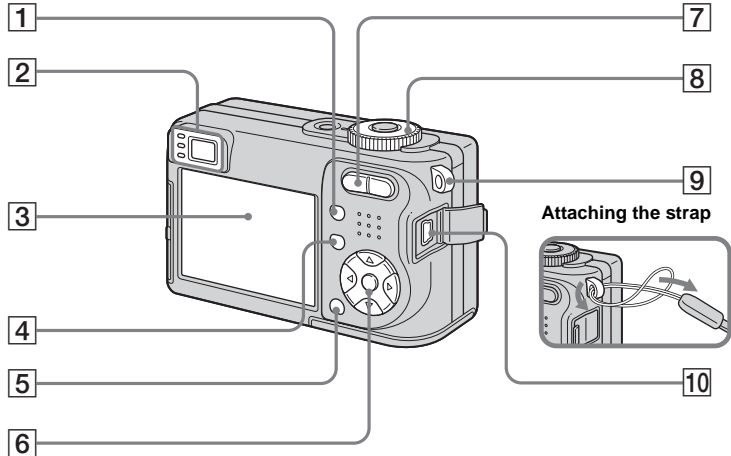



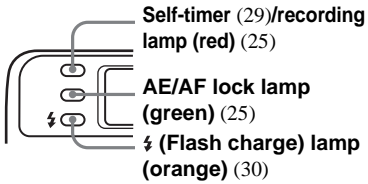



- 1 **POWER button** (17)
- 2 **POWER lamp** (17)
- 3 **Shutter button** (25)
- 4 **Microphone**
- 5 **Self-timer lamp** (29)/
AF illuminator (31, 114)
- 6 **Lens**
- 7 **RESET button** (96)
- 8 **Speaker**
- 9 **Tripod receptacle**
- 10 **Battery cover** (13)
- 11 **OPEN button** (13)
- 12 **Flash** (30)
- 13 **Finder window**
- 14 **Jack/"Memory Stick" cover**
- 15 **DC IN jack** (16)
- 16 **A/V OUT (MONO) jack** (39)
- 17 **Access lamp** (20)
- 18 **DC IN jack cover** (16)





- Use a tripod with a screw length of less than 5.5 mm (7/32 inch). You will be unable to firmly secure the camera to tripods having longer screws, and may damage the camera.



- 1  (Display/LCD on/off) button (32)
- 2 **Finder** (32)



- 3 **LCD screen**
For details on the items on the LCD screen, see page 122 to 125.
- 4 **MENU button** (45, 110)
- 5  /  (**Image Size/Delete**) button (21, 41)
- 6 **Control button**
Menu on:  /  /  /  /  (17) /
Menu off:  /  /  /  (30/29/26/28)
Mode dial "M": Shutter speed/aperture value (51)

- 7 **For shooting: Zoom (W/T) button** (26)
For viewing:  /  (Playback zoom) button (63) /  (Index) button (38)
- 8 **Mode dial** (10, 110)
- 9 **Hook for wrist strap**
- 10  (**USB**) jack (84)

Mode dial

Before using your camera, set the desired mark on the mode dial to the POWER lamp side.

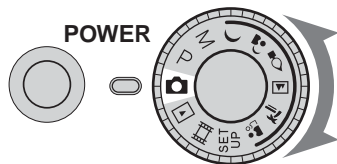

(Auto adjustment mode)

The focus, exposure and white balance are automatically adjusted to allow easy shooting. The image quality is set to [Fine] (page 46).

P (Program auto shooting)

The shooting adjustments are made automatically just as in the auto adjustment mode, but you can also change the focus and other adjustments as desired. In addition, you can set various shooting functions using menus (pages 45 and 110).

M (Manual exposure shooting)

You can manually adjust the aperture value and the shutter speed (page 51). In addition, you can set various shooting functions using menus (pages 45 and 110).

(Twilight mode)

(Twilight portrait mode)

(Candle mode)

(Landscape mode)

(Beach mode)

(Soft snap mode)

You can easily shoot effective pictures according to the scene (page 34). In addition, you can set various shooting functions using menus (pages 45 and 111).

SET UP (Set up)

You can change the settings of the camera (pages 46 and 114).

(Movie shooting)

You can shoot movies (page 77).

(Playback/Edit)

You can play back or edit recorded still images and movies (pages 37 and 67).

Preparing batteries

Use the following batteries in this camera.

Acceptable batteries

HR 15/51:HR6 (size AA) Nickel-Metal Hydride batteries (2)

- NH-AA-DA (2) (supplied)
- NH-AA-2DA twin-pack (not supplied), etc.

R6 (size AA) alkaline batteries (2)

Batteries that cannot be used

Manganese batteries
Lithium batteries
Ni-cad batteries

If you use the batteries described above, we cannot guarantee full performance of the camera by property of the batteries, such as brownout of the batteries.

Notes on using alkaline batteries

- Alkaline batteries have a shorter life compared to the supplied Nickel-Metal Hydride batteries. For this reason, the power may turn off even though the battery remaining indicator shows sufficient battery life remaining.
- Battery performance differs greatly depending on the manufacturer and the type of battery, and in some cases the battery life may be extremely short. This is especially true at low temperatures, and you may not be able to shoot at temperatures below 5°C (41°F).
- Do not mix new and old batteries.
- The battery remaining indicator does not display the correct information when using alkaline batteries.
- Due to the characteristics of alkaline batteries, there is a large difference between the available shooting time and the available playback time. For this reason, the camera may turn off with the lens portion extended when you switch the mode dial. In this case, replace the batteries with new ones or fully charged Nickel-Metal Hydride batteries.

We recommend using the supplied Nickel-Metal Hydride batteries.

Charging the batteries

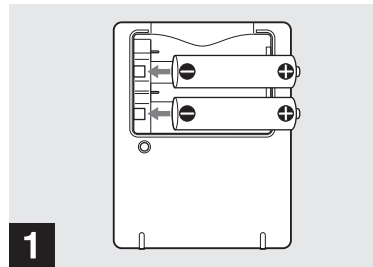

➔ **Insert Nickel-Metal Hydride batteries into the battery charger (supplied) with the correct polarity +/-.**

- **You cannot charge alkaline batteries using the battery charger.**
- **Be sure to charge the Nickel-Metal Hydride batteries supplied with your camera before using them.**
- Connect the battery charger to an easily accessible wall outlet (wall socket) close by.
- Even if the CHARGE lamp is not lit, the battery charger is not disconnected from the AC power source (mains) as long as it is connected to the wall outlet (wall socket). If some trouble occurs while using the battery charger, immediately shut off the power by disconnecting the plug from the wall outlet (wall socket).

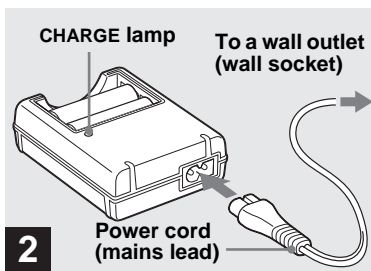

➔ **Connect the battery charger to a wall outlet (wall socket) using the power cord (mains lead).**

The CHARGE lamp lights up when charging begins, and goes off when charging is completed.

For details on the battery charger (supplied), see page 119.

To remove the batteries

Press the – end of the battery down in order to raise the + end, then remove the battery.

- When charging is finished, disconnect the power cord (mains lead) from the wall outlet (wall socket), and remove the Nickel-Metal Hydride batteries from the battery charger.

Charging time

Nickel-Metal Hydride battery	Charging time
NH-AA-DA × 2 (supplied)	Approx. 6 hours

This represents the time required to charge fully depleted Nickel-Metal Hydride batteries using the supplied battery charger in an environment where the ambient temperature is 25°C (77°F).

- It takes about six hours to completely charge the batteries. The CHARGE lamp may remain lit longer than six hours, but this is not a malfunction.
- If you use the battery charger supplied with the STAMINA “Quick charge” kit (not supplied), the batteries will charge faster.

Charging time

When charging two Nickel-Metal Hydride batteries: Approximately 2 hours 30 minutes

When charging four Nickel-Metal Hydride batteries: Approximately 5 hours

Notes on the Nickel-Metal Hydride batteries

- **At the time of purchase, or when the Nickel-Metal Hydride batteries have not been used for a long time, they may not fully charge. This is typical of this type of battery, and is not a malfunction. If this happens, repeatedly using up the batteries fully, and then recharging them, should correct the problem.**
- If the poles of the Nickel-Metal Hydride batteries are dirty, the batteries may not charge properly. Occasionally clean the poles of the batteries and the terminals of the charger by wiping them with a dry cloth.
- Always carry the Nickel-Metal Hydride batteries in the supplied battery case. Otherwise, metallic objects may short the + and – ends, resulting in the risk of heating or fire.
- Even when Nickel-Metal Hydride batteries are not being used they lose their charge naturally over time. It is recommended that you recharge the batteries just before using them.
- If you recharge Nickel-Metal Hydride batteries before fully using up the existing charge, the low battery warning may be displayed sooner than expected. This is called the “memory effect.”* If this problem occurs, charging the batteries only after using up the existing charge will correct it.

* The “memory effect” – the situation in which the capacity of the battery is temporarily lowered.

Inserting the batteries

- To use up the batteries completely, put the camera in the slide show mode (page 64) and leave it that way until the batteries are used up.
- Do not peel off the external seals or damage the batteries. Never use batteries from which the seals have been partially or completely removed, or batteries that have been split in any way. These may cause leakage, explosion, or heat-up of the battery, and personal scald or injury may be caused. These may cause a malfunction of the battery charger.

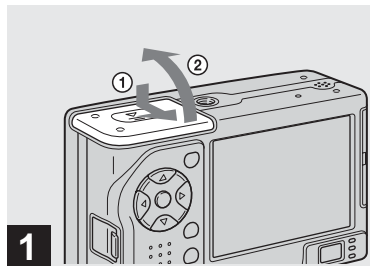

➔ Open the battery cover.

Press ▼ on the OPEN button and slide it in the direction of the arrow to open the cover.

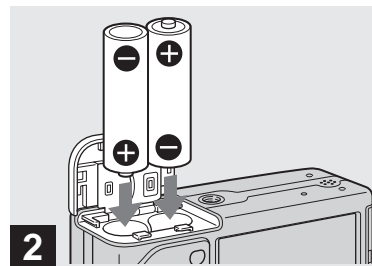

➔ Insert the batteries.

Match the +/- poles of the batteries to the +/- marks inside the battery case.

- From time to time, use a dry cloth to wipe any dirt off of the battery terminals and the contacts inside the inner cover. Skin oil and other dirt on the battery terminals and contacts can significantly shorten the operating time provided by the batteries.

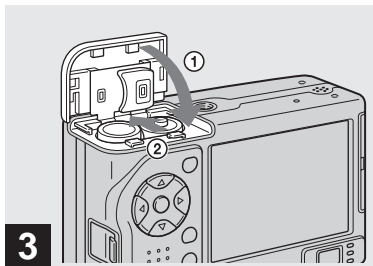

→ Close the battery cover.

Press in the batteries with the cover, and close the cover firmly until it locks in place.

To remove the batteries

Hold the camera with the battery cover facing upward, then open the battery cover and remove the batteries.

- Be careful not to drop the batteries when opening or closing the battery cover.

Battery remaining indicator (When using the Nickel-Metal Hydride batteries)

As the battery power decreases with use, the battery remaining indicator displays the amount of power remaining using the following symbols.

Battery remaining indicator	Battery remaining guidelines
	Sufficient power remaining
	Battery half full
	Battery low, recording/ playback will stop soon.
	Change the batteries for fully charged ones, or charge these batteries. (The warning indicator flashes.)

- If the LCD screen is off, press to turn it on.
- Based on the conditions under which the camera is being used and the state of the charge, or on the environment, this information may not be correctly indicated.
- When using alkaline batteries, the battery remaining indicator does not display the correct information. In addition, battery performance differs greatly depending on the manufacturer and the type of battery, and the power may turn off even though the battery remaining indicator shows sufficient battery life remaining. In this case, replace the batteries with new ones or use the supplied Nickel-Metal Hydride batteries.
- When the AC Adaptor (not supplied) is being used, the battery remaining indicator is not displayed.

Number of images and battery life that can be recorded/viewed

The tables show the approximate number of images and the battery life that can be recorded/viewed when you shoot images in normal mode with fully charged batteries (supplied) at a temperature of 25°C (77°F). The numbers of images that can be recorded or viewed take into account changing the supplied “Memory Stick” as necessary. Note that the actual numbers may be less than indicated depending on the conditions of use.

- The battery capacity decreases as the number of uses increases and over time (page 118).

Shooting still images

Under the average conditions¹⁾

Image size	NH-AA-DA (2) (supplied)		
	LCD screen	No. of images	Battery life (min.)
5M	On	Approx. 340	Approx. 170
	Off	Approx. 580	Approx. 290
VGA(E-Mail)	On	Approx. 340	Approx. 170
	Off	Approx. 580	Approx. 290

Image size	R6 (Size AA) alkaline battery (2) (not supplied)		
	LCD screen	No. of images	Battery life (min.)
5M	On	Approx. 70	Approx. 35
	Off	Approx. 150	Approx. 75
VGA(E-Mail)	On	Approx. 70	Approx. 35
	Off	Approx. 150	Approx. 75

- When using Sony alkaline batteries

¹⁾ Shooting in the following situations:

- The  (P. Quality) is set to [Fine]
- Shooting one time every 30 seconds
- The zoom is switched alternately between the W and T ends
- The flash strobes once every two times
- The power turns on and off once every ten times
- [AF Mode] is set to [Single]

The measurement method is based on CIPA standard. (CIPA: Camera & Imaging Products Association)

Viewing still images²⁾

Image size	NH-AA-DA (2) (supplied)	
	No. of images	Battery life (min.)
5M	Approx. 6800	Approx. 340
VGA(E-Mail)	Approx. 6800	Approx. 340

²⁾ Viewing single images in order at about three second intervals

Shooting movies³⁾

NH-AA-DA (2) (supplied)	
LCD screen On	LCD screen Off
Approx. 170 min.	Approx. 240 min.

³⁾ Shooting movies continuously with the image size [160]

- The number of images and the battery life that can be recorded/viewed are decreased under the following conditions:
 - The surrounding temperature is low
 - The flash is used
 - The camera has been turned on and off many times
 - The zoom is used frequently
 - [LCD Backlight] is set to [Bright] in the SET UP settings
 - [AF Mode] is set to [Monitor] in the SET UP settings
 - The battery power is low

Using the AC adaptor

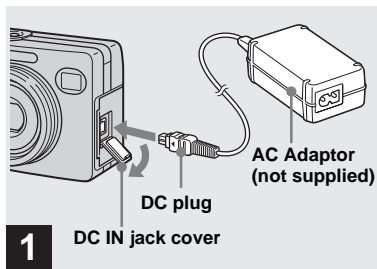

- ➔ **Open the DC IN jack cover and connect the AC Adaptor AC-LS5 (not supplied) to the DC IN jack of your camera.**

Connect the DC plug with the ▲ mark facing the front of the camera.

- **Be sure to use the AC-LS5 AC Adaptor. Other AC adaptors cannot be used with this camera.**
- Connect the AC Adaptor to an easily accessible wall outlet (wall socket) close by. If any trouble occurs while using the adaptor, immediately shut off the power by disconnecting the plug from the wall outlet (wall socket).

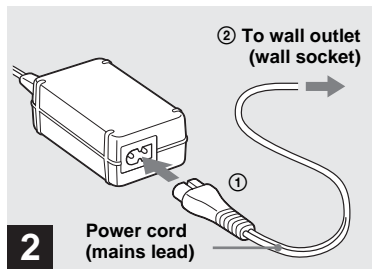

- ➔ **Connect the power cord (mains lead) to the AC Adaptor and then to a wall outlet (wall socket).**

- After using the AC Adaptor, disconnect it both from the DC IN jack of the camera and from a wall outlet (wall socket).
- The set is not disconnected from the AC power source (mains) as long as it is connected to the wall outlet (wall socket) even if the set itself has been turned off.

Using your camera abroad

Power sources

You can use your camera in any country or region with the battery charger (supplied) or the AC Adaptor AC-LS5 (not supplied) within 100 V to 240 V AC, 50/60 Hz. Use a commercially available AC plug adaptor [a], if necessary, depending on the design of the wall outlet (wall socket) [b].

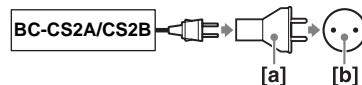

- Do not use an electronic transformer (travel converter), as this may cause a malfunction.

Turning on/off your camera

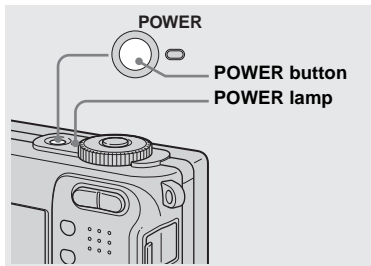

→ Press POWER.

The POWER lamp (green) lights up and the power is on. When you turn on your camera for the first time, the Clock Set screen appears (page 18).

Turning off the power

Press POWER again. The POWER lamp goes out, and the camera turns off.

- Do not leave the camera with the lens portion extended for a long period of time with the batteries or the AC Adaptor (not supplied) removed, etc., as this may cause malfunction.
- If you turn on the power when the mode dial is set to other than SET UP or , or when you push the RESET button, the lens portion moves. Do not touch the lens portion while it is operating.

Auto power-off function







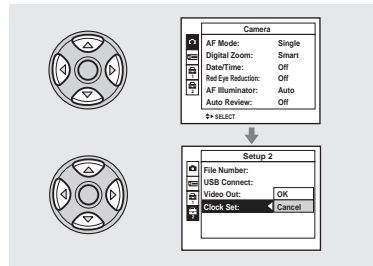

If you do not operate the camera for about three minutes during shooting or viewing or when performing SET UP, the camera turns off automatically to prevent wearing down the batteries. The auto power-off function only operates when the camera is operating using batteries. The auto power-off function also will not operate in the following circumstances.

- When viewing movies
- When playing back a slide show
- When connecting the  (USB) jack or A/V OUT (MONO) jack

How to use the control button



To change the current settings of the camera, bring up the menu or the SET UP screen (page 46), and use the control button to make the changes.





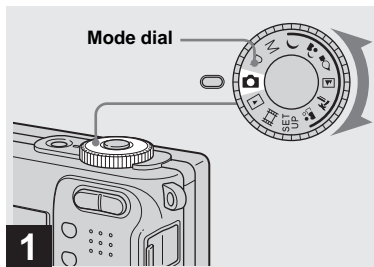



To set a menu item, press /// on the control button to select the desired item and setting and make the setting. To set a SET UP item, press /// on the control button to select the desired item and setting, then press  to make the setting.

Setting the date and time



➔ Set the mode dial to .

- To change the date and time, set the mode dial to **SET UP**, select **[Clock Set]** in  (**Setup 2**) (pages 46 and 115), and perform the procedure from step **3**.

- You can also carry out this operation when the mode dial is set to P, M, , , , , , ,  or .

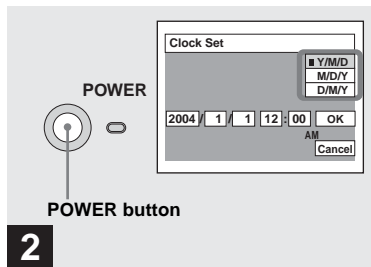

➔ Press **POWER** to turn on the power.

The **POWER** lamp (green) lights up and the **Clock Set** screen appears on the LCD screen.

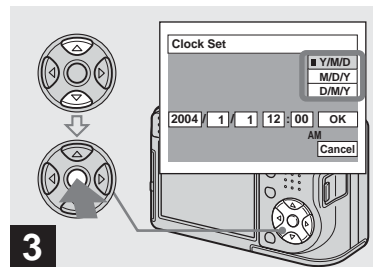

➔ Select the desired date display format with **▲/▼** on the control button, then press **●**.

Select from **[Y/M/D]** (year/month/day), **[M/D/Y]** (month/day/year) or **[D/M/Y]** (day/month/year).

- If the rechargeable button battery (page 117), which provides the power for saving the time data, ever becomes low, the **Clock Set** screen will appear again. When this happens, reset the date and time, by starting from step **3** above.

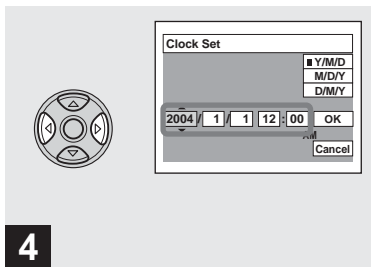

- 4**
- Select the year, month, day, hour or minute item you want to set with ◀/▶ on the control button.

The item to be set is indicated with ▲/▼.

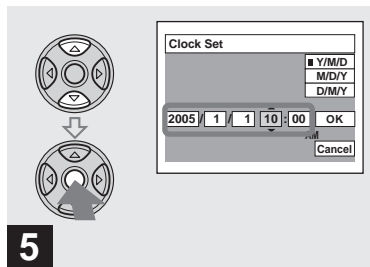

- 5**
- Set the numeric value with ▲/▼ on the control button, then press ● to enter it.

After entering the number, ▲/▼ moves to the next item. Repeat steps **4** and **5** until all of the items are set.

- If you selected [D/M/Y] in step **3**, set the time on a 24-hour cycle.
- Midnight is indicated as 12:00 AM, and noon as 12:00 PM.

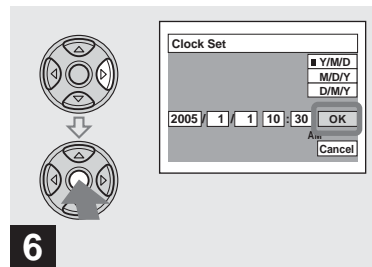

- 6**
- Select [OK] with ▶ on the control button, then press ●.

The date and time are entered and the clock starts to keep time.

- To cancel the date and time setting, select [Cancel] with ▲/▼/◀/▶ on the control button, then press ●.

Inserting and removing a “Memory Stick”

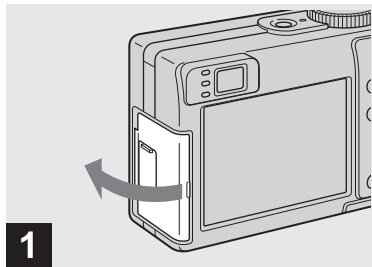

- 1** → Open the jack/“Memory Stick” cover.

- For details on “Memory Stick,” see page 117.

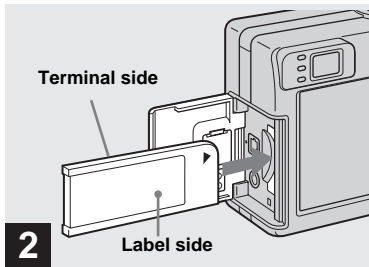

- 2** → Insert the “Memory Stick.”

Insert a “Memory Stick” all the way in until it clicks as illustrated.

- Push the “Memory Stick” all of the way in so that it is securely seated in the connector. If the “Memory Stick” is not inserted correctly, you may not be able to record or display images with the “Memory Stick.”

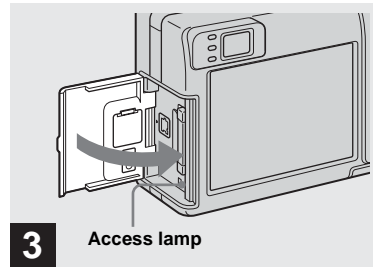

- 3** → Close the jack/“Memory Stick” cover until it clicks.

To remove a “Memory Stick”





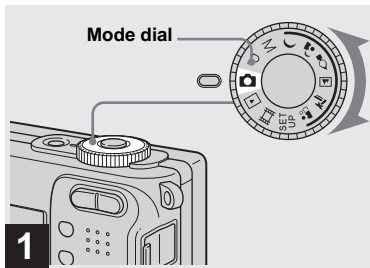

Open the jack/“Memory Stick” cover, then push the “Memory Stick” to pop it out.

- **Whenever the access lamp is lit, the camera is recording or reading an image. Never remove the “Memory Stick” or turn off the power at this time. The data may be corrupted.**

Setting the still image size



➔ Set the mode dial to , and turn on the power.

- You can also carry out this operation when the mode dial is set to P, M, , , , , , or .

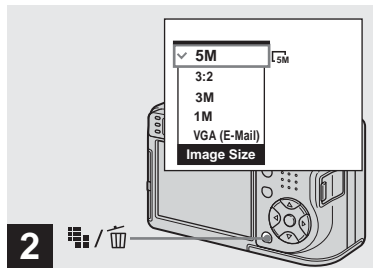



➔ Press  (Image Size).

The Image Size setup appears.

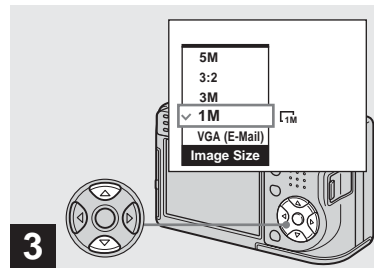
- For details on the image size, see page 22.



➔ Select the desired image size with  /  on the control button.

The image size is set.

When the setting is complete, press  (Image Size) so that the Image Size setup disappears from the LCD screen.

- The image size setting selected here is maintained even when the power is turned off.

Image size and quality

You can choose image size (number of pixels) and image quality (compression ratio) based on the kind of images you want to shoot.

The image size is shown by the number of pixels (dots) (horizontal × vertical), which compose an image. For example, a 5M (2592×1944) size image indicates that there are 2592 pixels horizontally and 1944 pixels vertically. The larger the number of pixels, the larger the image size.

You can select from Fine (high quality) or Standard image quality. Each uses a different compression ratio.

When you select Fine, the image quality improves as the image size increases, but the amount of recorded data also increases and the number of images that can be recorded on a “Memory Stick” decreases. Refer to the table on the right and choose the image size and image quality appropriate to the kind of images you want to shoot.

Short description of the image size

The following illustration shows a brief image using the maximum image size and the minimum one.

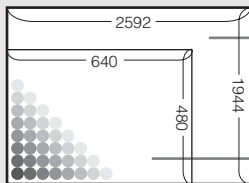

Display size: 5M

Image size: 5M

2592 pixels × 1944 pixels=5,038,848 pixels

Display size: VGA (E-Mail)

Image size: VGA

640 pixels × 480 pixels=307,200 pixels

Examples based on the image size

Image size		Usage guidelines
5M ¹⁾ (2592×1944)	Larger ↑ ↓ Smaller	<ul style="list-style-type: none">• For saving important images, printing in A4 size or printing A5 size high density images• For printing in postcard size• For recording a larger number of images• For attaching images to e-mail or creating home pages
3:2 ²⁾ (2592×1728)		
3M (2048×1536)		
1M (1280×960)		
VGA (E-Mail) (640×480)		

¹⁾ The factory setting is [5M]. It is the highest image quality on this camera.

²⁾ Images are recorded in the same 3:2 aspect ratio as photograph printing paper or postcards, etc.

Examples based on the image quality

Image quality (Compression ratio)		Usage guideline
Fine	Low compression (looks better)	<ul style="list-style-type: none"> For recording or printing with better image quality For recording a larger number of images
Standard	High compression (normal)	

The number of images that can be saved in a “Memory Stick”³⁾

The number of images that can be saved in Fine (Standard)⁴⁾ mode are shown below.

(Units: number of images)

Image size \ Capacity	Capacity						
	16MB	32MB	64MB	128MB	MSX-256	MSX-512	MSX-1G
5M	6 (11)	12 (23)	25 (48)	51 (96)	92 (174)	188 (354)	384 (723)
3:2	6 (11)	12 (23)	25 (48)	51 (96)	92 (174)	188 (354)	384 (723)
3M	10 (18)	20 (37)	41 (74)	82 (149)	148 (264)	302 (537)	617 (1097)
1M	24 (46)	50 (93)	101 (187)	202 (376)	357 (649)	726 (1320)	1482 (2694)
VGA (E-Mail)	97 (243)	196 (491)	394 (985)	790 (1975)	1428 (3571)	2904 (7261)	5928 (14821)

³⁾ When [REC Mode] is set to [Normal].

For the number of images that can be saved in other modes, see page 109.

⁴⁾ For more information about the image quality (compression ratio), see page 46.

- When images recorded using earlier Sony models are played back on this camera, the display may differ from the actual image size.
- When the images are viewed on the LCD screen of the camera, they all look the same size.
- Number of shooting images can differ from these values according to shooting conditions.
- When the number of remaining shooting images is greater than 9,999, the “>9999” indicator appears on the LCD screen.
- You can resize the images later (Resize function, see page 68).

Basic still image shooting — Using auto adjustment mode

Holding the camera correctly



When shooting pictures with the camera, be careful so that your fingers do not block the lens portion, finder window, flash emitter, microphone or self-timer lamp/AF illuminator (page 8).

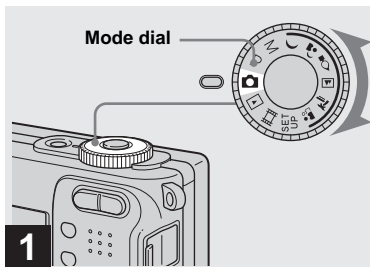

➔ **Set the mode dial to , and turn on the power.**

- The lens cover opens when the power is turned on.
- Do not touch the lens portion while it is operating, such as when you press POWER to turn on the power or when the zoom function is working (page 26).
- This camera can create new folders and select folders to be stored in the “Memory Stick” (page 47).

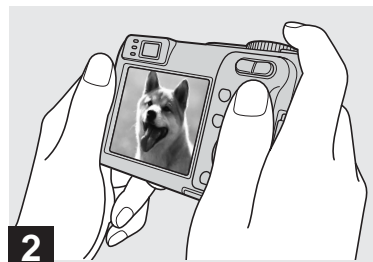

➔ **Hold the camera steadily with both hands and position the subject in the center of the focus frame.**

- The minimum focal distance to a subject is approx. 50 cm (19 3/4 inches). To shoot subjects at distances closer than this, use the close-ups (Macro) mode (page 28).
- The frame indicated on the LCD screen shows the focus adjustment range (AF range finder, page 48).



→ **Press and hold the shutter button halfway down.**

The beep sounds but the image is not yet recorded. When the AE/AF lock indicator changes from flashing to steadily lit, the camera is ready for shooting. (The LCD screen may be frozen for a split second depending on the subject.)

- If you release the shutter button, shooting will be canceled.
- You can continue and shoot even when the camera does not beep, but in this case the focus is not set properly.

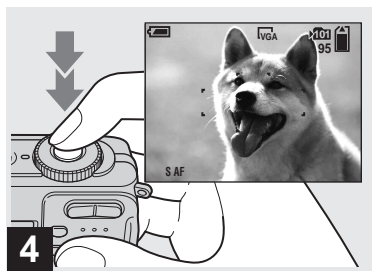

→ **Press the shutter button fully down.**

The shutter sounds. The image will be recorded in the “Memory Stick.” When the recording lamp (page 9) goes out, you can shoot the next image.

- When operating the camera using batteries, if you do not operate the camera for a while during recording or playback, the camera turns off automatically to prevent wearing down the batteries (page 17).

Auto Focus

When you try to shoot a subject that is difficult to focus on, the AE/AF lock indicator changes to flashing slowly. In addition, the AE locked beep does not sound.

The Auto Focus function may have difficulty working under the following conditions. In such cases, release the shutter button, then recompose the shot and focus again.

- The subject is distant from the camera and dark.
- The contrast between the subject and its background is poor.
- The subject is seen through glass, such as a window.
- A fast-moving subject.
- The subject reflects or has a lustrous finish, such as a mirror or a luminous body.
- A flashing subject.
- A backlit subject.

There are two Auto Focus functions: “AF range finder frame” which sets the focus position according to the subject position and size, and “AF mode” which sets the focus start/finish timing. See page 48 for details.

Checking the last image you shot — Quick Review

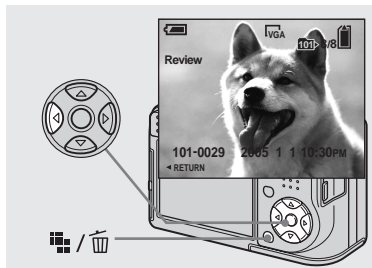

➔ Press ◀ (⏪) on the control button.

To return to the normal shooting mode, press lightly on the shutter button or press ◀ (⏪) again.

To delete the image displayed on the LCD screen

- 1 Press / (Delete).
- 2 Select [Delete] with ▲ on the control button, then press ●.
The image is deleted.

- The image may appear rough right after playback starts due to the image processing.

Using the zoom feature

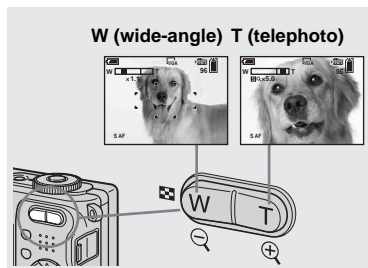

➔ Press the zoom buttons to choose the desired zoom position for shooting.

The minimum focal distance to the subject

Approx. 50 cm (19 3/4 inches) from the lens surface

- The lens portion moves during zoom operation. Do not touch the lens portion while it is operating.
- You cannot change the zoom scale while shooting movie (page 77).

Zoom

Your camera is equipped with zoom functions that enlarge the image using optical zoom and two types of digital processing. Digital zoom can be selected from smart zoom or precision digital zoom. When digital zoom is set, the zoom method switches from optical zoom to digital zoom when the zoom scale exceeds 3×.

To use only the optical zoom, set [Digital Zoom] to [Off] in the SET UP settings (page 114). In this case, the digital zoom area does not appear in the zoom scale display bar on the LCD screen, and the maximum zoom is 3×. The enlargement method and the zoom scale differ according to the image size and the zoom type, so select the zoom to match the shooting purpose.

When you press the zoom button, the zoom scaling indicator appears on the LCD screen as follows.

The W side of this line is optical zoom area, and the T side is digital zoom area

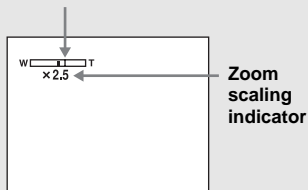

- The zoom scaling indicator differs according to the zoom type.
 - Optical zoom: **X**
 - Smart zoom: **SQx**
 - Precision digital zoom: **PQx**
- The AF range finder frame does not appear when using the digital zoom. The **[AF]** or **[AF]** indicators flashes, and AF operates with priority on subjects located near the center.

Smart zoom

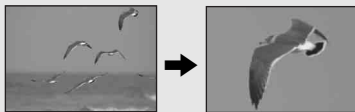

The image is enlarged with almost no distortion. This lets you use smart zoom with the same feeling as optical zoom. To set smart zoom, set [Digital Zoom] to [Smart] in the SET UP settings (page 114).

When you purchase your camera, it is set to smart zoom.

The maximum zoom scale depends on the selected image size as follows.

Image size	Maximum zoom scale
3M	3.8×
1M	6.1×
VGA (E-Mail)	12×

Smart zoom cannot be used when the image size is set to [5M] or [3:2], so set a different image size. When you purchase your camera, the image size is set to [5M].

- When using the smart zoom, the image on the LCD screen may look rough. However, this phenomenon has no effect on the recorded image.
- You cannot use the smart zoom in the Multi Burst mode.

Precision digital zoom

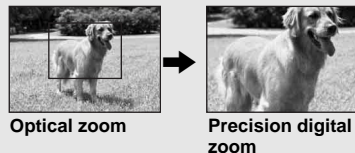

All image sizes are enlarged up to a maximum 6×. This function cuts out and enlarges a certain portion of the image, so the image quality deteriorates. To set precision digital zoom, set [Digital Zoom] to [Precision] in the SET UP settings (page 114).



The close-ups (Macro) recording mode is used when zooming up subjects such as flowers or insects. Setting the zoom all the way to the W side lets you shoot subjects at distances as close as 6 cm (2 3/8 inches). However, the minimum focus distance varies according to the zoom position. Therefore, shooting with the zoom set all the way to the W side is recommended.

When the zoom is set all the way to the W side:

Approx. 6 cm (2 3/8 inches) from the lens surface



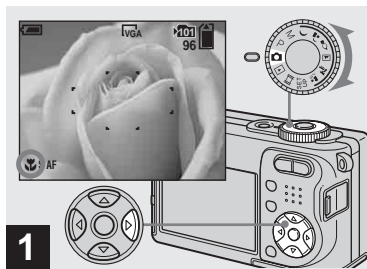

When the zoom is set all the way to the T side:

Approx. 30 cm (11 7/8 inches) from the lens surface



➔ **Set the mode dial to , and press  on the control button.**

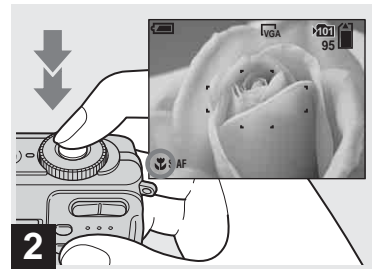

The  (Macro) indicator appears on the LCD screen.

- If the menu is currently displayed, press MENU first so that the menu disappears.
- You can also carry out this operation when the mode dial is set to P, M, , , , or .



➔ **Center the subject in the frame. Press and hold the shutter button halfway down to focus on, then press the shutter button fully down.**



To return to normal recording mode

Press  on the control button again. The  indicator disappears from the LCD screen.



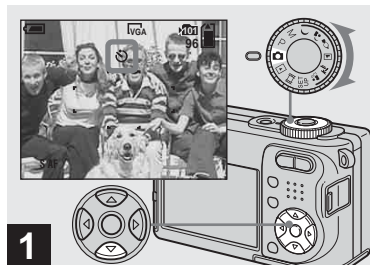





Using the self-timer

- When shooting in close-ups (Macro) mode, use the LCD screen. If you shoot using the finder, the range you can see through the finder may differ from the actual recording range. This is due to parallax.
- When shooting in close-ups (Macro) mode, the in-focus range becomes extremely narrow, and the entire subject may not be in focus.
- When shooting in close-ups (Macro) mode, the AF speed drops in order to focus accurately on close subjects.



➔ **Set the mode dial to , and press  on the control button.**

The  (self-timer) indicator appears on the screen.

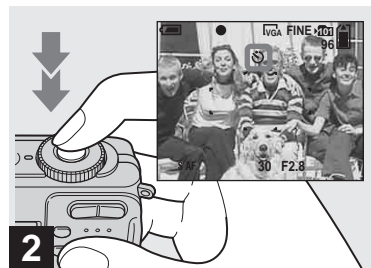

- If the menu is currently displayed, press MENU first so that the menu disappears.
- You can also carry out this operation when the mode dial is set to P, M, , , , , , , , or .



➔ **Center the subject in the frame. Press and hold the shutter button halfway down to focus on, then press the shutter button fully down.**

The self-timer lamp (page 8) flashes and a beep sounds after you press the shutter button until the shutter operates (approximately 10 seconds later).



To cancel the self-timer in the middle of the operation

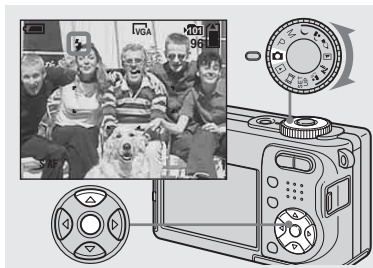

Press  on the control button again. The  indicator disappears from the LCD screen.

- If you press the shutter button while standing in front of the camera, the focus and the exposure may not be correctly set.

Selecting a flash mode



➔ Set the mode dial to , and press  () on the control button repeatedly to select a flash mode.

Each time you press  (), the indicator changes as follows.









No indicator (Auto): The flash automatically strobos when shooting images in a dark place or against a light source. The factory setting is Auto.

 (Forced flash): The flash strobos regardless of the surrounding brightness.

 (Slow synchro): The flash strobos regardless of the surrounding brightness.

The shutter speed is slow in a dark place, so you can clearly shoot the background that is out of flash light.

 (No flash): The flash does not strobe.

- If the menu is currently displayed, press MENU first so that the menu disappears.
- You can also carry out this operation when the mode dial is set to P, M, , , or .
- The recommended shooting distance using the flash is approx. 0.2 m to 3.5 m (7 7/8 inches to 11 feet 5 7/8 inches) (W)/0.3 m to 2.5 m (11 7/8 inches to 8 feet 2 1/2 inches) (T) (When [ISO] is set to [Auto] in the menu settings).
- The flash strobos twice. The first time is the pre-flash which is used to adjust the flash light quantity, and the second time is the actual flash during which the image is recorded.
- You can change the brightness of the flash with  (Flash Level) in the menu settings (page 58). (You cannot change the brightness of the flash while the mode dial is set to .)
- When using the  (Slow synchro) or  (No flash) mode, the shutter speed becomes slower in dark places, so using a tripod is recommended.
- While charging the flash, the  (Flash charge) lamp flashes. After the charging is complete, the lamp goes out.
- This setting is maintained even when the power is turned off.

Shooting images against a light source

In auto adjustment mode, shooting against a light source automatically strobos even when there is enough light around the subject (Daylight synchro).

Before strobed



When strobed



- Daylight synchro may not produce the desired effects depending on shooting conditions.
- When you do not want to use the flash, set the flash mode to  (No flash).

To prevent subjects' eyes from appearing red

Set [Red Eye Reduction] to [On] in the SET UP settings (page 114). The  indicator appears on the LCD screen, and the flash pre-strobes before shooting to reduce the red-eye phenomenon.



- Red-eye reduction may not produce the desired effects depending on individual differences, the distance to the subject, if the subject does not see the pre-strobe, or other conditions.
- When [Red Eye Reduction] is set to [On], the flash is strobed twice or more.



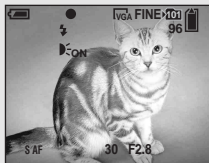

Shooting images with the AF illuminator

The AF illuminator is fill light to focus more easily on a subject in dark surroundings. The  appears on the LCD screen and the AF illuminator emits red light when the shutter button is pressed halfway until the focus is locked.





When this function is not needed, set [AF Illuminator] to [Off] in the SET UP settings (page 114).

- If AF illuminator light does not reach the subject sufficiently or the subject has no contrast, focus will not be achieved. (A distance up to approximately 3.5 m (11 feet 5 7/8 inches) (W)/2.5 m (8 feet 2 1/2 inches) (T) is recommended.)
- Focus is achieved as long as AF illuminator light reaches the subject, even if the light is slightly off the center of the subject.
- When the focus preset distance is set (page 50), the AF illuminator does not function.

- The AF range finder frame does not appear. The  or  indicators flashes, and AF operates with priority on subjects located near the center.
- The AF illuminator does not operate when the mode dial is set to  or .
- The AF illuminator emits very bright light. Although there are no problems with safety, directly looking into the AF illuminator emitter at close range is not recommended.

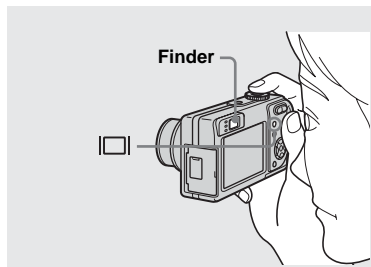
Shooting images with the finder



The finder is convenient when you want to save battery power, or when it is difficult to confirm the image using the LCD screen. Each time you press , the display changes in the following order.

Histogram on

(Image information can also be displayed during playback.)



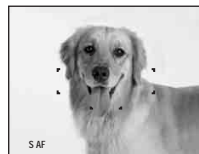

Indicators off



LCD screen off

Indicators on



- The image through the finder does not indicate the actual recordable range. This is due to parallax. To confirm the recordable range, use the LCD screen.
- Just as with the AE/AF lock indicator on the LCD screen, when the AE/AF lock lamp of the finder section stops flashing and remains on, you can start shooting (page 25).
- When the LCD screen is turned off:
 - The digital zoom does not function (page 27).
 - [AF Mode] is set to [Single] (page 49).
 - If you press  (Flash mode)/ (Self-timer)/ (Macro), the image will be displayed on the LCD screen for approximately two seconds so you can check or change the setting.
- When shooting/viewing movies, the status of the LCD screen changes as follows: Indicators off → LCD screen off → Indicators on
- For a detailed description of the indicators, see page 122.
- For a detailed description of the histogram, see page 55.
- This setting is maintained even when the power is turned off.

Inserting the date and time on a still image

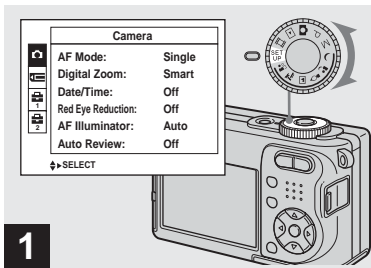

1 → Set the mode dial to SET UP.

The SET UP screen appears.

- The date and time is not inserted in Multi Burst mode.
- When images are shot with the date and time superimposed, the date and time cannot be removed later.
- The date and time do not appear on the LCD screen during shooting, instead, **DATE** indicator appears on the LCD screen. The actual date and time appear in red on the lower-right corner during playback only.

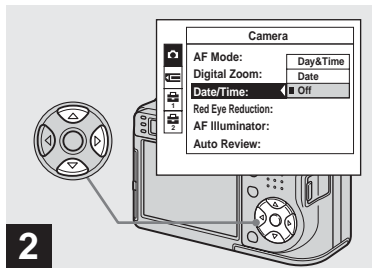

2 → Select (Camera) with ▲ on the control button, then press ►. Select [Date/Time] with ▲/▼, then press ►.

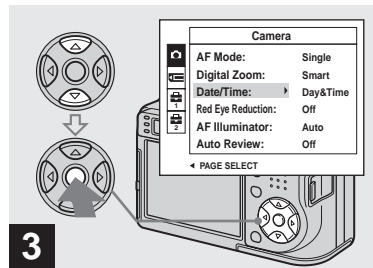







3 → Select the date and time setting with ▲/▼ on the control button, then press ●.

Day&Time: Superimposes the date, hour, and minute onto the image.

Date: Superimposes the year, month and day onto the image.

Off: Does not superimpose the date and time onto the image.

After the setting has been completed, set the mode dial to , and shoot the image.

- You can also shoot with the mode dial set to P, M, , , , , , or .
- If you select [Date], the date is superimposed onto the image in the order selected in “Setting the date and time” (page 18).
- This setting is maintained even when the power is turned off.

Shooting according to scene conditions

You can shoot more effectively by selecting the appropriate mode and then pressing the shutter button.

Twilight mode

Allows you to shoot night scenes at far distance without losing the dark atmosphere of the surroundings. The shutter speed becomes slower, so using a tripod is recommended.



Twilight portrait mode

Suitable for shooting portraits in dark places. Allows you to shoot sharp images of people in dark places without losing the dark atmosphere of the surroundings. The shutter speed becomes slower, so using a tripod is recommended.



Candle mode

You can record parties, candle services and other candlelit scenes without spoiling the candlelit atmosphere. The shutter speed becomes slower, so using a tripod is recommended.



Landscape mode

Focuses only on a distant subject to shoot landscapes, etc.



Beach mode





When shooting seaside or lakeside scenes, the blue of the water is clearly recorded.

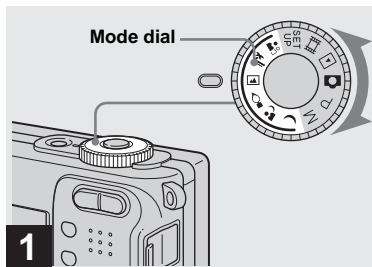

Soft snap mode

This mode lets you shoot skin colors in brighter and warmer tones for more beautiful pictures. In addition, the soft focus effect creates a gentle atmosphere for portraits of people, flowers, etc.





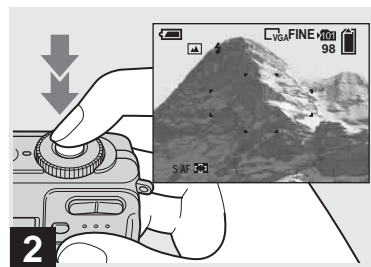











1 → Set the mode dial to , , , , ,  or .



2 → Center the subject in the frame. Press and hold the shutter button halfway down to focus on, then press the shutter button fully down.

Combinations for each mode dial setting

When shooting with the mode dial set to , , , ,  or , the combination of functions such as the flash mode is predetermined to make the optimum settings to match the scene. See the table below.

Function Mode dial	Macro	Flash mode	AF range finder frame	Focus preset	White balance	Burst/Multi Burst
	—		○	∞	○	—
	○	 SL	○	○	Auto	—
	—		Center AF	0.5m/1.0m/ 3.0m/7.0m		—
	—	 /○	○	∞	○	○
	○	 /○	○	○	○	○
	○	○	○	○	○	○

- indicates that the function can be set to your preference.

NR slow shutter

The NR slow shutter function reduces noise from recorded images, providing clear images. When the shutter speed is 1/6 second or slower, the camera automatically activates the NR slow shutter function and “NR” is indicated next to the shutter speed indicator.



Press the shutter button fully down.

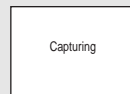

Then the screen turns black.

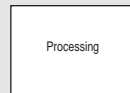

Finally, when “Processing” disappears, the image has been recorded.

- To eliminate the effects of vibration, use of a tripod is recommended.
- When you set a slow shutter speed, the processing may take some time.

Viewing images on the LCD screen of your camera

Single (single-image) screen



Index (nine-image) screen



Index (sixteen-image) screen



You can view images shot with your camera almost immediately on the LCD screen.

You can select the following three methods for viewing images.

Single (single-image) screen

You can view one image at a time, displayed over the entire screen.

Index (nine-image/sixteen-image) screen

Nine or sixteen images are displayed simultaneously in separate panels on the LCD screen.

- For details on viewing movies, see page 78.
- For a detailed description of the indicators, see page 124.

Viewing single images

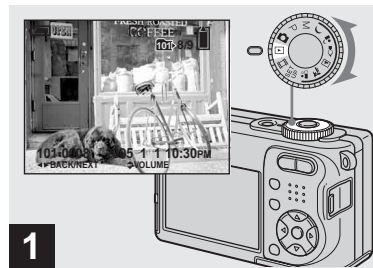

➔ **Set the mode dial to , and turn on the power.**

The last image in the selected recording folder (page 62) appears on the LCD screen.

- The image may appear rough right after playback starts due to the image processing.

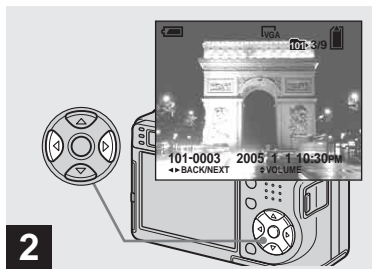

➔ **Select the desired still image with ◀/▶ on the control button.**

- ◀ : To display the preceding image
- ▶ : To display the next image

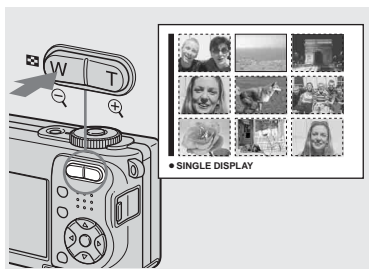

➔ **Press  (index) once.**

The display switches to the **index (nine-image) screen**.

To display the next (previous) index screen

Press ▲/▼/◀/▶ on the control button to move the yellow frame up/down/left/right.

To return the nine-image screen to the single-image screen

Press the zoom T or press ● on the control button once.

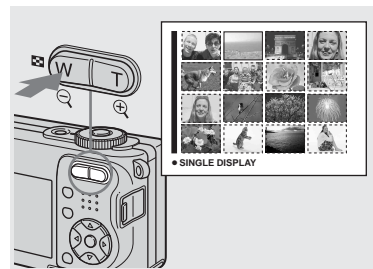

➔ **Press  (index) twice.**

The display switches to the **index (sixteen-image) screen**.

To display the next (previous) index screen

Press ▲/▼/◀/▶ on the control button to move the yellow frame up/down/left/right.

To return the sixteen-image screen to the single-image screen

Press the zoom T or press ● on the control button once.

Viewing images on a TV screen

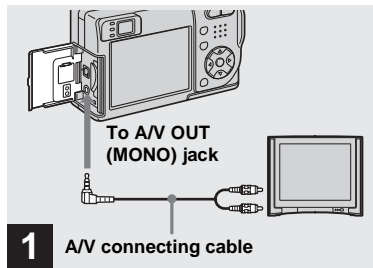

- ➔ **Connect the A/V connecting cable (supplied) to the A/V OUT (MONO) jack of the camera and the audio/video input jacks of the TV.**

If your TV has stereo input jacks, connect the audio plug (black) of the A/V connecting cable to the left audio jack.

- Turn off both your camera and the TV before connecting the camera and the TV with the A/V connecting cable.

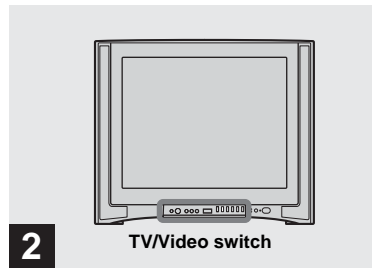

- ➔ **Turn on the TV and set the TV/Video switch to “Video”.**

- The name and location of this switch may differ depending on your TV. For details, see the operating instructions supplied with the TV.

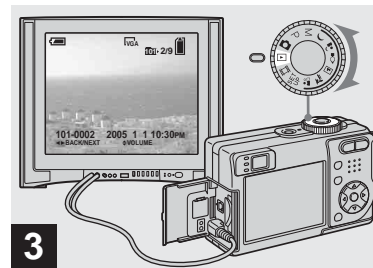

- ➔ **Set the mode dial to , and turn on the camera.**

Press  on the control button to select the desired image.

- When using your camera abroad, it may be necessary to switch the video output signal to match that of your TV system (page 115).

Viewing images on a TV screen

If you want to view images on a TV screen, you need a TV with a video input jack and the A/V connecting cable (supplied).

The color system of the TV must match that of your digital still camera. Check the following lists:

NTSC system

Bahama Islands, Bolivia, Canada, Central America, Chile, Colombia, Ecuador, Jamaica, Japan, Korea, Mexico, Peru, Surinam, Taiwan, the Philippines, the U.S.A., Venezuela, etc.

PAL system

Australia, Austria, Belgium, China, Czech Republic, Denmark, Finland, Germany, Holland, Hong Kong, Hungary, Italy, Kuwait, Malaysia, New Zealand, Norway, Poland, Portugal, Singapore, Slovak Republic, Spain, Sweden, Switzerland, Thailand, United Kingdom, etc.

PAL-M system

Brazil

PAL-N system



Argentina, Paraguay, Uruguay

SECAM system

Bulgaria, France, Guiana, Iran, Iraq, Monaco, Russia, Ukraine, etc.

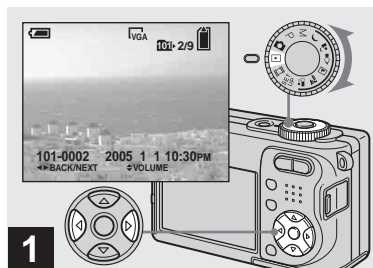
Deleting images



- 1** → Set the mode dial to , and turn on the camera. Press  on the control button to select the image you want to delete.

- Note that you cannot restore deleted images.

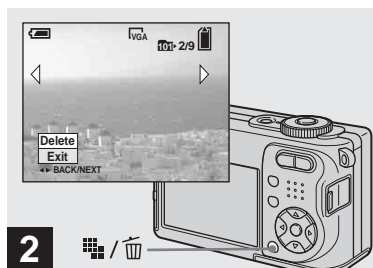



- 2** → Press  (Delete).

The image has not yet been deleted at this point.

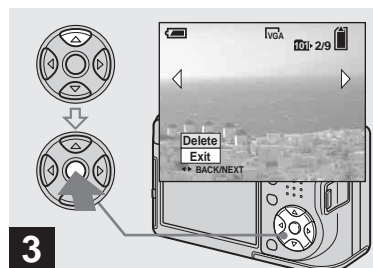

- You cannot delete the protected image (page 67).





- 3** → Select [Delete] with  on the control button, then press .

The message “Access” appears, and the image has been deleted.

To continue and delete other images



Display the image to be deleted with  on the control button. Then, select [Delete] with  and press .

To cancel deleting

Select [Exit] with  on the control button, then press .

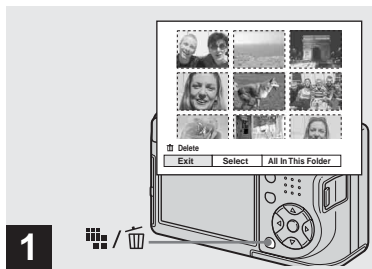

Deleting images in index (nine-image/sixteen-image) mode

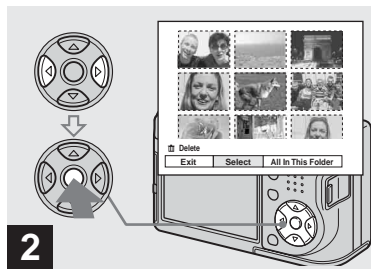

→ While an index (nine-image/sixteen-image) screen (page 38) is displayed, press  /  (Delete).

- Note that you cannot restore deleted images.



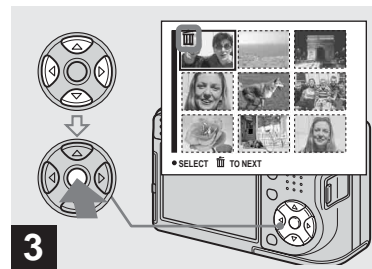

→ Select [Select] with  /  on the control button, then press .





→ Select an image you want to delete with  /  /  /  on the control button, then press .

The  (Delete) indicator appears on the selected image. At this point, the image has not yet been deleted. Repeat this step for all of the images you want to delete.

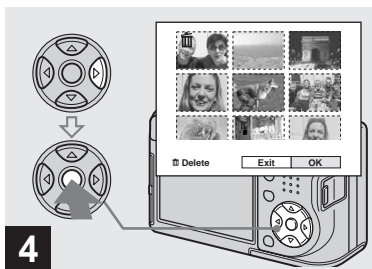
- To cancel a selection, select the image, then press  on the control button again so that the  indicator disappears.





4





→ Press  (Delete) and select [OK] with  on the control button, then press .

The message “Access” appears, and the images with the  indicator have been deleted.

To cancel deleting

Select [Exit] with  on the control button, then press .

To delete all the images in the folder

Select [All In This Folder] with  on the control button in step 2, then press . Select [OK], then press . All of the unprotected images in the folder are deleted. To cancel deleting, select [Cancel], then press .

Formatting a “Memory Stick”

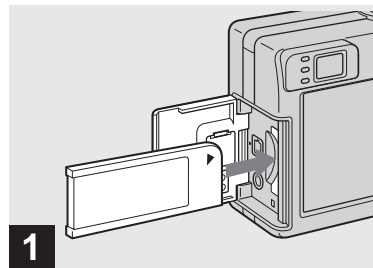

1

→ Insert the “Memory Stick” you want to format into the camera.

- The term “formatting” means preparing a “Memory Stick” to record images; this process is also called “initialization.”
- The “Memory Stick” supplied with your camera and commercially available “Memory Stick” are already formatted, and can be used immediately.
- **When you format a “Memory Stick,” be aware that all data in the “Memory Stick” will be permanently erased. Protected images are also erased.**

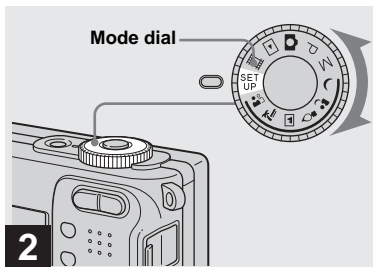

→ Set the mode dial to SET UP, and turn on the power.

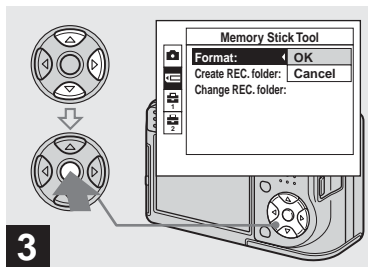

→ Select **Memory Stick Tool** with ▲/▼ on the control button. Select [Format] with ►, then press ►. Select [OK] with ▲, then press ●.

To cancel the formatting

Select [Cancel] with ▼ on the control button, then press ●.

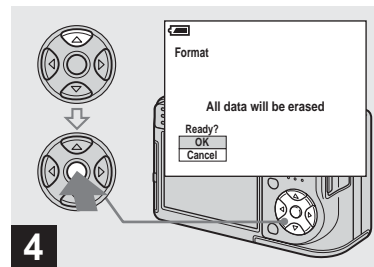

→ Select [OK] with ▲ on the control button, then press ●.

The message "Formatting" appears. When this message disappears, the format is complete.

How to setup and operate your camera

The usage of the menus and SET UP screen items is described below.

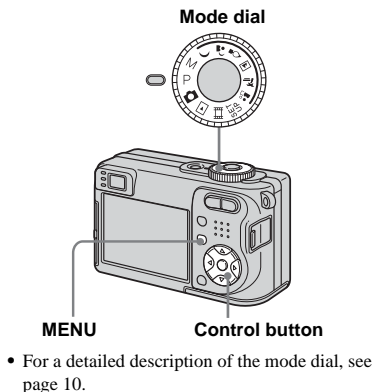

Changing the menu settings

1 Set the mode dial to , P, M, , , , , , or .

2 Press MENU.

The menu appears.

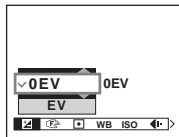

- The displayed items differ according to the mode dial position.

3 Press / on the control button to select the item you want to set.

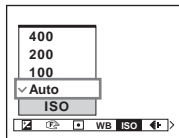

- When the mode dial is set to , press on the control button after selecting the item.

4 Press / on the control button to select the desired setting.

The selected setting is enlarged and the setting is entered.

When the mark appears at the top or the mark appears at the bottom of an item

There are items that are not displayed on the screen. Press / on the control button to display these items.

To turn off the menu display

Press MENU again.

- You cannot select items displayed in gray.
- For a detailed description of the menu items, see page 110.

Changing the items in the SET UP screen

1 Set the mode dial to SET UP.

The SET UP screen appears.

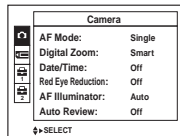

2 Press ▲/▼/◀/▶ on the control button to select the item you want to set.

The frame of the selected item turns yellow.

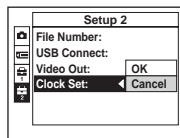

3 Press ● on the control button to enter the setting.

To turn off the SET UP screen display

Set the mode dial to anything other than SET UP.

- For a detailed description of the SET UP items, see page 114.

Deciding the still image quality

You can select the still image quality from [Fine] (high quality) or [Standard].

Mode dial

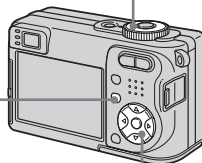
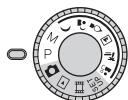

MENU

Control button

1 Set the mode dial to P, M, , , , or .

2 Press MENU.

The menu appears.

3 Select (P. Quality) with ◀/▶, then select the desired image quality with ▲/▼.

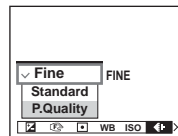

Creating or selecting a folder

Your camera can create multiple folders within a “Memory Stick.” You can select the folder used to store images.

When not creating a new folder, “101MSDCF” folder is selected as the recording folder.

You can create folders up to “999MSDCF.”

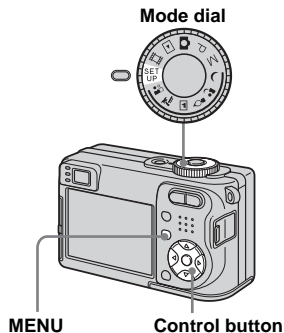

- Up to 4,000 images can be stored in one folder. When the folder capacity is exceeded, a new folder is automatically created.

Creating a new folder

- 1** Set the mode dial to SET UP.
- 2** Select (Memory Stick Tool) with $\blacktriangle/\blacktriangledown$, [Create REC. Folder] with $\blacktriangleright/\blacktriangleleft/\blacktriangledown$, and [OK] with $\blacktriangleright/\blacktriangleleft$, then press \bullet .

The creating folder screen appears.

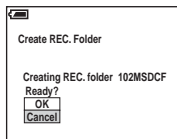

- 3** Select [OK] with \blacktriangle , then press \bullet .

A new folder is created with a number one higher than the largest number in the “Memory Stick,” and the folder becomes the recording folder.

To cancel folder creation

Select [Cancel] in step **2** or **3**.

- Once you create a new folder, you cannot delete the new folder with the camera.
- Images are recorded in the newly created folder until a different folder is created or selected.

Changing the recording folder

- 1** Set the mode dial to SET UP.
- 2** Select (Memory Stick Tool) with $\blacktriangle/\blacktriangledown$, [Change REC. Folder] with $\blacktriangleright/\blacktriangledown$, and [OK] with $\blacktriangleright/\blacktriangleleft$, then press \bullet .

The recording folder selection screen appears.

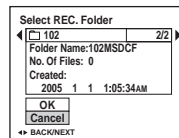

- 3** Select the desired folder with $\blacktriangleleft/\blacktriangleright$, and [OK] with \blacktriangle , then press \bullet .

To cancel changing the recording folder

Select [Cancel] in step **2** or **3**.

- You cannot select the “100MSDCF” folder as a recording folder (page 87).
- The image is stored in the newly selected folder. You cannot move recorded images to a different folder with this camera.

Choosing an auto focus method

You can set the AF range finder frame and the AF mode.

AF range finder frame

This selects the focus position according to the subject position and size.

AF mode

This sets the focus operation start and stop timing.

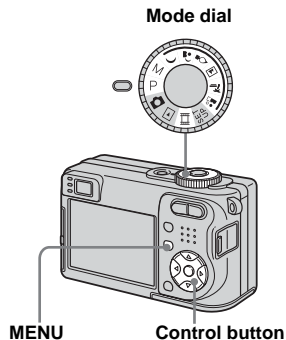

Choosing a focus range finder frame

— AF range finder

Multipoint AF (AF)

The camera calculates the distance in five areas to the left, right, top, bottom and in the center of the image, letting you shoot using the auto focus function without worrying about the image composition. This mode is useful when it is difficult to focus on the subject because it is not in the center of the frame. You can check the position where the focus was adjusted using the green frame.

The factory setting is the Multipoint AF.



Center AF (AF)

This mode is useful for focusing on a subject near the center of the frame. Use together with the AF lock function lets you shoot in the desired image composition.

- 1 Set the mode dial to P, M, , , , ,  or .

- 2 Press MENU.

The menu appears.

- 3 Select  (Focus) with / , then select [Multi AF] or [Center AF] with / .

The focus is adjusted automatically. The color of the AF range finder frame changes from white to green.

Multipoint AF



AF range finder frame

AF range finder frame indicator



Center AF



AF range finder frame

AF range finder frame indicator

- When you are shooting movies and you choose Multipoint AF, the distance to the center of the screen is estimated as an average, so the AF works even with a certain amount of vibration. The AF range finder frame is . Center AF automatically focuses only on selected frame, so this is convenient when you want to focus only on what you aim at.

- When you use the digital zoom or AF illuminator, priority AF movement is given to subjects in or near the center of the frame. In this case the  or  indicator flashes and the AF range finder frame is not displayed.
- The AF range finder frame selection is limited according to the mode dial setting (page 36).

Choosing a focus operation

— AF Mode

Single AF (S AF)

This mode is useful for shooting stationary subjects. The focus is not adjusted before the shutter button is pressed and held halfway down. When the shutter button is pressed and held halfway down and AF lock is complete, the focus is locked. The factory setting is Single AF.

Monitoring AF (M AF)

This mode shortens the time needed for focusing. The camera automatically adjusts the focus before the shutter button is pressed and held halfway down, letting you compose images with the focus already adjusted. When the shutter button is pressed and held halfway down and AF lock is complete, the focus is locked.



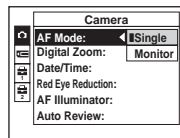

- Battery consumption may be faster than in Single AF mode.

1 Set the mode dial to SET UP.

2 Select  (Camera) with \blacktriangle , [AF Mode] with $\blacktriangleright/\blacktriangle$, and select the desired mode with $\blacktriangleright/\blacktriangle/\blacktriangledown$, then press \bullet .



- When shooting using the finder with the LCD screen off, the camera operates in Single AF mode.

- 3** Select  (Focus) with / , then select the distance to the subject with / .

You can select from the following distance settings.

0.5m, 1.0m, 3.0m, 7.0m, ∞ (unlimited distance)

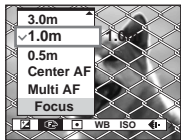

To return to auto focus mode

In step **3**, select [Multi AF] or [Center AF].

- Focus setting information is approximate, and should be used as a reference.
- If you point the lens up or down, the error increases.
- The distance selection is limited according to the mode dial setting (page 36).

Shooting with manual shutter speed and aperture settings

— Manual Exposure

You can manually adjust the shutter speed and aperture values.

The difference between the set values and the appropriate exposure determined by the camera is displayed on the LCD screen as the EV value (page 54). 0EV indicates the value judged as most suitable by the camera.

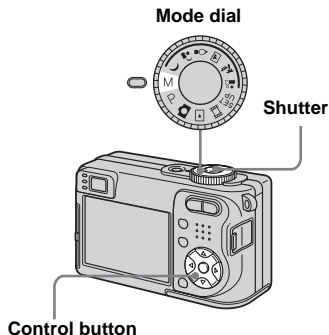

- 1** Set the mode dial to M.

- 2** Press .

The “Set” indicator at the lower left of the LCD screen changes to “Return”, and the camera enters the manual exposure setup mode.

- 3** Select a shutter speed with / .

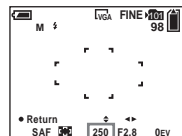

The shutter speed can be selected from 1/1000 to 30 seconds.

If you select 1/6 second or slower shutter speeds, “NR” appears before the shutter speed indicator and the NR slow shutter function is automatically activated (page 36).

4 Select an aperture value with



Two different aperture values can be selected, depending on the zoom position.

When the zoom is set all the way to the W side: F2.8/F5.6

When the zoom is set all the way to the T side: F5.2/F10

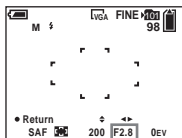

- Shutter speeds of one second or longer are indicated by ["] in the manner of 1".
- If the proper exposure cannot be obtained after making the settings, the EV value on the LCD screen flashes when you press the shutter button halfway down. You can continue and shoot in this condition, but we recommend that you adjust the settings again.
- The flash is set to (Forced flash) or (No flash).

5 Shoot the image.

To use the Quick Review, close-ups (Macro) or self-timer function, or to change the flash mode

After step 4, press to cancel the manual exposure setup mode. The “Return” indicator changes to “Set”.

To cancel the manual exposure mode

Set the mode dial to other than M.

Exposure

In addition to the focus and other settings, it is also important to adjust the exposure in order to take beautiful pictures.

Exposure is the amount of light that the CCD of the digital still camera is able to receive. This value changes according to the combination of the aperture and the shutter speed. When the amount of light is too large, the image becomes brighter (white), and when the amount of light is too small, the image becomes darker. The proper amount of light is called the “correct exposure”.

The correct exposure can be maintained by setting a faster shutter speed when the aperture value is reduced, or a slower shutter speed when the aperture value is increased from the correct exposure.

Adjustment by aperture

Aperture is the diaphragm of the lens part which adjusts the amount of light entering the camera. The aperture setting value is called the “Aperture value (F value)”.

Open (smaller F value)

- The image tends toward overexposure (brighter).
- The in-focus range narrows.



Close (larger F value)

- The image tends toward underexposure (darker).
- The in-focus range widens.



Adjustment by shutter speed

Shutter speed adjusts the time during which light enters the camera.

Faster

- The image tends toward underexposure (darker).
- Moving objects appear stopped.



Slower

- The image tends toward overexposure (brighter).
- Moving objects appear to flow.



When setting a slower shutter speed, we recommend using a tripod to prevent shaking.

Overexposure

- Open the aperture
- Set a slower shutter speed



Correct exposure



Underexposure

- Close the aperture
- Set a faster shutter speed





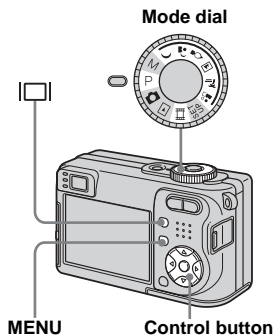
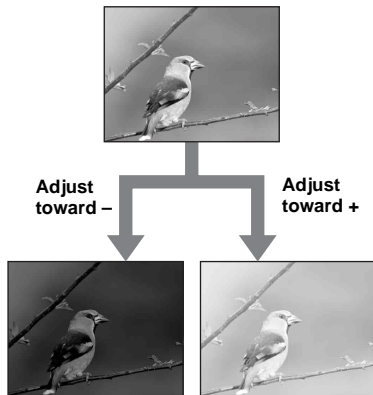

Adjusting the exposure

— EV adjustment

You can manually adjust the exposure determined by the camera. Use this mode when the proper exposure cannot be obtained, for example, when the contrast (difference between light and dark) between the subject and the background is extremely large.

The compensation value can be set in 1/3EV steps in the range from +2.0EV to -2.0EV.



1 Set the mode dial to P, , , , ,  or .

2 Press MENU.

The menu appears.

3 Select  (EV) with .

The value of the exposure adjustment is displayed.



4 Select the desired exposure value with /.

Adjust the exposure value while checking the brightness of the background.

To reactivate auto exposure

In step **4**, select [0EV].





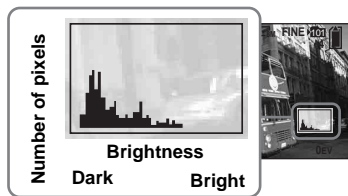

- If a subject is being shot in extremely bright or dark conditions, or the flash is used, the exposure adjustment may not be effective.

Displaying a histogram



A histogram is a graph showing the brightness of an image. The horizontal axis shows the brightness, and the vertical axis shows the number of pixels. The graph display indicates a bright image when skewed to the right side, a dark image when skewed to the left side.

A histogram can be used to check the exposure when the screen is difficult to see during recording and playback.



- 1** Set the mode dial to P, , , , ,  or .
- 2** Press  to display the histogram.
- 3** Adjust the exposure based on the histogram.

- The histogram also appears when the mode dial is set to  or M, but you cannot adjust the exposure.

- The histogram also appears when you press  while playing back a single image (page 37) or during Quick Review (page 26).
- The histogram does not appear in the following cases:
 - When the menu is displayed
 - When using playback zoom
 - When recording or playing back movies
-  appears and the histogram does not appear in the following cases:
 - When recording in the digital zoom area
 - When the image size is [3:2]
 - When playing back Multi Burst images
 - When rotating a still image
- The histogram before recording represents the histogram of the image displayed on the LCD screen at the time. A difference occurs in the histogram before and after you press the shutter button. In this case, check the histogram while playing back a single-image or during Quick Review.
In particular a large difference may appear in the following cases:
 - When the flash strobes
 - When the shutter speed is slow or high
- The histogram may not appear for images recorded using other cameras.

Shooting techniques

When shooting images, the camera automatically sets the exposure.

When shooting a whitish overall image such as a backlit subject or a snowy scene, the camera may judge that the subject is bright and set a darker exposure for the image. In such cases, adjusting the exposure in the + (plus) direction is effective.



Adjust in the + direction



When shooting a dark subject that fills the frame, the camera may judge that the subject is dark and set a brighter exposure for the image. In such cases, adjusting the exposure in the - (minus) direction is effective.



Adjust in the - direction



Refer to the histogram and adjust so that the image is not overexposed (white out) or underexposed (black out).

Try various images with different exposures to find the brightness that suits your taste.

Selecting the metering method

You can select the metering mode that sets which part of the subject to measure to determine the exposure.

Multi-pattern metering (No indicator)

The image is divided into multiple regions and metering is performed for each region. The camera judges the subject position and background brightness, and determines a well-balanced exposure.

The factory setting is the multi-pattern metering.

Spot metering (☐)

Metering is performed for only a part of the subject. This lets you shoot images that are not too dark even when the subject is backlit, or adjust the exposure to the subject when there is strong contrast between the subject and the background.

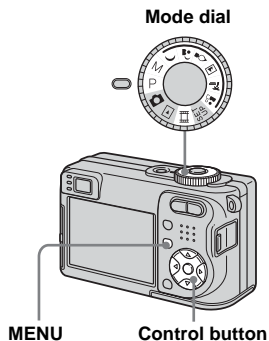

MENU



Control button

1 Set the mode dial to P, M, ,



2 Press MENU.

The menu appears.

3 Select  (Metering Mode) with /▶, then select the desired metering mode with ▲/▼.

4 When selecting [Spot] in step **3**, position the spot metering cross hair on one point of the subject you want to shoot.

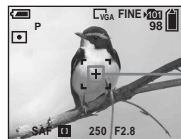

Spot metering cross hair

- When using spot metering, to focus on the metering position, setting  (Focus) to [Center AF] is recommended (page 48).

Adjusting color tones

— White Balance

You can set the white balance mode according to your shooting conditions. The apparent color of the subject is affected by the lighting conditions. When you want to fix the light source imaging conditions, or when the color of the entire image seems to be a bit unnatural, we recommend that you adjust the white balance setting.

Auto (No indicator)

Adjusts the white balance automatically. The factory setting is Auto.

(Daylight)

Shooting outdoors, shooting night scenes, neon signs, fireworks or sunrise, or shooting just before and after sundown

(Cloudy)

Shooting under a cloudy sky

(Fluorescent)

Shooting under fluorescent lighting

(Incandescent)

- Places where the lighting conditions change quickly
- Under bright lighting such as photography studios

Mode dial

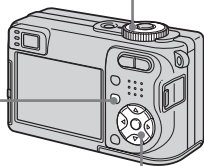
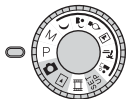

MENU



Control button

1 Set the mode dial to P, M, ,

, , , ,  or .

2 Press MENU.

The menu appears.

3 Select [WB] (White Bal) with , then select the desired setting with /.

To reactivate auto adjustment

Select [Auto] in step **3**.

- Under fluorescent lights that flicker, the white balance adjustment function may not work correctly even though you select  (Fluorescent).
- When the flash strobos, the manual setting is canceled, and the image is recorded in [Auto].
- Some of the white balance settings are restricted based on the position of mode dial (page 36).

Adjusting the flash level

— Flash Level

You can adjust the amount of flash light.

Mode dial

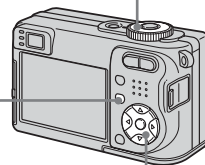
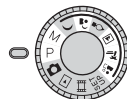

MENU

Control button

1 Set the mode dial to P, M, ,

,  or .

2 Press MENU.

The menu appears.

- 3** Select [\pm] (Flash Level) with $\blacktriangleleft/\blacktriangleright$, then select the desired setting with $\blacktriangle/\blacktriangledown$.

+: Makes the flash level higher than normal.

Normal: Normal setting.

-: Makes the flash level lower than normal.

Shooting continuously

This mode is used for continuous shooting. The maximum number of images you can shoot per one shooting depends on the image size and image quality settings.

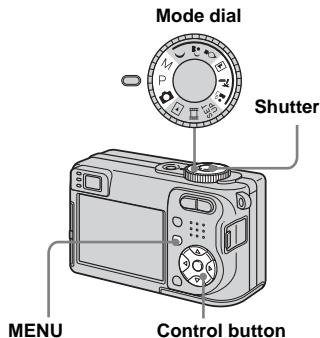

- When the battery power decreases with use or the capacity of the “Memory Stick” is full, recording stops even if you press and hold the shutter button.

- 1** Set the mode dial to M , P , M ,



- 2** Press MENU.

The menu appears.

- 3** Select [Mode] (REC Mode) with $\blacktriangleleft/\blacktriangleright$, then select [Burst] with $\blacktriangle/\blacktriangledown$.

- 4** Shoot the image.

When you press and hold down the shutter button, the camera records the maximum number of images in succession. If you release the shutter button, shooting will stop at that point. When “Recording” disappears, you can shoot the next image.

The maximum number of images shot continuously (Units: images)

Image quality \ Image size	Fine	Standard
5M	9	15
3:2	9	15
3M	13	24
1M	32	59
VGA (E-Mail)	100	100

To return to normal mode

Select [Normal] in step **3**.

- The flash is set to No flash .
- When recording with the self timer, a series of maximum five images are recorded each time you press the shutter button.
- When the mode dial is set to M, you cannot select shutter speeds of 1/6 second or slower.

Shooting in Multi Burst mode

— Multi Burst

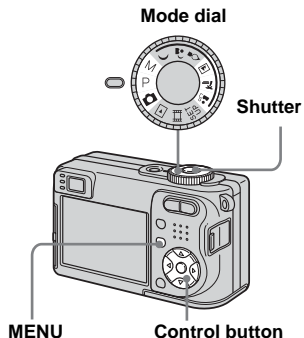

This mode records 16 frames in succession each time you press the shutter button. This is convenient for checking your form in sports, for example.





1 Set the mode dial to , P, M, ,  or .

2 Press MENU.

The menu appears.

3 Select [Mode] (REC Mode) with , then select [Multi Burst] with .

4 Select  (Interval) with , then select the desired frame interval with .

You can choose the frame interval from [1/7.5], [1/15] or [1/30].

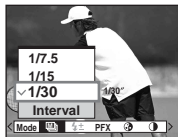

5 Shoot the image.

A continuous burst of 16 frames are recorded within a single still image (image size 1M).

- You cannot use the following functions in Multi Burst mode:
 - Smart zoom
 - Flash
 - Inserting the date and time
- When the mode dial is set to , frame interval is automatically set to [1/30].
- When the mode dial is set to M, you cannot set the shutter speed to lower than 1/30 second.
- See page 65 to play back images recorded in Multi Burst mode using this camera.
- For the number of images that can be recorded in Multi Burst mode, see page 109.

Shooting with special effects

— Picture Effect

You can digitally process images to obtain special effects.

B&W











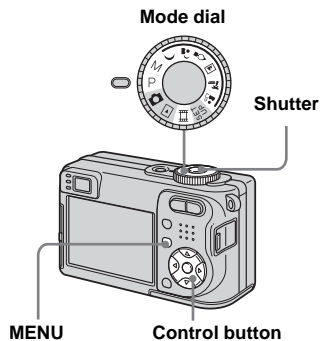

The picture is monochrome (black and white).

Sepia



The picture is sepia-toned like an old photograph.



- 1** Set the mode dial to P, M, , , , , ,  or .
- 2** Press MENU.
The menu appears.
- 3** Select [PFX] (P. Effect) with , then select the desired mode with /.
- 4** Shoot the image.

To cancel Picture Effects

Select [Off] in step **3**.

Selecting the folder and playing back images

— Folder

Select the folder that images you want to play back are stored.

Mode dial

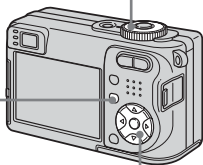
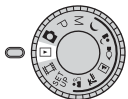

MENU

Control button

1 Set the mode dial to .

2 Press MENU.

The menu appears.

3 Select (Folder) with , then press .

4 Select the desired folder with .

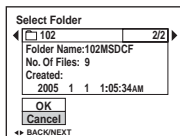

5 Select [OK] with , then press .



To cancel the selection

In step **5**, select [Cancel].

When multiple folders are created in the “Memory Stick”

When the first or last image in the folder is displayed, the following indicators appear on the screen.

: Moves to the previous folder.

: Moves to the next folder.

: Moves to both the previous and next folders.

Single screen



Index (nine-image) screen



Index (sixteen-image) screen







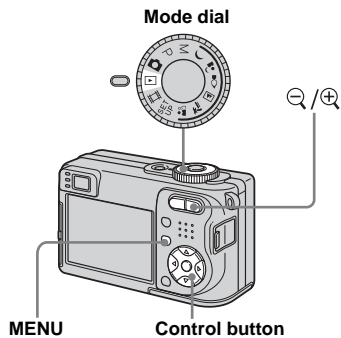

- When no images are stored in the folder, “No file in this folder” appears.

Enlarging a portion of a still image

You can enlarge a part of an image up to five times the original size. You can also record the magnified image as a new file.



Enlarging an image — Playback zoom

- 1** Set the mode dial to .
- 2** Display the image to be enlarged with .
- 3** Press  (playback zoom) to zoom in on the image.
- 4** Select the desired portion of the image with / / / .



- ▲: To view more of the top of the image
- ▼: To view more of the bottom of the image
- ◀: To view more of the left side of the image
- ▶: To view more of the right side of the image

- 5** Adjust the image size with the /  (playback zoom) button.



To cancel playback zoom

Press .

- You cannot use playback zoom for movies and Multi Burst images.
- If you press  (playback zoom) while a non-enlarged image is displayed, the LCD screen switches to the index screen (page 38).
- You can enlarge the images displayed with the Quick Review function (page 26) by performing steps **3** to **5**.

Recording an enlarged image — **Trimming**

1 Press MENU after playback zoom.

The menu appears.

2 Select [Trimming] with **▶**, then press **●**.

3 Select the image size with **▲/▼**, then press **●**.

The image is recorded, and the image on the LCD screen returns to the normal size after recording.

- The trimmed image is recorded as the newest file in the selected recording folder, and the original image is retained.
- The quality of trimmed images may deteriorate.
- You cannot trim to an image size of 3:2.
- You cannot trim images displayed with Quick Review.

Playing back successive images

— Slide Show

You can play back recorded images in order. This function is useful for checking your images or for presentations, etc.

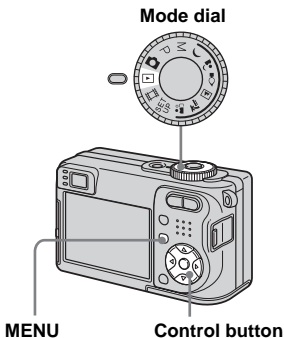

1 Set the mode dial to **▶**.

2 Press MENU.

The menu appears.

3 Select **▢** (Slide) with **◀/▶**, then press **●**.

Set the following items with **▲/▼/◀/▶**.

Interval

3 sec/5 sec/10 sec/30 sec/1 min

Image

Folder: Plays back all images in the selected folder.

All: Plays back all images stored in the “Memory Stick.”

Repeat

On: Plays back images in a continuous loop.

Off: After all the images have been played back, the slide show ends.

4 Select [Start] with **▼/▶**, then press **●**.

The slide show begins.

To cancel the slide show setting

Select [Cancel] in step **3**.

To stop slide show playback

Press **●**, select [Exit] with **▶**, then press **●** again.

To skip to the next/previous image during the slide show

Press **▶** (next) or **◀** (previous).

- The interval settings time are just guidelines, so it may vary depending on the image.

Rotating still images

— Rotate

You can rotate an image recorded in portrait orientation and display it in landscape orientation.



Mode dial

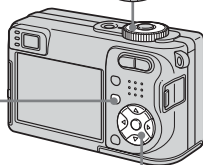
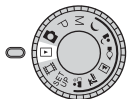





MENU





Control button



1 Set the mode dial to , and display the image to rotate.

2 Press MENU.

The menu appears.

3 Select  (Rotate) with / , then press .

4 Select  with , then rotate the image with / .

5 Select [OK] with / , then press .

To cancel rotation

Select [Cancel] in step **4** or **5**, then press .

- You cannot rotate protected images and movies and Multi Burst images.
- You may not be able to rotate images shot with other cameras.
- When viewing images on a computer, the image rotation information may not be reflected depending on the application software.

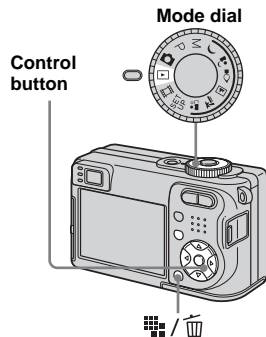

Playing back images shot in Multi Burst mode

You can play back Multi Burst images continuously or play them back frame by frame. This function is used for checking the image.



- When Multi Burst images are played back on a computer or on a camera without the Multi Burst function, the 16 frames you shot will be displayed at the same time as part of one image.
- You cannot cut the Multi Burst image.



Playing back continuously

- 1 Set the mode dial to .
- 2 Select the Multi Burst image with / .

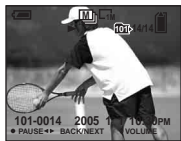



The selected Multi Burst image is played back continuously.



To pause playback

Press . To resume playback, press  again. The playback starts from the frame displayed on the LCD screen.



Playing back frame by frame



- 1 Set the mode dial to .
- 2 Select the Multi Burst image with / .
- 3 Press  when the desired frame is displayed.

“Step” appears.



- 4 Advance the frame with / .

: A next frame is displayed. When you keep and press , the frame advances.



: A previous frame is displayed. When you keep and press , the frame advances in the reverse direction.

To return to the normal playback

Press  in step **4**. The playback starts from the frame displayed on the LCD screen.

To delete shot images

When using this mode, you cannot delete only certain frames. When you delete images, all 16 of the frames are deleted at the same time.

- 1 Display the desired Multi Burst image to delete.
- 2 Press  /  (Delete).
- 3 Select [Delete], then press . All of the frames are deleted.

Protecting images



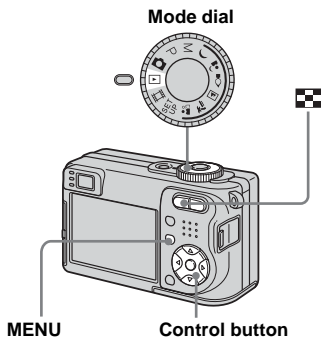

— Protect

This function protects images against accidental erasure.





- Note that formatting the "Memory Stick" erases all the data in the "Memory Stick" even if images are protected, and these images cannot be recovered.
- It may take some time to protect the images.

In single-image mode



- 1** Set the mode dial to .
- 2** Display the image you want to protect with .
- 3** Press MENU.
The menu appears.
- 4** Select  (Protect) with , then press .

The displayed image is protected. The  (protect) indicator appears on the image.





- 5** To continue and protect other images, select the desired image with , then press .







To cancel the protection

Press  again in step **4** or **5**. The  indicator disappears.

*In index (nine-image/
sixteen-image) mode*

- 1** Set the mode dial to , then press  (index) to display the index (nine-image) screen.

Press  (index) twice to display a sixteen-image index screen.

- 2** Press MENU.
The menu appears.
- 3** Select  (Protect) with , then press .
- 4** Select [Select] with , then press .
- 5** Select the image you want to protect with , then press .

The green  indicator appears on the selected image.



- 6** Repeat step **5** to protect other images.
- 7** Press MENU.

- 8** Select [OK] with **▶**, then press **●**.

The **☞** indicator turns white. The selected images are protected.

To exit the Protect function

Select [Cancel] in step **4** or select [Exit] in step **8**, then press **●**.

To cancel individual protection

Select the image to be unprotected with **▲/▼/◀/▶** in step **5**, then press **●**. The **☞** indicator turns gray. Repeat this operation for all images that are to be unprotected. Press MENU, select [OK], and then press **●**.

To protect all images in the folder

Select [All In This Folder] in step **4**, and press **●**. Select [On], then press **●**.

To cancel protection of all images in the folder

Select [All In This Folder] in step **4**, and press **●**. Select [Off], then press **●**.

Changing image size

— Resize

You can change the image size of a recorded image, and save it as a new file. You can resize to the following sizes: 5M, 3M, 1M, VGA

The original image is retained even after resizing.

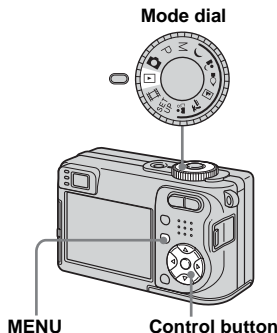

- 1** Set the mode dial to **▶**.
- 2** Display the image you want to resize with **◀/▶**.
- 3** Press MENU.
The menu appears.
- 4** Select **☞** (Resize) with **◀/▶**, then press **●**.

- 5** Select the desired size with **▲/▼**, then press **●**.

The resized image is recorded in the recording folder as the newest file.

To cancel resizing

Select [Cancel] in step **5**.

- You cannot change the size of movies or Multi Burst images.
- When you change from a small size to a large size, the image quality deteriorates.
- You cannot resize to an image size of 3:2.
- When you resize a 3:2 image, the upper and lower black portions will be displayed on the image.

Choosing images to print





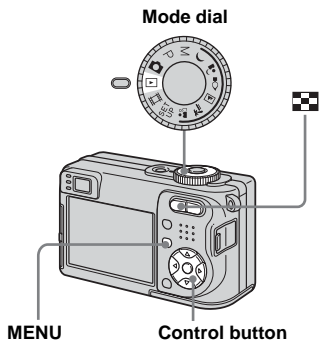

— Print (DPOF) mark

You can mark still images shot with your camera that you want to have printed. This function is convenient when you have images printed at a shop or using a printer that conforms with the DPOF (Digital Print Order Format) standard or a PictBridge compliant printer.





- You cannot mark movies.
- When you mark images shot in Multi Burst mode, all the images are printed on one sheet divided into 16 panels.
- You cannot set the number of prints.

In single-image mode



- 1** Set the mode dial to .
- 2** Display the image you want to mark with /.
- 3** Press MENU.
The menu appears.
- 4** Select DPOF (DPOF) with /, then press .

The  mark is marked on the displayed image.





- 5** To continue and mark other images, display the desired image with /, then press .









To unmark the mark

Press  again in step **4** or **5**. The  mark disappears.

In index (nine-image/ sixteen-image) mode

- 1** Set the mode dial to , then press  (index) to display the index (nine-image) screen.

Press  (index) twice to display a sixteen-image index screen.

- 2** Press MENU.
The menu appears.
- 3** Select DPOF (DPOF) with , then press .
- 4** Select [Select] with , then press .
- You cannot mark the  mark in [All In This Folder].
- 5** Select the image you want to mark with //, then press .



The green  mark appears on the selected image.



6 Repeat step **5** to mark other images.

7 Press MENU.

8 Select [OK] with ►, then press ●.

The  mark turns white. The  mark setting is completed.

To unmark marks

Select the images to be unmarked with ▲/▼/◀/▶ in step **5**, then press ●.

To unmark all the marks in the folder

Select [All In This Folder] in step **4**, then press ●. Select [Off], then press ●.

To exit the mark function

Select [Cancel] in step **4** or select [Exit] in step **8**.

Connecting to a PictBridge compliant printer

Even if you do not have a computer, you can easily print images shot using your camera by connecting the camera to a PictBridge compliant printer. For preparation, you only set the USB connection on the SET UP screen and connect the camera to the printer with the USB cable.

Using a PictBridge compliant printer easily prints the index print*.

PictBridge

* An index print function may not be provided depending on a printer.

- We recommend that you use the fully charged Nickel-Metal Hydride batteries or the AC Adaptor (not supplied) is recommended to prevent the power from turning off partway through printing.

Preparing the camera

Set the USB mode on the camera to connect the camera with a printer.

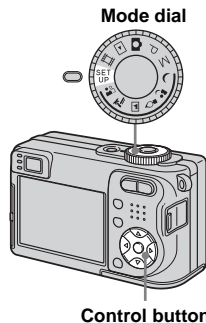

- 1** Set the mode dial to SET UP.
- 2** Select  (Setup 2) with \blacktriangledown , then select [USB Connect] with $\blacktriangle/\blacktriangledown/\blacktriangleright$.
- 3** Select [PictBridge] with $\blacktriangleright/\blacktriangle$, then press \bullet .

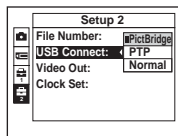

The USB mode is set.

Connecting the camera to the printer

Connect the Ψ (USB) jack on your camera and the USB jack on the printer with the supplied USB cable, then turn on your camera and the printer.

The camera turns to playback mode regardless of the mode dial position and an image in the selected playback folder appears on the LCD screen.

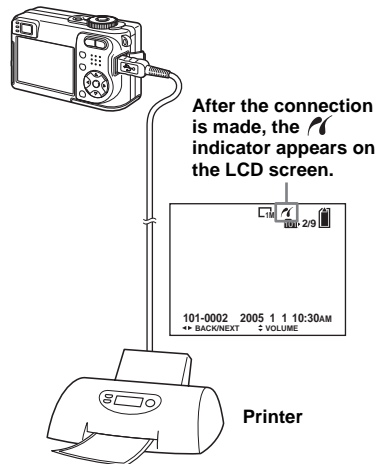



When [USB Connect] is not set to [PictBridge] in the SET UP settings

Even if you turn on the camera, you cannot use the PictBridge function. Disconnect the USB cable and set [USB Connect] to [PictBridge] (page 71).



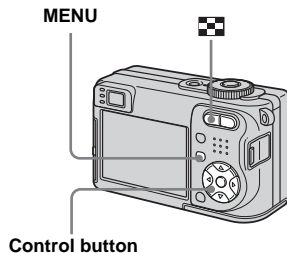





Printing images

You can select the image and print it. Set up the camera following the procedure on page 71, and connect the printer.





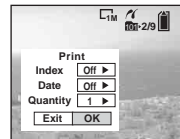

- You cannot print movies.
- When an error notification is received from the connected printer, the  indicator flashes for approximately five seconds. Check the connected printer.

In single-image mode

- 1** Display the image you want to print with  .
 - 2** Press MENU.
The menu appears.
 - 3** Select  (Print) with  , then press .
 - 4** Select [This image] with  , then press .
- The print setting screen appears.



- Setting items that the printer does not support cannot be displayed.
- 5** Select [Quantity] with  , select the number of sheets with  .
- You can select the number up to 20.

6 Select [OK] with ▼/►, then press ●.

The image is printed.

Do not disconnect the USB cable while the  (Not disconnect USB cable) indicator appears on the LCD screen.



To cancel printing

Select [Cancel] in step **4** or select [Exit] in step **6**.

To print other images

Select the image after step **6**, then select [Print] with ▲.

To print all the images with the print (DPOF) mark

Select [DPOF image] in step **4**. All the images with the  mark are printed by the specified number regardless of the displayed image.

To insert the date and time on images

Select [Date] in step **5**, then select the date format with ◀/▶. You can select from [Day&Time] or [Date]. When you choose [Date], the date will be inserted in the order set in “Setting the date and time” (page 18). This function may not be provided depending on a printer.

*In index (nine-image/
sixteen-image) mode*

1 Press  (index) to display the index (nine-image) screen.

Press  (index) twice to display a sixteen-image index screen.

2 Press MENU.

The menu appears.

3 Select  (Print) with ►, then press ●.

4 Select [Select] with ◀/►, then press ●.

5 Select the image you want to print with ▲/▼/◀/▶, then press ●.

The ✓ mark appears on the selected image.



6 Repeat step 5 to print other images.



7 Press MENU.

The print setting screen appears.

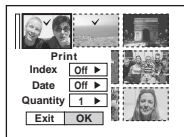

- Setting items that the printer does not support cannot be displayed.

8 Select [Quantity] with ▲/▼, select the number of sheets with ◀/▶.

You can select the number up to 20. The specified quantity of all the selected images are printed.

9 Select [OK] with ▼/▶, then press ●.

The images are printed. Do not disconnect the USB cable while the  indicator appears on the LCD screen.

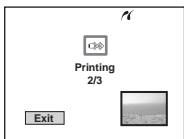

To cancel printing

Select [Cancel] in step 4 or select [Exit] in step 9.

To print all the images with the print (DPOF) mark

Select [DPOF image] in step 4. All the images with the  mark are printed by the specified number regardless of the displayed image.

To print all the images in the folder

Select [All In This Folder] in step 4, then press ●.

To insert the date and time on images

Select [Date] in step 8, then select the date format with ◀/▶. You can select from [Day&Time] or [Date]. When you choose [Date], the date will be inserted in the order set in “Setting the date and time” (page 18). This function may not be provided depending on a printer.

Printing index-images

You can print some images side-by-side. We refer to this function as an index print*. You can also arrange the specified quantity of the same image side-by-side and print them as an index image (refer to “In single-image mode”), or arrange a set of different images side-by-side as an index image and print the specified number of sets (refer to “In index (nine-image/sixteen-image) mode”).

Set up the camera following the procedure on page 71, and connect the printer.

* An index print function may not be provided depending on a printer.

MENU

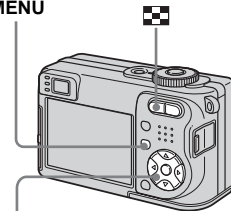

Control button

- You cannot print movies.
- When an error notification is received from the connected printer, the  indicator flashes for approximately five seconds. Check the connected printer.

In single-image mode

1 Display the image you want to print with ◀/▶.

2 Press MENU.

The menu appears.

3 Select  (Print) with ◀/▶, then press ●.

4 Select [This image] with ▲/▼, then press ●.

The print setting screen appears.

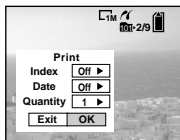

- Setting items that the printer does not support cannot be displayed.

5 Select [Index] with ▲, then select [On] with ◀/▶.

6 Select [Quantity] with ▲/▼, select the number of sheets laid side-by-side with ◀/▶.

You can select the number up to 20.
You can arrange the specified quantity of an image side-by-side.

7 Select [OK] with ▼/▶, then press ●.

The image is printed.

Do not disconnect the USB cable while the  (Not disconnect USB cable) indicator appears on the LCD screen.



To cancel printing

Select [Cancel] in step **4** or select [Exit] in step **7**.

To print other images

Select the image after step **7**. Select [Print] with ▲, then repeat from step **4**.

To print all the images with the print (DPOF) mark

Select [DPOF image] in step **4**. All the images with the  mark are printed regardless of the displayed image.

To insert the date and time on images









Select [Date] in step **6**, then select the date format with ◀/▶. You can select from [Day&Time] or [Date]. When you choose [Date], the date will be inserted in the order set in “Setting the date and time” (page 18). This function may not be provided depending on a printer.

- The designated number of images may not all fit onto a single sheet depending on the quantity of images.

In index (nine-image/
sixteen-image) mode

- 1 Press  (index) to display the index (nine-image) screen.









Press  (index) twice to display a sixteen-image index screen.

- 2 Press MENU.
The menu appears.
- 3 Select  (Print) with , then press .
- 4 Select [Select] with , then press .
- 5 Select the desired image with //, then press .

The  mark appears on the selected image.



- 6 Repeat step 5 to print other images.
- 7 Press MENU.

- 8 Select [Index] with , then select [On] with .
- 9 Select [Quantity] with /, select the number of sets you want to print with /.
You can select the number up to 20.
- 10 Select [OK] with , then press .

The image is printed.

Do not disconnect the USB cable while the  indicator appears on the LCD screen.

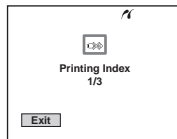

To cancel printing

Select [Cancel] in step 4 or select [Exit] in step 10.



To print all the images with the print (DPOF) mark

Select [DPOF image] in step 4. All the images with the  mark are printed regardless of the displayed image.

To print all the images in the folder

Select [All In This Folder] in step 4, then press .

To insert the date and time on images

Select [Date] in step 9, then select the date format with /. You can select from [Day&Time] or [Date]. When you choose [Date], the date will be inserted in the order set in “Setting the date and time” (page 18). This function may not be provided depending on a printer.

Shooting movies

You can shoot movies with sound using your camera.

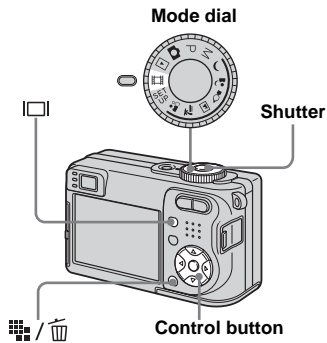

1 Set the mode dial to .

2 Press  /  (Image Size).

The Image Size setup appears.

3 Select the desired size with  / .

You can choose from [640(Fine)], [640(Standard)] and [160].

- [640(Fine)] can be recorded only on “Memory Stick PRO.”

4 Press the shutter button fully down.

“REC” appears on the screen and the camera starts recording the image and sound.



- Recording stops when the “Memory Stick” is full.

5 Press the shutter button fully down again to stop recording.

Indicators during shooting

The screen indicators are not recorded.

Each time you press , the status of the LCD screen changes as follows: Indicators off → LCD screen off → Indicators on.

A histogram is not displayed.

For a detailed description of the indicators, see page 123.

Shooting close-ups (Macro)

Set the mode dial to  and follow the procedure on page 28.

Using the self-timer

Set the mode dial to  and follow the procedure on page 29.

- You cannot use the following functions during shooting movies:
 - Changing the zoom scale
 - Flash
 - Inserting the date and time
- When you set the image size to [640(Fine)] while connecting the A/V connecting cable to A/V OUT (MONO) jack, the subject does not appear on the LCD screen. The LCD screen turns blue.
- For the recording time in each movie mode, see page 109.

Viewing movies on the LCD screen

You can view movies on the LCD screen with sound from the speaker.

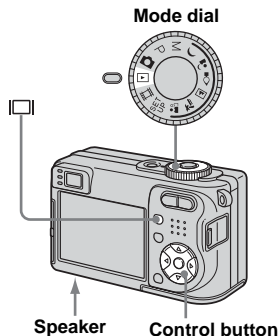

1 Set the mode dial to .

2 Select the desired moving image with / .

Movies with the image size [640(Fine)] or [640(Standard)] are displayed on the full screen.



- Movies with the image size [160] are displayed a size smaller.

3 Press .

The movie and sound are played back. During playback,  (playback) appears on the screen.





Playback bar



To stop playback

Press  again.

To adjust the volume

Press /  to adjust the volume.

To advance or rewind the movie

Press  (cue) or  (rev) during playback. To return to the normal playback, press .

Indicators during viewing movies

Each time you press , the status of the screen changes as follows: Indicators off → LCD screen off → Indicators on.

A histogram is not displayed.

For a detailed description of the indicators, see page 125.

- The procedure for viewing movies on a TV is the same as that for viewing still images (page 39).
- The moving images recorded using earlier Sony models may be also displayed a size smaller.





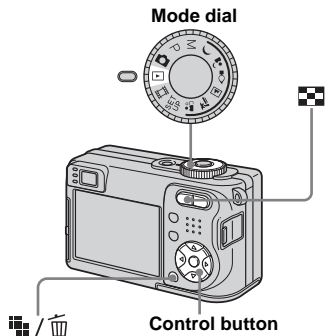



Deleting movies

You can delete unwanted movies.



- You cannot delete protected movies.
- Note that you cannot restore deleted movies.













In single-image mode

- 1** Set the mode dial to .
- 2** Display the movie you want to delete with  .
- 3** Press  /  (Delete).
The movie has not yet been deleted at this point.
- 4** Select [Delete] with , then press .
- 5** To continue and delete other movie, display the movie you want to delete with  , then repeat step **4**.

To cancel deletion

Select [Exit] in step **4** or **5**.

In index (nine-image/ sixteen-image) mode

- 1** Set the mode dial to , then press  (index) to display the index (nine-image) screen.
Press  (index) twice to display a sixteen-image index screen.
- 2** Press  /  (Delete).
- 3** Select [Select] with , then press .
- 4** Select the movie you want to delete with   /  , then press .

The green  (Delete) indicator appears on the selected movie.



The movie has not yet been deleted at this point.

- 5** Repeat step **4** to delete other movies.
- 6** Press  /  (Delete).

- 7** Select [OK] with **▶**, then press **●**.

The message “Access” appears, and the movie has been deleted.

To cancel deletion

Select [Exit] in step **3** or **7**.

To delete all images in the folder

Select [All In This Folder] in step **3**, then press **●**. Select [OK] with **▶**, then press **●**. To cancel deletion, select [Cancel] with **◀**, then press **●**.

Cutting movies

You can cut movies, or delete unnecessary portions of movies. This is the recommended function to use when the “Memory Stick” capacity is insufficient, or when you attach movies to your e-mail messages.

Note that the original movie is deleted when you cut it.

The file numbers assigned when movies are cut

The cut movies are assigned new numbers and recorded as the newest files in the selected recording folder. The original movie is deleted, and that number is skipped.

<Example> Cutting a movie numbered 101_0002

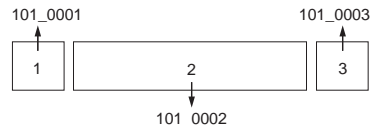

1. Cutting scene A.

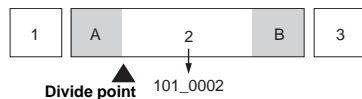

2. Cutting scene B.

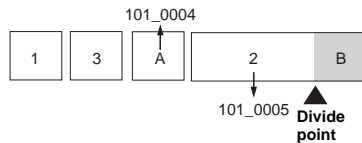

3. Deleting scenes A and B if they are unnecessary.

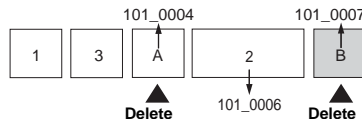

4. Only the desired scenes remain.

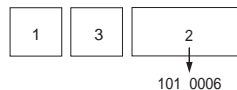

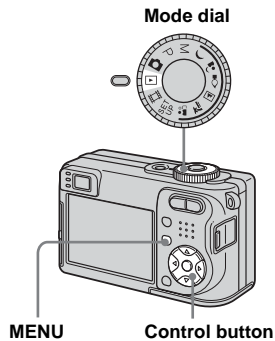





1 Set the mode dial to .

2 Select the movie you want to cut using / .

3 Press MENU.

The menu appears.





4 Select  (Divide) with , then press . Next, select [OK] with , then press .

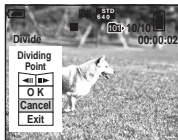

The playback of the movie starts.



5 Decide on a cutting point.

Press the center  at the desired cutting point.



When you want to adjust the cutting point, use [||] (frame rewind/forward) and adjust the cutting point using / . If you want to change the cutting point, select [Cancel]. The playback of the movie starts again.

6 When you have decided on a cutting point, select [OK] with , and press .

7 Select [OK] with , then press .

The movie is cut.

To cancel cutting

Select [Exit] in step **5** or **7**. The movie appears on the screen again.

- You cannot cut the following images.
 - Still image
 - Movies not long enough to cut
 - Protected movies
- You cannot restore files once you cut them.
- The original movie is deleted when you cut it.
- The cut movies are recorded as the newest files in the selected recording folder.

Copying images to your computer — For Windows users

Recommended computer environment

OS: Microsoft Windows 98, Windows 98SE, Windows 2000 Professional, Windows Millennium Edition, Windows XP Home Edition, or Windows XP Professional

The above OS must be installed at the factory. Operation is not assured in an environment upgraded to the operating systems described above or in a multi-boot environment.

CPU: MMX Pentium 200 MHz or faster

USB connector: Provided as standard

Display: 800 × 600 dots or more
High Color (16-bit color, 65,000 colors) or more

- This camera is compatible with Hi-Speed USB (USB 2.0 compliant).
- Connecting with a USB interface that is compatible with Hi-Speed USB (USB 2.0-compliant) allows advanced transfer (high-speed transfer).
- If you connect two or more USB equipment to a single computer at the same time, some equipment, including your camera, may not operate depending on the type of USB equipment.

- Operations are not guaranteed when using a USB hub.
- Operations are not guaranteed for all the recommended computer environments mentioned above.

USB mode

There are two modes for a USB connection when connecting with a computer, [Normal] and [PTP]* modes. The default setting is the [Normal] mode. This section describes the [Normal] mode as an example.

* Compatible with Windows XP. When connected to a computer, only the data in the folder selected by the camera is copied to the computer. To select the folder, follow the procedure on page 62.

Communication with your computer

When your computer resumes from the suspend or sleep mode, communication between your camera and your computer may not recover at the same time.

When a USB connector is not provided on your computer

When neither a USB connector nor a “Memory Stick” slot is provided, you can copy images using an additional device. See the Sony Website for details.

<http://www.sony.net/>

Contents of the CD-ROM

■ USB Driver

This driver is needed in order to connect the camera to a computer.

When using Windows XP, you need not install the USB driver.

■ Picture Package

This application is used to transfer images from the camera to a computer easily. It also allows you to utilize the various functions. When you install “Picture Package,” the USB driver is also installed at the same time.

- The required operations may differ depending on your OS.
- **Close down all applications running on the computer before installing the USB driver and application.**
- When using Windows XP or Windows 2000, log on as Administrator.

Installing the USB driver

When using Windows XP, you need not install the USB driver.

Once the USB driver is installed, you need not install the USB driver.

- 1 Turn on your computer, and insert the CD-ROM (supplied) into the CD-ROM drive.**

Do not connect your camera to your computer at this time.

The install menu screen appears. If it does not appear, double-click  (My Computer) →

 (PICTUREPACKAGE) in that order.

- If you are going to use the “Picture Package” application software, click [Picture Package]. The USB driver will be installed when “Picture Package” is installed (page 89).
- **When the computer is in use, shut down all application software before you install the USB driver.**

- 2 Click [USB Driver] on the title screen.**

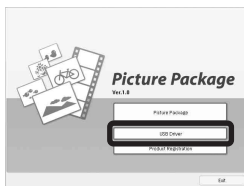

The “InstallShield Wizard” screen appears.

- 3 Click [Next].**



The USB driver installation starts. When the installation is completed, the screen informs you of completion.

- 4 Click [Yes, I want to restart my computer now], then click [Finish].**

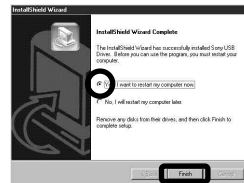

Your computer restarts. Then, you can establish USB connection.

- 5 Remove the CD-ROM.**

Connecting the camera to your computer

- 1** Insert the “Memory Stick” with the images you want to copy into the camera.

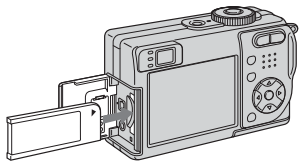

- Use fully charged Nickel-Metal Hydride batteries or the AC Adaptor (not supplied). If you attempt to copy image files using batteries with little remaining charge, the batteries may run out, causing copying to fail or possibly corrupting the data.

- 2** Set the mode dial to . Turn on your computer and the camera.

- You can also carry out this operation when the mode dial is set to SET UP.

- 3** Connect the USB cable (supplied) to the  (USB) jack of the camera.

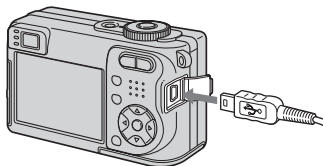

- 4** Connect the USB cable to your computer.

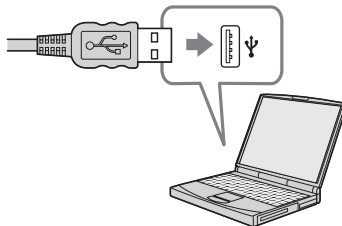

- When you use a desktop computer, we recommend that you connect the USB cable to the USB connector on the rear panel.

- When using Windows XP, the AutoPlay wizard automatically appears on the desktop. Proceed to page 86.

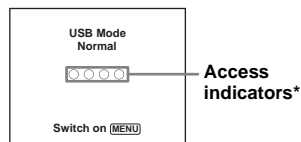

“USB Mode Normal” appears on the LCD screen of the camera. When a USB connection is established for the first time, your computer automatically runs the used program to recognize the camera. Wait for a while.

* During communication, the access indicators turn red. Do not operate the computer until the access indicators turn white.

- If “USB Mode Normal” does not appear in step **4**, press MENU, select [USB Connect], and set it to [Normal].

❗ Disconnecting the USB cable, removing the “Memory Stick,” or turning off the camera during a USB connection

For Windows 2000, Me, or XP users

- 1 Double-click  on the tasktray.



Double-click here

- 2 Click , then click [Stop].
- 3 Confirm the device on the confirmation window, then click [OK].
- 4 Click [OK].
Step 4 is unnecessary for Windows XP users.
- 5 Disconnect the USB cable, remove the “Memory Stick,” or turn off the camera.

For Windows 98 or 98SE users

Confirm that the access indicators (page 84) on the screen are turned white and carry out only step 5 above.

Copying images

– Windows 98/98SE/2000/Me

- 1 Double-click [My Computer], then double-click [Removable Disk].

The contents of the “Memory Stick” inserted in your camera appear.

- This section describes an example of copying images to the “My Documents” folder.
- When the “Removable Disk” icon is not shown, see page 86.
- When using Windows XP, see page 86.

- 2 Double-click [DCIM], then double-click the folder that the image files you want to copy are stored.

- 3 Right-click the image file to display the menu, then select [Copy] from the menu.

- 4 Double-click the [My Documents] folder and right-click on the “My Documents” window to display the menu, then select [Paste] from the menu.

The image files are copied to the “My Documents” folder.

When an image with the same file name exists in the copy destination folder

The overwrite confirmation message appears. When you overwrite the existing image with the new one, the original file data is deleted.

To change the file name

To copy an image file to the computer without overwriting, change the file name to the desired name and then copy the image file. However, note that if you change the file name, you may not be able to play back that image with your camera. To play back images with the camera, perform the operation on page 89.

When a removable disk icon is not shown

- 1 Right-click [My Computer] to display the menu, then click [Properties]. The “System Properties” screen appears.
- 2 Display [Device Manager].
 - ① Click [Hardware].
 - ② Click [Device Manager].
 - For Windows 98, 98SE, Me users, step ① is unnecessary. Click the [Device Manager] tab.
- 3 If [Sony DSC] is displayed, delete it.
 - ① Right-click [Sony DSC].
 - ② Click [Uninstall].

The “Confirm Device Removal” screen appears.

 - For Windows 98, 98SE, Me users, click [Remove].
 - ③ Click [OK].

The device is deleted.

Try the USB driver installation again using the CD-ROM (page 83).

– Windows XP

Copying images using the Windows XP AutoPlay wizard

- 1 Make a USB connection (page 84). Click [Copy pictures to a folder on my computer using Microsoft Scanner and Camera Wizard], then click [OK].**

The “Scanner and Camera Wizard” screen appears.

- 2 Click [Next].**

The images stored on the “Memory Stick” are displayed.

- 3 Click the checkbox of images that you do not want to copy to your computer to remove the checkmark, then click [Next].**

The “Picture Name and Destination” screen appears.

- 4 Select a name and destination for your pictures, then click [Next].**

Image copying starts. When the copying is completed, the “Other Options” screen appears.

- 5 Select [Nothing. I’m finished working with these pictures], then click [Next].**

The “Completing the Scanner and Camera Wizard” screen appears.

- 6 Click [Finish].**

The wizard closes.

- To continue copying other images, follow the procedure given under **1** on page 85 to disconnect the USB cable and reconnect it. Then, perform the procedure from step **1** again.

Viewing the images on your computer

1 Click [Start], then click [My Documents].

The “My Documents” folder contents are displayed.

- This section describes the procedure for viewing copied images in the “My Documents” folder.
- When not using Windows XP, double-click [My Documents] on the desktop.

2 Double-click the desired image file.

The image is displayed.

Image file storage destinations and file names

The image files recorded with your camera are grouped as folders in the “Memory Stick.”

Example: when viewing folders on Windows XP

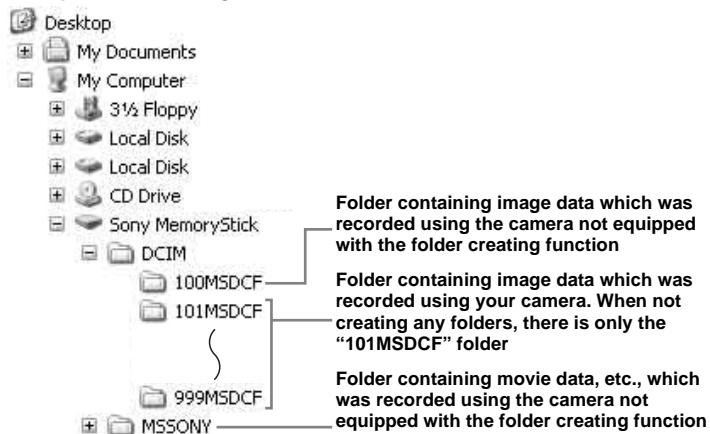

- You cannot record any images to “100MSDCF” or “MSSONY” folders. The images in these folders are available only for viewing.
- For more information about the folder, see pages 47 and 62.

Folder	File name	File meaning
101MSDCF to 999MSDCF	DSC0□□□□.JPG	<ul style="list-style-type: none"> • Still image files shot in <ul style="list-style-type: none"> – Normal mode (page 24) – Burst mode (page 59) – Multi Burst mode (page 60)
	MOV0□□□□.MPG	<ul style="list-style-type: none"> • Movie files (page 77)
	MOV0□□□□.THM	<ul style="list-style-type: none"> • Index image files recorded simultaneously in movie mode (page 77)

- □□□□ stands for any number within the range from 0001 to 9999.
- The numerical portions of a movie file recorded in movie mode and its corresponding index image file are the same.

Viewing image files once copied to a computer with your camera

When an image file copied to a computer no longer remains in a “Memory Stick,” you can view that image again on your camera by copying the image file in the computer to a “Memory Stick.”

- Step **1** is not necessary when the file name set with your camera has not been changed.
- You may be unable to play back some images depending on the image size.
- When an image file has been processed by a computer or when the image file was recorded using a model other than your camera, playback on your camera is not guaranteed.
- When the overwrite confirmation message appears, enter a different number in step **1**.
- When there is no folder, first create a folder with your camera and then copy the image file (page 47).

1 Right-click the image file, then click [Rename]. Change the file name to “DSC0□□□□”.

Enter a number from 0001 to 9999 for □□□□.

- An extension may be displayed depending on the computer settings. The extension for still images is JPG, and the extension for movies is MPG. Do not change the extension.

2 Copy the image file to the “Memory Stick” folder.

- ① Right-click the image file, then click [Copy].
- ② Select and double-click the [DCIM] folder from [Removable Disk] or [Sony MemoryStick] in [My Computer].
- ③ Right-click the [□□□MSDCF] folder in the [DCIM] folder and click [Paste]. □□□ stands for any number within the range from 100 to 999.

Installing “Picture Package”

“Picture Package” is only for Windows computers.

You can use the “Picture Package” software on your Windows computer to copy, view and edit the images shot with your camera. When you install “Picture Package,” the USB driver is also installed at the same time.

- When the computer is in use, shut down all application software before you install “Picture Package.”

For computer environment

See page 82 for the basic Windows operating environment. Other system requirements are as follows.

Software: Macromedia Flash Player 6.0 or later, Windows Media Player 7.0 or later, DirectX 9.0b or later

Sound card: 16-bit stereo sound card with speakers

Memory: 64 MB or more (128 MB or more is recommended.)

Hard Disk: Disk space required for installation: approximately 200 MB

Display: A video card equipped with 4 MB VRAM (Direct Draw driver compliant)



- When automatically creating slide shows (page 93), a Pentium III 500 MHz or faster CPU is required.
- This software is compatible with DirectX technology. “DirectX” must be installed for use.
- A separate environment for operating the recording device is required in order to write to CD-Rs.

1 Turn on your computer, and insert the CD-ROM (supplied) into the CD-ROM drive.

The installation menu screen appears.

- If you have not yet installed the USB driver (page 83), do not connect the camera to the computer before you install the “Picture Package” software (except for Windows XP).

2 Click [Picture Package].

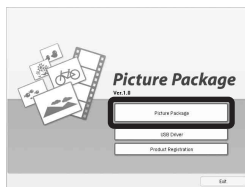

“Choose Setup Language” screen appears.

3 Select the desired language, then click [Next].

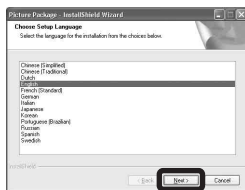

- This section describes the English screen.

4 Click [Next].

The “License Agreement” screen appears. Read the agreement carefully. If you accept the terms of the agreement, check the “I accept the terms of the license agreement” checkbox and click [Next].



5 Click [Next].

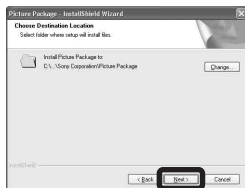

6 Click [Install] on the “Ready to Install the Program” screen.

The installation starts.



If the “Welcome to setup for Direct X” screen appears after you install the application software, follow the instructions.

7 Confirm if the checkbox of “Yes, I want to restart my computer now” is checked, then click [Finish].

Your computer restarts.

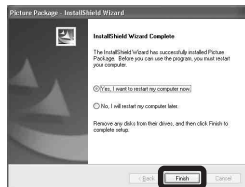

The shortcut icons of “Picture Package Menu” and “Picture Package destination Folder” are displayed.

8 Remove the CD-ROM.

Copying images using “Picture Package”

Connect the camera and your computer with the USB cable.

“Picture Package” starts up automatically and the images are copied to the computer automatically. After the images are copied, “Picture Package Viewer” starts up and the images copied are displayed.



- Normally “Picture Package” and “Date” folders are created inside the “My Picture” folder, and all of the image files recorded with the camera are copied into these folders.
- Windows XP is set so that the OS AutoPlay Wizard activates. If you deactivate the OS AutoPlay Wizard, cancel the activation using [Settings] on the “Picture Package Menu.”
- If “Picture Package” cannot copy images automatically, start up “Picture Package Menu” and check [Settings] in [Copy automatically].

Using "Picture Package"

Start up the "Picture Package Menu" on the desktop to use the various functions.

- The initial screen may differ depending on your computer. You can change the menu display order to suit your taste by clicking [Settings] at the lower-right corner of the screen.
- For details on the use of the application software, click  at the upper-right corner of each screen to show the on-line help.

Technical support of "Picture Package" is provided by the Pixela User Support Center. For more information, refer to the enclosed information with the CD-ROM.

Viewing images on a computer

Click [Viewing video and pictures on PC] on the left side of the screen, then click [Viewing video and pictures on PC] in the lower-right corner of the screen.

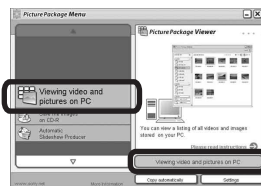

The screen used for viewing images appears.

Storing images on a CD-R

Click [Save the images on CD-R] on the left side of the screen, then click [Save the images on CD-R] in the lower-right corner of the screen.

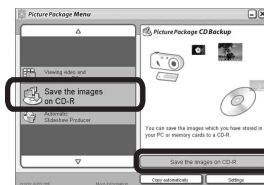

The screen used for storing images on a CD-R appears.

- A CD-R drive is required to store images on a CD-R. For further information on compatible drives, see the following home page of the Pixela User Support Center. <http://www.ppackage.com/>

Creating a slide show

Click [Automatic Slideshow Producer] on the left side of the screen, then click [Automatic Slideshow Producer] in the lower-right corner of the screen.

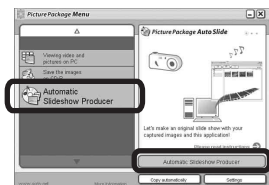

The screen used for creating a slide show appears.

Copying images to your computer — For Macintosh users

Recommended computer environment

OS: Mac OS 9.1, 9.2, or Mac OS X (v10.0/v10.1/v10.2/v10.3)

The above OS must be installed at the factory.

USB connector: Provided as standard

- If you connect two or more USB equipment to a single computer at the same time, some equipment, including your camera, may not operate depending on the type of USB equipment.
- Operations are not guaranteed when using a USB hub.
- Operations are not guaranteed for all the recommended computer environments mentioned above.

USB mode

There are two modes for a USB connection when connecting with a computer, [Normal] and [PTP]* modes. The default setting is the [Normal] mode. This section describes the [Normal] mode as an example.

* Compatible only with Mac OS X. When connected to a computer, only the data in the folder selected by the camera is copied to the computer. To select the folder, follow the procedure on page 62.

Communication with your computer

When your computer resumes from the suspend or sleep mode, communication between your camera and your computer may not recover at the same time.

When a USB connector is not provided on your computer

When neither a USB connector nor a “Memory Stick” slot is provided, you can copy images using an additional device. See the Sony Website for details.

<http://www.sony.net/>

1 Connecting your camera to your computer

For details, see page 84.

Disconnecting the USB cable, removing the “Memory Stick,” or turning off the camera during a USB connection

Drag and drop the drive icon or the icon of the “Memory Stick” to the “Trash” icon, then remove the USB cable, remove the “Memory Stick,” or turn off the camera.

- If you are using Mac OS X v10.0, remove the USB cable etc., after you have turned your computer off.

2 Copying images

- 1 Double-click the newly recognized icon on the desktop.
The contents of the “Memory Stick” inserted in your camera appear.
 - 2 Double-click [DCIM].
 - 3 Double-click the folder that the images you want to copy are stored.
 - 4 Drag and drop the image files to the hard disk icon.
The image files are copied to your hard disk.
- For details on the storage location of the images and file names, see page 87.

3 Viewing the images on your computer

- 1 Double-click the hard disk icon.
 - 2 Double-click the desired image file in the folder containing the copied files.
The image file opens.
- “Picture Package” cannot be used with Macintosh.

Using “ImageMixer VCD2”

“ImageMixer VCD2” is only for Macintosh (Mac OS X (v10.1.5) or later) computers.

Using “ImageMixer VCD2” on the CD-ROM supplied with your camera, you can create a video CD using the image or movie materials that are stored in your computer. You can create an image file that is compatible with the video CD creation function of Toast by Roxio (not supplied).

- When the computer is in use, shut down all other application software before you install “ImageMixer VCD2.”

Technical support of “ImageMixer VCD2” is provided by the Pixela User Support Center. For more information, refer to the enclosed information with the CD-ROM.
--

Required computer environment

OS: Mac OS X (v10.1.5 or later)

The above OS must be installed at the factory.

CPU: iMac, eMac, iBook, PowerBook, PowerMac G3/G4 series

Memory: 128 MB or more (256 MB or more is recommended.)

Hard Disk: Disk space required for installation: approximately 250 MB

Display: 1024 × 768 dots or more, 32,000 colors or more

- QuickTime 4 or later must be pre-installed at the factory. (QuickTime 5 is recommended.)
- Operations are not guaranteed for all the recommended computer environments mentioned above.

1 Installing “ImageMixer VCD2”

- 1 Turn on your computer.
 - The display settings should be 1024 × 768 dots or higher and 32,000 colors or higher.
- 2 Insert the CD-ROM (supplied) into the CD-ROM drive.
- 3 Double-click the CD-ROM icon.
- 4 Copy the [IMXINST.SIT] file in the [MAC] folder to the hard disk icon.
- 5 Double-click the [IMXINST.SIT] file in the copy-to folder.
- 6 Double-click the [ImageMixer VCD2_Install] extracted file.
- 7 After the user information screen appears, enter the desired name and password.
The installation of the software starts.

2 Creating a video CD

- 1 Open the [ImageMixer] folder in [Application].
- 2 Click [ImageMixer VCD2].
- 3 Click [Video CD].
The Video disc mode starts up.
 - You cannot create a DVD Video.

- 4 Select the folder in which the desired images are stored.
 - ① Select the desired folder on the left frame, then click [Add]. The selected folder moves to the right frame.
 - ② Click [Next].
- 5 Set up the menu background, buttons, titles, and so on, then click [Next]. Confirm the set up according to your preferences.
- 6 Confirm the preview of the Video CD file.
 - ① Click the file you want to preview on the left frame.
 - ② Click [▶] to preview the file.
- 7 Click [Next] and enter the disk name and its destination.
The preparation for storing the file on a CD-R is completed.
 - “ImageMixer VCD2” can create only the disk image to store the image file on a CD-R in the video CD format. Toast by Roxio (not supplied) is required to create a video CD.

Troubleshooting

If you experience trouble with your camera, try the following solutions.

1 First check the items on the tables below.

If code displays “C:□□:□□” appear on the screen, the self-diagnosis display function is working (page 108).

2 Should your camera still not work properly, press the RESET button on the bottom of the camera using a fine-tipped object, then turn on the power again. (All the settings including date and time are cleared.)

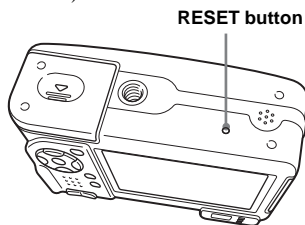







3 Should your camera still not work properly, consult your Sony dealer or local authorized Sony service facility.

Battery and power

























Symptom	Cause	Solution
The battery remaining indicator is incorrect, or sufficient battery remaining indicator is displayed but the power runs out soon.	<ul style="list-style-type: none">• You have used the camera in an extremely cold location.• The batteries are discharged.• The battery contacts or the terminals on the battery cover are dirty.• The memory effect has occurred in the Nickel-Metal Hydride batteries (page 12).• A deviation has occurred in the remaining battery time.• The batteries are dead (page 119).	<p>→ See page 116.</p> <p>→ Install charged batteries (page 13).</p> <p>→ Wipe any dirt off from them with a dry cloth (page 13).</p> <p>→ Charge the batteries only after using up the existing charge to correct it.</p> <p>→ Charge the batteries only after using up the existing charge so that the battery remaining indicator functions correctly (page 14).</p> <p>→ Replace the batteries with new ones.</p>
The battery runs down too quickly.	<ul style="list-style-type: none">• You have used the camera in an extremely cold location.• The batteries are not charged enough.• The batteries are dead (page 119).	<p>→ See page 116.</p> <p>→ Charge the batteries (page 11).</p> <p>→ Replace the batteries with new ones.</p>

Symptom	Cause	Solution
You cannot turn on the camera.	<ul style="list-style-type: none"> The batteries are not installed correctly. The AC Adaptor (not supplied) is disconnected. The batteries are discharged. The batteries are dead (page 119). 	<ul style="list-style-type: none"> → Install the batteries correctly (page 13). → Properly connect the AC Adaptor (page 16). → Install charged batteries (page 13). → Replace the batteries with new ones.
The power turns off suddenly.	<ul style="list-style-type: none"> If you do not operate the camera for about three minutes while the power is on, the camera turns off automatically to prevent wearing down the batteries (page 17). The batteries are discharged. 	<ul style="list-style-type: none"> → Turn on the camera again (page 17). → Install charged batteries (page 13).

Shooting still images/movies



Symptom	Cause	Solution
The LCD screen is not turned on even when the power is turned on.	<ul style="list-style-type: none"> The power was turned off with the LCD screen turned off the last time you used the camera. 	<ul style="list-style-type: none"> → Turn on the LCD screen (page 32).
The subject is not visible on the LCD screen.	<ul style="list-style-type: none"> The mode dial is set to SET UP or . 	<ul style="list-style-type: none"> → Set it to other modes than SET UP or  (page 10).
The LCD screen turns blue and the subject does not appear when recording movies.	<ul style="list-style-type: none"> The image size is set to [640(Fine)] while an A/V connecting cable is connected to the A/V OUT (MONO) jack. 	<ul style="list-style-type: none"> → Disconnect the A/V connecting cable. → Set the image size to other than [640(Fine)].
The image is out of focus.	<ul style="list-style-type: none"> The subject is too close. The mode dial is set to  or  when shooting still images. The focus preset function is selected. 	<ul style="list-style-type: none"> → Record in the close-ups (Macro) recording mode. Make sure to position the lens farther away from the subject than the shortest shooting distance when shooting (page 28). → Set it to other modes than  or  (page 36). → Set to the auto focus mode (page 50).
Zoom does not work.	<ul style="list-style-type: none"> You cannot change the zoom scale when shooting movies. 	—
Precision digital zoom does not function.	<ul style="list-style-type: none"> [Digital Zoom] is set to [Smart] or [Off] in the SET UP settings. This function cannot be used during shooting movies. 	<ul style="list-style-type: none"> → Set [Digital Zoom] to [Precision] (pages 27, 46 and 114). —

Symptom	Cause	Solution
Smart zoom does not function.	<ul style="list-style-type: none"> • [Digital Zoom] is set to [Precision] or [Off] in the SET UP settings. • The image size is set to [5M] or [3:2]. • You are shooting in Multi Burst mode. • This function cannot be used during shooting movies. 	<p>→ Set [Digital Zoom] to [Smart] (pages 27, 46 and 114).</p> <p>→ Set image size to other settings except [5M] and [3:2] (pages 21 and 27).</p> <p>→ The smart zoom cannot be used in Multi Burst mode (pages 27, 60).</p> <p>—</p>
The image is too dark.	<ul style="list-style-type: none"> • You are shooting a subject with a light source behind the subject. • The brightness of the LCD screen is too low. 	<p>→ Select the metering mode (page 56).</p> <p>→ Adjust the exposure (pages 53, 54 and 110).</p> <p>→ Adjust the brightness of the LCD backlight (page 115).</p>
The image is too bright.	<ul style="list-style-type: none"> • You are shooting a spotlighted subject in a dark location such as on a stage. • The brightness of the LCD screen is too bright. 	<p>→ Adjust the exposure (pages 53, 54 and 110).</p> <p>→ Adjust the brightness of the LCD backlight (page 115).</p>
The image is monochrome (black and white).	<ul style="list-style-type: none"> • [PFX] (P. Effect) is set to [B&W]. 	<p>→ Set it to the other modes than [B&W] (page 60).</p>
Vertical streaks appear when you are shooting a very bright subject.	<ul style="list-style-type: none"> • The smear phenomenon is occurring. 	<p>→ This phenomenon is not a malfunction.</p>
Noise appears in the image when you view the LCD screen in a dark place.	<ul style="list-style-type: none"> • The camera is functioning to increase the visibility of the LCD screen by temporarily brightening the image under conditions of low illumination. 	<p>→ There is no effect on the recorded image.</p>

Symptom	Cause	Solution
Your camera cannot record images.	<ul style="list-style-type: none"> No “Memory Stick” has been inserted. The capacity of the “Memory Stick” is full. The write-protect switch on the “Memory Stick” is set to the LOCK position. You cannot record images while charging the flash. The mode dial is set to SET UP or  when shooting still images. The mode dial is not set to  when shooting movies. The image size is set to [640(Fine)] when recording movies. 	<ul style="list-style-type: none"> → Insert a “Memory Stick” (page 20). → Delete unnecessary images saved in the “Memory Stick” (pages 41 and 79). → Change the “Memory Stick”. → Set it to the recording position (page 117). — → Set it to other modes than SET UP or  (page 10). → Set it to  (page 77). → Insert a “Memory Stick PRO” (pages 77 and 117). → Set the image size to other than [640(Fine)].
Recording takes a long time.	<ul style="list-style-type: none"> NR slow shutter function is activated. 	<ul style="list-style-type: none"> → See page 36.
The flash does not work.	<ul style="list-style-type: none"> The mode dial is set to , SET UP or . The flash is set to . The mode dial is set to  or  when shooting still images. The mode dial is set to  or  when shooting still images. [Mode] (REC Mode) is set to [Burst] or [Multi Burst]. 	<ul style="list-style-type: none"> → Set it to other modes than , SET UP or  (page 10). → Set the flash to auto (No indicator),  (Forced flash) or  (Slow synchro) (page 30). → Set it to other modes than  or  (page 36). → Set the flash to  (Forced flash) (page 30). → Set it to other modes than [Burst] or [Multi Burst].
The close-ups (Macro) function does not work.	<ul style="list-style-type: none"> The mode dial is set to ,  or  when shooting still images. 	<ul style="list-style-type: none"> → Set it to other modes than ,  or  (page 36).
Continuous shooting is not possible.	<ul style="list-style-type: none"> The capacity of the “Memory Stick” is full. The battery remaining charge is insufficient, so you can only shoot one frame. 	<ul style="list-style-type: none"> → Delete unnecessary images saved in the “Memory Stick” (pages 41 and 79). → Install charged batteries.
The eyes of the subject come out red.	—	<ul style="list-style-type: none"> → Set [Red Eye Reduction] in the SET UP settings to [On] (pages 31 and 114).

Symptom	Cause	Solution
The date and time are recorded incorrectly.	<ul style="list-style-type: none"> The date and time are not set correctly. 	→ Set the correct date and time (pages 18 and 115).
The F value and shutter speed flash when you press and hold the shutter button halfway down.	<ul style="list-style-type: none"> The exposure is incorrect. 	→ Correct the exposure (page 54).

Viewing images

Symptom	Cause	Solution
Your camera cannot play back images.	<ul style="list-style-type: none"> The mode dial is not set to . The folder/file name has been changed on your computer. Your camera cannot play back image files copied from the hard disk of your computer if the image has been modified. The camera is in USB mode. 	→ Set it to  (page 37). → See page 89. — → Cancel USB communication (pages 85 and 94).
The image appears rough right after playback starts.	<ul style="list-style-type: none"> The image may appear rough right after playback starts due to the image processing. 	→ This is not a malfunction.
The image does not appear on the TV screen.	<ul style="list-style-type: none"> The video output signal setting of your camera in the SET UP settings is incorrect. The connection is not correct. 	→ Change the setting (pages 46 and 115). → Check the connection (page 39).
The image cannot be played back on a computer.	—	→ See page 101.

Deleting/Editing Images

Symptom	Cause	Solution
Your camera cannot delete an image.	<ul style="list-style-type: none">• The image is protected.• The write-protect switch on the “Memory Stick” is set to the LOCK position.	<ul style="list-style-type: none">→ Cancel the protection (page 67).→ Set it to the recording position (page 117).
You have deleted an image by mistake.	<ul style="list-style-type: none">• Once you have deleted an image, you cannot restore it.	<ul style="list-style-type: none">→ Marking  (protect) will prevent you from deleting images by mistake (page 67).→ We recommend that you set the “Memory Stick” write-protect switch to the LOCK position to prevent accidental erasure (page 117).
The resizing function does not work.	<ul style="list-style-type: none">• You cannot resize movies and Multi Burst images.	—
You cannot display a print (DPOF) mark.	<ul style="list-style-type: none">• You cannot display print (DPOF) marks on movies.	—
You cannot cut a movie.	<ul style="list-style-type: none">• The movie is not long enough to cut.• Protected movie cannot be cut.• Still images cannot be cut.	<ul style="list-style-type: none">—→ Cancel the protection (page 67).—

Computers

Symptom	Cause	Solution
You do not know if the OS of your computer is compatible.	—	→ Check “Recommended computer environment” (pages 82 and 93).
You cannot install the USB driver.	—	→ In Windows 2000, log on as Administrator (authorized Administrators) (page 82).

Symptom	Cause	Solution
Your computer does not recognize your camera.	<ul style="list-style-type: none"> • The camera is turned off. • The battery level is low. • You are not using the supplied USB cable. • The USB cable is not connected firmly. <ul style="list-style-type: none"> • [USB Connect] is not set to [Normal] in the SET UP settings. • The USB connectors on your computer are connected to other equipment besides the keyboard, the mouse, and your camera. • The camera is not connected directly to your computer. • The USB driver is not installed. • Your computer does not properly recognize the device because you connected the camera and your computer with the USB cable before you installed the “USB Driver” from the supplied CD-ROM. 	<ul style="list-style-type: none"> → Turn on the camera (page 17). → Use the AC Adaptor (not supplied) (page 16). → Use the supplied USB cable (pages 84 and 94). → Disconnect the USB cable from both the computer and the camera, and connect it again firmly. Make sure that “USB Mode” is displayed on the LCD screen (page 84). → Set it to [Normal] (pages 46 and 115). <ul style="list-style-type: none"> → Disconnect all equipment other than the keyboard and the mouse from the USB connectors (page 82). <ul style="list-style-type: none"> → Connect the camera directly to your computer without passing through a USB hub or other device (page 82). → Install the USB driver (page 83). → Delete the erroneously recognized device from your computer (page 86), then install the USB driver (page 83).
You cannot copy images.	<ul style="list-style-type: none"> • The camera is not correctly connected to your computer. • You are not using the correct copy procedure for your OS. • You attempted to shoot using a “Memory Stick” formatted by a computer. 	<ul style="list-style-type: none"> → Connect the camera and your computer correctly using the supplied USB cable (page 84). → Follow the designated copy procedure for your OS (pages 85, 86, 91 and 93). → Shoot using a “Memory Stick” formatted by your camera.
After making a USB connection, “Picture Package” does not automatically start.	— —	<ul style="list-style-type: none"> → Start up the “Picture Package Menu” and check [Settings]. → Make a USB connection when the computer is turned on (page 84).
The image cannot be played back on a computer.	— —	<ul style="list-style-type: none"> → If you are using the “Picture Package” application software, click on help at the upper-right corner of each screen. → Consult the computer or software manufacturer.

Symptom	Cause	Solution
The image and sound are interrupted by noise when you view a movie on a computer.	<ul style="list-style-type: none"> You are playing back the movie directly from the “Memory Stick”. 	→ Copy the movie to the hard disk of your computer and then play back the movie from the hard disk (pages 85, 86, 91 and 93).
You cannot print an image.	—	→ Check the printer settings.
Images once copied to a computer cannot be viewed on the camera.	<ul style="list-style-type: none"> Copied to a wrong folder. 	→ Copy them to an available folder, such as “101MSDCF” (page 89).

“Memory Stick”

Symptom	Cause	Solution
You cannot insert a “Memory Stick.”	<ul style="list-style-type: none"> You are inserting it backwards. 	→ Insert it from the right side (page 20).
You cannot record on a “Memory Stick.”	<ul style="list-style-type: none"> The write-protect switch on the “Memory Stick” is set to the LOCK position. The capacity of the “Memory Stick” is full. The image size is set to [640(Fine)] when recording movies. 	→ Set it to the recording position (page 117). → Delete unnecessary images saved in the “Memory Stick” (pages 41 and 79). → Insert a “Memory Stick PRO” (pages 77 and 117). → Set the image size to other than [640(Fine)].
You cannot format a “Memory Stick.”	<ul style="list-style-type: none"> The write-protect switch on the “Memory Stick” is set to the LOCK position. 	→ Set it to the recording position (page 117).
You have formatted a “Memory Stick” by mistake.	<ul style="list-style-type: none"> All the data on the “Memory Stick” are deleted by formatting. You cannot restore them. 	→ We recommend that you set the “Memory Stick” write-protect switch to the LOCK position to prevent accidental erasure (page 117).

PictBridge compliant printer

Symptom	Cause	Solution
The connection cannot be established.	<ul style="list-style-type: none"> • The printer is not compliant with the PictBridge. • The printer is not set for the connection with the camera. • [USB Connect] is not set to [PictBridge] in the SET UP settings. • Depending on the circumstances, the connection may not be established. 	<ul style="list-style-type: none"> → Consult with the printer manufacturer. → Check that the printer is turned on and can connect with the camera. → Set it to [PictBridge] (page 115). → Disconnect and connect the USB cable again. If an error message is indicated on the printer, refer to the operating instructions supplied with the printer.
You cannot print images.	<ul style="list-style-type: none"> • The camera is not connected to the printer. • The printer is not turned on. • If you select [Exit] during printing, you may not print again depending on your printer. • Movies cannot be printed. • Images modified with a computer or images shot using other than this camera may not be able to be printed. 	<ul style="list-style-type: none"> → Check that the camera and the printer are properly connected using the USB cable. → Turn on the printer. For further information, refer to the operating instructions supplied with it. → Disconnect and connect the USB cable again. If you cannot print still, disconnect the USB cable, turn off and on the printer, then connect the USB cable again. — —
Printing is canceled.	<ul style="list-style-type: none"> • You disconnected the USB cable before the  (Not disconnect USB cable) mark disappears. 	—
You cannot insert the date or print images in the index mode.	<ul style="list-style-type: none"> • The printer does not provide these functions. • The date may not be inserted in the index mode depending on the printer. 	<ul style="list-style-type: none"> → Consult with the printer manufacturer whether the printer provides these functions or not. → Consult with the printer manufacturer.
“---- -- --” is printed on the date-inserted part.	<ul style="list-style-type: none"> • The recording date data is not recorded on the image. 	<ul style="list-style-type: none"> → The images that do not have the recording date data cannot be printed with the date inserted. Set [Date] to [Off] and print it.





Others

Symptom	Cause	Solution
Your camera does not work.	<ul style="list-style-type: none">• The battery level is low. (The  indicator appears.)• The AC Adaptor (not supplied) is not connected securely.	<p>→ Charge the batteries (page 11).</p> <p>→ Connect it securely to the DC IN jack of your camera and to a wall outlet (wall socket) (page 16).</p>
The power is on, but the camera does not work.	<ul style="list-style-type: none">• The built-in microcomputer is not working properly.	<p>→ Remove the batteries, then after one minute reinsert the batteries and turn on the camera. If this does not work, press the RESET button located on the bottom of the camera with a pointed object, then turn the power on again. (This will clear the date and time settings, etc.)</p>
You cannot identify an indicator on the screen.	—	<p>→ Check the indicator (pages 122 to 125).</p>
The lens gets fogged.	<ul style="list-style-type: none">• Moisture condensation has occurred.	<p>→ Turn off the camera and leave for about an hour at room temperature for the moisture to evaporate before use (page 116).</p>
The camera becomes warm when you use it for the long time.	—	<p>→ This is not a malfunction.</p>
The lens does not move when you turn off the camera.	<ul style="list-style-type: none">• The batteries are discharged.	<p>→ Replace them with charged batteries (pages 11 and 13) or use the AC Adaptor (not supplied) (page 16).</p>

Warnings and messages

The following messages may appear on the screen.

Message	Meaning/Corrective Action
No Memory Stick	<ul style="list-style-type: none">• Insert a “Memory Stick” (page 20).
System error	<ul style="list-style-type: none">• Turn the power off and on again (page 17).
Memory Stick error	<ul style="list-style-type: none">• The inserted “Memory Stick” cannot be used in your camera (page 117).• The “Memory Stick” is damaged.• The terminal section of the “Memory Stick” is dirty.• Insert the “Memory Stick” correctly (page 20).
Memory Stick type error	<ul style="list-style-type: none">• The inserted “Memory Stick” cannot be used in your camera (page 117).
Format error	<ul style="list-style-type: none">• Failed to format the “Memory Stick.” Format the “Memory Stick” again (page 43).
Memory Stick locked	<ul style="list-style-type: none">• The write-protect switch on the “Memory Stick” is set to the LOCK position. Set it to the recording position (page 117).
No memory space	<ul style="list-style-type: none">• The capacity of the “Memory Stick” is insufficient. You cannot record images. Delete unnecessary images (pages 41 and 79).
Read only memory	<ul style="list-style-type: none">• Your camera cannot record or delete images to this “Memory Stick.”
No file in this folder	<ul style="list-style-type: none">• No images have been recorded in this folder.
Folder error	<ul style="list-style-type: none">• A folder with the same first three digits number already exists in the “Memory Stick.” (For example: 123MSDCF and 123ABCDE) Select other folders, or create a new folder.
Cannot create more folders	<ul style="list-style-type: none">• The folder whose first three digits of the name is “999” exists in the “Memory Stick.” You cannot create any folders.
Cannot record	<ul style="list-style-type: none">• The camera cannot record images in the selected folder. Select a different folder (page 47).
File error	<ul style="list-style-type: none">• An error occurred while playing back the image.
File protect	<ul style="list-style-type: none">• The image is protected against erasure. Release the protection (page 68).
Image size over	<ul style="list-style-type: none">• You are playing back an image of a size that cannot be played back on your camera.
Cannot divide	<ul style="list-style-type: none">• The movie is not long enough to be divided.• The file is not a movie.
Invalid operation	<ul style="list-style-type: none">• You are playing back a file that was created on equipment other than this camera.

Message	Meaning/Corrective Action
	<ul style="list-style-type: none"> The battery level is low or zero. Charge the batteries (page 11). Depending on the conditions of use or the type of batteries, the indicator may flash even though there are still 5 to 10 minutes of remaining battery time left.
	<ul style="list-style-type: none"> Camera shake may occur due to insufficient light. Use the flash, mount the camera on a tripod, or otherwise secure the camera in place.
Turn the power off and on again	<ul style="list-style-type: none"> A problem with the lens caused an error.
640(Fine) is not available	<ul style="list-style-type: none"> 640(Fine) size movies can be recorded only using “Memory Stick PRO.” Insert a “Memory Stick PRO” or set the image size to other than [640(Fine)].
Enable printer to connect	<ul style="list-style-type: none"> [USB Connect] is set to [PictBridge], however the camera is connected to a non-PictBridge compliant device. Check the device. Depending on the circumstances, the connection may not be established. Disconnect and connect the USB cable again. If an error message is indicated on the printer, refer to the operating instructions supplied with the printer.
Connect to  device	<ul style="list-style-type: none"> You tried to print images before the printer connection was established. Connect to a PictBridge compliant printer.
No printable image	<ul style="list-style-type: none"> You tried to execute [DPOF image] without checking the  mark. You tried to execute [All In This Folder] while selecting the folder that stores only movies. You cannot print movies.
Printer busy	<ul style="list-style-type: none"> Since the printer is busy, it cannot receive print requests. Check the printer.
Paper error	<ul style="list-style-type: none"> A paper error occurred, such as paper-out, paper-jam, etc. Check the printer.
Ink error	<ul style="list-style-type: none"> An ink error occurred. Check the printer.
Printer error	<ul style="list-style-type: none"> The camera received an error from the printer. Check the printer, or check if the image you want to print is corrupted.
	<ul style="list-style-type: none"> The data transmission to the printer may not be completed yet. Do not disconnect the USB cable.

Self-diagnosis display

– If a code starting with an alphabet letter appears

Your camera has a self-diagnosis display. This function displays the camera condition on the LCD screen with a combination of a letter and four numerical digits. If this occurs, check the following code chart and attempt the corresponding corrective actions. The last two digits (indicated by □□) will differ depending on the state of the camera.

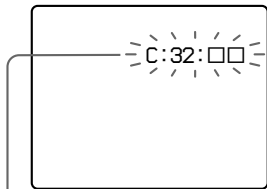

Self-diagnosis display

Code	Cause	Countermeasure
C:32: □□	There is trouble with your camera's hardware.	• Turn the power off and on again (page 17).
C:13: □□	The camera cannot read or write data on the "Memory Stick."	• Re-insert the "Memory Stick" several times.
	An unformatted "Memory Stick" is inserted.	• Format the "Memory Stick" (page 43).
	The inserted "Memory Stick" cannot be used with your camera, or the data is damaged.	• Insert a new "Memory Stick" (page 20).
E:61: □□ E:91: □□ E:92: □□	A camera malfunction that you cannot reverse has occurred.	• Press the RESET button (page 96) located on the bottom of the camera, then turn the power on again.

If you are unable to solve the problem even after trying the corrective actions a few times, contact your Sony dealer or local authorized Sony service facility.

Number of images that can be saved or shooting time

The number of images that can be saved and the shooting time differ, depending on the capacity of the “Memory Stick,” the image size, and the image quality. Refer to the following charts when you choose a “Memory Stick.”

- The number of images is listed in Fine (Standard) order.
- The values for the number of images that can be saved and the shooting time may vary, depending on the shooting conditions.
- For normal shooting times and numbers of images that can be saved, see page 23.
- When the number of remaining shooting images is greater than 9,999, the “>9999” indicator appears on the LCD screen.

Multi Burst

(Units: images)

	16MB	32MB	64MB	128MB	MSX-256	MSX-512	MSX-1G
1M	24 (46)	50 (93)	101 (187)	202 (376)	357 (649)	726 (1320)	1482 (2694)

Movie

	16MB	32MB	64MB	128MB	MSX-256	MSX-512	MSX-1G
640(Fine)	—	—	—	—	0:02:57	0:06:02	0:12:20
640(Standard)	0:00:42	0:01:27	0:02:56	0:05:54	0:10:42	0:21:47	0:44:27
160	0:11:12	0:22:42	0:45:39	1:31:33	2:51:21	5:47:05	11:44:22

The numbers indicate the recording time. For example: “1:34:45” indicates “1 hour, 34 minutes, 45 seconds.”

- The image size is as follows:
640(Fine): 640×480
640(Standard): 640×480
160: 160×112

Menu items





Menu items that can be modified differ depending on the position of the mode dial or the setting.

Factory settings are indicated with ■.

When the mode dial is set to

Item	Setting	Description
Mode (REC Mode)	Multi Burst Burst ■Normal	<ul style="list-style-type: none">– Records a continuous burst of 16 frames within a single still image (page 60).– Records continuously (page 59).– Records an image using the normal recording mode.

When the mode dial is set to P or M

Item	Setting	Description
 (EV) ¹⁾	+2.0EV / +1.7EV / +1.3EV / +1.0EV / +0.7EV / +0.3EV / ■0EV / -0.3EV / -0.7EV / -1.0EV / -1.3EV / -1.7EV / -2.0EV	Adjusts the exposure (page 54).
 (Focus)	∞ / 7.0m / 3.0m / 1.0m / 0.5m / Center AF / ■Multi AF	Chooses the auto focus method (page 48), or sets the focus preset distance (page 50).
 (Metering mode)	Spot / ■Multi	Matches the exposure to the subject you want to shoot (page 56). Set the metering region.
WB (White Bal)	 / ■Auto	Sets the white balance (page 57).
ISO	400 / 200 / 100 / ■Auto	Selects the ISO sensitivity. Select a large number when shooting in dark locations or shooting a subject moving at high speed, or select a small number to obtain high image quality. <ul style="list-style-type: none">• Note that the image tends to become noisier as the ISO sensitivity number increases.

Item	Setting	Description
(P.Quality)	■Fine / Standard	Records images with fine/standard quality (page 46).
Mode (REC Mode)	Multi Burst Burst ■Normal	<ul style="list-style-type: none"> – Records a continuous burst of 16 frames within a single still image (page 60). – Records continuously (page 59). – Records an image using the normal recording mode.
(Interval)	1/7.5 / 1/15 / ■1/30	Selects the Multi Burst shutter interval (page 60). (This setting cannot be made when [Mode] (REC Mode) in the menu is set to other than [Multi Burst].)
(Flash Level)	+ / ■Normal / –	Selects the amount of flash light (page 58).
PFX (P.Effect)	B&W / Sepia / ■Off	Sets the image special effects (page 60).
(Saturation)	+ / ■Normal / –	Adjusts the saturation of the image. The indicator appears (except when the setting is Normal).
(Contrast)	+ / ■Normal / –	Adjusts the contrast of the image. The indicator appears (except when the setting is Normal).
(Sharpness)	+ / ■Normal / –	Adjusts the sharpness of the image. The indicator appears (except when the setting is Normal).

¹⁾This does not appear when mode dial is set to M.



When the mode dial is set to , , , , or



Item	Setting	Description
(EV)	+2.0EV / +1.7EV / +1.3EV / +1.0EV / +0.7EV / +0.3EV / ■0EV / –0.3EV / –0.7EV / –1.0EV / –1.3EV / –1.7EV / –2.0EV	Adjusts the exposure (page 54).
(Focus) ¹⁾	∞ / 7.0m / 3.0m / 1.0m / 0.5m / Center AF / ■Multi AF	Chooses the auto focus method (page 48), or sets the focus preset distance (page 50).
(Metering mode)	Spot / ■Multi	Matches the exposure to the subject you want to shoot (page 56). Set the metering region.
WB (White Bal)¹⁾	/ / / / ■Auto	Sets the white balance (page 57).
ISO	Auto	[Auto] is selected automatically.
(P.Quality)	■Fine / Standard	Records images with fine/standard quality (page 46).







Item	Setting	Description
Mode (REC Mode)¹⁾	Multi Burst Burst ■Normal	<ul style="list-style-type: none"> – Records a continuous burst of 16 frames within a single still image (page 60). – Records continuously (page 59). – Records an image using the normal recording mode.
 (Interval)²⁾	1/7.5 / 1/15 / ■1/30	Selects the Multi Burst shutter interval (page 60). (This setting cannot be made when [Mode] (REC Mode) in the menu is set to other than [Multi Burst].)
± (Flash Level)³⁾	+ / ■Normal / –	Selects the amount of flash light (page 58).
PFX (P.Effect)	B&W / Sepia / ■Off	Sets the image special effects (page 60).

¹⁾ The setting selection is limited according to the mode dial setting (page 36).









²⁾ This does not appear when mode dial is set to  or .

³⁾ This does not appear when mode dial is set to  or .

When the mode dial is set to

Item	Setting	Description
 (EV)	+2.0EV / +1.7EV / +1.3EV / +1.0EV / +0.7EV / +0.3EV / ■0EV / –0.3EV / –0.7EV / –1.0EV / –1.3EV / –1.7EV / –2.0EV	Adjusts the exposure (page 54).
 (Focus)	∞ / 7.0m / 3.0m / 1.0m / 0.5m / Center AF / ■Multi AF	Chooses the auto focus method (page 48), or sets the focus preset distance (page 50).
 (Metering mode)	Spot / ■Multi	Matches the exposure to the subject you want to shoot (page 56). Set the metering region.
WB (White Bal)	 / ■Auto	Sets the white balance (page 57).
PFX (P.Effect)	B&W / Sepia / ■Off	Sets the image special effects (page 60).

When the mode dial is set to

Item	Setting	Description
 (Folder)	OK / Cancel	Selects the folder containing the image you want to play back (page 62).
 (Protect)	—	Protects and unprotects images against accidental erasure (page 67).
DPOF (DPOF)	—	Marks and unmarks the print (DPOF) mark on still images you want to print (page 69).
 (Print)	—	Prints images using a PictBridge compliant printer (page 71).
 (Slide)	Interval Image Repeat Start Cancel	<ul style="list-style-type: none"> – Sets the slide show interval (page 64). (Only in single-image mode) <ul style="list-style-type: none"> ■ 3 sec / 5 sec / 10 sec / 30 sec / 1 min – Sets the range of the playback images. <ul style="list-style-type: none"> ■ Folder / All – Plays back images repeatedly. <ul style="list-style-type: none"> ■ On / Off – Starts the slide show. – Cancels the slide show.
 (Resize)	5M / 3M / 1M / VGA / Cancel	Changes the recorded still image size (page 68). (Only in single-image mode)
 (Rotate)	 (counter clockwise) /  (clockwise) / OK / Cancel	Rotates the still image (page 65). (Only in single-image mode)
 (Divide)	OK / Cancel	Divides a moving image (page 80). (Only in single-image mode)

SET UP items

Set the mode dial to SET UP. The SET UP screen appears.

Factory settings are indicated with ■.

(Camera)

Item	Setting	Description
AF Mode	■Single / Monitor	Selects the focus operation mode (page 49).
Digital Zoom	■Smart / Precision / Off	Selects the digital zoom mode (page 26).
Date/time	Day&Time / Date / ■Off	Selects whether to superimpose the date or time onto the image (page 33). The date and time are not inserted in movie or Multi Burst mode. Also, the date and time appear only during playback, and do not appear during recording.
Red Eye Reduction	On / ■Off	Reduces the red-eye phenomenon when using a flash (page 31).
AF Illuminator	■Auto / Off	Selects whether to emit an AF assist light in the dark. Helps when it is hard to focus on the subject under dark lighting (page 31).
Auto Review	On / ■Off	Selects whether to automatically display the recorded image on the LCD screen immediately after shooting a still image. When set to [On], the recorded image is displayed for approximately two seconds. You cannot shoot the next image during this period.

(Memory Stick Tool)

Item	Setting	Description
Format	OK / Cancel	Formats the “Memory Stick.” Note that formatting irrevocably erases all data on a “Memory Stick,” including even protected images (page 43).
Create REC. Folder	OK / Cancel	Creates a folder for recording images (page 47).
Change REC. Folder	OK / Cancel	Changes a folder for recording images (page 47).

(Setup 1)

Item	Setting	Description
LCD Backlight	Bright / <input type="checkbox"/> Normal / Dark	Selects the brightness of the LCD backlight. Selecting [Bright] makes the screen bright and easy to see when using the camera outdoors or in other bright locations, but also uses up the battery charge faster. Displayed only when you are using the camera with the batteries.
Beep	Shutter <input type="checkbox"/> On Off	<ul style="list-style-type: none">– Turns on the shutter sound when you press the shutter button.– Turns on the beep/shutter sound when you press the control button/ press the shutter button.– Turns off the beep/shutter sound.
 Language	—	Displays the menu items, warnings and messages in selected language.

(Setup 2)

Item	Setting	Description
File Number	<input type="checkbox"/> Series Reset	<ul style="list-style-type: none">– Assigns numbers to files in sequence even if the “Memory Stick” is changed or the recording folder is changed.– Resets the file numbering and starts from 0001 each time the folder is changed. (When the recording folder contains a file, a number one higher than the largest number is assigned.)
USB Connect	PictBridge / PTP / <input type="checkbox"/> Normal	Switches the USB mode when connecting with a computer or a PictBridge compliant printer using the USB cable (pages 71, 82, 84 and 93).
Video Out	NTSC PAL	<ul style="list-style-type: none">– Sets the video output signal to NTSC mode (e.g., USA, Japan).– Sets the video output signal to PAL mode (e.g., Europe).
Clock Set	OK / Cancel	Sets the date and time (pages 18 and 46).

Precautions

Do not leave the camera in the following places

- In extremely hot place, such as in a car parked in the sun. The camera body may become deformed or this may cause a malfunction.
- Under direct sunlight or near a heater. The camera body may become discolored or deformed, or this may cause a malfunction.
- On rocking vibration
- Near strong magnetic place
- In sandy or dusty places, be careful not to let sand or dust get into the camera. This may cause the camera to malfunction, and in some cases this malfunction cannot be repaired.

On cleaning

Cleaning the LCD screen

Wipe the screen surface with an LCD cleaning kit (not supplied) to remove fingerprints, dust, etc.

Cleaning the lens

Wipe the lens with a soft cloth to remove fingerprints, dust, etc.

Cleaning the camera surface

Clean the camera surface with a soft cloth slightly moistened with water, then wipe the surface with a dry cloth. Do not use the following as this may damage the finish or the casing.

- Chemical products such as thinner, benzene, alcohol, disposable cloth, insect repellent or insecticide, etc.
- Touch the camera with the above on your hand
- Contact with rubber or vinyl for a long time

On operating temperature

Your camera is designed for use between the temperatures of 0°C and 40°C (32°F and 104°F). Shooting in extremely cold or hot places that exceed this range is not recommended.

On moisture condensation

If the camera is brought directly from a cold to a warm location, or is placed in a very damp room, moisture may condense inside or outside the camera. This moisture condensation may cause a malfunction of the camera.

Moisture condensation occurs easily when:

- The camera is brought from a cold location such as a ski slope into a warmly heated room
- The camera is taken from an air-conditioned room or car interior to the hot outdoors, etc.

How to prevent moisture condensation

When bringing the camera from a cold place to a warm place, seal the camera in a plastic bag and allow it to adapt to conditions at the new location over a period of time (about an hour).

If moisture condensation occurs

Turn off the camera and wait about an hour for the moisture to evaporate. Note that if you attempt to shoot with moisture remaining inside the lens, you will be unable to record clear images.

On internal rechargeable button battery

This camera has an internal rechargeable button battery for maintaining the date and time and other settings regardless of whether the power is on or off.

This rechargeable button battery is continually charged as long as you are using the camera. However, if you use the camera for only short periods it discharges gradually, and if you do not use the camera at all for about one month it becomes completely discharged. In this case, be sure to charge this rechargeable button battery before using the camera.

However, even if this rechargeable button battery is not charged, you can still use the camera as long as you do not record the date and time.

Charging method

Install charged batteries, or connect the camera to a wall outlet (wall socket) using the AC Adaptor (not supplied), and leave the camera for 24 hours or more with the power off.

- The rechargeable button battery is located behind a separate cover inside the battery insertion slot. Never remove the rechargeable button battery.

On "Memory Stick"

"Memory Stick" is a compact, portable IC recording medium with a data capacity that exceeds the capacity of a floppy disk.

The types of "Memory Stick" that can be used with this camera are listed in the table below. However, proper operation cannot be guaranteed for all "Memory Stick" functions.

"Memory Stick" type	Recording/ Playback ⁴⁾
Memory Stick	○
Memory Stick Duo ¹⁾	○
Memory Stick Duo (MagicGate/High-speed data transfer compatible) ¹⁾	○ ^{2) 3)}
MagicGate Memory Stick	○ ²⁾
MagicGate Memory Stick Duo ¹⁾	○ ²⁾
Memory Stick PRO	○ ^{2) 3)}
Memory Stick PRO Duo ¹⁾	○ ^{2) 3)}

- ¹⁾ When using "Memory Stick Duo" with this camera, be sure to insert into the Memory Stick Duo Adaptor.

- ²⁾ "MagicGate Memory Stick" and "Memory Stick PRO" are equipped with MagicGate functions. MagicGate is copyright protection technology that uses encryption technology. Data recording/playback that requires MagicGate functions cannot be performed with this camera.
- ³⁾ Supports high-speed data transfer using a parallel interface.
- ⁴⁾ 640(Fine) size movies can be recorded and played back only using "Memory Stick PRO" or "Memory Stick PRO Duo."

- "Memory Stick" formatted with a computer is not guaranteed to operate with this camera.
- Data read/write speeds differ depending on the combination of the "Memory Stick" and the equipment used.

Notes on using "Memory Stick" (supplied)

- You cannot record, edit or delete images if you slide the write-protect switch to LOCK.

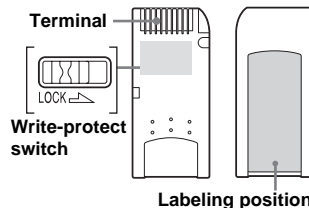

The position and/or the shape of the write-protect switch may differ depending on the "Memory Stick" you use.

- Do not remove the “Memory Stick” while reading or writing data.
- Data may be corrupted in the following cases:
 - When the “Memory Stick” is removed or the camera is turned off during read or write operation
 - When the “Memory Stick” is used in locations subject to static electricity or electrical noise
- We recommend backing up important data.
- Do not attach any other material than the supplied label on the labeling position.
- When you attach the supplied label, be sure to attach it to the labeling position. Be careful that the label does not stick out.
- When you carry or store the “Memory Stick,” put it in the case supplied with it.
- Do not touch the terminal of the “Memory Stick” with your hand or a metal object.
- Do not strike, bend or drop the “Memory Stick.”
- Do not disassemble or modify the “Memory Stick.”
- Do not expose the “Memory Stick” to water.
- Do not use or keep the “Memory Stick” under the following conditions:
 - High temperature locations such as the hot interior of a car parked in direct sunlight
 - Locations exposed to direct sunlight
 - Humid locations or locations with corrosive substances

Notes on using a “Memory Stick Duo” (not supplied)

- When using a “Memory Stick Duo” with the camera, be sure to insert the “Memory Stick Duo” into a Memory Stick Duo Adaptor. If you insert a “Memory Stick Duo” into a “Memory Stick” compliant device without a Memory Stick Duo Adaptor, you might not be able to remove it from the device.
- When inserting a “Memory Stick Duo” into a Memory Stick Duo Adaptor, make sure the “Memory Stick Duo” is inserted facing in the correct direction.
- When using a “Memory Stick Duo” inserted into a Memory Stick Duo Adaptor with the camera, make sure that the “Memory Stick Duo” is inserted facing the correct direction. Note that improper use may damage the equipment.
- Do not insert a Memory Stick Duo Adaptor into a “Memory Stick” compliant device without a “Memory Stick Duo” attached. Doing so may result in malfunction of the unit.
- When formatting the “Memory Stick Duo,” insert the “Memory Stick Duo” into the Memory Stick Duo Adaptor.
- When the “Memory Stick Duo” is equipped with the write protect switch, release its lock.

Note on using “Memory Stick PRO” (not supplied)

“Memory Stick PRO” with a capacity up to 1GB have been confirmed to operate properly with this camera.

On Nickel-Metal Hydride batteries

Effective use of the battery

- Battery performance decreases in low-temperature surroundings, and the battery life is shortened under such circumstances. To use the battery longer, we recommend you keep the battery in its case in a pocket close to your body to warm it, and insert it in your camera just before you start shooting.
- If you shoot a lot using the flash and the zoom, the battery power will be used up faster.
- We recommend having spare batteries handy for two or three times the expected shooting time, and try test shooting before actually using the camera.
- Do not expose the battery to water. The battery is not water-resistant.

Battery life

- The battery life is limited. The battery capacity decreases little by little as you use it more and more, and as time passes. When the battery operating time seems to have been considerably shortened, a probable cause is that the batteries have reached the end of their life.
- The battery life varies depending on storage, operating conditions, and environment, and is different for each battery.

On the battery charger

- Do not charge any other batteries except Sony Nickel-Metal Hydride batteries in the battery charger supplied with your camera. If you try to charge any other type of battery (e.g., manganese batteries, alkaline dry cells, primary lithium batteries, or Ni-Cd batteries) than the batteries specified, those batteries may leak, overheat, or explode, causing the danger of burns or other injuries.
- Do not charge fully charged Nickel-Metal Hydride batteries again. Otherwise, there is a danger of leaks, excessive heat, explosions, or electric shock.
- When charging a high capacity battery other than the supplied battery using the supplied battery charger, the full capacity of the battery may not be available.

- When the CHARGE lamp flashes, this may indicate a battery error or that batteries other than the specified type have been inserted. Check that the batteries are the specified type. If the batteries are the specified type, remove all the batteries, replace them with new ones or another ones and check if the battery charger operates correctly. If the battery charger operates correctly, a battery error may have occurred.

Specifications

■ Camera

[System]

Image device

9.04 mm (1/1.8 type) color CCD
Primary color filter

Total pixels number of camera

Approx. 5 255 000 pixels

Effective pixels number of camera

Approx. 5 090 000 pixels

Lens

Carl Zeiss Vario-Tessar
3× zoom lens
f = 7.9 – 23.7 mm (38 – 114 mm when converted to a 35 mm still camera)
F2.8 – 5.2

Exposure control

Automatic exposure, Manual exposure, Twilight, Twilight portrait, Candle, Landscape, Beach, Soft snap

White balance

Automatic, Daylight, Cloudy, Fluorescent, Incandescent

File format (DCF compliant)

Still images: Exif Ver. 2.2 JPEG compliant, DPOF compatible
Movies: MPEG1 compliant (Monaural)

Recording media

“Memory Stick”

Flash

Recommended distance (ISO set to Auto):
0.2 m to 3.5 m (7 7/8 inches to 11 feet 5 7/8 inches) (W)
0.3 m to 2.5 m (11 7/8 inches to 8 feet 2 1/2 inches) (T)

[Input and Output connectors]

A/V OUT (MONO) jack (Monaural)

Minijack
Video: 1 V_{p-p}, 75 Ω, unbalanced, sync negative
Audio: 327 mV (at a 47 kΩ load)
Output impedance 2.2 kΩ

USB jack

mini-B

USB communication

Hi-Speed USB (USB 2.0 compliant)

[LCD screen]

LCD panel

6.2 cm (2.5 type) TFT drive

Total number of dots

123 200 (560×220) dots

[Power, general]

Power

AA Nickel-Metal Hydride batteries (2)
2.4 V
AC-LS5 AC Adaptor (not supplied), 4.2 V

Power consumption (during shooting with LCD screen on)

1.4 W

Operating temperature

0°C to +40°C (+32°F to +104°F)

Storage temperature

–20°C to +60°C (–4°F to +140°F)

Dimensions

91 × 60 × 36.3 mm
(3 5/8 × 2 3/8 × 1 7/16 inches)
(W/H/D, excluding maximum protrusions)

Mass

Approx. 250 g (8.8 oz) (including two batteries, “Memory Stick” and wrist strap)

Microphone

Electret condenser microphone

Speaker

Dynamic speaker

Exif Print

Compatible

PRINT Image Matching II

Compatible

PictBridge

Compatible

■ BC-CS2A/CS2B Ni-MH battery charger

Power requirements

AC 100 to 240V 50/60Hz
3 W

Output voltage

AA : DC 1.4 V 400 mA × 2
AAA : DC 1.4 V 160 mA × 2

Operating temperature range

0°C to +40°C (+32°F to +104°F)

Storage temperature range

–20°C to +60°C (–4°F to +140°F)

Dimensions

71 × 30 × 91 mm
(2 7/8 × 1 3/16 × 3 5/8 inches) (W/H/D)

Mass

Approx. 90 g (3 oz)

■ AC-LS5 AC Adaptor (not supplied)

Input rating

100 V to 240 V AC, 50/60 Hz, 11 W,
0.16 A to 0.09 A

Output rating

4.2 V DC, 1.5 A

Operating temperature

0°C to +40°C (+32°F to +104°F)

Storage temperature

-20°C to +60°C (-4°F to +140°F)

Dimensions

Approx. 48 × 29 × 81 mm
(1 15/16 × 1 3/16 × 3 1/4 inches)
(W/H/D, excluding projecting parts)

Mass

Approx. 130 g (5 oz)

■ Accessories

- HR6 (size AA) Ni-MH batteries (DSC-W1: 2, DSC-W12: 4)
- Battery case (DSC-W1: 1, DSC-W12: 2)
- BC-CS2A/CS2B Ni-MH Battery charger (1)
- Power cord (mains lead) (1)
- USB cable (1)
- A/V connecting cable (1)
- Wrist strap (1)
- "Memory Stick" (32 MB) (1)
- CD-ROM (USB driver SPVD-012) (1)
- Operating instructions (1)
- Soft carrying case (DSC-W12 only) (1)

Design and specifications are subject to change without notice.

The LCD screen

When shooting still images

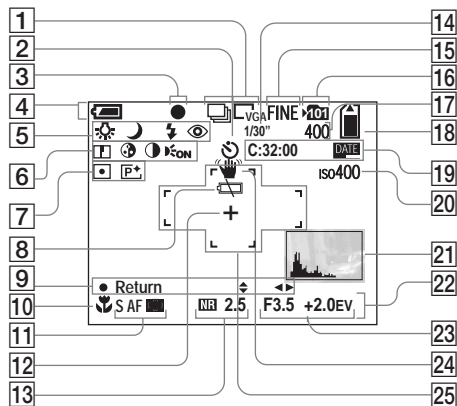

- | | |
|---|---|
| 1 Recording mode indicator (59, 60)/Image size indicator (21) | 7 Metering mode indicator (56)/Picture effect indicator (60) |
| 2 Self-timer indicator (29) | 8 Low battery warning indicator (107) |
| 3 AE/AF lock indicator (25, 50) | 9 Manual exposure setup mode indicator (51) |
| 4 Battery remaining indicator (14) | 10 Macro indicator (28) |
| 5 White balance indicator (57)/Mode dial indicator (10)/Flash mode indicator (30)/Red-eye reduction indicator (31) | 11 AF mode (49)/AF range finder frame indicator (48)/Focus preset value (50) |
| 6 Sharpness indicator (111)/Saturation indicator (111)/Contrast indicator (111)/AF illuminator indicator (31, 114) | 12 Spot metering cross hair (57) |
| | 13 NR slow shutter indicator (36)/Shutter speed indicator |

- | |
|---|
| 14 Multi Burst interval indicator (60) |
| 15 Image quality indicator (46) |
| 16 Recording folder indicator (47) |
| 17 Remaining number of recordable images indicator (23) |
| 18 Remaining "Memory Stick" capacity indicator |
| 19 Self-diagnosis display (108)/Date/time indicator (33) |
| 20 ISO number indicator (110) |
| 21 Histogram indicator (55) |
| 22 Menu/Guide menu (45) |
| 23 Aperture value indicator (51)/EV level value indicator (54) |
| 24 Vibration warning indicator (107) |
| 25 AF range finder frame (48) |

- Pressing MENU switches the menu/guide menu on/off.

Page numbers in parentheses indicate the location of additional important information.

When shooting movies

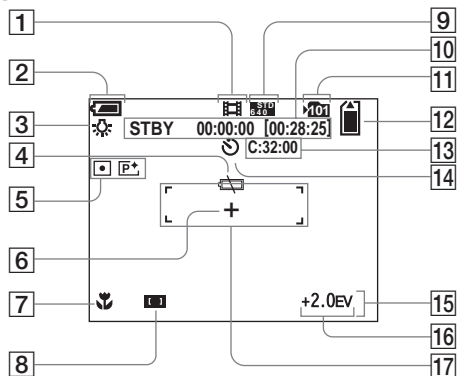

- 1 Recording mode indicator (77)
- 2 Battery remaining indicator (14)
- 3 White balance indicator (57)
- 4 Low battery warning indicator (107)
- 5 Metering mode indicator (56)/
Picture effect indicator (60)
- 6 Spot metering cross hair (57)
- 7 Macro indicator (28)
- 8 AF range finder frame indicator (48)/
Focus preset value (50)
- 9 Image size indicator (77)
- 10 Recording time [maximum recordable time] indicator (109)

- 11 Recording folder indicator (47)
- 12 Remaining "Memory Stick" capacity indicator
- 13 Self-diagnosis display (108)
- 14 Self-timer indicator (29)
- 15 Menu/Guide menu (45)
- 16 EV level value indicator (54)
- 17 AF range indicator (48)

- Pressing MENU switches the menu/guide menu on/off.

Page numbers in parentheses indicate the location of additional important information.

When playing back still images

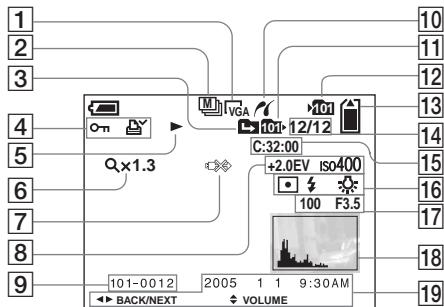

- | | |
|---|---|
| 1 Image size indicator (21) | 13 Remaining “Memory Stick” capacity indicator |
| 2 Recording mode indicator (59, 60) | 14 Image number/Number of images recorded in selected folder |
| 3 Change folder indicator (62) | 15 Self-diagnosis display (108) |
| 4 Protect indicator (67)/
Print (DPOF) mark indicator (69) | 16 Metering mode indicator (56)/
Flash indicator/White balance indicator (57) |
| 5 Playback indicator (65) | 17 Shutter speed indicator (51)/
Aperture value indicator (51) |
| 6 Zoom scaling indicator (63)/
Frame by frame playback indicator (66) | 18 Histogram indicator (55) |
| 7 Not disconnect USB cable indicator (73) | 19 Recording date/time of the playback image (33)/Menu/Guide menu (45) |
| 8 EV level value indicator (54)/
ISO number indicator (110) | |
| 9 Folder-file number (87) | |
| 10 PictBridge connecting indicator (71) | |
| 11 Playback folder indicator (62) | |
| 12 Recording folder indicator (47) | |
- Pressing MENU switches the menu/guide menu on/off.

Page numbers in parentheses indicate the location of additional important information.

When playing back moving images

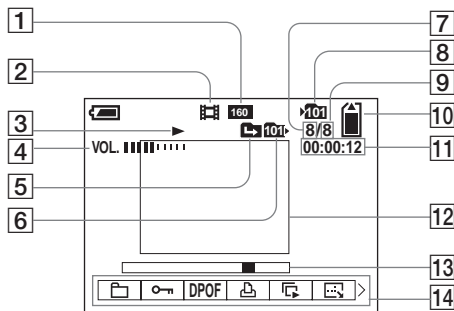

- | | |
|---|--------------------------------|
| 1 Image size indicator (78) | 11 Counter (78) |
| 2 Recording mode indicator (78) | 12 Playback image (78) |
| 3 Playback indicator (78) | 13 Playback bar (78) |
| 4 Volume indicator (78) | 14 Menu/Guide menu (45) |
| 5 Change folder indicator (62) | |
| 6 Playback folder indicator (62) | |
| 7 Image number | |
| 8 Recording folder indicator (47) | |
| 9 Number of images recorded in selected folder | |
| 10 Remaining "Memory Stick" capacity indicator | |

- Pressing MENU switches the menu/guide menu on/off.

Page numbers in parentheses indicate the location of additional important information.

Index

A

AC Adaptor	16
Access lamp	20
AE	25
AE/AF lock	25, 50
AF illuminator	31, 114
AF lock	50
AF Mode	49
AF range finder frame	48
Aperture value	51
Auto adjustment mode	24
Auto Focus	25, 48
Auto power-off function	17
Auto Review	114
A/V connecting cable	39

B

Battery life	15, 119
Battery remaining indicator	14
Beach mode	34
Beep/shutter sound	115
Burst	59
B&W	60

C

Candle mode	34
CD-ROM	83, 90, 94
Center AF	48
Charging batteries	11, 119
Charging time	12
Cleaning	116
Clock Set	18, 115
Close-ups (Macro) shooting	28
Cloudy	57
Contrast	111
Control button	17
Copying images to your computer	85, 86, 91, 93
Cutting movies	80

D

Daylight	57
Daylight synchro	30
DC plug	16
Deleting movies	79
Deleting still images	41
Digital zoom	26
Divide	80
DPOF	69

E

Enlarging an image	63
EV adjustment	54

F

File names	87
File storage destinations	87
Finder	32
Flash Level	58, 111
Flash mode	30
Fluorescent	57
Focus	48
Focus preset	50
Folder	47, 62
Format	43

H

Histogram	55
-----------------	----

I

Image quality	22, 46
Image size	21, 22
ImageMixer VCD2	94
Incandescent	57
Index screen	37
Inserting "Memory Stick"	20
Install	83, 89, 95
ISO	110

J

JPG	88
-----------	----

L	
Landscape mode	34
LCD Backlight	115
LCD backlight on/off	32
M	
Manual exposure	51
Memory Stick	43, 117
Menu settings	45, 110
Metering mode	56
Mode dial	10
Moisture condensation	116
Monitoring AF	49
MPG	88
Multi AF	48
Multi Burst	60
Multi-pattern metering	56
Multipoint AF	48
N	
NR slow shutter	36
NTSC system	40, 115
Number of images that can be shot or viewed	15, 23, 109
P	
PAL system	40, 115
PictBridge	71
Picture effect	60
Picture Package	89
Playback zoom	63
Power on/off	17
Precautions	116
Precision digital zoom	27
Print (DPOF) mark	69
Program auto shooting	10
Protect	67
PTP	82, 93, 115
Q	
Quick Review	26
R	
Red Eye Reduction	31
Remaining shooting/viewing time	15, 109
RESET button	96
Resize	68
Rotate	65

S	
Saturation	111
Screen display	32, 122
Self-diagnosis display	108
Self-timer	29
Sepia	60
SET UP	46, 114
Setting date and time	18, 114
Sharpness	111
Shooting movies	77
Shutter speed	51
Single AF	49
Single screen	37
Slide show	64
Smart zoom	26
Soft snap mode	35
Spot metering	56
Still image auto shooting	10, 48
Superimposing the date and time	33
T	
Trimming	64
TV color system	39
Twilight mode	34
Twilight portrait mode	34

U

USB cable	71, 84
USB connection	71, 84
USB driver	83
USB jack	71, 84
USB mode	82
Using your camera abroad	16

V

VGA	22
Viewing images on a TV screen	39
Viewing images on your computer	87
Viewing movies on the LCD screen	78
Viewing still images on the LCD screen	37

W

Warnings and notice messages	106
White Balance	57

Z

Zoom	26
------------	----



Printed on 100% recycled paper
using VOC (Volatile Organic
Compound)-free vegetable oil
based ink.

<http://www.sony.net/>
Sony Corporation Printed in Japan

Additional information on this product and answers to frequently
asked questions can be found at our Customer Support Website.