

# SONY®

2-659-813-11(1)

Digital Video Camera Recorder

## HANDYCAM®

### Operating Guide

### DCR-HC36/HC46/HC96

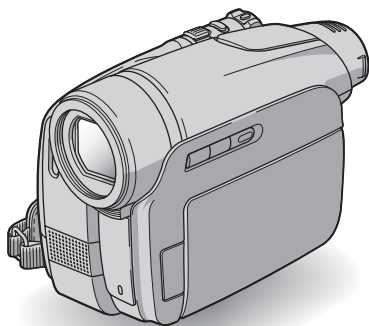

Getting Started 12



Recording/  
Playback 28

Using the Menu 44

Dubbing/Editing 71

Using a Computer 86

Troubleshooting 99

Additional Information 122

Mini DV Digital  
Video  
Cassette

MEMORY STICK™

InfoLITHIUM™  
SERIES

## WARNING

To reduce fire or shock hazard, do not expose the unit to rain or moisture.

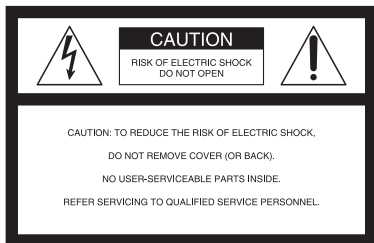

This symbol is intended to alert the user to the presence of uninsulated “dangerous voltage” within the product’s enclosure that may be of sufficient magnitude to constitute a risk of electric shock to persons.



This symbol is intended to alert the user to the presence of important operating and maintenance (servicing) instructions in the literature accompanying the appliance.

# IMPORTANT SAFEGUARDS

For your protection, please read these safety instructions completely before operating the appliance, and keep this manual for future reference.

Carefully observe all warnings, precautions and instructions on the appliance, or the one described in the operating instructions and adhere to them.

## Use

### Power Sources

This set should be operated only from the type of power source indicated on the marking label. If you are not sure of the type of electrical power supplied to your home, consult your dealer or local power company. For those sets designed to operate from battery power, or other sources, refer to the operating instructions.

### Polarization

This set may be equipped with a polarized ac power cord plug (a plug having one blade wider than the other).

This plug will fit into the power outlet only one way. This is a safety feature. If you are unable to insert the plug fully into the outlet, try reversing the plug. If the plug should still fail to fit, contact your electrician to have a suitable outlet installed. Do not defeat the safety purpose of the polarized plug by forcing it in.

### Overloading

Do not overload wall outlets, extension cords or convenience receptacles beyond their capacity, since this can result in fire or electric shock.

### Object and Liquid Entry

Never push objects of any kind into the set through openings as they may touch dangerous voltage points or short out parts that could result in a fire or electric shock. Never spill liquid of any kind on the set.

### Attachments

Do not use attachments not recommended by the manufacturer, as they may cause hazards.

## Cleaning

Unplug the set from the wall outlet before cleaning or polishing it. Do not use liquid cleaners or aerosol cleaners. Use a cloth lightly dampened with water for cleaning the exterior of the set.

## Installation

### Water and Moisture

Do not use power-line operated sets near water – for example, near a bathtub, washbowl, kitchen sink, or laundry tub, in a wet basement, or near a swimming pool, etc.

### Power-Cord Protection

Route the power cord so that it is not likely to be walked on or pinched by items placed upon or against them, paying particular attention to the plugs, receptacles, and the point where the cord exits from the appliance.

### Accessories

Do not place the set on an unstable cart, stand, tripod, bracket, or table. The set may fall, causing serious injury to a child or an adult, and serious damage to the set. Use only a cart, stand, tripod, bracket, or table recommended by the manufacturer.

### Ventilation

The slots and openings in the cabinet are provided for necessary ventilation. To ensure reliable operation of the set, and to protect it from overheating, these slots and openings must never be blocked or covered.

- Never cover the slots and openings with a cloth or other materials.
- Never block the slots and openings by placing the set on a bed, sofa, rug, or other similar surface.
- Never place the set in a confined space, such as a bookcase, or built-in cabinet, unless proper ventilation is provided.
- Do not place the set near or over a radiator or heat register, or where it is exposed to direct sunlight.

## IMPORTANT SAFEGUARDS (Continued)

### Lightning

For added protection for this set during a lightning storm, or when it is left unattended and unused for long periods of time, unplug it from the wall outlet and disconnect the antenna or cable system. This will prevent damage to the set due to lightning and power-line surges.

## Service

### Damage Requiring Service

Unplug the set from the wall outlet and refer servicing to qualified service personnel under the following conditions:

- When the power cord or plug is damaged or frayed.
- If liquid has been spilled or objects have fallen into the set.
- If the set has been exposed to rain or water.
- If the set has been subject to excessive shock by being dropped, or the cabinet has been damaged.
- If the set does not operate normally when following the operating instructions. Adjust only those controls that are specified in the operating instructions. Improper adjustment of other controls may result in damage and will often require extensive work by a qualified technician to restore the set to normal operation.
- When the set exhibits a distinct change in performance – this indicates a need for service.

### Servicing

Do not attempt to service the set yourself as opening or removing covers may expose you to dangerous voltage or other hazards.

Refer all servicing to qualified service personnel.

### Replacement parts

When replacement parts are required, be sure the service technician has used replacement parts specified by the manufacturer that have the same characteristics as the original parts.

Unauthorized substitutions may result in fire, electric shock, or other hazards.

### Safety Check

Upon completion of any service or repairs to the set, as the service technician to perform routine safety checks (as specified by the manufacturer) to determine that the set is in safe operating condition.

# Read this first

Before operating the unit, please read this manual thoroughly, and retain it for future reference.

## CAUTION

**Replace the battery with the specified type only. Otherwise, fire or injury may result.**

## For customers in the U.S.A. and CANADA

### RECYCLING LITHIUM-ION BATTERIES

Lithium-Ion batteries are recyclable. You can help preserve our environment by returning your used rechargeable batteries to the collection and recycling location nearest you.

For more information regarding recycling of rechargeable batteries, call toll free 1-800-822-8837, or visit <http://www.rbrcc.org/>

Caution: Do not handle damaged or leaking Lithium-Ion batteries.

### Battery pack

This device complies with Part 15 of the FCC Rules. Operation is subject to the following two conditions:

(1) This device may not cause harmful interference, and (2) this device must accept any interference received, including interference that may cause undesired operation.

This Class B digital apparatus complies with Canadian ICES-003.



## For customers in the U.S.A.

If you have any questions about this product, you may call:  
Sony Customer Information Center 1-800-222-SONY (7669).  
The number below is for the FCC related matters only.

### Regulatory Information

#### Declaration of Conformity

Trade Name: SONY  
Model No.: DCR-HC36  
Responsible Party: Sony Electronics Inc.  
Address: 16450 W. Bernardo Dr, San Diego, CA 92127 U.S.A.  
Telephone Number: 858-942-2230  
This device complies with Part 15 of the FCC Rules.

Operation is subject to the following two conditions:

(1) This device may not cause harmful interference, and (2) this device must accept any interference received, including interference that may cause undesired operation.

#### Declaration of Conformity

Trade Name: SONY  
Model No.: DCR-HC46  
Responsible Party: Sony Electronics Inc.  
Address: 16450 W. Bernardo Dr, San Diego, CA 92127 U.S.A.  
Telephone Number: 858-942-2230  
This device complies with Part 15 of the FCC Rules.

Operation is subject to the following two conditions:

(1) This device may not cause harmful interference, and (2) this device must accept any interference received, including interference that may cause undesired operation.

### Declaration of Conformity

Trade Name: SONY

Model No.: DCR-HC96

Responsible Party: Sony Electronics Inc.

Address: 16450 W. Bernardo Dr, San Diego, CA 92127 U.S.A.

Telephone Number: 858-942-2230

This device complies with Part 15 of the FCC Rules.

Operation is subject to the following two conditions:

(1) This device may not cause harmful interference, and (2) this device must accept any interference received, including interference that may cause undesired operation.

### Notes

- DCR-HC46 is to be used with the Handycam Station Model DCRA-C151 and AC Adaptor Model AC-L25A/L25B.
- DCR-HC96 is to be used with the Handycam Station Model DCRA-C152 and AC Adaptor Model AC-L25A/L25B.

### Owner's Record

The model and serial numbers are located on the bottom. Record the serial number in the space provided below. Refer to these numbers whenever you call upon your Sony dealer regarding this product.

Model No. DCR-HC

Serial No.

Model No. AC-

No.

### CAUTION

You are cautioned that any changes or modifications not expressly approved in this manual could void your authority to operate this equipment.

### Note

This equipment has been tested and found to comply with the limits for a Class B digital device, pursuant to Part 15 of the FCC Rules.

These limits are designed to provide reasonable protection against harmful interference in a residential installation. This equipment generates, uses, and can radiate radio frequency energy and, if not installed and used in accordance with the instructions, may cause harmful interference to radio communications.

However, there is no guarantee that interference will not occur in a particular installation. If this equipment does cause harmful interference to radio or television reception, which can be determined by turning the equipment off and on, the user is encouraged to try to correct the interference by one or more of the following measures:

- Reorient or relocate the receiving antenna.
- Increase the separation between the equipment and receiver.
- Connect the equipment into an outlet on a circuit different from that to which the receiver is connected.
- Consult the dealer or an experienced radio/TV technician for help.

The supplied interface cable must be used with the equipment in order to comply with the limits for a digital device pursuant to Subpart B of Part 15 of FCC Rules.

### Notes on use

#### Your camcorder is supplied with two kinds of operation guides.

- “Operating Guide” (This manual)
- “First Step Guide” for connecting the camcorder to a computer and using the supplied software (stored on the supplied CD-ROM)

#### Types of cassette you can use in your camcorder

You can use mini DV cassettes marked with . Mini DV cassettes with Cassette Memory are incompatible (p. 123).

## Types of “Memory Stick” you can use in your camcorder

There are two sizes of “Memory Stick.” You can use “Memory Stick Duo” marked with **MEMORY STICK DUO** or **MEMORY STICK PRO DUO** (p. 124).

“Memory Stick Duo”  
(This size can be used with your camcorder.)



“Memory Stick”  
(You cannot use it in your camcorder.)



- You cannot use any type of memory card except “Memory Stick Duo.”
- “Memory Stick PRO” and “Memory Stick PRO Duo” can be used only with “Memory Stick PRO” compatible equipment.

## When using a “Memory Stick Duo” with “Memory Stick” compatible equipment

Be sure to insert the “Memory Stick Duo” into the Memory Stick Duo Adaptor.

Memory Stick Duo Adaptor

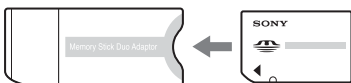

## Using the camcorder

- Do not hold the camcorder by the following parts.



Viewfinder



Battery pack



LCD panel



Shoe cover  
(DCR-HC96)

- The camcorder is not dustproof, dripproof or waterproof.  
See “Maintenance and precautions” (p. 128).
- Before connecting your camcorder to another device with a USB or i.LINK cable, be sure to insert the connector plug the correct way, and not forcibly to avoid damaging the terminal, or cause a malfunction of your camcorder.
- For DCR-HC46/HC96:  
Disconnect the AC Adaptor from the Handycam Station holding both the Handycam Station and the DC plug.
- For DCR-HC46/HC96:  
Be sure to slide the POWER switch to OFF (CHG) when you insert the camcorder into the Handycam Station or remove the camcorder from it.

## About menu items, LCD panel, viewfinder, and lens

- A menu item that is grayed out is not available under the current recording or playback conditions.

## Read this first (Continued)

- The LCD screen and the viewfinder are manufactured using extremely high-precision technology, so over 99.99% of the pixels are operational for effective use. However, there may be some tiny black points and/or bright points (white, red, blue, or green in color) that appear constantly on the LCD screen and the viewfinder. These points are normal results of the manufacturing process and do not affect the recording in any way.

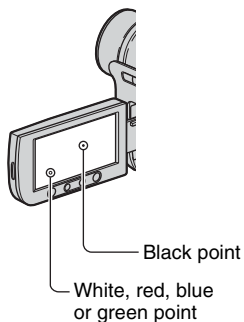

- Exposing the LCD screen, the viewfinder, or the lens to direct sunlight for long periods of time may cause malfunctions.
- Do not aim at the sun. Doing so might cause your camcorder to malfunction. Take pictures of the sun only in low light conditions, such as at dusk.

### On recording

- Before starting to record, test the recording function to make sure the picture and sound are recorded without any problems.
- Compensation for the contents of recordings cannot be provided, even if recording or playback is not possible due to a malfunction of the camcorder, storage media, etc.
- TV color systems differ depending on the countries/regions. To view your recordings on a TV, you need an NTSC system-based TV.

- Television programs, films, video tapes, and other materials may be copyrighted. Unauthorized recording of such materials may be contrary to the copyright laws.

### About this manual

- The images of the LCD screen and the viewfinder used in this manual for illustration purposes are captured using a digital still camera, and therefore may appear different.
- The on-screen displays in each local language are used for illustrating the operating procedures. Change the screen language before using your camcorder if necessary (p. 69).
- The illustrations used on this manual are based on the model DCR-HC96. The model name is indicated on the bottom of your camcorder.
- Design and specifications of recording media and accessories are subject to change without notice.

### About the Carl Zeiss lens

- Your camcorder is equipped with a Carl Zeiss lens, which was developed jointly by Carl Zeiss, in Germany, and Sony Corporation, and produces superior images. It adopts the MTF measurement system for video cameras and offers a quality typical of a Carl Zeiss lens. MTF= Modulation Transfer Function. The number value indicates the amount of light from a subject coming into the lens.
- For DCR-HC96:  
The lens for your camcorder is T\*<sup>®</sup>-coated to suppress unwanted reflections and faithfully reproduce colors.



# Table of Contents

IMPORTANT SAFEGUARDS .....	3
Read this first .....	5

## Getting Started

Step 1: Checking supplied items .....	12
Step 2: Charging the battery pack .....	13
Step 3: Turning the power on and holding your camcorder firmly .....	18
Step 4: Adjusting the LCD panel and viewfinder .....	20
Step 5: Using the touch panel .....	21
Changing the language setting .....	21
Checking the screen indicators (Display guide) .....	21
Step 6: Setting the date and time .....	23
Step 7: Inserting a tape or a "Memory Stick Duo" .....	24
Step 8: Selecting the aspect ratio (16:9 or 4:3) of the recording picture (DCR-HC46/HC96) .....	26



## Recording/Playback

Easy Recording/Playback (Easy Handycam) .....	28
Recording .....	30
Playback .....	31
Functions used for recording/playback, etc. ....	32

### Recording

- To use zoom
- To use the flash (DCR-HC96)
- To record in dark places (NightShot plus) (DCR-HC36/HC46)
- To record in dark places (NightShot) (DCR-HC96)
- To adjust the exposure for backlit subjects (BACK LIGHT)
- To adjust the focus for an off center subject (SPOT FOCUS)
- To fix the exposure for the selected subject (Flexible spot meter)
- To record in mirror mode
- To use a tripod
- To use a Shoulder belt

### Playback







- To play back the images in sequence (SLIDE SHOW)
- To use PB zoom

### Recording/playback

- To check the remaining battery (Battery Info)
- To turn off the operation confirmation beep (BEEP)
- To use special effects
- To initialize the settings (RESET)

Other part names and functions .....	36
Indicators displayed during recording/playback .....	36
Searching for the starting point .....	39
Searching for the last scene of the most recent recording (END SEARCH) .....	39
Searching manually (EDIT SEARCH) .....	39
Reviewing the most recently recorded scenes (Rec review) .....	39
Remote Commander .....	40
Searching quickly for a desired scene (Zero set memory) .....	40
Searching for a scene by date of recording (Date search) .....	41
Playing the picture on a TV .....	42

## Using the Menu

<i>Using the menu items</i> .....	44
Menu items .....	46
 CAMERA SET menu .....	49
Settings to adjust your camcorder to the recording conditions (EXPOSURE/ WHITE BAL./STEADYSHOT, etc.)	
 MEMORY SET menu .....	55
Settings for the "Memory Stick Duo" (BURST/QUALITY/IMAGE SIZE/ ALL ERASE/NEW FOLDER, etc.)	
 PICT.APPLI. menu .....	59
Special effects on pictures or additional functions on recording/playback (SLIDE SHOW/PICT. EFFECT/FRAME REC, etc.)	
 EDIT/PLAY menu .....	64
Settings for editing or playing back in various modes (VAR.SPD PB/ END SEARCH, etc.)	
 STANDARD SET menu .....	65
Settings while recording on a tape or other basic settings (REC MODE/ MULTI-SOUND/LCD/VF SET/DISP OUTPUT, etc.)	
 TIME/LANGU. menu .....	69
(CLOCK SET/WORLD TIME/LANGUAGE)	
Customizing Personal Menu .....	69

## Dubbing/Editing

Dubbing to VCR/DVD device, etc. ....	71
Recording pictures from a TV or VCR/DVD device, etc. ....	74
Dubbing pictures from a tape to a "Memory Stick Duo" .....	77
Dubbing sound to a recorded tape .....	78
Deleting recorded pictures from the "Memory Stick Duo" .....	80
Marking images on the "Memory Stick Duo" with specific information (Print mark/Image protection) .....	81

Printing recorded images (PictBridge compliant printer) .....	82
Jacks to connect external devices .....	84

## Using a Computer

Before referring to the “First Step Guide” on your computer .....	86
Installing the software and “First Step Guide” on a computer .....	89
Viewing “First Step Guide” .....	93
Creating a DVD (Direct Access to “Click to DVD”) .....	94
Connecting an analog VCR to the computer via your camcorder (Signal convert function) (DCR-HC96) .....	97

## Troubleshooting

Troubleshooting .....	99
Warning indicators and messages .....	117

## Additional Information

Using your camcorder abroad .....	122
Usable cassette tapes .....	123
About the “Memory Stick” .....	124
About the “InfoLITHIUM” battery pack .....	126
About i.LINK .....	127
Maintenance and precautions .....	128
Specifications .....	132
Index .....	137

# Step 1: Checking supplied items

Make sure that you have following items supplied with your camcorder. The number in the parentheses indicates the number of that item supplied.

- The cassette tape and “Memory Stick Duo” are not supplied. See page 6, 123, 124, for compatible cassettes and “Memory Stick Duo” for your camcorder.

AC Adaptor (1) (p. 13)

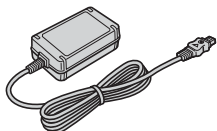

Power cord (1) (p. 13)



Handycam Station (1)  
(DCR-HC46/HC96) (p. 13)

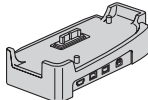

Wireless Remote Commander (1) (p. 40)



A button-type lithium battery is already installed.

A/V connecting cable (1) (p. 42, 74, 97)



USB cable (1) (p. 82, 86)



Lens cap (1)  
(DCR-HC36/HC46) (p. 18, 28, 30)

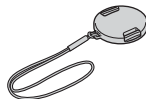

- To attach the lens cap  
Attach the lens cap to the metal fittings of the Grip belt, as illustrated below, using the strap.

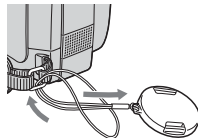

Rechargeable battery pack (1) (p. 13, 126)  
NP-FP30 (DCR-HC36)  
NP-FP50 (DCR-HC46/HC96)

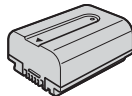

CD-ROM “Picture Package Ver.1.5.1” (1)  
(p. 86)

Operating Guide (This manual) (1)

## Step 2: Charging the battery pack

You can charge the “InfoLITHIUM” battery pack (P series) (p. 126) after attaching it to your camcorder.

For DCR-HC46/HC96:

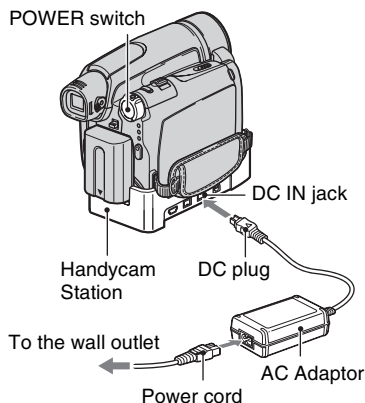

For DCR-HC36:

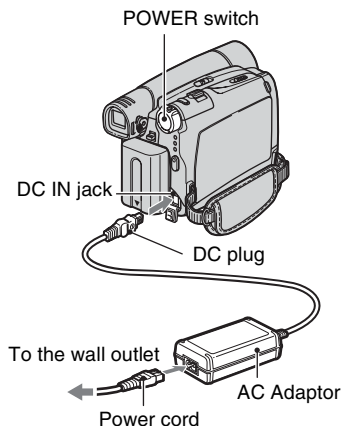

- 1 Align the terminals of the battery pack and your camcorder (①), then attach the battery pack and click it into place (②).

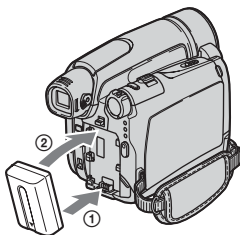

- 2 Slide the POWER switch in the direction of the arrow to OFF (CHG) (The default setting).



- 3 Connect the AC Adaptor to the DC IN jack on the Handycam Station for the DCR-HC46/HC96 or on your camcorder for the DCR-HC36.

For DCR-HC46/HC96:

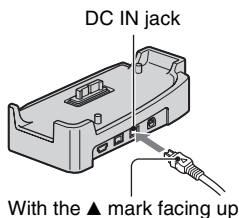

## Step2: Charging the battery pack (Continued)

For DCR-HC36:

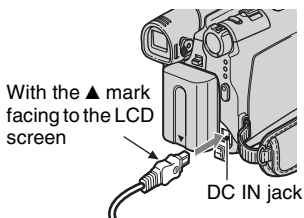

The CHG (charge) lamp lights up and charging starts.

- When inserting the camcorder into the Handycam Station, close the DC IN jack cover.

**For DCR-HC36:**

**Connect the power cord to the AC Adaptor and the wall outlet.**

CHG (charge) lamp

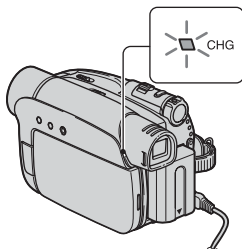

### 4 For DCR-HC46/HC96:

**Connect the power cord to the AC Adaptor and the wall outlet. Insert the camcorder into the Handycam Station securely, all the way to the bottom.**

DCR-HC96:

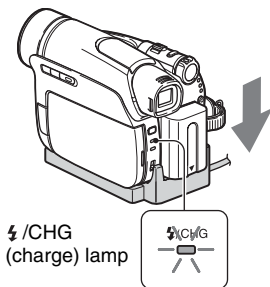

The CHG (charge) lamp lights up and charging starts.

### 5 The CHG (charge) lamp turns off when the battery is fully charged. Disconnect the AC Adaptor from the DC IN jack.

For DCR-HC46/HC96:

Disconnect the AC Adaptor from the DC IN jack holding both the Handycam Station and the DC plug.

DCR-HC46:

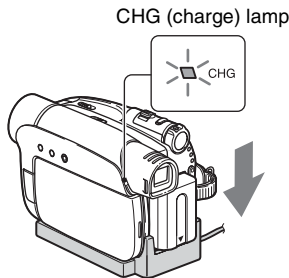

**For DCR-HC46/HC96:**

**To charge the battery pack using only the AC Adaptor**

Turn off the power, then connect the AC Adaptor to the DC IN jack on your camcorder.

- You can operate your camcorder connected to a power source such as a wall outlet as shown in the illustration. The battery pack will not lose its charge in this case.

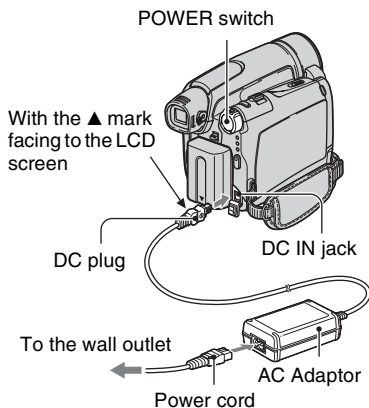

### For DCR-HC46/HC96: To remove your camcorder from the Handycam Station

Turn off the power, then remove the camcorder from the Handycam Station holding both your camcorder and the Handycam Station.

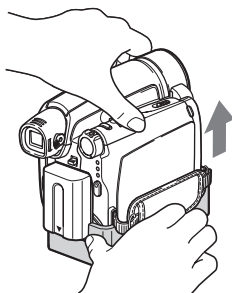

### For DCR-HC36: To use an outside power source

You can operate your camcorder using the power from the wall outlet by making the same connections as you do when charging the battery pack. The battery pack will not lose its charge in this case.

### To remove the battery pack

- Slide the POWER switch to OFF (CHG). Hold down the ▼ BATT (battery) release lever with one hand.
- Remove the battery in the direction of the arrow with the other hand.

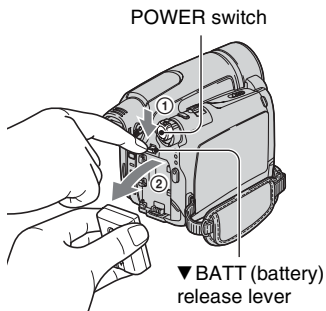

### When storing the battery pack

Fully discharge the battery before storing it for an extended period (p. 126).

### Charging time

Approximate time (min.) required when you fully charge a fully discharged battery pack.

Battery pack	Charging time
NP-FP30*1	115
NP-FP50*2	125
NP-FP70	155
NP-FP71	170
NP-FP90	220

\*1 supplied with DCR-HC36

\*2 supplied with DCR-HC46/HC96

### Recording time

Approximate time (min.) available when you use a fully charged battery pack.

## Step2: Charging the battery pack (Continued)

### DCR-HC36

Battery pack	Continuous recording time	Typical recording time*
NP-FP30 (supplied)	85	40
	105	50
NP-FP50	120	60
	150	75
NP-FP70	255	125
	310	155
NP-FP71	300	150
	370	185
NP-FP90	455	225
	550	275

- All times measured under the following conditions:  
Top: Recording with LCD screen.  
Bottom: Recording with viewfinder while the LCD panel closed.

\* Typical recording time shows the time when you repeat recording start/stop, turning the power on/off and zooming.

### DCR-HC46

Battery pack	Continuous recording time	Typical recording time*
NP-FP50 (supplied)	100	55
	115	65
	115	65
NP-FP70	215	120
	240	130
	240	130
NP-FP71	255	140
	290	160
	290	160
NP-FP90	385	210
	435	240
	435	240

- All times measured under the following conditions:  
Top: Recording with LCD screen.  
Middle: When the LCD backlight turns off.  
Bottom: Recording with viewfinder while the LCD panel closed.

\* Typical recording time shows the time when you repeat recording start/stop, turning the power on/off and zooming.

### DCR-HC96

Battery pack	Continuous recording time	Typical recording time*
NP-FP50 (supplied)	80	45
	85	45
	90	50
NP-FP70	170	95
	185	100
	190	105
NP-FP71	200	110
	220	120
	230	125
NP-FP90	300	165
	335	185
	345	190

- All times measured under the following conditions:  
Top: Recording with LCD screen.  
Middle: When the LCD backlight turns off.  
Bottom: Recording with viewfinder while the LCD panel closed.

\* Typical recording time shows the time when you repeat recording start/stop, turning the power on/off and zooming.

### Playing time

Approximate time (min.) available when you use a fully charged battery pack.

### DCR-HC36

Battery pack	LCD panel opened	LCD panel closed
NP-FP30 (supplied)	90	110
NP-FP50	125	160
NP-FP70	265	330
NP-FP71	315	395
NP-FP90	475	580



**DCR-HC46**

Battery pack	LCD panel opened*	LCD panel closed
NP-FP50 (supplied)	120	150
NP-FP70	255	310
NP-FP71	300	370
NP-FP90	455	550

\* When the LCD backlight turns on.

**DCR-HC96**

Battery pack	LCD panel opened*	LCD panel closed
NP-FP50 (supplied)	115	140
NP-FP70	240	295
NP-FP71	290	350
NP-FP90	435	525

\* When the LCD backlight turns on.

**On the battery pack**

- Before changing the battery pack, slide the POWER switch to OFF (CHG).
- The CHG (charge) lamp flashes during charging, or the Battery Info (p. 35) will not be correctly displayed under the following conditions.
  - The battery pack is not attached correctly.
  - The battery pack is damaged.
  - The battery pack is worn-out (For Battery Info only).
- The power will not be supplied from the battery as long as the AC Adaptor is connected to the DC IN jack of your camcorder or the Handycam Station supplied with the DCR-HC46/HC96, even when the power cord is disconnected from the wall outlet.

**On the charging/recording/playback time**

- Times measured with the camcorder at 25°C (77°F). (10 - 30 °C (50 - 86°F) is recommended.)
- The recording and playback time will be shorter when you use your camcorder in low temperatures.
- The recording and playback time will be shorter depending on the conditions under which you use your camcorder.

**On the AC Adaptor**

- Use the nearby wall outlet when using the AC Adaptor. Disconnect the AC Adaptor from the wall outlet immediately if any malfunction occurs while using your camcorder.
- Do not use the AC Adaptor placed in a narrow space, such as between a wall and furniture.
- Do not short-circuit the DC plug of the AC Adaptor or battery terminal with any metallic objects. This may cause a malfunction.

**PRECAUTION**

- Even if your camcorder is turned off, AC power (house current) is still supplied to it while connected to the wall outlet via the AC Adaptor.

# Step 3: Turning the power on and holding your camcorder firmly

To record or play back, slide the POWER switch repeatedly to turn on the respective lamp.

When using it for the first time, the [CLOCK SET] screen appears (p. 23).

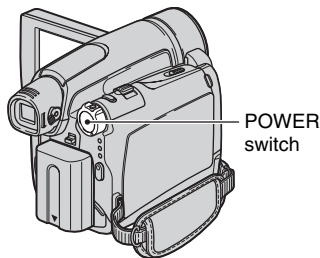

**1** Slide the **POWER** switch repeatedly in the direction of the arrow to turn on the respective lamp.

For DCR-HC36/HC46:  
Remove the lens cap by pressing both knobs on the sides of the cap.

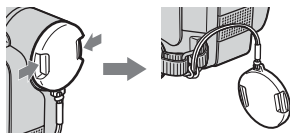

For DCR-HC96:  
The lens cover opens automatically when the POWER switch is set to CAMERA-TAPE or CAMERA-MEMORY.

If the POWER switch is set to OFF (CHG), slide it while pressing the green button.

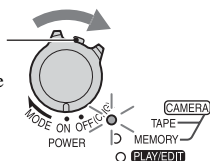

## Lamps that light up

**CAMERA-TAPE:** To record on a tape.

**CAMERA-MEMORY:** To record on a "Memory Stick Duo."

**PLAY/EDIT:** To play or edit pictures.

- After you have set the date and time ([CLOCK SET], p. 23), the next time you turn on the power of your camcorder, the current date and time will be displayed on the LCD screen for a few seconds.

**2** Hold the camcorder correctly.

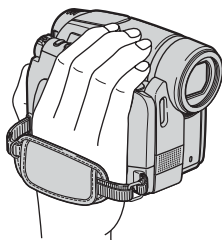

**3** Ensure a good grip, then fasten the Grip belt.

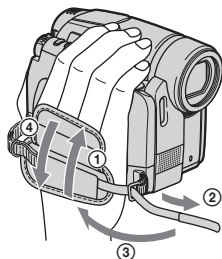

## To turn off the power

Slide the POWER switch to OFF (CHG).

For DCR-HC36/HC46:

Attach the lens cap after turning off the power.

- At the time of purchase, the power will be set to turn off automatically if you leave your camcorder without any operation attempted for approximately 5 minutes, to save battery power ([A.SHUT OFF], p. 68).
- If warning messages appear on the screen, follow the instructions (p. 118).

# Step 4: Adjusting the LCD panel and viewfinder

## The LCD panel

Open the LCD panel 90 degrees to the camcorder (①), then rotate it to the best angle to record or play (②).

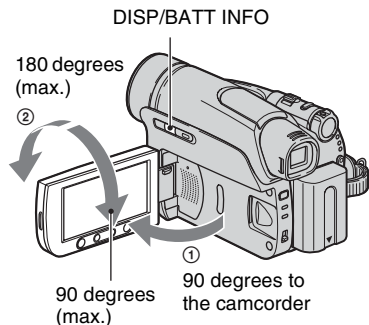

- Do not press the buttons on the LCD frame accidentally when you open or adjust the LCD panel.
- If you rotate the LCD panel 180 degrees to the lens side, you can close the LCD panel with the LCD screen facing out. This is convenient during playback operations.

### For DCR-HC46/HC96: To turn off the LCD backlight to make the battery last longer

Press and hold DISP/BATT INFO for a few seconds until  appears.

This setting is practical when you use your camcorder in bright conditions or where you want to save battery power. The recorded picture will not be affected by the setting. To turn on the LCD backlight, press and hold DISP/BATT INFO for a few seconds until  disappears.

- See [LCD/VF SET] - [LCD BRIGHT] (p. 66) to adjust the brightness of the LCD screen.

## The viewfinder

You can view pictures using the viewfinder to avoid wearing down the battery, or when the picture seen on the LCD screen is poor.

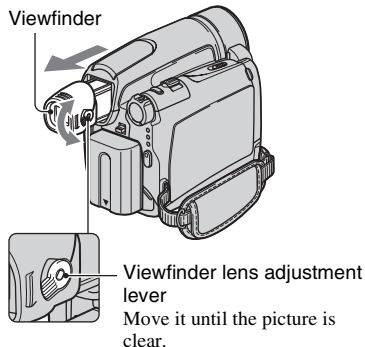

- You can adjust the brightness of the viewfinder backlight by selecting [LCD/VF SET] - [VF B.LIGHT] (p. 66).
- You can adjust the [FADER] and the [EXPOSURE] setting using the viewfinder (p. 60).

## Step 5: Using the touch panel

You can play back recorded pictures (p. 31), or change the settings (p. 44) using the touch panel.

**Place your hand on the rear side of the LCD panel to support it. Then, touch the buttons displayed on the screen.**

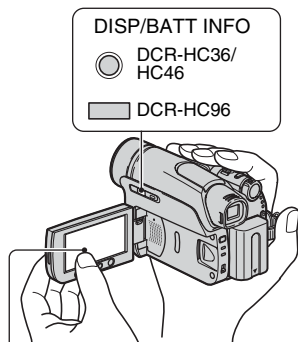

Touch the button on the LCD screen.

- Perform the same actions as explained above when you press the buttons on the LCD frame.
- Be careful not to press buttons on the LCD frame accidentally while using the touch panel.
- If the buttons on the touch panel do not work correctly, adjust the LCD screen (CALIBRATION) (p. 130).
- Dots in lines may appear on the LCD screen, but this is not a malfunction. These dots are not recorded.

### To hide the screen indicators

Press DISP/BATT INFO to toggle the screen indicators (such as time code) on or off.

### Changing the language setting

You can change the on-screen displays to show messages in a specified language. Select the screen language in [LANGUAGE] on the (TIME/LANGU.) menu (p. 44, 69).

### Checking the screen indicators (Display guide)

You can easily check the meaning of each indicator (p. 38) that appears on the LCD screen.

#### 1 Touch [P-MENU].

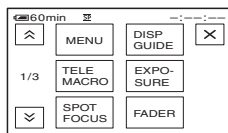

Touch [MENU] during Easy Handycam operation (p. 28).

#### 2 Touch [DISP GUIDE].

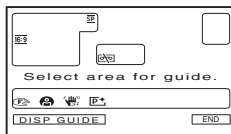



The indicators vary depending on the settings.

## Step 5: Using the touch panel (Continued)

---

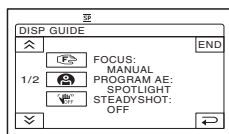
### 3 Touch the area including the indicator that you want to check.



The meanings of the indicators in the area are listed on the screen. If you cannot find the indicator you want to check, touch / to toggle.

When you touch , the screen returns to the area selecting display.

---

### To finish the operation

Touch [END].

## Step 6: Setting the date and time

Set the date and time when using this camcorder for the first time. If you do not set the date and time, the [CLOCK SET] screen appears every time you turn on your camcorder or change the POWER switch position.

- If you do not use your camcorder for **about 3 months**, the built-in rechargeable battery gets discharged and the date and time settings may be cleared from the memory. In that case, charge the rechargeable battery and then set the date and time again (p. 131).

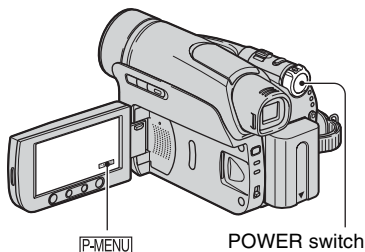

Skip to step 4 when you set the clock for the first time.

- 1 Touch **P-MENU** → **[MENU]**.

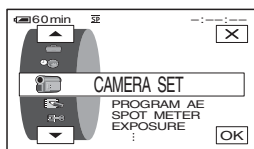

- 2 Select **(TIME/LANGU.)** menu with **▲/▼**, then touch **OK**.

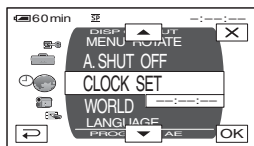

- 3 Select **[CLOCK SET]** with **▲/▼**, then touch **OK**.

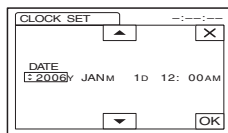

- 4 Set **[Y]** (year) with **▲/▼**, then touch **OK**.

You can set any year up to the year 2079.

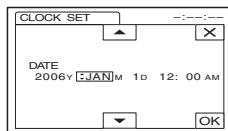

- 5 Set **[M]** (month), **[D]** (day), hour and minute, then touch **OK**.

For midnight, set it to 12:00 AM.

For midday, set it to 12:00 PM.

The clock starts.

- The date and time are not displayed while recording, but they are automatically recorded on the tape, and can be displayed during playback (see page 67 for [DATA CODE]) (During Easy Handycam operation, you can set only [DATE/TIME]).

# Step 7: Inserting a tape or a “Memory Stick Duo”

## Cassette tape

You can use mini DV **Mini DV** cassettes only (p. 123).

- The recordable time varies depending on [RECORD] REC MODE] (p. 65).

- 1** Slide and hold the  OPEN/EJECT lever in the direction of the arrow and open the lid.

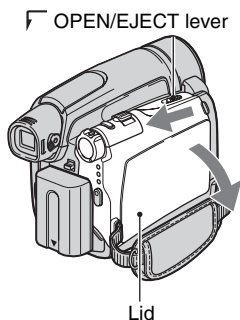

The cassette compartment automatically comes out and opens up.

- 2** Insert a cassette with its window facing outwards, then press .

Push the center of the back of the cassette lightly.

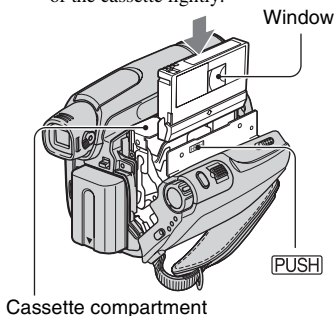

The cassette compartment automatically slides back in.

- Do not force the cassette compartment closed by pressing the portion marked  while it is sliding in. It may cause a malfunction.

- 3** Close the lid.

## To eject the cassette

Open the lid following the same procedure as described in Step 1 and remove the cassette.

- For DCR-HC46/HC96:  
Do not insert/eject the cassette while your camcorder is on the Handycam Station. This may cause a malfunction.



## “Memory Stick Duo”

You can use only a “Memory Stick Duo” marked with **MEMORY STICK DUO** or **MEMORY STICK PRO DUO** (p. 124).

- The number and time of recordable pictures varies depending on the image quality or the image size. For details, see page 56.

### 1 Open the LCD panel.

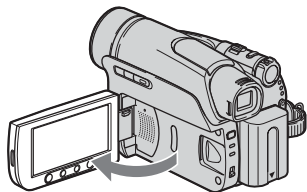

### 2 Insert the “Memory Stick Duo” into the “Memory Stick Duo” slot in the right direction until it clicks.

DCR-HC96:

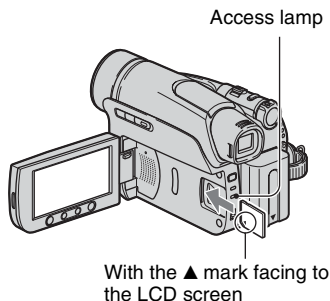

DCR-HC36/HC46:

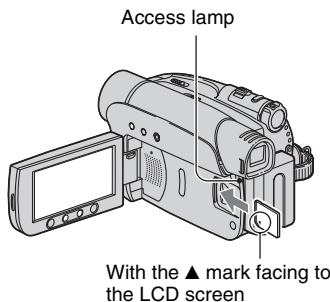

- If you force the “Memory Stick Duo” into the slot in the wrong direction, the “Memory Stick Duo,” the “Memory Stick Duo” slot, or image data may be damaged.

### To eject a “Memory Stick Duo”

Lightly push in once and slide out the “Memory Stick Duo” alongside the camcorder body.

- Do not remove the “Memory Stick Duo” forcibly with the fingers as it may be damaged.
- When the access lamp is lit or flashing, your camcorder is reading/writing data. Do not shake or knock your camcorder, turn the power off, eject the “Memory Stick Duo,” or remove the battery pack. Otherwise, image data may be damaged.
- When inserting or ejecting the “Memory Stick Duo,” be careful that the “Memory Stick Duo” does not pop out and drop.

## Step 8: Selecting the aspect ratio (16:9 or 4:3) of the recording picture (DCR-HC46/HC96)

By recording in the 16:9 (wide) mode, you can enjoy wide-angle, high-quality pictures.

- If you intend to view pictures on a wide TV, recording in the 16:9 (wide) mode is recommended.

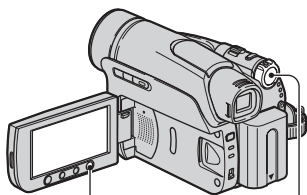

WIDE SELECT button    POWER switch

### Selecting the aspect ratio for recording movies on a tape

Be sure to set the POWER switch to CAMERA-TAPE.

**Press WIDE SELECT repeatedly to select the desired screen aspect ratio.**

16:9\*



4:3\*







\* When viewing on the LCD screen. It may be different in the viewfinder.

- Differences in the angle of view between 4:3 and 16:9 vary depending on the zoom position.
- If you play back a picture on TV, set [TV TYPE] for playback in the aspect ratio of the TV (p. 43).

- When viewing pictures recorded in 16:9 aspect ratio with [TV TYPE] set to [4:3], pictures may appear rough depending on the subject (p. 43).

### Recording a moving picture or still image on the "Memory Stick Duo"

- ① Set the POWER switch to CAMERA-MEMORY.  
The aspect ratio of the picture switches to 4:3.
  - ② Press WIDE SELECT to select the desired screen aspect ratio.
- If you record movies (MPEG MOVIE EX) in the 16:9 (wide) mode, black bands appear at the top and bottom of the picture when they are played back.
  - For the number of recordable pictures, see page 56.
  - For DCR-HC46:  
Still images will be fixed to image size [0.7M] () in the 16:9 (wide) mode. In the 4:3 mode, you can select up to [1.0M] ().
  - For DCR-HC96:  
Still images will be fixed to image size [2.3M] () in the 16:9 (wide) mode. In the 4:3 mode, you can select up to [3.0M] ().





# Easy Recording/Playback (Easy Handycam)

With this Easy Handycam operation, most of the camera settings are automatically optimally adjusted, which frees you from detailed adjustments. The screen font size increases for easy viewing.

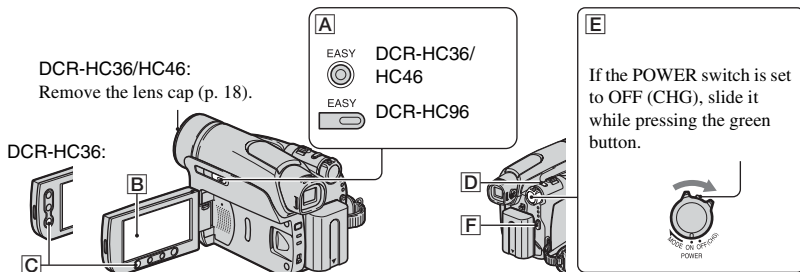

## Movies

- Slide the POWER switch **E** to turn on the CAMERA-TAPE lamp.



- Press EASY **A**.

**EASY** appears on the screen **B**.

- Press REC START/STOP **F** (or **C**) to start recording.\*<sup>1</sup>



The indicator changes [STBY] to [REC].

To stop recording, press **F** again.

## Still images (4:3)

- Slide the POWER switch **E** to turn on the CAMERA-MEMORY lamp.



- Press EASY **A**.

**EASY** appears on the screen **B**.

- Press PHOTO **D** to record.\*<sup>2</sup>



Press and hold lightly to adjust the focus. Press fully to record.

When **||||** disappears, the image has been recorded.

\*<sup>1</sup> Movies are recorded in SP (Standard Play) mode on a cassette.

\*<sup>2</sup> Still images are recorded in [FINE] quality on a "Memory Stick Duo."

## Playing back movies/still images

Slide the **POWER** switch **E** to turn on the **PLAY/EDIT** lamp. Touch the buttons on the screen **B** as follows.

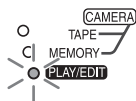

### Movies

Touch **◀◀**, then touch **▶▶** to start playback.

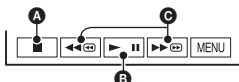

- A** Stop
- B** Play/Pause toggles
- C** Rewind/Fast forward

### Still images

Touch **MEMORY** → **-** / **+** to select a picture.

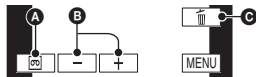

- A** Tape playback
- B** Previous/Next
- C** Delete (p. 80)

## ■ To cancel Easy Handycam operation

Press **EASY** **A** again. **EASY** disappears from the screen.

## ■ Adjustable menu settings during Easy Handycam operation

Touch **[MENU]** to display adjustable menu settings. See page 45 for details on settings.

- Almost all the settings return to the default setting automatically (p. 46).
- **[P-MENU]** is not displayed during Easy Handycam operation.
- Cancel Easy Handycam operation if you want to add any effects or settings to the images. Almost all the settings are returned to the previous status.

## ■ Unavailable buttons during Easy Handycam

During Easy Handycam operation, the following buttons are unavailable, since the items are set automatically. **[Invalid during Easy Handycam operation.]** may appear if operations not available during Easy Handycam are attempted.

- **BACK LIGHT** button (p. 33)
- **PHOTO** button (in the **CAMERA-TAPE** mode) (p. 30)
- **REC START/STOP** button (in the **CAMERA-MEMORY** mode) (p. 30).
- For **DCR-HC46/HC96**:  
Pressing and holding **DISP/BATT INFO** button (p. 20)
- For **DCR-HC46/HC96**:  
**WIDE SELECT** button (in the **CAMERA-MEMORY** mode) (p. 26)

# Recording

Lens cap (DCR-HC36/HC46)

Remove the lens cap by pressing both knobs on the sides of the cap.

Lens cover (DCR-HC96)

Opens in accordance with the setting of the POWER switch.

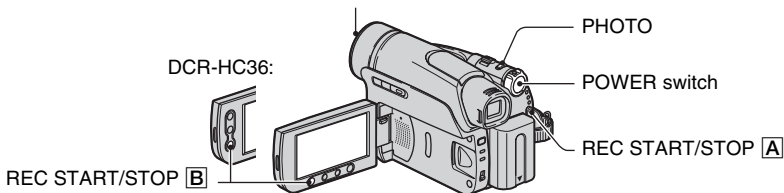

## 1 Slide the POWER switch in the direction of the arrow repeatedly to turn on the respective lamp to select a recording medium.

To record on a tape, light up the CAMERA-TAPE lamp.

To record on a “Memory Stick Duo,” light up the CAMERA-MEMORY lamp.

If the POWER switch is set to OFF (CHG), slide it while pressing the green button.

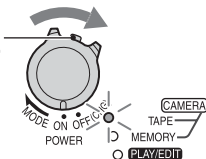

## 2 Start recording.

**Movies**

Press REC START/STOP **A** (or **B**).

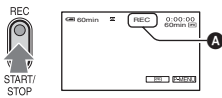

The indicator **(A)** changes [STBY] (tape only) to [REC].

- The sound of a movie (MPEG MOVIE EX) recorded on a “Memory Stick Duo” will be monaural.

**Still images**

Press and hold PHOTO lightly to adjust the focus **(A)**, then press it fully **(B)**.

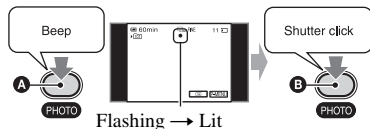

A shutter sound is heard. When disappears, the image has been recorded.

## To stop movie recording

Press REC START/STOP again.

- While recording movies on a tape, or while in standby mode, you can record a still image on a “Memory Stick Duo” by pressing PHOTO fully. Still images will be fixed to image size [0.2M] in 16:9 screen (DCR-HC46/HC96), or [VGA (0.3M)] in 4:3 screen.

## To check the latest recording on a “Memory Stick Duo”

Touch . To delete the picture, touch → [YES].

# Playback

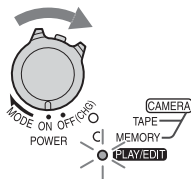

- 1** Slide the **POWER** switch in the direction of the arrow repeatedly to turn on the **PLAY/EDIT** lamp.



## 2 Start playing back.

### Movies

**On a Tape:**

Touch , then touch  to start playback.

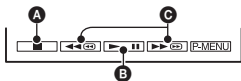

- A** Stop
- B** Play/Pause toggles as you touch it
  - Playback automatically stops if pause is engaged for more than 3 minutes.
- C** Rewind/Fast forward

**On a “Memory Stick Duo”:**



Touch  →  /  to select a picture with , then touch .

### Still images

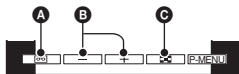

**Touch** .



The most recently recorded image is displayed.







- A** Tape playback
  - B** Previous/Next
  - C** Index screen display
- When a “Memory Stick Duo” is inserted, touch  to display .  is not displayed when an inserted “Memory Stick Duo” contains no image data.

### To adjust the volume

Touch  → [VOLUME], then  /  to adjust the volume.

- If you cannot find [VOLUME] in , touch  (p. 44).

### To search for a scene during playback

Touch and hold  /  during playback (Picture Search), or  /  while fast forwarding or rewinding the tape (Skip Scan).



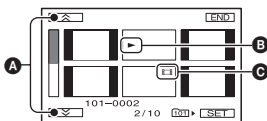

- You can play back in various modes ( VAR. SPD PB], p. 64).

### To display pictures on a “Memory Stick Duo” on the Index screen

Touch . Touch one of the pictures to back to the single display mode.



- A** Previous/Next 6 pictures
- B** The picture displayed before switching to the index screen.
- C** Movie icon

To view pictures in other folders, touch  →  → [PB FOLDER], select a folder with  / , then touch  (p. 59).

# Functions used for recording/playback, etc.

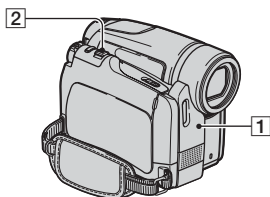

For DCR-HC36:

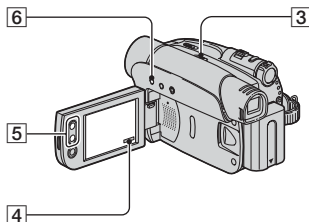

For DCR-HC46:

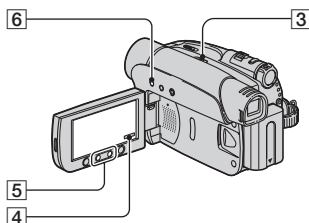

For DCR-HC96:

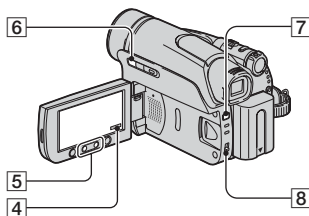

## Recording

To use zoom ..... [2] [5]

Move the power zoom lever [2] slightly for a slower zoom. Move it further for a faster zoom.

**Wider range of view: (Wide angle)**

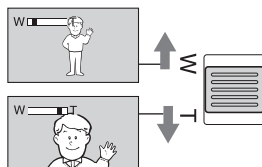

**Close view: (Telephoto)**

- You cannot change the zoom speed with the zoom buttons [5] on the LCD frame.
- The minimum possible distance between camcorder and subject while maintaining sharp focus is about 1 cm (about 13/32 in.) for wide angle and about 80 cm (about 2 5/8 feet) for telephoto.
- You can set [DIGITAL ZOOM] (p. 54) if you want to zoom to a level greater than the following:
  - 20 × (DCR-HC36)
  - 12 × (DCR-HC46)
  - 10 × (DCR-HC96)
- Be sure to keep your finger on the power zoom lever. If you move your finger off the power zoom lever, the operation sound of the power zoom lever may also be recorded.

To use the flash (DCR-HC96)..... [7]

Press  (flash) repeatedly to select an appropriate setting.

**No indication (Auto flash):**

Automatically flashes when there is insufficient ambient light.



 **(Forced flash):** Always uses the flash regardless of the surrounding brightness.



 **(No flash):** Records without flash.

- The recommended distance to the subject when using the built-in flash is 0.3 to 2.5 m (1 to 8 feet).



- Remove any dust from the surface of the flash lamp before using it. Flash effect may be impaired if heat discoloration or dust obscures the lamp.
- The flash charge lamp flickers when charging the flash, and remains lit when the battery charge is complete (In the CAMERA-TAPE mode, it takes a while to fully charge the flash lamp).
- If you use the flash in bright places such as when shooting a backlit subject, the flash may not be effective.
- Attaching a conversion lens (optional) may create a shadow.
- You can change the brightness of the flash by setting [FLASH LEVEL], or you can prevent the red-eye by setting [REDEYE REDUC], in [FLASH SET] (p. 52).

### To record in dark places (NightShot plus) (DCR-HC36/HC46) ..... [3]

Set the NIGHTSHOT PLUS switch [3] to ON. (☑ and ["NIGHTSHOT PLUS"] appear.)

- To record an image brighter, use Super NightShot plus function (p. 52).  
To record an image more faithful to the original colors, use Color Slow Shutter function (p. 53).
- The NightShot plus and Super NightShot plus function use infrared light. Therefore, do not cover the infrared port [1] with your fingers or other objects. Remove the conversion lens (optional) if it is attached.
- Adjust the focus manually ([FOCUS], p. 51) when it is hard to focus automatically.
- Do not use these functions in bright places. This may cause a malfunction.

### To record in dark places (NightShot) (DCR-HC96) ..... [8]

Set the NIGHTSHOT switch [8] to ON. (☑ and ["NIGHTSHOT"] appear.)

- To record an image brighter, use Super NightShot function (p. 52).  
To record an image brighter in color in dim light, use Color Slow Shutter function (p. 53).
- The NightShot and Super NightShot function use infrared light. Therefore, do not cover the infrared port [1] with your fingers or other objects. Remove the conversion lens (optional) if it is attached.

- Adjust the focus manually ([FOCUS], p. 51) when it is hard to focus automatically.
- Do not use these functions in bright places. This may cause a malfunction.

### To adjust the exposure for backlit subjects (BACK LIGHT) ..... [6]

To adjust the exposure for backlit subjects, press BACK LIGHT [6] to display ☑. To cancel the back light function, press BACK LIGHT again.

### To adjust the focus for an off center subject (SPOT FOCUS) ..... [4]

See [SPOT FOCUS] on page 51.

### To fix the exposure for the selected subject (Flexible spot meter) ..... [4]

See [SPOT METER] on page 49.

## Functions used for recording/playback, etc. (Continued)

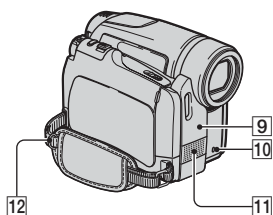

### For DCR-HC36:

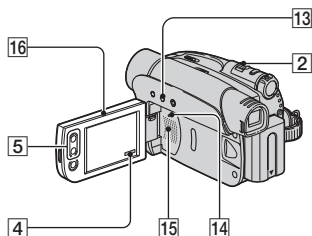

### For DCR-HC46/HC96:

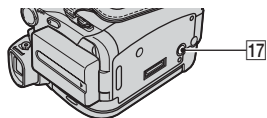
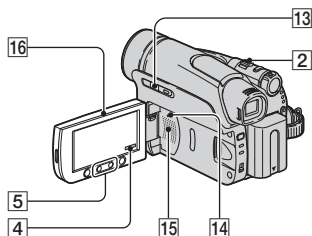

### To record in mirror mode ..... 16

Open the LCD panel 16 90 degrees to the camcorder (1), then rotate it 180 degrees to the lens side (2).

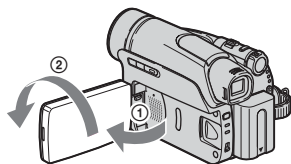

- A mirror-image of the subject appears on the LCD screen, but the picture will be normal when recorded.

### To use a tripod ..... 17

Attach the tripod (optional: the length of the screw must be less than 5.5 mm (7/32 in.)) to the tripod receptacle 17 using a tripod screw.

### To use a Shoulder belt ..... 12

Attach the Shoulder belt (optional) to its designated hook 12.

## Playback

### To play back the images in sequence (SLIDE SHOW) ..... 4

See [SLIDE SHOW] on page 60.

### To use PB zoom ..... 2 5

You can magnify pictures from about 1.1 to 5 times the original size.

Magnification can be adjusted with the power zoom lever 2 or the zoom buttons 5 on the LCD frame.

- 1 Play back the picture you want to magnify.
- 2 Magnify the picture with T (Telephoto).
- 3 Touch the screen at the point you want to display in the center of the displayed frame.
- 4 Adjust the magnification with W (Wide angle)/T (Telephoto).

To cancel, touch [END].

- You cannot change the zoom speed with the zoom buttons [5] on the LCD frame.

## Recording/playback

### To check the remaining battery (Battery Info) ..... [13]

Set the POWER switch to OFF (CHG), then press DISP/BATT INFO [13]. The battery information appears for about 7 seconds. You can view the battery information for up to 20 seconds by pressing DISP/BATT INFO again while the battery information is displayed.

Remaining battery (approx.)

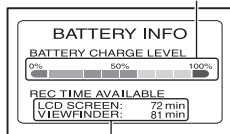

Recording capacity (approx.)

### To turn off the operation confirmation beep (BEEP) ..... [4]

See [BEEP] on page 68.

### To use special effects ..... [4]

See [ ] (PICT.APPL.) menu on page 59.

### To initialize the settings (RESET) ..... [14]

Press RESET [14] to initialize all the settings, including the setting of the date and time.

(Menu items customized on Personal Menu are not initialized.)

## Other part names and functions

- [9] Remote sensor  
Point the Remote Commander (p. 40) towards the remote sensor to operate your camcorder.
- [10] Recording lamp (DCR-HC96)  
The recording lamp lights up in red during recording (p. 68).
  - The recording lamp flashes if the remaining tape or battery power is low.
- [11] Internal stereo microphone  
For DCR-HC96:  
An Active Interface Shoe compatible microphone will take precedence when connected (p. 78).
- [15] Speaker  
Playback sound come out from the speaker.
  - For how to adjust the volume, see page 31.

# Indicators displayed during recording/playback

## Recording movies

### In the CAMERA-TAPE mode

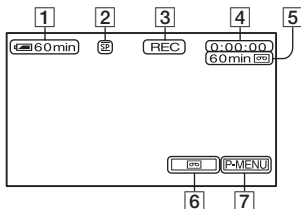

- 1 Remaining battery (approx.)
- 2 Recording mode (SP or LP) (65)
- 3 Recording status ([STBY] (standby) or [REC] (recording))
- 4 Recording: Tape counter (hour: minute: second)  
Playback: Tape counter (hour: minute: second)/Time code (hour: minute: second: frame)
- 5 Recording capacity of the tape (approx.) (68)
- 6 END SEARCH/EDIT SEARCH/Rec review display switch button (39)
- 7 Personal Menu button (44)

### In the CAMERA-MEMORY mode

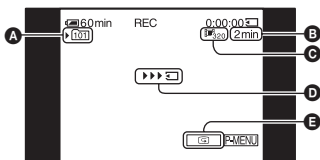

- A Recording folder (59)
- B Estimated recordable time
- C Movie size (58)
- D Recording start indicator (appears for about 5 seconds)
- E Review button (30)

## Recording still images

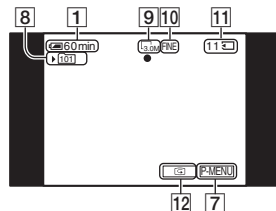

- 8 Recording folder (59)
- 9 Image size (26, 56) (DCR-HC46/HC96)
- 10 Quality (FINE or STD) (56)
- 11 “Memory Stick Duo” indicator and the number of images that can be recorded (approx.)
- 12 Review button (30)

## Data code during recording

The date/time during recording and the camera setting data will be recorded automatically. They do not appear on the screen during recording, but you can check them as [DATA CODE] during playback (p. 67).

( ) is a reference page.

The indicators during recording will not be recorded.

## Viewing movies

### On a tape

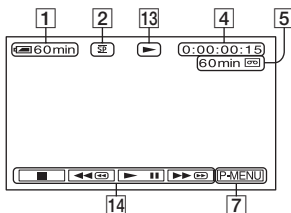

- 13 Tape transport indicator
- 14 Video operation buttons (31)

### On a “Memory Stick Duo”

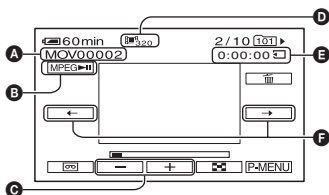

- A Data file name
- B Play/Pause button (31)
- C Previous/Next image button (31)
- D Image size (58)
- E Playing time
- F Previous/Next scene button

A movie file will be divided into a maximum of 60 scenes. The number of scenes divided depends on the length of the movie. After selecting a scene from which to start the playback, touch **[MPEG▶]** to play back.

## Viewing still images

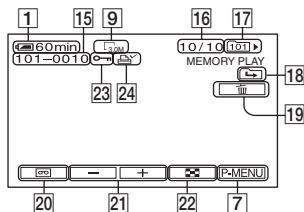

- 15 Data file name
- 16 Picture number/Total number of recorded pictures in the current playback folder
- 17 Playback folder (59)
- 18 Previous/Next folder icon

The following indicators appear when the first or last picture of the current folder is displayed and when there are multiple folders on the same “Memory Stick Duo.”

- : Touch **[−]** to move to the previous folder.
- : Touch **[+]** to move to the next folder.
- : Touch **[−]/[+]** to move to either the previous or the next folder.

- 19 Image delete button (80)
- 20 Tape playback select button (31)
- 21 Previous/Next image button (31)
- 22 Index screen display button (31)
- 23 Image protection mark (81)
- 24 Print mark (81)

## Indicators when you made changes

You can use the [DISP GUIDE] (p. 21) to check the function of each indicator that appears on the LCD screen.

- Some of the indicators may not appear when you use [DISP GUIDE].

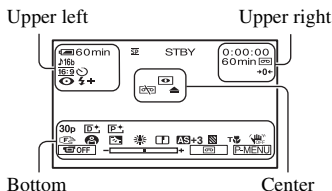

### Upper left

Indicator	Meaning
	AUDIO MODE (65)
	Continuous photo recording (55)
	Self-timer recording (53)
	WIDE SELECT (26, 54)
	Interval photo recording (63)
	Flash light (52)
	Frame recording (62)

### Upper right

Indicator	Meaning
	A/V → DV OUT (67, 97)
	DV input (74)
	DV output (71)
	i.LINK connection (71, 74)
	Zero set memory (40)
	Slide show (60)
	LCD backlight off (20)

### Center

Indicator	Meaning
	Night Shot/NightShot plus (33)
	Super NightShot/Super NightShot plus (52)
	Color Slow Shutter (53)
	PictBridge connecting (82)
	Warning (117)

### Bottom

Indicator	Meaning
	AE SHIFT (51)
	Picture effect (62)
	Digital effect (60)
	Manual focus (51)
	PROGRAM AE (49)
	Sharpness (51)
	Backlight (33)
	White balance (50)
	FLD/FRAME (56)
	SteadyShot off (55)
<b>30p</b>	Progressive recording (55)
	Zebra (53)
	Tele macro (52)
	Flexible spot meter (49)/EXPOSURE (50)
	Panel off (60)

### Other indicator

Indicator	Meaning
	Information (118)

# Searching for the starting point

Make sure that the **CAMERA-TAPE** lamp lights up (p. 30).

## Searching for the last scene of the most recent recording (END SEARCH)

[END SEARCH] will not work once you eject the cassette after you have recorded on the tape.

Touch  → .

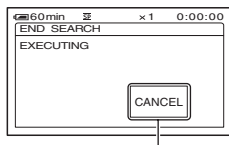

Touch here to cancel the operation.

The last scene of the most recent recording is played back for about 5 seconds, and the camcorder enters the standby mode at the point where the last recording has finished.



- [END SEARCH] will not work correctly when there is a blank section between recorded sections on the tape.
- You can also select [END SEARCH] from the menu. When the **PLAY/EDIT** lamp lights up, select the [END SEARCH] short-cut in Personal Menu (p. 44).

## Searching manually (EDIT SEARCH)

You can search for the start point to start the next recording while viewing the pictures on the screen. The sound is not played back during the search.

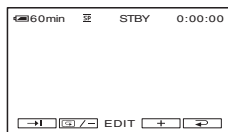
1 Touch .



2 Touch and hold  /  (to go backward) /  (to go forward) and release it at the point where you want the recording to start.

## Reviewing the most recently recorded scenes (Rec review)

You can view about 2 seconds of the scene recorded just before you stopped the tape.

Touch  → .

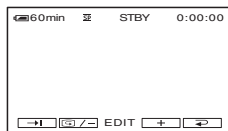

The last 2 seconds (approx.) of the most recently recorded scene are played back. Then, your camcorder is set to the standby.

# Remote Commander

Remove the insulation sheet before using the Remote Commander.

Insulation sheet

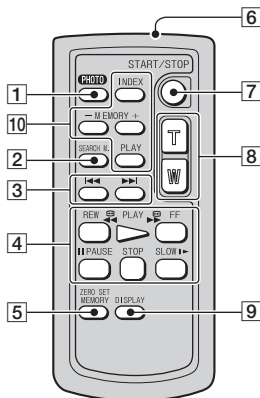
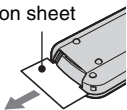

- 1** PHOTO\*<sup>1</sup> (p. 30)  
The on-screen image when you press this button will be recorded onto the "Memory Stick Duo" as a still image.
- 2** SEARCH M. (p. 41)\*<sup>2</sup>
- 3** ◀▶▶▶\*<sup>2</sup>
- 4** Video control buttons (Rewind, Playback, Fast-forward, Pause, Stop, Slow) (p. 31)
- 5** ZERO SET MEMORY\*<sup>2</sup>
- 6** Transmitter
- 7** REC START/STOP (p. 28, 30)
- 8** Power zoom (p. 32, 34)
- 9** DISPLAY (p. 21)
- 10** Memory control buttons (Index\*<sup>2</sup>, -/+ , Memory playback) (p. 31)

\*<sup>1</sup> Not available during Easy Handycam operation with the POWER switch is set to CAMERA-TAPE.

\*<sup>2</sup> Not available during Easy Handycam operation.

- Aim the Remote Commander towards the remote sensor to operate your camcorder (p. 35).
- To change the battery, see page 131.

## Searching quickly for a desired scene (Zero set memory)

- 1** During playback, press **ZERO SET MEMORY** **5** at a point you want to locate later on.

The tape counter is reset to "0:00:00" and +0+ appears on the screen.

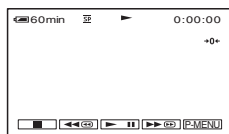

If the tape counter is not displayed, press **DISPLAY** **9**.

- 2** Press **STOP** **4** when you want to stop playback.

- 3** Press **◀◀REW** **4**.

The tape stops automatically when the tape counter reaches "0:00:00."

The tape counter returns to the time code display, and the zero set memory display disappears.



---

#### 4 Press PLAY [4].

Playback starts from the point designated "0:00:00" on the tape counter.

---

- The Date search will not function correctly when there is a blank section between recorded sections on the tape.

#### To cancel the operation

Press ZERO SET MEMORY [5] again before rewinding.

- There may be a discrepancy of several seconds between the time code and the tape counter.
- Zero set memory will not function correctly if there is a blank section between recorded sections on the tape.

### Searching for a scene by date of recording (Date search)

You can locate the point where the recording date changes.

---

#### 1 Slide the POWER switch repeatedly to turn on the PLAY/EDIT lamp.

---

#### 2 Press SEARCH M. [2].

---

#### 3 Press ◀◀(previous)/▶▶(next) [3] to select a recording date.

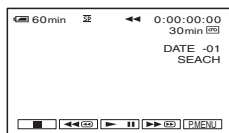

---

#### To cancel the operation

Press STOP [4].

# Playing the picture on a TV

You can connect your camcorder to the input jack of a TV or a VCR using the A/V connecting cable (1) or the A/V connecting cable with S VIDEO (2). Connect your camcorder to the wall outlet using the supplied AC Adaptor for this operation (p. 13). Refer also to the instruction manuals supplied with the devices to be connected.

- For DCR-HC46/HC96:

Do not insert/eject the cassette while your camcorder is on the Handycam Station. This may cause a malfunction.

## DCR-HC36:

A/V OUT jack

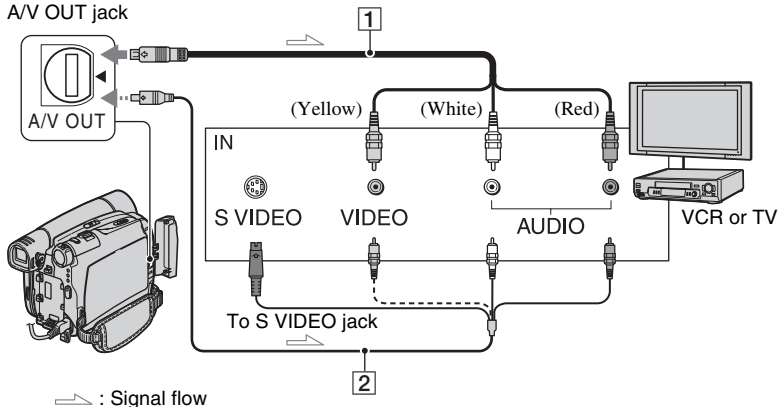

## DCR-HC46/HC96:

A/V or A/V OUT jack

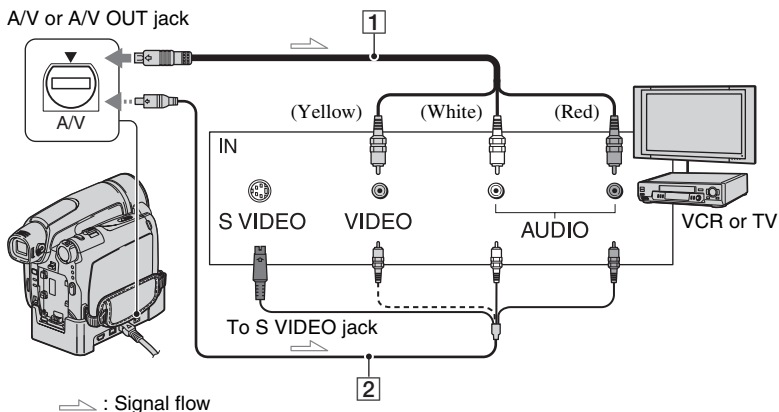

**1 A/V connecting cable (supplied)**

For DCR-HC46/HC96:

The Handycam Station and your camcorder are both equipped with A/V jacks (p. 84). Connect the A/V connecting cable either to the Handycam Station or to your camcorder, depending on your setup.

**2 A/V connecting cable with S VIDEO (optional)**

When connecting to another device via the S VIDEO jack, by using the A/V connecting cable with an S VIDEO cable, pictures can be reproduced more faithfully than with the supplied A/V cable connection.

Connect the white and red plugs (left/right audio) and S VIDEO plug (S VIDEO channel) of an A/V connecting cable. In this case, the yellow (standard video) plug connection is not necessary. S VIDEO connection only will not output audio.

- You can display the time code on the TV screen by setting [DISP OUTPUT] to [V-OUT/PANEL] (p. 68).
- For DCR-HC46/HC96:  
Do not connect A/V connecting cable to both the Handycam Station and your camcorder at the same time, as image disturbance may occur.

**When connecting your camcorder to a TV through a VCR**

Connect your camcorder to the LINE IN input on the VCR. Set the input selector on the VCR to LINE (VIDEO 1, VIDEO 2, etc.), if the VCR has an input selector.

**To set the aspect ratio according to the connected TV (16:9/4:3) (DCR-HC46/HC96)**

Change the aspect ratio of the image according to the screen size of your TV.

- ① Slide the POWER switch repeatedly to turn on the PLAY/EDIT lamp.
- ② Touch [P-MENU] → [MENU] →  (STANDARD SET) → [TV TYPE] → [16:9] or [4:3] → [OK].

- When you set [TV TYPE] to [4:3], or when the picture's aspect ratio switches between 16:9 and 4:3, the image may jitter.

- On some 4:3 TVs, the still image recorded in 4:3 aspect ratio may not appear in full screen. This is not a malfunction.



- When you play back a picture recorded in 16:9 aspect ratio on a 4:3 TV not compatible with the 16:9 signal, set [TV TYPE] to [4:3].

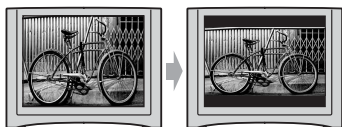

- When you connect your camcorder to a TV compatible with the ID-1/ID-2 system, and play back the tape, set [TV TYPE] to [16:9]. The TV automatically switches the aspect ratio according to the playback picture.

**When your TV is monaural (Only one audio input jack)**

Connect the yellow plug of the A/V connecting cable to the video input jack and connect the white (left channel) or the red (right channel) plug to the audio input jack of your TV or VCR.

# Using the menu items

Follow the instructions below to use each of the menu items listed after this page.

## 1 Slide the POWER switch in the direction of the arrow repeatedly to turn on the respective lamp.

CAMERA-TAPE lamp:  settings on a tape

CAMERA-MEMORY lamp:  settings on a "Memory Stick Duo"

PLAY/EDIT lamp: settings for viewing/editing

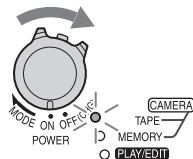

## 2 Touch the LCD screen to select the menu item.

Unavailable items will be grayed out.

### ■ To use the short-cuts of Personal Menu



On Personal Menu, short-cuts for frequently used menu items are added.

- You can customize Personal Menu as you like (p. 69).

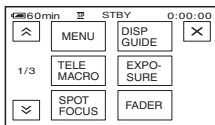
#### ① Touch **P-MENU**.



#### ② Touch the desired item.

If the desired item is not displayed on the screen, touch / until the item is displayed.

#### ③ Select the desired setting, then touch **OK**.

### ■ To use menu items

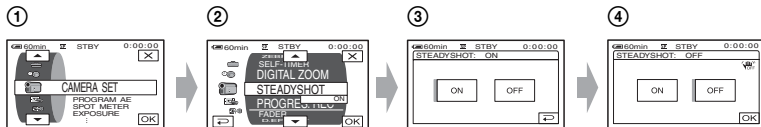

You can customize menu items that are not added to Personal Menu.



#### ① Touch **P-MENU** → **[MENU]**.

The menu index screen appears.

#### ② Select the desired menu.

Touch / to select the item, then touch **OK**. (The process in step ③ is the same as that in step ②.)

#### ③ Select the desired item.

- You can also touch the item directly to select it.

#### ④ Customize the item.

After finishing the settings, touch **[OK]** → **[X]** (close) to hide the menu screen.

If you decide not to change the setting, touch **[↶]** to return to the previous screen.

## ■ To use menu items during Easy Handycam operation

**[P-MENU]** is not displayed during Easy Handycam operation (p. 28).



- ① Touch **[MENU]**.

The menu index screen appears.

- ② Select the desired menu.

- ③ Change your item setting.

After finishing the settings, touch **[OK]**.

If you decide not to change the setting, touch **[↶]** to return to the previous screen.

- Cancel Easy Handycam operation to use menu items normally (p. 29).

# Menu items



Available menu items (●) vary depending on which lamp is lit.  
During Easy Handycam operation, the following settings are automatically applied (p. 28).

	TAPE	MEMORY	PLAY/EDIT	Easy Handycam
<b>CAMERA SET menu</b> (p. 49)				
PROGRAM AE	●	●	—	AUTO
SPOT METER	●	●	—	—
EXPOSURE	●	●	—	AUTO
WHITE BAL.	●	●	—	AUTO
SHARPNESS* <sup>1</sup>	●	●	—	—
AUTO SHUTTER	●	—	—	ON
AE SHIFT* <sup>1</sup>	●	●	—	OFF
SPOT FOCUS	●	●	—	—
FOCUS	●	●	—	AUTO
TELE MACRO	●	●	—	OFF
FLASH SET* <sup>1</sup>	●	●	—	⚡ * <sup>6</sup> /OFF
SUPER NSPLUS* <sup>2</sup>	●	—	—	OFF
SUPER NS* <sup>1</sup>	●	—	—	OFF
NS LIGHT	●	●	—	ON
COLOR SLOW S	●	—	—	OFF
ZEBRA* <sup>1</sup>	●	●	—	OFF
SELF-TIMER	●	●	—	●* <sup>5</sup>
DIGITAL ZOOM	●	—	—	OFF
WIDE SELECT* <sup>3</sup>	●	—	—	4:3
STEADYSHOT	●	—	—	ON
PROGRES.REC* <sup>1</sup>	●	—	—	OFF

<b>MEMORY SET menu</b> (p. 55)				
STILL SET	—	●	●	OFF* <sup>4</sup> /FINE/●* <sup>4</sup> /FIELD* <sup>3</sup>
MOVIE SET	—	●	●	—
ALL ERASE	—	—	●	●
FORMAT	—	●	●	—
FILE NO.	—	●	●	SERIES
NEW FOLDER	—	●	●	—
REC FOLDER	—	●	●	—* <sup>6</sup>
PB FOLDER	—	—	●	—* <sup>6</sup>

	TAPE	MEMORY	PLAY/EDIT	Easy Handycam
 <b>PICT.APPLI. menu</b> (p. 59)				
FADER	●	–	–	OFF
SLIDE SHOW	–	–	●	–
D. EFFECT	●	–	●	OFF
PICT. EFFECT	●	–	●	OFF
FRAME REC* <sup>1</sup>	●	–	–	OFF
SMTH INT.REC* <sup>4</sup>	●	–	–	–
INT.REC-STL	–	●	–	OFF
DEMO MODE	●	–	–	ON
PictBridge PRINT	–	–	●	–
USB SELECT	–	–	●	●

 **EDIT/PLAY menu** (p. 64)

 VAR. SPD PB	–	–	●	–
 REC CTRL	–	–	●	–
AUD DUB CTRL	–	–	●	–
 REC MOVIE	–	–	●	–
BURN DVD	–	–	●	–
BURN VCD	–	–	●	–
END SEARCH	●	–	●	–

\*<sup>1</sup> DCR-HC96

\*<sup>2</sup> DCR-HC36/HC46





\*<sup>3</sup> DCR-HC36

\*<sup>4</sup> DCR-HC46/HC96

\*<sup>5</sup> Cannot be operated in the CAMERA-TAPE mode.

\*<sup>6</sup> The setting value before entering Easy Handycam operation will be retained.

## Menu items (Continued)

	TAPE	MEMORY	PLAY/EDIT	Easy Handycam
 <b>STANDARD SET menu</b> (p. 65)				
 REC MODE	●	–	●	SP
AUDIO MODE	●	–	●*1	12BIT
VOLUME	–	–	●	●
MULTI-SOUND	–	–	●	STEREO
AUDIO MIX	–	–	●	–
LCD/VF SET	●	●	●	–/NORMAL/ – / NORMAL/ –*6
A/V → DV OUT*1	–	–	●	OFF
VIDEO INPUT*1	–	–	●	–*6
TV TYPE*4	●	●	●	–*6
USB CAMERA	●	–	–	OFF
DISP GUIDE	●	●	●	●
GUIDEFAME*1	●	●	–	OFF
DATA CODE	–	–	●	●
 REMAINING	●	–	●	AUTO
REMOTE CTRL	●	●	●	ON
REC LAMP*1	●	●	–	ON
BEEP	●	●	●	●
DISP OUTPUT	●	●	●	LCD PANEL
MENU ROTATE	●	●	●	–
A.SHUT OFF	●	●	●	5 min
CALIBRATION	–	–	●	–
 <b>TIME/LANGU. menu</b> (p. 69)				
CLOCK SET	●	●	●	●
WORLD TIME	●	●	●	–*6
LANGUAGE	●	●	●	–*6

\*1 DCR-HC96

\*2 DCR-HC36/HC46

\*3 DCR-HC36

\*4 DCR-HC46/HC96

\*5 Cannot be operated in the CAMERA-TAPE mode.

\*6 The setting value before entering Easy Handycam operation will be retained.



# CAMERA SET menu

Settings to adjust your camcorder to the recording conditions (EXPOSURE/WHITE BAL./STEADYSHOT, etc.)

The default settings are marked with ►. The indicators in parentheses appear when the items are selected.

See page 44 for details on selecting menu items.

## PROGRAM AE

You can record pictures effectively in various situations with the PROGRAM AE function.

### ► AUTO

Select to automatically record pictures effectively without the [PROGRAM AE] function.

### SPOTLIGHT\*()

Select to prevent people's faces from appearing excessively white when subjects are lit by strong light.



### PORTRAIT (Soft portrait) ()

Select to bring out the subject such as people or flowers while creating a soft background.



### SPORTS\* (Sports lesson) ()

Select to minimize shake when shooting fast moving subjects.



### BEACH&SKI\*()

Select to prevent people's faces from appearing dark in strong light or reflected light, such as at a beach in midsummer or on a ski slope.



### SUNSET&MOON\*\*()

Select to maintain the atmosphere of situations such as sunsets, general night views or fireworks.



### LANDSCAPE\*\*()

Select to shoot distant subjects clearly. This setting also prevents your camcorder from focusing on glass or metal mesh in windows that comes in between the camcorder and the subject.



- Items with one asterisk (\*) can be adjusted to focus on subjects only a short distance away. Items with two asterisks (\*\*) can be adjusted to focus on subjects farther away.
- The setting returns to [AUTO] when you turn the power off for more than 12 hours.

## SPOT METER (Flexible spot meter)

You can adjust and fix the exposure to the subject, so that it is recorded in suitable brightness even when there is strong contrast between the subject and the background, such as subjects in the spotlight on stage.

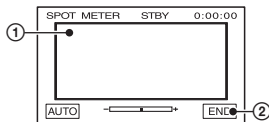

- ① Touch the point where you want to fix and adjust the exposure on the screen.

— appears.

- ② Touch [END].

To return the setting to automatic exposure, touch [AUTO] → [END].

- If you set [SPOT METER], [EXPOSURE] is automatically set to [MANUAL].
- The setting returns to [AUTO] when you turn the power off for more than 12 hours.

### EXPOSURE

You can fix the brightness of a picture manually. When recording indoors on a clear day, for instance, you can avoid backlight shadows on people next to the window by fixing the exposure to that of the wall side of the room.

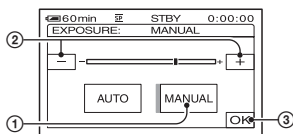

- ① Touch [MANUAL].

— appears.

- ② Adjust the exposure by touching [−]/[+].

- ③ Touch [OK].

To return the setting to automatic exposure, touch [AUTO] → [OK].

- You can adjust [EXPOSURE] and [FADER] while using the viewfinder by having the LCD panel rotated 180 degrees and closed with the screen facing out (p. 59).
- The setting returns to [AUTO] when you turn the power off for more than 12 hours.

### WHITE BAL. (White balance)

You can adjust the color balance to the brightness of the recording environment.

#### ▶ AUTO

The white balance is adjusted automatically.

#### OUTDOOR (☀)

The white balance is adjusted to be appropriate for the following recording conditions:

- Outdoors
- Night views, neon signs and fireworks
- Sunrise or sunset
- Under daylight fluorescent lamps

#### INDOOR (☾)

The white balance is adjusted to be appropriate for the following recording conditions:

- Indoors
- At party scenes or studios where the lighting conditions change quickly
- Under video lamps in a studio, or under sodium lamps or incandescent-like color lamps

#### ONE PUSH (📷)

The white balance will be adjusted according to the ambient light.

- ① Touch [ONE PUSH].

- ② Frame a white object such as a piece of paper, to fill the screen under the same lighting conditions as you will shoot the subject.

- ③ Touch [📷].

📷 flashes quickly. When the white balance has been adjusted and stored in the memory, the indicator stops flashing.

- Do not shake your camcorder while 📷 is flashing quickly.
- 📷 flashes slowly if white balance could not be set.
- If 📷 keeps flashing even after you have touched [OK], set [WHITE BAL.] to [AUTO].

- If you have changed the battery pack while [AUTO] is selected, taken your camcorder outdoors or brought it indoors after outside use while using fixed exposure, select [AUTO] and aim your camcorder at a nearby white object for about 10 seconds for better color balance adjustment.

- Redo the [ONE PUSH] procedure if you change the [PROGRAM AE] settings, or bring your camcorder outdoors from inside the house, or vice versa.
- Set [WHITE BAL.] to [AUTO] or [ONE PUSH] under white or cool white fluorescent lamps.
- The setting returns to [AUTO] when you turn the power off for more than 12 hours.

## SHARPNESS (DCR-HC96)

You can adjust the sharpness of the image outline with  $\left[ \text{---} \right] / \left[ \text{+} \right]$ .  $\left[ \text{---} \right]$  appears when the sharpness is anything other than the default setting.



## AUTO SHUTTER

Automatically activates the electronic shutter to adjust the shutter speed when recording in bright conditions if you set it to [ON] (the default setting).

## AE SHIFT (DCR-HC96)

You can adjust the exposure using  $\left[ \text{---} \right]$  (dark)/ $\left[ \text{+} \right]$  (bright).  $\left[ \text{AS} \right]$  and the setting value appear when [AE SHIFT] is set.

- Touch  $\left[ \text{+} \right]$  if the subject is white or the backlight is bright, or touch  $\left[ \text{---} \right]$  if the subject is black or the light is dim.
- You can adjust the automatic exposure level to brighter or darker when [EXPOSURE] is set to [AUTO].

## SPOT FOCUS

You can select and adjust the focal point to aim it at a subject not located in the center of the screen.

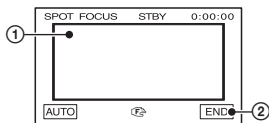

- ① Touch the subject on the screen.

$\left[ \text{Ⓢ} \right]$  appears.

- ② Touch [END].

To adjust the focus automatically, touch [AUTO] → [END] in step ①.

- If you set [SPOT FOCUS], [FOCUS] is automatically set to [MANUAL].
- The setting returns to [AUTO] when you turn the power off for more than 12 hours.

## FOCUS

You can adjust the focus manually. You can select this function also when you want to focus on a certain subject intentionally.

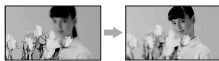

- ① Touch [MANUAL].

$\left[ \text{Ⓢ} \right]$  appears.

- ② Touch  $\left[ \text{---} \right]$  (focusing on close subjects)/ $\left[ \text{+} \right]$  (focusing on distant subjects) to sharpen the focus.  $\left[ \text{---} \right]$  appears when the focus cannot be adjusted any closer, and  $\left[ \text{+} \right]$  appears when the focus cannot be adjusted farther away.

- ③ Touch [OK].

To adjust the focus automatically, touch [AUTO] → [OK] in step ①.

- It is easier to focus on the subject by moving the power zoom lever towards T (Telephoto) to adjust the focus, then towards W (Wide angle) to adjust the zoom for recording. When you want to record a subject at close range, move the power zoom lever to W (Wide angle), then adjust the focus.
- The minimum possible distance between camcorder and subject while maintaining sharp focus is about 1 cm (about 13/32 in.) for wide angle and about 80 cm (about 2 5/8 feet) for telephoto.
- The setting returns to [AUTO] when you turn the power off for more than 12 hours.

## TELE MACRO

This is useful to shoot small subjects, such as flowers or insects. You can blur out backgrounds and the subject stands out clearer.

When you set [TELE MACRO] to [ON] (T), the zoom (p. 32) moves to the top of the T (Telephoto) side automatically and allows for recording subjects at a close distance as follows:

For DCR-HC36: down to about 39 cm (15 3/8 in.).

For DCR-HC46: down to about 35 cm (13 7/8 in.).

For DCR-HC96: down to about 37 cm (14 5/8 in.).

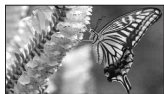

To cancel, touch [OFF], or zoom to wide-angle (W side).

- When recording a distant subject, focusing may be difficult and can take some time.
- Adjust the focus manually ([FOCUS], p. 51) when it is hard to focus automatically.

## FLASH SET (DCR-HC96)

You can set this function when you use the built-in flash or an external flash (optional) that is compatible with your camcorder.

## ■ FLASH LEVEL

## HIGH(++)

Makes the flash level higher.

## ▶ NORMAL(±)

## LOW(--)

Makes the flash level lower.

## ■ REDEYE REDUC

You can prevent redevye by activating the flash before recording.

Set [REDEYE REDUC] to [ON], then press **⚡** (flash) (p. 32) repeatedly to select a setting.

⦿ (Auto redevye reduction): Pre-flashes to reduce redevye before the flash automatically flashes when there is insufficient ambient light.



⦿⚡ (Forced redevye reduction): Always uses the flash and the redevye reducing pre-flash.



⦿ (No flash): Records without flash.

- The redevye reduction may not produce the desired effect due to individual differences and other conditions.

## SUPER NSPLUS (Super NightShot plus) (DCR-HC36/HC46)

The picture will be recorded at a maximum of 16 times the sensitivity of NightShot plus recording if you set [SUPER NSPLUS] to [ON] while the NIGHTSHOT PLUS switch (p. 33) is also set to ON.

S and ["SUPER NIGHTSHOT PLUS"] appear on the screen.

To cancel the setting, set [SUPER NSPLUS] to [OFF] or set the NIGHTSHOT switch to OFF.

- Do not use NightShot plus/[SUPER NSPLUS] in bright places. This may cause a malfunction.
- Do not cover the infrared port with your fingers or other objects (p. 33).
- Remove the conversion lens (optional) if it is attached.
- Adjust the focus manually ([FOCUS], p. 51) when it is hard to focus automatically.
- The shutter speed of your camcorder changes depending on the brightness. The motion of the picture may slow down in this case.

## SUPER NS (Super NightShot) (DCR-HC96)

The picture will be recorded at a maximum of 16 times the sensitivity of NightShot

recording if you set [SUPER NS] to [ON] while the NIGHTSHOT switch (p. 33) is also set to ON.  
 and ["SUPER NIGHTSHOT"] appear on the screen.

To cancel the setting, set [SUPER NS] to [OFF] or set the NIGHTSHOT switch to OFF.

- Do not use NightShot/[SUPER NS] in bright places. This may cause a malfunction.
- Do not cover the infrared port with your fingers or other objects (p. 33).
- Remove the conversion lens (optional) if it is attached.
- Adjust the focus manually ([FOCUS], p. 51) when it is hard to focus automatically.
- The shutter speed of your camcorder changes depending on the brightness. The motion of the picture may slow down in this case.

### NS LIGHT (NightShot Light)

You can record clearer pictures by setting [NS LIGHT], which emits infrared light (invisible), to [ON] (the default setting) using either of the functions below:

- For DCR-HC36/HC46:  
NightShot plus or [SUPER NSPLUS] (p. 33).
- For DCR-HC96:  
NightShot or [SUPER NS] (p. 52).
- Do not cover the infrared port with your fingers or other objects (p. 33).
- Remove the conversion lens (optional) if it is attached (p. 33).
- The maximum shooting distance using [NS LIGHT] is about 3 m (10 feet).
- For DCR-HC36/HC46:  
If you record subjects in dark places, such as night scenes or in moonlight, set [NS LIGHT] to [OFF]. You can make the image color deeper this way.

### COLOR SLOW S (Color Slow Shutter)

When you set [COLOR SLOW S] to [ON], you can record an image brighter in color even in dark places.

 and [COLOR SLOW SHUTTER] appear on the screen.

To cancel [COLOR SLOW S], touch [OFF].

- Adjust the focus manually ([FOCUS], p. 51) when it is hard to focus automatically.
- The shutter speed of your camcorder changes depending on the brightness. The motion of the picture may slow down at this time.

### ZEBRA (DCR-HC96)

This is useful as a guide when adjusting the brightness. When you change the default setting,  is displayed. The zebra pattern is not recorded.

#### ► OFF

The zebra pattern is not displayed.

#### 70

The zebra pattern appears at a screen brightness level of about 70 IRE.

#### 100

The zebra pattern appears at a screen brightness level of about 100 IRE or higher.

- Portions of the screen where brightness is about 100 IRE or above may appear overexposed.
- The zebra pattern is diagonal stripes that appear in portions of the screen where brightness is at a preset level.

### SELF-TIMER

When you set [SELF-TIMER] to [ON] () , the self-timer starts recording in about 10 seconds after pressing REC START/STOP to record the movie, or PHOTO to record still images.

To cancel the count down, touch [RESET].

To cancel [SELF-TIMER], touch [OFF].

- You can also set the self-timer with the REC START/STOP button or PHOTO button of the Remote Commander (p. 40).

## DIGITAL ZOOM

You can select the maximum zoom level in case you want to zoom to a level greater than 20 × (DCR-HC36)/12 × (DCR-HC46)/10 × (DCR-HC96) (the default setting) while recording on a tape. Note that the image quality decreases when you are using the digital zoom.

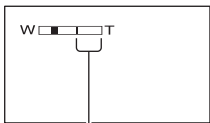

The right side of the bar shows the digital zooming factor. The zooming zone appears when you select the zooming level.

### For DCR-HC36:

► **OFF**

Up to 20 × zoom is performed optically.

**40 ×**

Up to 20 × zoom is performed optically, and after that, up to 40 × zoom is performed digitally.

**800 ×**

Up to 20 × zoom is performed optically, and after that, up to 800 × zoom is performed digitally.

### For DCR-HC46:

► **OFF**

Up to 12 × zoom is performed optically.

**24 ×**

Up to 12 × zoom is performed optically, and after that, up to 24 × zoom is performed digitally.

**800 ×**

Up to 12 × zoom is performed optically, and after that, up to 800 × zoom is performed digitally.

### For DCR-HC96:

► **OFF**

Up to 10 × zoom is performed optically.

**20 ×**

Up to 10 × zoom is performed optically, and after that, up to 20 × zoom is performed digitally.

**120 ×**

Up to 10 × zoom is performed optically, and after that, up to 120 × zoom is performed digitally.

## WIDE SELECT (DCR-HC36)

You can record a picture in a ratio suitable for the screen on which it will be displayed. Refer also to the operating instructions supplied with your TV for details.

► **4:3**

Standard setting (to record pictures to be played back on a 4:3 TV).

**16:9 WIDE (16:9)**

Select to record a picture to be played back on a 16:9 wide TV. The recorded picture will be played in full mode when you connect to your TV compatible with ID-1/ID-2 systems.

When viewed on the LCD screen/viewfinder with [16:9 WIDE] selected.

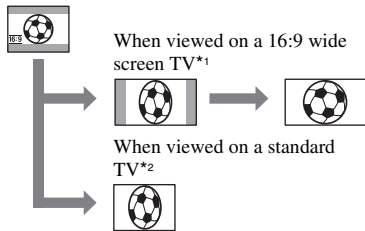

\*1 Picture appears in full screen mode when the wide-screen TV switches to full mode.

\*2 Played in 4:3 mode. When you play a picture in the wide mode, it appears as you have seen on the LCD screen or in the viewfinder.

## STEADYSHOT

You can compensate for camera shake (the default setting is [ON]).

Set [STEADYSHOT] to [OFF] (  ) when using a tripod (optional) or the conversion lens (optional), then the image becomes natural.

## PROGRES.REC (DCR-HC96)

You can reduce image blur when recording moving pictures on tapes, intended for import to your computer as still images, by setting [PROGRES.REC] to [ON] (30p). This is especially useful for analyzing high-speed action, such as sports scenes.

To cancel [PROGRES.REC], touch [OFF].

### Note on the progressive recording mode

In a normal TV broadcast, the screen is divided into 2 finer fields and these are displayed in turn, every 1/60 of a second. Thus, the actual picture displayed in an instant covers only half of the apparent picture area. In progressive recording, the picture is fully displayed with all the pixels. A picture recorded in this mode appears clearer, but a moving subject may appear awkward.

- When recording under fluorescent light or a light bulb, the screen may flicker. Touch [OFF] to return to the normal recording.

## MEMORY SET menu

Settings for the “Memory Stick Duo” (BURST/QUALITY/IMAGE SIZE/ALL ERASE/NEW FOLDER, etc.)

The default settings are marked with ►. The indicators in parentheses appear when the items are selected.

See page 44 for details on selecting menu items.

## STILL SET

### ■ BURST (DCR-HC46/HC96)

You can record several still images one after another by pressing PHOTO.

#### ► OFF

Select this when not recording continuously.

#### NORMAL ( )

Records still images continuously at about 0.5 seconds intervals.

The maximum number of images are recorded when you press and hold PHOTO fully.

#### In 4:3 aspect ratio

	3.0M	1.9M	1.0M	VGA
DCR-HC46	–	–	4	13
DCR-HC96	3	4	–	21

#### In 16:9 aspect ratio

	2.3M	0.7M
DCR-HC46	–	4
DCR-HC96	3	–

#### HIGH SPEED ( ) (DCR-HC96)

Record up to 32 images (VGA image sizes) continuously at about 0.07 second intervals.

#### EXP. BRKTG (BRK)

Records 3 images consecutively with different exposures at about 0.5 second intervals. You can compare the 3 images and select an image recorded at the best exposure.

## MEMORY SET menu (Continued)

- [BURST] can be set only when the POWER switch is set to CAMERA-MEMORY.
- [BURST] cannot be set during Easy Handycam operation.
- The maximum number of images will be recorded in the self-timer mode or when you are operating with the Remote Commander.
- [EXP. BRKGTG] will not function when there is space of less than 3 images remaining on the "Memory Stick Duo."
- For DCR-HC96:  
The flash will not function during [BURST].
- For DCR-HC96:  
The images may flicker or discolor when you select [HIGH SPEED].

### QUALITY

#### ► FINE (FINE)

Records still images at the fine image quality level.

#### STANDARD (STD)

Records still images at the standard image quality level.

- Image quality is automatically fixed to [FINE] during Easy Handycam operation.

### IMAGE SIZE (DCR-HC46/HC96)

#### For DCR-HC46:

##### ► 1.0M (1.0M)

Allows you to record more still images in relatively clear quality.

##### VGA (0.3M) (VGA)

Allows for the maximum number of images to be recorded.

#### For DCR-HC96:

##### ► 3.0M (3.0M)

Records still images clearly.

##### 1.9M (1.9M)

Allows you to record more still images in relatively clear quality.

##### VGA (0.3M) (VGA)

Allows for the maximum number of images to be recorded.

- If you set a screen ratio of 16:9 (wide), [IMAGE SIZE] is fixed to [0.7M] (DCR-HC46)/[2.3M] (DCR-HC96) automatically (p. 26).
- [IMAGE SIZE] can be set only when the POWER switch is set to CAMERA-MEMORY.

### FLD/FRAME (DCR-HC36)

#### ► FIELD

To record moving subjects correcting jitter (p. 30).

#### FRAME (FRAME)

To record stationary subjects in high quality.

## Capacity of the "Memory Stick Duo" (MB) and the number of recordable pictures

### In 4:3 aspect ratio

	3.0M*1 (2016 × 1512) 3.0M	1.9M*1 (1600 × 1200) 1.9M	1.0M*2 (1152 × 864) 1.0M	VGA (640 × 480) VGA
16MB	10 24	16 37	30 74	96 240
32MB	20 48	32 75	61 150	190 485
64MB	40 98	65 150	120 300	390 980
128MB	82 195	130 300	245 600	780 1970
256MB	145 355	235 540	445 1000	1400 3550
512MB	300 720	480 1100	900 2050	2850 7200
1GB	610 1450	980 2250	1800 4200	5900 14500
2GB	1250 3000	2000 4650	3750 8600	12000 30000

\*1 DCR-HC96

\*2 DCR-HC46

- All numbers measured at the following setting:  
Top: [FINE] is selected for image quality.  
Bottom: [STANDARD] is selected for image quality.



- When using the “Memory Stick Duo” made by Sony Corporation.

The number of recordable pictures varies depending on the recording environment.

- For DCR-HC36:

When recording still images, the size is always fixed to VGA (640 × 480).

### In 16:9 aspect ratio (DCR-HC46/HC96)

	2.3M* <sup>1</sup> (2016 × 1134) ↳2.3M	0.7M* <sup>2</sup> (1152 × 648) ↳0.7M	0.2M* <sup>3</sup> (640 × 360) ↳0.2M
16MB	13 32	40 96	115 240
32MB	27 65	81 190	240 485
64MB	54 130	160 390	490 980
128MB	105 260	320 780	980 1970
256MB	195 470	590 1400	1750 3550
512MB	400 960	1200 2850	3600 7200
1GB	820 1950	2450 5900	7300 14500
2GB	1650 4000	5000 12000	15000 30000

\*<sup>1</sup> DCR-HC96

\*<sup>2</sup> DCR-HC46

\*<sup>3</sup> If you record a still image on a “Memory Stick Duo” with the POWER switch set to CAMERA-TAPE, [IMAGE SIZE] is automatically fixed at [0.2M]. You cannot select [0.2M] for the image size in [STILL SET].

- All numbers measured at the following setting:  
Top: [FINE] is selected for image quality.  
Bottom: [STANDARD] is selected for image quality.
- When using the “Memory Stick Duo” made by Sony Corporation.  
The number of recordable pictures varies depending on the recording environment.

## Approximate data size of a picture (kB)

### 4:3 picture

3.0M* <sup>1</sup>	1.9M* <sup>1</sup>	1.0M* <sup>2</sup>	VGA
1540	960	500	150
640	420	210	60

- For DCR-HC36:

When recording still images, the size is always fixed to VGA (640 × 480).

### 16:9 picture (DCR-HC46/HC96)

2.3M* <sup>1</sup>	0.7M* <sup>2</sup>	0.2M* <sup>3</sup>
1150	380	130
480	160	60

\*<sup>1</sup> DCR-HC96

\*<sup>2</sup> DCR-HC46

\*<sup>3</sup> If you record a still image on a “Memory Stick Duo” with the POWER switch set to CAMERA-TAPE, [IMAGE SIZE] is automatically fixed at [0.2M]. You cannot select [0.2M] for the image size in [STILL SET].

- Data sizes measured at the following settings:  
Top: [FINE] is selected for image quality.  
Bottom: [STANDARD] is selected for image quality.

## MOVIE SET

### IMAGE SIZE

#### ▶ 320 × 240 (320)

Records movies in high resolution.

#### 160 × 112 (160)

Allows for more movie recording time.

### Capacity of the “Memory Stick Duo” (MB) and the recordable time (hour: minute: second)

	320 × 240 320	160 × 112 160
16MB	00:02:40	00:10:40
32MB	00:05:20	00:21:20
64MB	00:10:40	00:42:40
128MB	00:21:20	01:25:20
256MB	00:42:40	02:50:40
512MB	01:25:20	05:41:20
1GB	02:50:40	11:22:40
2GB	05:41:20	22:45:20

- When using the “Memory Stick Duo” made by Sony Corporation.  
The recordable time varies depending on the recording environment.

## ALL ERASE

Deletes all the pictures on a “Memory Stick Duo” without image protection, or in the selected folder.

- ① Select [ALL FILES] or [CURRENT FOLDER].

**[ALL FILES]:** Deletes all the images on the “Memory Stick Duo.”

**[CURRENT FOLDER]:** Deletes all the images in the selected folder.

- ② Touch [YES] twice → [X].

- Cancel image protection on the “Memory Stick Duo” beforehand when using the “Memory Stick Duo” with the write-protect tab (p. 124).

- The folder will not be deleted even when you delete all the pictures in the folder.
- Do not do any of the following while [Erasing all data...] is displayed:
  - Operate the POWER switch/operation buttons.
  - Eject the “Memory Stick Duo.”

## FORMAT

The “Memory Stick Duo” has been formatted at the factory, and does not require formatting.

To execute formatting, touch [YES] twice → [X].

Formatting is completed, and all the images will be deleted.

- Do not do any of the following while [Formatting...] is displayed:
  - Operate the POWER switch/operation buttons.
  - Eject the “Memory Stick Duo.”
- Formatting erases everything on the “Memory Stick Duo” including protected image data and newly created folders.

## FILE NO.

### ▶ SERIES

Assigns file numbers in sequence even if the “Memory Stick Duo” is replaced with another one. The file number is reset when a new folder is created or the recording folder is replaced with another.

### RESET

Resets the file number to 0001 each time the “Memory Stick Duo” is changed.



## NEW FOLDER

You can create a new folder (102MSDCF to 999MSDCF) on a “Memory Stick Duo.” When 9,999 images are stored in the current folder, a new folder is automatically created for storing subsequent images.

Touch [YES] → .



- You cannot delete the created folders using your camcorder. You will have to format the “Memory Stick Duo” (p. 58), or delete them using your computer.
- The number of recordable pictures on a “Memory Stick Duo” may decrease as the number of folders increases.

## REC FOLDER (Recording folder)

Select the folder to be used for recording with /, then touch .

- As the default setting, pictures are saved in the 101MSDCF folder.
- Once you record a picture in a folder, the same folder will be set as the default folder for playback.

## PB FOLDER (Playback folder)

Select the playback folder with /, then touch .

## PICT.APPLI. menu

Special effects on pictures or additional functions on recording/playback (SLIDE SHOW/PICT. EFFECT/FRAME REC, etc.)

The default settings are marked with . The indicators in parentheses appear when the items are selected.

See page 44 for details on selecting menu items.

## FADER

You can add the following effects to currently recording pictures.

- ① Select the desired effect in standby mode (to fade in) or recording mode (to fade out), then touch .

When [OVERLAP], [WIPE] or [DOT FADER] is selected, the screen turns to blue while storing the image, then the image on a tape is stored as a still image.

- ② Press REC START/STOP.

The fader indicator stops flashing and disappears when the fade is complete.

To cancel [FADER] before starting the operation, touch [OFF] in step ①.

- If you press REC START/STOP once, the setting is canceled.



### WHITE FADER



### BLACK FADER



### MOSAIC FADER



### MONOTONE

When fading in, the picture gradually changes from black and white to color. When fading out, it gradually changes from color to black and white.

### OVERLAP (fade in only)



### WIPE (fade in only)



### DOT FADER (fade in only)



### Using the viewfinder

You can adjust [EXPOSURE] and [FADER] while using the viewfinder by having the LCD panel rotated 180 degrees and closed with the screen facing out.

- 1 Make sure that the CAMERA-TAPE or the CAMERA-MEMORY lamp lights up.
- 2 Close the LCD panel with the screen facing out.  
[OFF] appears.
- 3 Touch [OFF].  
[Set LCD off?] appears on the screen.
- 4 Touch [YES].  
The LCD screen is turned off.
- 5 Touch the LCD screen while checking the display in the viewfinder.  
[EXPOSURE], etc. are displayed.
- 6 Touch the button you want to set.

**[EXPOSURE]:** Adjust with  $\left[ \text{---} \right] / \left[ \text{+} \right]$ , and touch [OK].

**[FADER]:** Touch it repeatedly to select a desired effect (only while the CAMERA-TAPE lamp lights up).

[ON]: The LCD screen lights up.

To hide the buttons, touch [OK].

### SLIDE SHOW

Plays back the images stored on a “Memory Stick Duo,” or in a folder in sequence (slide show).

- 1 Touch [SET] → [PB FOLDER].

- 2 Select [ALL FILES (all)] or [CURRENT FOLDER (T)], then touch [OK].

If you select [CURRENT FOLDER (T)], all the images in the current playback folder selected in [PB FOLDER] (p. 59) are played back in sequence.

- 3 Touch [REPEAT].
- 4 Select [ON] or [OFF], then [OK].  
To repeat the slide show, select [ON] (↻).  
To execute the slide show only once, select [OFF].
- 5 Touch [END] → [START].

To cancel [SLIDE SHOW], touch [END].  
To pause, touch [PAUSE].

- You can select the first picture for the slide show with  $\left[ \text{---} \right] / \left[ \text{+} \right]$  before touching [START].
- If movies are played in the slide show, you can adjust the volume with  $\left[ \text{V} \right] / \left[ \text{V} \right]$ .

### D. EFFECT (Digital effect)

You can add digital effects to your recordings.

- 1 Touch the desired effect.  
When you select [STILL] or [LUMI.KEY], the image is saved as a still image.
- 2 Adjust the effect with  $\left[ \text{---} \right] / \left[ \text{+} \right]$ , then touch [OK].

Effect	Items to adjust
CINEMA EFFECT*1*2	No adjustment necessary.
DELAY MOTION*2	The speed of repeats.
STILL	The degree of transparency of the still image you want to superimpose under a movie.
FLASH	The interval of frame-by-frame playback.

Effect	Items to adjust
LUMI. KEY	The color scheme of the area in the still image which is to be swapped with a movie.
TRAIL	The fade time of the incidental image.
SLOW SHUTTR* <sup>1</sup>	Shutter speed (1 is 1/30, 2 is 1/15, 3 is 1/8, 4 is 1/4).
OLD MOVIE* <sup>1</sup>	No adjustment necessary.

\*<sup>1</sup> Available during recording on a tape only.

\*<sup>2</sup> DCR-HC96

- ③ Touch [OK].  
[D+] appears.

To cancel [D. EFFECT], touch [OFF] in step ①.

#### ► OFF

Does not use [D. EFFECT] setting.

#### CINEMA EFFECT (Cinematic effect) (DCR-HC96)

You can add a cinematic atmosphere to pictures by adjusting to a 16:9 screen and progressive picture.

#### DELAY MOTION (Delay motion) (DCR-HC96)

You can record a movie with a repeat effect.

#### STILL

Records a movie while superimposing it on a previously memorized still image.



#### FLASH (flash motion)

Records a movie with a serial-still-image effect (strobe effect).

#### LUMI. KEY (luminance key)

Replaces a brighter area in a previously memorized still image (e.g. background of a person) with a movie.



#### TRAIL

Records a picture so that an incidental image like a trail is left.

#### SLOW SHUTTR (slow shutter)

The shutter speed is slowed down. Suitable for shooting a subject more clearly in a dark place.

- Adjust the focus manually using a tripod (optional) since adjusting the focus automatically is hard when [SLOW SHUTTR] is selected. ([FOCUS], p. 51)

#### OLD MOVIE

Adds an old movie effect with a sepia hue to pictures.

- You cannot record playback pictures edited using special effects on the tape in your camcorder.
- You can save pictures edited using special effects on a “Memory Stick Duo” (p. 77) or record them on another VCR/DVD device, etc. (p. 71).
- You cannot output playback pictures edited with digital effects via the DV Interface (i.LINK).
- You cannot add effects to externally input pictures.
- For DCR-HC46/HC96: You cannot select 16:9/4:3 as the aspect ratio for [OLD MOVIE].
- For DCR-HC96: You cannot change to another digital effect while recording pictures on a tape with [CINEMA EFFECT] selected.
- For DCR-HC96: The digital effect function is suspended while using zoom with [DELAY MOTION] selected.
- For DCR-HC96: It is recommended that you mount your camcorder on a tripod (optional) when you select [DELAY MOTION].

## PICT. EFFECT (Picture effect)

You can add special effects to a picture during recording or playback. appears.

### ▶ OFF

Does not use [PICT. EFFECT] setting.

### NEG.ART



The color and brightness are reversed.

### SEPIA

Pictures appear in sepia.

### B&W

Pictures appear in black and white.

### SOLARIZE



Pictures appear as an illustration with strong contrast.

### PASTEL\*



Pictures appear as a pale pastel drawing.

### MOSAIC\*



Pictures appear mosaic-patterned.

\* Not available during playback.

- You can save pictures edited using special effects on a "Memory Stick Duo" (p. 77) or record them on another VCR/DVD device, etc. (p. 71).
- You cannot output playback pictures edited with picture effects via the DV Interface (i.LINK).
- You cannot add effects to externally input pictures.

## FRAME REC (Frame recording) (DCR-HC96)

You can record pictures with a stop-motion animated effect by alternately frame recording and then moving the subject a little. After steadying your camcorder, use the Remote Commander to prevent camera shake.

- ① Touch [ON] () → [OK] → [X].
- ② Press REC START/STOP.

A picture (approximately 6 frames) is recorded, and your camcorder enters the standby mode.

- ③ Move the subject and repeat step ②.

To cancel [FRAME REC], touch [OFF] in step ①.

- The remaining tape time will not be indicated correctly.
- The last scene will be longer than other scenes.

## SMTH INT.REC (Smooth interval tape recording) (DCR-HC46/HC96)

Your camcorder will shoot 1 frame of the picture at a selected interval and keep them in memory until it has stored several frames. This function is useful to observe the movement of clouds or the changes of daylight. These pictures appear smooth when played back. Connect your camcorder to the wall outlet using the supplied AC Adaptor for this operation.

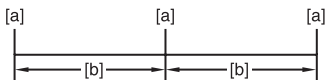

[a]: Recording

[b]: Interval

- ① Touch [SET] → / to select a desired interval time (1 to 120 seconds) → [OK].
- ② Touch [REC START].  
Recording starts and changes to red.  
To interrupt, touch [REC STOP] in step ②.

To resume, touch [REC START].  
To cancel, touch [REC STOP], then [END] in step ②.

- During Smooth interval recording, your camcorder may perform the END SEARCH function to locate the end in current recordings on the tape after several frames have been recorded.
- Do not turn off the power or disconnect the power source while a message is displayed on the screen.
- The camcorder will shoot several frames for the first and last shots of the Smooth interval recording.
- Smooth interval recording is released when approximately 12 hours have elapsed after shooting has begun.
- Sounds are not recorded.
- The last few frames may not be recorded if the battery or tape has run out.
- There may be discrepancies in the interval.
- If you adjust the focus manually, you can record clear pictures even if the light changes ([FOCUS], p. 51).
- You can silence the recording beep by setting of [BEEP] (p. 68).

## INT.REC-STL (Interval photo recording)

You can record still images on the “Memory Stick Duo” at a selected interval. This function is useful to observe the movement of clouds or the changes in daylight, etc.

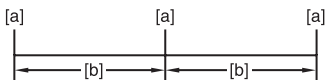

**[a]:** Recording

**[b]:** Interval

- ① Touch [SET] → a desired interval time (1, 5 or 10 minutes) → [OK] → [ON] (📷) → [OK] → [X].
- ② Press PHOTO fully.  
📷 stops flashing and the interval still image recording starts.

To cancel [INT.REC-STL], select [OFF] in step ①.

## DEMO MODE

The default setting is [ON], allowing you to view the demonstration in about 10 minutes, after you have removed both a cassette and a “Memory Stick Duo” from your camcorder, and slide the POWER switch repeatedly to turn on the CAMERA-TAPE lamp.

- The demonstration will be suspended in situations such as those described below.
  - When you touch the screen during the demonstration. (The demonstration starts again after about 10 minutes.)
  - When a cassette or a “Memory Stick Duo” is inserted.
  - When the POWER switch is set to other than CAMERA-TAPE.

## PictBridge PRINT

See page 82.

## USB SELECT

You can connect the camcorder to a personal computer with a USB cable and view pictures on the computer. You can also connect the camcorder to a PictBridge-compatible printer (p. 82) using this function. Refer to “First Step Guide” on the supplied CD-ROM for details.

### 📷 Memory Stick

Select this to view pictures on a “Memory Stick Duo” on the computer or to import them to the computer.

### 🖨️ PictBridge PRINT

Select this when you connect the camcorder to a PictBridge-compatible printer to print out directly (p. 82).

### 📺 STREAM

Select this to view movies on a tape on the computer or to import them to the computer.

### BURN VCD

Select this to burn the picture recorded on the tape onto a CD-R. Refer to "First Step Guide" on the supplied CD-ROM for details (p. 93).

- During Easy Handycam operation, [EASY] [STREAM] and [BURN VCD] cannot be set.

Settings for editing or playing back in various modes (VAR.SPD PB/END SEARCH, etc.)









The default settings are marked with ►. The indicators in parentheses appear when the items are selected.

**See page 44 for details on selecting menu items.**

### VAR.SPD PB (Various speed playback)

You can play back in various modes while viewing movies.

- ① Touch the following buttons during playback.

To	Touch
change the playback direction*	 (frame)
play back slowly**	 To reverse direction:  (frame) → 
play back 2 times faster (double speed)	 To reverse direction:  (frame) →  (double speed)
play back frame by frame	 (frame) during playback pause. To reverse direction:  (frame) during frame playback.

\* Horizontal lines may appear at the top, bottom, or in the center of the screen. This is not a malfunction.

\*\*Pictures output from the  DV Interface (i.LINK) cannot be played back smoothly in slow mode.

- ② Touch  → .

To return to the normal playback mode, touch  (Play/Pause) twice (once from frame playback).





# STANDARD SET menu

- You will not hear the recorded sound. You may see mosaic-like images of the previously played picture.

## REC CTRL (Movie recording control)

See page 76.

## AUD DUB CTRL (Audio dubbing)

See page 79.

## REC MOVIE (Recording control)

See page 77.

## BURN DVD

When your camcorder is connected to a Sony VAIO series personal computer, you can easily burn the picture recorded on the tape on a DVD (Direct Access to “Click to DVD”) (p. 94).

## BURN VCD

When your camcorder is connected to a personal computer, you can easily burn the picture recorded on the tape on a CD-R (Direct Access to Video CD Burn). See “First Step Guide” in the supplied CD-ROM for details (p. 93).

## END SEARCH

### EXEC

The most recently recorded picture is played back for about 5 seconds and then stops automatically.

### CANCEL

Stops [END SEARCH].

- After ejecting the cassette, the END SEARCH function is not available.

## Settings while recording on a tape or other basic settings (REC MODE/MULTI-SOUND/LCD/VF SET/DISP OUTPUT, etc.)

The default settings are marked with ►. The indicators in parentheses appear when the items are selected.

See page 44 for details on selecting menu items.

## REC MODE (Recording mode)

### ► SP (SP)

Records in the SP (Standard Play) mode on a cassette.

### LP (LP)

Increases the recording time to 1.5 times the SP mode (Long Play).

- If you record in the LP mode, a mosaic-like noise may appear or sound may be interrupted when you play back the tape on other camcorders or VCRs.
- When you mix recordings in the SP mode and in the LP mode on one tape, the playback picture may be distorted or the time code may not be written properly between the scenes.

## AUDIO MODE

### ► 12BIT

Records in the 12-bit mode (2 stereo sounds).

### 16BIT (16b)

Records in the 16-bit mode (1 stereo sound with high quality).

## VOLUME

See page 31.

## MULTI-SOUND

You can select whether to play back audio recorded using other devices with dual sound or stereo sound.

► **STEREO**

Plays back with main and sub sound (or stereo sound).

1

Plays back with main sound (or the left channel sound).

2

Plays back with sub sound (or the right channel sound).

- You can play back, but cannot record a dual sound track cassette on your camcorder.
- The setting returns to [STEREO] when you turn the power off for more than 12 hours.

**AUDIO MIX**

See page 80.

**LCD/VF SET**

The recorded picture will not be affected by this operation.

■ **LCD BRIGHT**

You can adjust the brightness of the LCD screen.

- ① Adjust the brightness with / .
- ② Touch .

■ **LCD BL LEVEL**

You can adjust the brightness of the LCD screen's backlight.

► **NORMAL**

Standard brightness.

**BRIGHT**

Brightens the LCD screen.

- When you connect your camcorder to outside power sources, [BRIGHT] is automatically selected for the setting.
- When you select [BRIGHT], battery life is slightly reduced during recording.

■ **LCD COLOR**

You can adjust the color on the LCD screen with / .

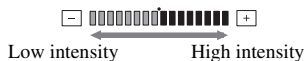

■ **VF B.LIGHT**

You can adjust the brightness of the viewfinder.

► **NORMAL**

Standard brightness.

**BRIGHT**

Brightens the viewfinder screen.

- When you connect your camcorder to outside power sources, [BRIGHT] is automatically selected for the setting.
- When you select [BRIGHT], battery life is slightly reduced during recording.

■ **WIDE DISPLAY (DCR-HC36)**

You can select how a 16:9 aspect ratio picture appears in the viewfinder and the LCD screen by setting [WIDE SELECT] to [16:9 WIDE]. The recorded picture will not be affected by this operation.

► **LETTER BOX**

Normal setting (standard type of display)

**SQUEEZE (Squeeze)**

Expands the picture vertically if black bands at the top and bottom in 16:9 aspect ratio are undesirable.

■ **VF WIDE DISP (DCR-HC46/HC96)**

You can select how a 16:9 aspect ratio picture appears in the viewfinder.

► **LETTER BOX**

Normal setting (standard type of display)

**SQUEEZE (Squeeze)**

Expands the picture vertically if black bands at the top and bottom in 16:9 aspect ratio are undesirable.

## A/V → DV OUT (DCR-HC96)

When you set [A/V → DV OUT] (**A/V•DV**) to [ON], you can convert analog signals to digital by connecting a digital device and an analog device to your camcorder. See page 97 for details.

## VIDEO INPUT (DCR-HC96)

Selects the video plug to connect when you input the picture from the other device via A/V connecting cable.

### ▶ VIDEO

Connects via video plug of the A/V connecting cable.

### S VIDEO

Connects via S VIDEO plug of the A/V connecting cable with S VIDEO cable.

## TV TYPE (DCR-HC46/HC96)

See page 43.

## USB CAMERA

When you set [**STREAM**] and connect your camcorder to your computer via the USB cable, you can view the picture your camcorder is currently seeing on your computer like a live camera.

You can also import the picture to your computer. Refer to the “First Step Guide” on the supplied CD-ROM for details (p. 93).

## DISP GUIDE

See page 21.

## GUIDEFAME (DCR-HC96)

You can display the frame and check that the subject is horizontal or vertical by setting [GUIDEFAME] to [ON]. The frame is not recorded. Press DISP/BATT INFO to make the frame disappear.

- Pointing the subject at the cross point of the guide frame makes a balanced composition.

## DATA CODE

During playback, displays information (data code) recorded automatically at the time of recording.

### ▶ OFF

Data code is not displayed.

### DATE/TIME

Displays the date and time.

### CAMERA DATA (below)

Displays camera setting data.

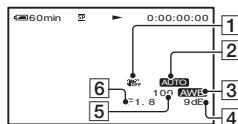

- 1 SteadyShot off
- 2 Exposure
- 3 White balance
- 4 Gain
- 5 Shutter speed
- 6 Aperture value

- Camera setting data does not appear when movies on a “Memory Stick Duo” are played back.
- The exposure adjustment value (0EV), a shutter speed, and the aperture value appear when still images on a “Memory Stick Duo” are played back.
- In the [DATE/TIME] data display, the date and time are displayed in the same area. If you record a picture without setting the clock, [--- --] and [---:--] will appear.

- During Easy Handycam operation, you can set [DATE/TIME] only.
- For DCR-HC96:
  - ⚡ appears for a picture recorded using a flash.

### REMAINING

#### ▶ AUTO

Displays the remaining tape indicator for about 8 seconds in situations such as those described below.

- When you set the POWER switch to PLAY/EDIT or CAMERA-TAPE with a cassette inserted.
- When you touch  (Play/Pause).

#### ON

Always displays the remaining tape indicator.

### REMOTE CTRL (Remote control)

The default setting is [ON], allowing you to use the supplied Remote Commander (p. 40).

- Set to [OFF] to prevent your camcorder from responding to a command sent by another VCR remote control unit.

### REC LAMP (Recording lamp) (DCR-HC96)

The camera recording lamp will not light up during recording when you set this to [OFF] (The default setting is [ON]) (p. 35).

### BEEP

#### ▶ ON

A melody sounds when you start/stop recording, or operate the touch panel.

#### OFF

Cancels the melody.

### DISP OUTPUT

#### ▶ LCD PANEL

Shows displays such as the time code on the LCD screen and in the viewfinder.

#### V-OUT/PANEL

Shows displays such as the time code on the TV screen, LCD screen, and in the viewfinder.

### MENU ROTATE

#### ▶ NORMAL

Scrolls the menu items downwards by touching .

#### OPPOSITE

Scrolls the menu items upwards by touching .

### A.SHUT OFF (Auto shut off)

#### ▶ 5 min

The camcorder is automatically turned off when you do not operate your camcorder for more than approximately 5 minutes.

#### NEVER

The camcorder is not automatically turned off.

- When you connect your camcorder to a wall outlet, [A.SHUT OFF] is automatically set to [NEVER].

### CALIBRATION

See page 130.

# TIME/LANGU. menu



(CLOCK SET/WORLD TIME/LANGUAGE)

See page 44 for details on selecting menu items.

## CLOCK SET

See page 23.

## WORLD TIME

When using your camcorder abroad, you can set the time difference by touching /, the clock will be adjusted in accordance with the time difference. If you set the time difference to 0, the clock returns to the originally set time.

## LANGUAGE

You can select the language to be used on the LCD screen.

- Your camcorder offers [ENG[SIMP]] (simplified English) for when you cannot find your native tongue among the options.

# Customizing Personal Menu

You can add desired menu items to any Personal Menu allocated to the lamp positions currently lit. This is convenient if you add frequently used menu items to Personal Menu.

## Adding a menu item

You can add up to 28 menu items to each Personal Menu. Delete a less important menu item, if you want to add more.

### 1 Touch → [P-MENU SET UP] → [ADD].

If the desired menu item is not displayed, touch .

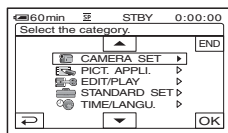

### 2 Touch to select a menu category, then touch .

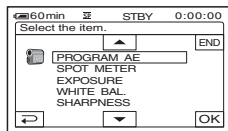

### 3 Touch to select a menu item, then touch → [YES] → .

The menu item is added to the end of list.

### Deleting a menu item

- 1 Touch [P-MENU] → [P-MENU SET UP] → [DELETE].

If the desired menu item is not displayed, touch  $\uparrow/\downarrow$ .

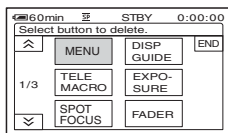

- 2 Touch the menu item that you want to delete.

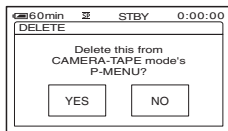

- 3 Touch [YES] →  $\times$ .

- You cannot delete [MENU] and [P-MENU SET UP].

### Arranging the order of menu items displayed on Personal Menu

- 1 Touch [P-MENU] → [P-MENU SET UP] → [SORT].

If the desired menu item is not displayed, touch  $\uparrow/\downarrow$ .

- 2 Touch the menu item you want to move.

- 3 Touch  $\uparrow/\downarrow$  to move the menu item to the desired place.

- 4 Touch [OK].

To sort more items, repeat steps 2 to 4.

- 5 Touch [END] →  $\times$ .

- You cannot move [P-MENU SET UP].

### Initializing the Personal Menu settings (Reset)

- Touch [P-MENU] → [P-MENU SET UP] → [RESET] → [YES] → [YES] →  $\times$ .

If the desired menu item is not displayed, touch  $\uparrow/\downarrow$ .

# Dubbing to VCR/DVD device, etc.

You can copy the picture played back on your camcorder to other recording devices (VCR/ DVD device, etc.).

You can connect your camcorder to a VCR/DVD device, etc., using the A/V connecting cable (1), the A/V connecting cable with S VIDEO (2), or the i.LINK cable (3).

Connect your camcorder to the wall outlet using the supplied AC Adaptor for this operation (p. 13). Refer also to the instruction manuals supplied with the devices to be connected.

- For DCR-HC46/HC96:

Do not insert/eject the cassette while your camcorder is on the Handycam Station. This may cause a malfunction.

## DCR-HC36:

A/V OUT jack

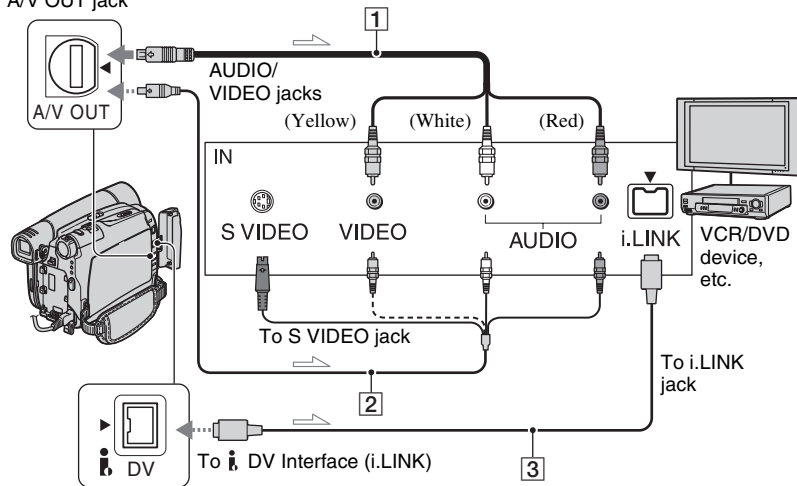

➡ : Signal flow

## Dubbing to VCR/DVD device, etc. (Continued)

### DCR-HC46/HC96:

A/V or A/V OUT jack

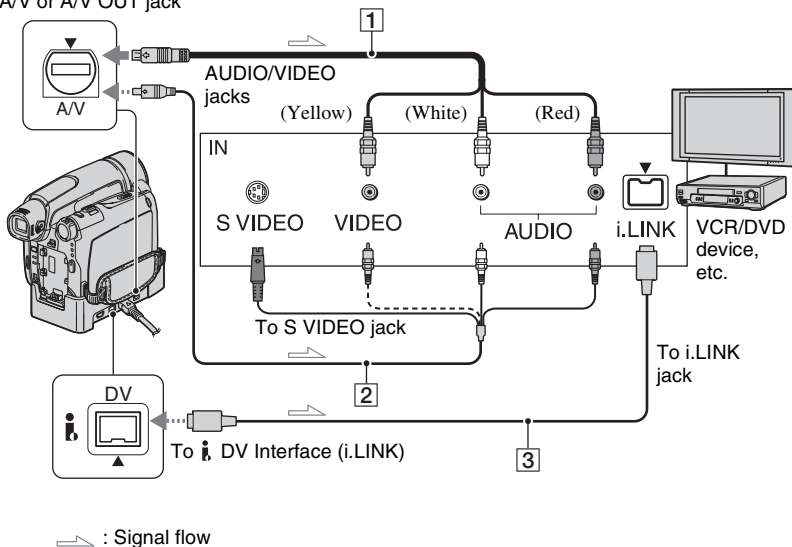

#### 1 A/V connecting cable (supplied)

For DCR-HC46/HC96:

The Handycam Station and your camcorder are both equipped with A/V jacks (p. 84). Connect the A/V connecting cable either to the Handycam Station or to your camcorder, depending on your setup.

#### 2 A/V connecting cable with S VIDEO (optional)

When connecting to another device via the S VIDEO jack, by using the A/V connecting cable with an S VIDEO cable, pictures can be reproduced more faithfully than with the supplied A/V cable connection. Connect the white and red plugs (left/right audio) and S VIDEO plug (S VIDEO channel) of an A/V connecting cable. In this case, the yellow (standard video) plug connection is not necessary. S VIDEO connection only will not output audio.

#### 3 i.LINK cable (optional)

Use an i.LINK cable to connect your camcorder to another device equipped with an i.LINK jack. The video and audio signals are transmitted digitally, producing high quality pictures and sound. Note that you cannot output picture and sound separately.

- When you are connecting your camcorder to a monaural device, connect the yellow plug of the A/V connecting cable to the video jack, and the red (right channel) or the white (left channel) plug to the audio jack on the VCR/TV.
- When you connect a device via an A/V connecting cable, set [DISP OUTPUT] to [LCD PANEL] (the default setting) (p. 68).
- While your camcorder is sending signals to another device via an i.LINK cable, **DVOUT** appears on the LCD screen on your camcorder.



---

## 1 Prepare your camcorder for playback.

Insert the recorded cassette.

For DCR-HC46/HC96:

Set [TV TYPE] according to the playback device (TV, etc.) (p. 43).

---

## 2 Prepare your VCR/DVD device for recording.

When dubbing to the VCR, insert a cassette for recording.

When dubbing to the DVD recorder, insert a DVD for recording.

If your recording device has an input selector, set it to the appropriate input (such as video input1, video input2).

---

## 3 Connect your VCR/DVD device to your camcorder as a recording device.

Connect your camcorder to the input jacks of a VCR or a DVD device.

---

## 4 Start playback on the camcorder, and recording on the VCR/DVD device.

Refer to the operating instructions supplied with your recording device for details.

---

## 5 When dubbing is complete, stop your camcorder and the VCR/DVD device.

- 
- To record the date/time and camera settings data when connected by the A/V connecting cable, display them on the screen (p. 67, 68).

- The following cannot be output via the  DV Interface (i.LINK):

- Indicators

- Pictures edited using [PICT. EFFECT] (p. 62), [D. EFFECT] (p. 60) or PB zoom (p. 34).

- When connected using an i.LINK cable, the recorded picture becomes rough when a picture is paused on your camcorder while recording to a VCR.
- When connected using an i.LINK cable, data code (date/time/camera settings data) may not be displayed or recorded depending on the device or application.

# Recording pictures from a TV or VCR/DVD device, etc.

You can record pictures or TV programs from a TV or VCR/DVD device, etc., on a tape or a “Memory Stick Duo.” You can also record a scene as a still image on a “Memory Stick Duo.” Be sure to insert a cassette or a “Memory Stick Duo” for recording in your camcorder beforehand.

You can connect your camcorder to a TV, VCR/DVD device, etc. or an i.LINK-compatible device using the A/V connecting cable (1), the A/V connecting cable with S VIDEO (2), or the i.LINK cable (3).

Connect your camcorder to the wall outlet using the supplied AC Adaptor for this operation (p. 13). Refer also to the instruction manuals supplied with the devices to be connected.

- You cannot record pictures on your camcorder from a TV or VCR/DVD device, etc. that does not have an output jack.
- For DCR-HC46/HC96:  
Do not insert/eject the cassette while your camcorder is on the Handycam Station. This may cause a malfunction.

## DCR-HC36:

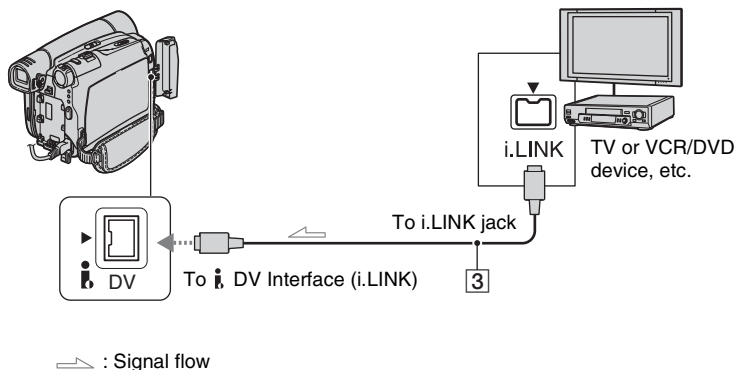

## DCR-HC46/HC96:

A/V jack (DCR-HC96)

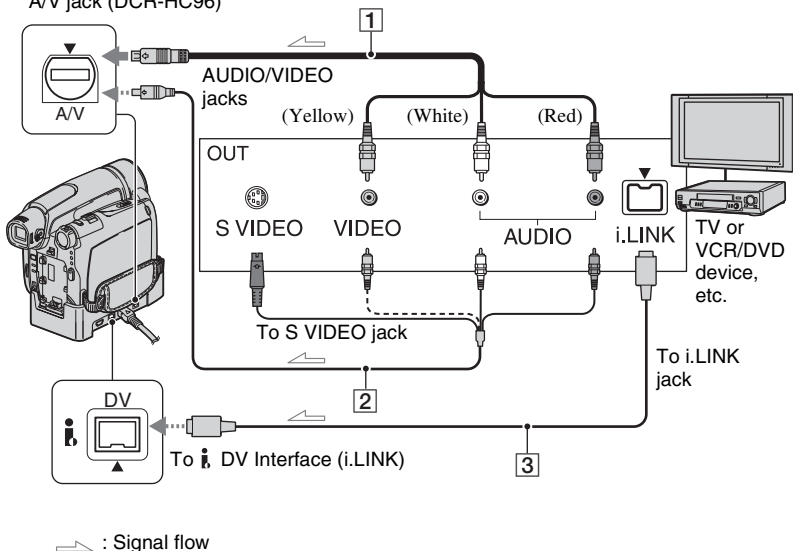

### 1 For DCR-HC96:

#### A/V connecting cable (supplied)

The Handycam Station and your camcorder are both equipped with A/V jacks. Connect the A/V connecting cable either to the Handycam Station or to your camcorder, depending on your setup.

### 2 For DCR-HC96:

#### A/V connecting cable with S VIDEO (optional)

When connecting to another device via the S VIDEO jack, by using the A/V connecting cable with an S VIDEO cable, pictures can be reproduced more faithfully than with the supplied A/V cable connection. Connect the white and red plugs (left/right audio) and S VIDEO plug (S VIDEO channel) of an A/V connecting cable. In this case, the yellow (standard video) plug connection is not necessary. S VIDEO connection only will not input audio.

### 3 i.LINK cable (optional)

Use an i.LINK cable to connect your camcorder to another device equipped with an i.LINK jack. The video and audio signals are transmitted digitally, producing high quality pictures and sound. Note that you cannot input the picture and sound separately.

- While your camcorder is receiving signals from another device via an i.LINK cable, **DV i.LINK** appears on the LCD screen on your camcorder (This indicator may also appear on the connected device.).
- For DCR-HC96:  
When you are connecting your camcorder to a monaural device, connect the yellow plug of the A/V connecting cable to the video jack, and the red (right channel) or the white (left channel) plug to the audio jack on the VCR or the TV.
- For DCR-HC96:  
When you connect a device via an A/V connecting cable, set [DISP OUTPUT] to [LCD PANEL] (the default setting) (p. 68).

### Recording movies



#### 1 Connect your TV or VCR/DVD device to your camcorder as a playback device.



Connect your camcorder to the output jacks of a TV or VCR/DVD device.

#### 2 If you are recording from a VCR/DVD device, insert a cassette or a DVD.



#### 3 Slide the POWER switch repeatedly to turn on the PLAY/EDIT lamp.

#### 4 Set your camcorder to recording pause mode.

When recording on a tape, touch  →  REC CTRL] → [REC PAUSE].

When recording on a “Memory Stick Duo,” touch  → [MENU] →  (EDIT/PLAY) → [ REC MOVIE].

For DCR-HC96:

When connecting with an S VIDEO plug, touch  → [MENU] →  (STANDARD SET) → [VIDEO INPUT] → [S VIDEO].

#### 5 When recording pictures from a VCR/DVD device: Start playing the cassette or the disc on the VCR/DVD device.

When recording pictures from a TV:  
Select a TV program.

The picture played on the connected device appears on the LCD screen of your camcorder.

#### 6 Touch [REC START] at the point you want to start recording.

#### 7 Stop recording.

When recording on a tape, touch  (Stop) or [REC PAUSE].

When recording on a “Memory Stick Duo,” touch [REC STOP].

#### 8 Touch → [].

### Recording still images

#### 1 Perform steps 1 to 3 in “Recording movies.”

#### 2 Start playing the cassette or the disc on the playback device, or select a TV program.

The pictures on the VCR/DVD device or TV appear on the screen of your camcorder.

#### 3 Press PHOTO lightly at the scene you want to record. Check the image and press it fully.

# Dubbing pictures from a tape to a “Memory Stick Duo”

You can record movies or still images on a “Memory Stick Duo.” Make sure you have a recorded tape and a “Memory Stick Duo” inserted into your camcorder.

- For DCR-HC46/HC96:  
Do not insert/eject the cassette while your camcorder is on the Handycam Station. This may cause a malfunction.

- For DCR-HC96:  
The playback pictures edited using [DELAY MOTION] in [D. EFFECT] cannot be dubbed to a “Memory Stick Duo.”

---

## 1 Slide the POWER switch repeatedly to turn on the PLAY/EDIT lamp.



---



## 2 Search and record the scene you want to record.

### When you dub pictures as a still image

Touch  (Play) to play back the tape, then press PHOTO lightly at the scene you want to record. Check the image and press it fully.

### When you dub pictures as a movie

Touch [P-MENU] → [MENU] →  (EDIT/PLAY) → [ REC MOVIE] →  (Play) to play back the tape, then touch [REC START] at the point you want to start recording.

At the point you want to stop recording, touch [REC STOP] →  (Stop) →  → [].

- 
- The date and time the picture is recorded on the tape and stored on the “Memory Stick Duo” are recorded. On your camcorder, the date and time the picture is recorded on the tape are displayed. Camera setting data recorded on the tape cannot be stored on the “Memory Stick Duo.”
  - The sound is recorded in 32kHz monaural.
  - For the recording time of movies, see page 58.
  - For DCR-HC46/HC96:  
Still images will be fixed to image size [0.2M] when playing back the 16:9 picture, or [VGA (0.3M)] when playing back the 4:3 picture.

# Dubbing sound to a recorded tape

You can add sound to a tape already recorded in the 12-bit mode (p. 65) without erasing the original sound.

## Connecting

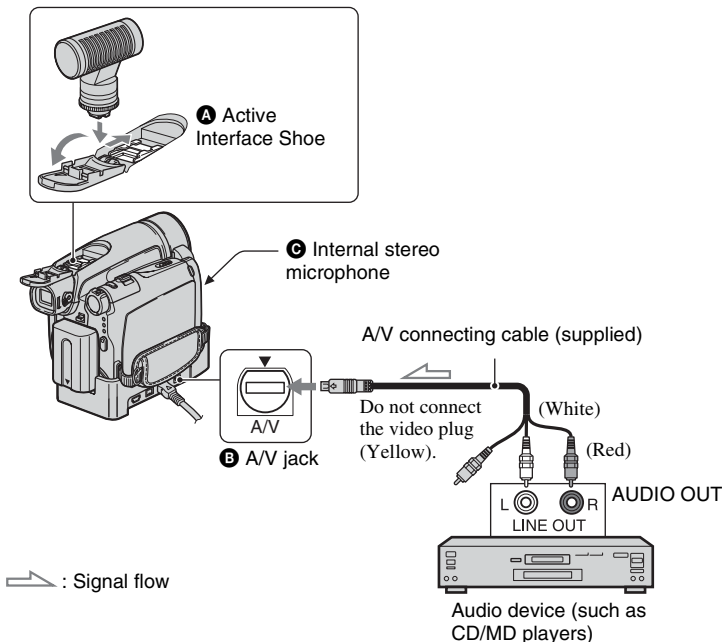

For DCR-HC96:

The Handycam Station and your camcorder are both equipped with A/V jacks. Connect the A/V connecting cable either to the Handycam Station or to your camcorder, depending on your setup.

You can input audio in the following ways:

- A** For DCR-HC96:  
An external microphone (optional) to the Active Interface Shoe.
- B** For DCR-HC96:  
An audio device to the Handycam Station or your camcorder using the A/V connecting cable.

**C** Using the internal stereo microphone (no connection required).

The audio input to be recorded takes precedence over others in the order of **A** → **B** → **C**.

You cannot record additional audio:

- When the tape has been recorded in the 16-bit mode (p. 65).
- When the tape has been recorded in the LP mode.
- When your camcorder is connected via an i.LINK cable.
- When the tape has been recorded in 4CH MIC mode.
- On blank sections of the tape.

- When the tape has been recorded in a TV color system other than that of your camcorder (p. 122).
- When the write-protect tab of the cassette is set to SAVE (p. 123).
- On sections recorded in HDV format.
- The Active Interface Shoe has a safety device for fixing the installed external microphone (optional) securely. To connect, press down and push it to the end, and then tighten the screw. To release, loosen the screw, and then slide it out while pressing down.
- When you are using the A/V jack (DCR-HC96) or the internal stereo microphone, the picture will not be output from the A/V jack. Check the picture on the LCD screen or the viewfinder.
- For DCR-HC46/HC96:  
Do not insert/eject the cassette while your camcorder is on the Handycam Station. This may cause a malfunction.
- For DCR-HC96:  
When you attach an external microphone (optional) to the Active Interface Shoe, you can check the picture and the sound by connecting your camcorder to a TV or other device using the A/V connecting cable. Sound you are recording is not output from your camcorder's speaker. Check the sound using a TV or other device.

## Recording sound

Insert a recorded cassette into your camcorder beforehand.

- 1 Slide the POWER switch repeatedly to turn on the PLAY/EDIT lamp.**
- 2 Touch  (Play/Pause) to play back the tape, then touch it again at the point where you want to start recording the sound.**

- 3 Touch  → [MENU] →  (EDIT/PLAY) →  → [AUD DUB CTRL] →  → [AUDIO DUB].**

 appears.

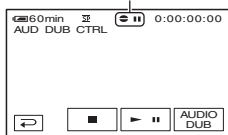

- 4 Touch  (Play) and start playing back the audio you want to record at the same time.**

 appears while recording the new sound in stereo 2 (ST2) during the playback of the tape.

- 5 Touch  (Stop) when you want to stop recording.**

To dub on other scenes, repeat step 2 to select scenes, then touch [AUDIO DUB].

- 6 Touch  → .**

- To set the end point for audio dubbing, beforehand, press ZERO SET MEMORY on the Remote Commander at the scene at which you want to stop audio dubbing during playback. After step 2 to 4, the recording stops automatically at the selected scene.
- You can only record additional audio over a tape recorded on your camcorder. The sound may deteriorate when you dub audio on a tape recorded on other camcorders (including other DCR-HC36/HC46/HC96 camcorders).

## Dubbing sound to a recorded tape (Continued)

### To check the recorded sound

- 1 Play back the tape on which you have recorded audio (p. 31).
- 2 Touch **[P-MENU]** → **[MENU]** →  (STANDARD SET) → **[OK]** → **[AUDIO MIX]** → **[OK]**.

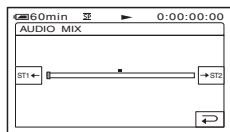

- 3 Touch **[ST1←/→ST2]** to adjust the balance of the original sound (ST1) and the new sound (ST2), then touch **[OK]**.
- The original sound (ST1) is output at the default setting.
  - Audio balance adjustment returns to the default setting after 12 hours of turning the power off.

## Deleting recorded pictures from the “Memory Stick Duo”

- 1 Slide the **POWER** switch repeatedly to turn on the **PLAY/EDIT** lamp.

- 2 Touch **[MEMORY]**.

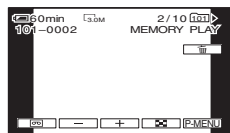

- 3 Select a picture you want to delete with **[-]/[+]**.

- To delete all pictures at once, select **[ALL]** [ALL ERASE] (p. 58).

- 4 Touch **[YES]**.

- The pictures cannot be restored once they are deleted.

- You can delete pictures on the index screen (p. 31). You can easily search for the picture to be deleted by displaying 6 pictures at once. Touch **[SET]** → **[DELETE]** → the picture you want to delete → **[OK]** → **[YES]**.
- Pictures cannot be deleted when a “Memory Stick Duo” with the write-protect tab is set to the selected picture is protected (p. 81).



# Marking images on the “Memory Stick Duo” with specific information (Print mark/Image protection)

When you are using a “Memory Stick Duo” with the write-protect tab, make sure the write-protect tab on the “Memory Stick Duo” is not set to the write-protect position (p. 124).

## Selecting still images for printing (Print mark)

The DPOF (Digital Print Order Format) standard is used to select images for printing on your camcorder.

By marking images that you want to print out, you do not need to reselect them when you print them out. (You cannot specify the number of printouts.)

**1** Slide the **POWER** switch repeatedly to turn on the **PLAY/EDIT** lamp.

**2** Touch **[MEMORY]** →  → **[SET]** → **[PRINT MARK]**.

**3** Touch the image that you want to print out later.

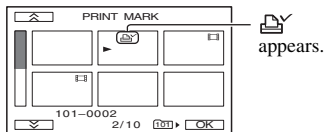

**4** Touch **[OK]** → **[END]**.

• To cancel Print mark, touch the image again to cancel Print mark in step **3**.

• Do not mark images on your camcorder if the “Memory Stick Duo” already has some images with the Print mark put on using other devices. This may change the information of the images with the Print mark put on using the other device.

## Preventing accidental erasure (Image protection)

You can select and mark images to prevent accidental erasure.

**1** Slide the **POWER** switch repeatedly to turn on the **PLAY/EDIT** lamp.

**2** Touch **[MEMORY]** →  → **[SET]** → **[PROTECT]**.

**3** Touch the image that you want to protect.

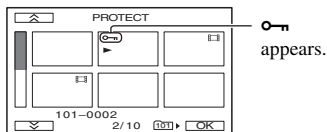

**4** Touch **[OK]** → **[END]**.

• To cancel image protection, touch the image again to cancel image protection in step **3**.

# Printing recorded images (PictBridge compliant printer)

You can print out pictures using a PictBridge compliant printer without connecting the camcorder to a computer.

## PictBridge

Connect the AC Adaptor to obtain power from the wall outlet.

Insert the “Memory Stick Duo” containing still images into your camcorder and turn on the printer.

### Connecting your camcorder to the printer

**1** Slide the **POWER** switch repeatedly to turn on the **PLAY/EDIT** lamp.

**2** Connect the **ψ (USB)** jack of your camcorder (**DCR-HC36**) or the **Handycam Station (DCR-HC46/HC96)** to the printer using the **USB cable**. **[USB SELECT]** appears on the screen automatically.

**3** Touch **[PictBridge PRINT]**.

When connection is complete, **[PictBridge connecting]** appears on the screen.

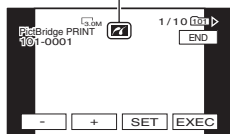

One of the images stored on the “Memory Stick Duo” will be displayed.

• You can also operate by selecting in the following orders:

– Touch **[P.MENU]** → **[MENU]** → **[PictBridge PRINT]**  
(**PICT.APPL.**) → **[USB SELECT]** → **[PictBridge PRINT]**

– Touch **[P.MENU]** → **[MENU]** → **[PictBridge PRINT]**  
(**PICT.APPL.**) → **[PictBridge PRINT]**

• We cannot guarantee the operation of models that are not PictBridge compatible.

## Printing

**1** Select the image to be printed with **[−]/[+]**.

**2** Touch **[SET]** → **[COPIES]**.

**3** Select the number of copies to be printed with **[−]/[+]**.

A maximum of 20 copies of the image can be printed.

**4** Touch **[OK]** → **[END]**.

To print the date and time on the image, touch **[SET]** → **[DATE/TIME]** → **[DATE]** or **[DAY&TIME]** → **[OK]**.

**5** Touch **[EXEC]** → **[YES]**.

When printing is finished, **[Printing...]** disappears and the image selection screen appears again.

Touch **[END]** when printing is completed.

- Refer also to the operating instructions for the printer to be used.
- Do not attempt the following operations when **[PictBridge connecting]** is on the screen. The operations may not be performed properly.
  - Operate the **POWER** switch.

- Disconnect the power cord.
- Remove your camcorder from the Handycam Station (DCR-HC46/HC96).
- Disconnect the USB cable from your camcorder (DCR-HC36) or the Handycam Station (DCR-HC46/HC96) or the printer.
- Remove the “Memory Stick Duo” from your camcorder.
- If the printer stops working, disconnect the USB cable, turn the printer off and on again and restart the operation from the beginning.
- Some printer models may not support the date and time printing function. Refer to your printer’s operating instructions for details.
- We cannot guarantee the printing of images recorded with a device other than your camcorder.
- PictBridge is an industry standard established by the Camera & Imaging Products Association (CIPA). You can print still images without using a computer by connecting a printer directly to a digital video camera or digital still camera, regardless of model or manufacturer.
- For DCR-HC46/HC96:  
If you print a still image recorded with a 16:9 ratio, left and right ends of the image may be cut off.

# Jacks to connect external devices

## Camcorder

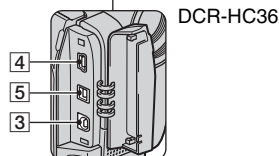
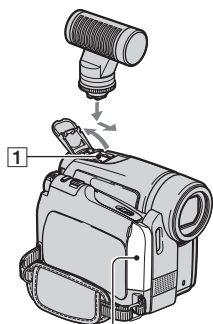

DCR-HC36



DCR-HC46



DCR-HC96

## Bottom

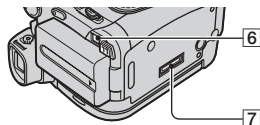

- 1** ...Open the shoe cover.  
**2** - **6** ...Open the jack cover.

## Handycam Station (DCR-HC46/HC96)

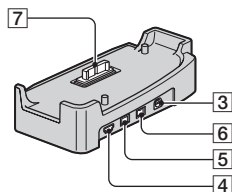

### **1** For DCR-HC96:

Active Interface Shoe  (p. 78)



The Active Interface Shoe supplies power to optional accessories such as a video light, a flash, or a microphone. The accessory can be turned on or off as you operate the POWER switch on your camcorder. Refer to the operating instructions supplied with your accessory for details.

- When you connect an accessory, open the shoe cover.
- The Active Interface Shoe has a safety device for fixing the installed accessory securely. To connect an accessory, press down and push it to the end, and then tighten the screw. To release an accessory, loosen the screw, and then slide it out while pressing down.
- Connecting with an external device wears out the battery pack faster.
- When you are recording movies with an external flash (optional) connected to the accessory shoe, turn off the power of the external flash to prevent charging noise being recorded.
- You cannot use an external flash (optional) and the built-in flash at the same time.
- When an external microphone (optional) is connected, it takes precedence over the internal stereo microphone (p. 35).

### **2** For DCR-HC96:

 LANC jack (blue)

- The LANC control jack is used for controlling the tape transport of video devices and peripherals connected to it.

- 3 For DCR-HC96:  
A/V (audio/video) jack (p. 42, 71, 97)  
For DCR-HC36/HC46:  
A/V (audio/video) OUT jack (p. 42, 71)
  - For DCR-HC46/HC96:  
The Handycam Station and your camcorder are both equipped with A/V jacks.
- 4  (USB) jack (p. 86)
- 5  DV Interface (i.LINK) (p. 71, 94)
- 6 DC IN jack (p. 13)
- 7 Interface connector

## Before referring to the “First Step Guide” on your computer

When you install the Picture Package software on a Windows computer from the supplied CD-ROM, you can enjoy the following operations by connecting your camcorder to your computer.

- Software and features available for Macintosh computers differ from those available for Windows computers. For details, refer to chapter 6 of “First Step Guide” on the supplied CD-ROM. For “First Step Guide,” see page 89.
- There are 2 ways to connect your camcorder to a computer.

- USB cable

This method is good for copying video and sound recorded on a tape to the computer, copying files from a “Memory Stick Duo” to a computer, and copying files to a “Memory Stick Duo.”

Software is not required to copy files from a “Memory Stick Duo” to a computer. (You can connect your camcorder using the standard driver of the computer.)

- i.LINK cable

This method is good for copying video and sound recorded on a tape. Image data is transferred in more clarity than with a USB cable.

For details on connection, see “First Step Guide.”

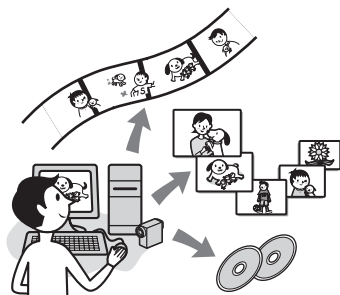

### Viewing video and pictures on PC

You can view the video and still images copied from your camcorder by selecting from thumbnails. Video and still images are saved in folders by date.

### Music Video/Slideshow Producer

You can select your favorite video and still images from video and still images saved on your computer and easily create an original short video or original slide show with added music and visual styles.

### Automatic Music Video Producer

You can easily create an original short video with added music and visual styles using video recorded on a tape.

### Copying tape to Video CD

You can import the entire contents of a tape to create a video CD.

### Save the images on CD-R

You can save video and still images copied onto a computer to a CD-R.

### Burning Video CD

You can compose a video CD with a menu of videos and slide shows. ImageMixer VCD2 is compatible with high resolution still images.

### USB Streaming Tool

You can view live or recorded images from your camcorder on a computer.

### Video Capturing Tool

You can import the entire contents of a tape to a computer.

- The CD-ROM (supplied) includes the following software:
  - USB Driver
  - Picture Package Ver.1.5.1
  - ImageMixer VCD2

– “First Step Guide”

## About “First Step Guide”

“First Step Guide” is an instruction manual you can refer to on your computer. This “First Step Guide” describes basic operations, from initial hookup of your camcorder and computer and making settings, to general operation the first time you use the software stored on the CD-ROM (supplied). Install the CD-ROM, read “Installing the software and “First Step Guide” on a computer” (p. 89), start the “First Step Guide,” then follow the instructions.

## About the help function of the software

The Help guide explains all software application functions. Refer to the Help guide for further detailed operations after reading the “First Step Guide” thoroughly. To display the Help guide, click the [?] mark on the screen.

## System requirements

### ■ For Windows users

#### When using Picture Package

**OS:** Microsoft Windows 2000 Professional, Windows Millennium Edition, Windows XP Home Edition or Windows XP Professional  
Standard installation is required.  
Operation is not assured if the above OS has been upgraded.

**CPU:** Intel Pentium III 500 MHz or faster (800 MHz or faster recommended) (For using ImageMixer VCD2, Intel Pentium 4 1.3 GHz or faster recommended)

**Application:** DirectX 9.0c or later (This product is based on DirectX technology. It is necessary to have DirectX installed.)

Windows Media Player 7.0 or later  
Macromedia Flash Player 6.0 or later

**Sound system:** 16 bit stereo sound card and stereo speakers

**Memory:** 64 MB or more

**Hard disk:** Available memory required for installation: 500 MB or more  
Available free hard disk space recommended: 6 GB or more (depending on the size of the image files edited)

**Display:** 4 MB VRAM video card, Minimum 800 × 600 dots, High color (16 bit color, 65,000 colors), DirectDraw display driver capability (This product will not operate correctly at less than 800 × 600 dots, or 256 colors or less.)

**Others:** USB port (This must be provided as standard), DV Interface (IEEE1394, i.LINK) (to connect via an i.LINK cable), disc drive (You need a CD-R drive to create a video CD. For the compatible drive, visit the following URL: <http://www.ppackage.com/>)

#### When playing pictures recorded on a “Memory Stick Duo” on a computer

**OS:** Microsoft Windows 2000 Professional, Windows Millennium Edition, Windows XP Home Edition or Windows XP Professional  
Standard installation is required.  
Operation is not assured if the above OS has been upgraded.

**CPU:** MMX Pentium 200MHz or faster

**Application:** Windows Media Player (This must be installed to play back movies.)

## Before referring to the “First Step Guide” on your computer (Continued)

**Others:** USB port (This must be provided as standard), disc drive

- If your computer has a Memory Stick slot, insert the “Memory Stick Duo” on which pictures are recorded into the Memory Stick Duo Adaptor (optional), then insert it into the Memory Stick slot on your computer to copy still images to the computer.
- If you try to use the “Memory Stick PRO Duo” on a computer that is not compatible with “Memory Stick PRO Duo,” connect your camcorder to the computer using the USB cable instead of using the “Memory Stick” slot.

### ■ For Macintosh users

#### When using ImageMixer VCD2

**OS:** Mac OS X (v10.1.5 or later)

**CPU:** iMac, eMac, iBook, PowerBook, Power Mac G3/G4/G5 series

**Memory:** 128 MB or more

**Hard disk:** Available memory required for installation: 250 MB or more  
Available free hard disk space recommended: 4 GB or more (depending on the size of the image files edited)

**Display:** Minimum 1,024 × 768 dots, 32,000 colors (This product will not operate correctly at 1,024 × 768 dots or less, or 256 colors or less.)

**Application:** QuickTime 4 or later (QuickTime 5 recommended)

**Other:** Disc drive

#### When only copying pictures recorded on a “Memory Stick Duo” on a computer

**OS:** Mac OS 9.1/9.2 or Mac OS X (v 10.1/v 10.2/v 10.3/v 10.4)

**Application:** QuickTime 3.0 or later (This must be installed to play back movies.)

**Others:** USB port (This must be provided as standard.)

- When you connect your camcorder to a Macintosh computer using a USB cable, you

cannot copy pictures recorded on a tape to the computer. To copy recordings from a tape, connect your camcorder to the computer with an i.LINK cable and use the standard software in the OS.



# Installing the software and “First Step Guide” on a computer

You need to install the software etc., with the supplied CD-ROM on your computer **before connecting your camcorder** and your computer. Once installed, no further installation will be necessary. The software to be used varies depending on the computer’s operating system you are using. Windows computer: Picture Package (including ImageMixer VCD2) Macintosh computer: ImageMixer VCD2 For the details on the software, refer to “First Step Guide.”

## Installing on a Windows computer

Log on as Administrators for installation for Windows 2000/Windows XP.

**1 Confirm that your camcorder is not connected to the computer.**

**2 Turn on the computer.**

Close all applications running on the computer before installing the software.

**3 Place the CD-ROM in the disc drive of your computer.**

The installation screen appears.



The software version of Picture Package is displayed as “1.5.”

If the screen does not appear

- ① Double-click [My Computer].
- ② Double-click [PICTUREPACKAGE] (Disc drive).\*

\* Drive names (such as (E:)) may vary depending on the computer.

**4 Click [Install].**



The software version of Picture Package is displayed as “1.5.”

Depending on the computer’s operating system, a message may appear notifying you that “First Step Guide” cannot be installed automatically with the InstallShield Wizard. In such a case, manually copy “First Step Guide” to your computer according to the message instructions.

**5 Select the language for the application to be installed, then click [Next].**



## 6 Click [Next].

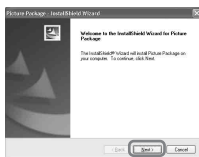

## 7 Read [License Agreement], check [I accept the terms of the license agreement] if you agree, then click [Next].

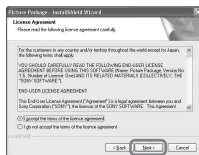

The software version of Picture Package is displayed as “1.5.”

## 8 Select where to save the software, then click [Next].



## 9 Click [Install] on the [Ready to Install the Program] screen.

The installation of Picture Package starts.



## 10 Click [Next] to install the “First Step Guide.”

Depending on the computer, this screen may not be displayed. In such a case, skip to step 11.



## 11 Click [Next], then follow the on-screen instructions to install ImageMixer VCD2.



---

## 12 If the [Installing Microsoft(R) DirectX(R)] screen is displayed, follow the steps below to install DirectX 9.0c. If not, skip to step 13.

- ① Read the License Agreement, then click [Next].



- ② Click [Next].

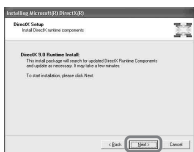

- ③ Click [Finish].



---

## 13 Make sure [Yes, I want to restart my computer now.] is checked, then click [Finish].

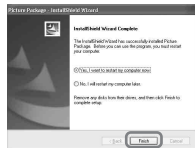

The computer turns off once, then starts up again automatically (Restart). The short-cut icons for [Picture Package Menu] and [Picture Package destination folder] (and “First Step Guide,” if installed in step 10) appear on the desktop.



---

## 14 Remove the CD-ROM from the disc drive of your computer.

---

- For details on connecting your camcorder and computer, see “First Step Guide” on the supplied CD-ROM (p. 93).
- If you have any questions about Picture Package, contact information is listed on page 93.

### Installing on a Macintosh computer

---

**1** Confirm that your camcorder is not connected to the computer.

---

**2** Turn on the computer.

Close all applications running on the computer before installing the software.

---

**3** Place the CD-ROM in the disc drive of your computer.

---

**4** Double-click CD-ROM icon.

---

**5** Copy “FirstStepGuide.pdf,” stored in the desired language in the [FirstStepGuide] folder, to your computer.

---

**6** Copy [IMXINST.SIT] in the [MAC] folder of the CD-ROM to a folder of your choice.

---

**7** Double-click [IMXINST.SIT] in the folder it was copied to.

---

**8** Double-click the unzipped [ImageMixerVCD2\_Install].

---

**9** When the user acceptance screen is displayed, enter your name and password.

The installation of ImageMixer VCD2 starts.

---

- For details on connecting your camcorder and computer, see “First Step Guide” on the supplied CD-ROM (p. 93).
- For details on how to use ImageMixer VCD2, refer to software’s on-line help.

# Viewing “First Step Guide”

## Displaying “First Step Guide”

### Starting up on a Windows computer

Viewing with Microsoft Internet Explorer Ver.6.0 or later is recommended.

Double-click the  icon on the desktop.



You can also start up [First Step Guide] by selecting [Start], [Programs] ([All Programs] for Windows XP), [Picture Package] and [First Step Guide].

- To view “First Step Guide” in HTML without using automatic installation, copy the desired language folder from the [FirstStepGuide] folder on the CD-ROM, and then double-click “index.html.”
- Refer to “FirstStepGuide.pdf” located in your desired language folder in the following cases:
  - When printing “First Step Guide”
  - When “First Step Guide” is not displayed correctly due to the browser setting even in recommended environment.
  - When the HTML version of “First Step Guide” is not installed automatically.

### Starting up on a Macintosh computer

Double-click “FirstStepGuide.pdf.”

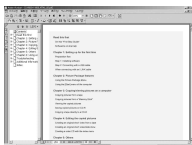

To view the PDF, Adobe Reader is needed. If it is not installed on your computer, you can download it from the Adobe Systems web page:  
<http://www.adobe.com/>

## For inquires about this software

### Pixela User Support Center

Pixela Home Page

Picture Package:

<http://www.ppackage.com/>

ImageMixer VCD2:

<http://www.ImageMixer.com/>

– North America (Los Angeles) Telephone:

(Toll-Free) +1-800-458-4029

+1-213-341-0163

– Europe (U.K.) Telephone:

(Toll-Free) UK, Germany, France and Spain:

+800-1532-4865

Other countries:

+44-1489-564-764

– Asia (Philippines) Telephone:

+63-2-438-0090

### On Copyrights

Music works, sound recording or other third party musical contents you may acquire from CDs, the Internet or other sources (the “Music Contents”) are the copyrighted work of the respective owners thereof and are protected by copyright laws and other applicable laws of each country/region. Except to the extent expressly permitted by applicable laws, you are not permitted to use (including, without limitation, copying, modifying, reproducing, uploading, transmitting or placing to the external network accessible to the public, transferring, distributing, lending, licensing, selling and publishing) any of the Music Contents without obtaining authorization or approval of the respective owners thereof. License of Picture Package by Sony Corporation would not be construed as conferring to you by implication, estoppel or otherwise, any license or right to use the Music Contents.

# Creating a DVD (Direct Access to “Click to DVD”)

You can create a DVD from a tape with a Sony VAIO series computer\* preinstalled with “Click to DVD Ver.1.2” (Sony original software) or later via an i.LINK cable. The picture is automatically copied and written to a DVD.

The following procedures describe how to create a DVD from a recorded tape. For details on system and operation requirements, and “Click to DVD,” visit the following URL:

- Europe  
<http://www.vaio-link.com/>
- USA  
<http://ciscdb.sel.sony.com/perl/select-p-n.pl>
- Asia Pacific Regional  
<http://www.css.ap.sony.com/>
- Korea  
<http://scs.sony.co.kr/>
- Taiwan  
<http://vaio-online.sony.com/tw/vaio/>
- China  
<http://www.sonymstyle.com.cn/vaio/>
- Thailand  
<http://www.sony.co.th/vaio/index.html>
- Latin America  
<http://www.sony-latin.com/vaio/info/index.jsp>

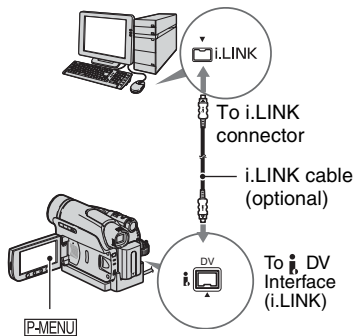

- You can only use an i.LINK cable for this operation. You cannot use a USB cable.

- For DCR-HC46/HC96:  
Do not insert/eject the cassette while your camcorder is on the Handycam Station. This may cause a malfunction.
- \* Note that you need a computer equipped with a DVD drive that can write DVDs.

## Using the Direct Access to “Click to DVD” function for the first time

The Direct Access to “Click to DVD” function enables you to copy pictures recorded on a tape to a DVD easily if your camcorder is connected to a computer. Before operating the Direct Access to “Click to DVD” function, follow the steps below to start “Click to DVD Automatic Mode Launcher.”

- ① Turn on the computer.
  - ② Click the start menu, then select [All Programs].
  - ③ Select [Click to DVD] from the programs displayed, then click [Click to DVD Automatic Mode Launcher].  
[Click to DVD Automatic Mode Launcher] starts up.
- After you start up [Click to DVD Automatic Mode Launcher] once, from then on it starts up automatically when you turn on your computer.
  - [Click to DVD Automatic Mode Launcher] is set up for each Windows XP user.

---

## 1 Turn on the computer.

Close all applications running with an i.LINK.

---

## 2 Prepare the power source for the camcorder.

Use the supplied AC Adaptor as the power source since it takes a few hours to create a DVD.

**3** Slide the **POWER** switch repeatedly to turn on the **PLAY/EDIT** lamp.

**4** Insert a recorded cassette into your camcorder.

**5** Connect your camcorder (DCR-HC36) or the Handycam Station (DCR-HC46/HC96) to a computer via an i.LINK cable (p. 94).

- When you connect your camcorder to a computer, make sure you insert the connector in the correct way. If you insert the connector forcibly, damage may occur and cause camcorder malfunction.
- For details, see "First Step Guide" on the supplied CD-ROM (p. 93).

**6** Touch **[P-MENU]** → **[MENU]** →  **(EDIT/PLAY)** → **[BURN DVD]** → **[OK]**.

"Click to DVD" starts up and the on-screen instructions appear on your computer.

**7** Place a writable DVD in the disc drive of the computer.

**8** Touch **[EXEC]** on the screen of your camcorder.

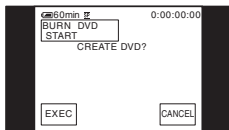

The status of the operation on your computer is displayed on the LCD screen of your camcorder.

[CAPTURING]: The picture recorded on the tape is being copied to the computer.

[CONVERTING]: The picture is being converted to the MPEG2 format.

[WRITING]: The picture is being written onto the DVD.

- If you use a DVD-RW/+RW which has other data stored on it, the message [This is a recorded disc. Delete and overwrite?] appears on the LCD screen of your camcorder. When you touch [EXEC], the existing data is erased and new data is written.

**9** Touch **[NO]** to finish creating a DVD.

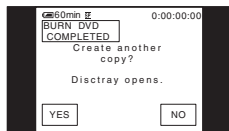

The disc tray comes out automatically. To create another DVD with the same content, touch [YES].

The disc tray comes out. Place a new writable DVD in the disc drive. Then, repeat step 8 and 9.

## To cancel the operation

Touch **[CANCEL]** on the LCD screen on your camcorder.

- You cannot cancel the operation after [Finalizing DVD.] is displayed on the LCD screen of your camcorder.
- Do not disconnect the i.LINK cable or set the **POWER** switch to another mode on your camcorder until the picture is completely copied to the computer.

## Creating a DVD (Direct Access to “Click to DVD”) (Continued)

- When [CONVERTING] or [WRITING] is displayed on the screen, capturing of pictures has already finished. Even if you disconnect the i.LINK cable or turn off the camcorder at this stage, DVD creation will continue on your computer.
- If any of the following occurs, copying of the picture is canceled. A DVD containing the data up to the point the operation was canceled is created. Refer to the help files of “Click to DVD” for details.
  - The tape contains a 10-second blank portion.
  - The tape data contains a date before the date of later images.
  - Both normal and wide pictures are recorded on the same tape (Only for “Click to DVD” older than Ver.2.2).
- You cannot operate [BURN DVD] in the following situations:
  - While a tape is running.
  - While recording images onto a “Memory Stick Duo.”
  - When “Click to DVD” is started up from the computer.
  - For DCR-HC96:  
When [A/V → DV OUT] in the menu setting of your camcorder is set to [ON].



# Connecting an analog VCR to the computer via your camcorder (Signal convert function) (DCR-HC96)

Using an i.LINK cable (3) and the A/V connecting cable (1) or the A/V connecting cable with S VIDEO (2), you can convert an analog signal output from an analog device such as a VCR to a digital signal and transfer it to a digital device, such as a computer, via your camcorder.

Connect your camcorder to the wall outlet using the supplied AC Adaptor for this operation (p. 13).

Software that can record the video signal must be installed on your computer beforehand.

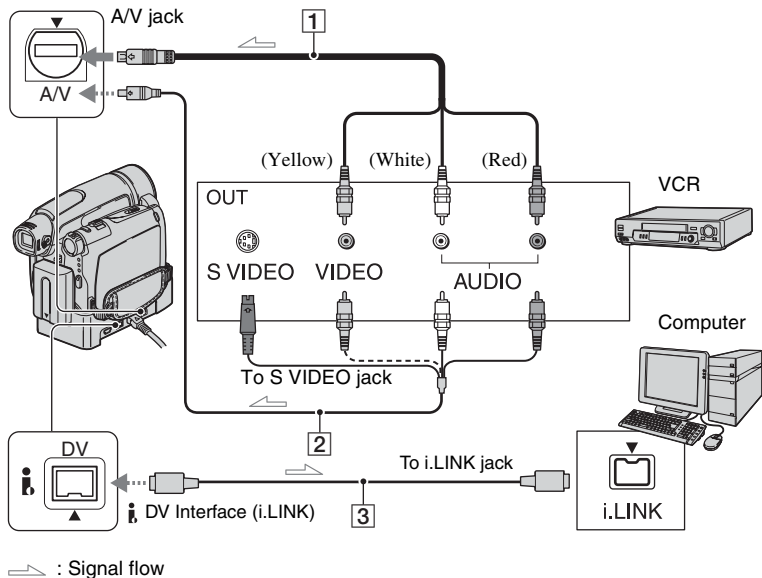

## 1 A/V connecting cable (supplied)

The Handycam Station and your camcorder are both equipped with A/V jacks. Connect the A/V connecting cable either to the Handycam Station or to your camcorder, depending on your setup. The A/V jack accepts analog signals.

## 2 A/V connecting cable with S VIDEO (optional)

When connecting to another device via the S VIDEO jack, by using the A/V connecting cable with an S VIDEO cable, pictures can be reproduced more faithfully than with the supplied A/V cable connection.

Connect the white and red plugs (left/right audio) and S VIDEO plug (S VIDEO channel) of an A/V connecting cable. In this case, the yellow (standard video) plug connection is not necessary. S VIDEO connection only will not output audio.

## 3 i.LINK cable (optional)

Set [DISP OUTPUT] to [LCD PANEL] on the menu (p. 68) beforehand. (The default setting is [LCD PANEL].)





## 1 Turn on the analog video unit.

## Connecting an analog VCR to the computer via your camcorder (Signal convert function) (Continued)

---

**2** Slide the **POWER** switch of your camcorder repeatedly to turn on the **PLAY/EDIT** lamp.

---

**3** On the LCD screen, touch  → **[MENU]** →  (**STANDARD SET**) → **[A/V → DV OUT]** → **[ON]** →  → .

---

**4** Start playback on the analog video unit.

---

**5** Start capturing procedures on your computer.

Regarding operation, refer to the operating instructions supplied with the software or the on-line help.

After capturing images and sound, stop capturing procedures on your computer, and stop playback on the analog video unit.

---

- The bundled software Picture Package or ImageMixer VCD2 does not support the signal convert function.
- You may not be able to output the pictures correctly depending on the condition of the analog video signal input to your camcorder.
- You cannot transfer pictures with copyright protection signals to a computer.
- You can use a USB cable instead of an i.LINK cable to transfer pictures to a computer. Note, however, that the picture displayed may lack the same smoothness.
- When you are using the USB cable or an i.LINK cable to connect your camcorder to a computer, make sure you insert the connectors in the correct way. If you insert the connectors forcibly, damage may occur and cause camcorder malfunction.

# Troubleshooting

If you run into any problems using your camcorder, use the following table to troubleshoot the problem. If the problem persists, disconnect the power source and contact your Sony dealer.

## Overall operations/Easy Handycam

### The power does not turn on.

- Attach a charged battery pack to the camcorder (p. 13).
- Use the AC Adaptor to connect to a wall outlet (p. 13).
- For DCR-HC46/HC96:  
Insert your camcorder into the Handycam Station correctly (p. 14).

### The camcorder does not operate even when the power is set to on.

- Disconnect the AC Adaptor from the wall outlet or remove the battery pack, then reconnect it after about 1 minute.
- Press the RESET button (p. 35) using a sharp-pointed object. (If you press the RESET button, all settings are reset, except Personal Menu items.)

### Buttons do not work.

- During Easy Handycam operation, not all buttons are functional (p. 29).

### Easy Handycam operation cannot be switched to normal operation.

- While recording or communicating with another device via USB cable, you cannot switch Easy Handycam operation to the normal operation.

### Settings change during Easy Handycam operation.

- During Easy Handycam operation, the settings of the functions that are not displayed on the screen return to their defaults. Previously made settings are restored when you cancel the Easy Handycam operation (p. 28, 46).

### [DEMO MODE] does not start.

- You cannot view the demonstration when NIGHTSHOT PLUS (DCR-HC36/HC46)/NIGHTSHOT (DCR-HC96) switch is set to ON (p. 33).
- Eject the cassette and “Memory Stick Duo” from your camcorder (p. 24, 25).

### The camcorder gets warm.

- The camcorder may get warmer while you use it. This is not a malfunction.

### Batteries/Power sources

#### The power abruptly turns off.

- When approximately 5 minutes have elapsed while you do not operate your camcorder, the camcorder is automatically turned off (A.SHUT OFF). Change the setting of [A.SHUT OFF] (p. 68), or turn on the power again (p. 18), or use the AC Adaptor.
- Charge the battery pack (p. 13).

---

#### The CHG (charge) lamp does not light while the battery pack is being charged.

- Slide the POWER switch to OFF (CHG) (p. 13).
- Attach the battery pack to the camcorder correctly (p. 13).
- Connect the power cord to the wall outlet properly.
- The battery charge is completed (p. 14).
- For DCR-HC46/HC96:  
Insert your camcorder into the Handycam Station correctly (p. 14).

---

#### The CHG (charge) lamp flashes while the battery pack is being charged.

- Attach the battery pack to the camcorder correctly (p. 13). If the problem persists, disconnect the AC Adaptor from the wall outlet and contact your Sony dealer. The battery pack may be worn-out.

---

#### The power turns off frequently although the remaining battery time indicator indicates that the battery pack has enough power to operate.

- A problem has occurred in the remaining battery time indicator, or the battery pack has not been charged enough. Fully charge the battery again to correct the indication (p. 13).

---

#### The remaining battery time indicator does not indicate the correct time.

- Ambient temperature is too high or too low, or the battery pack has not been charged enough. This is not a malfunction.
- Fully charge the battery again. If the problem persists, the battery may be worn-out. Replace it with a new one (p. 13, 126).
- The indicated time may not be correct in certain circumstances. For example, when you open or close the LCD panel, it takes about 1 minute to display the correct remaining battery time.

---

#### The battery pack discharges too quickly.

- Ambient temperature is too high or too low, or the battery pack has not been charged enough. This is not a malfunction.
- Fully charge the battery again. If the problem persists, the battery may be worn-out. Replace it with a new one (p. 13, 126).

---

#### A problem occurs when the camcorder is connected to the AC Adaptor.

- Turn off the power, and disconnect the AC Adaptor from the wall outlet. Then, connect it again.

## LCD screen/viewfinder

### An rippling effect appears on the LCD screen when you touch it.

- This is not a malfunction. Do not press hard on the LCD screen.

### An unknown picture appears on the LCD screen or viewfinder.

- The camcorder is in [DEMO MODE] (p. 63). Touch the LCD screen or insert a cassette or a "Memory Stick Duo" to cancel [DEMO MODE].

### An unknown indicator appears on the screen.

- A warning indicator or message appears on the screen (p. 117).



### The picture remains on the LCD screen.

- This occurs if you disconnect the DC plug from your camcorder or remove the battery pack without turning off the power first. This is not a malfunction.

### You cannot turn the LCD backlight off (DCR-HC46/HC96).

- During Easy Handycam operation (p. 28), you cannot turn the LCD backlight on/off by pressing and holding DISP/BATT INFO.

### You cannot turn off the indicators.

- You cannot turn off . Touch  to check the warning messages (p. 118).

### The buttons do not appear on the touch panel.

- Touch the LCD screen lightly.
- Press DISP/BATT INFO on your camcorder (or DISPLAY on the Remote Commander) (p. 21, 40).

### The buttons on the touch panel do not work correctly or do not work at all.

- Adjust the screen ([CALIBRATION]) (p. 130).
- If you change the aspect ratio of the picture, the aspect ratio of the buttons of the touch panel and indicators will switch to the selected one (p. 26).

### The picture in the viewfinder is not clear.

- Move the viewfinder lens adjustment lever until the picture appears clearly (p. 20).

### The picture in the viewfinder has disappeared.

- Close the LCD panel. The picture is not displayed in the viewfinder when the LCD panel is open (p. 20).

### **Dots in lines appear on the LCD screen.**

- This is not a malfunction. These dots are not recorded.

## **Cassette tapes**

### **The cassette cannot be ejected from the compartment.**

- Make sure the power source (battery pack or AC Adaptor) is connected correctly (p. 13).
- Remove the battery pack from the camcorder, then attach it again (p. 15).
- Attach a charged battery pack to the camcorder (p. 13).
- Moisture condensation has occurred inside the camcorder (p. 129).

### **The Cassette Memory indicator or title display does not appear while using a cassette with Cassette Memory.**

- This camcorder does not support Cassette Memory, so the indicator does not appear.

### **The remaining tape indicator is not displayed.**

- Set [ REMAINING] to [ON] to always display the remaining tape indicator (p. 68).

### **The cassette is noisier during rewinding or fast-forwarding.**

- When using the AC Adaptor, rewind/fast forward speed increases (compared with battery operation) and therefore increases noise. This is not a malfunction.

## **“Memory Stick Duo”**

### **You cannot operate functions using the “Memory Stick Duo.”**

- Slide the POWER switch repeatedly to turn on the CAMERA-MEMORY or PLAY/EDIT lamp (p. 18).
- Insert a “Memory Stick Duo” into your camcorder (p. 25).
- If you use a “Memory Stick Duo” formatted on a computer, format it again on your camcorder (p. 58).

### **Pictures cannot be deleted.**

- Release the lock on the write-protect tab of the “Memory Stick Duo” if there is one (p. 124).
- Cancel image protection on the picture (p. 81).
- The maximum number of pictures that you can delete on the index screen at one time is 100.

### **You cannot delete all pictures at once.**

- Release the lock on the write-protect tab of the “Memory Stick Duo” if there is one (p. 124).
- Cancel image protection on the pictures (p. 81).

---

**You cannot format the “Memory Stick Duo.”**

- Release the lock on the write-protect tab of the “Memory Stick Duo” if there is one (p. 124).

---

**Image protection cannot be applied.**

- Release the lock on the write-protect tab of the “Memory Stick Duo” if there is one (p. 124).
- Perform the operation again on the index screen (p. 81).

---

**You cannot mark pictures for print.**

- Release the lock on the write-protect tab of the “Memory Stick Duo” if there is one (p. 124).
- Perform the operation again on the index screen (p. 81).
- The maximum number of pictures you can mark for print is 999.
- Movies cannot be marked for print.

---

**The data file name is not indicated correctly.**

- Only the file name is displayed if the directory structure does not conform to the universal standard.
- The file is damaged.
- The file format is not supported on your camcorder (p. 124).

---

**The data file name flashes.**

- The file is damaged.
- The file format is not supported on your camcorder (p. 124).

## Recording

Refer also to “Adjusting the image during recording” (p. 105) and “Memory Stick Duo” section (p. 102).

---

**The tape does not start when you press REC START/STOP.**

- Slide the POWER switch repeatedly to turn on the CAMERA-TAPE lamp (p. 30).
- The tape has reached the end. Rewind it, or insert a new cassette.
- Set the write-protect tab to REC or insert a new cassette (p. 123).
- The tape is stuck to the drum due to moisture condensation. Remove the cassette and leave your camcorder for at least 1 hour, then re-insert the cassette (p. 129).

---

**You cannot record on the “Memory Stick Duo.”**

- Release the lock on the write-protect tab of the “Memory Stick Duo” if there is one (p. 124).
- The “Memory Stick Duo” is full. Delete unnecessary pictures recorded on the “Memory Stick Duo” (p. 80).
- Format the “Memory Stick Duo” on your camcorder (p. 58) or insert another “Memory Stick Duo” (p. 25).

## Troubleshooting (Continued)

- In the following settings, still images cannot be recorded on a “Memory Stick Duo” during tape recording.
  - [PROGRES.REC] (DCR-HC96)
  - [SMTH INT.REC] (DCR-HC46/HC96)
- For DCR-HC36:  
You cannot record still images on the “Memory Stick Duo” using [WIDE SELECT] mode (p. 54).

---

### The recording angle differs depending on the POWER switch setting position (DCR-HC46/HC96).

- The recording angle when the POWER switch is set to CAMERA-MEMORY is wider than when it is set to CAMERA-TAPE.

---

### You cannot record a smooth transition on a tape from the last recorded scene to the next.

- Perform END SEARCH (p. 39).
- Do not remove the cassette. (The picture will be recorded continuously without a break even when you turn the power off.)
- Do not record pictures in SP mode and LP mode on the same tape.
- Avoid stopping then recording a movie in the LP mode.

---

### The shutter sound is not heard when you record a still image.

- Set [BEEP] to [ON] (p. 68).

---

### The internal flash does not work (DCR-HC96).

- You cannot use the internal flash with:
  - Tape recording
  - [SUPER NS]
  - [COLOR SLOW S]
  - [D. EFFECT]
  - [PROGRES.REC]
  - [BURST]
- Even if auto flash or  (Auto red-eye reduction) is selected, you cannot use the internal flash with:
  - NightShot
  - [SPOTLIGHT], [SUNSET&MOON], and [LANDSCAPE] of [PROGRAM AE]
  - [EXPOSURE]
  - [SPOT METER]

---

### The external flash (optional) does not work (DCR-HC96).

- The power of the flash is not turned on, or the flash is not attached correctly.

---

### [END SEARCH] does not work.

- Do not eject the cassette after recording (p. 39).
- There is nothing recorded on the cassette.



---

**[END SEARCH] does not work correctly.**

- There is a blank section between recorded sections of the tape. This is not a malfunction.

---

**Smooth interval recording stops/[Smooth interval rec discontinued due to error.] appears and recording stops (DCR-HC46/HC96).**

- The video head may be dirty. Use a cleaning cassette (optional).
- Try again from the beginning.
- Use a Sony mini DV cassette.

---

**Adjusting the image during recording**

Refer also to “Menu” (p. 108).

---

**The auto focus does not function.**

- Set [FOCUS] to [AUTO] (p. 51).
- The recording conditions are not suitable for auto focus. Adjust the focus manually (p. 51).

---

**[STEADYSHOT] does not function.**

- Set [STEADYSHOT] to [ON] (p. 55).

---

**The BACK LIGHT function does not function.**

- In the following settings, the BACK LIGHT function is canceled.
  - [MANUAL] of [EXPOSURE]
  - [SPOT METER]
- The BACK LIGHT function does not work during Easy Handycam operation (p. 29).

---

**The [FLASH LEVEL] cannot be changed (DCR-HC96).**

- [FLASH LEVEL] cannot be changed during Easy Handycam operation (p. 52).

---

**[DIGITAL ZOOM] does not function.**

- [DIGITAL ZOOM] does not function when you set [TELE MACRO] to [ON].

---

**A vertical band appears when recording candlelight or electric light in the dark.**

- This occurs when the contrast between the subject and the background is too high. This is not a malfunction.

---

**A vertical band appears when recording a bright subject.**

- This phenomenon is called the smear effect. This is not a malfunction.

## Troubleshooting (Continued)

---

### **Tiny spots in white, red, blue, or green appear on the screen.**

- The spots appear when you are recording in [SLOW SHUTTR], [SUPER NSPLUS] (DCR-HC36/HC46), [SUPER NS] (DCR-HC96), or [COLOR SLOW S]. This is not a malfunction.
- 

### **The color of the picture is not correctly displayed.**

- Deactivate the NightShot plus (DCR-HC36/HC46)/NightShot (DCR-HC96) function (p. 33).
- 

### **The screen picture is bright, and the subject does not appear on the screen.**

- Deactivate the NightShot plus (DCR-HC36/HC46)/NightShot (DCR-HC96) function (p. 33), or cancel the BACK LIGHT function (p. 33).
- 

### **The screen picture is dark, and the subject does not appear on the screen (DCR-HC46/HC96).**

- Press and hold DISP/BATT INFO for a few seconds to turn on the backlight (p. 20).
- 

### **The picture appears too bright, or flickering or changes in color occurs.**

- These anomalies may occur when recording pictures under the discharge tube, such as a fluorescent lamp, sodium lamp, or mercury lamp, with [PORTRAIT] or [SPORTS]. This is not a malfunction. Cancel [PROGRAM AE] to reduce the anomaly (p. 49).
- 

### **Black bands appear when you record a TV screen or computer screen.**

- Set [STEADYSHOT] to [OFF] (p. 55).
- 

## **Playback**

If you are playing back pictures stored on a “Memory Stick Duo,” refer also to the “Memory Stick Duo” section (p. 102).

---

### **You cannot play back tape.**

- Slide the POWER switch repeatedly to turn on the PLAY/EDIT lamp.
  - Rewind the tape (p. 31).
- 

### **The pictures stored on a “Memory Stick Duo” are not played back in their correct size or aspect ratio.**

- Pictures recorded on other devices may not appear in their actual size. This is not a malfunction.
- If you play back a movie recorded on the “Memory Stick Duo” with a 16:9 ratio, black bands will appear at the top and bottom of the screen. This is not a malfunction.

---

**Image data stored on a “Memory Stick Duo” cannot be played back.**

- Image data cannot be played back if you have modified file or folder names, or have edited the data on a computer (In this case, the file name flashes). This is not a malfunction (p. 125).
- Pictures recorded on other devices may not be played back. This is not a malfunction (p. 125).

---

**Horizontal lines appear on the picture. The displayed pictures are not clear or do not appear.**

- Clean the head using the cleaning cassette (optional) (p. 129).

---

**Fine patterns flicker, diagonal lines look jagged (DCR-HC96).**

- Adjust [SHARPNESS] to the  (soften) side (p. 51).

---

**No sound or only a low sound is heard.**

- Set [MULTI-SOUND] to [STEREO] (p. 65).
- Turn up the volume (p. 31).
- Adjust [AUDIO MIX] from the [ST2] (additional sound) side until the sound is heard appropriately (p. 80).
- If you are using an S VIDEO plug, make sure the red and white plugs of the A/V connecting cable are also connected (p. 42).

---

**The sound breaks off.**

- Clean the head using the cleaning cassette (optional) (p. 129).

---

**“---” is displayed on the screen.**

- The tape you are playing was recorded without setting the date and time.
- A blank section on the tape is being played.
- The data code on a tape with a scratch or noise cannot be read.

---

**Noises appear and **PARL** is displayed on the screen.**

- The tape was recorded in a TV color system other than that of your camcorder (NTSC). This is not a malfunction (p. 122).

---

**4ch-12b is displayed on the screen.**

- The tape you are playing was recorded on another device with a 4ch microphone (4CH MIC REC). Your camcorder is not compatible with 4ch microphone recording.

### Date search does not work correctly.

- Be sure to record more than 2 minutes after the date changed. If one day's recording is too short, your camcorder may not accurately find the point where the recording date changes.
- There is a blank section in the beginning or between recorded sections of the tape. This is not a malfunction.

## Remote Commander

### The supplied Remote Commander does not function.

- Set [REMOTE CTRL] to [ON] (p. 68).
- Remove any obstructions between the Remote Commander and the remote sensor.
- Keep strong light sources, such as sunlight or overhead lighting, away from the remote sensor, otherwise the Remote Commander may not function properly.
- Insert a fresh battery in the compartment with its +/- terminals matching those of the compartment (p. 131).
- Remove the conversion lens (optional) as the remote sensor may be obstructed by it.

### Another VCR malfunctions when you use the supplied Remote Commander.

- Select a commander mode other than VTR 2 for your VCR.
- Cover the sensor of your VCR with black paper.

## Menu

### Menu items are grayed out.

- You cannot select grayed items in the current recording/playback situation.

### [P-MENU] is not displayed.

- During Easy Handycam operation, not all menu items are functional. Cancel Easy Handycam operation (p. 28).

### You cannot use [PROGRAM AE].

- You cannot use [PROGRAM AE] together with:
  - NightShot plus (DCR-HC36/HC46)
  - [SUPER NSPLUS] (DCR-HC36/HC46)
  - NightShot (DCR-HC96)
  - [SUPER NS] (DCR-HC96)
  - [COLOR SLOW S]
  - [TELE MACRO]
- [SPORTS] will not work when the POWER switch is set to CAMERA-MEMORY.

### You cannot use [SPOT METER].

- You cannot use [SPOT METER] together with:
  - NightShot plus (DCR-HC36/HC46)
  - [SUPER NSPLUS] (DCR-HC36/HC46)

- NightShot (DCR-HC96)
  - [SUPER NS] (DCR-HC96)
  - [COLOR SLOW S]
  - [CINEMA EFFECT] of [D. EFFECT] (DCR-HC96)
  - If you set [PROGRAM AE], [SPOT METER] is automatically set to [AUTO].
- 

#### **You cannot use [EXPOSURE].**

- You cannot use [EXPOSURE] together with:
    - NightShot plus (DCR-HC36/HC46)
    - [SUPER NSPLUS] (DCR-HC36/HC46)
    - NightShot (DCR-HC96)
    - [SUPER NS] (DCR-HC96)
    - [COLOR SLOW S]
    - [CINEMA EFFECT] of [D. EFFECT] (DCR-HC96)
  - If you set [PROGRAM AE], [EXPOSURE] is automatically set to [AUTO].
- 

#### **You cannot use [WHITE BAL.].**

- You cannot use [WHITE BAL.] when you use NightShot plus or [SUPER NSPLUS] (DCR-HC36/HC46)/NightShot or [SUPER NS](DCR-HC96).
- 

#### **You cannot adjust [SHARPNESS] (DCR-HC96).**

- You cannot adjust [SHARPNESS] with [CINEMA EFFECT] of [D. EFFECT].
- 

#### **[AE SHIFT] cannot be operated (DCR-HC96).**

- [AE SHIFT] cannot be selected when [EXPOSURE] is set to [MANUAL].
- 

#### **You cannot use [SPOT FOCUS].**

- You cannot use [SPOT FOCUS] together with [PROGRAM AE].
- 

#### **You cannot use [TELE MACRO].**

- You cannot use [TELE MACRO] together with:
    - [PROGRAM AE]
    - Recording a movie on a tape or “Memory Stick Duo.”
- 

#### **You cannot use [SUPER NSPLUS] (DCR-HC36/HC46)/[SUPER NS] (DCR-HC96).**

- You cannot use [SUPER NSPLUS] (DCR-HC36/HC46)/[SUPER NS] (DCR-HC96) together with:
    - [FADER]
    - [D. EFFECT]
    - [PROGRAM AE]
-

### **[COLOR SLOW S] does not operate correctly.**

- [COLOR SLOW S] may not operate correctly in total darkness. Use NightShot plus or [SUPER NSPLUS] (DCR-HC36/HC46)/NightShot or [SUPER NS] (DCR-HC96).
  - You cannot use [COLOR SLOW S] together with:
    - [FADER]
    - [D. EFFECT]
    - [PROGRAM AE]
    - [EXPOSURE]
    - [SPOT METER]
- 

### **You cannot use [PROGRES.REC] (DCR-HC96).**

- You cannot use [PROGRES.REC] with [CINEMA EFFECT] of [D. EFFECT].
- 

### **You cannot use [FADER].**

- You cannot use [FADER] together with:
    - [SELF-TIMER]
    - [SUPER NSPLUS] (DCR-HC36/HC46)
    - [SUPER NS] (DCR-HC96)
    - [COLOR SLOW S]
    - [D. EFFECT]
    - [FRAME REC] (DCR-HC96)
    - [SMTH INT.REC] (DCR-HC46/HC96)
- 

### **You cannot use [D. EFFECT].**

- You cannot use [D. EFFECT] together with:
    - [SUPER NSPLUS] (DCR-HC36/HC46)
    - [SUPER NS] (DCR-HC96)
    - [COLOR SLOW S]
    - [FADER]
  - You cannot use [CINEMA EFFECT] (DCR-HC96), [SLOW SHUTTR], and [OLD MOVIE] together with [PROGRAM AE] (except [AUTO]).
  - You cannot use [OLD MOVIE] together with:
    - [PICT. EFFECT]
    - [WIDE SELECT] (DCR-HC36)
  - For DCR-HC96:  
You cannot use [CINEMA EFFECT] together with:
    - [EXPOSURE] set to [MANUAL]
    - Other than 0 in [AE SHIFT]
    - [PROGRES.REC]
    - [PICT. EFFECT]
- 

### **You cannot use [SMTH INT.REC] (DCR-HC96).**

- You cannot use [SMTH INT.REC] when you use [CINEMA EFFECT] or [DELAY MOTION] of [D. EFFECT].

## Dubbing/Editing/Connecting to other devices

### **Pictures output from the camcorder do not appear on the screen of the connected device (DCR-HC46/HC96).**

- When attaching the camcorder to the Handycam Station, close the DC IN jack cover on the camcorder, and then fully insert the camcorder into the Handycam Station in the correct way securely (p. 14).

---

### **Pictures from connected devices are not displayed on the LCD screen or the viewfinder (DCR-HC96).**

- Set [DISP OUTPUT] to [LCD PANEL] (p. 68).
- You cannot input a signal to your camcorder if you press DISP/BATT INFO while [DISP OUTPUT] is set to [V-OUT/PANEL] (p. 68).
- Make sure that the proper video plug is connected to the other device, and then set [VIDEO INPUT] properly (p. 67).

---

### **Pictures from connected devices cannot be zoomed.**

- You cannot zoom pictures from connected devices on your camcorder (p. 34).

---

### **Time code and other information appear on the display of the connected device.**

- Set [DISP OUTPUT] to [LCD PANEL] while connected with an A/V connecting cable (p. 68).

---

### **You cannot dub correctly using the A/V connecting cable.**

- The A/V connecting cable is not connected properly. Make sure that the A/V connecting cable is connected to the proper jack, i.e., to the output jack of a device you are dubbing a picture from (DCR-HC96), or to the input jack of another device for dubbing a picture from your camcorder (p. 71, 74).
- For DCR-HC96:  
Set [DISP OUTPUT] to [LCD PANEL] (p. 68).

---

### **New sound added to a recorded tape is not heard.**

- Adjust [AUDIO MIX] from the [ST1] (original sound) side until the sound is heard appropriately (p. 80).

---

### **Pictures from connected devices are not displayed correctly.**

- The input signal is not NTSC (p. 122).

---

### **Still pictures cannot be dubbed from a tape to a “Memory Stick Duo.”**

- You cannot record or a distorted picture may be recorded if the tape has been used repeatedly for recording.

### **Movies cannot be dubbed from a tape to a “Memory Stick Duo.”**

- You cannot record or a distorted picture may be recorded in the following situations:
    - The tape has a blank section.
    - The tape has been used repeatedly for recording.
    - The input signal has been interrupted or cut.
- 

### **You cannot input pictures using the A/V connecting cable (DCR-HC96).**

- You cannot input pictures while [DISP OUTPUT] is set to [V-OUT/PANEL] (p. 68).
  - You cannot input pictures if you press the DISP/BATT INFO button.
- 

### **The picture gets disturbed or dark, or the sounds get distorted (DCR-HC46/HC96).**

- A/V connecting cables are connected to both your camcorder and the Handycam Station. Disconnect one of the A/V connecting cables.
- 

## Connecting to a computer

### **The computer does not recognize your camcorder.**

- Disconnect the cable from the computer and camcorder, then connect it again securely.
  - Disconnect USB devices other than the keyboard, the mouse, and the camcorder from the  (USB) jack on the computer.
  - Disconnect the cable from the computer and camcorder, restart the computer, then connect them again correctly.
  - For DCR-HC46/HC96:  
Insert you camcorder into the Handycam Station correctly (p. 14).
- 

### **An error message appears when you place the supplied CD-ROM in your computer.**

- Set the computer display as follows:
    - Windows: 800 × 600 dots or more, High Color (16 bits, 65,000 colors or more)
    - Macintosh: 1,024 × 768 dots or more, 32,000 colors or more
- 

### **You cannot view the pictures the camcorder is seeing on the computer.**

- Disconnect the cable from the computer, turn on the camcorder, then connect it again.
  - Slide the POWER switch repeatedly to turn on the CAMERA-TAPE lamp on your camcorder, and set [USB CAMERA] to  [STREAM] (p. 67). (Only when connected to the Windows computer with the USB cable)
- 

### **You cannot view the video recorded on a tape on the computer.**

- Disconnect the cable from the computer, then connect it again.
- Slide the POWER switch repeatedly to turn on the PLAY/EDIT lamp on your camcorder and set [USB SELECT] to  [STREAM] (p. 63). (Only when connected to the Windows computer with the USB cable)



---

**You cannot view the video recorded on a tape on a Macintosh computer. [USB]**

- When you connect your camcorder to a Macintosh computer using the USB cable, you cannot copy pictures recorded on a tape to the computer. To copy recordings from a tape, connect your camcorder to the computer with an i.LINK cable and use the standard software in the OS.

---

**You cannot view the video and still images recorded on a “Memory Stick Duo” on the computer. [USB]**

- Insert a “Memory Stick Duo” in the correct direction, then push it all the way in.
- You cannot use an i.LINK cable. Connect the camcorder and the computer using the USB cable.
- Slide the POWER switch repeatedly to turn on the PLAY/EDIT lamp on your camcorder and set [USB SELECT] to [Memory Stick] (p. 63).
- The computer does not recognize the “Memory Stick Duo” during camcorder operations such as tape playback or editing. Finish any camcorder operations and then connect the camcorder to the computer again.

---

**The Removable Disk does not appear on the computer screen. [USB]**

- Insert a “Memory Stick Duo” into your camcorder.
- Disconnect the USB device other than the keyboard, the mouse, and the camcorder from the computer.
- Slide the POWER switch repeatedly to turn on the PLAY/EDIT lamp and set [USB SELECT] to [Memory Stick] (p. 63).
- The computer does not recognize the “Memory Stick Duo” during camcorder operations such as tape playback or editing. Finish camcorder operations and then connect the camcorder to the computer again.

---

**The image on tape does not appear on the screen of the Windows computer during USB Streaming. [USB]**

- The USB driver has been registered incorrectly as the computer was connected to your camcorder before the installation of the USB driver was completed. Follow the procedure below to install the USB driver correctly.

**■ For Windows Me**

- 1 Check that your camcorder is connected to a computer.
- 2 Right-click [My Computer], then click [Properties].  
The [System Properties] screen appears.
- 3 Click the [Device Manager] tab.
- 4 If the devices below are already installed, right-click them, then click [Remove] to delete them.
  - [USB Audio Device] in the [Sound, video and game controllers] folder
  - [USB Device] in the [Other devices] folder
  - [USB Composite Device] in the [Universal Serial Bus Controller] folder
- 5 When the [Confirm Device Removal] screen appears, click [OK].

## Troubleshooting (Continued)

- 6 Turn off the power of your camcorder, disconnect the USB cable, then restart the computer.
- 7 Place the supplied CD-ROM in the disc drive of your computer.
- 8 Follow the steps below and try to install the USB driver again.
  - 1 Double-click [My Computer].
  - 2 Right-click [PICTUREPACKAGE] (Disc drive)\*.
    - \* Drive names (such as (E:)) may vary depending on the computer.
  - 3 Click [Open].
  - 4 Double-click [Driver].
  - 5 Double-click [Setup.exe].
  - Deleting anything other than [USB Audio Device], [USB Device] and [USB Composite Device] may cause a malfunction of your computer.

### ■ For Windows 2000

Log on as Administrator.

- 1 Check that your camcorder is connected to a computer.
- 2 Right-click [My Computer], then click [Properties].

The [System Properties] screen appears.
- 3 Click the [Hardware] tab → [Device Manager] → [View] → [Devices by type].
- 4 If the devices below are already installed, right-click them, then click [Uninstall] to delete them.
  - [USB Composite Device] in the [Universal Serial Bus Controller] folder
  - [USB Audio Device] in the [Sound, video and game controller] folder
  - [Composite USB Device] in the [Other devices] folder
- 5 When the [Confirm Device Removal] screen appears, click [OK].
- 6 Turn off the power of your camcorder, disconnect the USB cable, then restart the computer.
- 7 Place the supplied CD-ROM in the disc drive of your computer.
- 8 Follow the steps below and try to install the USB driver again.
  - 1 Double-click [My Computer].
  - 2 Right-click [PICTUREPACKAGE] (Disc drive)\*.
    - \* Drive names (such as (E:)) may vary depending on the computer.
  - 3 Click [Open].
  - 4 Double-click [Driver].
  - 5 Double-click [Setup.exe].
  - Deleting anything other than [USB Composite Device], [USB Audio Device] and [Composite USB Device] may cause a malfunction of your computer.

### ■ For Windows XP

Log on as Administrator.

- 1 Check that your camcorder is connected to a computer.
- 2 Click [Start].

- 3 Right-click [My Computer], then click [Properties].  
The [System Properties] screen appears.
- 4 Click the [Hardware] tab → [Device Manager] → [View] → [Devices by type].
- 5 If the devices below are already installed, right-click them, then click [Uninstall] to delete them.
  - [USB Composite Device] in the [Universal Serial Bus Controller] folder
  - [USB Audio Device] in the [Sound, video and game controller] folder
  - [USB Device] in the [Other devices] folder
- 6 When the [Confirm Device Removal] screen appears, click [OK].
- 7 Turn off the power of your camcorder, disconnect the USB cable, then restart the computer.
- 8 Place the supplied CD-ROM in the disc drive of your computer.
- 9 Follow the steps below and try to install the USB driver again.
  - 1 Double-click [My Computer].
  - 2 Right-click [PICTUREPACKAGE] (Disc drive)\*.

\* Drive names (such as (E:)) may vary depending on the computer.

  - 3 Click [Open].
  - 4 Double-click [Driver].
  - 5 Double-click [Setup.exe].
  - Deleting anything other than [USB Composite Device], [USB Audio Device] and [USB Device] may cause a malfunction of your computer.

**You cannot copy video and still images to the Windows computer.** [USB](#)

- Display pictures recorded on a “Memory Stick Duo” with the following procedures.
  - 1 Double-click [My Computer].
  - 2 Double-click the icon for the newly recognized drive [Removable Disk].  
It may take some time until the drive is recognized.
  - 3 Double-click the desired image file.

**[Cannot start Easy Handycam.] or [Cannot cancel Easy Handycam.] appears on the screen of your camcorder.** [USB](#)

- You cannot start or cancel the Easy Handycam settings while the USB cable is connected. Disconnect the USB cable from your camcorder first.

**There is no sound when the camcorder is connected to the Windows computer via a USB cable.** [USB](#)

- Change the settings for your computer environment as described in the following procedures:
  - 1 Select [Start] → [Programs] ([All Programs] for Windows XP) → [Picture Package] → [Handycam Tools] → [USB Streaming Tool].
  - 2 Select another device on the [Select audio device] screen.
  - 3 Follow the on-screen instructions, click [Next], then click [Done].

### **The movie is not smooth during USB Streaming.** [USB]

- Change the settings as described in the following procedures:
    - 1 Select [Start] → [Programs] ([All Programs] for Windows XP) → [Picture Package] → [Handycam Tools] → [USB Streaming Tool].
    - 2 Adjust the slider in the (-) direction on [Select video quality].
    - 3 Follow the on-screen instructions, click [Next], then click [Done].
- 

### **Picture Package does not function correctly.**

- Close Picture Package, then restart the computer.
- 

### **An error message appears while operating Picture Package.**

- Close Picture Package first, then slide the POWER switch on your camcorder to turn on another lamp.
- 

### **The CD-R drive is not recognized or data cannot be written on the CD-R in Picture Package Auto Video, Producer, CD Backup, or VCD Maker.**

- For compatible drives, visit the following URL:  
<http://www.ppackage.com/>
- 

### **[USB streaming... This function is not available.] appears on the screen of your camcorder.** [USB]

- Start recording or playing back pictures recorded on a “Memory Stick Duo” after USB Streaming is finished.
- 

### **“First Step Guide” is not displayed correctly.**

- Follow the procedure below and refer to “First Step Guide” (FirstStepGuide.pdf).
  - 1 Place the supplied CD-ROM in the disc drive of your computer.
  - 2 Double-click [My Computer].
  - 3 Right-click [PICTUREPACKAGE] (Disc drive)\*.
    - \* Drive names (such as (E:)) may vary depending on the computer.
  - 4 Click [Explorer].
  - 5 Double-click [FirstStepGuide].
  - 6 Double-click the desired language folder.
  - 7 Double-click “FirstStepGuide.pdf.”

# Warning indicators and messages

## Self-diagnosis display/Warning indicators

If indicators appear on the LCD screen or in the viewfinder, check the following.

Some symptoms you can fix by yourself. If the problem persists even after you have tried a couple of times, contact your Sony dealer or local authorized Sony service facility.

### C:(or E:) □□:□□ (Self-diagnosis display)

#### C:04:□□

- The battery pack is not an “InfoLITHIUM” battery pack. Use an “InfoLITHIUM” battery pack (p. 126).
- Connect the DC plug of the AC Adaptor to the DC IN jack of your camcorder securely (p. 13).

#### C:21:□□

- Moisture condensation has occurred. Remove the cassette and leave your camcorder for at least 1 hour, then re-insert the cassette (p. 129).

#### C:22:□□

- Clean the head using a cleaning cassette (optional) (p. 129).

#### C:31:□□ / C:32:□□

- Symptoms that are not described above have occurred. Remove and insert the cassette, then operate your camcorder again. Do not perform this procedure if moisture condensation has occurred (p. 129).
- Remove the power source. Reconnect it and operate your camcorder again.
- Change the cassette. Press RESET (p. 35), and operate your camcorder again.

### E:61:□□ / E:62:□□ / E:91:□□

- Contact your Sony dealer or local authorized Sony service facility. Inform them of the 5-digit code, which starts from “E.”

### 101-1001(Warning indicator pertaining to files)

- The file is damaged.
- The file is unreadable (p. 124).

### ⚡ (Battery level warning)

- The battery pack is nearly used up.
- Depending on the operating environment, or battery conditions, ⚡ may flash, even if there are approximately 5 to 10 minutes remaining.

### ☒ (Moisture condensation warning)\*

- Eject the cassette, remove the power source, and then leave it for about 1 hour with the cassette lid open (p. 129).

### Ⓜ (Warning indicator pertaining to “Memory Stick Duo”)

- A “Memory Stick Duo” is not inserted (p. 25).

### Ⓜ (Warning indicators pertaining to “Memory Stick Duo” formatting)\*

- The “Memory Stick Duo” is damaged.
- The “Memory Stick Duo” is not formatted correctly (p. 58, 124).

### Ⓜ (Warning indicator pertaining to incompatible “Memory Stick Duo”)\*

- An incompatible “Memory Stick Duo” is inserted (p. 124).

---

### (Warning indicators pertaining to the tape)

#### **Slow flashing:**

- There is less than 5 minutes remaining on the tape.
- No cassette is inserted.\*
- The write-protect tab on the cassette is set to lock (p. 123).\*

#### **Fast flashing:**

- The tape has run out.\*

---

### (Eject cassette warning)\*

#### **Slow flashing:**

- The write-protect tab on the cassette is set to lock (p. 123).

#### **Fast flashing:**

- Moisture condensation has occurred (p. 129).
- The self-diagnosis display code is displayed (p. 117).

---

### (Warning indicator pertaining to image deletion)\*

- The image is protected (p. 81).

---

### (Warning indicator pertaining to the write-protect of the “Memory Stick Duo”)\*

- The write-protect tab on the “Memory Stick Duo” is set to lock (p. 124).

---

### (Warning indicator pertaining to the flash) (DCR-HC96)

#### **Slow flashing:**

- Still charging

#### **Fast flashing:**

- The self-diagnosis display code is displayed (p. 117).\*
- There is something wrong with the flash.

---

### (Warning indicator pertaining to camera-shake warning)





- The amount of lights is not sufficient, so camera-shake easily occurs. Use the flash (DCR-HC96).
- The camcorder is unsteady, so camera-shake easily occurs. Hold the camcorder steady with both hands and shoot the image. However, note that the camera-shake warning indicator does not disappear.

---

\* You hear a melody when the warning indicators appear on the screen (p. 68).

## Description of warning messages

If messages appear on the screen, follow the instructions.

- When  is displayed, the message can be turned into  by touching . Touch  to display the message again.

## ■ Battery/Power

---

**Use the “InfoLITHIUM” battery pack.** (p. 126)

---

**Battery level is low.**

- Change the battery (p. 13, 126).

---

**Old battery. Use a new one.** (p. 126)

---

**▲ Re-attach the power source.** (p. 13)

---

**Use new AC adapter or reinsert.** (p. 14)

## ■ Moisture condensation

 **Moisture condensation. Eject the cassette** (p. 129)

 **Moisture condensation. Turn off for 1H.** (p. 129)

## ■ Cassette/Tape

 **Insert a cassette.** (p. 24)

 **Reinsert the cassette.** (p. 24)

- Check if the cassette is damaged.

 **The tape is locked - check the tab.** (p. 123)

 **The tape has reached the end.** (p. 24, 31)

- Rewind or change the tape.

## ■ “Memory Stick Duo”

 **Insert a Memory Stick.** (p. 25)

 **Reinsert the Memory Stick.** (p. 25, 124)

- Reinsert the “Memory Stick Duo” a few times. If even then the indicator flashes, the “Memory Stick Duo” might be damaged. Try with another “Memory Stick Duo.”

**This is a read-only Memory Stick.**

- Insert a writable “Memory Stick Duo.”

 **Incompatible type of Memory Stick.**

- A type of “Memory Stick Duo” incompatible with your camcorder is inserted (p. 124).

 **This Memory Stick is not formatted correctly.**

- Check the format, then format the “Memory Stick Duo” as necessary (p. 58, 124).

**Cannot record. The Memory Stick is full.**

- Delete unnecessary images (p. 80).

 **The Memory Stick is locked. Check the tab.** (p. 124)

**Cannot playback. Reinsert the Memory Stick.** (p. 25)

**Cannot record. Reinsert the Memory Stick.** (p. 25)

**No file.**

- No file is recorded or there is no readable file on the “Memory Stick Duo.”

**USB streaming... This function is not available.**

- You tried to play back or record on a “Memory Stick Duo” during USB Streaming.

**Memory Stick folders are full.**

- You cannot create folders exceeding 999MSDCF. You cannot delete created folders using your camcorder.
- You will have to format the “Memory Stick Duo” (p. 58), or delete them using your computer.

**Cannot record still images on Memory Stick.** (p. 124)

**Cannot record movies on Memory Stick.** (p. 124)

## Warning indicators and messages (Continued)

### ■ PictBridge compliant printer

---

#### Check the connected device.

- Switch off the printer and switch it on again, then disconnect the USB cable and reconnect it.

#### Connect the camcorder to a PictBridge compatible printer.

- Switch off the printer and switch it on again, then disconnect the USB cable and reconnect it.

#### Error. Cancel the task.

- Check the printer.

#### Cannot print. Check the printer.

- Switch off the printer and switch it on again, then disconnect the USB cable and reconnect it.

### ■ Flash (DCR-HC96)

---

#### Charging... Cannot record still images.

- You are trying to record a still image while charging the flash.

### ■ Lens cover (DCR-HC96)

---

#### Lens cover not fully open. Turn power off then on. (p. 18)

#### Lens cover is not closed. Turn the power off once. (p. 18)

### ■ Others

---

#### Cannot record due to copyright protection. (p. 123)

---

#### Cannot add audio. Disconnect the i.LINK cable. (p. 78)

---

#### Not recorded in SP mode. Cannot add audio. (p. 78)

---

#### Not recorded in 12-bit audio. Cannot add audio. (p. 78)

---

#### Cannot add audio on the blank portion of a tape. (p. 78)

---

#### Cannot add audio. (p. 78)

- You cannot add sound to a tape recorded on other devices by 4CH MIC REC.

---

#### Dirty video head. Use a cleaning cassette. (p. 129)

---

#### Cannot start Easy Handycam. (p. 28, 99)

---

#### Cannot cancel Easy Handycam. (p. 28, 99)

---

#### Invalid during Easy Handycam operation. (p. 29)

---

#### USB is invalid in this mode during Easy Handycam.

- During Easy Handycam operation with  [STREAM] in [USB CAMERA] selected while the POWER switch is set to CAMERA-TAPE, you cannot use a USB cable.

---

#### HDV recorded tape. Cannot playback.

- Your camcorder cannot play back this format. Play back the tape with the equipment that recorded it.



---

**HDV recorded tape. Cannot add audio.**

- Your camcorder does not allow you to add audio on a section of a tape recorded in HDV format (p. 78).

---

**Disconnect one AV cable.** (DCR-HC46/HC96)

- A/V connecting cables are connected to both the camcorder and the Handycam Station. Disconnect one of them.
- When the A/V connecting cable is connected only to your camcorder, your camcorder is not attached to the Handycam Station correctly. Attach the Handycam Station correctly.

# Using your camcorder abroad

## Power supply

You can use your camcorder in any country/region using the AC Adaptor supplied with your camcorder within the AC 100 V to 240 V, 50/60 Hz range. Use a commercially available AC plug adaptor [a], if necessary, depending on the design of the wall outlet [b].

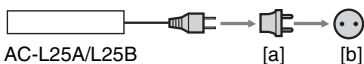

AC-L25A/L25B

[a]

[b]

## On TV color systems

Your camcorder is NTSC system, so its picture can only be viewed on an NTSC system TV with an AUDIO/VIDEO input jack.

System	Used in
NTSC	Bahama Islands, Bolivia, Canada, Central America, Chile, Colombia, Ecuador, Guyana, Jamaica, Japan, Korea, Mexico, Peru, Surinam, Taiwan, the Philippines, the U.S.A., Venezuela, etc.
PAL	Australia, Austria, Belgium, China, Czech Republic, Denmark, Finland, Germany, Holland, Hong Kong, Hungary, Italy, Kuwait, Malaysia, New Zealand, Norway, Poland, Portugal, Singapore, Slovak Republic, Spain, Sweden, Switzerland, Thailand, United Kingdom, etc.
PAL - M	Brazil
PAL - N	Argentina, Paraguay, Uruguay.
SECAM	Bulgaria, France, Guiana, Iran, Iraq, Monaco, Russia, Ukraine, etc.

## Simple setting of the clock by time difference

You can easily set the clock to local time abroad by the time difference you are in. Select [WORLD TIME] in the (TIME/LANGU.) menu, then set the time difference (p. 69).

# Usable cassette tapes

You can use mini DV format cassettes only. Use a cassette with the <sup>Mini</sup>DV mark. Your camcorder is not compatible with cassettes with Cassette Memory.

## To prevent a blank section from being created on the tape

Go to the end of the recorded section using END SEARCH (p. 39) before you begin the next recording in the following cases:

- You have played back the tape.
- You have used EDIT SEARCH.

## Copyright signal

### ■ When you play back

If the cassette you play back on your camcorder contains copyright signals, you cannot copy it to a tape in another video camera connected to your camcorder.

### ■ When you record

You cannot record software on your camcorder that contains copyright control signals for copyright protection of software. [Cannot record due to copyright protection.] appears on the LCD screen, or on the viewfinder if you try to record such software. Your camcorder does not record copyright control signals on the tape when it records.

## Notes on use

### ■ When not using your camcorder for a long time

Remove the cassette and store it.

### ■ To prevent accidental erasure

Slide the write-protect tab on the cassette to set it to SAVE.

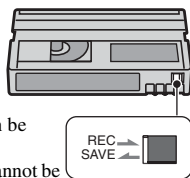

REC: The cassette can be recorded.

SAVE: The cassette cannot be recorded (write-protected).

### ■ When labeling the cassette

Be sure to place the label only on the locations shown in the following illustration so as not to cause a malfunction of your camcorder.

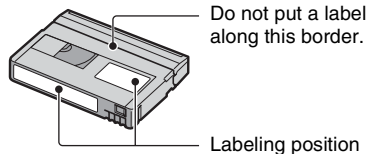

### ■ After using the cassette

Rewind the tape to the beginning to avoid distortion of the picture or the sound. The cassette should then be put in its case, and stored in an upright position.

### ■ When cleaning the gold-plated connector

Generally, clean the gold-plated connector on a cassette with a cotton-wool swab after every 10 times it has been ejected.

If the gold-plated connector on the cassette is dirty or dusty, the remaining tape indicator may not show correctly.

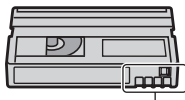

Gold-plated connector

# About the “Memory Stick”

A “Memory Stick” is a compact, portable IC recording medium with a data capacity that exceeds the capacity of a floppy disk. You can use only a “Memory Stick Duo,” which is about the half size of a standard “Memory Stick” in your camcorder. However, appearance on the list below does not guarantee the operation of all types of “Memory Stick Duo” in your camcorder.

Types of “Memory Stick”	Recording/ Playback
“Memory Stick” (without MagicGate)	–
“Memory Stick Duo” (without MagicGate)*1	○
“MagicGate Memory Stick”	–
“Memory Stick Duo” (with MagicGate)*1	○*2*3
“MagicGate Memory Stick Duo” *1	○*3
“Memory Stick PRO”	–
“Memory Stick PRO Duo” *1	○*2*3

\*1 A “Memory Stick Duo” is about half the size of a standard “Memory Stick.”

\*2 The types of “Memory Stick” that support high speed data transfer. The speed of data transfer varies depending on the device to be used.

\*3 “MagicGate” is a copyright protection technology that records and transfers the contents in an encrypted format. Note that data that uses “MagicGate” technology cannot be recorded or played on your camcorder.

- Still image format: Your camcorder compresses and records image data in the JPEG (Joint Photographic Experts Group) format. The file extension is “.JPG.”
- Movie format: Your camcorder compresses and records picture data in the MPEG (Moving Picture Experts Group) format. The file extension is “.MPG.”
- File names of still images:
  - 101-0001: This file name appears on the screen of your camcorder.
  - DSC00001.JPG: This file name appears on the display of a computer.

- File names of movies:
  - MOV00001: This file name appears on the screen on your camcorder.
  - MOV00001.MPG: This file name appears on the display of a computer.
- A “Memory Stick Duo” formatted by a computer (Windows OS/Mac OS) does not have guaranteed compatibility with your camcorder.
- Data read/write speed may vary depending on the combination of the “Memory Stick” and “Memory Stick” compliant product you use.

## On a “Memory Stick Duo” with a write-protect tab

You can prevent accidental erasure of images when you slide the write-protect tab on the “Memory Stick Duo” with a small tapered object, to the write-protect position.

## Notes on use

Damaged or lost image data will not be compensated for, and may occur in the following cases:

- If you eject the “Memory Stick Duo,” turn the power off on your camcorder, or remove the battery pack for replacement while your camcorder is reading or writing image files on the “Memory Stick Duo” (while the access lamp is lit or flashing).
- If you use the “Memory Stick Duo” near magnets or magnetic fields.

It is recommended you make a back-up of important data on the hard disk of a computer.

### ■ On handling a “Memory Stick”

Keep the following in mind when handling a “Memory Stick Duo.”

- Be careful not to apply excessive force when writing on a memo area on a “Memory Stick Duo.”
- Do not attach a label or the like on a “Memory Stick Duo” or a Memory Stick Duo adaptor.
- When you carry or store a “Memory Stick Duo,” put it in its case.
- Do not touch, or allow metallic objects to come into contact with the terminals.
- Do not bend, drop or apply strong force to the “Memory Stick Duo.”

- Do not disassemble or modify the “Memory Stick Duo.”
- Do not let the “Memory Stick Duo” get wet.
- Be careful to keep “Memory Stick Duo” media out of the reach of small children. There is danger that a child might swallow it.
- Do not insert anything other than a “Memory Stick Duo” into the “Memory Stick Duo” slot. Doing so may cause a malfunction.

#### ■ On a location for use

Do not use or keep the “Memory Stick Duo” in the following locations.

- Places subject to extremely high temperature, such as a car parked outside in the summer.
- Places under direct sunlight.
- Places with extremely high humidity or subject to corrosive gases.

#### ■ On the Memory Stick Duo adaptor

After inserting a “Memory Stick Duo” into the Memory Stick Duo adaptor, you can use it with a standard “Memory Stick” compliant device.

- When using a “Memory Stick Duo” with a “Memory Stick” compliant device, be sure to insert the “Memory Stick Duo” into a Memory Stick Duo adaptor.
- When inserting a “Memory Stick Duo” into a Memory Stick Duo adaptor, make sure the “Memory Stick Duo” is inserted facing in the correct direction, then insert it all the way in. Note that improper use may cause a malfunction. Also, if you force the “Memory Stick Duo” into the “Memory Stick Duo” slot in the wrong direction, the Memory Stick Duo adaptor may be damaged.
- Do not insert a Memory Stick Duo adaptor without a “Memory Stick Duo” attached. Doing so may result in malfunctions of the unit.

#### ■ On a “Memory Stick PRO Duo”

- The maximum memory capacity of a “Memory Stick PRO Duo” that can be used on your camcorder is 2 GB.
- This unit does not support high speed data transfer.

## On image data compatibility

- Image data files recorded on a “Memory Stick Duo” by your camcorder conform to the “Design rule for Camera File system” universal standard established by the JEITA (Japan Electronics and Information Technology Industries Association).
- On your camcorder, you cannot play back still images recorded on other devices (DCR-TRV900 or DSC-D700/D770) that do not conform to the universal standard. (These models are not sold in some regions.)
- If you cannot use a “Memory Stick Duo” that has been used with another device, format it with your camcorder (p. 58). Note that formatting erases all information on the “Memory Stick Duo.”
- You may not be able to play back images with your camcorder:
  - When playing back image data modified on your computer.
  - When playing back image data recorded with other devices.

# About the “InfoLITHIUM” battery pack

This unit is compatible with an “InfoLITHIUM” battery pack (P series). Your camcorder operates only with an “InfoLITHIUM” battery pack. “InfoLITHIUM” P series battery packs have the  mark.

## What is an “InfoLITHIUM” battery pack?

An “InfoLITHIUM” battery pack is a lithium-ion battery pack that has functions for communicating information related to operating conditions between your camcorder and an optional AC Adaptor/charger.

The “InfoLITHIUM” battery pack calculates the power consumption according to the operating conditions of your camcorder, and displays the remaining battery time in minutes.

## To charge the battery pack

- Be sure to charge the battery pack before you start using your camcorder.
- We recommend charging the battery pack in an ambient temperature of between 10 °C to 30 °C (50 °F to 86 °F) until the CHG (charge) lamp turns off. If you charge the battery pack outside of this temperature range, you may not be able to charge it efficiently.
- When charging the battery pack while the AC Adaptor is connected to your camcorder, after charging is complete, disconnect the cable from the DC IN jack on your camcorder or remove the battery pack.

## To use the battery pack effectively

- Battery pack performance decreases when the surrounding temperature is 10 °C (50 °F) or below, and the length of time you can use the battery pack becomes shorter. In that case, do one of the following to use the battery pack for a longer time.
  - Put the battery pack in a pocket to warm it up, and insert it in your camcorder right before you start taking shots.
  - Use a large capacity battery pack: NP-FP70/FP71/FP90 (optional).

- Frequent use of the LCD screen or a frequent playback, fast forward or rewind operation wears out the battery pack faster. We recommend using a large capacity battery pack: NP-FP70/FP71/FP90 (optional).
- Be sure to set the POWER switch to OFF (CHG) when not recording or playing back on your camcorder. The battery pack is also consumed when your camcorder is in recording standby or playback pause.
- Have spare battery packs ready for two or three times the expected recording time, and make trial recordings before making the actual recording.
- Do not expose the battery pack to water. The battery pack is not water resistant.

## About the remaining battery time indicator

- When the power goes off even though the remaining battery time indicator indicates that the battery pack has enough power to operate, charge the battery pack fully again. Remaining battery time will be indicated correctly. Note, however, that the battery indication will not be restored if it is used in high temperatures for a long time, or if left in a fully charged state, or when the battery pack is frequently used. Use the remaining battery time indication as a rough guide only.
- The  mark that indicates low battery flashes even if there are still 5 to 10 minutes of battery time remaining, depending on the operating conditions or ambient temperature.

## About storage of the battery pack

- If the battery pack is not used for a long time, fully charge the battery pack and use it up on your camcorder once a year to maintain proper function. To store the battery pack, remove it from your camcorder and put it in a dry, cool place.
- To discharge the battery pack on your camcorder completely, set [A.SHUT OFF] to [NEVER] on the  (STANDARD SET) menu and leave your camcorder in tape recording standby until the power goes off (p. 68).

# About i.LINK

## About battery life

- Battery capacity decreases over time and through repeated use. If decreased usage time between charges becomes significant, it is probably time to replace it with a new one.
- Each battery's life is governed by storage, operating and environmental conditions.

The DV Interface on this unit is an i.LINK-compliant DV Interface. This section describes the i.LINK standard and its features.

## What is i.LINK?

i.LINK is a digital serial interface for transferring digital video, digital audio, and other data to other i.LINK-compatible devices. You can also control other devices using the i.LINK.

i.LINK-compatible devices can be connected using an i.LINK cable. Possible applications are operations and data transactions with various digital AV devices.

When two or more i.LINK-compatible devices are daisy-chained with the unit, operation becomes possible from any device in the chain. Note that operation method may vary, or data transactions may not be possible, depending on specifications and characteristics of the connected devices.

- Normally, only one device can be connected to this unit with an i.LINK cable. When connecting this unit to an i.LINK-compatible device having two or more DV Interfaces, refer to the operating instructions of the device to be connected.
- i.LINK is a more familiar term for the IEEE 1394 data transport bus proposed by Sony, and is a trademark approved by many corporations.
- IEEE 1394 is an international standard standardized by the Institute of Electrical and Electronics Engineers.

## About the i.LINK Baud rate

i.LINK's maximum baud rate varies according to the device. There are 3 types.

S100 (approx. 100Mbps\*)

S200 (approx. 200Mbps)

S400 (approx. 400Mbps)

The baud rate is listed under "Specifications" in the operating instructions of each piece of equipment. It

is also indicated near the i.LINK interface on some devices.

The baud rate may differ from the indicated value when the unit is connected to a device with a different maximum baud rate.

### \* What is Mbps?

Mbps stands for “megabits per second,” or the amount of data that can be sent or received in one second. For example, a baud rate of 100 Mbps means that 100 megabits of data can be sent in one second.

### To use i.LINK functions on this unit

For details on how to dub when this unit is connected to other video devices having a DV Interface, see page 71, 74.

This unit can also be connected to other i.LINK (DV Interface) compatible devices made by Sony (e.g. a VAIO series personal computer) as well as to video devices. Some i.LINK compatible video devices, such as Digital Televisions, DVD, MICROMV or HDV recorders/players are not compatible with DV devices. Before connecting to other devices, be sure to confirm whether the device is compatible with a DV device or not. For details on precautions and compatible application software, refer also to the operating instructions for the device to be connected.

### About the required i.LINK cable

Use the Sony i.LINK 4-pin-to-4-pin cable (during DV dubbing).

# Maintenance and precautions

## On use and care

- Do not use or store the camcorder and accessories in the following locations.
  - Anywhere extremely hot or cold. Never leave them exposed to temperatures above 60 °C (140 °F), such as under direct sunlight, near heaters or in a car parked in the sun. They may malfunction or become deformed.
  - Near strong magnetic fields or mechanical vibration. The camcorder may malfunction.
  - Near strong radio waves or radiation. The camcorder may not be able to record properly.
  - Near AM receivers and video equipment. Noise may occur.
  - On a sandy beach or anywhere dusty. If sand or dust gets in your camcorder, it may malfunction. Sometimes this malfunction cannot be repaired.
  - Near windows or outdoors, where the LCD screen, the viewfinder, or the lens may be exposed to direct sunlight. This damages the inside of the viewfinder or the LCD screen.
  - Anywhere very humid.
- Operate your camcorder on DC 7.2 V (battery pack) or DC 8.4 V (AC Adaptor).
- For DC or AC operation, use the accessories recommended in these operating instructions.
- Do not let your camcorder get wet, for example, from rain or sea water. If your camcorder gets wet, it may malfunction. Sometimes this malfunction cannot be repaired.
- If any solid object or liquid gets inside the casing, unplug your camcorder and have it checked by a Sony dealer before operating it any further.
- Avoid rough handling, disassembling, modifying, physical shock, or impact such as hammering, dropping or stepping on the product. Be particularly careful of the lens.
- Keep the POWER switch setting to OFF (CHG) when you are not using your camcorder.
- Do not wrap your camcorder with a towel, for example, and operate it. Doing so might cause heat to build up inside.
- When disconnecting the power cord, pull it by the plug and not the cord.
- Do not damage the power cord such as by placing anything heavy on it.
- Keep metal contacts clean.





- Keep the Remote Commander and button-type battery out of children's reach. If the battery is accidentally swallowed, consult a doctor immediately.
- If the battery electrolytic liquid has leaked,
  - consult your local authorized Sony service facility.
  - wash off any liquid that may have contacted your skin.
  - if any liquid gets in your eyes, wash with plenty of water and consult a doctor.

### ■ When not using your camcorder for a long time



- Periodically turn on the camcorder and play a cassette for about 3 minutes.
- Use up the battery pack completely before storing it.

### Moisture condensation

If your camcorder is brought directly from a cold place to a warm place, moisture may condense inside your camcorder, on the surface of the tape, or on the lens. In this state, the tape may stick to the head drum and be damaged or your camcorder may not operate correctly. If there is moisture inside your camcorder, []  Moisture condensation. Eject the cassette] or [] Moisture condensation. Turn off for 1H.] appears. The indicator will not appear when the moisture condenses on the lens.

### ■ If moisture condensation has occurred

None of the functions except cassette ejection will work. Eject the cassette, turn off your camcorder, and leave it for about one hour with the cassette lid open. Your camcorder can be used again when both of the following conditions are met:

- The warning message does not appear when the power is turned on.
- Neither  or  flash when a cassette is inserted and video operation buttons are touched.

If moisture starts to condense, your camcorder sometimes cannot detect condensation. If this happens, the cassette is sometimes not ejected for 10 seconds after the cassette lid is opened. This is not a

malfunction. Do not close the cassette lid until the cassette is ejected.

### ■ Note on moisture condensation

Moisture may condense when you bring your camcorder from a cold place into a warm place (or vice versa) or when you use your camcorder in a humid place as shown below.

- When you bring your camcorder from a ski slope into a place warmed up by a heating device.
- When you bring your camcorder from an air conditioned car or room into a hot place outside.
- When you use your camcorder after a squall or a shower.
- When you use your camcorder in a hot and humid place.

### ■ How to avoid moisture condensation

When you bring your camcorder from a cold place into a warm place, put your camcorder in a plastic bag and seal it tightly. Remove the bag when the air temperature inside the plastic bag has reached the surrounding temperature (after about one hour).

### Video head

- If the video heads are dirty, video or sound distortion may be apparent.
- If the following problem occurs, clean the video heads for 10 seconds with the Sony DVM-12CLD cleaning cassette (optional).
  - Mosaic-pattern noise appears on the playback picture or the screen is displayed in blue.



- Playback pictures do not move.
- Playback pictures do not appear or the sound breaks off.
- [] Dirty video head. Use a cleaning cassette.] appears on the screen during recording/playback.

## Maintenance and precautions (Continued)

- The video heads will wear after long use. If you cannot obtain a clear image even after using a cleaning cassette (optional), it might be because the video heads are worn. Please contact your Sony dealer or local authorized Sony service facility to have the video heads replaced.

### LCD screen

- Do not exert excessive pressure on the LCD screen, as it may cause damage.
- If your camcorder is used in a cold place, a residual image may appear on the LCD screen. This is not a malfunction.
- While using your camcorder, the back of the LCD screen may heat up. This is not a malfunction.

#### ■ To clean the LCD screen

If fingerprints or dust make the LCD screen dirty, it is recommended you use a soft cloth to clean it. When you use the LCD Cleaning Kit (optional), do not apply the cleaning liquid directly to the LCD screen. Use cleaning paper moistened with the liquid.

#### ■ On adjustment of the LCD screen (CALIBRATION)

The buttons on the touch panel may not work correctly. If this happens, follow the procedure below. It is recommended you connect your camcorder or the Handycam Station (supplied with DCR-HC46/HC96) to the wall outlet using the supplied AC Adaptor during the operation.

- ① Slide the POWER switch repeatedly to turn on the PLAY/EDIT lamp.
- ② Disconnect cables other than that of the AC Adaptor from your camcorder or the Handycam Station (supplied with DCR-HC46/HC96), then eject the cassette and "Memory Stick Duo" from your camcorder.
- ③ Touch **[P-MENU]** → **[MENU]** →  (STANDARD SET) → **[CALIBRATION]** → **[OK]**.
  - For DCR-HC46/HC96:  
The screen changes to 16:9 ratio when using 4:3 ratio.

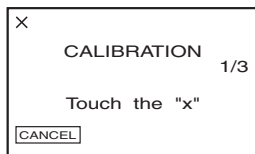

- ④ Touch the "x" displayed on the screen with the corner of the "Memory Stick Duo" or the like.

The position of the "x" changes.

To cancel [CALIBRATION], touch [CANCEL] in step ④.

If you did not press the right spot, start from step ④ again.

- You cannot calibrate the LCD screen if it is rotated.

### On handling the casing

- If the casing is soiled, clean the camcorder body with a soft cloth lightly moistened with water, and then wipe the casing with a dry soft cloth.
- Avoid the following to avoid damage to the finish.
  - Using chemicals such as thinner, benzine, alcohol, chemical cloths, repellent, insecticide and sunscreen.
  - Handling with above substances on your hands.
  - Leaving the casing in contact with rubber or vinyl objects for a long period of time.

### About care and storage of the lens

- Wipe the surface of the lens clean with a soft cloth in the following instances:
  - When there are fingerprints on the lens surface.
  - In hot or humid locations
  - When the lens is exposed to salty air such as at the seaside.
- Store in a well-ventilated location subject to little dirt or dust.
- To prevent mold, periodically clean the lens as described above. It is recommended that you operate your camcorder about once a month to keep it in optimum state for a long time.

## On charging the pre-installed rechargeable battery

Your camcorder has a pre-installed rechargeable battery to retain the date, time, and other settings even when the POWER switch is set to OFF (CHG). The pre-installed rechargeable battery is always charged while your camcorder is connected to the wall outlet via the AC Adaptor or while the battery pack is attached. The rechargeable battery will be fully discharged in about **3 months** if you do not use your camcorder at all without the AC Adaptor connected or the battery pack attached. Use your camcorder after charging the pre-installed rechargeable battery.

However, even if the pre-installed rechargeable battery is not charged, the camcorder operation will not be affected as long as you are not recording the date.

### ■ Procedures

Connect your camcorder to a wall outlet using the supplied AC Adaptor, and leave it with the POWER switch set to OFF (CHG) for more than 24 hours.

## To change the battery of the Remote Commander

- ① While pressing on the tab, inset your fingernail into the slit to pull out the battery case.
- ② Place a new battery with the + side facing up.
- ③ Insert the battery case back into the Remote Commander until it clicks.

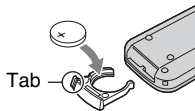

## WARNING

Battery may explode if mistreated. Do not recharge, disassemble or dispose of in fire.

- A button-type lithium battery (CR2025) is used in the Remote Commander. Do not use batteries other than the CR2025.
- When the lithium battery becomes weak, the operating distance of the Remote Commander may shorten, or the Remote Commander may not function properly. In this case, replace the battery with a Sony CR2025 lithium battery. Use of another battery may present a risk of fire or explosion.

# Specifications

## System

### Video recording system

2 rotary heads, Helical scanning system

### Still image recording system

Exif Ver. 2.2\*1

### Audio recording system

Rotary heads, PCM system

Quantization: 12 bits (Fs 32 kHz, stereo 1, stereo 2), 16 bits (Fs 48 kHz, stereo)

### Video signal

NTSC color, EIA standards

### Usable cassette

Mini DV cassette with the  mark printed

### Tape speed

SP: Approx. 18.81 mm/s

LP: Approx. 12.56 mm/s

### Recording/playback time

SP: 60 min (using a DVM60 cassette)

LP: 90 min (using a DVM60 cassette)

### Fast forward/rewind time

Approx. 2 min 40 s (using a DVM60 cassette and rechargeable battery pack)

Approx. 1 min 45 s (using a DVM60 cassette and AC Adaptor)

### Viewfinder

Electric viewfinder (color)

### Image device

DCR-HC36:  
3.0 mm (1/6 type) CCD (Charge Coupled Device)

Gross: Approx. 680 000 pixels  
Effective (still): 340 000 pixels  
Effective (movie): 340 000 pixels

DCR-HC46:  
3.27 mm (1/5.5 type) CCD (Charge Coupled Device)

Gross: Approx. 1 070 000 pixels  
Effective (still): 1 000 000 pixels  
Effective (movie): 690 000 pixels

DCR-HC96:

5.9 mm (1/3 type) CCD (Charge Coupled Device)

Gross: Approx. 3 310 000 pixels

Effective (still): 3 050 000 pixels

Effective (movie): 2 050 000 pixels

## Lens

DCR-HC36:

Carl Zeiss Vario-Tessar

20 × (Optical), 800 × (Digital)

DCR-HC46:

Carl Zeiss Vario-Tessar

12 × (Optical), 800 × (Digital)

DCR-HC96:

Carl Zeiss Vario-Sonnar T\*

10 × (Optical), 120 × (Digital)

## Focal length

DCR-HC36:

f=2.3 ~ 46 mm (3/32 ~ 1 13/16 in.)

When converted to a 35 mm still camera

In CAMERA-TAPE:

44 ~ 880 mm (1 3/4 ~ 34 1/32 in.)

In CAMERA-MEMORY:

44 ~ 880 mm (1 3/4 ~ 34 1/32 in.)

F1.8 ~ 3.1

Filter diameter: 25 mm (1 in.)

DCR-HC46:

f=3.0 ~ 36 mm (1/8 ~ 1 7/16 in.)

When converted to a 35 mm still camera

In CAMERA-TAPE:

46 ~ 628.5 mm (1 13/16 ~ 24 3/4 in.) (16:9)\*2

48 ~ 576 mm (1 15/16 ~ 22 3/4 in.) (4:3)

In CAMERA-MEMORY:

43.6 ~ 523.2 mm (1 3/4 ~ 20 5/8 in.) (16:9)

40 ~ 480 mm (1 5/8 ~ 19 in.) (4:3)

F1.8 ~ 2.5

Filter diameter: 25 mm (1 in.)

DCR-HC96:

f=5.1 ~ 51 mm (7/32 ~ 2 1/8 in.)

When converted to a 35 mm still camera

In CAMERA-TAPE:

42.8 ~ 495 mm (1 11/16 ~ 19 1/2 in.)

(16:9)\*<sup>2</sup>

45 ~ 450 mm (1 13/16 ~ 17 3/4 in.)

(4:3)

In CAMERA-MEMORY:

40.6 ~ 406 mm (1 5/8 ~ 16 in.) (16:9)

37 ~ 370 mm (1 1/2 ~ 14 5/8 in.) (4:3)

F1.8 ~ 2.9

Filter diameter: 30 mm (1 3/16 in.)

### Color temperature

[AUTO], [ONE PUSH], [INDOOR]

(3 200 K), [OUTDOOR] (5 800 K)

### Minimum illumination

DCR-HC36/HC96:

5 lx (lux) (F 1.8)

0 lx (lux) (during NightShot plus (DCR-HC36)/NightShot (DCR-HC96) function)\*<sup>3</sup>

DCR-HC46:

7 lx (lux) (F 1.8)

0 lx (lux) (NightShot plus function)\*<sup>3</sup>

\*1“Exif” is a file format for still images, established by the JEITA (Japan Electronics and Information Technology Industries Association). Files in this format can have additional information such as your camcorder’s setting information at the time of recording.

\*<sup>2</sup>In 16:9 mode, the focal length figures are actual figures resulting from wide angle pixel read-out.

\*<sup>3</sup>Objects unable to be seen due to the dark can be shot with infrared lighting.

## Input/Output connectors

### Audio/Video output

DCR-HC36/HC46:

10-pin connector

Video signal: 1 Vp-p, 75 Ω (ohms), unbalanced

Luminance signal: 1 Vp-p, 75 Ω (ohms), unbalanced

Chrominance signal: 0.286 Vp-p, 75 Ω (ohms), unbalanced

Audio signal: 327 mV (at load impedance 47 kΩ (kilohms)), Output impedance with less than 2.2 kΩ (kilohms)

### Audio/Video input/output

DCR-HC96:

10-pin connector

Input/output auto switch

Video signal: 1 Vp-p, 75 Ω (ohms), unbalanced

Luminance signal: 1 Vp-p, 75 Ω (ohms), unbalanced

Chrominance signal: 0.286 Vp-p, 75 Ω (ohms), unbalanced

Audio signal: 327 mV (at load impedance 47 kΩ (kilohms)), Input impedance more than 47 kΩ (kilohms), Output impedance with less than 2.2 kΩ (kilohms)

### USB jack (DCR-HC36)

mini-B

### LANC jack (DCR-HC96)

Stereo mini-minijack (Ø 2.5 mm)

### DV input/output (DCR-HC36)

i.LINK Interface (IEEE1394, 4-pin connector S100)

## LCD screen

### Picture

DCR-HC36:

6.2 cm (2.5 type)

DCR-HC46/HC96:

6.9 cm (2.7 type, aspect ratio 16:9)

## Specifications (Continued)

### Total dot number

123 200 (560 × 220)

### General

#### Power requirements

DC 7.2 V (battery pack)

DC 8.4 V (AC Adaptor)

#### Average power consumption

DCR-HC36:

During camera recording using the viewfinder 1.9 W

During camera recording using the LCD 2.3 W

DCR-HC46:

During camera recording using the viewfinder 2.4 W

During camera recording using the LCD 2.7 W

DCR-HC96:

During camera recording using the viewfinder 3.0 W

During camera recording using the LCD 3.4 W

During camera recording using the viewfinder and the LCD 3.6 W

#### Operating temperature

0 °C to 40 °C (32 °F to 104 °F)

#### Storage temperature

-20 °C to +60 °C (-4 °F to +140 °F)

#### Dimensions (approx.)

DCR-HC36/HC46:

65 × 79 × 113 mm

(2 5/8 × 3 1/8 × 4 1/2 in.) (w/h/d)

DCR-HC96:

72 × 91 × 120 mm

(2 7/8 × 3 5/8 × 4 3/4 in.) (w/h/d)

### Mass (approx.)

DCR-HC36:

370 g (13 oz) main unit only,

430 g (15 oz) including the NP-FP30 rechargeable battery pack and DVM60 cassette

DCR-HC46:

380 g (13 oz) main unit only,

445 g (15 oz) including the NP-FP50 rechargeable battery pack and DVM60 cassette

DCR-HC96:

460 g (1 lb) main unit only,

525 g (1 lb 2 oz) including the NP-FP50 rechargeable battery pack and DVM60 cassette

### Supplied accessories

See page 12.

### Handycam Station Input/Output connectors

#### DCRA-C151 (DCR-HC46)

#### Audio/Video output

10-pin connector

Video signal: 1 V<sub>p-p</sub>, 75 Ω (ohms), unbalanced

Luminance signal: 1 V<sub>p-p</sub>, 75 Ω (ohms), unbalanced

Chrominance signal: 0.286 V<sub>p-p</sub>, 75 Ω (ohms), unbalanced

Audio signal: 327 mV (at load impedance 47 kΩ (kilohms)), Output impedance with less than 2.2 kΩ (kilohms)

#### USB jack

mini-B

#### DV input/output

i.LINK Interface (IEEE1394, 4-pin connector S100)

## DCRA-C152 (DCR-HC96)

### Audio/Video input/output

10-pin connector

Input/output auto switch

Video signal: 1 Vp-p, 75  $\Omega$  (ohms), unbalanced

Luminance signal: 1 Vp-p, 75  $\Omega$  (ohms), unbalanced

Chrominance signal: 0.286 Vp-p, 75  $\Omega$  (ohms), unbalanced

Audio signal: 327 mV (at load impedance 47 k $\Omega$  (kilohms)), Input impedance more than 47 k $\Omega$  (kilohms), Output impedance with less than 2.2 k $\Omega$  (kilohms)

### USB jack

mini-B

### DV input/output

i.LINK Interface (IEEE1394, 4-pin connector S100)

## AC Adaptor AC-L25A/L25B

### Power requirements

AC 100 - 240 V, 50/60 Hz

### Current consumption

0.35 - 0.18 A

### Power consumption

18 W

### Output voltage

DC 8.4 V\*

### Operating temperature

0 °C to 40 °C (32 °F to 104 °F)

### Storage temperature

-20 °C to + 60 °C (-4 °F to + 140 °F)

### Dimensions (approx.)

56 × 31 × 100 mm (2 1/4 × 1 1/4 × 4 in.) (w/h/d) excluding the projecting parts

### Mass (approx.)

190 g (6.7 oz) excluding the power cord

\* See the label on the AC Adaptor for other specifications.

## Rechargeable battery pack NP-FP30 (DCR-HC36)

### Maximum output voltage

DC 8.4 V

### Output voltage

DC 7.2 V

### Capacity

3.6 Wh (500 mAh)

### Dimensions (approx.)

31.8 × 18.5 × 45.0 mm  
(1 5/16 × 3/4 × 1 13/16 in.) (w/h/d)

### Mass (approx.)

40 g (1.5 oz)

### Operating temperature

0 °C to 40 °C (32 °F to 104 °F)

### Type

Lithium ion

## NP-FP50 (DCR-HC46/HC96)

### Maximum output voltage

DC 8.4 V

### Output voltage

DC 7.2 V

### Capacity

4.9 Wh (680 mAh)

### Dimensions (approx.)

31.8 × 18.5 × 45.0 mm  
(1 5/16 × 3/4 × 1 13/16 in.) (w/h/d)

### Mass (approx.)

45 g (1.6 oz)

### Operating temperature

0 °C to 40 °C (32 °F to 104 °F)

### Type

Lithium ion

Design and specifications are subject to change without notice.

## Specifications (Continued)

### Types of differences



DCR-HC	36	46
A/V jack	OUT	OUT
DV Interface	IN/OUT	IN/OUT
Handycam Station	–	●
LANC jack	–	–

DCR-HC	96
A/V jack	IN/OUT
DV Interface	IN/OUT
Handycam Station	●
LANC jack	●

● Provided

– Not provided

### On trademarks



- “Memory Stick,” “,” “Memory Stick Duo,” “**MEMORY STICK DUO**,” “Memory Stick PRO Duo,” “**MEMORY STICK PRO DUO**,” “MagicGate,” “**MAGIC GATE**,” “MagicGate Memory Stick” and “MagicGate Memory Stick Duo” are trademarks of Sony Corporation.
- “InfoLITHIUM” is a trademark of Sony Corporation.
- i.LINK and  are trademarks of Sony Corporation.
- Picture Package is a trademark of Sony Corporation.
- Mini  Digital Video Cassette is a trademark.
- “Handycam” and **HANDYCAM** are registered trademarks of Sony Corporation.
- Microsoft, Windows, and Windows Media are trademarks or registered trademarks of U.S. Microsoft Corporation in the U.S. and other countries.
- Windows Media Player is a trademark of Microsoft Corporation.
- iMac, iBook, eMac, Macintosh, Mac OS, PowerBook and Power Mac are trademarks of Apple Computer, Inc in the U.S. and other countries.
- QuickTime and the QuickTime logo are trademarks of Apple Computer, Inc.
- Adobe, the Adobe logo, and Adobe Acrobat are either registered trademarks or trademarks of Adobe Systems Incorporated in the United States and/or other countries.
- Roxio is a registered trademark of Roxio, Inc.
- Toast is a trademark of Roxio, Inc.
- Macromedia and Macromedia Flash Player are trademarks or registered trademarks of Macromedia, Inc. in the United States and other countries.
- Pentium is a trademark or registered trademark of Intel Corporation.

All other product names mentioned herein may be the trademarks or registered trademarks of their respective companies. Furthermore, <sup>TM</sup> and “®” are not mentioned in each case in this manual.



# Index

## Numeric/Symbol

12BIT .....	65
16:9 WIDE.....	54
16BIT .....	65
4:3 .....	54
 Memory Stick.....	63
 STREAM.....	63

## A

A.SHUT OFF (Auto shut off) .....	68
A/V connecting cable .....	43, 72, 75, 78, 97
A/V jack .....	42, 71, 72, 75, 78, 97
A/V → DV OUT .....	67
AC Adaptor.....	13
Access lamp .....	25
Active Interface Shoe .....	78, 84
Adjusting exposure for back light.....	33, 105
AE SHIFT .....	51, 109
ALL ERASE.....	58
Aspect ratio .....	26
AUD DUB CTRL (Audio dubbing) .....	79
AUDIO MIX.....	66, 80
AUDIO MODE.....	65
AUTO SHUTTER .....	51

## B

B&W.....	62
BACK LIGHT .....	33, 105
BATT (battery) release lever .....	15
Battery	

BATT INFO (Battery info) .....	35
Charging time .....	15
Playing time.....	16
Recording time .....	15
Remaining battery .....	35

BEACH&SKI.....	49
BEEP .....	68
BLACK FADER .....	59
BURN DVD .....	65, 94
BURN VCD .....	64
BURST .....	55
Button-type lithium battery .....	131

## C

CALIBRATION.....	130
CAMERA DATA .....	67
CAMERA SET menu.....	49
Cassette .....	24, 123
Cassette compartment ...	24
Insert/Eject.....	24
Write-protect tab .....	123
CD-ROM.....	86
Charging the battery.....	13
Battery pack .....	13
Pre-installed rechargeable battery .....	131
CINEMA EFFECT (Cinematic effect) .....	61
Click to DVD .....	94
CLOCK SET .....	23
COLOR SLOW S (Color Slow Shutter) ...	53, 110
Compression format.....	124
Computer.....	86, 89
Connect	
Computer .....	86
TV .....	42
VCR .....	71, 72, 74, 75

## D

D. EFFECT (Digital effect).....	60, 110
DATA CODE.....	23, 36, 67
Date search.....	41
DATE/TIME .....	23, 36, 67
DC IN jack .....	13

DC plug .....	13
DELAY MOTION.....	61
Delete pictures .....	80
DEMO MODE.....	63, 99
DIGITAL ZOOM .....	54, 105
DISP GUIDE (Display guide) .....	21
DISP OUTPUT.....	68
DISP/BATT INFO button .....	20, 35
Display indicators .....	36
DOT FADER .....	60
Double speed Playback.....	64
Dubbing .....	71, 77, 78
DV Interface .....	71, 72, 74, 75, 85, 94, 97

## E

EASY button .....	28
Easy Handycam .....	28, 45
EDIT SEARCH .....	39
EDIT/PLAY menu.....	64
END SEARCH .....	39, 65
END SEARCH/EDIT SEARCH/Rec review display switch button .....	36
ERASE	
ALL ERASE .....	58
Pictures .....	80
EXP. BRKTG (Exposure bracketing) .....	55
EXPOSURE .....	50, 109

## F

FADER .....	59, 110
FILE NO. (File number).....	58
FINE .....	56
Fireworks .....	49
First Step Guide.....	86, 93
FLASH (Flash motion).....	61
Flash button .....	32, 104
FLASH LEVEL.....	52, 105

## Index (Continued)

- FLASH SET ..... 52
- Flexible spot meter  
..... See SPOT METER
- FOCUS ..... 51, 105
- Folder
- NEW FOLDER ..... 59
  - PB FOLDER  
(Playback folder) ..... 59
  - REC FOLDER  
(Recording folder) ..... 59
- FORMAT ..... 58, 124
- FRAME REC  
(Frame recording) ..... 62
- Frame-by-frame Playback ..... 64
- ### G
- Getting Started ..... 12
- Grip belt ..... 18
- GUIDEFRAAME ..... 67
- ### H
- Handycam Station ..... 13, 84
- Help ..... 87
- Holding the camcorder ..... 18
- ### I
- i.LINK ..... 127
- i.LINK cable ..... 72, 75, 94, 97
- Icon ..... See Display indicators
- ID-1/ID-2 ..... 43, 54
- Image delete button ..... 37
- Image protection ..... 81
- Image quality  
(QUALITY) ..... 56
- Image size  
(IMAGE SIZE) ..... 56, 58
- Movie ..... 58
  - Still image ..... 56
- ImageMixer VCD2 ..... 86, 89
- Index screen ..... 31
- Index screen display button  
..... 37
- Indicators ..... 38
- INDOOR ..... 50
- “InfoLITHIUM” battery pack  
..... 126
- Initialize (Reset) ..... 35
- Install ..... 89
- Insulation sheet ..... 40
- INT.REC-STL  
(Interval photo recording) ..... 63
- Interface connector ..... 85
- Internal stereo microphone  
..... 35
- ### J
- Jack ..... 84
- JPEG ..... 124
- ### L
- Label ..... 123
- LANC jack ..... 84
- LANDSCAPE ..... 49
- LANGUAGE ..... 69
- LCD backlight ..... 20, 101
- LCD BL LEVEL  
(LCD back light level) ..... 66
- LCD BRIGHT ..... 66
- LCD COLOR ..... 66
- LCD PANEL ..... 68
- LCD panel ..... 20
- LCD screen ..... 20
- LCD/VF SET ..... 66
- Lens cap ..... 12, 30
- Lens cover ..... 18, 30
- LETTER BOX ..... 66
- Lid ..... 24
- LP (Long Play) ..... 65
- LUMI. KEY  
(Luminance key) ..... 61
- ### M
- Macintosh ..... 88, 92
- Main sound ..... 66
- Maintenance ..... 128
- MEMORY SET menu ..... 55
- “Memory Stick” ..... 124
- “Memory Stick Duo” ..... 24
- FORMAT ..... 58
  - Insert/Eject ..... 25
  - Number of recordable  
pictures ..... 56
  - Recordable time ..... 58
  - Write-protect tab ..... 124
- Memory Stick Duo adaptor  
..... 125
- “Memory Stick Duo” slot ..... 25
- Menu ..... 44
- CAMERA SET menu ..... 49
  - EDIT/PLAY menu ..... 64
  - MEMORY SET menu ..... 55
  - Menu items ..... 46
  - Personal Menu ..... 44, 69
  - PICT.APPLI. menu ..... 59
  - STANDARD SET menu  
..... 65
  - TIME/LANGU. menu ..... 69
  - Using the menu ..... 44
- MENU ROTATE ..... 68
- Mirror mode ..... 34
- Moisture condensation ..... 129
- MONOTONE ..... 59
- MOSAIC ..... 62
- MOSAIC FADER ..... 59
- Movie
- Movie format ..... 124
  - REC MODE  
(Recording mode) ..... 65
- MOVIE SET ..... 58
- MPEG ..... 124
- MPEG MOVIE EX ..... 30
- MULTI-SOUND ..... 65
- ### N
- NEG.ART ..... 62
- NEW FOLDER ..... 59
- NightShot ..... 33

NightShot plus .....	33
NIGHTSHOT PLUS switch .....	33, 52
NIGHTSHOT switch.....	33, 53
NORMAL.....	55
NS LIGHT (NightShot Light) .....	53
NTSC.....	107, 122
Number of recordable pictures .....	56

## O

OLD MOVIE.....	61
ONE PUSH.....	50
OPEN/EJECT lever .....	24
Operation confirmation beep .....	See BEEP
OUTDOOR.....	50
OVERLAP.....	60

## P

P.MENU ....	See Personal Menu
PAL.....	122
PASTEL.....	62
PB FOLDER (Playback folder) .....	59
PB zoom .....	34
Personal Menu .....	44, 69
Add .....	69
Arrange the order.....	70
Customize.....	69
Delete.....	70
Reset.....	70
Use.....	44
Personal Menu button.....	36
PHOTO button.....	28, 30, 40
PICT. EFFECT (Picture effect) .....	62
PICT.APPLI. menu (Picture Application menu).....	59
PictBridge.....	82
PictBridge PRINT.....	63

Picture Package.....	86
Picture Search .....	31
Pixela user support center ...	93
Playback.....	31
Double speed.....	64
Frame .....	64
Reverse.....	64
Slow .....	64
PORTRAIT (Soft portrait) ...	49
Power cord .....	13
POWER switch .....	13, 18
Pre-installed rechargeable battery.....	131
Previous/Next image button .....	37
Print.....	82
Print mark.....	81
PROGRAM AE.....	49, 108
PROGRES.REC .....	55, 110

## Q

QUALITY .....	56
---------------	----

## R

REC CTRL (Recording control) .....	76
REC FOLDER (Recording folder).....	59
REC LAMP (Recording lamp) .....	68
REC MODE (Recording mode) .....	65
REC MOVIE.....	77
Rec review.....	39
REC START/STOP button .....	28, 30
Recording .....	30
Recording capacity.....	36
Recording lamp .....	35
Recording time .....	58
REDEYE REDUC .....	52
REMAINING.....	68

Remaining battery .....	36
Remote Commander.....	40
REMOTE CTRL (Remote control).....	68
Remote sensor .....	35
RESET button.....	35
Reversal Playback .....	64
Review button.....	36

## S

S VIDEO cable ...	43, 72, 75, 97
S VIDEO jack.....	43, 72, 75, 97
Searching for the starting point .....	39
Self-diagnosis display.....	117
SELF-TIMER .....	53
SEPIA .....	62
Setting the date and time .....	23
SHARPNESS .....	51, 109
Shoulder belt.....	34
Signal convert function.....	97
Skip Scan .....	31
SLIDE SHOW .....	60
Slow Playback .....	64
SLOW SHUTTR (Slow shutter) .....	61
SMTH INT.REC (Smooth interval tape recording) .....	62, 110
Software.....	89
SOLARIZE.....	62
SP (Standard Play).....	65
Speaker .....	35
Specifications .....	132
SPORTS (Sports lesson).....	49
SPOT FOCUS .....	51, 109
SPOT METER (Flexible spot meter).....	49, 108
SPOTLIGHT .....	49
SQUEEZE (Squeeze).....	66
STANDARD .....	56
STANDARD SET menu .....	65

STEADYSHOT.....	55, 105
STEREO.....	66
STILL.....	61
Still image	
Image size.....	56
Quality.....	56
Still image format.....	124
STILL SET.....	55
Sub sound.....	66
SUNSET&MOON.....	49
SUPER NS	
(Super NightShot).....	52
SUPER NSPLUS (Super	
NightShot plus).....	52, 109
System requirements.....	87

## T

Tape counter.....	36
Tape playback select button	
.....	37
Tape.....	See Cassette
TELE MACRO.....	52, 109
Telephoto.....	32
Time code.....	36
TIME/LANGU. menu.....	69
Touch panel.....	21
Trademark.....	136
TRAIL.....	61
Transmitter.....	40
Tripod.....	34

TV.....	42
TV color systems.....	122
TV TYPE.....	43

## U

USB CAMERA.....	67
USB jack.....	85
USB SELECT.....	63
Using abroad.....	122

## V

VAR.SPD PB	
(Various speed playback)....	64
VF B.LIGHT	
(Viewfinder brightness).....	66
VF WIDE DISP	
(Viewfinder wide display) ...	66
Video control buttons.....	40
Video head.....	129
VIDEO INPUT.....	67
Video operation buttons.....	37
Viewfinder.....	20
Brightness.....	66
Viewfinder lens adjustment	
lever.....	20
VOLUME.....	31, 65
V-OUT/PANEL.....	68

## W

Wall outlet.....	13
Warning indicators.....	117
Warning messages.....	117
WHITE BAL.	
(White balance).....	50, 109
WHITE FADER.....	59
Wide angle.....	32
WIDE DISPLAY.....	66
WIDE SELECT.....	54
WIDE SELECT button.....	26
Windows.....	87, 89
WIPE.....	60
WORLD TIME.....	69
Write-protect tab.....	123, 124

## Z

ZEBRA.....	53
Zero set memory.....	40
ZERO SET MEMORY button	
.....	40
Zoom.....	32
Zoom lever.....	32

Additional information on this product and answers to frequently asked questions can be found at our Customer Support Website.

<http://www.sony.net/>



Printed on 100% recycled paper using  
VOC (Volatile Organic Compound)-free  
vegetable oil based ink.

Printed in Japan

US



2659813110