

- ▶ Operation Search
- ▶ Before use
- ▶ Getting started
- ▶ Recording
- ▶ Playback
- ▶ Playing images on a TV
- ▶ Saving images with an external device
- ▶ Using the Wi-Fi function
- ▶ Customizing your camcorder
- ▶ Troubleshooting
- ▶ Maintenance and precautions

[→ Contents list](#)

## HDR-PJ780E/ PJ780VE/ PJ790/ PJ790E/ PJ790V/ PJ790VE User Guide

Use this manual if you encounter any problems, or have any questions about the camcorder.



**HANDYCAM.**

[▲ Back to top](#)

▶ **Operation Search**

▶ Before use

▶ Getting started

▶ Recording

▶ Playback

▶ Playing images on a TV

▶ Saving images with an external device

▶ Using the Wi-Fi function

▶ Customizing your camcorder

▶ Troubleshooting

▶ Maintenance and precautions

[→ Contents list](#)

## Operation Search

### Operation Search

[Search by operation](#)

[▲ Back to top](#)

- ▶ Operation Search
- ▶ **Before use**
- ▶ Getting started
- ▶ Recording
- ▶ Playback
- ▶ Playing images on a TV
- ▶ Saving images with an external device
- ▶ Using the Wi-Fi function
- ▶ Customizing your camcorder
- ▶ Troubleshooting
- ▶ Maintenance and precautions

[→ Contents list](#)

## Before use

### How to use this User Guide

[How to use this User Guide](#)

[Model Information](#)

### Parts and controls/Screen indicators

[Parts and controls](#)

[Parts and controls \(Wireless Remote Commander\)](#)

[Screen indicators](#)

### About language setting

[About language setting](#)

[▲ Back to top](#)

- ▶ [Operation Search](#)
- ▶ [Before use](#)
- ▶ [Getting started](#)
- ▶ [Recording](#)
- ▶ [Playback](#)
- ▶ [Playing images on a TV](#)
- ▶ [Saving images with an external device](#)
- ▶ [Using the Wi-Fi function](#)
- ▶ [Customizing your camcorder](#)
- ▶ [Troubleshooting](#)
- ▶ [Maintenance and precautions](#)

[→ Contents list](#)

## Getting started

### Checking the supplied items

[Supplied items](#)

[Attaching the supplied accessories](#)

### Charging the battery pack

[Charging the battery pack using the AC Adaptor](#)

[Charging the battery pack using your computer](#)

### Turning the power on, and setting the date and time

[Turning the power on, and setting the date and time](#)

### Preparing the recording media

[Selecting a recording medium](#)

[Inserting a memory card](#)

[▲ Back to top](#)

- ▶ [Operation Search](#)
- ▶ [Before use](#)
- ▶ [Getting started](#)
- ▶ [Recording](#)
- ▶ [Playback](#)
- ▶ [Playing images on a TV](#)
- ▶ [Saving images with an external device](#)
- ▶ [Using the Wi-Fi function](#)
- ▶ [Customizing your camcorder](#)
- ▶ [Troubleshooting](#)
- ▶ [Maintenance and precautions](#)

[→ Contents list](#)

## Recording

### Recording

- [Recording movies](#)
- [Shooting photos](#)
- [Screen indicators during recording](#)

### Useful functions for recording images

- [Zooming](#)
- [Capturing photos during movie recording \(Dual Capture\)](#)
- [Recording in mirror mode](#)
- [Intelligent Auto](#)
- [Recording the selected subject clearly \(Face Priority\)](#)
- [Recording movies in dim places \(Video Light\)](#)
- [Recording in dark places \(NightShot\)](#)
- [Controlling the image settings manually with the MANUAL dial](#)

### Recording information on your location (GPS)

- [Features available using GPS \(Models with GPS\)](#)
- [Using the GPS function \(Models with GPS\)](#)
- [Obtaining a map of the current location \(triangulation priority mode\) \(Models with GPS\)](#)
- [Checking the triangulating status \(Models with GPS\)](#)
- [Hints for better reception \(Models with GPS\)](#)

[▲ Back to top](#)

- ▶ Operation Search
- ▶ Before use
- ▶ Getting started
- ▶ Recording
- ▶ **Playback**
- ▶ Playing images on a TV
- ▶ Saving images with an external device
- ▶ Using the Wi-Fi function
- ▶ Customizing your camcorder
- ▶ Troubleshooting
- ▶ Maintenance and precautions

[➔ Contents list](#)

## Playback

### Playback

- [Playing movies and photos from the Event View screen](#)
- [Playing movies and photos from a map \(Models with GPS\)](#)
- [Dividing a movie](#)
- [Capturing a photo from a movie](#)

### Highlight playback

- [Enjoying a digest of your movies \(Highlight Playback\)](#)
- [Changing the settings for Highlight Playback](#)
- [Saving Highlight Playback in high definition image quality \(HD\) \(Scenario Save\)](#)
- [Converting Highlight Playback scenes or Highlight Scenarios to standard definition image quality \(STD\) \(Highlight Movie\)](#)

### Using the built-in projector

- [Using the built-in projector](#)
- [Using the projector for your computer or smartphone](#)

[▲ Back to top](#)

- ▶ [Operation Search](#)
- ▶ [Before use](#)
- ▶ [Getting started](#)
- ▶ [Recording](#)
- ▶ [Playback](#)
- ▶ [Playing images on a TV](#)
- ▶ [Saving images with an external device](#)
- ▶ [Using the Wi-Fi function](#)
- ▶ [Customizing your camcorder](#)
- ▶ [Troubleshooting](#)
- ▶ [Maintenance and precautions](#)

[→ Contents list](#)

## Playing images on a TV

### Playing images on a high definition TV

[Connecting the camcorder to a high definition TV](#)

### Playing images on a non-high-definition TV

[Connecting the camcorder to a non-high-definition TV](#)

[Setting the aspect ratio according to the connected TV \(16:9/4:3\)](#)

[When your TV is monaural \(When your TV has only one audio input jack\)](#)

[Connecting the camcorder to a TV via a VCR](#)

### Playing images on a TV supporting 5.1ch surround sound

[Enjoying 5.1ch surround sound](#)

### Playing images on a TV supporting "BRAVIA" Sync

[Using "BRAVIA" Sync](#)

[▲ Back to top](#)

- ▶ [Operation Search](#)
- ▶ [Before use](#)
- ▶ [Getting started](#)
- ▶ [Recording](#)
- ▶ [Playback](#)
- ▶ [Playing images on a TV](#)
- ▶ [Saving images with an external device](#)
- ▶ [Using the Wi-Fi function](#)
- ▶ [Customizing your camcorder](#)
- ▶ [Troubleshooting](#)
- ▶ [Maintenance and precautions](#)

[→ Contents list](#)

## **Saving images with an external device**

### **Using the “PlayMemories Home” software**

- [Playing images on a computer](#)
- [Checking the computer system](#)
- [Installing the “PlayMemories Home” software in your computer](#)
- [Disconnecting your camcorder from the computer](#)
- [The devices on which the created disc can be played back](#)
- [Starting the “PlayMemories Home” software](#)
- [Downloading the dedicated software for the camcorder](#)

### **Saving images on an external media device**

- [Saving images on an external media device easily](#)
- [Saving the desired images in the camcorder to the external media device](#)
- [Playing back images in the external media device on the camcorder](#)
- [Devices that cannot be used as an external media device](#)

### **Creating a disc with a recorder**

- [Creating a standard definition image quality \(STD\) disc with a recorder](#)

[▲ Back to top](#)



- ▶ [Operation Search](#)
- ▶ [Before use](#)
- ▶ [Getting started](#)
- ▶ [Recording](#)
- ▶ [Playback](#)
- ▶ [Playing images on a TV](#)
- ▶ [Saving images with an external device](#)
- ▶ [Using the Wi-Fi function](#)
- ▶ [Customizing your camcorder](#)
- ▶ [Troubleshooting](#)
- ▶ [Maintenance and precautions](#)

[→ Contents list](#)

## Using the Wi-Fi function

### Using the Wi-Fi function

- [Using the Wi-Fi function](#)
- [Attaching the wireless adaptor](#)

### What you can do with the Wi-Fi function

- [What you can do with the Wi-Fi function](#)

### Available menus with the wireless adaptor attached

- [Ctrl with Smartphone](#)
- [Send to Smartphone](#)
- [Send to Computer](#)
- [WPS Push](#)
- [Access point settings](#)
- [Edit Device Name](#)
- [Disp MAC Address](#)
- [SSID/PW Reset](#)
- [Network Info Reset](#)
- [Airplane Mode](#)

### Troubleshooting

- [Troubleshooting](#)

[▲ Back to top](#)

- ▶ [Operation Search](#)
- ▶ [Before use](#)
- ▶ [Getting started](#)
- ▶ [Recording](#)
- ▶ [Playback](#)
- ▶ [Playing images on a TV](#)
- ▶ [Saving images with an external device](#)
- ▶ [Using the Wi-Fi function](#)
- ▶ [Customizing your camcorder](#)
- ▶ [Troubleshooting](#)
- ▶ [Maintenance and precautions](#)

[→ Contents list](#)

## Customizing your camcorder

### Using menu items

[Setting up menu items](#)

### Shooting Mode

[Movie](#)

[Photo](#)

[Smth Slw REC \(Smooth slow rec\)](#)

[Golf Shot](#)

### Camera/Mic

[White Balance](#)

[Spot Meter/Fcs \(Spot meter/focus\)](#)

[Spot Meter \(Flexible spot meter\)](#)

[Spot Focus](#)

[Exposure](#)

[Focus](#)

[IRIS](#)

[Shutter Speed](#)

[AGC Limit](#)

[AE Shift](#)

[White Balance Shift](#)

[Low Lux](#)

[Scene Selection](#)

[Cinematone](#)

[Fader](#)

[Self-Timer](#)

[Tele Macro](#)

[SteadyShot \(movie\)](#)

[SteadyShot \(photo\)](#)

[Digital Zoom](#)

[Conversion Lens](#)

[Auto Back Light](#)

[Dial Setting](#)

[NIGHTSHOT Light](#)

[Face Detection](#)

[Smile Shutter](#)

[Smile Sensitivity](#)

[Flash](#)

[Flash Level](#)

[Red Eye Reduction](#)

[Closer Voice](#)

[Blt-in Zoom Mic](#)

- Auto Wind NR
- Audio Mode
- Audio Rec Level
- My Button
- Expanded Focus
- Grid Line
- Display Setting
- Zebra
- Peaking
- Light Bright
- Audio Level Display

#### **Image Quality/Size**

- REC Mode
- Frame Rate
- HD/MP4/STD Setting
- Wide Mode
- x.v.Color
- Image Size

#### **Playback Function**

- Event View
- Map View (HDR-PJ780VE/ PJ790V/ PJ790VE)
- Highlight Movie
- Scenario

#### **Edit/Copy**

- Delete
- Protect
- Copy
- Direct Copy

#### **Setup**

- Media Select
- Media Info
- Format
- Repair Img. DB F.
- File Number
- Data Code
- Volume
- Download Music (HDR-PJ790/ PJ790V)
- Empty Music (HDR-PJ790/ PJ790V)
- TV Type
- HDMI Resolution
- CTRL FOR HDMI (Control for HDMI)
- USB Connect
- USB Connect Setting
- USB LUN Setting
- Beep
- LCD Brightness
- Your Location (HDR-PJ780VE/ PJ790V/ PJ790VE)
- Airplane Mode (HDR-PJ780VE/ PJ790V/ PJ790VE)

GPS Setting (HDR-PJ780VE/ PJ790V/ PJ790VE)  
REC Lamp  
Remote Ctrl  
Language Setting  
24p Mode (HDR-PJ780E/ PJ780VE/ PJ790E/ PJ790VE)  
Calibration  
Battery Info  
Power Save  
Initialize  
Demo Mode  
Date & Time Setting  
Area Setting  
Auto Clock ADJ (HDR-PJ780VE/ PJ790V/ PJ790VE)  
Auto Area ADJ (HDR-PJ780VE/ PJ790V/ PJ790VE)

 [Back to top](#)

---

Copyright 2013 Sony Corporation

- ▶ [Operation Search](#)
- ▶ [Before use](#)
- ▶ [Getting started](#)
- ▶ [Recording](#)
- ▶ [Playback](#)
- ▶ [Playing images on a TV](#)
- ▶ [Saving images with an external device](#)
- ▶ [Using the Wi-Fi function](#)
- ▶ [Customizing your camcorder](#)
- ▶ [Troubleshooting](#)
- ▶ [Maintenance and precautions](#)

[➔ Contents list](#)

## Troubleshooting

### If you have problems

[If you have problems](#)

### Troubleshooting

[Overall operations/Wireless Remote Commander](#)

[Batteries/power sources](#)

[LCD screen/viewfinder](#)

[Memory card](#)

[Recording](#)

[Playback](#)

[Editing movies/photos on your camcorder](#)

[Playback on the TV](#)

[Copying/Connecting to other devices](#)

[Connecting to a computer](#)

### Self-diagnosis display/Warning indicators

[Self-diagnosis display](#)

[Warning Indicators](#)

[▲ Back to top](#)

- ▶ [Operation Search](#)
- ▶ [Before use](#)
- ▶ [Getting started](#)
- ▶ [Recording](#)
- ▶ [Playback](#)
- ▶ [Playing images on a TV](#)
- ▶ [Saving images with an external device](#)
- ▶ [Using the Wi-Fi function](#)
- ▶ [Customizing your camcorder](#)
- ▶ [Troubleshooting](#)
- ▶ [Maintenance and precautions](#)

[→ Contents list](#)

## Maintenance and precautions

### Maintenance and precautions

- [About the AVCHD format](#)
- [About GPS \(Models with GPS\)](#)
- [About the memory card](#)
- [About the "InfoLITHIUM" battery pack](#)

### About handling of your camcorder

- [On use and care](#)
- [On moisture condensation](#)
- [On charging the pre-installed rechargeable battery](#)
- [Notes on disposal/transfer the ownership of the camcorder](#)

### Recording time of movies/number of recordable photos

- [Charging time](#)
- [Expected time of recording and playback with each battery pack](#)
- [Expected recording time of movies](#)
- [Expected number of recordable photos](#)

### Using your camcorder abroad

- [Using your camcorder abroad](#)

### On trademarks

- [On trademarks](#)

### License

- [Notes on the License](#)

[▲ Back to top](#)

- ▶ [Operation Search](#)
- ▶ [Before use](#)
- ▶ [Getting started](#)
- ▶ [Recording](#)
- ▶ [Playback](#)
- ▶ [Playing images on a TV](#)
- ▶ [Saving images with an external device](#)
- ▶ [Using the Wi-Fi function](#)
- ▶ [Customizing your camcorder](#)
- ▶ [Troubleshooting](#)
- ▶ [Maintenance and precautions](#)

[→ Contents list](#)

## Contents list

---

### Operation Search

#### Operation Search

[Search by operation](#)

[▲ Back to top](#)

### Before use

#### How to use this User Guide

[How to use this User Guide](#)

[Model Information](#)

#### Parts and controls/Screen indicators

[Parts and controls](#)

[Parts and controls \(Wireless Remote Commander\)](#)

[Screen indicators](#)

#### About language setting

[About language setting](#)

[▲ Back to top](#)

### Getting started

#### Checking the supplied items

[Supplied items](#)

[Attaching the supplied accessories](#)

#### Charging the battery pack

[Charging the battery pack using the AC Adaptor](#)

[Charging the battery pack using your computer](#)

#### Turning the power on, and setting the date and time

[Turning the power on, and setting the date and time](#)

#### Preparing the recording media

[Selecting a recording medium](#)

[Inserting a memory card](#)

[▲ Back to top](#)

### Recording

#### Recording

[Recording movies](#)

[Shooting photos](#)

[Screen indicators during recording](#)

## Useful functions for recording images

- Zooming
- Capturing photos during movie recording (Dual Capture)
- Recording in mirror mode
- Intelligent Auto
- Recording the selected subject clearly (Face Priority)
- Recording movies in dim places (Video Light)
- Recording in dark places (NightShot)
- Controlling the image settings manually with the MANUAL dial

## Recording information on your location (GPS)

- Features available using GPS (Models with GPS)
- Using the GPS function (Models with GPS)
- Obtaining a map of the current location (triangulation priority mode) (Models with GPS)
- Checking the triangulating status (Models with GPS)
- Hints for better reception (Models with GPS)

[▲ Back to top](#)

## Playback

### Playback

- Playing movies and photos from the Event View screen
- Playing movies and photos from a map (Models with GPS)
- Dividing a movie
- Capturing a photo from a movie

### Highlight playback

- Enjoying a digest of your movies (Highlight Playback)
- Changing the settings for Highlight Playback
- Saving Highlight Playback in high definition image quality (HD) (Scenario Save)
- Converting Highlight Playback scenes or Highlight Scenarios to standard definition image quality (STD) (Highlight Movie)

### Using the built-in projector

- Using the built-in projector
- Using the projector for your computer or smartphone

[▲ Back to top](#)

## Playing images on a TV

### Playing images on a high definition TV

- Connecting the camcorder to a high definition TV

### Playing images on a non-high-definition TV

- Connecting the camcorder to a non-high-definition TV
- Setting the aspect ratio according to the connected TV (16:9/4:3)
- When your TV is monaural (When your TV has only one audio input jack)
- Connecting the camcorder to a TV via a VCR

### Playing images on a TV supporting 5.1ch surround sound

- Enjoying 5.1ch surround sound

### Playing images on a TV supporting “BRAVIA” Sync

- Using “BRAVIA” Sync



## **Saving images with an external device**

### **Using the “PlayMemories Home” software**

- [Playing images on a computer](#)
- [Checking the computer system](#)
- [Installing the “PlayMemories Home” software in your computer](#)
- [Disconnecting your camcorder from the computer](#)
- [The devices on which the created disc can be played back](#)
- [Starting the “PlayMemories Home” software](#)
- [Downloading the dedicated software for the camcorder](#)

### **Saving images on an external media device**

- [Saving images on an external media device easily](#)
- [Saving the desired images in the camcorder to the external media device](#)
- [Playing back images in the external media device on the camcorder](#)
- [Devices that cannot be used as an external media device](#)

### **Creating a disc with a recorder**

- [Creating a standard definition image quality \(STD\) disc with a recorder](#)

## **Using the Wi-Fi function**

### **Using the Wi-Fi function**

- [Using the Wi-Fi function](#)
- [Attaching the wireless adaptor](#)

### **What you can do with the Wi-Fi function**

- [What you can do with the Wi-Fi function](#)

### **Available menus with the wireless adaptor attached**

- [Ctrl with Smartphone](#)
- [Send to Smartphone](#)
- [Send to Computer](#)
- [WPS Push](#)
- [Access point settings](#)
- [Edit Device Name](#)
- [Disp MAC Address](#)
- [SSID/PW Reset](#)
- [Network Info Reset](#)
- [Airplane Mode](#)

### **Troubleshooting**

- [Troubleshooting](#)

## **Customizing your camcorder**

### **Using menu items**

- [Setting up menu items](#)

### **Shooting Mode**

Movie  
Photo  
Smth Slw REC (Smooth slow rec)  
Golf Shot

**Camera/Mic**

White Balance  
Spot Meter/Fcs (Spot meter/focus)  
Spot Meter (Flexible spot meter)  
Spot Focus  
Exposure  
Focus  
IRIS  
Shutter Speed  
AGC Limit  
AE Shift  
White Balance Shift  
Low Lux  
Scene Selection  
Cinematone  
Fader  
Self-Timer  
Tele Macro  
SteadyShot (movie)  
SteadyShot (photo)  
Digital Zoom  
Conversion Lens  
Auto Back Light  
Dial Setting  
NIGHTSHOT Light  
Face Detection  
Smile Shutter  
Smile Sensitivity  
Flash  
Flash Level  
Red Eye Reduction  
Closer Voice  
Blt-in Zoom Mic  
Auto Wind NR  
Audio Mode  
Audio Rec Level  
My Button  
Expanded Focus  
Grid Line  
Display Setting  
Zebra  
Peaking  
Light Bright  
Audio Level Display

**Image Quality/Size**

REC Mode  
Frame Rate  
HD/MP4/STD Setting  
Wide Mode  
x.v.Color  
Image Size

**Playback Function**

Event View  
Map View (HDR-PJ780VE/ PJ790V/ PJ790VE)  
Highlight Movie  
Scenario

**Edit/Copy**

Delete  
Protect  
Copy  
Direct Copy

**Setup**

Media Select  
Media Info  
Format  
Repair Img. DB F.  
File Number  
Data Code  
Volume  
Download Music (HDR-PJ790/ PJ790V)  
Empty Music (HDR-PJ790/ PJ790V)  
TV Type  
HDMI Resolution  
CTRL FOR HDMI (Control for HDMI)  
USB Connect  
USB Connect Setting  
USB LUN Setting  
Beep  
LCD Brightness  
Your Location (HDR-PJ780VE/ PJ790V/ PJ790VE)  
Airplane Mode (HDR-PJ780VE/ PJ790V/ PJ790VE)  
GPS Setting (HDR-PJ780VE/ PJ790V/ PJ790VE)  
REC Lamp  
Remote Ctrl  
Language Setting  
24p Mode (HDR-PJ780E/ PJ780VE/ PJ790E/ PJ790VE)  
Calibration  
Battery Info  
Power Save  
Initialize  
Demo Mode  
Date & Time Setting  
Area Setting

## **Troubleshooting**

### **If you have problems**

[If you have problems](#)

### **Troubleshooting**

[Overall operations/Wireless Remote Commander](#)

[Batteries/power sources](#)

[LCD screen/viewfinder](#)

[Memory card](#)

[Recording](#)

[Playback](#)

[Editing movies/photos on your camcorder](#)

[Playback on the TV](#)

[Copying/Connecting to other devices](#)

[Connecting to a computer](#)

### **Self-diagnosis display/Warning indicators**

[Self-diagnosis display](#)

[Warning Indicators](#)

## **Maintenance and precautions**

### **Maintenance and precautions**

[About the AVCHD format](#)

[About GPS \(Models with GPS\)](#)

[About the memory card](#)

[About the "InfoLITHIUM" battery pack](#)

### **About handling of your camcorder**

[On use and care](#)

[On moisture condensation](#)

[On charging the pre-installed rechargeable battery](#)

[Notes on disposal/transfer the ownership of the camcorder](#)

### **Recording time of movies/number of recordable photos**

[Charging time](#)

[Expected time of recording and playback with each battery pack](#)

[Expected recording time of movies](#)

[Expected number of recordable photos](#)

### **Using your camcorder abroad**

[Using your camcorder abroad](#)

### **On trademarks**

[On trademarks](#)

### **License**

[Notes on the License](#)



▶ [Operation Search](#)

▶ [Before use](#)

▶ [Getting started](#)

▶ [Recording](#)

▶ [Playback](#)

▶ [Playing images on a TV](#)

▶ [Saving images with an external device](#)

▶ [Using the Wi-Fi function](#)

▶ [Customizing your camcorder](#)

▶ [Troubleshooting](#)

▶ [Maintenance and precautions](#)

[→ Contents list](#)

## Search by operation

---

### Setting the date and time

[Date & Time Setting](#)

[Area Setting](#)

[Auto Clock ADJ \(HDR-PJ780VE/ PJ790V/ PJ790VE\)](#)

### Identifying part names

[Parts and controls](#)

### Displaying the data code

[Data Code](#)

### Checking your golf swing

[Golf Shot](#)

[Smth Slw REC \(Smooth slow rec\)](#)

### Selecting the suitable setting automatically for the recording situation

[Intelligent Auto](#)

### Recording people clearly

[Face Detection](#)

[Recording the selected subject clearly \(Face Priority\)](#)

[Smile Shutter](#)

[Scene Selection \(Portrait\)](#)

[Scene Selection \(Spotlight\)](#)

[Scene Selection \(Night Portrait\)](#)

[Closer Voice](#)

### Recording images with the selected image quality

[REC Mode](#)

[Frame Rate](#)

[HD/MP4/STD Setting](#)

[Wide Mode](#)

[Image Size](#)

### Recording images without blurring

[SteadyShot \(movie\)](#)

[SteadyShot \(photo\)](#)

### Adjusting the focus

[Spot Focus](#)

[Tracking focus: Recording the selected subject clearly \(Face Priority\)](#)

[Focus](#)

### Using the GPS function

[GPS Setting \(HDR-PJ780VE/ PJ790V/ PJ790VE\)](#)

[Your Location \(HDR-PJ780VE/ PJ790V/ PJ790VE\)](#)

### Recording movies in a dim place

[Recording in dark places \(NightShot\)](#)

- Low Lux
- Scene Selection (Night Portrait)
- Scene Selection (Night Scene)
- Recording movies in dim places (Video Light)
- Flash

### **Recording sound clearly**

- Closer Voice
- Auto Wind NR
- Audio Mode
- Bit-in Zoom Mic
- Audio Rec Level

### **Capturing photos during movie recording**

- Recording high quality photos during movie recording (Dual capture): [Recording movies Smile Shutter](#)

### **Recording sunset or fireworks beautifully**

- Scene Selection (Fireworks)
- Scene Selection (Sunrise&Sunset)

### **Selecting a recording medium**

- Media Select

### **Saving battery power**

- Power Save

### **Recording images manually to achieve the effect you want**

- Controlling the image settings manually with the MANUAL dial
- Dial Setting

### **Playing movies and photos from an event**

- Event View

### **Playing movies and photos from a map**

- Map View (HDR-PJ780VE/ PJ790V/ PJ790VE)

### **Enjoying a digest of your movies**

- Enjoying a digest of your movies (Highlight Playback)

### **Using the built-in projector**

- Using the built-in projector

### **Playing images on a TV**

- Connecting the camcorder to a high definition TV
- Connecting the camcorder to a non-high-definition TV

### **Editing movies and photos**

- Capturing a photo from a movie
- Dividing a movie
- Delete

### **Saving images with an external device**

- Saving images on an external media device easily

### **Creating a disc**

- Creating a standard definition image quality (STD) disc with a recorder

- ▶ Operation Search
- ▶ **Before use**
- ▶ Getting started
- ▶ Recording
- ▶ Playback
- ▶ Playing images on a TV
- ▶ Saving images with an external device
- ▶ Using the Wi-Fi function
- ▶ Customizing your camcorder
- ▶ Troubleshooting
- ▶ Maintenance and precautions

[→ Contents list](#)

## How to use this User Guide

- ▼ [Selecting a topic to display](#)
- ▼ [Searching a topic by keyword](#)
- ▼ [Returning to a previous page](#)
- ▼ [Printing out a page](#)
- ▼ [Marks and notations used in this User Guide](#)

This User Guide explains how to use each function of the camcorder, how to change settings, and how to troubleshoot a problem.

### Selecting a topic to display

The following illustrations take Internet Explorer 7 as an example.

1. Click a title in the side bar on the left of the browser window.  
A list of topic titles appears in the right pane.
2. Click a topic title in the list.

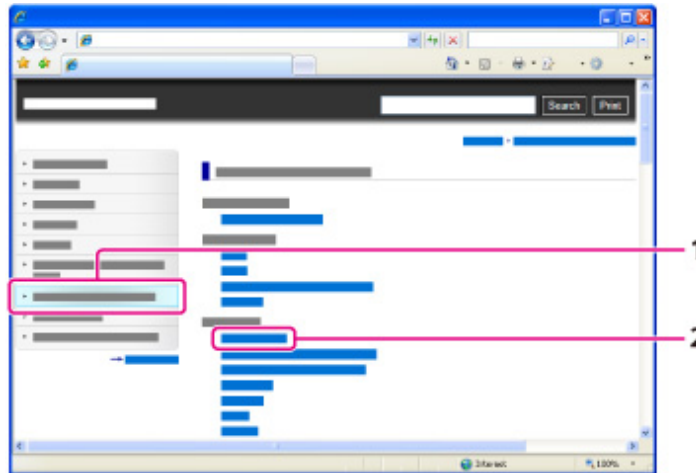

Descriptions appear in the right pane.



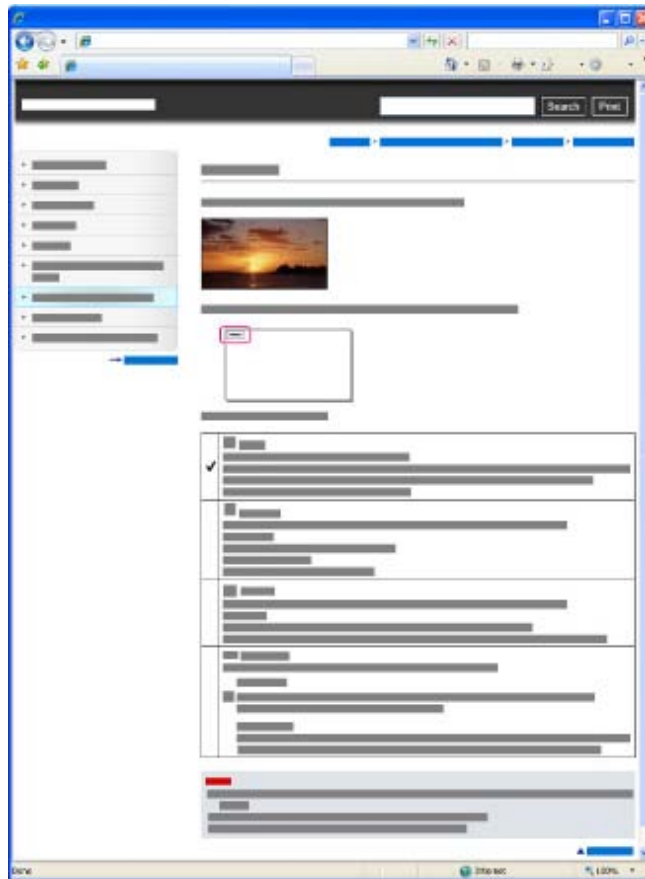

### Changing the font size

Change the font size by changing the setting of your web browser. For how to change the font size setting, refer to the Help of your web browser.

### Searching a topic by keyword

Enter the keyword in the search window, then click the [Search] button.

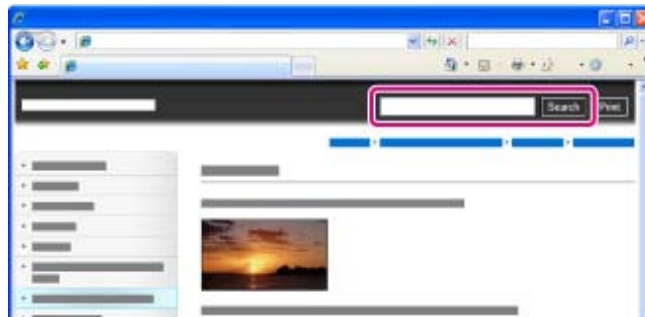

### Returning to a previous page

Use the back button of your web browser or the breadcrumb trail navigation **(A)** to return to a page you previously viewed.

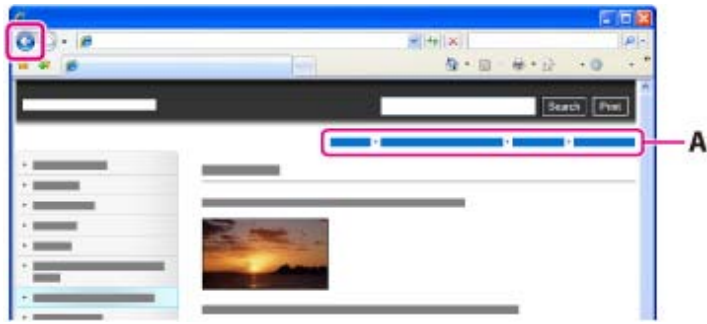

## Printing out a page

Click the [Print] button to print out a page you are viewing.

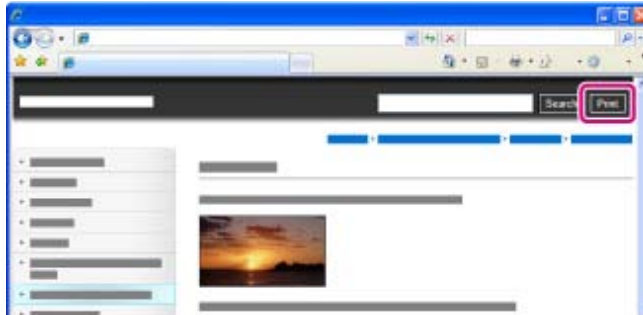

## Marks and notations used in this User Guide

In this User Guide, the sequence of operations is shown by arrows (→) (A). Operate the camcorder in the order indicated.

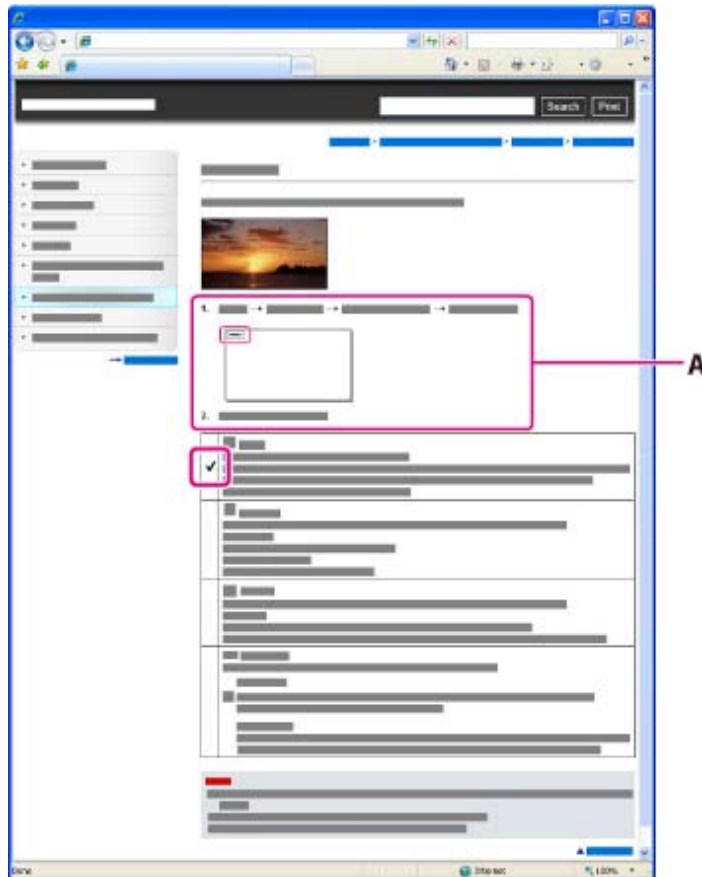

- Icons in the operating procedure sentences appear when the camcorder is in its default settings.
- The default setting is indicated by ✓.

---

[▲ Back to top](#)

Copyright 2013 Sony Corporation

- ▶ Operation Search
- ▶ Before use
- ▶ Getting started
- ▶ Recording
- ▶ Playback
- ▶ Playing images on a TV
- ▶ Saving images with an external device
- ▶ Using the Wi-Fi function
- ▶ Customizing your camcorder
- ▶ Troubleshooting
- ▶ Maintenance and precautions

[→ Contents list](#)

## Model Information

In this User Guide, the differences in the specifications for each model are described together. If you find the description "Models with ..." like below, confirm in this chapter whether the description applies to your camcorder.

- (Models with GPS)
- (Models with the NTSC color system)

### To confirm the model name of your camcorder

See the bottom of your camcorder.

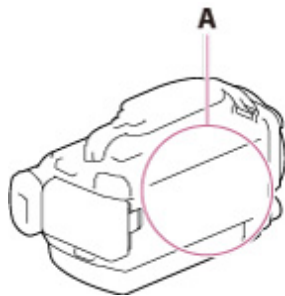

A: Model name (HDR-xxx)

### Differences in functions

Model name	Signal format	USB connection	GPS
HDR-PJ780E	PAL	Output only	—
HDR-PJ780VE/ PJ790VE	PAL	Output only	✓
HDR-PJ790	NTSC	Input/Output	—
HDR-PJ790E	PAL	Output only	—
HDR-PJ790V	NTSC	Input/Output	✓

#### Notes

- For the following items, the descriptions are explained with the model name.
  - Parts and controls [\[Details\]](#)
  - Menu items
  - Expected recording time of movies [\[Details\]](#)
  - Expected number of recordable photos [\[Details\]](#)

[▲ Back to top](#)

- ▶ Operation Search
- ▶ Before use
- ▶ Getting started
- ▶ Recording
- ▶ Playback
- ▶ Playing images on a TV
- ▶ Saving images with an external device
- ▶ Using the Wi-Fi function
- ▶ Customizing your camcorder
- ▶ Troubleshooting
- ▶ Maintenance and precautions

[→ Contents list](#)

## Parts and controls

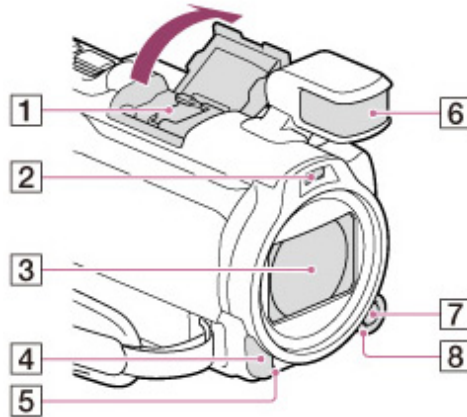

**1 Multi interface shoe**



For details on compatible accessories of the Multi interface shoe, visit the Sony web site in your area, or consult your Sony dealer or local authorized Sony service facility.

Operations with other manufacture's accessories are not guaranteed.

**2 Flash/Video light**

**3 Lens (Carl Zeiss lens)**

**4 Remote sensor/Infrared port**

**5 Camera recording lamp**

The camera recording lamp lights up in red during recording. The lamp flashes when the remaining recording media capacity or battery power is low.

**6 Built-in microphone**

**7 MANUAL button**

**8 MANUAL dial**

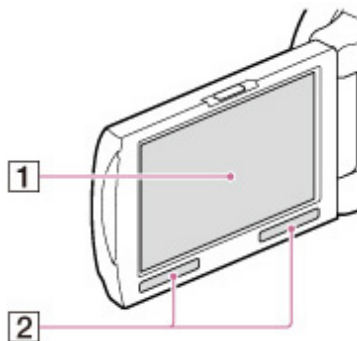

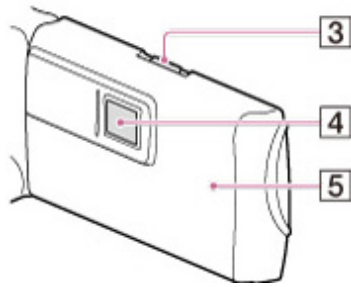

**1 LCD screen/Touch panel**

If you rotate the LCD panel 180 degrees, you can close the LCD panel with the LCD screen facing out. This is convenient during playback operations.

**2 Speakers**

**3 PROJECTOR FOCUS lever**

**4 Projector lens**

**5 GPS antenna (HDR-PJ780VE/ PJ790V/ PJ790VE)**

A GPS antenna is located in the LCD panel.

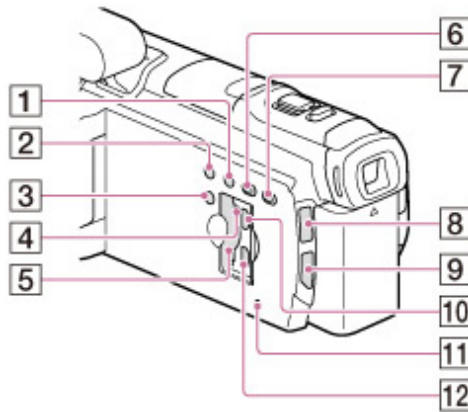

**1 LIGHT (Video Light) button**

**2 NIGHTSHOT button**

**3 POWER button**



**4 Memory card access lamp**

While the lamp is lit or flashing, the camcorder is reading or writing data.

**5 Memory card slot**

**6  (View Images) button**

**7 PROJECTOR button**

**8  (Movie)/  (Photo) lamp**

**9 MODE button**

**10 PROJECTOR IN jack**



**11 RESET button**

Press RESET using a pointed object.

Press RESET to initialize all the settings including the clock setting.

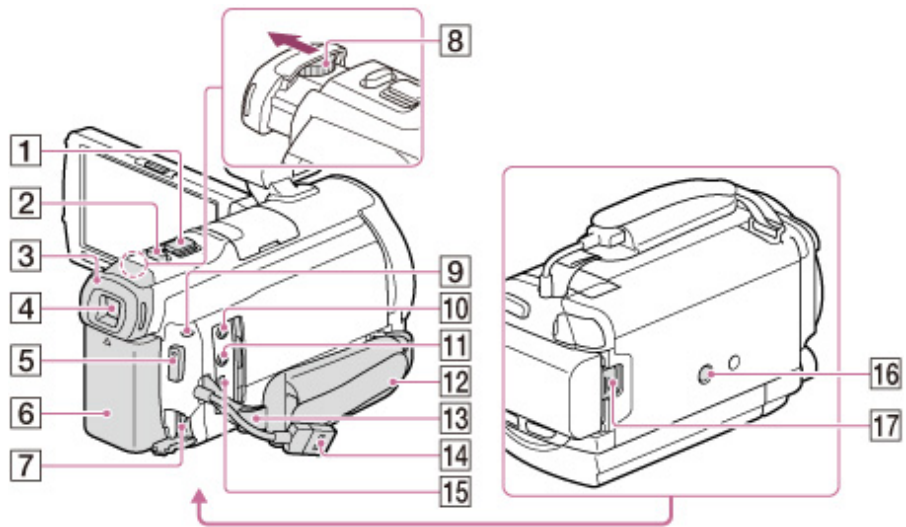
**12 HDMI OUT jack**



- 1** Power zoom lever
- 2** PHOTO button
- 3** Eyecup
- 4** Viewfinder
- 5** START/STOP button
- 6** Battery pack
- 7** DC IN jack
- 8** Viewfinder lens adjustment lever
- 9** CHG (charge) lamp
- 10**  (microphone) jack (PLUG IN POWER)
- 11**  (headphones) jack
- 12** Grip belt
- 13** Loop for a shoulder belt
- 14** Built-in USB Cable
- 15** Multi/Micro USB Terminal  
Supports Micro USB compatible devices.
- 16** Tripod receptacle  
Attach a tripod (sold separately: the length of the screw must be less than 5.5 mm (7/32 in.)).  
Depending on the specifications of the tripod, your camcorder may not attach in the proper direction.
- 17** BATT (battery) release lever

## **To fasten the grip belt**

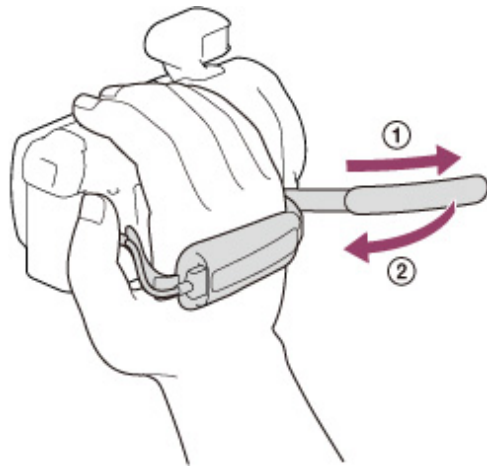

[▲ Back to top](#)

Copyright 2013 Sony Corporation



- ▶ Operation Search
- ▶ Before use
- ▶ Getting started
- ▶ Recording
- ▶ Playback
- ▶ Playing images on a TV
- ▶ Saving images with an external device
- ▶ Using the Wi-Fi function
- ▶ Customizing your camcorder
- ▶ Troubleshooting
- ▶ Maintenance and precautions

[→ Contents list](#)

## Parts and controls (Wireless Remote Commander)

Using the wireless remote commander is helpful when projecting recorded images from your camcorder.

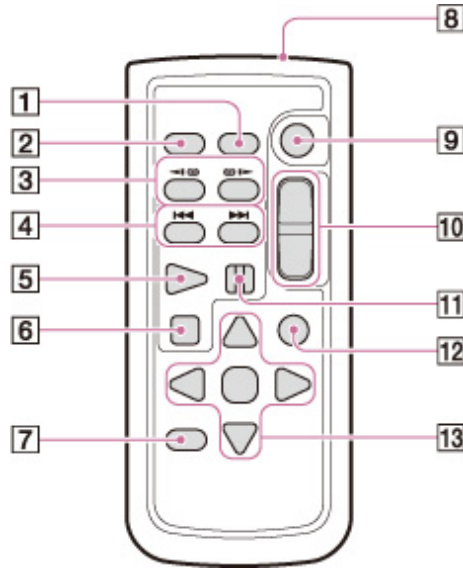

- 1 DATA CODE button**  
Displays the date and time, camera setting data, or coordinates (HDR-PJ780VE/ PJ790V/ PJ790VE) of the recorded images when you press this button during playback.
- 2 PHOTO button**  
Records as a still image the image that is displayed on the screen when this button is pressed.
- 3 SCAN/SLOW buttons**
- 4 ◀◀ / ▶▶ (Previous/Next) buttons**
- 5 PLAY button**
- 6 STOP button**
- 7 DISPLAY button**
- 8 Transmitter**
- 9 START/STOP button**
- 10 Power zoom buttons**
- 11 PAUSE button**
- 12 VISUAL INDEX button**  
Displays an Index screen during playback.
- 13 ◀ / ▶ / ▲ / ▼ /ENTER buttons**  
Displays a light blue frame on the LCD screen when you press any of these buttons. Select a desired button or an item with ◀ / ▶ / ▲ / ▼ , then press ENTER to enter.



- ▶ Operation Search
- ▶ Before use
- ▶ Getting started
- ▶ Recording
- ▶ Playback
- ▶ Playing images on a TV
- ▶ Saving images with an external device
- ▶ Using the Wi-Fi function
- ▶ Customizing your camcorder
- ▶ Troubleshooting
- ▶ Maintenance and precautions

[→ Contents list](#)

## Screen indicators



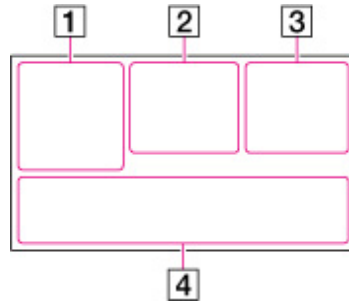

The following indicators appear when you change the settings. Check also for the indicators that appear during recording or playing.



### 1

Indicator	Meaning
	MENU button
	Self-timer recording
	GPS triangulation status
	[Airplane Mode] set to [On]
	Video light
	Wide Mode
	Fader
	[Face Detection] set to [Off]
	[Smile Shutter] set to [Off]
	Manual focus
	Scene Selection
	White Balance
	SteadyShot off
	White Balance Shift
	Tele Macro
	x.v.Color
	Conversion Lens
	Zebra

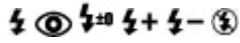

	Low Lux
<b>AGC</b>	AGC Limit
	Spot Meter/Fcs/Spot Meter/Exposure
EV	AE Shift
<b>10000</b>	Shutter Speed
<b>F1.8</b>	IRIS
	Intelligent Auto
 101-0005	Data file name
	Protect
	Flash/Flash Level/Red Eye Reduction

- Indicators and their positions are approximate and may differ from what you actually see.
- Some indicators may not appear, depending on your camcorder model.

[▲ Back to top](#)

[Top page](#) > [Before use](#) > [About language setting](#) > [About language setting](#)

▶ Operation Search

▶ Before use

▶ Getting started

▶ Recording

▶ Playback

▶ Playing images on a TV

▶ Saving images with an external device

▶ Using the Wi-Fi function

▶ Customizing your camcorder

▶ Troubleshooting

▶ Maintenance and precautions

[→ Contents list](#)

## About language setting

---

Change the screen language before using the camcorder if necessary. The on-screen displays in each local language are used for illustrating the operating procedures. [\[Details\]](#)

Select **MENU** → [Setup] → [ General Settings] → [Language Setting] → a desired language.

[▲ Back to top](#)

- ▶ Operation Search
- ▶ Before use
- ▶ Getting started
- ▶ Recording
- ▶ Playback
- ▶ Playing images on a TV
- ▶ Saving images with an external device
- ▶ Using the Wi-Fi function
- ▶ Customizing your camcorder
- ▶ Troubleshooting
- ▶ Maintenance and precautions

[→ Contents list](#)

## Supplied items

The numbers in ( ) indicate the supplied quantity.

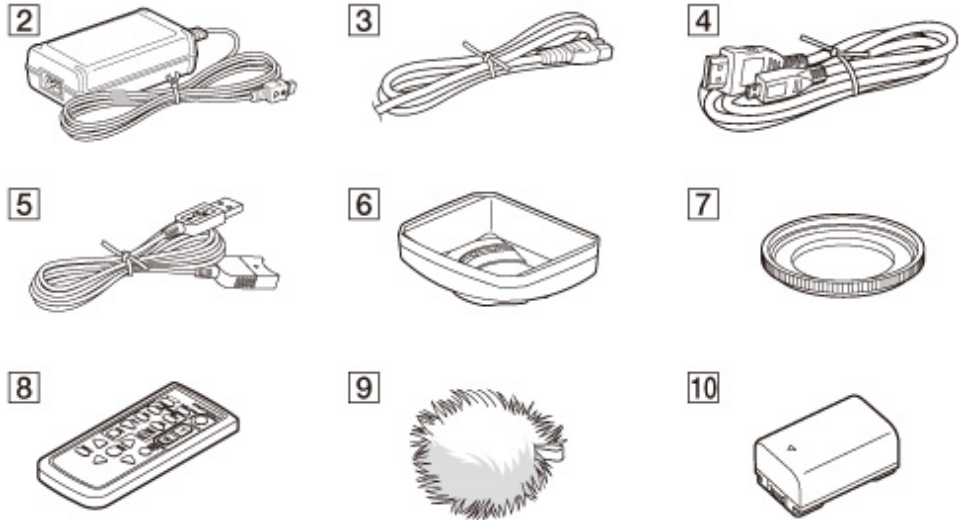

- 1** Camcorder (1)
- 2** AC Adaptor (1)
- 3** Power cord (mains lead) (1)
- 4** HDMI cable (1)
- 5** USB connection support cable (1)

- The USB connection support cable is designed for use with this camcorder only. Use this cable when the Built-in USB Cable of the camcorder is too short for connection.

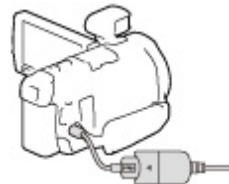

- 6** Lens hood (1)
- 7** Step Down Ring (1)
- 8** Wireless Remote Commander (1)
- 9** Wind screen (1)
- 10** Rechargeable battery pack NP-FV50 (1)
- 11** "Operating Guide" (1)

### Notes

-

- The “PlayMemories Home” software and “PlayMemories Home Help Guide” can be downloaded from the Sony website. [\[Details\]](#)

[▲ Back to top](#)

---

Copyright 2013 Sony Corporation



- ▶ Operation Search
- ▶ Before use
- ▶ Getting started
- ▶ Recording
- ▶ Playback
- ▶ Playing images on a TV
- ▶ Saving images with an external device
- ▶ Using the Wi-Fi function
- ▶ Customizing your camcorder
- ▶ Troubleshooting
- ▶ Maintenance and precautions

[→ Contents list](#)

## Attaching the supplied accessories

### To attach the lens hood

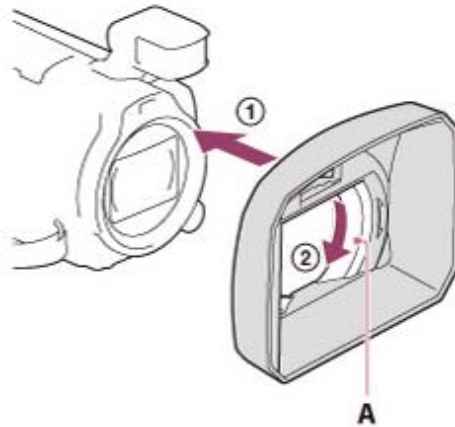

**A:** Securing ring

Align the lens hood with the camcorder properly (①), then turn the securing ring of the lens hood in the direction of the arrow (②).

- When attaching the lens hood, align the opening section of the lens hood with the flash-emitting section of the camcorder properly.
- To remove the lens hood, turn the securing ring of the lens hood in the opposite direction from that of the arrow.
- Remove the lens hood when you record movies using the NightShot function. If you do not do so, the shadow of the lens hood will be reflected and recorded in your movies.
- Remove the lens hood when you operate the camcorder with the supplied remote commander.

### To attach the Step Down Ring

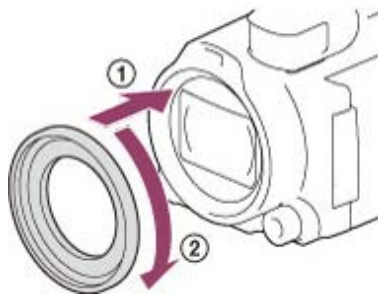

Align the Step Down Ring with the camcorder properly (①), then turn it in the direction of the arrow until the Step Down Ring is locked in place (②).

- You can change the filter diameter to 37 mm (1 1/2 in.) by attaching the Step Down Ring, allowing you to use the recommended conversion lens.
- You cannot attach the wide end conversion lens/filter, if the Step Down Ring is attached.

- To remove Step Down Ring, turn it in the opposite direction from that of the arrow.

### **To attach the wind screen**

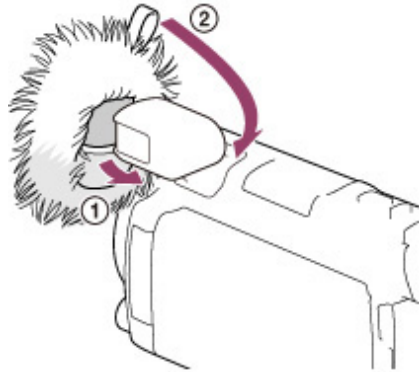

The wind screen can reduce wind noise in windy conditions.

Insert the front side of the built-in microphone into the hole at the bottom of the wind screen (①), then pull the tag on the windscreen backwards until the wind screen covers the built-in microphone (②).

- When the lens hood is attached, it may be difficult to attach the wind screen.
- Pull the tag upward to remove the wind screen.

[▲ Back to top](#)

Copyright 2013 Sony Corporation

- ▶ Operation Search
- ▶ Before use
- ▶ Getting started
- ▶ Recording
- ▶ Playback
- ▶ Playing images on a TV
- ▶ Saving images with an external device
- ▶ Using the Wi-Fi function
- ▶ Customizing your camcorder
- ▶ Troubleshooting
- ▶ Maintenance and precautions

[→ Contents list](#)

## Charging the battery pack using the AC Adaptor

1. Turn off your camcorder by closing the LCD screen, and attach the battery pack (①). (Be sure to store the viewfinder first.)
  - Align the indentation on the camcorder and projection on the battery pack, then slide the battery pack upwards.

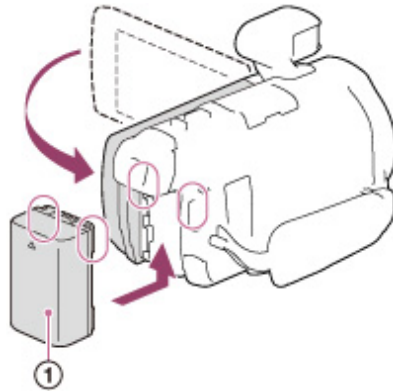

2. Connect the AC Adaptor (①) and the power cord (mains lead) (②) to your camcorder and the wall outlet (wall socket) (③).

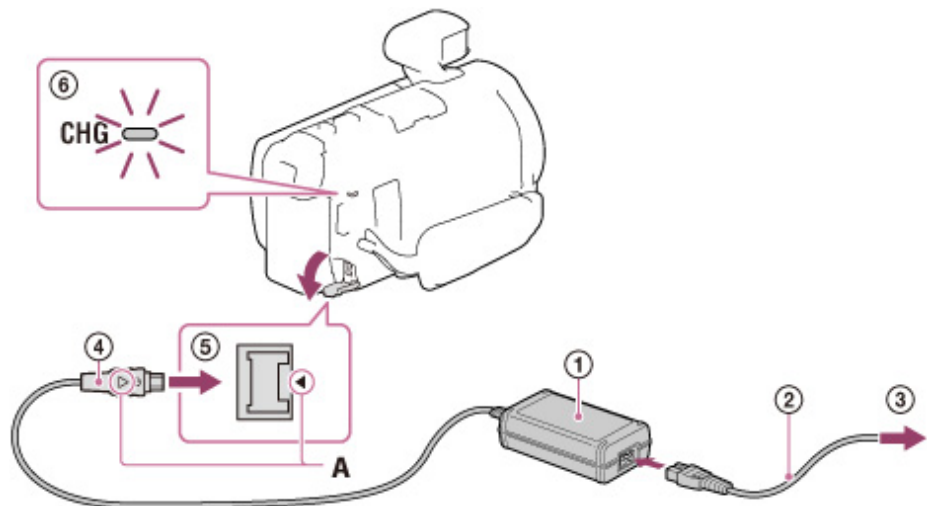

**A:** Align the ▲ mark on the DC plug (④) with that of DC IN jack (⑤).

- The CHG (charge) (⑥) lamp turns on.
- The CHG (charge) lamp turns off when the battery pack is fully charged. Disconnect the AC Adaptor from the DC IN jack of your camcorder.

### Notes

- You cannot attach any "InfoLITHIUM" battery pack other than the V series to your camcorder.
- When attaching a video light (sold separately), it is recommended that you use an NP-FV70 or NP-FV100 battery pack.

- You cannot use the NP-FV30 “InfoLITHIUM” battery pack with the camcorder.
- In the default setting, the power turns off automatically if you leave your camcorder without any operation for about 2 minutes, to save battery power ([Power Save]).

## Charging time

Approximate time (min.) required to fully charge a fully discharged battery pack.

Battery pack	AC Adaptor
NP-FV50 (supplied)	155
NP-FV70	195
NP-FV100	390

- The charging times shown in the table above are measured when charging the camcorder at a room temperature of 25 °C (77 °F). It is recommended that you charge the battery in a temperature range of 10 °C to 30 °C (50 °F to 86 °F).

## To remove the battery pack

Close the LCD screen. Slide the BATT (battery) release lever (①) and remove the battery pack (②).

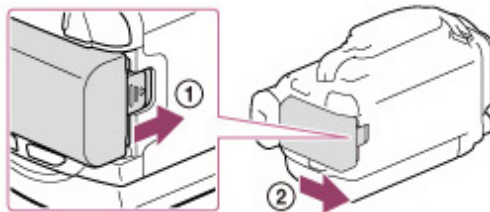

## To use your camcorder continuously for a long time

Connect the AC Adaptor and the power cord (mains lead) to your camcorder and the wall outlet (wall socket). [\[Details\]](#)

By using the AC Adaptor, you can use your camcorder without worrying about the battery running out of charge.

## Notes on the AC Adaptor

- Do not short-circuit the DC plug of the AC Adaptor or battery terminal with any metallic objects. This may cause a malfunction.
- Disconnect the AC Adaptor from the camcorder, while holding both the camcorder and the DC plug.

## Related topics

[Expected time of recording and playback with each battery pack](#)

Remaining battery indicator: [Screen indicators](#)

[Using your camcorder abroad](#)

[\[Power Save\]](#)

[▲ Back to top](#)

- ▶ Operation Search
- ▶ Before use
- ▶ Getting started
- ▶ Recording
- ▶ Playback
- ▶ Playing images on a TV
- ▶ Saving images with an external device
- ▶ Using the Wi-Fi function
- ▶ Customizing your camcorder
- ▶ Troubleshooting
- ▶ Maintenance and precautions

[→ Contents list](#)

## Charging the battery pack using your computer

1. Turn off your camcorder and connect the camcorder to a running computer using the Built-in USB Cable ( ① ).

② : To the wall outlet (wall socket)

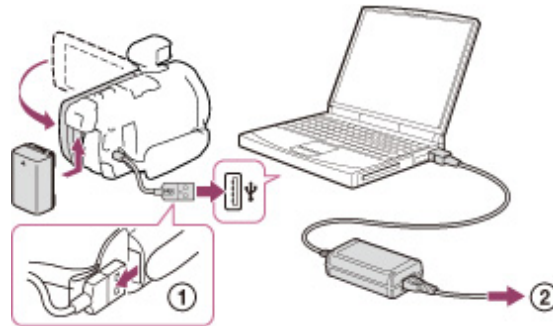

- The CHG (charge) lamp turns on.
- The CHG (charge) lamp turns off when the battery pack is fully charged. Disconnect Built-in USB Cable from your computer.

### To charge the battery using an AC-UD10 USB charger/AC Adaptor (sold separately)

You can charge the battery by connecting the Built-in USB Cable to a wall outlet (wall socket) using an AC-UD10 USB charger/AC Adaptor (sold separately). You cannot use a Sony CP-AH2R, CP-AL, or AC-UP100 portable power supply device (sold separately) to charge the camcorder.

### Charging time

Approximate time (min.) required to fully charge a fully discharged battery pack.

Battery pack	Built-in USB Cable* (when using your computer)
NP-FV50 (supplied)	280
NP-FV70	545
NP-FV100	1,000

- The charging times shown in the table above are measured when charging the camcorder at a room temperature of 25 °C (77 °F). It is recommended that you charge the battery in a temperature range of 10 °C to 30 °C (50 °F to 86 °F).

\* The charging times are measured without using the USB Connection support cable.

### To remove the battery pack

Close the LCD screen. Slide the BATT (battery) release lever ( ① ) and remove the battery pack ( ② ).

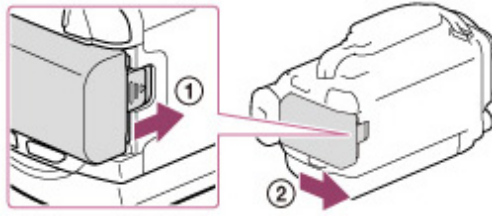

---

**Related topics**

[Charging the battery pack using the AC Adaptor](#)

[▲ Back to top](#)

---

Copyright 2013 Sony Corporation

- ▶ Operation Search
- ▶ Before use
- ▶ Getting started
- ▶ Recording
- ▶ Playback
- ▶ Playing images on a TV
- ▶ Saving images with an external device
- ▶ Using the Wi-Fi function
- ▶ Customizing your camcorder
- ▶ Troubleshooting
- ▶ Maintenance and precautions

[→ Contents list](#)

[Top page](#) > [Getting started](#) > [Turning the power on, and setting the date and time](#) > [Turning the power on, and setting the date and time](#)

## Turning the power on, and setting the date and time

1. Open the LCD screen of your camcorder and turn the power on.
  - You can also turn on the camcorder by pressing POWER.

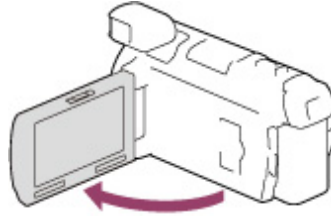

2. Select the desired language, then select [Next].

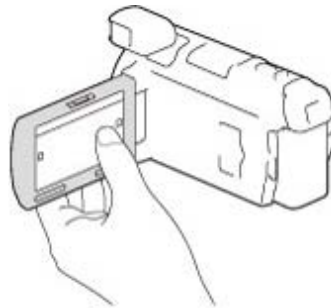

Touch the button on the LCD screen.

3. Select the desired geographical area with ◀ / ▶, then select [Next].

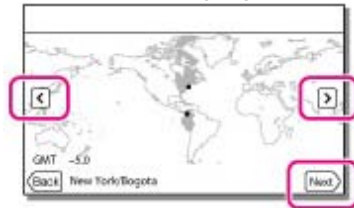

4. Set [Daylight Savings] or [Summer Time], select the date format and the date and time.
  - If you set [Daylight Savings] or [Summer Time] to [On], the clock advances 1 hour.
  - When you select the date and time, select one of the items and adjust the value with ▲ / ▼.
  - When you select OK → X, the date and time setting operation is complete.

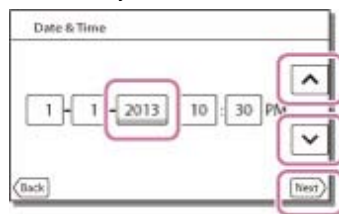

### **To change the language setting**

You can change the on-screen displays to show messages in a specified language.

Select **MENU** → [Setup] → [General Settings] → [Language Setting] → a desired language.

## To turn off the power

Close the LCD screen or press the POWER button.

If the viewfinder is pulled out, retract the viewfinder as shown in the illustration below.

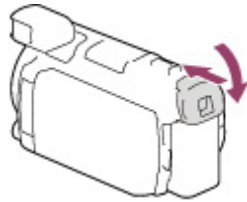

## On turning the camcorder on or off using the LCD screen or the viewfinder

The power of the camcorder is turned on or off depending on the status of the LCD screen or the viewfinder.

Status		Power of the camcorder
LCD screen	Viewfinder	
Open	Retracted	On
	Pulled out	On
Closed	Retracted	Off
	Pulled out	On

### Notes

- Even if the LCD screen is closed, if the viewfinder is pulled out, the camcorder is not turned off. When you turn off the power of the camcorder, make sure that the viewfinder is retracted to the original position.

## When you make recording with the viewfinder only

Pull out the viewfinder (①) and close the LCD panel and then adjust the angle you want (②). If the indicator on the viewfinder appears blurred, adjust the appearance using the viewfinder lens adjustment lever located on the above of the viewfinder.

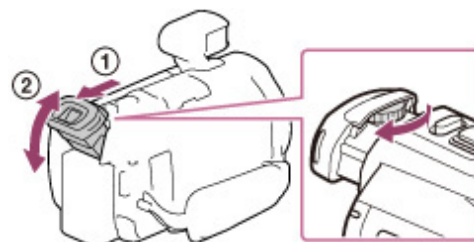

## To adjust the angle of the LCD screen

First open the LCD panel 90 degrees to the camcorder (①), and then adjust the angle (②).



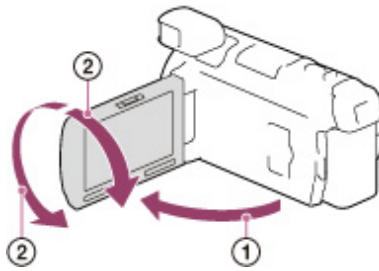

### Notes

- The recording date and time are recorded automatically on the recording media. They are not displayed during recording. However, you can check them as [Data Code] during playback. To display them, select **MENU** → [Setup] → [▶ Playback Settings] → [Data Code] → [Date/Time].
- Once the clock is set, the clock time is automatically adjusted with [Auto Clock ADJ] and [Auto Area ADJ] set to [On]. The clock may not automatically adjust to the correct time, depending on the country/region selected for your camcorder. In this case, set [Auto Clock ADJ] and [Auto Area ADJ] to [Off] (models with GPS).

### Related topics

Information on your camcorder model: [Model Information](#)

To set the date and time again: [\[Date & Time Setting\]](#)

To calibrate the touch panel: [\[Calibration\]](#)



[▲ Back to top](#)

- ▶ Operation Search
- ▶ Before use
- ▶ Getting started
- ▶ Recording
- ▶ Playback
- ▶ Playing images on a TV
- ▶ Saving images with an external device
- ▶ Using the Wi-Fi function
- ▶ Customizing your camcorder
- ▶ Troubleshooting
- ▶ Maintenance and precautions

[→ Contents list](#)

## Selecting a recording medium

The recording media that can be used are displayed on the screen of your camcorder as following icons.

Default recording medium		Alternative recording medium	
	Internal memory		Memory card

### Notes

- You cannot select a different recording medium for movies and for photos.

You can select a recording medium from the menu.

1. Select **MENU** → [Setup] → [Media Settings] → [Media Select] → the desired medium.



### Related topics

[Screen indicators during recording](#)

[Expected recording time of movies](#)

[▲ Back to top](#)

- ▶ Operation Search
- ▶ Before use
- ▶ Getting started
- ▶ Recording
- ▶ Playback
- ▶ Playing images on a TV
- ▶ Saving images with an external device
- ▶ Using the Wi-Fi function
- ▶ Customizing your camcorder
- ▶ Troubleshooting
- ▶ Maintenance and precautions

[→ Contents list](#)

## Inserting a memory card

1. Open the cover and insert the memory card until it clicks.
  - The [Preparing image database file. Please wait.] screen appears if you insert a new memory card. Wait until the screen disappears.

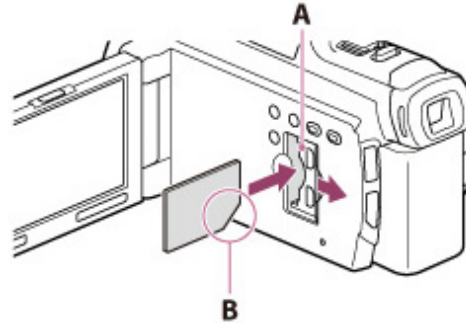

**A:** Access lamp

**B:** Insert the card with the notched corner in the direction as illustrated.

## Types of memory card you can use with your camcorder

	SD Speed Class	Capacity (operation verified)	Described in this manual
"Memory Stick PRO Duo" media (Mark2)	—	Up to 32 GB	"Memory Stick PRO Duo" media
"Memory Stick PRO-HG Duo" media			
"Memory Stick XC-HG Duo" media			
SD memory card	Class 4 or faster	Up to 64 GB	SD card
SDHC memory card			
SDXC memory card			

- Operation with all memory cards is not assured.

### Notes

- A MultiMediaCard cannot be used with this camcorder.
- Movies recorded on the "Memory Stick XC-HG Duo" media and SDXC memory cards cannot be imported to or played back on computers or AV devices not supporting the exFAT\* file system by connecting the camcorder to these devices with the USB cable. Confirm in advance that the connecting equipment is supporting the exFAT system. If you connect an equipment not supporting the exFAT system and the format screen appears, do not perform the format. All the data recorded will be lost.

\* The exFAT is a file system that is used for the "Memory Stick XC-HG Duo" media and SDXC memory cards.

## **| To eject the memory card**

Open the cover and lightly push the memory card in once.

### **Notes**

- To ensure stable operation of the memory card, it is recommended to format the memory card with your camcorder before the first use. Formatting the memory card will erase all the data stored on it and the data will be irrecoverable. Save your important data on your PC, etc.
- If [Failed to create a new Image Database File. It may be possible that there is not enough free space.] is displayed, format the memory card. [\[Details\]](#)
- Confirm the direction of the memory card. If you forcibly insert the memory card in the wrong direction, the memory card, memory card slot, or image data may be damaged.
- When inserting or ejecting the memory card, be careful so that the memory card does not pop out and drop.

---

### **Related topics**

Recording/playback/editing media: [Screen indicators during recording](#)

[Expected recording time of movies](#)

[Expected number of recordable photos](#)

[▲ Back to top](#)

---

Copyright 2013 Sony Corporation

- ▶ Operation Search
- ▶ Before use
- ▶ Getting started
- ▶ Recording
- ▶ Playback
- ▶ Playing images on a TV
- ▶ Saving images with an external device
- ▶ Using the Wi-Fi function
- ▶ Customizing your camcorder
- ▶ Troubleshooting
- ▶ Maintenance and precautions

[→ Contents list](#)

## Recording movies

In the default setting, movies and photos are recorded on the internal memory. Movies are recorded with high definition image quality (HD).

1. Open the LCD screen.
2. Press START/STOP to start recording.

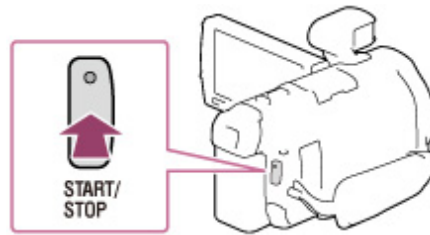

- To stop recording, press START/STOP again.

### To display items on the LCD screen

Items on the LCD screen disappear if you do not operate the camcorder for a few seconds after you turn the camcorder on or switch between the movie recording and photo shooting modes.

Touch anywhere except the buttons on the LCD screen to display information on icons with functions convenient for recording.

#### Notes

- If you close the LCD screen while recording movies, the camcorder stops recording (only when the viewfinder is retracted).
- The maximum continuous recordable time of movies is about 13 hours.
- When a movie file exceeds 2 GB, the next movie file is created automatically.
- The flash does not work while the (Movie) lamp is lit.
- The following states will be indicated if data is still being written onto the recording media after recording has finished. During this time, do not apply shock or vibration to the camcorder, or remove the battery or AC Adaptor.
  - Access lamp is lit or flashing
  - The media icon in the upper right of the LCD screen is flashing
- You may not be able to shoot photos depending on the setting in [ REC Mode] and [ Frame Rate].
- The LCD screen of your camcorder can display recording images across the entire screen (full pixel display). However, this may cause slight trimming of the top, bottom, right, and left edges of images when played back on a TV which is not compatible with full pixel display. It is recommended you record images with [Grid Line] set to [On] and using the outer frame of [Grid Line] as a guide.

#### Related topics

[Expected recording time of movies](#)

[[Media Select](#)]

To display items on the LCD screen all the time: [[Display Setting](#)]

Recordable time, remaining capacity: [[Media Info](#)]

[Zooming](#)



- ▶ Operation Search
- ▶ Before use
- ▶ Getting started
- ▶ Recording
- ▶ Playback
- ▶ Playing images on a TV
- ▶ Saving images with an external device
- ▶ Using the Wi-Fi function
- ▶ Customizing your camcorder
- ▶ Troubleshooting
- ▶ Maintenance and precautions

[→ Contents list](#)

## Shooting photos

In the default setting, photos are recorded on the internal memory.

1. Open the LCD screen and press MODE to turn on the  (Photo) lamp.
  - You can also switch the shooting mode by selecting [MODE] on the LCD screen.

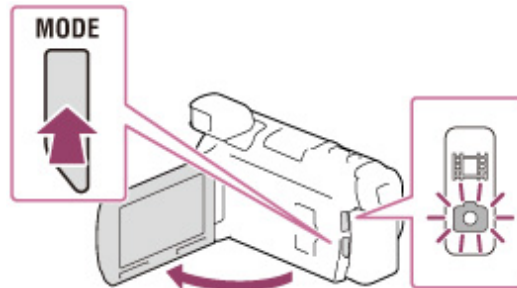

2. Press PHOTO lightly to adjust the focus, then press it fully.

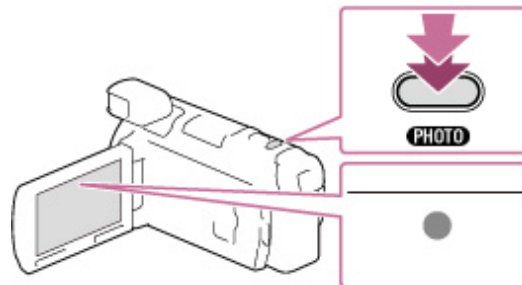

- When the focus is adjusted properly, AE/AF lock indicator appears on the LCD screen.

### Related topics

[Screen indicators during recording](#)

[Zooming](#)

[\[Flash\]](#)

To change the image size: [\[Image Size\]](#)

[▲ Back to top](#)

- ▶ Operation Search
- ▶ Before use
- ▶ Getting started
- ▶ Recording
- ▶ Playback
- ▶ Playing images on a TV
- ▶ Saving images with an external device
- ▶ Using the Wi-Fi function
- ▶ Customizing your camcorder
- ▶ Troubleshooting
- ▶ Maintenance and precautions

[→ Contents list](#)

## Screen indicators during recording

Described here are icons for both movie recording and photo recording modes.

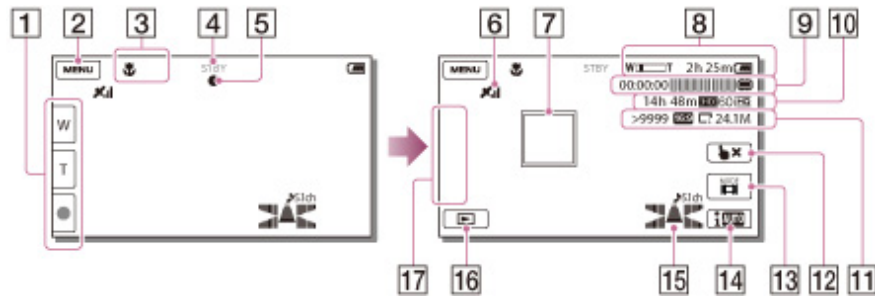

- 1** Zoom button (W: Wide/T: Telephoto), START/STOP button (in movie recording mode), PHOTO button (in photo recording mode)
- 2** MENU button
- 3** Status detected by Intelligent Auto
- 4** Recording status ([STBY]/[REC])
- 5** AE/AF (automatic exposure/automatic focus) lock
- 6** GPS triangulating status (models with GPS)
- 7** Tracking focus
- 8** Zoom, Remaining battery
- 9** Counter (hour: minute: second), Capturing a photo, Recording/playback/editing media
- 10** Estimated recording remaining time, Recording image quality, Frame rate, Recording mode (HD/STD), Movie size (MP4)
- 11** Approximate number of recordable photos, Aspect ratio (16:9 or 4:3), Photo size (L/M/S)
- 12** Tracking focus cancel button
- 13** [MODE] (Shooting Mode) button
- 14** Intelligent Auto button
- 15** Audio mode, Audio Level Display
- 16** View Images button
- 17** My Button (you can assign your favorite functions to icons displayed in this area)

### Related topics

Information on your camcorder model: [Model Information](#)

[▲ Back to top](#)





- ▶ Operation Search
- ▶ Before use
- ▶ Getting started
- ▶ Recording
- ▶ Playback
- ▶ Playing images on a TV
- ▶ Saving images with an external device
- ▶ Using the Wi-Fi function
- ▶ Customizing your camcorder
- ▶ Troubleshooting
- ▶ Maintenance and precautions

[→ Contents list](#)

## Zooming

1. Move the power zoom lever to magnify or reduce the size of the image.

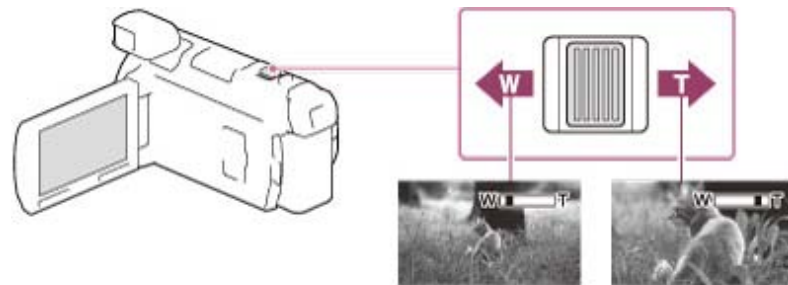

**W:** Wider range of view (Wide angle)

**T:** Close view (Telephoto)

- You can magnify images up to 17 times (Extended Zoom) the original size with the power zoom lever.
- Move the power zoom lever slightly for a slower zoom. Move it further for a faster zoom.

### Notes

- Be sure to keep your finger on the power zoom lever. If you move your finger off the power zoom lever, the operation sound of the power zoom lever may also be recorded.
- You cannot change the zoom speed with the / button on the LCD screen.
- The minimum possible distance between camcorder and subject while maintaining sharp focus is about 1 cm (about 13/32 in.) for wide angle and about 80 cm (about 31 1/2 in.) for telephoto.
- You can magnify images up to 10 times using optical zooming in the following cases:
  - When [SteadyShot] is set to other than [Active].
  - When the (Photo) lamp is lit.

### Related topics

Further zooming: [\[Digital Zoom\]](#)

[▲ Back to top](#)

[Top page](#) > [Recording](#) > [Useful functions for recording images](#) > [Capturing photos during movie recording \(Dual Capture\)](#)

▶ Operation Search

▶ Before use

▶ Getting started

▶ Recording

▶ Playback

▶ Playing images on a TV

▶ Saving images with an external device

▶ Using the Wi-Fi function

▶ Customizing your camcorder

▶ Troubleshooting

▶ Maintenance and precautions

[→ Contents list](#)

## Capturing photos during movie recording (Dual Capture)

1. Press PHOTO during movie recording to capture still photos.

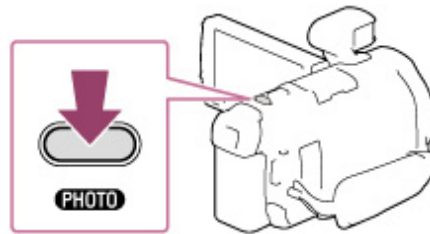

### Notes

- You cannot use the Dual Capture function when  is displayed.
- You may not be able to shoot photos depending on the setting in [ REC Mode] and [ Frame Rate].
- The flash does not work when you use the Dual Capture function.

[▲ Back to top](#)

Copyright 2013 Sony Corporation

▶ Operation Search

▶ Before use

▶ Getting started

▶ Recording

▶ Playback

▶ Playing images on a TV

▶ Saving images with an external device

▶ Using the Wi-Fi function

▶ Customizing your camcorder

▶ Troubleshooting

▶ Maintenance and precautions

[→ Contents list](#)

## Recording in mirror mode

1. Open the LCD panel 90 degrees to the camcorder (①), then rotate it 180 degrees to the lens side (②).

A mirror-image of the subject appears on the LCD screen, but the image will be normal when recorded.

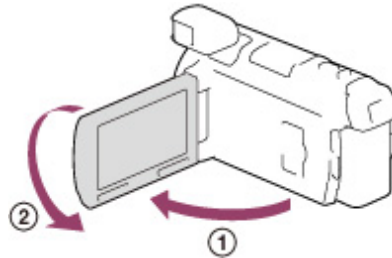



[▲ Back to top](#)

- ▶ Operation Search
- ▶ Before use
- ▶ Getting started
- ▶ Recording
- ▶ Playback
- ▶ Playing images on a TV
- ▶ Saving images with an external device
- ▶ Using the Wi-Fi function
- ▶ Customizing your camcorder
- ▶ Troubleshooting
- ▶ Maintenance and precautions

[→ Contents list](#)

## Intelligent Auto

Your camcorder records movies after selecting the most suitable setting for the subjects or the situation automatically. ([On] is the default setting.)







1. Select  → [On] →  at the right bottom of the recording screen of movies or photos.



2. Point the camcorder toward the subject and start recording.  
The icons that correspond to the conditions detected are displayed.



**Face detection:**  (Portrait),  (Baby)

**Scene detection:**  (Backlight),  (Landscape),  (Night Scene),  (Spotlight),  (Low light),  (Macro)

**Camera-shake detection:**  (Walk),  (Tripod)

**Sound detection:**   (Auto Wind NR)

To cancel the Intelligent Auto function, select  → [Off].

### Notes

- The camcorder may not detect the expected scene or subject, depending on the recording conditions.

### Related topics

[\[Low Lux\]](#)

[▲ Back to top](#)

- ▶ Operation Search
- ▶ Before use
- ▶ Getting started
- ▶ Recording
- ▶ Playback
- ▶ Playing images on a TV
- ▶ Saving images with an external device
- ▶ Using the Wi-Fi function
- ▶ Customizing your camcorder
- ▶ Troubleshooting
- ▶ Maintenance and precautions

[→ Contents list](#)

[Top page](#) > [Recording](#) > [Useful functions for recording images](#) > [Recording the selected subject clearly \(Face Priority\)](#)

## Recording the selected subject clearly (Face Priority)

Your camcorder can track a face you select and adjust the focus, exposure, and skin tone of the face automatically.

1. Touch one of the faces targeted.

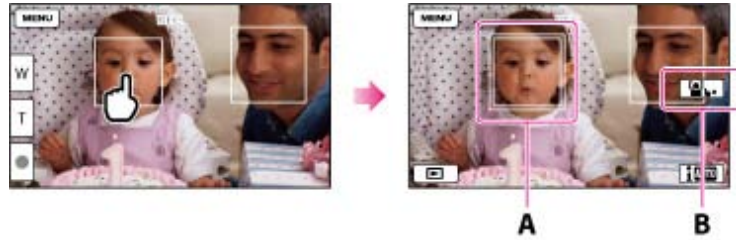

- A:** The double-lined frame is displayed.  
**B:** You can release the selection.

### Notes

- The subject you touched may not be detected, depending on the surrounding brightness or hairstyle of the subject.
- Make sure to set the [Face Detection] setting to other than [Off] ([Auto] is the default setting).

## To record subjects other than people (Tracking focus)

Touch the subject you want to record.  
Your camcorder adjusts the focus automatically.

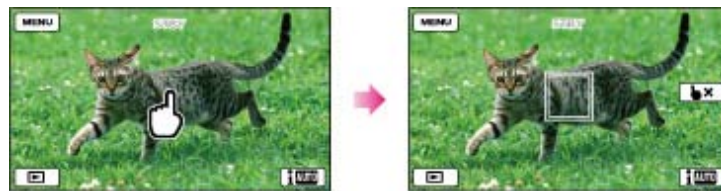

[▲ Back to top](#)

- ▶ Operation Search
- ▶ Before use
- ▶ Getting started
- ▶ Recording
- ▶ Playback
- ▶ Playing images on a TV
- ▶ Saving images with an external device
- ▶ Using the Wi-Fi function
- ▶ Customizing your camcorder
- ▶ Troubleshooting
- ▶ Maintenance and precautions

[→ Contents list](#)

## Recording movies in dim places (Video Light)

1. Press LIGHT.

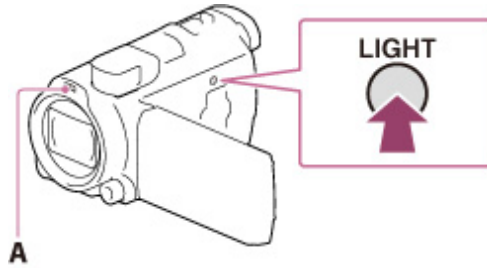

**A:** Flash/Video light

Each time you press the LIGHT button, the setting changes as follows.

Off (no indicator) → Auto (AUTO) → On (ON) → ...

### Notes

- Keep a distance of about 0.3 m to 1.5 m (1 foot to 5 feet) between the camcorder and the subject.
- The video light generates strong light. Do not use the video light directly in front of the eyes at close range.
- The battery drains quickly while using the video light.
- When you shoot photos, the video light turns off and will work as a flash.

### Related topics

[\[Light Bright\]](#)

[▲ Back to top](#)

- ▶ Operation Search
- ▶ Before use
- ▶ Getting started
- ▶ Recording
- ▶ Playback
- ▶ Playing images on a TV
- ▶ Saving images with an external device
- ▶ Using the Wi-Fi function
- ▶ Customizing your camcorder
- ▶ Troubleshooting
- ▶ Maintenance and precautions

[→ Contents list](#)

## Recording in dark places (NightShot)

You can record images even in total darkness.

1. Press NIGHTSHOT.

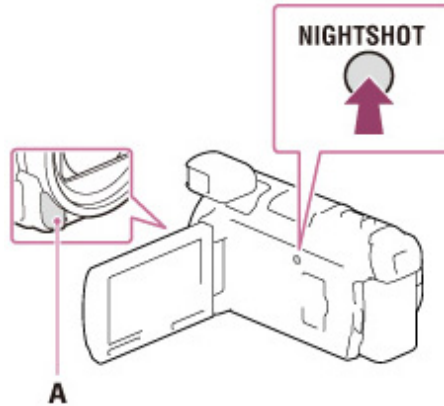

**A:** Infrared port

-  appears on the LCD screen.
- To cancel the NightShot function, press NIGHTSHOT again.

### Notes

- Using NightShot in bright places will cause a malfunction of your camcorder.
- Do not cover the infrared port. Infrared rays are required when using NightShot.
- When recording movies using the NightShot function, remove the lens hood, the Step Down Ring (supplied), and the conversion lens (sold separately).

### Related topics

Adjusting focus: [\[Focus\]](#)

Recording color images in dim light: [\[Low Lux\]](#)

[▲ Back to top](#)



- ▶ Operation Search
- ▶ Before use
- ▶ Getting started
- ▶ Recording
- ▶ Playback
- ▶ Playing images on a TV
- ▶ Saving images with an external device
- ▶ Using the Wi-Fi function
- ▶ Customizing your camcorder
- ▶ Troubleshooting
- ▶ Maintenance and precautions

[→ Contents list](#)

## Controlling the image settings manually with the MANUAL dial

It is convenient to make manual adjustments using the MANUAL dial, by assigning a menu item ([Focus] in the default setting) to the MANUAL dial.

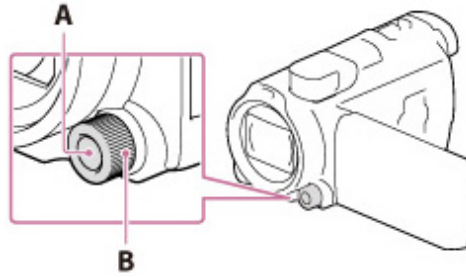

**A:** MANUAL button  
**B:** MANUAL dial

1. Press MANUAL to switch to manual operation mode.
  - Pressing MANUAL switches the operation mode between manual and automatic.
2. Rotate the dial to make the adjustment.

### Items you can control with the MANUAL dial

- [\[Focus\]](#)
- [\[Exposure\]](#)
- [\[IRIS\]](#)
- [\[Shutter Speed\]](#)
- [\[AE Shift\]](#)
- [\[White Balance Shift\]](#)

### To assign the menu item to the MANUAL dial

- ① Press and hold MANUAL down for a few seconds.
- ② Rotate the MANUAL dial and select the item to be assigned.

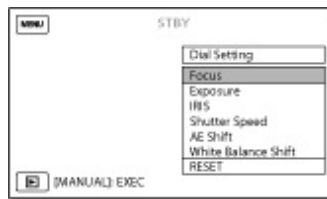

Select [RESET] to reset the items adjusted manually to the default settings.

- ③ Press MANUAL.

The camera data that appears on the LCD screen will differ, depending on the recording settings of the camcorder. The settings will be displayed with the following icons.

AUTO : Automatic

MANUAL : Exposure is set manually.

**AE A** : IRIS priority

**AE S** : Shutter speed priority

#### Notes

- Manual settings will be retained even if you change the assigned item of the MANUAL dial. However, if you set [Exposure] after setting [AE Shift] manually, [Exposure] will override [AE Shift].
- If you set either one of [Exposure], [IRIS], or [Shutter Speed], the settings of other 2 items are canceled.

---

#### Related topics

Checking the camera data: [[Data Code](#)]

[▲ Back to top](#)

---

Copyright 2013 Sony Corporation

- ▶ Operation Search
- ▶ Before use
- ▶ Getting started
- ▶ Recording
- ▶ Playback
- ▶ Playing images on a TV
- ▶ Saving images with an external device
- ▶ Using the Wi-Fi function
- ▶ Customizing your camcorder
- ▶ Troubleshooting
- ▶ Maintenance and precautions

[→ Contents list](#)

### Features available using GPS (Models with GPS)

The following features are available if you use the GPS (Global Positioning System) function.

- Recording location information on movies or photos ([On] is the default setting.)



- Playing movies and photos by searching for them from a map (Map View)

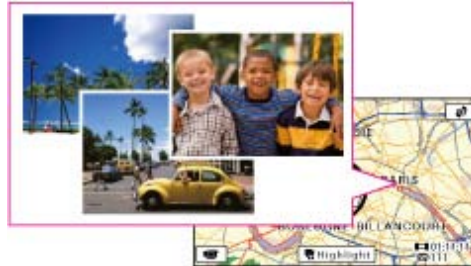

- Displaying a map of your current location



### GPS triangulating status

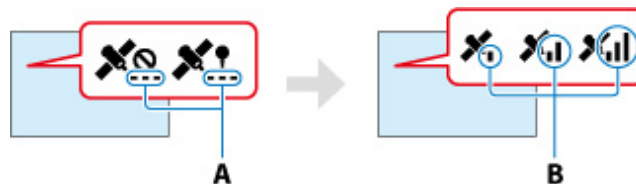

- A: Number of dots changes while the camcorder is searching for the satellites.
- B: Triangulating meters appear when the satellites are found.

### When the camcorder cannot triangulate



**A:** The camcorder does not have location information.

**B:** The camcorder displays the location information that was previously obtained.

---

### Related topics

Information on your camcorder model: [Model Information](#)

[▲ Back to top](#)

---

Copyright 2013 Sony Corporation

[Top page](#) > [Recording](#) > [Recording information on your location \(GPS\)](#) > [Using the GPS function \(Models with GPS\)](#)

- ▶ [Operation Search](#)
- ▶ [Before use](#)
- ▶ [Getting started](#)
- ▶ [Recording](#)
- ▶ [Playback](#)
- ▶ [Playing images on a TV](#)
- ▶ [Saving images with an external device](#)
- ▶ [Using the Wi-Fi function](#)
- ▶ [Customizing your camcorder](#)
- ▶ [Troubleshooting](#)
- ▶ [Maintenance and precautions](#)

[→ Contents list](#)

## Using the GPS function (Models with GPS)

You can use the GPS function by selecting **MENU** → [Setup] → [ General Settings] → [GPS Setting] → [On] (the default setting).

### If you do not want to record location information

Select **MENU** → [Setup] → [ General Settings] → [GPS Setting] → [Off].

#### Notes

- It may take a while before the camcorder starts triangulating.
- Use the GPS function outdoors and in open areas, where the radio signals can be best received in such areas.
- The map always displays the north at the top.

### Related topics

Information on your camcorder model: [Model Information](#)

[▲ Back to top](#)

- ▶ Operation Search
- ▶ Before use
- ▶ Getting started
- ▶ Recording
- ▶ Playback
- ▶ Playing images on a TV
- ▶ Saving images with an external device
- ▶ Using the Wi-Fi function
- ▶ Customizing your camcorder
- ▶ Troubleshooting
- ▶ Maintenance and precautions

[→ Contents list](#)

[Top page](#) > [Recording](#) > [Recording information on your location \(GPS\)](#) > [Obtaining a map of the current location \(triangulation priority mode\) \(Models with GPS\)](#)

## Obtaining a map of the current location (triangulation priority mode) (Models with GPS)

This feature is useful for checking a map of your current location while traveling.

1. Select  → [Setup] → [ General Settings] → [Your Location].



**A:** A marker that indicates your current location

### Notes

- If you select a certain point on the screen, the map shows an area with that point at the center. Select  to move your current location back to the center again.
- If the camcorder cannot acquire current location information, the triangulating information appears.
- If the camcorder cannot obtain current location information, a marker which indicates the location last acquired is displayed on a map. If the location information that was previously obtained is invalid, the marker does not appear.

### Related topics

Information on your camcorder model: [Model Information](#)

[▲ Back to top](#)

- ▶ Operation Search
- ▶ Before use
- ▶ Getting started
- ▶ Recording
- ▶ Playback
- ▶ Playing images on a TV
- ▶ Saving images with an external device
- ▶ Using the Wi-Fi function
- ▶ Customizing your camcorder
- ▶ Troubleshooting
- ▶ Maintenance and precautions

[→ Contents list](#)

## Checking the triangulating status (Models with GPS)

The camcorder displays the status of the GPS signal reception when you are unable to obtain the triangulating information.

1. Touch  on [Your Location] screen.

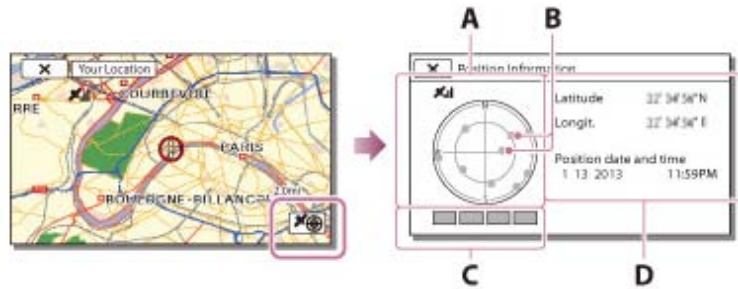

- A: Satellite map
- B: Satellite icons
- C: Triangulating gauge
- D: Information on the previously obtained location

### On the satellite map and triangulating gauge

The center of the satellite map shows your current location. You can check the direction (north/south/east/west) of the satellites with the satellite icons (●) that appear on the satellite map. When the camcorder succeeds in triangulating your location, the triangulating gauge turns to green.

### How to check the GPS satellite icons/triangulating gauge

The color of the GPS satellite icons and the triangulating gauge change according to the current status of triangulation.

GPS satellite icons/triangulating gauge	Status
●/■ (black)	No signal, but orbit information for the satellite is available.
●/■ (gray)	Part of the satellite orbit information has been obtained.
●/■ (brown)	About a half of the satellite orbit information has been obtained.
●/■ (ocher)	Most of the satellite orbit information has been obtained.
●/■ (green)	Triangulating is completed and the satellite is currently being used.

## **| If data on your current location cannot be obtained**

A display that allows you to triangulate the location again appears. In this case, follow the instructions that appears on the LCD screen.

---

### **Related topics**

Information on your camcorder model: [Model Information](#)

[▲ Back to top](#)

---

Copyright 2013 Sony Corporation



[Top page](#) > [Recording](#) > [Recording information on your location \(GPS\)](#) > [Hints for better reception \(Models with GPS\)](#)

- ▶ Operation Search
- ▶ Before use
- ▶ Getting started
- ▶ Recording
- ▶ Playback
- ▶ Playing images on a TV
- ▶ Saving images with an external device
- ▶ Using the Wi-Fi function
- ▶ Customizing your camcorder
- ▶ Troubleshooting
- ▶ Maintenance and precautions

[→ Contents list](#)

## Hints for better reception (Models with GPS)

- Use the GPS function outdoors and in open areas.  
For details on locations or situations where radio signals cannot be received, see ["About GPS \(Models with GPS\)."](#)
- Rotate the LCD panel to direct the GPS antenna toward the sky. Do not place your hand on the GPS antenna.

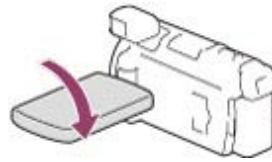

- Select [Your Location] in the menu to use the triangulating priority mode.
- Use GPS Assist Data. If you import GPS Assist Data from your computer to your camcorder using the "PlayMemories Home" software, the time it takes the camcorder to acquire your location information can be shortened. Connect the camcorder to a computer that is connected to the Internet. The GPS Assist Data will be updated automatically.

### Notes

- In the following situations, the current location of the camcorder shown on the map may be different from the actual location. The margin of error can be as wide as several hundred meters.
  - When the camcorder receives GPS signals that have been reflected off the surrounding buildings
  - When the GPS signal is too weak
- The GPS Assist Data may not function in the following cases:
  - When the GPS Assist Data are not updated for about 30 days or more.
  - When the date and time of the camcorder are not correctly set.
  - When the camcorder is moved for a long distance.

### Related topics

Information on your camcorder model: [Model Information](#)

Locations or situations where radio signals cannot be received: [About GPS \(Models with GPS\)](#)

[▲ Back to top](#)

- ▶ Operation Search
- ▶ Before use
- ▶ Getting started
- ▶ Recording
- ▶ Playback
- ▶ Playing images on a TV
- ▶ Saving images with an external device
- ▶ Using the Wi-Fi function
- ▶ Customizing your camcorder
- ▶ Troubleshooting
- ▶ Maintenance and precautions

[→ Contents list](#)



## Playing movies and photos from the Event View screen

You can search for recorded images by date and time of recording (Event View).

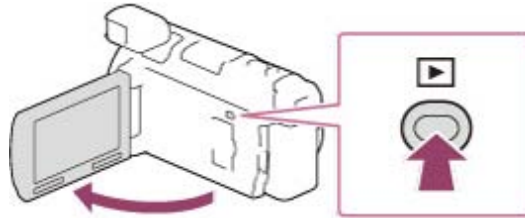
1. Open the LCD screen and press the  button on the camcorder to enter the playback mode.



- You can enter the playback mode by selecting  on the LCD screen. [\[Details\]](#)

2. Select  /  to move the desired event to the center (①) and then select it (②).

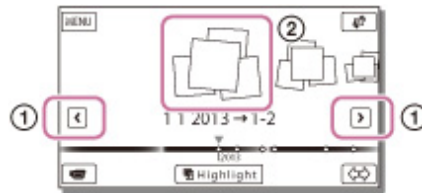

- The camcorder displays recorded images as an event automatically, based on the date and time.



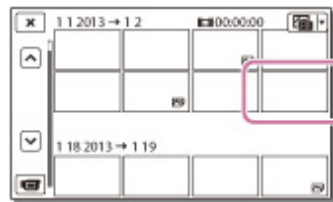



3. Select the image.











- The camcorder plays from the selected image to the last image in the event.

4. Select the appropriate buttons on the LCD screen for various playback operations.



	Volume	 / 	Previous/Next
	Delete	 / 	Fast-reverse/fast-forward

	Context		Play/Pause
	Stop		Play/stop slide show

- Some buttons described above may not appear, depending on the image being played back.
- As you repeat selecting  /  during playback, movies are played as fast as about 5 times → about 10 times → about 30 times → about 60 times.
- Select  /  during pause to play movies slowly.
- To repeat Slideshow, select  → [Slideshow Set] when  is selected with the Switch Image Type button.

## Screen display on the Event View screen

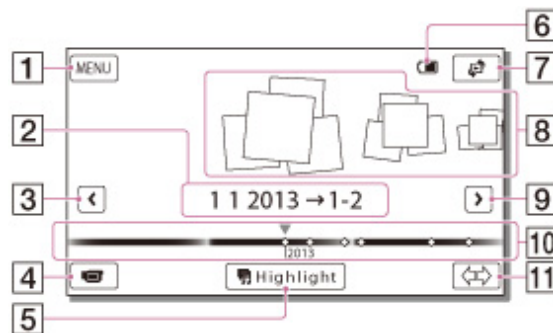

- 1**: To the MENU screen
- 2**: Event name
- 3**: To the previous event
- 4**: Change to the movie/photo recording mode
- 5**: To play back short movies (Highlight Playback)
- 6**: Remaining battery
- 7**: To the Map View screen (models with GPS)
- 8**: Events
- 9**: To the next event
- 10**: Time-line bar
- 11**: Change Event Scale button

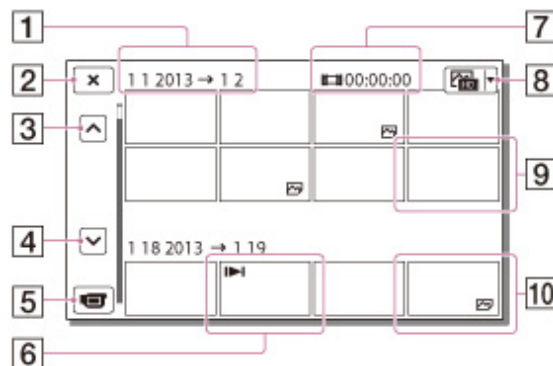

- 1**: Event title
- 2**: To go back to the Event View screen
- 3**: Previous
- 4**: Next

**5** : Change to the movie/photo recording mode

**6** : Last played image

**7** : Recorded time/number of photos

**8** : Switch Image Type button

**9** : Movie

**10** : Photo

- Reduced-size images which enable you to view many images at the same time on an index screen are called “thumbnails.”

## **To play back images with other devices**

- You may not be able to play back with other devices images that were recorded on your camcorder normally. Also, you may not be able to play back images recorded on other devices with your camcorder.
- Standard definition image quality (STD) movies recorded on SD memory cards cannot be played on AV equipment of other manufacturers.

### **Notes**

- To prevent your image data from being lost, save all your recorded images on external media periodically.
- In the default setting, a protected demonstration movie is pre-recorded.

---

### **Related topics**

Information on your camcorder model: [Model Information](#)

[▲ Back to top](#)

---

Copyright 2013 Sony Corporation

- ▶ Operation Search
- ▶ Before use
- ▶ Getting started
- ▶ Recording
- ▶ Playback
- ▶ Playing images on a TV
- ▶ Saving images with an external device
- ▶ Using the Wi-Fi function
- ▶ Customizing your camcorder
- ▶ Troubleshooting
- ▶ Maintenance and precautions

[→ Contents list](#)

## Playing movies and photos from a map (Models with GPS)

You can search for recorded images by location of recording (Map View).

1. Open the LCD screen and select  (View Images) on the LCD screen to enter the playback mode.

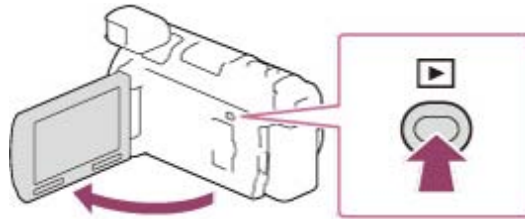

2. Switch to the Map View by touching  → [Map View].



3. Select the recording location.

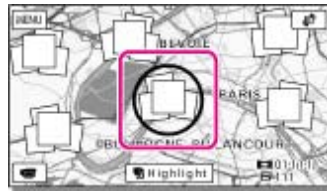

- Touch the direction on the map in which you want the map to be scrolled. Keep touching that point to scroll the map continuously.
- If you change the map scale using the power zoom button, the clusters of thumbnails will change as well.

4. Select the desired image.

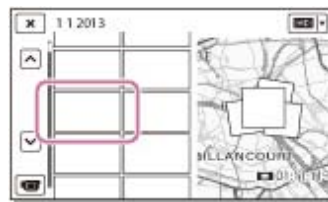

5. Select the appropriate buttons on the LCD screen for various playback operations.



	Volume		Previous/Next
	Delete		Fast-reverse/fast-forward
	Context		Play/Pause
	Stop		Play/stop slide show

- Some buttons described above may not appear, depending on the image being played back.
- As you repeat selecting / during playback, movies are played as fast as about 5 times → about 10 times → about 30 times → about 60 times.
- Select / during pause to play movies slowly.
- To repeat Slideshow, select → [Slideshow Set] when is selected with the Switch Image Type button.

## When you use the map data for the first time

A message appears asking you to confirm whether you agree with the terms of the license agreement of the map data. You can use the map data by touching [Agree] on the screen after agreeing to the terms of the license agreement. (For details on the license agreement, refer to the “Operating Guide” supplied with your camcorder.)

You cannot use the map data if you touch [Not Agree]. However, when you try to use the map data for the second time, the same message will appear on the screen, and you can use the map data by touching [Agree].

## Screen display on the Map View

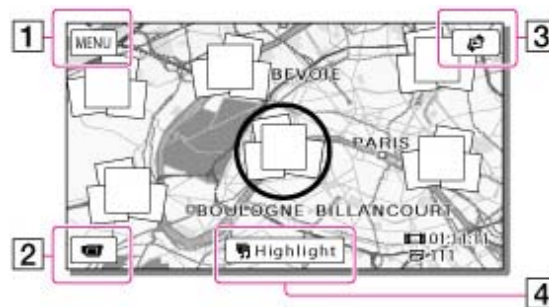

- 1** : To the MENU screen
- 2** : To the movie recording display
- 3** : To the Event View screen
- 4** : To play back short movies

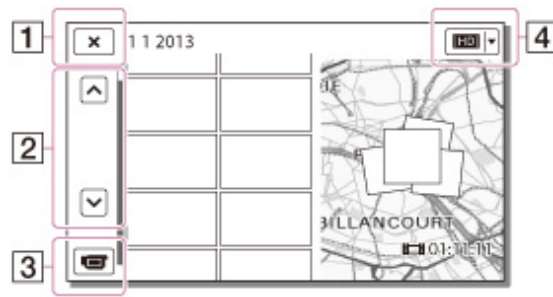

- 1** : To the Map View
- 2** : Previous/next
- 3** : To the movie recording display
- 4** : Switch Image Type button

### **To play back images with other devices**

- You may not be able to play back with other devices images that were recorded on your camcorder normally. Also, you may not be able to play back images recorded on other devices with your camcorder.
- Standard definition image quality (STD) movies recorded on SD memory cards cannot be played on AV equipment of other manufacturers.

---

#### **Related topics**

Information on your camcorder model: [Model Information](#)

[▲ Back to top](#)



- ▶ Operation Search
- ▶ Before use
- ▶ Getting started
- ▶ Recording
- ▶ Playback
- ▶ Playing images on a TV
- ▶ Saving images with an external device
- ▶ Using the Wi-Fi function
- ▶ Customizing your camcorder
- ▶ Troubleshooting
- ▶ Maintenance and precautions

[→ Contents list](#)

## Dividing a movie

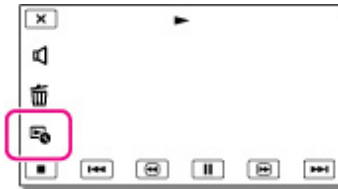
1. Select  → [Divide] on the movie playback screen.



2. Select the point where you want to divide the movie into scenes using  / , and then select .

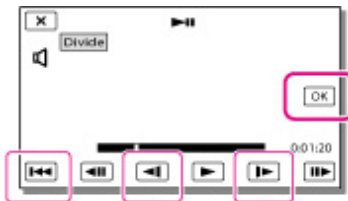

- A:** Returns to the beginning of the selected movie  
**B:** Adjusts the dividing point with more precision

### Notes

- A slight difference may occur from the point where you select and the actual dividing point, as your camcorder selects the dividing point based on about half-second increments.
- An MP4 movie cannot be divided.
- Some basic editing operations can be done on the camcorder. If you want to do advanced editing operations, use the "PlayMemories Home" software.
- Do not remove the battery pack or the AC Adaptor from your camcorder while dividing the images. It may damage the recording media.
- Do not eject the memory card while dividing images from the memory card.
- If you divide movies that are included in saved scenarios, the scenarios will also be deleted.

### Related topics

[\[Delete\]](#)

[▲ Back to top](#)



- ▶ Operation Search
- ▶ Before use
- ▶ Getting started
- ▶ Recording
- ▶ Playback
- ▶ Playing images on a TV
- ▶ Saving images with an external device
- ▶ Using the Wi-Fi function
- ▶ Customizing your camcorder
- ▶ Troubleshooting
- ▶ Maintenance and precautions



[→ Contents list](#)

## Capturing a photo from a movie

You can capture images from movies recorded with your camcorder.

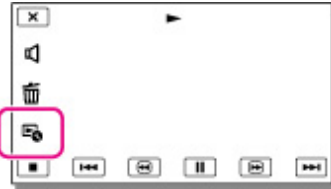
1. Select  → [Photo Capture] that appears on the playback screen of a movie.



2. Select the point where you want to capture a photo using  / , and then select .

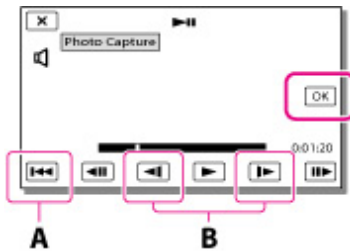

- A:** Returns to the beginning of the selected movie  
**B:** Adjusts the capturing point with more precision

If the movie was recorded with one of the following image quality levels, the image size will be set as shown below.

- High definition image quality (HD) or MP4: 2.1 M (16:9)
- Wide aspect ratio (16:9) with standard definition image quality (STD): 0.2 M (16:9)
- 4:3 aspect ratio with standard definition image quality (STD): VGA (0.3 M) (4:3)

### Notes

- You cannot save captured images to the memory card (models without a USB input function).

### On recording date and time of captured photos

- The recording date and time of captured photos is the same as the recording date and time of the movies.
- If the movie you are capturing from has no data code, the recording date and time of the photo will be the date and time you captured from the movie.

### Related topics

Information on your camcorder model: [Model Information](#)



[▲ Back to top](#)

- ▶ Operation Search
- ▶ Before use
- ▶ Getting started
- ▶ Recording
- ▶ Playback
- ▶ Playing images on a TV
- ▶ Saving images with an external device
- ▶ Using the Wi-Fi function
- ▶ Customizing your camcorder
- ▶ Troubleshooting
- ▶ Maintenance and precautions

[➔ Contents list](#)

## Enjoying a digest of your movies (Highlight Playback)

You can enjoy a digest of high definition image quality (HD) movies and photos, similar to a short movie.

1. Press  (View Images).
2. Display the desired event at the center of the Event View, and select [ Highlight].

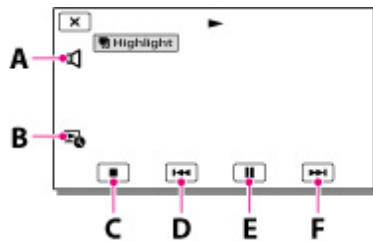

- A: Volume adjustment
- B: Context
- C: To stop
- D: Previous
- E: To pause
- F: Next

3. Select the desired operation when the highlight playback finishes.

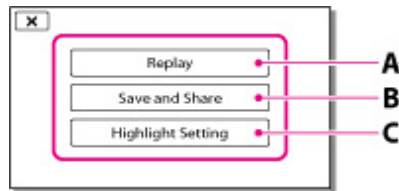

- A: The camcorder plays the Highlight Playback scenes again.
- B: You can save the Highlight Playback scenes in standard definition image quality (STD) and share it (upload it to the Web, etc.).
- C: You can change the settings for Highlight Playback.

### Notes

- Highlight Playback scenes will change each time you select a Highlight Playback.
- The [Playback Range] setting is cleared when the Highlight Playback stops.
- The audio used for the Highlight Playback will be converted to 2ch stereo.
- When you connect the camcorder to an external device, such as a TV, and watch Highlight Playback, these images do not appear on the LCD screen of the camcorder.



- ▶ Operation Search
- ▶ Before use
- ▶ Getting started
- ▶ Recording
- ▶ Playback
- ▶ Playing images on a TV
- ▶ Saving images with an external device
- ▶ Using the Wi-Fi function
- ▶ Customizing your camcorder
- ▶ Troubleshooting
- ▶ Maintenance and precautions

[➔ Contents list](#)

## Changing the settings for Highlight Playback

You can change the Highlight Playback settings by selecting [Highlight Setting] on the screen after Highlight Playback has finished.

You can also change the setting by selecting  → [Highlight Setting] while the camcorder is playing highlight scenes.

- [Playback Range]: You can set the playback range (starting and ending date) of the Highlight Playback.
- [Theme]: You can select a theme for Highlight Playback.
- [Music]: You can select music.
- [Audio mix]: The original sound is played back with the music.
- [Length]: You can set the length of the Highlight Playback segment.
- [Highlight Point]: You can set the points in a movie or photo that will be used in a Highlight Playback.

Play the desired movie, and select  → OK. Or play the desired photo and select OK.

 appears on the movie or photo that is used in a Highlight Playback.

To erase the points, select  → [Clear All Points].

### Notes

- After the music file is transferred to the camcorder, if you cannot play the music, the music file may be damaged. Delete the music file by selecting MENU → [Setup] → [ Playback Settings] → [Empty Music], then transfer the music file again. You can restore the music data recorded on your camcorder at the default using "Music Transfer." For operating instructions, see "Music Transfer" help (models with a USB input function).
- If the Highlight Playback function was started from the Map View, [Highlight Point] cannot be set. However, if the Highlight Playback function was started from the Event View screen and you set the [Highlight Point], the point can take effect on the Map View also (models with GPS).

### Related topics

Information on your camcorder model: [Model Information](#)

[▲ Back to top](#)

- ▶ Operation Search
- ▶ Before use
- ▶ Getting started
- ▶ Recording
- ▶ Playback
- ▶ Playing images on a TV
- ▶ Saving images with an external device
- ▶ Using the Wi-Fi function
- ▶ Customizing your camcorder
- ▶ Troubleshooting
- ▶ Maintenance and precautions

[→ Contents list](#)

[Top page](#) > [Playback](#) > [Highlight playback](#) > [Saving Highlight Playback in high definition image quality \(HD\) \(Scenario Save\)](#)

## Saving Highlight Playback in high definition image quality (HD) (Scenario Save)

You can save your favorite Highlight Playback as a "Scenario" with high definition image quality (HD). Up to 8 scenarios can be saved.

1. Select [Replay] on the screen after a Highlight Playback has finished.
2. When the Highlight Playback starts again, select  → [Scenario Save].



### To play back a saved scenario

1. Select MENU → [Playback Function] → , select the desired scenario, and then select OK.

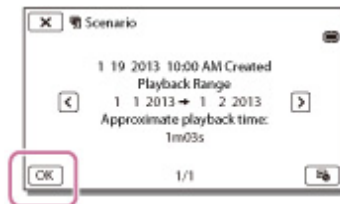

- To erase a saved scenario, select  → [Erase]/[Erase All] while playing the scenario.

### Notes

- When you connect the camcorder to an external device, such as a TV, and watch Highlight Scenario, these images do not appear on the LCD screen of the camcorder.
- The scenarios can be played on this camcorder only.

[▲ Back to top](#)

- ▶ Operation Search
- ▶ Before use
- ▶ Getting started
- ▶ Recording
- ▶ Playback
- ▶ Playing images on a TV
- ▶ Saving images with an external device
- ▶ Using the Wi-Fi function
- ▶ Customizing your camcorder
- ▶ Troubleshooting
- ▶ Maintenance and precautions

[→ Contents list](#)

## Converting Highlight Playback scenes or Highlight Scenarios to standard definition image quality (STD) (Highlight Movie)

You can convert the data format of Highlight Playback or Highlight Scenarios to standard definition image quality (STD) and save them as a "Highlight Movie." Highlight movies can be uploaded to the Web.

1. Select [Save and Share] on the screen after Highlight Playback or Highlight Scenario playback has finished.
2. Select the desired operation when the item has been saved.

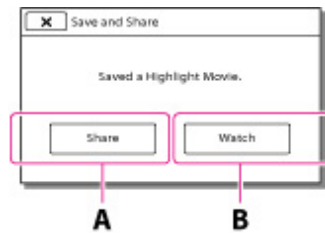

- A:** Selecting [Share] allows you to upload the Highlight movie to the Web using the "PlayMemories Home" software [\[Details\]](#).
- B:** Your camcorder plays the Highlight Movie saved.

### To play back a Highlight Movie

1. Select **MENU** → [Playback Function] → [Highlight Movie] and select the desired Highlight Movie.
  - To erase Highlight Movie, select  while the Highlight Movie is playing.

[▲ Back to top](#)

- ▶ Operation Search
- ▶ Before use
- ▶ Getting started
- ▶ Recording
- ▶ Playback
- ▶ Playing images on a TV
- ▶ Saving images with an external device
- ▶ Using the Wi-Fi function
- ▶ Customizing your camcorder
- ▶ Troubleshooting
- ▶ Maintenance and precautions

[→ Contents list](#)

## Using the built-in projector

You can use a flat surface such as a wall as a screen to view recorded images using the built-in projector.

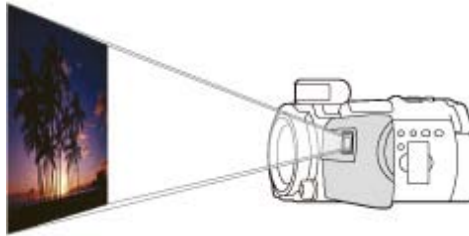

1. Face the projector lens towards a surface, such as a wall, and then press PROJECTOR.

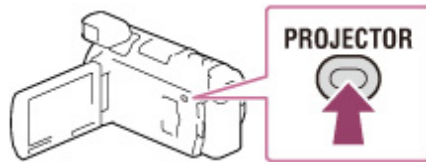

2. Select [Image Shot on This Device] on the LCD screen.
3. When the operating guide screen appears, select [Project].



- This screen appears the first time you use the built-in projector after the camcorder is turned on.
4. Adjust the focus of the projected image using the PROJECTOR FOCUS lever.

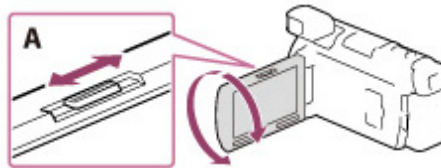

**A:** PROJECTOR FOCUS lever

- The projected image is larger when the distance between your camcorder and the reflecting surface increase.
  - It is recommended that you place the camcorder further than 0.5 m (1.6 feet) away (approximate distance) from the surface that the images are to be projected onto.
5. When playing back images, use the power zoom lever to move the selection frame that appears on the LCD screen, then press PHOTO button.

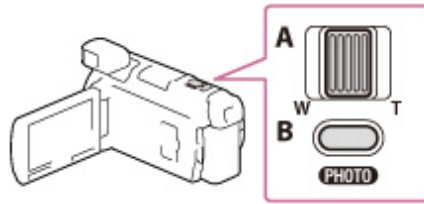

**A:** Power zoom lever

**B:** PHOTO button

- For details on playback, see the playback section. [\[Details\]](#)
- When you use the wireless remote commander, press ◀ / ▶ / ▲ / ▼ to move the selection frame and press ENTER to start playing the framed item.
- To turn off the projector, press PROJECTOR.

#### Notes

- The LCD screen turns off while an image is being projected.
- Be careful of the following operations or situations while using the projector.
  - Make sure not to project images towards the eyes.
  - Make sure not to touch the projector lens.
  - The LCD screen and the projector lens become hot while in use.
  - Using the projector shortens battery life (using the supplied AC Adaptor is recommended).
- The following operations are unavailable while you are using the projector.
  - Map operation (models with GPS)
  - Output of Highlight Playback to a device such as a TV
  - Operation of the camcorder with the LCD screen closed
  - Several other functions
- When the projected images contain a lot of black, faint color unevenness may appear. This is caused by light reflection in the projector lens and is not a malfunction.

---

#### Related topics

Information on your camcorder model: [Model Information](#)

[▲ Back to top](#)



- ▶ Operation Search
- ▶ Before use
- ▶ Getting started
- ▶ Recording
- ▶ Playback
- ▶ Playing images on a TV
- ▶ Saving images with an external device
- ▶ Using the Wi-Fi function
- ▶ Customizing your camcorder
- ▶ Troubleshooting
- ▶ Maintenance and precautions

[→ Contents list](#)

## Using the projector for your computer or smartphone

You can project images from a computer or smartphone using the built-in projector.

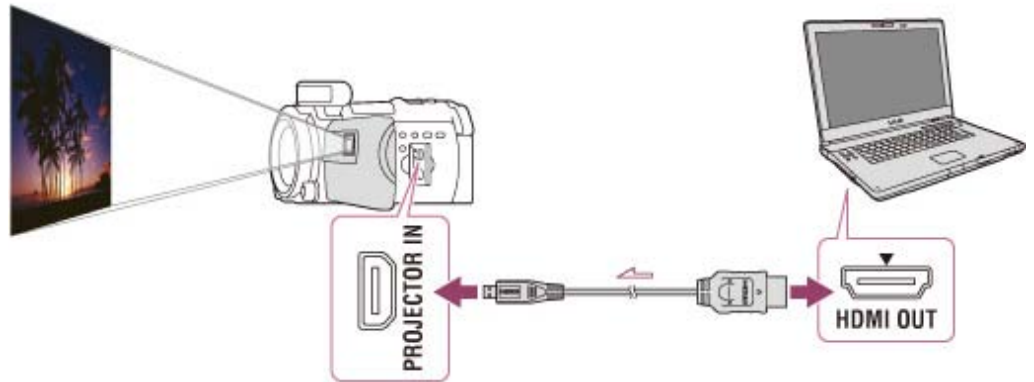

:Signal flow

1. Connect the PROJECTOR IN jack of the camcorder to an HDMI output jack of the other device using the HDMI cable (supplied).
2. Face the projector lens towards a surface, such as a wall, and then press PROJECTOR.
3. Select [Image from External Device] on the LCD screen.
4. Select [Project] on the LCD screen.



- This screen appears the first time you use the built-in projector after the camcorder is turned on.
5. Adjust the focus of the projected image using the PROJECTOR FOCUS lever.
    - The projected image is larger when the distance between your camcorder and the reflecting surface increase.
    - It is recommended that you place the camcorder further than 0.5 m (1.6 feet) away (approximate distance) from the surface that the images are to be projected onto.

### Notes

- If the terminal of the device connected is not compatible with the HDMI cable (supplied), use an HDMI plug adaptor (sold separately).
- You can only operate the PROJECTOR FOCUS lever while projecting images.

### Related topics

[On an HDMI cable](#)

[▲ Back to top](#)



- ▶ Operation Search
- ▶ Before use
- ▶ Getting started
- ▶ Recording
- ▶ Playback
- ▶ **Playing images on a TV**
- ▶ Saving images with an external device
- ▶ Using the Wi-Fi function
- ▶ Customizing your camcorder
- ▶ Troubleshooting
- ▶ Maintenance and precautions

[→ Contents list](#)

## Connecting the camcorder to a high definition TV

When movies are recorded with high definition image quality (HD), they are played back in high definition image quality (HD) on a high definition TV.

If the TV does not have an HDMI input jack, use an AV Cable (sold separately). [\[Details\]](#)

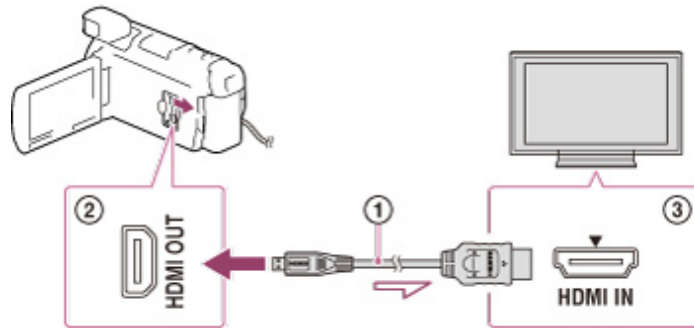

:Signal flow

1. Switch the input on the TV to the connected jack.
2. Connect the HDMI cable ( ① ); supplied) to the HDMI OUT jack ( ② ) on the camcorder and to the HDMI IN jack ( ③ ) on the TV.
3. Play a movie or a photo on the camcorder.

### On an HDMI cable

- Use an HDMI cable with the HDMI logo.
- Use an HDMI micro connector on one end (for the camcorder), and a plug suitable for connecting your TV on the other end.
- Copyright-protected images are not output from the HDMI OUT jack of your camcorder.
- Some TVs may not function correctly (e.g., no sound or image) with this connection.
- Do not connect the camcorder HDMI OUT jack to an external device HDMI OUT jack, as malfunction may result.
- HDMI (High-Definition Multimedia Interface) is an interface to send both video/audio signals. The HDMI OUT jack outputs high quality images and digital audio.

#### Notes

- Refer to the instruction manuals of the TV as well.
- Use the supplied AC Adaptor as the power source. [\[Details\]](#)
- When movies are recorded with standard image quality (STD), they are played back in standard definition image quality (STD) even on a high definition TV.

[▲ Back to top](#)

- ▶ Operation Search
- ▶ Before use
- ▶ Getting started
- ▶ Recording
- ▶ Playback
- ▶ Playing images on a TV
- ▶ Saving images with an external device
- ▶ Using the Wi-Fi function
- ▶ Customizing your camcorder
- ▶ Troubleshooting
- ▶ Maintenance and precautions

[→ Contents list](#)

## Connecting the camcorder to a non-high-definition TV

When movies are recorded with high definition image quality (HD), they are played back in standard definition image quality (STD) on a non-high-definition TV. When movies are recorded with standard image quality (STD), they are played back in standard definition image quality (STD).

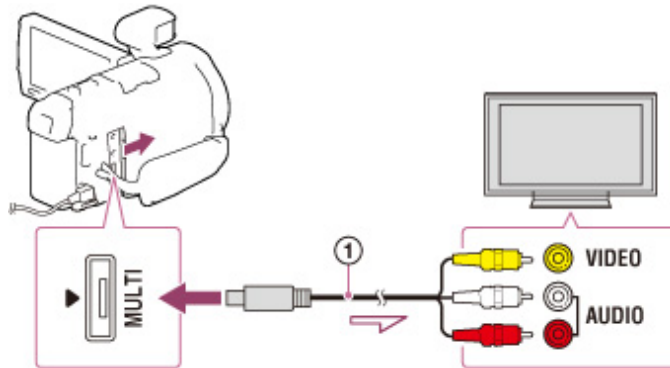

:Signal flow

1. Switch the input on the TV to the connected jack.
2. Connect your camcorder and the TV using an AV Cable ( ; sold separately).
3. Play a movie or a photo on the camcorder.

### Notes

- Refer to the instruction manuals of the TV as well.
- Use the supplied AC Adaptor as the power source. [\[Details\]](#)
- When you play back standard definition image quality (STD) movies on a 4:3 TV that is not compatible with the 16:9 signal, set [ Wide Mode] to [4:3] to record movies with 4:3 aspect ratio.
- If you connect your camcorder to the TV using more than one type of cable to output images, HDMI input takes priority on the TV.

### Related topics

[\[TV Type\]](#)

[▲ Back to top](#)

[Top page](#) > [Playing images on a TV](#) > [Playing images on a non-high-definition TV](#) > [Setting the aspect ratio according to the connected TV \(16:9/4:3\)](#)

- ▶ Operation Search
- ▶ Before use
- ▶ Getting started
- ▶ Recording
- ▶ Playback
- ▶ **Playing images on a TV**
- ▶ Saving images with an external device
- ▶ Using the Wi-Fi function
- ▶ Customizing your camcorder
- ▶ Troubleshooting
- ▶ Maintenance and precautions

[→ Contents list](#)

## Setting the aspect ratio according to the connected TV (16:9/4:3)

---

Set [TV Type] to [16:9] or [4:3] according to your TV.

---

### Related topics

[\[Wide Mode\]](#)

[▲ Back to top](#)

[Top page](#) > [Playing images on a TV](#) > [Playing images on a non-high-definition TV](#) > [When your TV is monaural \(When your TV has only one audio input jack\)](#)

- ▶ Operation Search
- ▶ Before use
- ▶ Getting started
- ▶ Recording
- ▶ Playback
- ▶ **Playing images on a TV**
- ▶ Saving images with an external device
- ▶ Using the Wi-Fi function
- ▶ Customizing your camcorder
- ▶ Troubleshooting
- ▶ Maintenance and precautions

[→ Contents list](#)

## **When your TV is monaural (When your TV has only one audio input jack)**

---

Connect the yellow plug of an AV Cable (sold separately) to the video input jack and connect the white (left channel) or red (right channel) plug to the audio input jack of your TV or VCR.

[▲ Back to top](#)

[Top page](#) > [Playing images on a TV](#) > [Playing images on a non-high-definition TV](#) > [Connecting the camcorder to a TV via a VCR](#)

▶ Operation Search

▶ Before use

▶ Getting started

▶ Recording

▶ Playback

▶ **Playing images on a TV**

▶ Saving images with an external device

▶ Using the Wi-Fi function

▶ Customizing your camcorder

▶ Troubleshooting

▶ Maintenance and precautions

[→ Contents list](#)

## Connecting the camcorder to a TV via a VCR

---

Connect your camcorder to the LINE IN input on the VCR using an AV Cable (sold separately). Set the input selector on the VCR to LINE (VIDEO 1, VIDEO 2, etc.).

[▲ Back to top](#)

[Top page](#) > [Playing images on a TV](#) > [Playing images on a TV supporting 5.1ch surround sound](#) > [Enjoying 5.1ch surround sound](#)

▶ Operation Search

▶ Before use

▶ Getting started

▶ Recording

▶ Playback

▶ **Playing images on a TV**

▶ Saving images with an external device

▶ Using the Wi-Fi function

▶ Customizing your camcorder

▶ Troubleshooting

▶ Maintenance and precautions

[→ Contents list](#)

## Enjoying 5.1ch surround sound

You can record Dolby Digital 5.1ch surround sound with the built-in microphone. Realistic sound can be enjoyed when playing a movie on devices that support 5.1ch surround sound input.

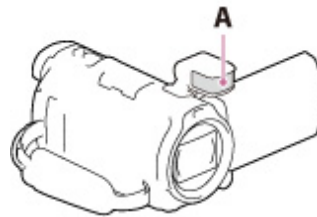

A: Built-in microphone

### Notes

- The sound of MP4 movies is recorded in 2ch sound.
- The built-in speaker does not output 5.1ch surround sound even if you play back a movie recorded with 5.1ch surround sound on your camcorder.
- To enjoy the 5.1ch surround sound of the movies recorded with high definition image quality (HD) in 5.1ch sound, you need a device compatible with 5.1ch surround.
- When you connect your camcorder with the supplied HDMI cable, the sound of high definition image quality (HD) movies recorded in 5.1ch sound is automatically output in 5.1ch sound. The sound of standard definition image quality (STD) movies is converted to 2ch.

### Related topics

[\[Audio Mode\]](#)

[▲ Back to top](#)



▶ Operation Search

▶ Before use

▶ Getting started

▶ Recording

▶ Playback

▶ **Playing images on a TV**

▶ Saving images with an external device

▶ Using the Wi-Fi function

▶ Customizing your camcorder

▶ Troubleshooting

▶ Maintenance and precautions

[➔ Contents list](#)

## Using "BRAVIA" Sync

You can operate your camcorder with the remote commander of your TV by connecting your camcorder to a "BRAVIA" Sync compatible TV launched in 2008 or later with the HDMI cable.

You can operate the menu of your camcorder by pressing the SYNC MENU button of the remote commander of your TV. You can display the camcorder screens such as Event View, play selected movies or display selected photos by pressing up/down/left/right/enter buttons of the remote commander of your TV.

### Notes

- There may be some operations you cannot do with the remote commander.
- Set [CTRL FOR HDMI] to [On].
- Also set your TV accordingly. Refer to the instruction manual of the TV for details.
- The operation of "BRAVIA" Sync differs according to each model of BRAVIA. Refer to the instruction manual of your TV for details.
- If you turn off the TV, your camcorder is turned off simultaneously.

[▲ Back to top](#)

- ▶ Operation Search
- ▶ Before use
- ▶ Getting started
- ▶ Recording
- ▶ Playback
- ▶ Playing images on a TV
- ▶ Saving images with an external device
- ▶ Using the Wi-Fi function
- ▶ Customizing your camcorder
- ▶ Troubleshooting
- ▶ Maintenance and precautions

[→ Contents list](#)

## Playing images on a computer

The "PlayMemories Home" software allows you to import movies and still images to your computer to use them in a variety of ways.

### What you can do with "PlayMemories Home" software (Windows)

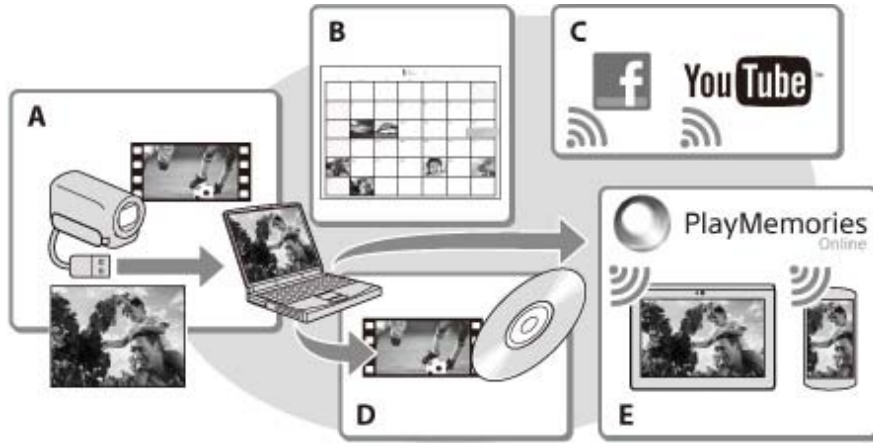

**A:** Import images from the camcorder / **B:** View images in a calendar / **C:** Upload images to online services / **D:** Create a movie disc / **E:** Share images in "PlayMemories Online"

"PlayMemories Home" can be downloaded from the following URL.

[www.sony.net/pm](http://www.sony.net/pm)

#### Notes

- An Internet connection is required to install "PlayMemories Home."
- An Internet connection is required to use "PlayMemories Online" and other online services. The services may not be available in some countries/regions.

### Software for Mac

The "PlayMemories Home" software is not supported with Mac. To import images from the camcorder to your Mac and play them, use the appropriate software on your Mac. For details, visit the following URL.

<http://www.sony.co.jp/imsoft/Mac/>

[▲ Back to top](#)

- ▶ Operation Search
- ▶ Before use
- ▶ Getting started
- ▶ Recording
- ▶ Playback
- ▶ Playing images on a TV
- ▶ Saving images with an external device
- ▶ Using the Wi-Fi function
- ▶ Customizing your camcorder
- ▶ Troubleshooting
- ▶ Maintenance and precautions

[→ Contents list](#)

## Checking the computer system

<b>OS*1</b>
Microsoft Windows XP SP3*2/Windows Vista SP2*3/Windows 7 SP1/Windows 8
<b>CPU*4</b>
Intel Core Duo 1.66 GHz or faster, or Intel Core 2 Duo 1.66 GHz or faster (Intel Core 2 Duo 2.26 GHz or faster is required when processing FX or FH movies, and Intel Core 2 Duo 2.40 GHz or faster is required when processing PS movies.)
<b>Memory</b>
Windows XP: 512 MB or more (1 GB or more is recommended) Windows Vista/ Windows 7/Windows 8: 1 GB or more
<b>Hard disk</b>
Disk volume required for installation: Approximately 500 MB
<b>Display</b>
Minimum 1,024 × 768 dots

- \*1 Standard installation is required. Operation is not assured if the OS has been upgraded or in a multi-boot environment.
- \*2 64-bit editions and Starter (Edition) are not supported. Windows Image Mastering API (IMAPI) Ver.2.0 or newer is required to use disc creation function, etc.
- \*3 Starter (Edition) is not supported.
- \*4 Faster processor is recommended.

### Notes

- Operation with all computer environments is not assured.

[▲ Back to top](#)

- ▶ Operation Search
- ▶ Before use
- ▶ Getting started
- ▶ Recording
- ▶ Playback
- ▶ Playing images on a TV
- ▶ Saving images with an external device
- ▶ Using the Wi-Fi function
- ▶ Customizing your camcorder
- ▶ Troubleshooting
- ▶ Maintenance and precautions

[→ Contents list](#)

## Installing the "PlayMemories Home" software in your computer

1. Access the following download site using an Internet browser on your computer, then click [Install] → [Run].  
[www.sony.net/pm](http://www.sony.net/pm)
2. Install according to the on-screen instructions.
  - When the on-screen instructions prompting you to connect the camcorder to a computer appear, connect the camcorder to your computer with the Built-in USB Cable.

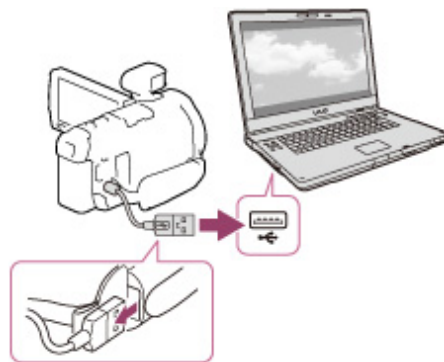

- When the installation completes, "PlayMemories Home" starts up.

### Notes on installation

- If the "PlayMemories Home" software is already installed on your computer, connect the camcorder to your computer. Functions that can be used with this camcorder will then be available.
- If the "PMB (Picture Motion Browser)" software is installed on your computer, it will be overwritten by the "PlayMemories Home" software. In this case, you cannot use some functions that were available with "PMB" with this "PlayMemories Home" software.

### Notes

- When you access the camcorder from the computer, use the "PlayMemories Home" software. Operation is not guaranteed if you operate the data using software other than the "PlayMemories Home" software or you directly manipulate files and the folders from a computer.
- Images cannot be saved to some discs depending on the configuration selected in [ REC Mode]. Movies recorded in [60p Quality ] (models with the NTSC color system) / [50p Quality ] (models with the PAL color system) or [Highest Quality ] mode can only be saved to a Blu-ray disc.
- You cannot create a disc with movies recorded in [ MP4] mode.
- The camcorder automatically divides an image file that exceeds 2 GB and saves the parts as separate files. All image files may be shown as separate files on a computer, however, the files will be handled properly by the import function and the playback function of the camcorder or the "PlayMemories Home" software.

[▲ Back to top](#)

[Top page](#) > [Saving images with an external device](#) > [Using the "PlayMemories Home" software](#) > [Disconnecting your camcorder from the computer](#)

▶ Operation Search

▶ Before use

▶ Getting started

▶ Recording

▶ Playback

▶ Playing images on a TV

▶ Saving images with an external device

▶ Using the Wi-Fi function

▶ Customizing your camcorder

▶ Troubleshooting



▶ Maintenance and precautions

[→ Contents list](#)

## Disconnecting your camcorder from the computer

1. Click the  icon at the bottom right of the desktop of the computer → [Safely remove USB Mass Storage Device].



2. Select  → [Yes] on the camcorder screen.
3. Disconnect the USB cable.
  - If you are using Windows 7 or Windows 8, click , then click .

[▲ Back to top](#)

- ▶ Operation Search
- ▶ Before use
- ▶ Getting started
- ▶ Recording
- ▶ Playback
- ▶ Playing images on a TV
- ▶ Saving images with an external device
- ▶ Using the Wi-Fi function
- ▶ Customizing your camcorder
- ▶ Troubleshooting
- ▶ Maintenance and precautions

[→ Contents list](#)

[Top page](#) > [Saving images with an external device](#) > [Using the "PlayMemories Home" software](#) > [The devices on which the created disc can be played back](#)

## The devices on which the created disc can be played back

### Blu-ray discs

Blu-ray disc player such as a Sony Blu-ray disc player or PlayStation®3

### DVD disc with high definition image quality (HD)

AVCHD format playback devices, such as a Sony Blu-ray disc player or a PlayStation®3

#### Notes

- The AVCHD recording disc can be played back only on AVCHD format compatible devices.
- Discs with high definition image quality (HD) images recorded should not be used in DVD players/recorders. Because DVD players/recorders are not compatible with the AVCHD format, DVD players/recorders may fail to eject the disc.
- Always keep your PlayStation®3 upgraded to the latest version of its system software. The PlayStation®3 may not be available in some countries/regions.

### To create a Blu-ray disc

You can create a Blu-ray disc with a high definition image quality (HD) movie previously imported to a computer.

To create a Blu-ray disc, the "BD Add-on Software" must be installed.

<http://support.d-imaging.sony.co.jp/BDUW/>

- Your computer must support the creation of Blu-ray discs.
- BD-R (unrewritable) and BD-RE (rewritable) media are available for creating Blu-ray discs. You cannot add contents to either type of disc after creating the disc.
- To play back a Blu-ray disc that has been created with a movie that was recorded in [60p Quality **PS**] (models with the NTSC color system) / [50p Quality **PS**] (models with the PAL color system) image quality, you need a device that complies with the AVCHD Ver. 2.0 format.

[▲ Back to top](#)

[Top page](#) > [Saving images with an external device](#) > [Using the "PlayMemories Home" software](#) > [Starting the "PlayMemories Home" software](#)

- ▶ Operation Search
- ▶ Before use
- ▶ Getting started
- ▶ Recording
- ▶ Playback
- ▶ Playing images on a TV
- ▶ Saving images with an external device
- ▶ Using the Wi-Fi function
- ▶ Customizing your camcorder
- ▶ Troubleshooting
- ▶ Maintenance and precautions

[→ Contents list](#)

## Starting the "PlayMemories Home" software

---

1. Double-click the "PlayMemories Home" icon on the computer screen.  
The "PlayMemories Home" software starts up.



- When using Windows 8, select the "PlayMemories Home" icon from the start screen.

2. Double-click the "PlayMemories Home Help Guide" short-cut icon on the computer screen to see how to use "PlayMemories Home."



- When using Windows 8, select [PlayMemories Home Help Guide] from the help menu of "PlayMemories Home."
- If the icon is not displayed on the computer screen, click [Start] → [All Programs] → [PlayMemories Home] → the desired item.
- For details on "PlayMemories Home," select  ("PlayMemories Home Help Guide") on the software or visit the PlayMemories Home support page (<http://www.sony.co.jp/pmh-se/>).

[▲ Back to top](#)

[Top page](#) > [Saving images with an external device](#) > [Using the "PlayMemories Home" software](#) > [Downloading the dedicated software for the camcorder](#)

- ▶ [Operation Search](#)
- ▶ [Before use](#)
- ▶ [Getting started](#)
- ▶ [Recording](#)
- ▶ [Playback](#)
- ▶ [Playing images on a TV](#)
- ▶ [Saving images with an external device](#)
- ▶ [Using the Wi-Fi function](#)
- ▶ [Customizing your camcorder](#)
- ▶ [Troubleshooting](#)
- ▶ [Maintenance and precautions](#)

[→ Contents list](#)

## Downloading the dedicated software for the camcorder

---

You can install the dedicated software for the camcorder from the following URL.

For Windows: <http://www.sony.co.jp/imsoft/Win/>

For Mac: <http://www.sony.co.jp/imsoft/Mac/>

### ■ Main software

#### Music Transfer (for models with a USB input function)

Music Transfer allows you to change the music files that have been supplied with your camcorder to suit your tastes, or to delete or add music files.

Furthermore, this software can restore the music files that were supplied with your camcorder.

#### Notes

- The software that can be used with your camcorder will differ, depending on the countries/regions.

---

#### Related topics

Information on your camcorder model: [Model Information](#)

[▲ Back to top](#)



- ▶ Operation Search
- ▶ Before use
- ▶ Getting started
- ▶ Recording
- ▶ Playback
- ▶ Playing images on a TV
- ▶ Saving images with an external device
- ▶ Using the Wi-Fi function
- ▶ Customizing your camcorder
- ▶ Troubleshooting
- ▶ Maintenance and precautions

[→ Contents list](#)

## Saving images on an external media device easily

You can save movies and photos on an external media device (USB storage devices), such as an external hard disk drive. The following functions will be available after you have saved your images on an external media device.

- You can connect your camcorder and the external media device, and then play back images stored on the external media device.
- You can connect your computer and the external media device and import images to your computer using the "PlayMemories Home" software.

### Notes

- For this operation, you need the USB Adaptor Cable VMC-UAM2 (sold separately).
- Connect the AC Adaptor and the power cord (mains lead) to the DC IN jack of your camcorder and the wall outlet (wall socket).
- Refer to the instruction manual supplied with the external media device.

1. Connect your camcorder and the external media device using the USB Adaptor Cable (sold separately).

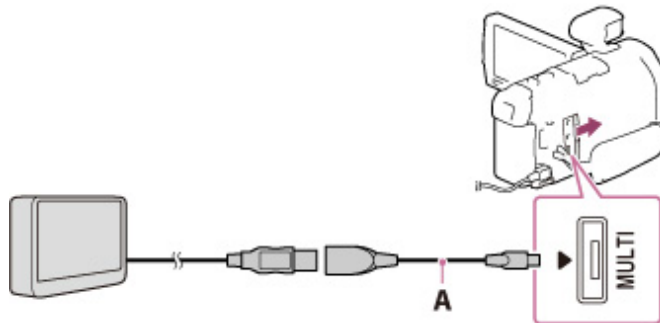

A: USB Adaptor Cable VMC-UAM2 (sold separately)

- Make sure not to disconnect the USB cable while [Preparing image database file. Please wait.] is displayed on the LCD screen.
- If [Repair Img. DB F.] is displayed on the camcorder screen, select OK.

2. Select [Copy.] on the camcorder screen.

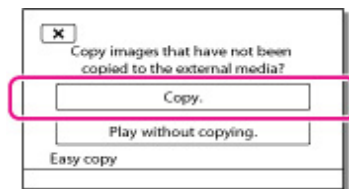

- Movies and photos that are stored on the recording media, and that have not yet been saved on to external media device can be saved on the connected media device at this time.
- This operation is available only when there are newly recorded images in your camcorder.
- To disconnect the external media device, select while the camcorder is in the playback standby mode (either Event View or Event Index is displayed).

## To delete images in the external media device

1. Select [Play without copying.] in step 2 above.
2. Select **MENU** → [Edit/Copy] → [Delete], and then follow the instructions that appear on the LCD screen to delete images.

#### Notes

- You may not be able to use external media devices with a code function.
- The FAT file system is available for your camcorder. If the storage medium of the external device was formatted for the NTFS file system, etc., format the external media device using the camcorder before use. The format screen appears when an external media device is connected to your camcorder. Before formatting, make sure that you have no important data saved on the external media device as formatting will delete the data.
- Operation is not guaranteed with all devices satisfying the operating requirements.
- For details on available external media devices, go to the Sony support website in your country/region.
- The number of scenes you can save on the external media device is as follows. However, even if the external media device has free space, you cannot save scenes exceeding the following number.
  - High definition image quality (HD) movies: Max. 3,999
  - Standard definition image quality (STD) movies: Max. 9,999
  - MP4 movies and photos: Max. 40,000 (both MP4 movies and photos)
- If your camcorder does not recognize the external media device, try the following operations.
  - Reconnect the USB Adaptor Cable to your camcorder.
  - If the external media device has the AC power cord (mains lead), connect it to the wall outlet (wall socket).
- The number of scenes may be smaller depending on the type of images recorded.
- You cannot copy images from an external media device to the internal recording medium on the camcorder.

[▲ Back to top](#)

Copyright 2013 Sony Corporation

- ▶ Operation Search
- ▶ Before use
- ▶ Getting started
- ▶ Recording
- ▶ Playback
- ▶ Playing images on a TV
- ▶ Saving images with an external device
- ▶ Using the Wi-Fi function
- ▶ Customizing your camcorder
- ▶ Troubleshooting
- ▶ Maintenance and precautions

[→ Contents list](#)

## Saving the desired images in the camcorder to the external media device

You can save desired images in the camcorder to the external media device.

### Notes

- For this operation, you need the USB Adaptor Cable VMC-UAM2 (sold separately).
- Connect the AC Adaptor and the power cord (mains lead) to the DC IN jack of your camcorder and the wall outlet (wall socket).
- Refer to the instruction manual supplied with the external media device.

1. Connect your camcorder and the external media device using the USB Adaptor Cable (sold separately).

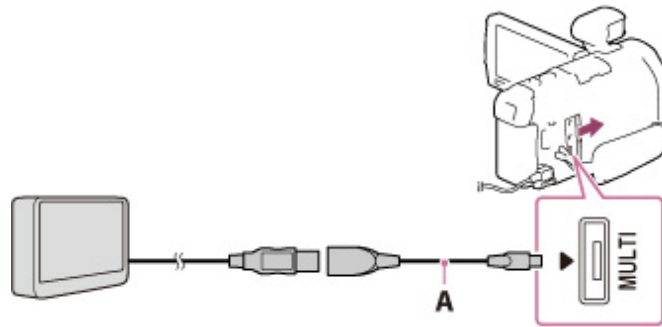

**A:** USB Adaptor Cable VMC-UAM2 (sold separately)

- Make sure not to disconnect the USB cable while [Preparing image database file. Please wait.] is displayed on the LCD screen.
  - If [Repair Img. DB F.] is displayed on the camcorder screen, select .
2. Select [Play without copying.].
  3. Select  → [Edit/Copy] → [Copy], and then follow the instructions that appear on the LCD screen to save images.
    - If you want to copy images that have not yet been copied, select  → [Edit/Copy] → [Direct Copy] while your camcorder is connected to the external media device.

[▲ Back to top](#)

[Top page](#) > [Saving images with an external device](#) > [Saving images on an external media device](#) > [Playing back images in the external media device on the camcorder](#)

- ▶ Operation Search
- ▶ Before use
- ▶ Getting started
- ▶ Recording
- ▶ Playback
- ▶ Playing images on a TV
- ▶ Saving images with an external device
- ▶ Using the Wi-Fi function
- ▶ Customizing your camcorder
- ▶ Troubleshooting
- ▶ Maintenance and precautions

[→ Contents list](#)

## Playing back images in the external media device on the camcorder

### Notes

- For this operation, you need the USB Adaptor Cable VMC-UAM2 (sold separately).
- Connect the AC Adaptor and the power cord (mains lead) to the DC IN jack of your camcorder and the wall outlet (wall socket).
- Refer to the instruction manual supplied with the external media device.

1. Connect your camcorder and the external media device using the USB Adaptor Cable (sold separately).

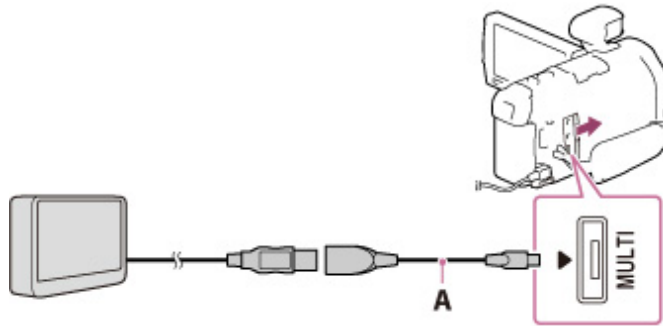

A: USB Adaptor Cable VMC-UAM2 (sold separately)

2. Select [Play without copying.] and select the image you want to view.
  - You can also view images on a TV connected to your camcorder.
  - When an external media device is connected, will appear on the Event View screen.

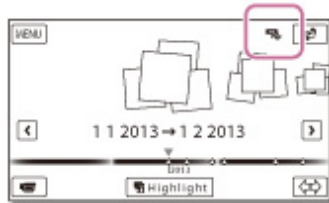

### To play back high definition image quality (HD) movies on your computer

On the "PlayMemories Home" software, select the drive that represents the external media device connected, and then play movies.

[▲ Back to top](#)

[Top page](#) > [Saving images with an external device](#) > [Saving images on an external media device](#) > [Devices that cannot be used as an external media device](#)

▶ Operation Search

▶ Before use

▶ Getting started

▶ Recording

▶ Playback

▶ Playing images on a TV

▶ Saving images with an external device

▶ Using the Wi-Fi function

▶ Customizing your camcorder

▶ Troubleshooting

▶ Maintenance and precautions

[→ Contents list](#)

## Devices that cannot be used as an external media device

---

The following devices cannot be used as an external media device:

- media devices with a capacity exceeding 2 TB
- ordinary disc drive such as CD or DVD drive
- media devices connected via a USB hub
- media devices with built-in USB hub
- card reader

[▲ Back to top](#)

- ▶ Operation Search
- ▶ Before use
- ▶ Getting started
- ▶ Recording
- ▶ Playback
- ▶ Playing images on a TV
- ▶ Saving images with an external device
- ▶ Using the Wi-Fi function
- ▶ Customizing your camcorder
- ▶ Troubleshooting
- ▶ Maintenance and precautions

[→ Contents list](#)

## Creating a standard definition image quality (STD) disc with a recorder

Connect your camcorder to a disc recorder with an AV Cable (sold separately). You can copy images played back on your camcorder on a disc or video cassette.

1. Insert the recording medium in the recording device (a disc recorder, etc.).
  - If your recording device has an input selector, set it to the input mode.
2. Connect your camcorder to the recording device with an AV Cable (sold separately).

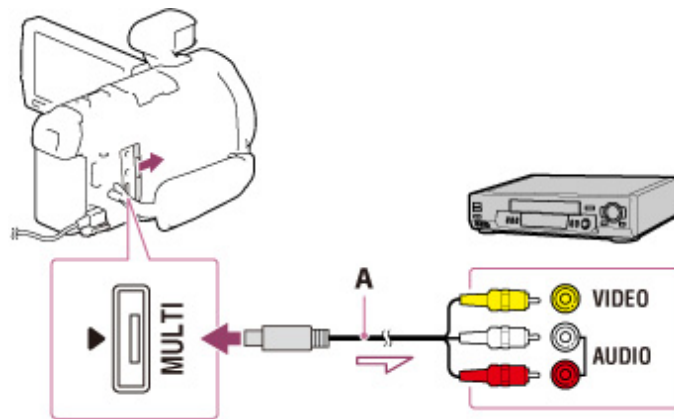

A: AV Cable (sold separately)

: Signal flow

- Connect your camcorder to the input jacks of the recording device.
3. Start playback on your camcorder, and record it on the recording device.
  4. When dubbing is finished, stop the recording device, and then your camcorder.

### Notes

- Connect your camcorder to the wall outlet (wall socket) using the supplied AC Adaptor for this operation.
- Refer to the instruction manual supplied with the device connected.
- You cannot copy images to recorders connected with an HDMI cable.
- Since copying is performed via analog data transfer, the image quality may deteriorate.
- High definition image quality (HD) movies will be copied with standard definition image quality (STD).
- When you connect a monaural device, connect the yellow plug of an AV Cable (sold separately) to the video input jack, and the white (left channel) or the red (right channel) plug to the audio input jack on the device.

### Related topics

Copying date and time information: [\[Data Code\]](#)

Using 4:3 screen size display device: [\[TV Type\]](#)

[▲ Back to top](#)

▶ Operation Search

▶ Before use

▶ Getting started

▶ Recording

▶ Playback

▶ Playing images on a TV

▶ Saving images with an external device

▶ Using the Wi-Fi function

▶ Customizing your camcorder

▶ Troubleshooting

▶ Maintenance and precautions

[→ Contents list](#)

## Using the Wi-Fi function

Attaching the wireless adaptor ADP-WL1M (sold separately) to the camcorder allows you to use the Wi-Fi function.

### Notes

- The wireless adaptor ADP-WL1M (sold separately) may not be available in some countries/regions.
- You cannot use the Wi-Fi function of your camcorder to connect with public wireless network using the wireless adaptor.
- Use the Wi-Fi function in accordance with regulations that apply in the place where you use the camcorder. In situations where use of Wi-Fi is prohibited, such as during airplane takeoff and landing, select **MENU** → [Setup] → [ General Settings] → [Airplane Mode] → [On].
- The Wi-Fi connection may be lost suddenly depending on your network environment. In addition, loss of Wi-Fi connection may cause recording to stop automatically.

### Related topics

[Attaching the wireless adaptor](#)

[▲ Back to top](#)

- ▶ Operation Search
- ▶ Before use
- ▶ Getting started
- ▶ Recording
- ▶ Playback
- ▶ Playing images on a TV
- ▶ Saving images with an external device
- ▶ Using the Wi-Fi function
- ▶ Customizing your camcorder
- ▶ Troubleshooting
- ▶ Maintenance and precautions

[→ Contents list](#)

## Attaching the wireless adaptor

Open the Multi interface shoe cover on the camcorder. Align the wireless adaptor ADP-WL1M (sold separately) with the Multi interface shoe (1), then attach it to the camcorder by pressing and sliding forward (2).



### To remove the wireless adaptor

Remove the wireless adaptor by sliding backward while pressing down.

[▲ Back to top](#)



[Top page](#) > [Using the Wi-Fi function](#) > [What you can do with the Wi-Fi function](#) > [What you can do with the Wi-Fi function](#)

## What you can do with the Wi-Fi function

Attaching the wireless adaptor ADP-WL1M (sold separately) to the camcorder, following functions are available.

### Saving movies and photos to your computer

A computer connected to an access point is required.

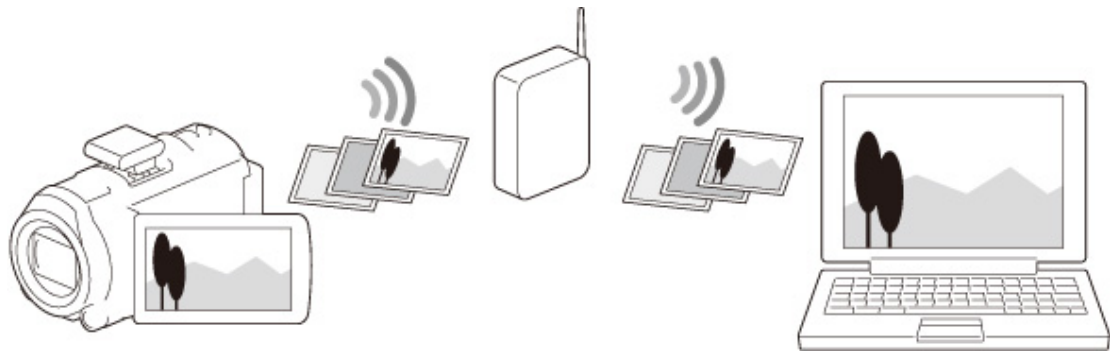

### Transferring movies (MP4) and photos to your smartphone or tablet

A smartphone or tablet is required.

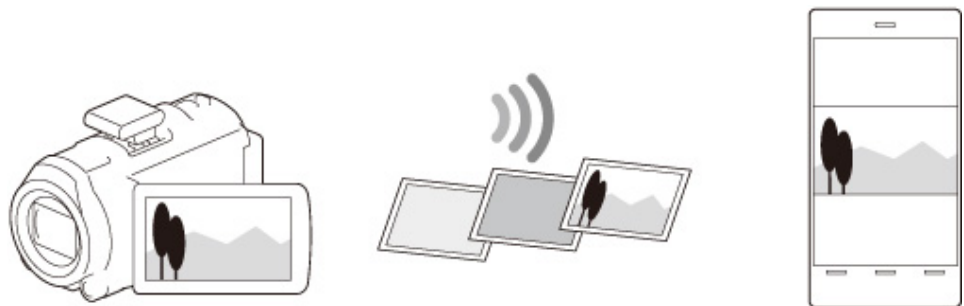

### Using your smartphone or tablet as a wireless remote commander

A smartphone or tablet is required.

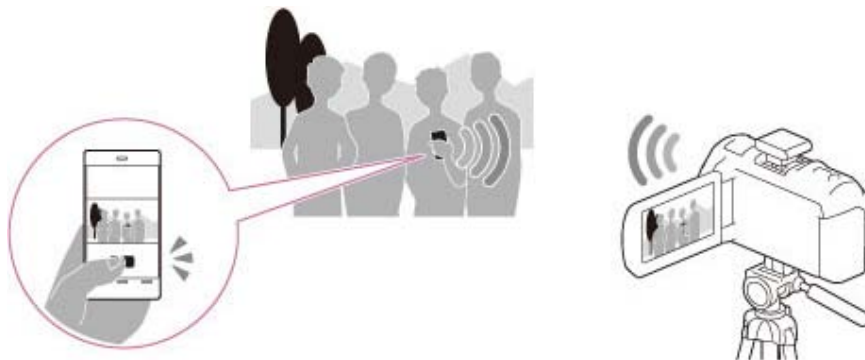

- ▶ Operation Search
- ▶ Before use
- ▶ Getting started
- ▶ Recording
- ▶ Playback
- ▶ Playing images on a TV
- ▶ Saving images with an external device
- ▶ Using the Wi-Fi function
- ▶ Customizing your camcorder
- ▶ Troubleshooting
- ▶ Maintenance and precautions

[→ Contents list](#)

---

**Related topics**

[Ctrl with Smartphone](#)

[Send to Smartphone](#)

[Send to Computer](#)

[▲ Back to top](#)

---

Copyright 2013 Sony Corporation

- ▶ Operation Search
- ▶ Before use
- ▶ Getting started
- ▶ Recording
- ▶ Playback
- ▶ Playing images on a TV
- ▶ Saving images with an external device
- ▶ Using the Wi-Fi function
- ▶ Customizing your camcorder
- ▶ Troubleshooting
- ▶ Maintenance and precautions

[→ Contents list](#)

## Ctrl with Smartphone

You can operate the camcorder using your smartphone or tablet as a wireless remote commander.

1. Install "PlayMemories Mobile" on your smartphone.
  - If "PlayMemories Mobile" is already installed in your smartphone, update the software to the latest version.



- For the latest supported OS, refer to the download page of "PlayMemories Mobile."
- This application is not guaranteed to work on all smartphones and tablets.

2. On the camcorder LCD screen, select **MENU** → [Camera/Mic] → [ Shooting Assist] → [Ctrl with Smartphone].



3. Confirm that the SSID and a password are displayed on the camcorder LCD screen.



- A:** SSID
- B:** Password

4. On your smartphone, select the SSID displayed on the camcorder LCD screen, and then enter the password displayed on the camcorder LCD screen.
  - Connect to the camcorder using your smartphone.
5. Operate the camcorder using your smartphone.

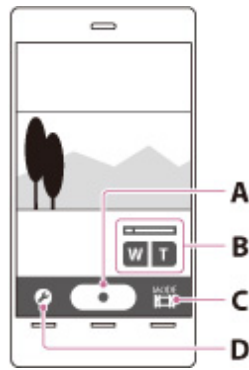

- A: START/STOP button (🎬 (Movie) mode) / PHOTO button (📷 (Photo) mode)
- B: Zoom button (W: Wide angle / T: Telephoto)
- C: 🎬 (Movie) / 📷 (Photo) mode switching button
- D: Setting button (⚙️ (Photo) mode only)

- You can also perform the zoom operation with the zoom lever on your smartphone.

### Functions that can be set with the setting button

Flash:	Select [Off], [On] or [Auto].
Self-Timer:	Select [Off] or [10sec].
Review Check:	Select [Off], [Review Only] or [Review, Save Image]. When you select [Review, Save Image], you can store still images to your smartphone.

#### Notes

- The photo size stored on the smartphone is [2M].
- Movies are recorded on the camcorder and are not stored on the smartphone.
- If the distance between the camcorder and smartphone is too far, a connection may not be established. Connect the camcorder and smartphone within 5 m.
- The operation methods and display screens for the application are subject to change without notice by future upgrades.

### To connect an Android smartphone to the camcorder

1. Start up "PlayMemories Mobile" on the smartphone.

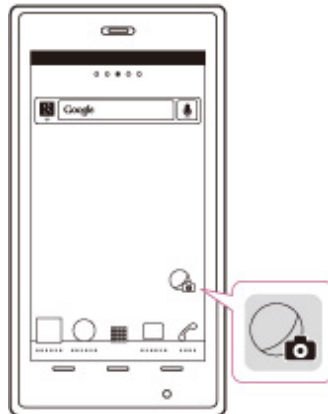

2. Select the SSID displayed on the camcorder.



3. Enter the password displayed on the camcorder.

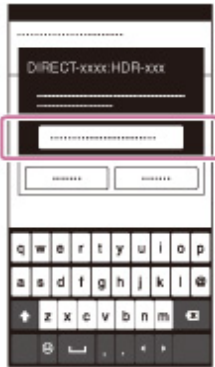

## To connect an iOS smartphone to the camcorder

1. Open the settings menu.

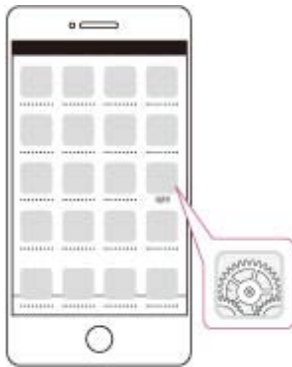

2. Select Wi-Fi.

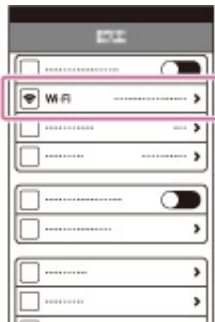

3. Select the SSID displayed on the camcorder.



4. Enter the password displayed on the camcorder.



5. Confirm that the SSID displayed on the camcorder is selected.



6. Start up "PlayMemories Mobile."

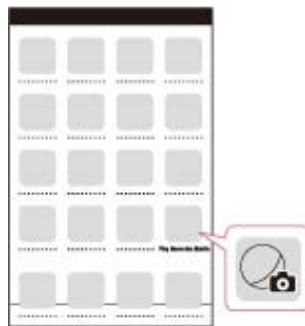

- ▶ Operation Search
- ▶ Before use
- ▶ Getting started
- ▶ Recording
- ▶ Playback
- ▶ Playing images on a TV
- ▶ Saving images with an external device
- ▶ Using the Wi-Fi function
- ▶ Customizing your camcorder
- ▶ Troubleshooting
- ▶ Maintenance and precautions

[→ Contents list](#)

## Send to Smartphone

You can transfer movies (MP4) and photos to your smartphone or tablet.

1. Install "PlayMemories Mobile" on your smartphone.
  - If "PlayMemories Mobile" is already installed in your smartphone, update the software to the latest version.



- For the latest supported OS, refer to the download page of "PlayMemories Mobile."
- This application is not guaranteed to work on all smartphones and tablets.

2. Press the button on the camcorder to enter the playback mode.

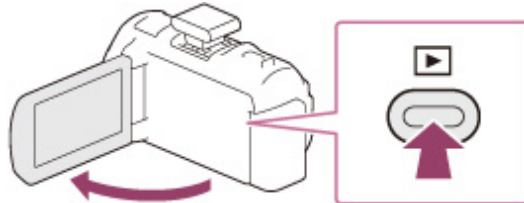

3. On the camcorder LCD screen, select **MENU** → [Edit/Copy] → [Send to Smartphone] → [Select on This Device].



4. Select the type of image you want to transfer.



5. Select the image you want to transfer, and add mark, and then select **OK** → **OK**.



6. Confirm that the SSID and a password are displayed on the camcorder LCD screen.



- A: SSID  
B: Password

7. On your smartphone, select the SSID displayed on the camcorder LCD screen, and then enter the password displayed on the camcorder LCD screen.
  - A connection is established between the smartphone and camcorder, and images are transferred from the camcorder to the smartphone.

## To select images to transfer using a smartphone

1. Perform the procedures in step 3 of “Send to Smartphone,” and then select **MENU** → [Edit/Copy] → [Send to Smartphone] → [Select on Smartphone].



2. On your smartphone, select the SSID displayed on the camcorder LCD screen, and then enter the password displayed on the camcorder LCD screen.
  - A connection is established between the smartphone and camcorder.
3. On your smartphone, select the image you want to transfer, and then select [Copy] or [Upload].
  - The images are transferred from the camcorder to the smartphone.

### Notes

- [Send to Smartphone] is not available when [HDMI/MP4/STD Setting] is not set to [MP4 MP4].
- [Send to Smartphone] is not available when MP4 movies or still images have not been saved on the camcorder.
- If you want to import images recorded on a memory card, insert the memory card to the camcorder, and then select the memory card in [Media Select].
- If the distance between the camcorder and smartphone is too far, a connection may not be established. Connect the camcorder and smartphone within 5 m.

## To connect an Android smartphone to the camcorder

1. Start up “PlayMemories Mobile” on the smartphone.





2. Select the SSID displayed on the camcorder.



3. Enter the password displayed on the camcorder.



### To connect an iOS smartphone to the camcorder

1. Open the settings menu.

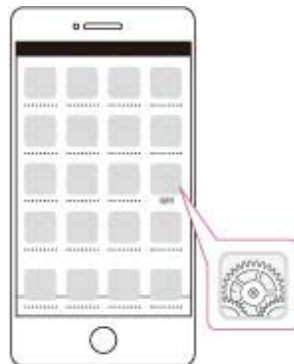

2. Select Wi-Fi.

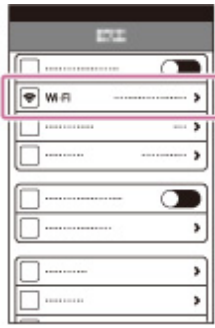

3. Select the SSID displayed on the camcorder.



4. Enter the password displayed on the camcorder.



5. Confirm that the SSID displayed on the camcorder is selected.



6. Start up "PlayMemories Mobile."

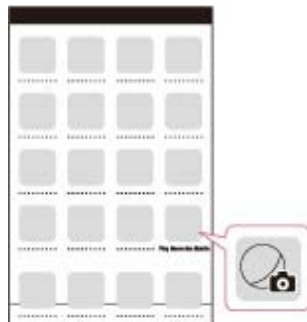



- ▶ Operation Search
- ▶ Before use
- ▶ Getting started
- ▶ Recording
- ▶ Playback
- ▶ Playing images on a TV
- ▶ Saving images with an external device
- ▶ Using the Wi-Fi function
- ▶ Customizing your camcorder
- ▶ Troubleshooting
- ▶ Maintenance and precautions

[→ Contents list](#)

## Send to Computer

You can save movies and photos to your computer.

1. Install the software on your computer.  
 For Windows: PlayMemories Home  
[www.sony.net/pm](http://www.sony.net/pm)  
 For Mac: Wireless Auto Import  
<http://www.sony.co.jp/imsoft/Mac/>
  - If connecting the camcorder to your computer for the first time after installing the software, set [USB Connect Setting] to [Auto] or [MTP] on the camcorder, and then connect the camcorder to your computer with the Built-in USB Cable.
  - If "PlayMemories Home" is already installed in your computer, update the software to the latest version.
2. Connect the camcorder to the wireless network access point.
  - If your access point does not support the WPS push button, refer to "[Access point settings.](#)" [\[Details\]](#)
  - If your access point supports the WPS push button, refer to "[WPS Push.](#)" [\[Details\]](#)
  - Settings for steps 1 and 2 are required only the first time.
3. Press the  button on the camcorder to enter the playback mode.

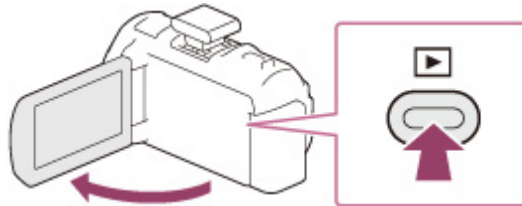

4. On the camcorder LCD screen, select **MENU** → [Edit/Copy] → [Send to Computer].



- Images are automatically transferred to and saved on the computer.
- Only newly recorded images are transferred.

### Notes

- You must turn on the computer to execute [Send to Computer].
- Depending on the settings of the application on the computer, the camcorder may turn off automatically after saving images.
- If you want to import images recorded on a memory card, insert the memory card to the camcorder, and then select the memory card in [Media Select].
- Importing movies and multiple still images may take time.



- ▶ Operation Search
- ▶ Before use
- ▶ Getting started
- ▶ Recording
- ▶ Playback
- ▶ Playing images on a TV
- ▶ Saving images with an external device
- ▶ Using the Wi-Fi function
- ▶ Customizing your camcorder
- ▶ Troubleshooting
- ▶ Maintenance and precautions

[→ Contents list](#)

## WPS Push

If your access point has a WPS button, you can register the access point to the camcorder easily.

1. Select **MENU** → [Setup] → [ Connection] → [WPS Push].
2. Press the WPS button on the access point you want to register.

### Notes

- [WPS Push] requires that the security of the access point be WPA or WPA2 and that the WPS push button method is supported. If the security of your access point is set to WEP and your access point does not support the WPS push button method, register the access point manually. [\[Details\]](#)
- For details on the supported functions and settings for your access point, refer to the manual of your access point or contact the administrator of your access point.
- Depending on the surrounding conditions such as obstacles between the camcorder and access point, signal condition and the materials of the wall, etc., connections may not be established or the communication distance may be shorter. Move the camcorder or decrease the distance between the camcorder and the access point.

[▲ Back to top](#)

- ▶ Operation Search
- ▶ Before use
- ▶ Getting started
- ▶ Recording
- ▶ Playback
- ▶ Playing images on a TV
- ▶ Saving images with an external device
- ▶ Using the Wi-Fi function
- ▶ Customizing your camcorder
- ▶ Troubleshooting
- ▶ Maintenance and precautions

[→ Contents list](#)

## Access point settings

You can register your access point manually.

1. Select **MENU** → [Setup] → [**↔**Connection] → [Access point settings].
2. Select the access point you want to register.

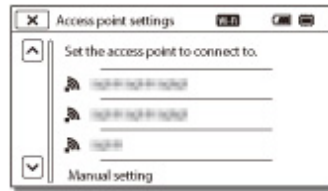

- If you want to enter and register the WPS PIN code, select [Manual setting] → [WPS PIN]. Within 2 minutes, enter the PIN code displayed on the camcorder to the access point.
- If the desired access point is not displayed, select [Manual setting] → [Manual regist.], enter the SSID name of the access point, and then select the encryption type.

3. Enter the password, and then select [Next] → [Register].







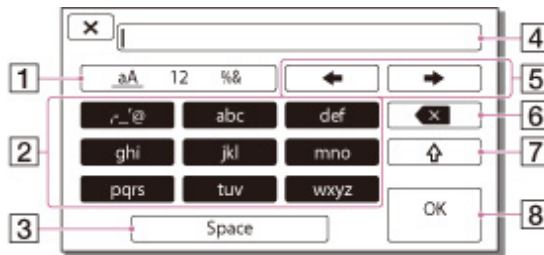

- Access points without the icon do not require a password to be entered.

## How to use the keyboard

A keyboard is displayed on the screen when text needs to be entered.



	Screen names	Functions
1	Switch character	Each time you touch the key, the type of character to be input switches between letters, numerals and symbols.

	types	
2	Keyboard	Each time you touch the key, the displayed character switches between the choices available. For example: If you want to enter "abd" Select  , touching it once to display "a" → touch  to move the cursor (5) → select  , touching it twice to display "b" → select  touching it once to display "d".
3	Space	Enters a space.
4	Input box	The characters you entered are displayed. If you try to input more characters than allowed,  is displayed on the screen.
5	Move cursor	Moves the cursor in the input box to the right or left.
6	Delete	Deletes the character preceding the cursor.
7		Switches the next character to a capital or small letter.
8	Fix	Finalizes the entry.

- To cancel text entry, select .

## Other setting items

Depending on the status or the setting method of your access point, there may be more setting items.

Setting items	Functions
WPS PIN	Displays the PIN to enter to the connected device.
IP address setting	Selects [Auto] or [Manual setting].
IP address	If you are entering the IP address manually, enter the fixed address.
Subnet mask/Default gateway	When you set [IP address setting] to [Manual setting], enter the IP address to match your network environment.
Priority Connection	Selects [On] or [Off].

### Notes

- To give the registered access point priority, set [Priority Connection] to [On].

[▲ Back to top](#)



▶ Operation Search

▶ Before use

▶ Getting started

▶ Recording

▶ Playback

▶ Playing images on a TV

▶ Saving images with an external device

▶ Using the Wi-Fi function

▶ Customizing your camcorder

▶ Troubleshooting

▶ Maintenance and precautions

[→ Contents list](#)

[Top page](#) > [Using the Wi-Fi function](#) > [Available menus with the wireless adaptor attached](#) > [Edit Device Name](#)

## Edit Device Name

---

You can change the device name for Wi-Fi Direct.

1. Select **MENU** → [Setup] → [**↔**Connection] → [Edit Device Name].
2. Select the input box, input the device name, and then select **OK**.
  - For input method, refer to "How to use the keyboard." [\[Details\]](#)

[▲ Back to top](#)

[Top page](#) > [Using the Wi-Fi function](#) > [Available menus with the wireless adaptor attached](#) > [Disp MAC Address](#)

▶ Operation Search

▶ Before use

▶ Getting started

▶ Recording

▶ Playback

▶ Playing images on a TV

▶ Saving images with an external device

▶ Using the Wi-Fi function

▶ Customizing your camcorder

▶ Troubleshooting

▶ Maintenance and precautions

[→ Contents list](#)

## Disp MAC Address

---

Display the MAC address of the wireless adaptor.

1. Select **MENU** → [Setup] → [ Connection] → [Disp MAC Address].
  - The MAC address is displayed.

[▲ Back to top](#)

[Top page](#) > [Using the Wi-Fi function](#) > [Available menus with the wireless adaptor attached](#) > [SSID/PW Reset](#)

- ▶ [Operation Search](#)
- ▶ [Before use](#)
- ▶ [Getting started](#)
- ▶ [Recording](#)
- ▶ [Playback](#)
- ▶ [Playing images on a TV](#)
- ▶ [Saving images with an external device](#)
- ▶ [Using the Wi-Fi function](#)
- ▶ [Customizing your camcorder](#)
- ▶ [Troubleshooting](#)
- ▶ [Maintenance and precautions](#)

[→ Contents list](#)

## SSID/PW Reset

---

The camcorder shares the SSID/password for [Send to Smartphone] and [Ctrl with Smartphone] with a device that has permission to connect. If you want to change the device that is permitted to connect to the camcorder, reset the SSID/password by the following procedure.

1. Select **MENU** → [Setup] → [[↔](#)Connection] → [SSID/PW Reset] → **OK**.

### Notes

- After resetting the SSID/password, you must set the smartphone again.

[▲ Back to top](#)

[Top page](#) > [Using the Wi-Fi function](#) > [Available menus with the wireless adaptor attached](#) > [Network Info Reset](#)

- ▶ [Operation Search](#)
- ▶ [Before use](#)
- ▶ [Getting started](#)
- ▶ [Recording](#)
- ▶ [Playback](#)
- ▶ [Playing images on a TV](#)
- ▶ [Saving images with an external device](#)
- ▶ [Using the Wi-Fi function](#)
- ▶ [Customizing your camcorder](#)
- ▶ [Troubleshooting](#)
- ▶ [Maintenance and precautions](#)

[→ Contents list](#)

## Network Info Reset

---

In addition to the SSID/password, you can also reset the information of the access point, etc. If you want to change the access point to connect to, reset the connection information by the following procedure.

1. Select **MENU** → [Setup] → [[↔](#)Connection] → [Network Info Reset] → **OK**.

### Notes

- After resetting the connection information, you must set the smartphone again.

[▲ Back to top](#)

[Top page](#) > [Using the Wi-Fi function](#) > [Available menus with the wireless adaptor attached](#) > [Airplane Mode](#)

- ▶ [Operation Search](#)
- ▶ [Before use](#)
- ▶ [Getting started](#)
- ▶ [Recording](#)
- ▶ [Playback](#)
- ▶ [Playing images on a TV](#)
- ▶ [Saving images with an external device](#)
- ▶ [Using the Wi-Fi function](#)
- ▶ [Customizing your camcorder](#)
- ▶ [Troubleshooting](#)
- ▶ [Maintenance and precautions](#)

[→ Contents list](#)

## Airplane Mode

---

When you board an airplane, you can deactivate the Wi-Fi function temporarily.

1. Select **MENU** → [Setup] → [ Connection] → [Airplane Mode] → [On].

### Notes

- When [Airplane Mode] is set to [On], the GPS function also is temporarily deactivated (models with GPS).

---

### Related topics

Information on your camcorder model: [Model Information](#)

[▲ Back to top](#)

▶ Operation Search

▶ Before use

▶ Getting started

▶ Recording

▶ Playback

▶ Playing images on a TV

▶ Saving images with an external device

▶ Using the Wi-Fi function

▶ Customizing your camcorder

▶ Troubleshooting

▶ Maintenance and precautions

[→ Contents list](#)

## Troubleshooting

---

### Functions are not displayed in the MENU screen.

- Check that the wireless adaptor ADP-WL1M (sold separately) is attached properly, select [Disp MAC Address] and check that a 12-digit number is displayed. If a 12-digit number is not displayed even though the wireless adaptor is attached properly, the camcorder or the wireless adaptor may be malfunctioning.

### The Wi-Fi function is not available.

- [Airplane Mode] is set to [On]. Set to [Off] to use the Wi-Fi function.







[▲ Back to top](#)

- ▶ Operation Search
- ▶ Before use
- ▶ Getting started
- ▶ Recording
- ▶ Playback
- ▶ Playing images on a TV
- ▶ Saving images with an external device
- ▶ Using the Wi-Fi function
- ▶ Customizing your camcorder
- ▶ Troubleshooting
- ▶ Maintenance and precautions

[→ Contents list](#)

## Setting up menu items

The camcorder has various menu items under each of 6 menu categories.

-  Shooting Mode (Items for selecting a shooting mode)
-  Camera/Mic (Items for customized shooting)
-  Image Quality/Size (Items for setting up image quality or size)
-  Playback Function (Items for playback)
-  Edit/Copy (Items for editing images such as copy or protect)
-  Setup (Other setup items)

1. Select **MENU**.



2. Select a category.

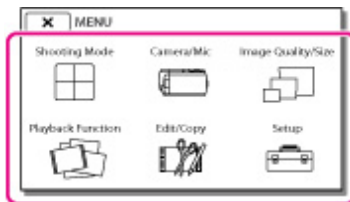

3. Select your desired menu item.

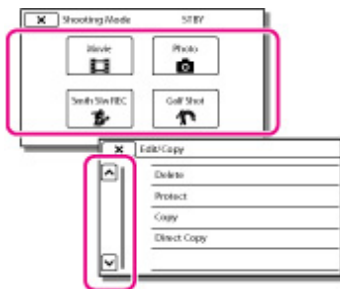

### Notes

- Select  to finish setting the menu or to return to the previous screen.

### To find a menu item quickly

The [Camera/Mic] and [Setup] menus have sub-categories. Select the sub-category icon so that the LCD screen displays the list of menus in the sub-category selected.

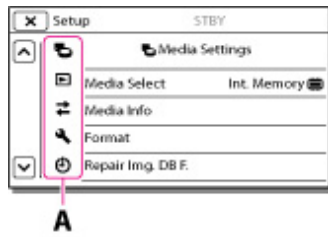

A: Sub-category icons

### When you cannot select a menu item

Grayed out menu items or settings are not available.

Your camcorder displays the reason why you cannot select the menu item or the instruction of under which condition you can set the menu item.

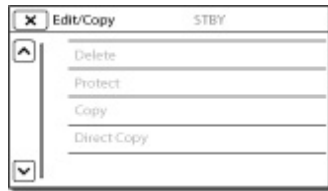

[▲ Back to top](#)

Copyright 2013 Sony Corporation



- ▶ Operation Search
- ▶ Before use
- ▶ Getting started
- ▶ Recording
- ▶ Playback
- ▶ Playing images on a TV
- ▶ Saving images with an external device
- ▶ Using the Wi-Fi function
- ▶ Customizing your camcorder
- ▶ Troubleshooting
- ▶ Maintenance and precautions

[→ Contents list](#)

## Movie

---

You can select the movie recording mode.

1. **MENU** → [Shooting Mode] → [Movie].



[▲ Back to top](#)

- ▶ Operation Search
- ▶ Before use
- ▶ Getting started
- ▶ Recording
- ▶ Playback
- ▶ Playing images on a TV
- ▶ Saving images with an external device
- ▶ Using the Wi-Fi function
- ▶ Customizing your camcorder
- ▶ Troubleshooting
- ▶ Maintenance and precautions

[→ Contents list](#)

## Photo

---

You can select the photo shooting mode.

1. **MENU** → [Shooting Mode] → [Photo].



[▲ Back to top](#)

- ▶ Operation Search
- ▶ Before use
- ▶ Getting started
- ▶ Recording
- ▶ Playback
- ▶ Playing images on a TV
- ▶ Saving images with an external device
- ▶ Using the Wi-Fi function
- ▶ Customizing your camcorder
- ▶ Troubleshooting
- ▶ Maintenance and precautions

[→ Contents list](#)

## Smth Slw REC (Smooth slow rec)

The camcorder records approximately 3-second-long fast actions or motions as an approximately 12-second-long slow-motion movie.

1. **MENU** → [Shooting Mode] → [Smth Slw REC].



2. Press the START/STOP button.  
[Recording...] disappears when recording is finished.

### **To change the timing at which the camcorder starts recording**

Select [] / [] to make the setting.



- [3sec After] (default setting)  
The camcorder records a movie of approximately 3 seconds after the START/STOP button is pressed.
- [3sec Before]  
The camcorder records a movie of approximately 3 seconds before the START/STOP button is pressed.

#### Notes

- You cannot record sound.
- Image quality is not as good as that of normal recording.
- [ REC Mode] will be set to [Standard ] automatically.

[▲ Back to top](#)

- ▶ Operation Search
- ▶ Before use
- ▶ Getting started
- ▶ Recording
- ▶ Playback
- ▶ Playing images on a TV
- ▶ Saving images with an external device
- ▶ Using the Wi-Fi function
- ▶ Customizing your camcorder
- ▶ Troubleshooting
- ▶ Maintenance and precautions

[→ Contents list](#)

## Golf Shot

Divides 2 seconds of fast movement into frames which are then recorded as a movie and photos. You can view a series of movement when playing back, which is convenient in cases such as checking golf swing or tennis form.

1. **MENU** → [Shooting Mode] → [Golf Shot].



2. On the [Golf Shot] screen, frame the subject in the grid in the center of the screen, then press START/STOP right after the subject has taken a swing.

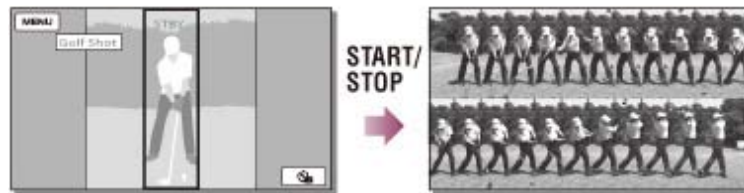

### Timing that the camcorder starts recording

If the moment when the largest sound in 1 second after the START/STOP button is pressed has been detected, the camcorder assumes the moment as the sound of a club hitting the ball. When the sound of a club hitting the ball is detected, the recording time period is automatically adjusted according to at that moment.

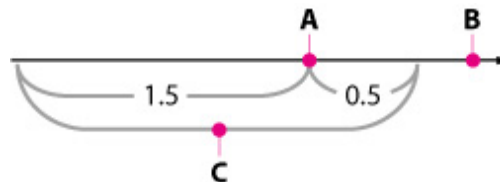

- A:** The sound of a club hitting the ball\*
- B:** The point when you press START/STOP
- C:** The camcorder records images in this 2 seconds period.

\* The camcorder sets the point when the loudest sound in the past 1 second is detected, as the sound of a club hitting the ball.

### To check your form using self-timer

Select / → [On].

The camcorder starts countdown of the timer after you press the START/STOP button.

The point when the count reaches 0 is assumed as the moment of impact and motion before and after 0 is recorded.

### Notes

- If the camcorder cannot detect the sound of a club hitting the ball, the camcorder automatically sets the impact point at 0.5 second before the START/STOP button has been pressed, and records a movie in the time period between 1.5 seconds before the impact point to 0.5 second after the impact point.
- The size of photos becomes 1,920 × 1,080.
- You cannot record sound.
- Image quality is not as good as that of normal recording.
- [REC Mode] will be set to [Standard HQ] automatically.
- Impact sound may be detected by the internal microphone even when an external microphone is attached.
- The image recorded may be noisy when your camcorder has failed to analyze the shot properly because there may be movement in background of the [Golf Shot] recording screen. It is recommended that you record images under stable conditions (for example, using a tripod).

[▲ Back to top](#)

Copyright 2013 Sony Corporation

- ▶ Operation Search
- ▶ Before use
- ▶ Getting started
- ▶ Recording
- ▶ Playback
- ▶ Playing images on a TV
- ▶ Saving images with an external device
- ▶ Using the Wi-Fi function
- ▶ Customizing your camcorder
- ▶ Troubleshooting
- ▶ Maintenance and precautions

[→ Contents list](#)

## White Balance

You can adjust the color balance to the recording environment.



1. **MENU** → [Camera/Mic] → [ Manual Settings] → [White Balance].



2. Select the desired setting.

	<p><b>WB (Auto)</b>  <small>WB AUTO</small></p> <p>The white balance is adjusted automatically.</p> <p>If you have changed the battery pack while [Auto] was selected, or taken your camcorder outdoors after inside use (or vice versa), aim your camcorder at a nearby white object for about 10 seconds for better color balance adjustment.</p>
	<p> <b>(Outdoor)</b></p> <p>The white balance is appropriately adjusted for the following recording conditions:</p> <ul style="list-style-type: none"> <li>● Outdoors</li> <li>● Night views, neon signs and fireworks</li> <li>● Sunrise or sunset</li> <li>● Under daylight fluorescent lamps</li> </ul>
	<p> <b>(Indoor)</b></p> <p>The white balance is appropriately adjusted for the following recording conditions:</p> <ul style="list-style-type: none"> <li>● Indoors</li> <li>● At party scenes or studios where the lighting conditions change quickly</li> <li>● Under video lamps in a studio, or under sodium lamps or incandescent-like color lamps</li> </ul>
	<p> <b>(One Push)</b></p> <p>The white balance will be adjusted according to the ambient light.</p> <ol style="list-style-type: none"> <li>① Select [].</li> <li>② Keep framing white object such as a piece of paper, to fill the screen under the same lightning conditions as you will shoot the subject.</li> <li>③ Select [ <small>SET</small>].</li> </ol> <p>If the lighting conditions changed by bringing your camcorder outdoors from inside the house, or vice versa, you need to redo the [One Push] procedure to readjust the white balance.</p>

- Set [White Balance] to [Auto] or adjust the color in [One Push] under white or cool white fluorescent lamps.
- While you are recording a movie,  (One Push) cannot be set.
- If you set [White Balance], [Scene Selection] is set to [Auto].

[▲ Back to top](#)

---

Copyright 2013 Sony Corporation

- ▶ Operation Search
- ▶ Before use
- ▶ Getting started
- ▶ Recording
- ▶ Playback
- ▶ Playing images on a TV
- ▶ Saving images with an external device
- ▶ Using the Wi-Fi function
- ▶ Customizing your camcorder
- ▶ Troubleshooting
- ▶ Maintenance and precautions

[→ Contents list](#)

## Spot Meter/Fcs (Spot meter/focus)

Exposure and focus can be adjusted for the selected subject automatically.

1. **MENU** → [Camera/Mic] → [ Manual Settings] → [Spot Meter/Fcs].



2. Touch the subject of which you want to adjust the exposure and focus.
  - To adjust the brightness and focus automatically, touch [Auto].



### Notes

- [Exposure] and [Focus] are automatically set to [Manual].

[▲ Back to top](#)



- ▶ Operation Search
- ▶ Before use
- ▶ Getting started
- ▶ Recording
- ▶ Playback
- ▶ Playing images on a TV
- ▶ Saving images with an external device
- ▶ Using the Wi-Fi function
- ▶ Customizing your camcorder
- ▶ Troubleshooting
- ▶ Maintenance and precautions

[→ Contents list](#)

## Spot Meter (Flexible spot meter)

Exposure can be adjusted and set for the selected subject automatically. This function is useful when there is strong contrast between the subject and the background, such as subjects in the spotlight on stage.

1. **MENU** → [Camera/Mic] → [ Manual Settings] → [Spot Meter].



2. Touch the subject of which you want to adjust the exposure.
  - To return the setting to automatic exposure, touch [Auto].



### Notes

- [Exposure] is automatically set to [Manual].

[▲ Back to top](#)

- ▶ Operation Search
- ▶ Before use
- ▶ Getting started
- ▶ Recording
- ▶ Playback
- ▶ Playing images on a TV
- ▶ Saving images with an external device
- ▶ Using the Wi-Fi function
- ▶ Customizing your camcorder
- ▶ Troubleshooting
- ▶ Maintenance and precautions

[→ Contents list](#)

## Spot Focus

Focus can be adjusted automatically for the subject selected.

1. **MENU** → [Camera/Mic] → [ Manual Settings] → [Spot Focus].



2. Touch the subject of which you want to adjust the focus.
  - To adjust the focus automatically, touch [Auto].



### Notes

- [Focus] is automatically set to [Manual].

[▲ Back to top](#)

- ▶ Operation Search
- ▶ Before use
- ▶ Getting started
- ▶ Recording
- ▶ Playback
- ▶ Playing images on a TV
- ▶ Saving images with an external device
- ▶ Using the Wi-Fi function
- ▶ Customizing your camcorder
- ▶ Troubleshooting
- ▶ Maintenance and precautions

[→ Contents list](#)

## Exposure

You can fix the brightness of a picture manually. Adjust the brightness when the subject is too bright or too dark.

1.  → [Camera/Mic] → [ Manual Settings] → [Exposure].



2. Select the desired item.

<input checked="" type="checkbox"/>	<b>Auto</b> The exposure is adjusted automatically.
	<b>Manual</b> Select <input type="button" value="+"/> if the subject is white or the backlight is bright, or select <input type="button" value="-"/> if the subject is black or the light is dim.  

[▲ Back to top](#)

- ▶ Operation Search
- ▶ Before use
- ▶ Getting started
- ▶ Recording
- ▶ Playback
- ▶ Playing images on a TV
- ▶ Saving images with an external device
- ▶ Using the Wi-Fi function
- ▶ Customizing your camcorder
- ▶ Troubleshooting
- ▶ Maintenance and precautions

[→ Contents list](#)

## Focus

You can adjust the focus manually. You can select this function also when you want to focus on a certain subject intentionally.

1. **MENU** → [Camera/Mic] → [ Manual Settings] → [Focus].



2. Select the desired item.

<input checked="" type="checkbox"/>	<p><b>Auto</b> The focus is adjusted automatically.</p>
<input type="checkbox"/>	<p><b>Manual</b> Adjust the focus using  (nearby subject) or  (distant subject).  appears when the focus cannot be adjusted any closer, and  appears when the focus cannot be adjusted farther away.</p> <div style="text-align: center;"> </div>

### To adjust the focus

It is easier to focus on the subject by moving the power zoom lever towards T (telephoto) to adjust the focus, then towards W (wide angle) to adjust the zoom for recording. When you want to record a subject at close range, move the power zoom lever to W (wide angle), then adjust the focus.

### On focal distance information

Your camcorder displays the focal distance information for a few seconds when the focus mode is switched from automatic to manual or when you set the focus manually. You can use this information as a guide when the subject is dark and focus adjustment is difficult. (This information will not appear correctly if a conversion lens (sold separately) is being used.)

#### Notes

- When you set [Focus] to [Manual], appears.
- The minimum possible distance between camcorder and subject while maintaining sharp focus is about 1 cm (about 13/32 in.) for wide angle and about 80 cm (about 31 1/2 in.) for telephoto.



- ▶ Operation Search
- ▶ Before use
- ▶ Getting started
- ▶ Recording
- ▶ Playback
- ▶ Playing images on a TV
- ▶ Saving images with an external device
- ▶ Using the Wi-Fi function
- ▶ Customizing your camcorder
- ▶ Troubleshooting
- ▶ Maintenance and precautions

[→ Contents list](#)

## IRIS

You can shoot images with the IRIS priority mode. Changing IRIS parameter changes the focus range. You can change the IRIS parameter depending on what type of photos you want to shoot, either to sharpen the subject with its background blurred or sharpen the whole image.

1. MENU → [Camera/Mic] → [ Manual Settings] → [IRIS].



2. Select the desired item.

<input checked="" type="checkbox"/>	<p><b>Auto</b> The IRIS is adjusted automatically.</p>
<input type="checkbox"/>	<p><b>Manual</b> Adjust the iris by selecting <span style="border: 1px solid black; padding: 2px;">+</span> to sharpen the whole image (increase the IRIS parameter), and <span style="border: 1px solid black; padding: 2px;">-</span> to sharpen the subject with its background blurred (decrease the IRIS parameter).</p>

### **To change the atmosphere of image by the IRIS parameter**

Smaller F-value (opening the iris) narrows the range that is in focus. Larger F-value (narrowing down the iris) widens the range that is in focus. Open the iris to blur the background, or narrow down the iris to sharpen the whole image.

#### Notes

- Even if you open the IRIS wider (a smaller F-value) than F3.4 when you set the zoom lever to the W (Wide angle) side, the IRIS is reset to F3.4 as you move the zoom lever to the T (Telephoto) side.

[▲ Back to top](#)

- ▶ Operation Search
- ▶ Before use
- ▶ Getting started
- ▶ Recording
- ▶ Playback
- ▶ Playing images on a TV
- ▶ Saving images with an external device
- ▶ Using the Wi-Fi function
- ▶ Customizing your camcorder
- ▶ Troubleshooting
- ▶ Maintenance and precautions

[→ Contents list](#)

## Shutter Speed

You can shoot images with the Shutter Speed priority mode. You can express the movement of a moving subject in various way by adjusting the shutter speed.

1. MENU → [Camera/Mic] → [ Manual Settings] → [Shutter Speed].



2. Select the desired item.

<input checked="" type="checkbox"/>	<p><b>Auto</b> The shutter speed is adjusted automatically.</p>
<input type="checkbox"/>	<p><b>Manual</b> Adjust the shutter speed using <span style="border: 1px solid black; padding: 2px;">+</span> to get a fast shutter speed, and <span style="border: 1px solid black; padding: 2px;">-</span> to get a slow shutter speed.</p>

- As the value becomes smaller (slower shutter speed), a trailing image of the movement of the subject is captured.

### **To change the atmosphere of image by changing the shutter speed**

When shooting a mountain stream, for example, a splash of water will be captured clearly with high shutter speed, or a trailing image of water with low shutter speed.

#### Notes

- When you record images under a fluorescent lamp, sodium lamp, or mercury lamp, horizontal stripes may appear, flicker may occur, or color may change. In this case, change the shutter speed according to the power supply frequency in your region.

[▲ Back to top](#)

- ▶ Operation Search
- ▶ Before use
- ▶ Getting started
- ▶ Recording
- ▶ Playback
- ▶ Playing images on a TV
- ▶ Saving images with an external device
- ▶ Using the Wi-Fi function
- ▶ Customizing your camcorder
- ▶ Troubleshooting
- ▶ Maintenance and precautions

[→ Contents list](#)

## AGC Limit

You can select the upper limit for the AGC (Auto Gain Control) to record dim scenes as they look.

- MENU → [Camera/Mic] → [ Manual Settings] → [AGC Limit].



- Select the desired item.

✓	<b>Off</b> The gain is automatically adjusted.
	<b>24dB/21dB/18dB/15dB/12dB/9dB/6dB/3dB/0dB (AGC<math>\bar{I}</math>)</b> The gain is automatically adjusted up to the selected limit.

### Notes

- The upper limit you can select for the AGC (Auto Gain Control) depends on the status of the camcorder.
  - When the camcorder is set to the movie recording mode, the upper limit is 24 dB.
  - When the camcorder is set to the photo shooting mode, the upper limit is 21 dB.
  - When the camcorder is set to use [Smth Slw REC], the upper limit is 15 dB.
- At a higher gain, the brightness becomes more appropriate in dim scenes, but the noise increases. At a lower gain, the noise decreases, but the shutter speed becomes slower to compensate for the lack of brightness, causing camera-shake or subject blur.

[▲ Back to top](#)



- ▶ Operation Search
- ▶ Before use
- ▶ Getting started
- ▶ Recording
- ▶ Playback
- ▶ Playing images on a TV
- ▶ Saving images with an external device
- ▶ Using the Wi-Fi function
- ▶ Customizing your camcorder
- ▶ Troubleshooting
- ▶ Maintenance and precautions

[→ Contents list](#)



## AE Shift

You can adjust the exposure based on the results of the automatic exposure measurement.

1. **MENU** → [Camera/Mic] → [ Manual Settings] → [AE Shift].



2. Select the desired item.

✓	<p><b>Off</b> The exposure is adjusted automatically.</p>
	<p><b>On (Adjusted number and EV)</b> Adjust the automatic exposure level using  when the subject is white or the background is bright, and  when the subject is dark or the light is dim.</p>

[▲ Back to top](#)

- ▶ Operation Search
- ▶ Before use
- ▶ Getting started
- ▶ Recording
- ▶ Playback
- ▶ Playing images on a TV
- ▶ Saving images with an external device
- ▶ Using the Wi-Fi function
- ▶ Customizing your camcorder
- ▶ Troubleshooting
- ▶ Maintenance and precautions

[→ Contents list](#)

## White Balance Shift

You can adjust the white balance manually.

1.  → [Camera/Mic] → [ Manual Settings] → [White Balance Shift].



2. Select the desired item.

<input checked="" type="checkbox"/>	<b>Off</b> The white balance is adjusted automatically.
	<b>On (<input type="button" value="WS"/> and adjusted number)</b> Adjust the white balance using <input type="button" value="+"/> when the images appear bluish, and <input type="button" value="-"/> when the images appear reddish.

[▲ Back to top](#)

- ▶ Operation Search
- ▶ Before use
- ▶ Getting started
- ▶ Recording
- ▶ Playback
- ▶ Playing images on a TV
- ▶ Saving images with an external device
- ▶ Using the Wi-Fi function
- ▶ Customizing your camcorder
- ▶ Troubleshooting
- ▶ Maintenance and precautions

[→ Contents list](#)

## Low Lux

You can record bright color images, even in dim light.

1. **MENU** → [Camera/Mic] → [ Manual Settings] → [Low Lux].



2. Select the desired item.

✓	<b>Off</b> The Low Lux function is not used.
	<b>On (🔒)</b> The Low Lux function is used.

[▲ Back to top](#)

- ▶ Operation Search
- ▶ Before use
- ▶ Getting started
- ▶ Recording
- ▶ Playback
- ▶ Playing images on a TV
- ▶ Saving images with an external device
- ▶ Using the Wi-Fi function
- ▶ Customizing your camcorder
- ▶ Troubleshooting
- ▶ Maintenance and precautions

[→ Contents list](#)

## Scene Selection









You can record images effectively in various situations.

1. MENU → [Camera/Mic] → [ Camera Settings] → [Scene Selection].



2. Select the desired item.



	<p> <b>(Auto)</b> Adjusts image quality automatically.</p>	
	<p> <b>(Night Scene)*<sup>1</sup></b> Maintains the darkening atmosphere of the distant surroundings in night scenes.</p>	
	<p> <b>(Night Portrait)</b> Enables to take photos of people and background using a flash.</p>	
	<p> <b>(Sunrise&amp;Sunset)*<sup>1</sup></b> Reproduces the atmosphere of scenes such as sunsets or sunrises.</p>	
	<p> <b>(Fireworks)*<sup>1</sup></b> Takes spectacular shots of fireworks.</p>	
	<p> <b>(Landscape)*<sup>1</sup></b> Shoots distant subjects clearly. This setting also prevents your camcorder from focusing on glass or metal mesh in windows</p>	

	between the camcorder and the subject.	
	 <b>(Portrait)</b> Brings out the subject such as people or flowers while creating a soft background.	
	 <b>(Spotlight)*2</b> Prevents people's faces from appearing excessively white when subjects are lit by strong light.	
	 <b>(Beach)*2</b> Takes the vivid blue of the ocean or a lake.	
	 <b>(Snow)*2</b> Takes bright pictures of a white landscape.	

\*1 Adjusted to focus on subjects farther away only.

\*2 Adjusted not to focus on subjects a short distance away.

**Notes**

- Even if you set [Night Portrait], the setting changes to [Auto] when the  (Movie) lamp is lit.
- If you set [Scene Selection], the [White Balance], [IRIS], [Shutter Speed] and [ Cinematone] settings are canceled.

[▲ Back to top](#)

- ▶ Operation Search
- ▶ Before use
- ▶ Getting started
- ▶ Recording
- ▶ Playback
- ▶ Playing images on a TV
- ▶ Saving images with an external device
- ▶ Using the Wi-Fi function
- ▶ Customizing your camcorder
- ▶ Troubleshooting
- ▶ Maintenance and precautions

[→ Contents list](#)

## Cinematone

The camcorder automatically adjusts the image quality of the movie to resemble the atmosphere of film camera images when recording a movie.



1. **MENU** → [Camera/Mic] → [ Camera Settings] → [ Cinematone].



2. Select the desired item.

<input checked="" type="checkbox"/>	<b>Off</b> Does not use the Cinematone function.
<input type="checkbox"/>	<b>On</b> Uses the Cinematone function.

### Notes

- When you switch the [ Cinematone] function on or off, the image will be paused temporarily.
- When [ Cinematone] is set to [On], the [Scene Selection] setting changes to [Auto].

[▲ Back to top](#)

- ▶ Operation Search
- ▶ Before use
- ▶ Getting started
- ▶ Recording
- ▶ Playback
- ▶ Playing images on a TV
- ▶ Saving images with an external device
- ▶ Using the Wi-Fi function
- ▶ Customizing your camcorder
- ▶ Troubleshooting
- ▶ Maintenance and precautions

[→ Contents list](#)







## Fader

You can record a transition with the following effects adding to the interval between scenes. Select the desired effect in [STBY] (to fading in) or [REC] (to fading out) mode.

1. **MENU** → [Camera/Mic] → [ Camera Settings] → [ Fader].



2. Select the desired item.

<input checked="" type="checkbox"/>	<p><b>Off</b></p> <p>Does not use an effect.</p>
<input type="checkbox"/>	<p><b>White Fader</b> </p> <p>Fades in/out with the white effect.</p> <p>Out  In</p> 
<input type="checkbox"/>	<p><b>Black Fader</b> </p> <p>Fades in/out with the black effect.</p> <p>Images recorded using the [Black Fader] effect may appear dark on the index screen.</p> <p>Out  In</p> 

### Notes

- When you press START/STOP, the setting is cleared.

[▲ Back to top](#)

- ▶ Operation Search
- ▶ Before use
- ▶ Getting started
- ▶ Recording
- ▶ Playback
- ▶ Playing images on a TV
- ▶ Saving images with an external device
- ▶ Using the Wi-Fi function
- ▶ Customizing your camcorder
- ▶ Troubleshooting
- ▶ Maintenance and precautions

[→ Contents list](#)

## 📷 Self-Timer

Press PHOTO to start the count down. A photo is recorded after about 10 seconds. You can also operate by pressing PHOTO on the Wireless Remote Commander.

1. **MENU** → [Camera/Mic] → [ Camera Settings] → [ Self-Timer].



2. Select the desired item.

✓	<b>Off</b> Cancels the self-timer.
	<b>On (🕒)</b> Starts the self-timer recording. To cancel the recording, select [Reset].

[▲ Back to top](#)



- ▶ Operation Search
- ▶ Before use
- ▶ Getting started
- ▶ Recording
- ▶ Playback
- ▶ Playing images on a TV
- ▶ Saving images with an external device
- ▶ Using the Wi-Fi function
- ▶ Customizing your camcorder
- ▶ Troubleshooting
- ▶ Maintenance and precautions

[→ Contents list](#)

## Tele Macro

You can blur out backgrounds and the subject stands out clearer. This is useful to shoot small subjects, such as flowers or insects.

1. **MENU** → [Camera/Mic] → [ Camera Settings] → [Tele Macro].



2. Select the desired item.

<input checked="" type="checkbox"/>	<p><b>Off</b> Cancels Tele Macro. (Tele Macro is also canceled when you move the zoom lever to the W side.)</p>
<input type="checkbox"/>	<p><b>On (T<sub>∞</sub>)</b> The zoom moves to the top of the T (telephoto) side automatically and allows recording subjects at close range down to about 32 cm (12 5/8 in.).</p> <div style="text-align: center;">  </div>

### Notes

- When recording a distant subject, focusing may be difficult and can take some time.
- Adjust the focus manually when it is hard to focus automatically.

### Related topics

[Zooming](#)  
[\[Focus\]](#)

[▲ Back to top](#)

- ▶ Operation Search
- ▶ Before use
- ▶ Getting started
- ▶ Recording
- ▶ Playback
- ▶ Playing images on a TV
- ▶ Saving images with an external device
- ▶ Using the Wi-Fi function
- ▶ Customizing your camcorder
- ▶ Troubleshooting
- ▶ Maintenance and precautions

[→ Contents list](#)

## SteadyShot (movie)

The camcorder has a balanced optical SteadyShot function that allows you to reduce the camera-shake when shooting with zooming, as well as when shooting with a wide-angle shot.

1. **MENU** → [Camera/Mic] → [ Camera Settings] → [ SteadyShot].



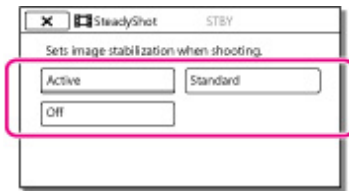

2. Select the desired item.



<input checked="" type="checkbox"/>	<p><b>Active</b></p> <p>In addition to the balanced optical SteadyShot function, the camcorder compensates for camera-shake in the rotation direction.</p>
	<p><b>Standard</b></p> <p>The camcorder reduces camera-shake using the balanced optical SteadyShot function in wide-angle shooting.</p>
	<p><b>Off</b> ()</p> <p>The camcorder does not use the balanced optical SteadyShot function.</p>

### Notes

- The angle of view will be changed after changing the settings of the [ SteadyShot] function.
- You can magnify images up to 10 times using optical zooming in the following cases.
  - When [ SteadyShot] is set to other than [Active].
  - When the  (Photo) lamp is lit.



[▲ Back to top](#)

- ▶ Operation Search
- ▶ Before use
- ▶ Getting started
- ▶ Recording
- ▶ Playback
- ▶ Playing images on a TV
- ▶ Saving images with an external device
- ▶ Using the Wi-Fi function
- ▶ Customizing your camcorder
- ▶ Troubleshooting
- ▶ Maintenance and precautions

[→ Contents list](#)

## SteadyShot (photo)

You can compensate for camera shake.

Set [ SteadyShot] to [Off] () when using a tripod (sold separately), then the image becomes natural.

1.  → [Camera/Mic] → [ Camera Settings] → [ SteadyShot].



2. Select the desired item.

✓	<b>On</b> The SteadyShot function is used.
	<b>Off</b> (  ) The SteadyShot function is not used.

[▲ Back to top](#)

- ▶ Operation Search
- ▶ Before use
- ▶ Getting started
- ▶ Recording
- ▶ Playback
- ▶ Playing images on a TV
- ▶ Saving images with an external device
- ▶ Using the Wi-Fi function
- ▶ Customizing your camcorder
- ▶ Troubleshooting
- ▶ Maintenance and precautions

[→ Contents list](#)

## Digital Zoom

You can select the maximum zoom level. Note that the image quality decreases when you use the digital zoom.

1. **MENU** → [Camera/Mic] → [ Camera Settings] → [Digital Zoom].



✓	<p><b>Off</b> Digital zoom cannot be used.</p>
✗	<p><b>120 ×</b> Up to 120 × zoom is performed digitally.</p> <p><b>A:</b> The zooming zone appears when you select [<b>120 ×</b>].</p>

[▲ Back to top](#)

- ▶ Operation Search
- ▶ Before use
- ▶ Getting started
- ▶ Recording
- ▶ Playback
- ▶ Playing images on a TV
- ▶ Saving images with an external device
- ▶ Using the Wi-Fi function
- ▶ Customizing your camcorder
- ▶ Troubleshooting
- ▶ Maintenance and precautions

[→ Contents list](#)

## Conversion Lens



Set this menu item when you want to use a conversion lens (sold separately) that is compatible with your camcorder.

When using a conversion lens (sold separately), use this function to record using the optimum compensation for camera shake and focus for the lens.

1. **MENU** → [Camera/Mic] → [ Camera Settings] → [Conversion Lens].



2. Select the desired item.

✓	<b>Off</b> Select this when you do not use a conversion lens.
	<b>Wide Conversion ()</b> Select this when you use a wide-conversion lens.
	<b>Tele Conversion ()</b> Select this when you use a tele-conversion lens.

### Notes

- If you select [Wide Conversion], the SteadyShot function will be canceled.

[▲ Back to top](#)

- ▶ Operation Search
- ▶ Before use
- ▶ Getting started
- ▶ Recording
- ▶ Playback
- ▶ Playing images on a TV
- ▶ Saving images with an external device
- ▶ Using the Wi-Fi function
- ▶ Customizing your camcorder
- ▶ Troubleshooting
- ▶ Maintenance and precautions

[→ Contents list](#)

## Auto Back Light

Your camcorder adjusts the exposure for backlit subjects automatically.

1. **MENU** → [Camera/Mic] → [ Camera Settings] → [Auto Back Light].



2. Select the desired item.

✓	<p><b>On</b> The exposure for backlit subjects is adjusted automatically.</p>
	<p><b>Off</b> Does not adjust the exposure for backlit subjects.</p>

[▲ Back to top](#)

- ▶ Operation Search
- ▶ Before use
- ▶ Getting started
- ▶ Recording
- ▶ Playback
- ▶ Playing images on a TV
- ▶ Saving images with an external device
- ▶ Using the Wi-Fi function
- ▶ Customizing your camcorder
- ▶ Troubleshooting
- ▶ Maintenance and precautions

[→ Contents list](#)

## Dial Setting

You can assign one menu item you often use to the MANUAL dial.

1. **MENU** → [Camera/Mic] → [ Camera Settings] → [Dial Setting].



- The [Dial Setting] display appears. The [Dial Setting] display also appears when you press and hold MANUAL down for a few seconds.
2. Rotate the MANUAL dial and select the item to be assigned.

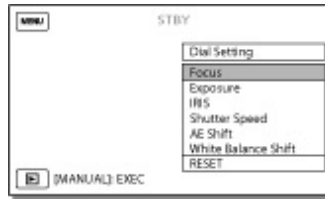

Select [RESET] to reset the items adjusted manually to the default settings.

3. Press MANUAL.

The camera data that appears on the LCD screen will differ, depending on the recording settings of the camcorder. The settings will be displayed with the following icons.

**AUTO** : Automatic

**MANUAL** : Exposure is set manually.

**AE A** : IRIS priority

**AE S** : Shutter speed priority

### Notes

- Manual settings will be retained even if you change the assigned item of the MANUAL dial. However, if you set [Exposure] after setting [AE Shift] manually, [Exposure] will override [AE Shift].
- If you set either one of [Exposure], [IRIS], or [Shutter Speed], the settings of other 2 items are canceled.

### Related topics

[Controlling the image settings manually with the MANUAL dial](#)

[▲ Back to top](#)

- ▶ Operation Search
- ▶ Before use
- ▶ Getting started
- ▶ Recording
- ▶ Playback
- ▶ Playing images on a TV
- ▶ Saving images with an external device
- ▶ Using the Wi-Fi function
- ▶ Customizing your camcorder
- ▶ Troubleshooting
- ▶ Maintenance and precautions

[→ Contents list](#)

## NIGHTSHOT Light

When using the NightShot function, you can record clearer images by activating [NIGHTSHOT Light], which emits infrared light (invisible).

1. **MENU** → [Camera/Mic] → [ Camera Settings] → [NIGHTSHOT Light].



2. Select the desired item.

✓	<b>On</b> Emits infrared light.
	<b>Off</b> Does not emit infrared light.

### Notes

- Do not cover the infrared port with your fingers or other objects.
- Remove the lens hood or the Step Down Ring (supplied) before using [NIGHTSHOT Light], because the lens hood or the Step Down Ring may prevent the infrared function from working properly.
- Remove the conversion lens (sold separately).
- The maximum shooting distance using [NIGHTSHOT Light] is about 3 m (10 feet).

### Related topics

[Recording in dark places \(NightShot\)](#)

Infrared port: [Parts and controls](#)

[▲ Back to top](#)



- ▶ Operation Search
- ▶ Before use
- ▶ Getting started
- ▶ Recording
- ▶ Playback
- ▶ Playing images on a TV
- ▶ Saving images with an external device
- ▶ Using the Wi-Fi function
- ▶ Customizing your camcorder
- ▶ Troubleshooting
- ▶ Maintenance and precautions

[→ Contents list](#)

## Face Detection

You can set the camcorder to detect a face automatically.

Your camcorder adjusts the focus/color/exposure automatically for the face of the selected subject.

- MENU** → [Camera/Mic] → [ Face] → [Face Detection].



- Select the desired item.

✓	<b>Auto</b> Detects faces without distinction between adults and children.
	<b>Child Priority</b> ( ) Gives faces of children priority.
	<b>Adult Priority</b> ( ) Gives faces of adults priority.
	<b>Off</b> () Does not detect faces.

### Recording conditions for better face detection performance

- Shoot in a sufficiently bright place.
- The subject is not wearing glasses, a hat or mask.
- The subject faces directly towards the camera.

#### Notes

- Faces may not be detected depending on recording conditions, subject conditions, and the setting of your camcorder.

#### Related topics

[Recording the selected subject clearly \(Face Priority\)](#)  
[\[Smile Shutter\]](#)

[▲ Back to top](#)

- ▶ Operation Search
- ▶ Before use
- ▶ Getting started
- ▶ Recording
- ▶ Playback
- ▶ Playing images on a TV
- ▶ Saving images with an external device
- ▶ Using the Wi-Fi function
- ▶ Customizing your camcorder
- ▶ Troubleshooting
- ▶ Maintenance and precautions

[→ Contents list](#)

## Smile Shutter

The shutter is released automatically when the camcorder detects a smile. If you do not want to take photos automatically, select [Off].

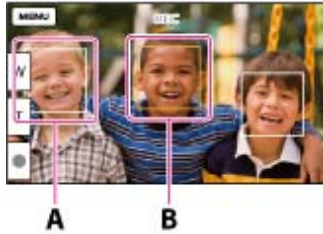

- A: The camcorder is detecting a face.
- B: The camcorder is detecting a smile (orange).

1. **MENU** → [Camera/Mic] → [ Face] → [Smile Shutter].



2. Select the desired item.

<input checked="" type="checkbox"/>	<b>Dual Capture</b> Only during movie recording, the shutter is released automatically, when the camcorder detects a smile.
<input type="checkbox"/>	<b>Always On</b> The shutter is released when the camcorder detects a smile whenever the camcorder is in recording mode.
<input type="checkbox"/>	<b>Off ( Off)</b> Smiles are not detected, so photos are not recorded automatically.

### Notes

- When set to the following, you cannot use the Smile Shutter function.
  - [ REC Mode]: [Highest Quality **FX**]
  - [ Frame Rate]: [60p] (models with the NTSC color system) or [50p] (models with the PAL color system)
- Smiles may not be detected depending on recording conditions, subject conditions, and the setting of your camcorder.

### Related topics

Information on your camcorder model: [Model Information](#)  
[\[Smile Sensitivity\]](#)



- ▶ Operation Search
- ▶ Before use
- ▶ Getting started
- ▶ Recording
- ▶ Playback
- ▶ Playing images on a TV
- ▶ Saving images with an external device
- ▶ Using the Wi-Fi function
- ▶ Customizing your camcorder
- ▶ Troubleshooting
- ▶ Maintenance and precautions

[→ Contents list](#)

## Smile Sensitivity

Sets the smile detection sensitivity for using the Smile Shutter function.

1. **MENU** → [Camera/Mic] → [ Face] → [Smile Sensitivity].



2. Select the desired item.

	<b>Big Smile</b> Detects a big smile.
✓	<b>Normal Smile</b> Detects a normal smile.
	<b>Slight Smile</b> Detects even a slight smile.

[▲ Back to top](#)

- ▶ Operation Search
- ▶ Before use
- ▶ Getting started
- ▶ Recording
- ▶ Playback
- ▶ Playing images on a TV
- ▶ Saving images with an external device
- ▶ Using the Wi-Fi function
- ▶ Customizing your camcorder
- ▶ Troubleshooting
- ▶ Maintenance and precautions

[→ Contents list](#)

## Flash

You can select the flash setting when you record photos using the built-in flash, or an external flash (sold separately) that is compatible with your camcorder.

1. **MENU** → [Camera/Mic] → [**Flash**] → [Flash].



2. Select the desired item.

✓	<b>Auto</b> Automatically flashes when there is insufficient ambient light.
	<b>On (⚡)</b> Always uses the flash regardless of the surrounding brightness.
	<b>Off (⊖)</b> Records without flash.

### If white circular spots appear on photos

This is caused by particles (dust, pollen, etc.) floating close to the lens. When they are accentuated by the camcorder's flash, they appear as white circular spots.

To reduce the white circular spots, light the room and shoot the subject without a flash.



#### Notes

- The recommended distance to the subject when using the built-in flash is approximately 0.3 m to 1.5 m (1 foot to 5 feet).
- Remove any dust from the surface of the flash before using it. Flash effect may be impaired if heat discoloration or dust obscures the lamp.
- The flash does not flash while the (Movie) lamp is lit.
- A shadow may be produced on photos if you use the flash when you take photos with the conversion lens (sold separately) attached.



- ▶ Operation Search
- ▶ Before use
- ▶ Getting started
- ▶ Recording
- ▶ Playback
- ▶ Playing images on a TV
- ▶ Saving images with an external device
- ▶ Using the Wi-Fi function
- ▶ Customizing your camcorder
- ▶ Troubleshooting
- ▶ Maintenance and precautions

[→ Contents list](#)

## Flash Level

You can select the brightness of the flash light.

You can set this function when you record photos using the built-in flash, or an external flash (sold separately) that is compatible with your camcorder.

1. **MENU** → [Camera/Mic] → [**Flash**] → [Flash Level].



2. Select the desired item.

	<b>High (⚡+)</b> Makes the flash level higher.
✓	<b>Normal (⚡)</b> Normal flash level.
	<b>Low (⚡-)</b> Makes the flash level lower.

[▲ Back to top](#)

- ▶ Operation Search
- ▶ Before use
- ▶ Getting started
- ▶ Recording
- ▶ Playback
- ▶ Playing images on a TV
- ▶ Saving images with an external device
- ▶ Using the Wi-Fi function
- ▶ Customizing your camcorder
- ▶ Troubleshooting
- ▶ Maintenance and precautions

[→ Contents list](#)

## Red Eye Reduction

You can prevent redevye by activating the pre-flash before the flash flashes. You can set this function when you record photos using the built-in flash, or an external flash (sold separately) that is compatible with your camcorder.

1. MENU → [Camera/Mic] → [ Flash] → [Red Eye Reduction].



2. Select the desired item.

✓	<b>Off</b> Does not use Red Eye Reduction to prevent redevye.
	<b>On ()</b> Uses Red Eye Reduction to prevent redevye.

### Notes

- The redevye reduction may not produce the desired effect due to individual differences and other conditions.
- The redevye function does not work with automatic recording by [Smile Shutter].

[▲ Back to top](#)



- ▶ Operation Search
- ▶ Before use
- ▶ Getting started
- ▶ Recording
- ▶ Playback
- ▶ Playing images on a TV
- ▶ Saving images with an external device
- ▶ Using the Wi-Fi function
- ▶ Customizing your camcorder
- ▶ Troubleshooting
- ▶ Maintenance and precautions

[→ Contents list](#)

## Closer Voice

Your camcorder detects a face of a person and records the voice clearly.

1. **MENU** → [Camera/Mic] → [ Microphone] → [Closer Voice].



2. Select the desired item.

✓	<b>On</b> Detects faces and records the voices clearly.
	<b>Off</b> () Does not detect faces and record voices clearly.

### Notes

- The [Closer Voice] function does not activate while an external microphone is connected to the camcorder.
- When you set [Audio Rec Level] to [Manual], [Closer Voice] is set to [Off] automatically.
- When you want to record the sound clearly without any interference, for example when you record a music concert, set [Closer Voice] to [Off].

### Related topics

[\[Face Detection\]](#)

[▲ Back to top](#)

- ▶ Operation Search
- ▶ Before use
- ▶ Getting started
- ▶ Recording
- ▶ Playback
- ▶ Playing images on a TV
- ▶ Saving images with an external device
- ▶ Using the Wi-Fi function
- ▶ Customizing your camcorder
- ▶ Troubleshooting
- ▶ Maintenance and precautions

[→ Contents list](#)

## Blt-in Zoom Mic

You can record a movie with vivid sound appropriate to the zoom position.

1. **MENU** → [Camera/Mic] → [ Microphone] → [Blt-in Zoom Mic].



2. Select the desired item.

<input checked="" type="checkbox"/>	<b>Off</b> The microphone does not record sound following zooming in or out.
<input type="checkbox"/>	<b>On</b> (  ) The microphone records sound following zooming in or out.

### Notes

- When you set [Audio Rec Level] to [Manual], [Blt-in Zoom Mic] is set to [Off] automatically.

[▲ Back to top](#)

- ▶ Operation Search
- ▶ Before use
- ▶ Getting started
- ▶ Recording
- ▶ Playback
- ▶ Playing images on a TV
- ▶ Saving images with an external device
- ▶ Using the Wi-Fi function
- ▶ Customizing your camcorder
- ▶ Troubleshooting
- ▶ Maintenance and precautions

[→ Contents list](#)

## Auto Wind NR

Your camcorder records a movie with less wind noise input from the built-in microphone. This function automatically cuts the low-range wind noise according to the noise level.

1. **MENU** → [Camera/Mic] → [ Microphone] → [Auto Wind NR].



2. Select the desired item.

<input type="checkbox"/>	<b>Off</b> (  Does not reduce the wind noise.
<input checked="" type="checkbox"/>	<b>On</b> Reduces the wind noise.

### Notes

- When you set [Auto Wind NR] to [Off], Intelligent Auto is set to [Off].
- [Auto Wind NR] will not function while an external microphone is attached to your camcorder.

[▲ Back to top](#)

- ▶ Operation Search
- ▶ Before use
- ▶ Getting started
- ▶ Recording
- ▶ Playback
- ▶ Playing images on a TV
- ▶ Saving images with an external device
- ▶ Using the Wi-Fi function
- ▶ Customizing your camcorder
- ▶ Troubleshooting
- ▶ Maintenance and precautions

[→ Contents list](#)

## Audio Mode

You can change the recording sound format.

1. **MENU** → [Camera/Mic] → [ Microphone] → [Audio Mode].



2. Select the desired item.

✓	<b>5.1ch Surround (♫5.1ch)</b> Records sound in 5.1ch surround.
	<b>2ch Stereo (♫2ch)</b> Records sound in 2ch stereo.

[▲ Back to top](#)

- ▶ Operation Search
- ▶ Before use
- ▶ Getting started
- ▶ Recording
- ▶ Playback
- ▶ Playing images on a TV
- ▶ Saving images with an external device
- ▶ Using the Wi-Fi function
- ▶ Customizing your camcorder
- ▶ Troubleshooting
- ▶ Maintenance and precautions

[→ Contents list](#)

## Audio Rec Level

You can adjust the audio recording level.

- MENU → [Camera/Mic] → [ Microphone] → [Audio Rec Level].



- Select the desired item.

<input checked="" type="checkbox"/>	<p><b>Auto</b> The audio recording level is adjusted automatically.</p>
<input type="checkbox"/>	<p><b>Manual</b> ( ) Adjust the audio recording level with <span style="border: 1px solid black; padding: 2px;">+</span> to raise the audio recording level and <span style="border: 1px solid black; padding: 2px;">-</span> to lower the audio recording level.</p>

### Notes

- The setting will be reset each time you switch between [Auto] and [Manual].
- When [Audio Rec Level] is set to [Manual], the following will switch to [Off].
  - [Closer Voice]
  - [Blt-in Zoom Mic]
- It is recommended that you wear headphones to operate while checking the level.
- When you record continuous loud sound, you can record more true to life sound by selecting a lower level in advance.
- The limiter is always active regardless of the setting value of the recording level.
- When you are using a dedicated microphone that is connected with the Multi Interface Shoe, the recording level setting will be invalid, and you will not be able to adjust the recording level.

[▲ Back to top](#)

- ▶ Operation Search
- ▶ Before use
- ▶ Getting started
- ▶ Recording
- ▶ Playback
- ▶ Playing images on a TV
- ▶ Saving images with an external device
- ▶ Using the Wi-Fi function
- ▶ Customizing your camcorder
- ▶ Troubleshooting
- ▶ Maintenance and precautions

[➔ Contents list](#)

## My Button

You can assign functions that you frequently use when recording to one of the My Buttons.

1. **MENU** → [Camera/Mic] → [ Shooting Assist] → [My Button].



2. Select the menu item that you want to assign to a My Button using / .



3. Select one of the My Buttons to which the menu item will be assigned.

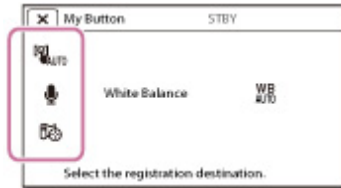

4. Select **OK**.

[▲ Back to top](#)

- ▶ Operation Search
- ▶ Before use
- ▶ Getting started
- ▶ Recording
- ▶ Playback
- ▶ Playing images on a TV
- ▶ Saving images with an external device
- ▶ Using the Wi-Fi function
- ▶ Customizing your camcorder
- ▶ Troubleshooting
- ▶ Maintenance and precautions

[→ Contents list](#)

## Expanded Focus

You can magnify an image that appears at the center of the LCD screen by about 2.0 times to confirm the sharpness of the focus.

1. **MENU** → [Camera/Mic] → [ Shooting Assist] → [Expanded Focus].



2. Select the desired item.

✓	<b>Off</b> Does not magnify images.
	<b>On</b> Magnify images.

### Notes

- Even though the images has been magnified on the camcorder, the recorded image is not magnified.
- The image that is output to an external device is not magnified.

[▲ Back to top](#)

- ▶ Operation Search
- ▶ Before use
- ▶ Getting started
- ▶ Recording
- ▶ Playback
- ▶ Playing images on a TV
- ▶ Saving images with an external device
- ▶ Using the Wi-Fi function
- ▶ Customizing your camcorder
- ▶ Troubleshooting
- ▶ Maintenance and precautions

[→ Contents list](#)

## Grid Line

You can display the lines and check that the subject is horizontal or vertical. Positioning the subject at the cross point of the grid lines makes a balanced composition. The lines is not recorded.

1. **MENU** → [Camera/Mic] → [ Shooting Assist] → [Grid Line].



2. Select the desired item.

✓	<p><b>Off</b> Does not display the grid lines.</p>
	<p><b>On</b> Displays the grid lines.</p>

### Notes

- The outer frame of grid lines shows the display area of a TV which is not compatible with full pixel display.

[▲ Back to top](#)



- ▶ Operation Search
- ▶ Before use
- ▶ Getting started
- ▶ Recording
- ▶ Playback
- ▶ Playing images on a TV
- ▶ Saving images with an external device
- ▶ Using the Wi-Fi function
- ▶ Customizing your camcorder
- ▶ Troubleshooting
- ▶ Maintenance and precautions

[→ Contents list](#)

## Display Setting

You can set the duration of displaying the icons or indicators on the LCD screen while recording.

1. **MENU** → [Camera/Mic] → [ Shooting Assist] → [Display Setting].



2. Select the desired item.

<input checked="" type="checkbox"/>	<p><b>Auto</b> Displays for about 3 seconds. The rec &amp; zoom buttons on the LCD screen is displayed.</p>
<input type="checkbox"/>	<p><b>On</b> Always displays. The rec &amp; zoom buttons on the LCD screen is not displayed.</p>

### Notes

- You cannot change the setting of the icons or indicators on the LCD screen while in the playback mode.

[▲ Back to top](#)

- ▶ Operation Search
- ▶ Before use
- ▶ Getting started
- ▶ Recording
- ▶ Playback
- ▶ Playing images on a TV
- ▶ Saving images with an external device
- ▶ Using the Wi-Fi function
- ▶ Customizing your camcorder
- ▶ Troubleshooting
- ▶ Maintenance and precautions

[→ Contents list](#)

## Zebra

You can display a zebra pattern as a guide for adjusting brightness. The zebra pattern will not be recorded with the image.

- MENU** → [Camera/Mic] → [ Shooting Assist] → [Zebra].



- Select the desired item.

✓	<b>Off</b> Does not display the zebra pattern.
	<b>70 (70)</b> Displays the zebra pattern over the part of an image that exceeds the brightness level of about 70 IRE*.
	<b>100 (100)</b> Displays the zebra pattern over the part of an image that exceeds the brightness level of about 100 IRE*.

\* IRE (Institute of Radio Engineers) is a measure of the video signal level that is used as the bases of brightness; the reference level (pedestal level) is set to 0 (%) and the maximum level (completely white level) is set to 100 (%).

### Notes

- With a subject that exceeds a brightness level of 100 IRE, the image may become overexposed.

[▲ Back to top](#)

- ▶ Operation Search
- ▶ Before use
- ▶ Getting started
- ▶ Recording
- ▶ Playback
- ▶ Playing images on a TV
- ▶ Saving images with an external device
- ▶ Using the Wi-Fi function
- ▶ Customizing your camcorder
- ▶ Troubleshooting
- ▶ Maintenance and precautions

[→ Contents list](#)



## Peaking

You can display an image on the screen with its outlines enhanced with colors. This function helps you to adjust the focus. The enhanced outlines will not be recorded on the image.

1. **MENU** → [Camera/Mic] → [ Shooting Assist] → [Peaking].



2. Select the desired item.

✓	<b>Off</b> Does not display the enhanced outlines.
	<b>(White)</b> Displays the enhanced outlines in white.
	<b>(Red)</b> Displays the enhanced outlines in red.
	<b>(Yellow)</b> Displays the enhanced outlines in yellow.

### Notes

- The enhanced outlines may not appear in a dark location.

[▲ Back to top](#)

- ▶ Operation Search
- ▶ Before use
- ▶ Getting started
- ▶ Recording
- ▶ Playback
- ▶ Playing images on a TV
- ▶ Saving images with an external device
- ▶ Using the Wi-Fi function
- ▶ Customizing your camcorder
- ▶ Troubleshooting
- ▶ Maintenance and precautions

[→ Contents list](#)

## Light Bright

You can set the brightness of the video light.

1. **MENU** → [Camera/Mic] → [ Shooting Assist] → [Light Bright].



2. Select the desired item.

✓	<b>Standard</b> Standard brightness.
	<b>Bright</b> Select this mode when you find the video light is not bright enough.

[▲ Back to top](#)

- ▶ Operation Search
- ▶ Before use
- ▶ Getting started
- ▶ Recording
- ▶ Playback
- ▶ Playing images on a TV
- ▶ Saving images with an external device
- ▶ Using the Wi-Fi function
- ▶ Customizing your camcorder
- ▶ Troubleshooting
- ▶ Maintenance and precautions

[→ Contents list](#)

## Audio Level Display

You can select whether or not to display the audio level meter.  
Shape of the audio level meter differs depending on the [Audio Mode] setting.

1. **MENU** → [Camera/Mic] → [ Shooting Assist] → [Audio Level Display].



2. Select the desired item.

✓	<p><b>On</b> Displays audio level meter.</p> 
	<p><b>Off</b> Does not display the audio level meter.</p>

[▲ Back to top](#)

- ▶ Operation Search
- ▶ Before use
- ▶ Getting started
- ▶ Recording
- ▶ Playback
- ▶ Playing images on a TV
- ▶ Saving images with an external device
- ▶ Using the Wi-Fi function
- ▶ Customizing your camcorder
- ▶ Troubleshooting
- ▶ Maintenance and precautions

[→ Contents list](#)

## REC Mode

You can switch the recording mode to select the movie quality when recording high definition image quality (HD) movies. The recording time or the type of media device to which the images can be copied may change, depending on the recording mode selected. ([Standard HQ] is the default setting.)

1. **MENU** → [Image Quality/Size] → [**REC Mode**].



2. Select the desired recording mode.



- appears on a medium icon if a movie recorded with the selected recording mode cannot be copied on that medium.

## On image quality

The image quality and the bit-rate for each recording mode can be set as follows. "M," such as in "24M," means "Mbps."

### Models with the NTSC color system:

- High definition image quality (HD):
  - [60p Quality PS]: 1920 × 1080/60p quality, AVC HD 28M (PS)\*<sup>1</sup>
  - [Highest Quality FX]: 1920 × 1080/60i or 1920 × 1080/24p quality, AVC HD 24M (FX)
  - [High Quality FH]: 1920 × 1080/60i or 1920 × 1080/24p quality, AVC HD 17M (FH)
  - [Standard HQ]: 1440 × 1080/60i quality, AVC HD 9M (HQ)\*<sup>2</sup>
  - [Long Time LP]: 1440 × 1080/60i quality, AVC HD 5M (LP)
- MP4:
  - 1280 × 720/30p quality
- Standard definition image quality (STD):
  - [Standard HQ]: Standard quality, Standard STD 9M (HQ)\*<sup>3</sup>

### Models with the PAL color system:

- High definition image quality (HD):
  - [50p Quality PS]: 1920 × 1080/50p quality, AVC HD 28M (PS)\*<sup>1</sup>
  - [Highest Quality FX]: 1920 × 1080/50i, 1920 × 1080/25p or 1920 × 1080/24p ([24p Mode]) quality, AVC HD 24M (FX)
  - [High Quality FH]: 1920 × 1080/50i, 1920 × 1080/25p or 1920 × 1080/24p ([24p Mode])

- quality, AVC HD 17M (FH)
- [Standard **HQ**]: 1440 × 1080/50i quality, AVC HD 9M (HQ)\*<sup>2</sup>
- [Long Time **LP**]: 1440 × 1080/50i quality, AVC HD 5M (LP)
- MP4:
  - 1280 × 720/25p quality
- Standard definition image quality (STD):
  - [Standard **HQ**]: Standard quality, Standard STD 9M (HQ)\*<sup>3</sup>

\*<sup>1</sup> You can select this setting when [**Frame Rate**] is set to [60p] (models with the NTSC color system) or [50p] (models with the PAL color system).

\*<sup>2</sup> The default setting.

\*<sup>3</sup> Standard image quality (STD) is fixed to this value.

## Types of media devices on which the images can be saved

Types of media that images can be saved on will depend on the recording mode selected.

Types of media	Recording mode		
	PS*	FX	FH/HQ/LP
Internal memory on this camcorder	✓	✓	✓
Memory card inserted in this camcorder	✓	✓	✓
External media (USB storage devices)	✓	✓	✓
Blu-ray discs	✓	✓	✓
AVCHD recording discs	—	—	✓

\* [60p Quality **PS**] (models with the NTSC color system) or [50p Quality **PS**] (models with the PAL color system) can be set only when the [**Frame Rate**] is set to [60p] (models with the NTSC color system) or [50p] (models with the PAL color system).

### Related topics

Information on your camcorder model: [Model Information](#)

[\[Frame Rate\]](#)



Recording standard definition image quality (STD) movie: [HD/MP4/STD Setting](#)

[▲ Back to top](#)

- ▶ Operation Search
- ▶ Before use
- ▶ Getting started
- ▶ Recording
- ▶ Playback
- ▶ Playing images on a TV
- ▶ Saving images with an external device
- ▶ Using the Wi-Fi function
- ▶ Customizing your camcorder
- ▶ Troubleshooting
- ▶ Maintenance and precautions

[→ Contents list](#)

## Frame Rate

You can select the frame rate to be used to record high definition image quality (HD) movies. Using 60i\*/50i\*\* is recommended for standard recording. Set [ Frame Rate] first, before setting [ REC Mode].

1.  → [Image Quality/Size] → [ Frame Rate].



2. Select the desired frame rate.

<input checked="" type="checkbox"/>	<p><b>60i*/50i**</b> This is an ordinary setting for recording.</p>
<input type="checkbox"/>	<p><b>60p*/50p**</b> You can record movies with a volume of data twice that of 60i*/50i** with this setting, and this will allow you to enjoy clear images. When you play a movie recorded with this setting on a TV, the TV must be compatible with 60p*/50p** movie playback and you have to set [HDMI Resolution] to [1080p/480p]*/[1080p/576p]**. If the TV is not compatible with 60p*/50p** movie playback, the movie will be output as a 60i*/50i** movie.</p>
<input type="checkbox"/>	<p><b>24p*/25p**</b> You can record movies which provide an atmosphere closer to that of film images with this setting. It is recommended that you record movies with this setting using a tripod.</p>

\* HDR-PJ790/ PJ790V

\*\* HDR-PJ780E/ PJ780VE/ PJ790E/ PJ790VE

### Notes

- The media that the recorded images can be saved on will depend on the recording mode that has been set during recording.

### Related topics

[REC Mode](#)

[▲ Back to top](#)



- ▶ Operation Search
- ▶ Before use
- ▶ Getting started
- ▶ Recording
- ▶ Playback
- ▶ Playing images on a TV
- ▶ Saving images with an external device
- ▶ Using the Wi-Fi function
- ▶ Customizing your camcorder
- ▶ Troubleshooting
- ▶ Maintenance and precautions

[→ Contents list](#)

## HD/MP4/STD Setting

You can select the image quality of movies.

- MENU → [Image Quality/Size] → [HD/MP4/STD Setting].



- Select the desired item.

✓	<p><b><span style="border: 1px solid black; padding: 2px;">HD</span> HD Quality</b> Records movies in high definition image quality (HD). Enjoy beautiful images on a big screen.</p>
	<p><b><span style="border: 1px solid black; padding: 2px;">MP4</span> MP4</b> Records movies in the MP4 format. This format is easy for playing back your movies on a smartphone, for uploading to a network or for uploading to the Web.</p>
	<p><b><span style="border: 1px solid black; padding: 2px;">STD</span> STD Quality</b> Records movies in standard definition image quality (STD). This is useful for saving your movies to a DVD.</p>

### Notes

- When you play or edit movies, only movies with the selected image quality will be displayed on your camcorder.

[▲ Back to top](#)

- ▶ Operation Search
- ▶ Before use
- ▶ Getting started
- ▶ Recording
- ▶ Playback
- ▶ Playing images on a TV
- ▶ Saving images with an external device
- ▶ Using the Wi-Fi function
- ▶ Customizing your camcorder
- ▶ Troubleshooting
- ▶ Maintenance and precautions

[→ Contents list](#)

## Wide Mode

When recording standard definition image quality (STD) movies, you can select the horizontal to vertical ratio.

1. MENU → [Image Quality/Size] → [ Wide Mode].



2. Select the desired item.

✓	<b>16:9 WIDE</b> Records movies to the full screen on a 16:9 (wide) TV screen.
	<b>4:3 ()</b> Records movies to the full screen on a 4:3 TV screen.

### Notes

- For details on the horizontal/vertical ratio of the TV that will be connected, refer to the instruction manuals of the TV.

### Related topics

[\[TV Type\]](#)

[▲ Back to top](#)

- ▶ Operation Search
- ▶ Before use
- ▶ Getting started
- ▶ Recording
- ▶ Playback
- ▶ Playing images on a TV
- ▶ Saving images with an external device
- ▶ Using the Wi-Fi function
- ▶ Customizing your camcorder
- ▶ Troubleshooting
- ▶ Maintenance and precautions

[→ Contents list](#)

## x.v.Color

You can capture wider range of colors. Various colors such as the brilliant color of flowers and turquoise blue of the sea can be more faithfully reproduced. Refer to the instruction manuals of the TV.

1. **MENU** → [Image Quality/Size] → [ x.v.Color].



2. Select the desired item.

<input checked="" type="checkbox"/>	<b>On</b> Select this setting if the recorded movies will be played back on an x.v.Color-compliant TV.
<input type="checkbox"/>	<b>Off</b> Records in ordinary color range.

### Notes

- If the movie recorded with this function [On] is played back on a non-x.v.Color-compliant TV, the color may not be reproduced correctly.

[▲ Back to top](#)

▶ Operation Search

▶ Before use

▶ Getting started

▶ Recording

▶ Playback

▶ Playing images on a TV

▶ Saving images with an external device

▶ Using the Wi-Fi function

▶ Customizing your camcorder

▶ Troubleshooting

▶ Maintenance and precautions

[→ Contents list](#)

## Image Size

You can select a size for the photos you are going to shoot.

1. **MENU** → [Image Quality/Size] → [ Image Size].



2. Select the desired image size.



### Notes

- The image size selected with this setting takes effect for photos taken by the Dual Capture function [Details].

### Related topics

[Expected number of recordable photos](#)

[▲ Back to top](#)

▶ Operation Search

▶ Before use

▶ Getting started

▶ Recording

▶ Playback

▶ Playing images on a TV

▶ Saving images with an external device

▶ Using the Wi-Fi function

▶ Customizing your camcorder

▶ Troubleshooting

▶ Maintenance and precautions

[→ Contents list](#)

## Event View

---

You can display the Event View screen.

1. **MENU** → [Playback Function] → [Event View].



---

### Related topics

[Playing movies and photos from the Event View screen](#)

[▲ Back to top](#)

[Top page](#) > [Customizing your camcorder](#) > [Playback Function](#) > [Map View \(HDR-PJ780VE/ PJ790V/ PJ790VE\)](#)

▶ Operation Search

▶ Before use

▶ Getting started

▶ Recording

▶ Playback

▶ Playing images on a TV

▶ Saving images with an external device

▶ Using the Wi-Fi function

▶ Customizing your camcorder

▶ Troubleshooting

▶ Maintenance and precautions

[→ Contents list](#)

## Map View (HDR-PJ780VE/ PJ790V/ PJ790VE)

---

You can display the Map View screen.

1. **MENU** → [Playback Function] → [Map View].



---

### Related topics

[Playing movies and photos from a map \(Models with GPS\)](#)

[▲ Back to top](#)

▶ Operation Search

▶ Before use

▶ Getting started

▶ Recording

▶ Playback

▶ Playing images on a TV

▶ Saving images with an external device

▶ Using the Wi-Fi function

▶ Customizing your camcorder

▶ Troubleshooting

▶ Maintenance and precautions

[→ Contents list](#)

## Highlight Movie

You can view the Highlight Movie you have saved.

1. **MENU** → [Playback Function] → [Highlight Movie].



2. Select the desired Highlight Movie.

### Related topics

[Converting Highlight Playback scenes or Highlight Scenarios to standard definition image quality \(STD\) \(Highlight Movie\)](#)

[▲ Back to top](#)

▶ Operation Search

▶ Before use

▶ Getting started

▶ Recording

▶ Playback

▶ Playing images on a TV

▶ Saving images with an external device

▶ Using the Wi-Fi function

▶ Customizing your camcorder

▶ Troubleshooting

▶ Maintenance and precautions

[→ Contents list](#)

## Scenario

You can view Highlight Scenario that you have saved.

1. **MENU** → [Playback Function] → [ Scenario].



2. Select the desired scenario.

### Related topics

[Saving Highlight Playback in high definition image quality \(HD\) \(Scenario Save\)](#)

[▲ Back to top](#)



- ▶ Operation Search
- ▶ Before use
- ▶ Getting started
- ▶ Recording
- ▶ Playback
- ▶ Playing images on a TV
- ▶ Saving images with an external device
- ▶ Using the Wi-Fi function
- ▶ Customizing your camcorder
- ▶ Troubleshooting
- ▶ Maintenance and precautions

[→ Contents list](#)

## Delete

1.  → [Edit/Copy] → [Delete].



2. Select the desired setting ([Multiple Images] or [All In Event]).

### Multiple Images

Select the type of image you want to delete, add check marks ✓ to the desired images, and then select  → .

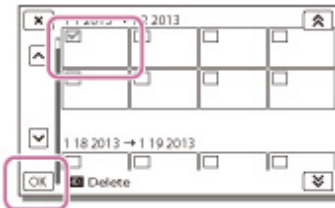

### All In Event

You can delete all images in the selected date at one time.

Select the date you want to delete using  / , and then select  → .

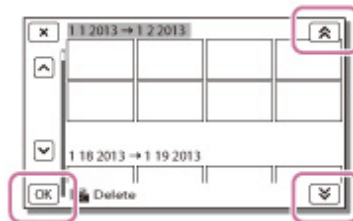

## To delete a part of a movie

You can divide a movie and delete it.

### Notes

- You cannot restore images once they are deleted. Save important movies and photos in advance.
- Do not remove the battery pack or the AC Adaptor from your camcorder while deleting the images. It may damage the recording media.
- Do not eject the memory card while deleting images from the memory card.
- If you delete movies/photos that are included in saved scenarios, the scenarios will also be deleted.

### Related topics

Release protection: [\[Protect\]](#)

[\[Format\]](#)

To divide a movie: [Dividing a movie](#)

[▲ Back to top](#)

---

Copyright 2013 Sony Corporation

- ▶ Operation Search
- ▶ Before use
- ▶ Getting started
- ▶ Recording
- ▶ Playback
- ▶ Playing images on a TV
- ▶ Saving images with an external device
- ▶ Using the Wi-Fi function
- ▶ Customizing your camcorder
- ▶ Troubleshooting
- ▶ Maintenance and precautions

[→ Contents list](#)

## Protect

Protect movies and photos to avoid deleting them by mistake.  
 Ⓞ will be displayed on the protected images.

1. MENU → [Edit/Copy] → [Protect].



2. Select the desired setting ([Multiple Images] or [Set All In Event]).

### Multiple Images

Select the type of image you want to protect, add check marks ✓ to the desired images, and then select OK → OK.



- You can select multiple images.
- Select the image with ✓ so that the ✓ mark disappears and you can remove the protection.

### Set All In Event

You can protect all images in the selected date at one time.

Select the date you want to protect using ▲ / ▼, and then select OK → OK.

- You cannot select multiple dates.

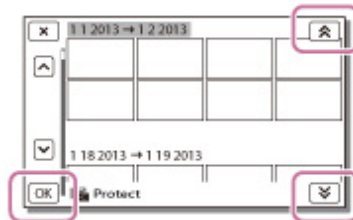

## To remove the protection of an event

You can remove the protection from all images in the selected date at one time.

In step 2 above, select [Remove All In Event], select the date you want to remove the protection using ▲ / ▼, and then select OK → OK.



- ▶ Operation Search
- ▶ Before use
- ▶ Getting started
- ▶ Recording
- ▶ Playback
- ▶ Playing images on a TV
- ▶ Saving images with an external device
- ▶ Using the Wi-Fi function
- ▶ Customizing your camcorder
- ▶ Troubleshooting
- ▶ Maintenance and precautions

[→ Contents list](#)

## Copy

You can copy images stored on the recording media of the camcorder. The original copy of the image will not be deleted after the copy operation has been completed. After you select [Copy], a display asking you to select the source and the destination for the images to be copied appears. Select the desired item.

1. **MENU** → [Edit/Copy] → [Copy].



2. Select the desired setting ([Multiple Images] or [All In Event]).

### Multiple Images

Select the type of image you want to copy, add check marks ✓ to the desired images, and then select **OK** → **OK**.

- You can select multiple images.

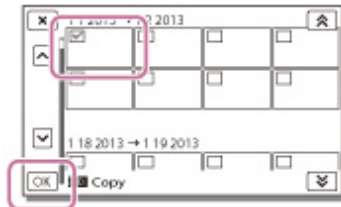

### All In Event

You can copy all images in the selected date at one time. Select the type of image you want to copy, select the date you want to copy using **▲** / **▼**, and then select **OK** → **OK**.

- You cannot select multiple dates.



### Notes

- When you record an image on the memory card for the first time, create the image database file by selecting **MENU** → [Setup] → [Media Settings] → [Repair Img. DB F.] → [Memory Card].
- Connect your camcorder to the wall outlet (wall socket) using the supplied AC Adaptor to prevent your camcorder from running out of power during copy.

- You cannot copy images stored on the memory card to the internal memory of the camcorder (models without a USB input function).

---

**Related topics**

Checking the image copied: [\[Media Select\]](#)

[Saving images on an external media device easily](#)

[▲ Back to top](#)

---

Copyright 2013 Sony Corporation

▶ Operation Search

▶ Before use

▶ Getting started

▶ Recording

▶ Playback

▶ Playing images on a TV

▶ Saving images with an external device

▶ Using the Wi-Fi function

▶ Customizing your camcorder



▶ Troubleshooting

▶ Maintenance and precautions

[→ Contents list](#)

## Direct Copy

You can save images on an external media device (USB storage device) manually while the device is connected to your camcorder. You can perform this operation while the camcorder is displaying the event view of the external device connected.

1. Press  (View Images).
2.  → [Edit/Copy] → [Direct Copy].



3. Follow the instructions that appear on the LCD screen.

### Related topics

[Saving images on an external media device easily](#)

[▲ Back to top](#)

- ▶ Operation Search
- ▶ Before use
- ▶ Getting started
- ▶ Recording
- ▶ Playback
- ▶ Playing images on a TV
- ▶ Saving images with an external device
- ▶ Using the Wi-Fi function
- ▶ Customizing your camcorder
- ▶ Troubleshooting
- ▶ Maintenance and precautions

[→ Contents list](#)

## Media Select

---

You can select the recording medium on which the images will be saved.

1. **MENU** → [Setup] → [ Media Settings] → [Media Select].



2. Select the desired recording medium.

[▲ Back to top](#)



▶ Operation Search

▶ Before use

▶ Getting started

▶ Recording

▶ Playback

▶ Playing images on a TV

▶ Saving images with an external device

▶ Using the Wi-Fi function

▶ Customizing your camcorder

▶ Troubleshooting

▶ Maintenance and precautions

[→ Contents list](#)

## Media Info

You can check the remaining recordable time for movies and the approximate free and used media storage space of the recording media.

1. **MENU** → [Setup] → [Media Settings] → [Media Info].



2. Select the recording medium that you want to view the information.

### Note

- Since there is a management file area, the used space is not displayed as 0 % even if you perform [Format]. [\[Details\]](#)

### Related topics

[\[Media Select\]](#)

[▲ Back to top](#)

- ▶ Operation Search
- ▶ Before use
- ▶ Getting started
- ▶ Recording
- ▶ Playback
- ▶ Playing images on a TV
- ▶ Saving images with an external device
- ▶ Using the Wi-Fi function
- ▶ Customizing your camcorder
- ▶ Troubleshooting
- ▶ Maintenance and precautions

[→ Contents list](#)

## Format

Formatting deletes all the movies and photos to recover recordable free space.

- MENU** → [Setup] → [ Media Settings] → [Format].



- Select the recording medium that you want to format, and then select **OK**.

### Notes

- Connect your camcorder to the wall outlet (wall socket) using the supplied AC Adaptor for this operation. [\[Details\]](#)
- To avoid the loss of important images, you should save them before formatting the recording media.
- Protected movies and photos will also be deleted.
- Make sure not to do the following while [Executing...] is displayed.
  - Open/Close the LCD screen.
  - Operate buttons on the camcorder.
  - Eject the memory card from your camcorder.
  - Disconnect the AC Adaptor.

### To prevent data on the internal memory from being recovered

When you dispose of or transfer the camcorder, it is recommended that you perform [Empty] to prevent the leakage of your personal data.

When the internal memory is selected on the [Format] screen, select [Empty].

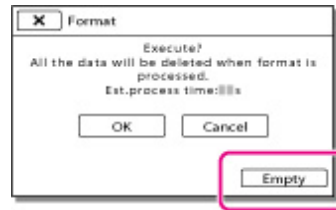

- You cannot perform [Empty] unless you connect the AC Adaptor to the wall outlet (wall socket).
- To avoid the loss of important images, they should be saved on a computer or other devices before performing [Empty].
- Disconnect all cables except the AC Adaptor. Do not disconnect the AC Adaptor during the operation.
- If you stop performing [Empty] while [Executing...] appears, be sure to complete the operation by performing [Format] or [Empty] when you use the camcorder next time.

### Related topics

Information on your camcorder model: [Model Information](#)



▶ Operation Search

▶ Before use

▶ Getting started

▶ Recording

▶ Playback

▶ Playing images on a TV

▶ Saving images with an external device

▶ Using the Wi-Fi function

▶ Customizing your camcorder

▶ Troubleshooting

▶ Maintenance and precautions

[→ Contents list](#)

## Repair Img. DB F.

The camcorder may be able to repair the damaged database file using this menu item.

1. **MENU** → [Setup] → [Media Settings] → [Repair Img. DB F.].



2. Select the recording medium that you want to repair, and then select **OK**.

[▲ Back to top](#)

- ▶ Operation Search
- ▶ Before use
- ▶ Getting started
- ▶ Recording
- ▶ Playback
- ▶ Playing images on a TV
- ▶ Saving images with an external device
- ▶ Using the Wi-Fi function
- ▶ Customizing your camcorder
- ▶ Troubleshooting
- ▶ Maintenance and precautions

[→ Contents list](#)

## File Number

You can select the way to assign file number of photos/MP4 movies.

1. **MENU** → [Setup] → [Media Settings] → [File Number].



2. Select the desired item.

✓	<p><b>Series</b>                  Assigns file numbers of photos/MP4 movies in sequence.                  The file number becomes larger each time you record a photo/MP4 movie. Even if the memory card is replaced with another one, the file number is assigned in sequence.</p>
	<p><b>Reset</b>                  Assigns file numbers in sequence, following the largest file number existing on the recording medium.                  When the memory card is replaced with another one, the file number is assigned for each memory card.</p>

[▲ Back to top](#)

- ▶ Operation Search
- ▶ Before use
- ▶ Getting started
- ▶ Recording
- ▶ Playback
- ▶ Playing images on a TV
- ▶ Saving images with an external device
- ▶ Using the Wi-Fi function
- ▶ Customizing your camcorder
- ▶ Troubleshooting
- ▶ Maintenance and precautions

[→ Contents list](#)

## Data Code

During playback, your camcorder displays the information recorded automatically at the time of recording. You can check the following information.

1. **MENU** → [Setup] → [▶ Playback Settings] → [Data Code].



2. Select the desired item.

✓	<b>Off</b> Data code is not displayed.
	<b>Date/Time</b> Displays the date and time.
	<b>Camera Data</b> Displays camera setting data.
	<b>Coordinates*</b> Displays coordinates.

\* HDR-PJ780VE/ PJ790V/ PJ790VE

### Date/Time

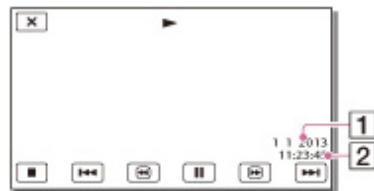

- 1 Date
- 2 Time

### Camera Data

Movie

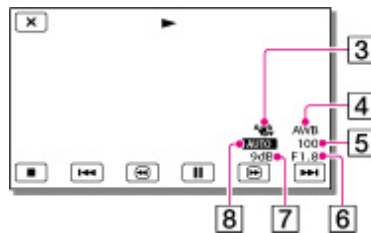

## Photo

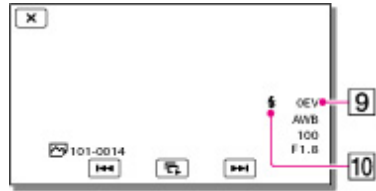

- 3 SteadyShot off
- 4 White Balance
- 5 Shutter Speed
- 6 IRIS (Aperture value)
- 7 Gain
- 8 Brightness
- 9 Exposure
- 10 Flash

## Coordinates (Models with GPS)

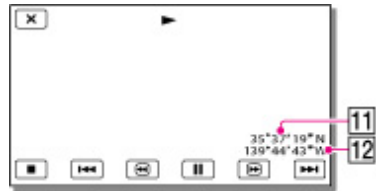

- 11 Latitude
- 12 Longitude

### Notes

- The data code is displayed on the TV screen if you connect your camcorder to a TV.
- Depending on the recording media condition, [-- --] may appear.

[▲ Back to top](#)

▶ Operation Search

▶ Before use

▶ Getting started

▶ Recording

▶ Playback

▶ Playing images on a TV

▶ Saving images with an external device

▶ Using the Wi-Fi function

▶ Customizing your camcorder

▶ Troubleshooting

▶ Maintenance and precautions



[→ Contents list](#)

## Volume

You can adjust the volume of playback sound.

1. **MENU** → [Setup] → [▶ Playback Settings] → [Volume].



2. Adjust the volume using  / .

[▲ Back to top](#)



▶ Operation Search

▶ Before use

▶ Getting started

▶ Recording

▶ Playback

▶ Playing images on a TV

▶ Saving images with an external device

▶ Using the Wi-Fi function

▶ Customizing your camcorder

▶ Troubleshooting

▶ Maintenance and precautions

[→ Contents list](#)

## Download Music (HDR-PJ790/ PJ790V)

You can transfer music files from audio CDs or MP3 files to your camcorder by connecting the camcorder to a computer. To transfer music files, use "Music Transfer."

1. **MENU** → [Setup] → [▶ Playback Settings] → [Download Music].



2. Follow the instructions that appear on the display.  
For details, refer to "Music Transfer" Help.

[▲ Back to top](#)

▶ Operation Search

▶ Before use

▶ Getting started

▶ Recording

▶ Playback

▶ Playing images on a TV

▶ Saving images with an external device

▶ Using the Wi-Fi function

▶ Customizing your camcorder

▶ Troubleshooting

▶ Maintenance and precautions

[→ Contents list](#)

## Empty Music (HDR-PJ790/ PJ790V)

You can delete all music files stored on the camcorder.

1. **MENU** → [Setup] → [ Playback Settings] → [Empty Music].



2. Select [OK] or [Cancel].

### Notes

- If you delete music files using [Empty Music], the music data recorded on your camcorder at the factory will be deleted as well.

[▲ Back to top](#)

- ▶ Operation Search
- ▶ Before use
- ▶ Getting started
- ▶ Recording
- ▶ Playback
- ▶ Playing images on a TV
- ▶ Saving images with an external device
- ▶ Using the Wi-Fi function
- ▶ Customizing your camcorder
- ▶ Troubleshooting
- ▶ Maintenance and precautions

[→ Contents list](#)

## TV Type

You need to convert the signal depending on the TV connected when playing back movies and photos. The recorded movies and photos are played back as following illustrations.

- MENU** → [Setup] → [ Connection] → [TV Type].



- Select the desired item.

✓	<b>16:9</b> Select this to view your movies on a 16:9 (wide) TV.	
	Movies and photos recorded in 16:9 (wide) mode 	Movies and photos recorded in 4:3 mode 
	<b>4:3</b> Select this to view your movies and photos on a 4:3 standard TV.	
	Movies and photos recorded in 16:9 (wide) mode 	Movies and photos recorded in 4:3 mode 

[▲ Back to top](#)

- ▶ Operation Search
- ▶ Before use
- ▶ Getting started
- ▶ Recording
- ▶ Playback
- ▶ Playing images on a TV
- ▶ Saving images with an external device
- ▶ Using the Wi-Fi function
- ▶ Customizing your camcorder
- ▶ Troubleshooting
- ▶ Maintenance and precautions

[→ Contents list](#)

## HDMI Resolution

Select the output image resolution when connecting your camcorder to a TV with an HDMI cable.

1. MENU → [Setup] → [ Connection] → [HDMI Resolution].



2. Select the desired item.

<input checked="" type="checkbox"/>	<p><b>Auto</b> Normal setting (outputs the signal according to the TV automatically).</p>
	<p><b>1080p/480p* / 1080p/576p**</b> Outputs high definition image quality (HD) / MP4 movies with a 1080p signal and standard image quality (STD) movies with a 480p*/576p** signal. Select this setting when you watch movies that have been recorded with [ Frame Rate] set to [60p]*/[50p]**, on the 60p*/50p** compliant TV.</p>
	<p><b>1080i/480i* / 1080i/576i**</b> Outputs high definition image quality (HD) / MP4 movies with a 1080i signal and standard image quality (STD) movies with a 480i*/576i** signal.</p>
	<p><b>720p/480p* / 720p/576p**</b> Outputs high definition image quality (HD) / MP4 movies with a 720p signal and standard image quality (STD) movies with a 480p*/576p** signal.</p>
	<p><b>480p* / 576p**</b> Outputs the 480p*/576p** signal.</p>
	<p><b>480i* / 576i**</b> Outputs the 480i*/576i** signal.</p>

\* HDR-PJ790/ PJ790V

\*\* HDR-PJ780E/ PJ780VE/ PJ790E/ PJ790VE

### Notes

- When [ Frame Rate] is set to [60p]\*/[50p]\*\* and [HDMI Resolution] is set to [720p/480p]\*/[720p/576p]\*\* or [480p]\*/[576p]\*\*, HDMI signals cannot be output during recording.

[▲ Back to top](#)

- ▶ Operation Search
- ▶ Before use
- ▶ Getting started
- ▶ Recording
- ▶ Playback
- ▶ Playing images on a TV
- ▶ Saving images with an external device
- ▶ Using the Wi-Fi function
- ▶ Customizing your camcorder
- ▶ Troubleshooting
- ▶ Maintenance and precautions

[→ Contents list](#)

## CTRL FOR HDMI (Control for HDMI)

When connecting your camcorder to a "BRAVIA" Sync compatible TV with a HDMI cable, you can play back movies on your camcorder by aiming the TV's Remote Commander at the TV. [\[Details\]](#)

1. **MENU** → [Setup] → [ Connection] → [CTRL FOR HDMI].



2. Select the desired item.

✓	<b>On</b> Operates your camcorder using the TV's Remote Commander.
	<b>Off</b> Does not operate your camcorder using the TV's Remote Commander.

[▲ Back to top](#)

▶ Operation Search

▶ Before use

▶ Getting started

▶ Recording

▶ Playback

▶ Playing images on a TV

▶ Saving images with an external device

▶ Using the Wi-Fi function

▶ Customizing your camcorder

▶ Troubleshooting

▶ Maintenance and precautions

[→ Contents list](#)

## USB Connect

Select this item when a USB connection does not start even when you connect the camcorder to an external device with the USB Cable.

1. **MENU** → [Setup] → [↔Connection] → [USB Connect].



[▲ Back to top](#)

- ▶ Operation Search
- ▶ Before use
- ▶ Getting started
- ▶ Recording
- ▶ Playback
- ▶ Playing images on a TV
- ▶ Saving images with an external device
- ▶ Using the Wi-Fi function
- ▶ Customizing your camcorder
- ▶ Troubleshooting
- ▶ Maintenance and precautions

[→ Contents list](#)

## USB Connect Setting

You can set the USB transfer mode for connecting the camcorder to a computer or other USB device.

- MENU** → [Setup] → [ Connection] → [USB Connect Setting].



- Select the desired item.

<input checked="" type="checkbox"/>	<p><b>Auto</b> The camcorder automatically selects the USB transfer mode depending on the connected device.</p>
	<p><b>MTP</b> This is a USB transfer mode compatible with certain types of computers.</p>
	<p><b>Mass Storage</b> This is a USB transfer mode compatible with many types of USB devices.</p>

### Notes

- When you connect the camcorder to other devices using the [MTP] mode, movies that have been recorded with the same image quality as the one currently selected (selected with the [ / / Setting] menu) can only be displayed on the connected device.
- When the camcorder is connected to an external device in the [MTP] mode, movie files will be displayed with the recorded date, however, some information, such as area information, included in the movie files cannot be displayed on the connected device. To import images from the camcorder to your computer, use the "PlayMemories Home" software.
- If the "Device Stage\*\*" window does not open when you connect the camcorder to a computer equipped with Windows 7 or Windows 8, set [USB Connect Setting] to [Auto].

\* "Device Stage" is a menu of Windows 7 or Windows 8, that is used to manage devices (camcorder, camera, etc.) that are connected to the computer.

[▲ Back to top](#)

- ▶ Operation Search
- ▶ Before use
- ▶ Getting started
- ▶ Recording
- ▶ Playback
- ▶ Playing images on a TV
- ▶ Saving images with an external device
- ▶ Using the Wi-Fi function
- ▶ Customizing your camcorder
- ▶ Troubleshooting
- ▶ Maintenance and precautions

[→ Contents list](#)

## USB LUN Setting

Improves compatibility with external devices by limiting the functions of the USB connection.

1. **MENU** → [Setup] → [ Connection] → [USB LUN Setting].



2. Select the desired item.

✓	<p><b>Multi</b> Use this setting for ordinary operations.</p>
	<p><b>Single</b> Try this setting only if you cannot connect to an external device.</p>

[▲ Back to top](#)



- ▶ Operation Search
- ▶ Before use
- ▶ Getting started
- ▶ Recording
- ▶ Playback
- ▶ Playing images on a TV
- ▶ Saving images with an external device
- ▶ Using the Wi-Fi function
- ▶ Customizing your camcorder
- ▶ Troubleshooting
- ▶ Maintenance and precautions

[→ Contents list](#)

## Beep

You can turn on or off the operation sound.

1. **MENU** → [Setup] → [ General Settings] → [Beep].



2. Select the desired item.

<input checked="" type="checkbox"/>	<b>On</b> A melody sounds when you start/stop recording, or operate your camcorder.
<input type="checkbox"/>	<b>Off</b> Cancels the melody.

[▲ Back to top](#)

- ▶ Operation Search
- ▶ Before use
- ▶ Getting started
- ▶ Recording
- ▶ Playback
- ▶ Playing images on a TV
- ▶ Saving images with an external device
- ▶ Using the Wi-Fi function
- ▶ Customizing your camcorder
- ▶ Troubleshooting
- ▶ Maintenance and precautions

[→ Contents list](#)

## LCD Brightness

You can adjust the brightness of the LCD screen.

1. **MENU** → [Setup] → [  General Settings ] → [LCD Brightness ].



2. Select the desired item.

✓	<b>Normal</b> Normal setting (normal brightness).
	<b>Bright</b> Select this when the LCD screen is not bright enough. This adjustment does not affect the recorded images in any way.

[▲ Back to top](#)

▶ Operation Search

▶ Before use

▶ Getting started

▶ Recording

▶ Playback

▶ Playing images on a TV

▶ Saving images with an external device

▶ Using the Wi-Fi function

▶ Customizing your camcorder

▶ Troubleshooting

▶ Maintenance and precautions

[→ Contents list](#)

[Top page](#) > [Customizing your camcorder](#) > [Setup](#) > [Your Location \(HDR-PJ780VE/ PJ790V/ PJ790VE\)](#)

## Your Location (HDR-PJ780VE/ PJ790V/ PJ790VE)

You can display your current location.

1. **MENU** → [Setup] → [ General Settings] → [Your Location].



Your current location appears on the Map View.

### Related topics

[Obtaining a map of the current location \(triangulation priority mode\) \(Models with GPS\)](#)

[▲ Back to top](#)

- ▶ Operation Search
- ▶ Before use
- ▶ Getting started
- ▶ Recording
- ▶ Playback
- ▶ Playing images on a TV
- ▶ Saving images with an external device
- ▶ Using the Wi-Fi function
- ▶ Customizing your camcorder
- ▶ Troubleshooting
- ▶ Maintenance and precautions

[→ Contents list](#)

## Airplane Mode (HDR-PJ780VE/ PJ790V/ PJ790VE)

You can deactivate all GPS related settings temporarily when you are on board an airplane.

1. **MENU** → [Setup] → [ General Settings] → [Airplane Mode].



2. Select the desired item.

✓	<b>Off</b> Normal setting.
	<b>On (✚)</b> Use the setting when you are on board an airplane.

[▲ Back to top](#)

- ▶ Operation Search
- ▶ Before use
- ▶ Getting started
- ▶ Recording
- ▶ Playback
- ▶ Playing images on a TV
- ▶ Saving images with an external device
- ▶ Using the Wi-Fi function
- ▶ Customizing your camcorder
- ▶ Troubleshooting
- ▶ Maintenance and precautions

[→ Contents list](#)

## GPS Setting (HDR-PJ780VE/ PJ790V/ PJ790VE)

You can select whether the camcorder receives or does not receive GPS signals.

1. **MENU** → [Setup] → [ General Settings] → [GPS Setting].



2. Select the desired item.

✓	<p><b>On</b>                  Receives GPS signals.                  The location information will not be recorded until triangulating is finished successfully.</p>
	<p><b>Off</b>                  Does not receive GPS signals.                  The location information that has previously been recorded will be invalid.</p>

[▲ Back to top](#)

- ▶ Operation Search
- ▶ Before use
- ▶ Getting started
- ▶ Recording
- ▶ Playback
- ▶ Playing images on a TV
- ▶ Saving images with an external device
- ▶ Using the Wi-Fi function
- ▶ Customizing your camcorder
- ▶ Troubleshooting
- ▶ Maintenance and precautions

[→ Contents list](#)

## REC Lamp

You can make the camera recording lamp on the front of your camcorder not to turn on.

1. **MENU** → [Setup] → [ General Settings] → [REC Lamp].



2. Select the desired item.

✓	<b>On</b> The camera recording lamp lights up.
	<b>Off</b> The camera recording lamp does not light up.

[▲ Back to top](#)

- ▶ Operation Search
- ▶ Before use
- ▶ Getting started
- ▶ Recording
- ▶ Playback
- ▶ Playing images on a TV
- ▶ Saving images with an external device
- ▶ Using the Wi-Fi function
- ▶ Customizing your camcorder
- ▶ Troubleshooting
- ▶ Maintenance and precautions

[→ Contents list](#)

## Remote Ctrl

1. **MENU** → [Setup] → [ General Settings] → [Remote Ctrl].



2. Select the desired item.

<input checked="" type="checkbox"/>	<b>On</b> Select this when you use the supplied Wireless Remote Commander.
<input type="checkbox"/>	<b>Off</b> Select this when you do not use supplied Wireless Remote Commander.

### Related topics

[Parts and controls \(Wireless Remote Commander\)](#)

[▲ Back to top](#)

- ▶ Operation Search
- ▶ Before use
- ▶ Getting started
- ▶ Recording
- ▶ Playback
- ▶ Playing images on a TV
- ▶ Saving images with an external device
- ▶ Using the Wi-Fi function
- ▶ Customizing your camcorder
- ▶ Troubleshooting
- ▶ Maintenance and precautions

[→ Contents list](#)

## Language Setting

---

You can select the language to be used on the LCD screen.

The camcorder offers [ENG[SIMP]] (simplified English) for when you cannot find your native tongue among the options.

1. **MENU** → [Setup] → [ General Settings] → [Language Setting].



2. Select the desired language.

[▲ Back to top](#)



- ▶ Operation Search
- ▶ Before use
- ▶ Getting started
- ▶ Recording
- ▶ Playback
- ▶ Playing images on a TV
- ▶ Saving images with an external device
- ▶ Using the Wi-Fi function
- ▶ Customizing your camcorder
- ▶ Troubleshooting
- ▶ Maintenance and precautions

[➔ Contents list](#)

## 24p Mode (HDR-PJ780E/ PJ780VE/ PJ790E/ PJ790VE)

You can record 24p movies with changing the signal format.

1. **MENU** → [Setup] → [ General Settings] → [24p Mode] → [OK].



If you want to return the system to 50i mode, select [OK] in the [Cancel 24p Mode] screen.

### Notes

- The camcorder reboots each time you change the setting.
- When you change the setting, formatting the recording media is required.
- When you select [24p Mode], the following settings will be limited.
  - The movie recording format is limited to AVCHD 24p (FX, FH).
  - Depending on the connected TV, images may not be played back normally because the video signal output from the camcorder is in the NTSC format.
  - You cannot set [ HDMI/MP4/STD Setting] and [ Frame Rate].

[▲ Back to top](#)

- ▶ Operation Search
- ▶ Before use
- ▶ Getting started
- ▶ Recording
- ▶ Playback
- ▶ Playing images on a TV
- ▶ Saving images with an external device
- ▶ Using the Wi-Fi function
- ▶ Customizing your camcorder
- ▶ Troubleshooting
- ▶ Maintenance and precautions

[➔ Contents list](#)

## Calibration

Use this function if the buttons on the touch panel does not work correctly.

It is recommended that you connect your camcorder to the wall outlet (wall socket) using the supplied AC Adaptor during the operation.

1. **MENU** → [Setup] → [ General Settings] → [Calibration].



2. Touch " × " displayed on the screen with the corner of memory card or the like 3 times.

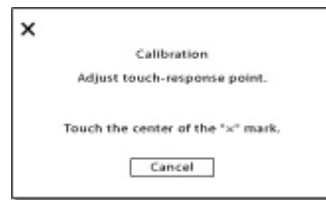

Touch [Cancel] to cancel calibration.

### Notes

- If you did not press the right spot, try the calibration again.
- Do not use a sharp-pointed object for calibration. Doing so may damage the LCD screen.
- You cannot calibrate the LCD screen if it is rotated, or closed with the screen facing out.

[▲ Back to top](#)

- ▶ Operation Search
- ▶ Before use
- ▶ Getting started
- ▶ Recording
- ▶ Playback
- ▶ Playing images on a TV
- ▶ Saving images with an external device
- ▶ Using the Wi-Fi function
- ▶ Customizing your camcorder
- ▶ Troubleshooting
- ▶ Maintenance and precautions

[→ Contents list](#)

## Battery Info

---

You can check the estimated remaining capacity of the battery.

1. **MENU** → [Setup] → [  General Settings] → [Battery Info].



The battery information appears.

[▲ Back to top](#)

- ▶ Operation Search
- ▶ Before use
- ▶ Getting started
- ▶ Recording
- ▶ Playback
- ▶ Playing images on a TV
- ▶ Saving images with an external device
- ▶ Using the Wi-Fi function
- ▶ Customizing your camcorder
- ▶ Troubleshooting
- ▶ Maintenance and precautions

[→ Contents list](#)

## Power Save

You can change the settings for the backlight of the LCD screen and the power status of the camcorder.

1. **MENU** → [Setup] → [  General Settings] → [Power Save].



2. Select the desired item.

✓	<p><b>Standard</b></p> <p>The backlight of the LCD screen turns dark automatically if you do not attempt to operate your camcorder for more than about 1 minute. The camcorder turns off automatically if you do not attempt to operate your camcorder for more than about 2 minutes.</p>
	<p><b>Max</b></p> <p>The brightness of the LCD screen is adjusted to the surrounding brightness automatically. The backlight of the LCD screen turns dark automatically if you do not attempt to operate your camcorder for more than about 15 seconds. The camcorder turns off automatically if you do not attempt to operate your camcorder for more than about 1 minute.</p>
	<p><b>Off</b></p> <p>The backlight of the LCD screen is always on brightly. The camcorder does not turn off automatically.</p>

[▲ Back to top](#)

- ▶ Operation Search
- ▶ Before use
- ▶ Getting started
- ▶ Recording
- ▶ Playback
- ▶ Playing images on a TV
- ▶ Saving images with an external device
- ▶ Using the Wi-Fi function
- ▶ Customizing your camcorder
- ▶ Troubleshooting
- ▶ Maintenance and precautions

[→ Contents list](#)

## Initialize

---

All the settings return to the default.  
Even if you use this function, all movies and photos are retained.

1. **MENU** → [Setup] → [ General Settings] → [Initialize].



[▲ Back to top](#)

- ▶ Operation Search
- ▶ Before use
- ▶ Getting started
- ▶ Recording
- ▶ Playback
- ▶ Playing images on a TV
- ▶ Saving images with an external device
- ▶ Using the Wi-Fi function
- ▶ Customizing your camcorder
- ▶ Troubleshooting
- ▶ Maintenance and precautions

[→ Contents list](#)

## Demo Mode

When the camcorder is connected to a wall outlet (wall socket) and no operation is attempted within a certain period with the movie recording mode or the Event View mode set, a demonstration movie starts playing.

1. **MENU** → [Setup] → [ General Settings] → [Demo Mode].



2. Select the desired item.

✓	<b>On</b> Make the settings for playback of the demonstration movie.
	<b>Off</b> The demonstration does not appear.

### Notes

- In the default setting, the demonstration movie is in the Event View. If you delete the demonstration movie, you cannot recover it.
- A movie you have recorded will be registered as the demonstration movie if it satisfies all of the following conditions.
  - The movie is protected.
  - The movie is the one that was recorded first.
  - The movie is saved on the internal memory.
  - The movie is recorded with high definition image quality (HD).
- When you operate your camcorder, the demonstration playback will be suspended.

[▲ Back to top](#)

- ▶ Operation Search
- ▶ Before use
- ▶ Getting started
- ▶ Recording
- ▶ Playback
- ▶ Playing images on a TV
- ▶ Saving images with an external device
- ▶ Using the Wi-Fi function
- ▶ Customizing your camcorder
- ▶ Troubleshooting
- ▶ Maintenance and precautions

[→ Contents list](#)

## Date & Time Setting

1. **MENU** → [Setup] → [⌚Clock Settings] → [Date & Time Setting].



2. Select the desired item ([Date & Time Format], [Daylight Savings]/[Summer Time], or [Date & Time]).

### Date & Time Format

You can select one from 4 types of date and time format.

### Daylight Savings / Summer Time

You can change this setting without stopping the clock.

✓	<b>Off</b> Does not set the summertime.
	<b>On</b> Sets the summertime. The clock is set to move the time forward 1 hour.

### Date & Time

You can set the clock.

[▲ Back to top](#)

- ▶ Operation Search
- ▶ Before use
- ▶ Getting started
- ▶ Recording
- ▶ Playback
- ▶ Playing images on a TV
- ▶ Saving images with an external device
- ▶ Using the Wi-Fi function
- ▶ Customizing your camcorder
- ▶ Troubleshooting
- ▶ Maintenance and precautions

[→ Contents list](#)

## Area Setting

You can adjust a time difference without stopping the clock. Select your local area when using the camcorder in other time zones.

1. **MENU** → [Setup] → [Clock Settings] → [Area Setting].



2. Select the desired item.  
**For models without GPS**

✓	<b>Home</b> Select this item when you are going to use the camcorder in the area where you are living.
	<b>Destination</b> (👤) Select this item when you want to use the camcorder with the area setting set to another place.

**For models with GPS**  
 Set the area.

### Related topics

Information on your camcorder model: [Model Information](#)  
[World time difference](#)

[▲ Back to top](#)



- ▶ Operation Search
- ▶ Before use
- ▶ Getting started
- ▶ Recording
- ▶ Playback
- ▶ Playing images on a TV
- ▶ Saving images with an external device
- ▶ Using the Wi-Fi function
- ▶ Customizing your camcorder
- ▶ Troubleshooting
- ▶ Maintenance and precautions

[→ Contents list](#)

## Auto Clock ADJ (HDR-PJ780VE/ PJ790V/ PJ790VE)

The camcorder can maintain accurate time automatically by acquiring time information from the GPS system.

1. **MENU** → [Setup] → [Clock Settings] → [Auto Clock ADJ].



2. Select the desired item.

✓	<b>On</b> Maintains accurate time automatically.
	<b>Off</b> Does not maintain accurate time using the GPS system.

### Notes

- You must set the date and time on your camcorder before use. [\[Details\]](#)
- There may be discrepancies of a few seconds even if [Auto Clock ADJ] is activated.
- This function automatically adjusts the clock when the camcorder receives GPS signals and finishes triangulating successfully while the power is on. Once the clock is adjusted, it will not be adjusted until the next time you turn the camcorder on again.
- The clock may not be adjusted to the correct time automatically using the GPS system, depending on the country/region selected for your camcorder. In this case, set [Auto Clock ADJ] to [Off].

[▲ Back to top](#)

- ▶ Operation Search
- ▶ Before use
- ▶ Getting started
- ▶ Recording
- ▶ Playback
- ▶ Playing images on a TV
- ▶ Saving images with an external device
- ▶ Using the Wi-Fi function
- ▶ Customizing your camcorder
- ▶ Troubleshooting
- ▶ Maintenance and precautions

[→ Contents list](#)

## Auto Area ADJ (HDR-PJ780VE/ PJ790V/ PJ790VE)

The camcorder can compensate for time differences automatically by acquiring location information from the GPS system.

1. **MENU** → [Setup] → [Clock Settings] → [Auto Area ADJ].



2. Select the desired item.

✓	<b>On</b> Compensates for time differences automatically.
	<b>Off</b> Does not compensate for time differences automatically.

### Notes

- You must set the date and time on your camcorder before use. [\[Details\]](#)
- The camcorder may not compensate for the time difference automatically, depending on the country/region selected for your camcorder. In this case, set [Auto Area ADJ] to [Off].

[▲ Back to top](#)

▶ Operation Search

▶ Before use

▶ Getting started

▶ Recording

▶ Playback

▶ Playing images on a TV

▶ Saving images with an external device

▶ Using the Wi-Fi function

▶ Customizing your camcorder

▶ Troubleshooting

▶ Maintenance and precautions

[➔ Contents list](#)

## If you have problems

---

If you run into any problems using your camcorder, follow the steps below.

1. Check the items under "Troubleshooting", and inspect your camcorder.

If a code such as "C:(or E:) □ □ : □ □ " appears on the screen, see "[Self-diagnosis display](#)."

2. Disconnect the power source, attach the power source again after about 1 minute, and turn the camcorder on.
3. Press RESET using a pointed object, and turn the camcorder on. [\[Details\]](#)
  - If you press RESET, all settings, including the clock setting, are reset.
4. Contact your Sony dealer or local authorized Sony service facility.
  - You may need to initialize or change the current internal memory of your camcorder depending on the problem. If you do so, the data stored on the internal memory will be deleted. Be sure to save the data on the internal memory on other media (backup) before sending your camcorder for repair. We will not compensate you for any loss of internal memory data.
  - During repair, we may check a minimum amount of data stored on the internal memory in order to investigate the problem. However, your Sony dealer will neither copy nor retain your data.

---

### Related topics

Information on your camcorder model: [Model Information](#)

[▲ Back to top](#)

- ▶ Operation Search
- ▶ Before use
- ▶ Getting started
- ▶ Recording
- ▶ Playback
- ▶ Playing images on a TV
- ▶ Saving images with an external device
- ▶ Using the Wi-Fi function
- ▶ Customizing your camcorder
- ▶ Troubleshooting
- ▶ Maintenance and precautions

[→ Contents list](#)

## Overall operations/Wireless Remote Commander

---



### The power does not turn on.

- Attach a charged battery pack to the camcorder. [\[Details\]](#)
- The plug of the AC Adaptor has been disconnected from the wall outlet (wall socket). Connect it to the wall outlet (wall socket). [\[Details\]](#)

### The camcorder does not operate even when the power is set to on.

- It takes a few seconds for your camcorder to be ready to shoot after the power is turned on. This is not a malfunction.
- Disconnect the AC Adaptor from the wall outlet (wall socket) or remove the battery pack, then reconnect it after about 1 minute. If the functions still do not work, press RESET using a pointed object. (If you press RESET, all settings, including the clock setting, are reset. [\[Details\]](#))

### The menu settings have been changed automatically.

- While Intelligent Auto is active, some menu settings related to image quality will be changed automatically.
- The following menu items return to the default settings when you switch between movie recording and photo recording and playback modes.
  - [  Fader]
  - [  Self-Timer]
  - [Tele Macro]

### The camcorder gets warm.

- Your camcorder may become warm during operation. This is not a malfunction.

### A rattling noise is heard when the camcorder is shaken.

- If no noise is heard when the camcorder is turned on and is in the movie/photo recording mode, the noise is produced by the movement of the internal lens. This is not a malfunction.

### Intelligent Auto is canceled.

- The Intelligent Auto setting is canceled if you change the following settings:
  - [Smth Slw REC]
  - [Golf Shot]
  - [White Balance]
  - [Spot Meter/Fcs]
  - [Spot Meter]
  - [Spot Focus]
  - [Exposure]
  - [Focus]
  - [Low Lux]
  -

- [Scene Selection]
- [  Cinematone]
- [Auto Wind NR]
- [Tele Macro]
- [  SteadyShot]
- [  SteadyShot]
- [Auto Back Light]
- [Face Detection]

---

### **The supplied Wireless Remote Commander does not function.**

- Set [Remote Ctrl] to [On]. [\[Details\]](#)
- Insert a battery into the battery holder with the +/- polarities correctly matching the +/- marks. [\[Details\]](#)
- Remove any obstructions between the Wireless Remote Commander and the remote sensor.
- Point the remote sensor away from strong light sources such as direct sunlight or overhead lighting. Otherwise, the Wireless Remote Commander may not function properly.

---

### **Another DVD device operates when you use the supplied Wireless Remote Commander.**

- Select a commander mode other than DVD 2 for your DVD device, or cover the sensor of your DVD device with black paper.

---

### **Related topics**

Information on your camcorder model: [Model Information](#)

[▲ Back to top](#)

---

Copyright 2013 Sony Corporation

- ▶ Operation Search
- ▶ Before use
- ▶ Getting started
- ▶ Recording
- ▶ Playback
- ▶ Playing images on a TV
- ▶ Saving images with an external device
- ▶ Using the Wi-Fi function
- ▶ Customizing your camcorder
- ▶ Troubleshooting
- ▶ Maintenance and precautions

[→ Contents list](#)

## Batteries/power sources

---

### The power abruptly turns off.

- Use the AC Adaptor.
- In the default setting, the camcorder turns itself off when no operations are performed for about 2 minutes ([Power Save]). Change the setting of [Power Save], or turn on the power again. [\[Details\]](#)
- Charge the battery pack. [\[Details\]](#)

### The CHG (charge) lamp does not light while the battery pack is being charged.

- Close the LCD screen. [\[Details\]](#)
- Attach the battery pack to the camcorder correctly. [\[Details\]](#)
- Connect the power cord (mains lead) to the wall outlet (wall socket) properly.
- The battery charge is completed. [\[Details\]](#)

### The CHG (charge) lamp flashes while the battery pack is being charged.

- When the battery is being charged using the Built-in USB Cable, disconnect the Built-in USB Cable and connect it again.
- If the temperature of the battery pack is too high or too low, you may not be able to charge it. [\[Details\]](#)
- Attach the battery pack to the camcorder correctly. If the problem persists, disconnect the AC Adaptor from the wall outlet (wall socket) and contact your Sony dealer. The battery pack may be damaged. [\[Details\]](#)

### The remaining battery time indicator does not indicate the correct time.

- The ambient temperature is too high or too low. This is not a malfunction.
- The battery pack has not been charged enough. Fully charge the battery again. If the problem persists, replace the battery pack with a new one. [\[Details\]](#)
- The indicated time may not be correct depending on the environment in which the camcorder is used.

### The battery pack is quickly discharged.

- The ambient temperature is too high or low. This is not a malfunction.
- The battery pack has not been charged enough. Fully charge the battery again. If the problem persists, replace the battery pack with a new one. [\[Details\]](#)

### Related topics

Information on your camcorder model: [Model Information](#)

[▲ Back to top](#)

▶ Operation Search

▶ Before use

▶ Getting started

▶ Recording

▶ Playback

▶ Playing images on a TV

▶ Saving images with an external device

▶ Using the Wi-Fi function

▶ Customizing your camcorder

▶ Troubleshooting

▶ Maintenance and precautions

[→ Contents list](#)

## LCD screen/viewfinder

---

### Menu items are grayed out.

- You cannot select grayed out items in the current recording/playback situation.
- There are some functions you cannot activate simultaneously.

### The buttons do not appear on the LCD screen.

- Touch the LCD screen lightly.

### The buttons on the touch panel do not work correctly or do not work at all.

- Adjust the touch panel ([Calibration]). [\[Details\]](#)

### The buttons on the LCD screen quickly disappear.

- If you set [Display Setting] to [On], the buttons do not disappear from the LCD screen while in recording mode. [\[Details\]](#)

### There are dots in the shape of a grid on the screen.

- These dots are a normal result of the manufacturing process of the screen and do not affect the recording in any way.

### The backlight of the LCD screen turns off if you do not attempt to operate your camcorder for a while.

- In the default setting, the backlight of the LCD screen turns off automatically if you do not attempt to operate your camcorder for more than about 1 minute ([Power Save]). [\[Details\]](#)

### The image in the viewfinder is not clear.

- Move the viewfinder lens adjustment lever until the image appears clearly. [\[Details\]](#)

### The image in the viewfinder is no-longer displayed.

- Close the LCD panel. Even if the viewfinder is pulled out, no image is displayed in the viewfinder when the LCD panel is open.

### Related topics

Information on your camcorder model: [Model Information](#)

[▲ Back to top](#)

- ▶ Operation Search
- ▶ Before use
- ▶ Getting started
- ▶ Recording
- ▶ Playback
- ▶ Playing images on a TV
- ▶ Saving images with an external device
- ▶ Using the Wi-Fi function
- ▶ Customizing your camcorder
- ▶ Troubleshooting
- ▶ Maintenance and precautions

[➔ Contents list](#)

## Memory card

---

### Operations using the memory card cannot be performed.

- If you use the memory card formatted on a computer, format it again on your camcorder. [\[Details\]](#)

### Images stored on the memory card cannot be deleted.

- The maximum number of images that you can delete on the index screen at one time is 100.
- You cannot delete the protected images.

### The data file name is not indicated correctly or flashes.

- The file is damaged.
- The file format is not supported by your camcorder. [\[Details\]](#)

### Images cannot be played back or the memory card is not recognized.

- The playback device does not support playing back memory cards. [\[Details\]](#)

### Related topics

Information on your camcorder model: [Model Information](#)

[▲ Back to top](#)



▶ Operation Search

▶ Before use

▶ Getting started

▶ Recording

▶ Playback

▶ Playing images on a TV

▶ Saving images with an external device

▶ Using the Wi-Fi function

▶ Customizing your camcorder

▶ Troubleshooting

▶ Maintenance and precautions

[→ Contents list](#)

## Recording

Refer also to "[Memory card](#)".

### Pressing START/STOP or PHOTO does not record images.

- The playback screen is displayed. Stop playback, and select **MENU** → [Shooting Mode] → [ Movie] or [ Photo].
- Your camcorder is recording the image you have just shot on the recording media. You cannot make new recording during this period.
- The recording media is full. Delete unnecessary images. [\[Details\]](#)
- Total number of movie scenes or photos exceeds the recordable capacity of your camcorder [\[Details\]](#)[\[Details\]](#). Delete unnecessary images [\[Details\]](#).

### Photos cannot be recorded.

- You cannot record photos together with:
  - [Smth Slw REC]
  - [Golf Shot]
  - [ Fader]
- The camcorder cannot shoot photos while it is in the movie recording mode, depending on the [ REC Mode] or [ Frame Rate] selected.

### The access lamp remains lit or flashing even if recording has stopped.

- Your camcorder is recording the scene you have just shot on the memory card.

### The imaging field looks different.

- The imaging field may look different depending on the condition of your camcorder. This is not a malfunction.

### The flash does not work.

- You cannot record with the built-in flash while:
  - the (Movie) lamp is on
  - [Conversion Lens] is set to other than [Off]
- Even if auto flash or (Auto red eye reduction) is selected, you cannot use the flash with:
  - NightShot
  - manually-set [IRIS] or [Shutter Speed] (when either one of them has been assigned to the MANUAL dial)
  - [Spot Meter/Fcs]
  - [Spot Meter]
  - [Manual] in [Exposure]
  - [Night Scene], [Sunrise&Sunset], [Fireworks], [Landscape], [Spotlight], [Beach] or [Snow] in [Scene Selection]

---

**The actual recording time for movies is less than the expected recording time of the recording media.**

- Depending on the recording conditions, the time available for recording may be shorter, for example when recording a fast moving object, etc.

---

**The camcorder stops operating.**

- If you keep applying vibration on the camcorder, recording may stop.

---

**There is a slight time lag between the moment when START/STOP is pressed and the actual movie recording starts or stops.**

- On your camcorder, there may be a slight time difference between the moment when you press START/STOP and when the actual movie recording starts/stops. This is not a malfunction.

---

**The horizontal to vertical ratio of the movie (16:9 (wide)/4:3) cannot be changed.**

- The horizontal to vertical ratio of high definition image quality (HD) movies and MP4 movies are 16:9 (wide).





---

**The auto focus does not function.**

- Set [Focus] to [Auto]. [\[Details\]](#)
- The recording conditions are not suitable for auto focus. Adjust the focus manually. [\[Details\]](#)

---

**SteadyShot does not function.**

- Set [ SteadyShot] to [Active] or [Standard] [\[Details\]](#), [ SteadyShot] to [On] [\[Details\]](#).
- Even if [ SteadyShot] is set to [Active] or [Standard], [ SteadyShot] to [On], your camcorder may not be able to compensate for excessive vibrations.
- Set [Conversion Lens] to [Off].

---

**Images cannot be recorded or played back correctly.**

- If you record and delete images repeatedly for a long time, the files on the recording media may become fragmented and images cannot be recorded or played back correctly. After backing up the images on other media, format the recording media on your camcorder. [\[Details\]](#)

---

**The subjects passing across the camcorder very fast appear crooked.**

- This is called the focal plane phenomenon. This is not a malfunction. Because of the way the image device (CMOS sensor) reads out image signals, the subjects passing by the lens rapidly might appear crooked depending on the recording conditions.

---

**The color of the image is not correctly displayed.**

- Press NIGHTSHOT to cancel the NightShot function. [\[Details\]](#)

---

**The screen image is bright, and the subject does not appear on the screen.**

- Press NIGHTSHOT to cancel the NightShot function. [\[Details\]](#)

---

**Horizontal stripes appear on the images.**

- This occurs when recording images under a fluorescent lamp, sodium lamp, or mercury lamp. This is not a malfunction.

---

**Black bands appear when you record a TV screen or computer screen.**

- Set [ SteadyShot] to an option except for [Active]. [\[Details\]](#)

---

**LCD brightness cannot be set.**

- You cannot set LCD brightness when:
  - The LCD panel is closed on your camcorder with the LCD screen facing out.
  - The power is supplied from the AC Adaptor.

---

**Sound is not recorded correctly.**

- If you connect or disconnect an external microphone, etc. while recording movies, the sound may not be recorded correctly. The sound will be recorded correctly by restoring the microphone connection at the start of movie recording.
- If you turn the volume down to the minimum level by adjusting in [Audio Rec Level], the sound of movies cannot be recorded. [\[Details\]](#)

---

**Photos are recorded automatically.**

- In the default setting, photos are recorded automatically when the camcorder detects a smile ([Smile Shutter]). [\[Details\]](#)

---

**Related topics**

Information on your camcorder model: [Model Information](#)

[▲ Back to top](#)

- ▶ Operation Search
- ▶ Before use
- ▶ Getting started
- ▶ Recording
- ▶ Playback
- ▶ Playing images on a TV
- ▶ Saving images with an external device
- ▶ Using the Wi-Fi function
- ▶ Customizing your camcorder
- ▶ Troubleshooting
- ▶ Maintenance and precautions

[→ Contents list](#)

## Playback

### Images cannot be played back.

- Select the type of recording media you want to play back. [\[Details\]](#)
- Select the image quality of the movie you want to play back. [\[Details\]](#)
- Images recorded on other devices may not be played back. This is not a malfunction.

### Photos cannot be played back.

- Photos cannot be played back if you have modified files or folders, or have edited the data on a computer. (The file name flashes in that case.) This is not a malfunction.



### The movie freezes.

- Photos which were recorded while recording a movie are played back. In the default setting, movies and photos are played back continuously.

### appears on a thumbnail.

- This may appear on an image recorded on other devices, edited on a computer, etc.
- You removed the AC Adaptor or the battery pack while the recording media icon at the top right corner of the screen flashes, or before the access lamp is turned off after recording. This may damage your image data and  is displayed.

### appears on a thumbnail.

- The image data base file may be damaged.
- Check the data base file by selecting **MENU** → [Setup] → [Media Settings] → [Repair Img. DB F.] → the recording medium. If it still appears, delete the image with . [\[Details\]](#)

### No sound or only a quiet sound is heard during playback.

- Turn up the volume. [\[Details\]](#)
- If you turn the volume down to the minimum level by adjusting in [Audio Rec Level], the sound of movies cannot be recorded. [\[Details\]](#)
- Sounds are not recorded while shooting with [Smth Slw REC] or [Golf Shot].

### Left and right sound is heard unbalanced when playing back movies on computers or other devices.

- Change the sound conversion type (downmix type) when playing back on 2ch stereo devices. Refer to the instruction manual supplied with your playback device for details.

- Change the sound to 2ch when creating a disc using the “PlayMemories Home” software.
  - This happens when sound recorded in 5.1ch surround is converted to 2ch (normal stereo sound) by a computer or other device. This is not a malfunction.
  - Record sound with [Audio Mode] set to [2ch Stereo]. [\[Details\]](#)
- 

**The demonstration movies cannot be played.**

- Select the internal memory for the recording media, and the high definition image quality (HD).
- 

**A movie is played back automatically.**

- Movies play automatically as a demonstration movie when the filmed movie meets a certain condition on your camcorder. This is not a malfunction. [\[Details\]](#)
- 

**Related topics**

Information on your camcorder model: [Model Information](#)

---

[▲ Back to top](#)

Copyright 2013 Sony Corporation

▶ Operation Search

▶ Before use

▶ Getting started

▶ Recording

▶ Playback

▶ Playing images on a TV

▶ Saving images with an external device

▶ Using the Wi-Fi function

▶ Customizing your camcorder

▶ Troubleshooting

▶ Maintenance and precautions

[→ Contents list](#)

## Editing movies/photos on your camcorder

---

### Unable to edit.

- Unable to edit because of the condition of the image.
- You cannot edit the files based on Map View (models with GPS).

### A movie cannot be divided.

- The following movies cannot be divided.
  - Movies that are too short
  - MP4 movies
- Release the protection, and then divide. [\[Details\]](#)

### The demonstration movies cannot be deleted.

- Release the protection, and then delete them. [\[Details\]](#)

### Related topics

Information on your camcorder model: [Model Information](#)

[▲ Back to top](#)

▶ Operation Search

▶ Before use

▶ Getting started

▶ Recording

▶ Playback

▶ Playing images on a TV

▶ Saving images with an external device

▶ Using the Wi-Fi function

▶ Customizing your camcorder

▶ Troubleshooting

▶ Maintenance and precautions

[→ Contents list](#)

## Playback on the TV

---

### Neither image nor sound is played on the connected TV.

- Images are not output from the HDMI OUT jack, if copyright protection signals are recorded in the images.

### The top, bottom, right, and left edges of images are trimmed slightly on a connected TV.

- The LCD screen of your camcorder can display recording images across the entire screen (full pixel display). However, this may cause slight trimming of the top, bottom, right, and left edges of images when played back on a TV which is not compatible with full pixel display.
- It is recommended you record images using the outer frame of [Grid Line] as a guide. [\[Details\]](#)

### The image appears distorted on the 4:3 TV.

- This happens when viewing an image recorded in the 16:9 (wide) mode on a 4:3 TV. Set [TV Type] correctly and play back the image. [\[Details\]](#)

### Black bands appear at the top and bottom of the screen of the 4:3 TV.

- This happens when viewing an image recorded in the 16:9 (wide) mode on a 4:3 TV. This is not a malfunction.

### The images being played back do not appear on the LCD screen when you connect the camcorder to a TV.

- Highlight Playback or a scenario will not appear on the LCD screen of the camcorder while it is connected to a TV and play back images.

### Related topics

Information on your camcorder model: [Model Information](#)

[▲ Back to top](#)

- ▶ [Operation Search](#)
- ▶ [Before use](#)
- ▶ [Getting started](#)
- ▶ [Recording](#)
- ▶ [Playback](#)
- ▶ [Playing images on a TV](#)
- ▶ [Saving images with an external device](#)
- ▶ [Using the Wi-Fi function](#)
- ▶ [Customizing your camcorder](#)
- ▶ [Troubleshooting](#)
- ▶ [Maintenance and precautions](#)

[→ Contents list](#)

## Copying/Connecting to other devices

---

### Images are not copied correctly.

- You cannot copy images using the HDMI cable.
- An AV Cable (sold separately) is not connected properly. Make sure that the cable is connected to the input jack of the device. [\[Details\]](#)

### Related topics

Information on your camcorder model: [Model Information](#)

[▲ Back to top](#)



▶ Operation Search

▶ Before use

▶ Getting started

▶ Recording

▶ Playback

▶ Playing images on a TV

▶ Saving images with an external device

▶ Using the Wi-Fi function

▶ Customizing your camcorder

▶ Troubleshooting

▶ Maintenance and precautions

[→ Contents list](#)

## Connecting to a computer

---

### **"PlayMemories Home" cannot be installed.**

- An Internet connection is required to install "PlayMemories Home."
- Check the computer environment or installation procedure required to install "PlayMemories Home."

### **"PlayMemories Home" does not work correctly.**

- Quit "PlayMemories Home" and restart your computer.

### **The camcorder is not recognized by the computer.**

- Disconnect all USB devices from the USB jack of your computer except the keyboard, mouse, and your camcorder.
- Disconnect the Built-in USB Cable from the computer and restart the computer, then connect the computer and your camcorder again in the correct order.
- When both the Built-in USB Cable and the USB jack of the camcorder are connected to the external devices at the same time, disconnect the one that is not connected to a computer.

### **Related topics**

Information on your camcorder model: [Model Information](#)

[▲ Back to top](#)

- ▶ Operation Search
- ▶ Before use
- ▶ Getting started
- ▶ Recording
- ▶ Playback
- ▶ Playing images on a TV
- ▶ Saving images with an external device
- ▶ Using the Wi-Fi function
- ▶ Customizing your camcorder
- ▶ Troubleshooting
- ▶ Maintenance and precautions

[→ Contents list](#)

## Self-diagnosis display

If indicators appear on the LCD screen or in the viewfinder, check the following.  
If the problem persists even after you have tried to fix a couple of times, contact your Sony dealer or local authorized Sony service facility. When you contact them, give them the complete error code beginning with C or E displayed on the screen.

- You may hear a melody when an important warning indicator appears on the screen.



### C:(or E:) □ □ : □ □ (Self-diagnosis display)

#### C:04: □ □

- The battery pack is not an "InfoLITHIUM" battery pack (V series). Use an "InfoLITHIUM" battery pack (V series). [\[Details\]](#)
- Connect the DC plug of the AC Adaptor securely to the DC IN jack of your camcorder. [\[Details\]](#)

#### C:06: □ □

- The battery pack temperature is high. Change the battery pack or place it in a cool place.

#### C:13: □ □ / C:32: □ □

- Remove the power source. Reconnect it and operate your camcorder again.

#### E: □ □ : □ □

- Follow the steps from 2 on "[If you have problems](#)".

### (Battery level warning)

- The battery pack is nearly used up.
- Depending on the operating environment or battery conditions,  may flash even with about 20 minutes of power remaining.

### (Warning indicator pertaining to battery pack temperature)

- The battery pack temperature is high. Change the battery pack or place it in a cool place.

### (Warning indicator pertaining to memory card)

#### Slow flashing

- Free spaces for recording images are running out. For the type of memory card you can use with your camcorder, see "[Types of memory card you can use with your camcorder](#)".

- No memory card is inserted. [\[Details\]](#)

#### Fast flashing

- There is not enough free spaces for recording images. After storing the images on other media, delete unnecessary images [\[Details\]](#), or format the memory card [\[Details\]](#).
- The image data base file may be damaged.  
Check the data base file by selecting **MENU** → [Setup] → [Media Settings] → [Repair Img. DB F.] → the recording medium.
- The memory card is damaged.

---

#### (Warning indicators pertaining to memory card formatting)

- The memory card is damaged.
- The memory card is not formatted correctly. [\[Details\]](#)

---

#### (Warning indicator pertaining to incompatible memory card)

- Incompatible memory card is inserted. [\[Details\]](#)

---

#### (Warning indicator pertaining to the write-protect of the memory card)

- The memory card is write-protected.
- Access to the memory card was restricted on another device.

---

#### (Warning indicator pertaining to the external device)

- The image data base file may be damaged.  
Check the data base file by selecting **MENU** → [Setup] → [Media Settings] → [Repair Img. DB F.] → the recording medium.
- The external device is damaged.

---

#### (Warning indicators pertaining to external device formatting)

- The external device is damaged.
- The external device is not formatted correctly

---

#### (Warning indicator pertaining to camera-shake warning)

- The amount of lights is not sufficient, so camera-shake easily occurs. Use the flash.
- The camcorder is unsteady, so camera-shake easily occurs. Hold the camcorder steady with both hands and record the image. However, note that the camera-shake warning indicator does not disappear.

---

#### (Warning indicator pertaining to photo recording)

- The recording media is full.
- Photos cannot be recorded during processing. Wait for a while, then record.
- When [REC Mode] is set to [Highest Quality **FX**], [60p Quality **PS**] (models with NTSC color system) or [50p Quality **PS**] (models with PAL color system), you cannot capture photos while

recording movies.

---

**Related topics**

Information on your camcorder model: [Model Information](#)

[▲ Back to top](#)

---

Copyright 2013 Sony Corporation

▶ Operation Search

▶ Before use

▶ Getting started

▶ Recording

▶ Playback

▶ Playing images on a TV

▶ Saving images with an external device

▶ Using the Wi-Fi function

▶ Customizing your camcorder

▶ Troubleshooting

▶ Maintenance and precautions

[→ Contents list](#)

## Warning Indicators

If messages appear on the screen, follow the instructions.



### Cannot recognize the internal memory. Format and use again.

- The internal memory of the camcorder is set differently from the default format. Performing [Format] may enable you to use your camcorder. Formatting will delete all data in the internal recording medium. [\[Details\]](#)

### Data error.

- An error occurred during reading or writing the internal memory of the camcorder.
- If the message is preceded by a GPS indicator, there may be some trouble with the GPS receiver. Turn on your camcorder again.
- This may occur when you keep applying shock to the camcorder.
- Movies recorded on other devices may not be played back.

### The Image Database File is damaged. Do you want to create a new file? HD movie management information is damaged. Create new information?

- The management file is damaged. When you select [Yes], a new management file is created. The old recorded images on the media cannot be played back (Image files are not damaged). If you execute [Repair Img. DB F.] after creating new information, playing back the old recorded images may become possible. If it does not work, copy the image using the "PlayMemories Home" software.

### There is no Image Database File Movies cannot be recorded or played Create a new file? There is no HD movie management information. Create new information?

- You cannot record or play back movies because no movie management information exists. If you select [Yes], new management information is created and you can record or play back movies.

### Inconsistencies found in image database file. Do you want to repair the image database file?

### The Image Database File is damaged. Do you want to repair the Image Database File? Inconsistencies found in image database file. Cannot record or play HD movies. Do you want to repair the image database file?

- You cannot record or play back movies because no movie management information exists. If you select , new management information is created and you can record or play back movies.

### Inconsistencies found in the image database file. Back up and recover. Recover, then import using the included PC software.

- Since the database information of high definition image quality (HD) movies has been damaged, there are inconsistencies between the information in the database and the information in the file.

Select **OK** to back up the high definition image quality (HD) movies and repair the database file. You cannot see the backed-up movies on the camcorder. By connecting the camcorder to a computer after repairing the database, you can import backed-up high definition image quality (HD) movies to the computer using the "PlayMemories Home" software installed on the computer. However, it is not guaranteed that all movies can be imported to the computer.

---

**Buffer overflow. Writing to the media was not completed in time.**

- You have performed recording and erasing operations repeatedly, or a memory card that has been formatted by other device is used. Copy and take data backup to other device (such as a computer), and then format the memory card on the camcorder. [\[Details\]](#)
- The size of the inserted memory card is not sufficient for copying the movie(s). Use the recommended memory card. [\[Details\]](#)

---

**Recovering data.**

- Your camcorder tries to recover data automatically if the data writing was not performed properly.

---

**Cannot recover data.**

- Writing data onto the media of the camcorder has failed. Attempts were made to recover the data, but they were unsuccessful.

---

 **Reinsert the memory card.**

- Reinsert the memory card a few times. If the indicator continues to flash even after reinserting, the memory card could be damaged. Try with another memory card.

---

 **Cannot recognize this memory card. Format and use again.**

- Format the memory card. Note that when you format the memory card, all the recorded movies and photos are deleted. [\[Details\]](#)

---

 **The maximum number of still image folders has been reached. Cannot record still images.**

- You cannot create folders exceeding 999MSDCF. You cannot create or delete created folders using your camcorder.
- Format the memory card, or delete folders using your computer. [\[Details\]](#)

---

**This memory card may not be able to record or play movies.  
This memory card may not be able to record or play images correctly.**

- Use a memory card recommended for your camcorder. [\[Details\]](#)

---

**Do not eject the memory card during writing. Data may be damaged.**

- Reinsert the memory card.

---

**External media cannot execute functions.**

- Check the data base file by selecting **MENU** → [Setup] → [Media Settings] → [Repair Img. DB F.] → the recording medium.

- If even then the indicator flashes, reconnect the external media device, and then perform the format. Note that if you format the external media device, all the recorded movies and photos in it are deleted.
- If you cannot perform the format, the external media may not be supported by the camcorder, or it may be damaged. Try with another external media.

---

#### **Unable to access external media.**

- Use the external media device in stable condition (the environment such as no vibration and room temperature, etc.).
- Make sure that the power source of the external media device is connected.

#### **Others**

---

---

#### **Maximum number of images already selected.**

- You can select only 100 images at one time for:
  - Deleting movies/photos
  - Protecting movies/photos, or releasing the protection
  - Copying movies/photos

---

#### **Data protected.**

- You tried to delete protected data. Release the protection of the data.

---

#### **Related topics**

Information on your camcorder model: [Model Information](#)

[▲ Back to top](#)

- ▶ Operation Search
- ▶ Before use
- ▶ Getting started
- ▶ Recording
- ▶ Playback
- ▶ Playing images on a TV
- ▶ Saving images with an external device
- ▶ Using the Wi-Fi function
- ▶ Customizing your camcorder
- ▶ Troubleshooting
- ▶ Maintenance and precautions

[→ Contents list](#)

## About the AVCHD format

---

### What is the AVCHD format?

The AVCHD format is a high definition digital video camera format used to record a high definition (HD) signal using efficient data compression coding technology. The MPEG-4 AVC/H.264 format is adopted to compress video data, and the Dolby Digital or Linear PCM system is used to compress audio data. The MPEG-4 AVC/H.264 format is capable of compressing images at higher efficiency than that of the conventional image compressing format.

- As the AVCHD format uses a compression coding technology, the picture may be disturbed in scenes where picture, field angles or brightness, etc. change drastically, but this is not a malfunction.

[▲ Back to top](#)



- ▶ Operation Search
- ▶ Before use
- ▶ Getting started
- ▶ Recording
- ▶ Playback
- ▶ Playing images on a TV
- ▶ Saving images with an external device
- ▶ Using the Wi-Fi function
- ▶ Customizing your camcorder
- ▶ Troubleshooting
- ▶ Maintenance and precautions

[→ Contents list](#)

## About GPS (Models with GPS)

The GPS (Global Positioning System) is a system that calculates geographical location from highly accurate US space satellites. This system allows you to pinpoint your exact location on the earth. The GPS satellites are located in 6 orbits, approximately 20,000 km above the earth. The GPS system consists of 24 or more GPS satellites. A GPS receiver receives radio signals from the satellites, and calculates the current location of the receiver based on the orbital information (almanac data) and travel time of the signals, etc.

Determining a location is called "triangulation." A GPS receiver can determine the location's latitude and longitude by receiving signals from 3 or more satellites.

- As the positions of GPS satellites vary constantly, it may take longer to determine the location or the receiver may not be able to determine the location at all, depending on the location and time you use the camcorder.
- "GPS" is a system for determining geographic location by triangulating radio signals from GPS satellites. Avoid using the GPS feature on your camcorder in places where radio signals are blocked or reflected, such as a shadowy place surrounded by buildings or trees, etc. Use the camcorder in open sky environments.
- You may not be able to record location information when radio signals from the GPS satellites do not reach the camcorder such as in the following situations:
  - In tunnels, indoors or under the shade of buildings.
  - Between tall buildings or at narrow streets surrounded by buildings.
  - In underground locations, locations surrounded by dense trees, under an elevated bridge, or in locations where magnetic fields are generated, such as near high voltage cables.
  - Near devices that generate radio signals of the same frequency band as the camcorder: near 1.5 GHz band mobile telephones, etc.
- When you upload to or share on the web images recorded with [GPS Setting] set to [On], location information may unintentionally be made known to others. If you want to avoid that situation, set [GPS Setting] to [Off].

### On triangulation errors

- If you move to another location right after turning the camcorder on, it may take a longer time for the camcorder to start triangulating, compared to when you stay in the same place.
- Error caused by the position of GPS satellites
 

The camcorder automatically triangulates your current location when the camcorder receives radio signals from 3 or more GPS satellites. The triangulating error allowed by the GPS satellites is about 10 m (33 feet). Depending on the environment of the location, the triangulating error can be greater. In this case, your actual location may not match the location on the map based on the GPS information. Meanwhile, the GPS satellites are controlled by the United States Department of Defense, and the degree of accuracy may be changed intentionally.
- Error during the triangulating process
 

The camcorder acquires location information periodically during triangulating. There is a slight time lag between when the location information is acquired and when the location information is recorded on an image, therefore, the actual recording location may not match the exact location on the map based on the GPS information.

### On GPS use restriction

- Use GPS in accordance with the situation and regulations of the countries/regions where you use the camcorder.

### On the map data

- The camcorder contains map data for the following countries/regions. Europe, Japan, North America,

Oceania, etc.

- Built-in map is powered by companies as follows; Map of Japan by Zenrin Co., Ltd., other areas by NAVTEQ.
- The map data included is as of the date of production of this manual.
- GPS maps will appear in 2-dimensional graphics except for certain landmarks in Japan, which will appear in 3D.
- The map always displays the north at the top.
- You cannot change the language on the map.
- You cannot update the map data.
- The scale of the map is 25 m to 6,000 km. (models available in the US: 100 feet to 6,000 miles)

### **On the geographic coordinate system**

- The “WGS-84” geographic coordinate system is used.

### **On copyright**

- The map data of the camcorder is copyrighted. Unauthorized copying or other usage of the map data may be contrary to the copyright laws.

### **On the navigation function**

- The camcorder does not have a navigation function that uses GPS.

---

### **Related topics**

Information on your camcorder model: [Model Information](#)

[▲ Back to top](#)

---

Copyright 2013 Sony Corporation

- ▶ Operation Search
- ▶ Before use
- ▶ Getting started
- ▶ Recording
- ▶ Playback
- ▶ Playing images on a TV
- ▶ Saving images with an external device
- ▶ Using the Wi-Fi function
- ▶ Customizing your camcorder
- ▶ Troubleshooting
- ▶ Maintenance and precautions

[➔ Contents list](#)

## About the memory card

- A memory card formatted by a computer (Windows OS/Mac OS) is not guaranteed to be compatible with your camcorder.
- Data read/write speed may vary depending on the combination of the memory card and memory card compliant product you use.
- Data may be damaged or lost in the following cases (the data will not be compensated for):
  - If you eject the memory card, or turn off your camcorder while your camcorder is reading or writing image files on the memory card (while the access lamp is lit or flashing)
  - If you use the memory card near magnets or magnetic fields
- It is recommended that you make a back-up of important data on the hard disk of a computer.
- Do not attach a label or the like on memory card or memory card adaptor.
- Do not touch, or allow metallic objects to come into contact with the terminals.
- Do not bend, drop or apply strong force to the memory card.
- Do not disassemble or modify the memory card.
- Do not allow the memory card to get wet.
- Keep the memory card out of the reach of small children. There is danger that a child might swallow it.
- Do not insert anything other than the compliant size of memory card into the memory card slot. Doing so may cause a malfunction.
- Do not use or keep the memory card in the following locations:
  - Places subject to extremely high temperature, such as a car parked outside in the sun
  - Places under direct sunlight
  - Places with extremely high humidity or subject to corrosive gases

### On the memory card adaptor

- If using the memory card adaptor to allow use of a memory card in a device compatible with memory cards, make sure that the memory card is inserted facing in the correct direction.

### On image data compatibility

- Image data files recorded on memory card by your camcorder conform to the "Design rule for Camera File system" universal standard established by the JEITA (Japan Electronics and Information Technology Industries Association).
- If you cannot use memory cards that have been used with another device, format it with your camcorder. Note that formatting erases all information on the memory card. [\[Details\]](#)
- You may not be able to play back images with your camcorder:
  - When playing back image data modified on your computer
  - When playing back image data recorded with other devices

### About the "Memory Stick" media

Types of "Memory Stick" media	Recording/Playback
"Memory Stick Duo" media (with MagicGate)	—
"Memory Stick PRO Duo" media (Mark2)	✓
"Memory Stick PRO-HG Duo" media	✓
"Memory Stick XC-HG Duo" media	✓

- This product does not support 8-bit parallel data transfer but it supports 4-bit parallel data transfer the

same as with “Memory Stick PRO Duo” media.

- This product cannot record or play back data that uses “MagicGate” technology. “MagicGate” is a copyright protection technology that records and transfers the contents in an encrypted format.

[▲ Back to top](#)

---



Copyright 2013 Sony Corporation

- ▶ Operation Search
- ▶ Before use
- ▶ Getting started
- ▶ Recording
- ▶ Playback
- ▶ Playing images on a TV
- ▶ Saving images with an external device
- ▶ Using the Wi-Fi function
- ▶ Customizing your camcorder
- ▶ Troubleshooting
- ▶ Maintenance and precautions

[→ Contents list](#)

## About the "InfoLITHIUM" battery pack

Your camcorder operates only with an "InfoLITHIUM" V series battery packs.

"InfoLITHIUM" V series battery packs have the   mark.

### What is an "InfoLITHIUM" battery pack?

- An "InfoLITHIUM" battery pack is a lithium-ion battery pack that has functions for communicating information related to operating conditions between your camcorder and an AC Adaptor/charger (sold separately).
- The "InfoLITHIUM" battery pack calculates the power consumption according to the operating conditions of your camcorder, and displays the remaining battery capacity in minutes.

### To charge the battery pack

- Be sure to charge the battery pack before you start using your camcorder.
- We recommend that you charge the battery pack in an ambient temperature range of 10 °C to 30 °C (50 °F to 86 °F) until the CHG (charge) lamp turns off. If you charge the battery pack outside of this temperature range, you may not be able to charge it efficiently.
- The CHG (charge) lamp flashes during charging under the following conditions.
  - The battery pack is not attached correctly.
  - The battery pack is damaged.
  - The temperature of the battery pack is low.
  - Remove the battery pack from your camcorder and put it in a warm place.
  - The temperature of the battery pack is high.
  - Remove the battery pack from your camcorder and put it in a cool place.

### To use the battery pack effectively

- Battery pack performance decreases when the ambient temperature is 10 °C (50 °F) or below, and the length of time you can use the battery pack becomes shorter. If that happens, one of the following is recommended to enable longer use of the battery pack:
  - Put the battery pack in a pocket to warm it up, and install it on your camcorder immediately before you start shooting.
  - Use a large capacity battery pack: NP-FV70/NP-FV100 (sold separately).
- Frequent use of the LCD screen or a frequent playback, fast forward or reverse operation wears out the battery pack faster.
- Be sure to close the LCD screen when not recording or playing back on your camcorder. The battery pack is also consumed when your camcorder is in recording standby or playback pause.
- Have spare battery packs ready for 2 or 3 times the expected recording time, and make trial recordings before making the actual recording.
- Do not expose the battery pack to water. The battery pack is not water resistant.

### About the remaining battery time indicator

- When the power goes off even though the remaining battery time indicator indicates that the battery pack has enough power to operate, charge the battery pack fully again. Remaining battery time will be indicated correctly. Note, however, that the battery indication will not be restored if it is used in high temperatures for a long time, or if left in a fully charged state, or when the battery pack is frequently used. Use the remaining battery time indication as a rough guide only.
- Depending on the operating conditions or ambient temperature, the  icon that indicates a low battery may flash even if there are still 20 minutes of power remaining.

### About storage of the battery pack

- If the battery pack is not used for a long time, fully charge the battery pack and use it up on your camcorder once a year to maintain proper function. To store the battery pack, remove it from your camcorder and put it in a dry, cool place.
- To discharge the battery pack on your camcorder completely, select **MENU** → [Setup] → [ General Settings] → [Power Save] → [Off], and leave your camcorder in recording standby until the power goes off. [\[Details\]](#)

### **About battery life**

- Battery capacity decreases over time and through repeated use. If the interval between charges becomes significantly short, the battery pack may need to be replaced with a new one.
- Each battery's life depends on storage, operating and environmental conditions.

[▲ Back to top](#)

---

Copyright 2013 Sony Corporation

- ▶ Operation Search
- ▶ Before use
- ▶ Getting started
- ▶ Recording
- ▶ Playback
- ▶ Playing images on a TV
- ▶ Saving images with an external device
- ▶ Using the Wi-Fi function
- ▶ Customizing your camcorder
- ▶ Troubleshooting
- ▶ Maintenance and precautions

[→ Contents list](#)



## On use and care

- ▼ [On recording](#)
- ▼ [Notes on use](#)
- ▼ [LCD Panel, viewfinder](#)
- ▼ [About this manual, illustrations and on-screen displays](#)
- ▼ [On use and care](#)
- ▼ [When not using your camcorder for a long time](#)
- ▼ [Note on the camcorder/battery pack temperature](#)
- ▼ [Notes on charging through the USB cable](#)
- ▼ [When the camcorder is connected to a computer or accessories](#)
- ▼ [Notes on optional accessories](#)
- ▼ [Multi interface shoe](#)
- ▼ [Notes on the Wireless Remote Commander](#)
- ▼ [To change the battery of the Wireless Remote Commander](#)
- ▼ [On handling the LCD screen](#)
- ▼ [LCD screen](#)
- ▼ [To clean the casing and the projector lens](#)
- ▼ [Carl Zeiss lens](#)
- ▼ [To clean the flash](#)
- ▼ [About care and storage of the lens](#)

### On recording

- Before starting to record, test the recording function to make sure the image and sound are recorded without any problems.
- Compensation for the contents of recordings cannot be provided, even if recording or playback is not possible due to a malfunction of the camcorder, recording media, etc.
- TV color systems differ depending on the country/region. To view your recordings on a TV, you need a TV that supports the signal format for your camcorder. For details on the signal format, refer to "[Model Information](#)".
- Television programs, films, video tapes, and other materials may be copyrighted. Unauthorized recording of such materials may be contrary to the copyright laws.

### Notes on use

- Do not do any of the following. If any of those are done, the recording media may be damaged, recorded images may be impossible to play back or may be lost, or other malfunctions could occur.
  - ejecting the memory card when the access lamp is lit or flashing
  - removing the battery pack or AC Adaptor from the camcorder, or applying mechanical shock or vibration to the camcorder when the  (Movie)/  (Photo) lamps or the access lamp are lit or flashing
- When the camcorder is connected to other devices through a USB connection and the power of the camcorder is turned on, do not close the LCD panel. The image data that has been recorded may be lost.
- Use the camcorder in accordance with local regulations.

## LCD Panel, viewfinder

- The LCD screen and the viewfinder are manufactured using extremely high-precision technology, so over 99.99% of the pixels are operational for effective use. However, there may be some tiny black points and/or bright points (white, red, blue, or green in color) that appear constantly on the LCD screen. These points are normal results of the manufacturing process and do not affect the recording in any way.

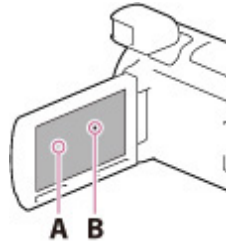

A: White, red, blue or green points



B: Black points

## About this manual, illustrations and on-screen displays

- Design and specifications of your camcorder and accessories are subject to change without notice.
- In this manual, the internal memory of the camcorder and the memory card are called “recording media.”
- In this manual, the DVD disc recorded with high definition image quality (HD) is called AVCHD recording disc.

## On use and care

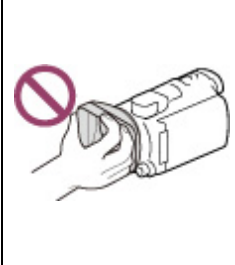
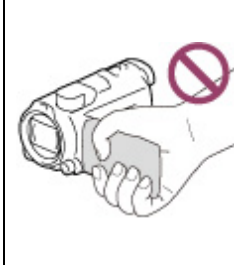
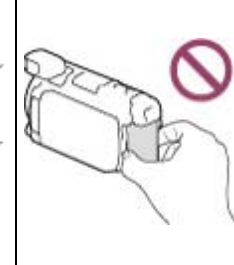
- The camcorder is not dustproofed, dripproofed or waterproofed.
- Do not hold the camcorder by the following parts, and also do not hold the camcorder by the jack covers.

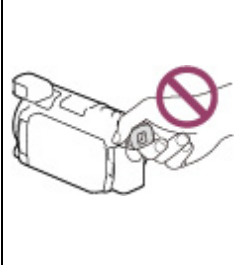
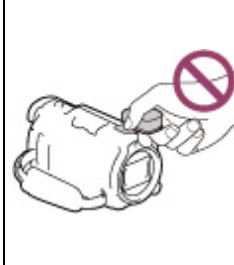
Shoe cover	Lens hood	LCD screen	Battery pack
			
Built-in USB Cable	Viewfinder	Built-in microphone	
			

- Do not aim the camcorder at the sun. Doing so might cause your camcorder to malfunction. Take images of the sun only in low light conditions, such as at dusk.
- Do not use or store the camcorder and accessories in the following locations:
  - Anywhere extremely hot, cold or humid. Never leave them exposed to temperatures above 60 °C (140 °F), such as under direct sunlight, near heaters or in a car parked in the sun. They may malfunction or become deformed.



- Near strong magnetic fields or mechanical vibration. The camcorder may malfunction.
- Near strong radio waves or radiation. The camcorder may not be able to record properly.
- Near tuner devices such as TVs or radio. Noise may occur.
- On a sandy beach or anywhere dusty. If sand or dust gets in your camcorder, it may malfunction. Sometimes this malfunction cannot be repaired.
- Near windows or outdoors, where the LCD screen, the viewfinder, or the lens may be exposed to direct sunlight. This damages the inside of the viewfinder or the LCD screen.
- For DC or AC operation, use the accessories recommended in these operating instructions.
- Do not let your camcorder get wet, for example, from rain or sea water. If your camcorder gets wet, it may malfunction. Sometimes this malfunction cannot be repaired.
- If any solid object or liquid gets inside the casing, unplug your camcorder and have it checked by a Sony dealer before operating it any further.
- Avoid rough handling, disassembling, modifying, physical shock, or impact such as hammering, dropping or stepping on the product. Be particularly careful with the lens.
- Keep the LCD screen and the viewfinder closed when you are not using your camcorder.
- Do not operate your camcorder with it wrapped in an object such as a towel. Doing so might cause heat to build up inside.
- When disconnecting the power cord (mains lead), pull it by the plug and not the cord.
- Do not damage the power cord (mains lead) such as by placing anything heavy on it.
- Do not use a deformed or damaged battery pack.
- Keep metal contacts clean.
- If the battery electrolytic liquid has leaked:
  - Consult your local authorized Sony service facility.
  - Wash off any liquid that may have contacted your skin.
  - If any liquid gets in your eyes, wash with plenty of water and consult a doctor.

### **When not using your camcorder for a long time**

- To keep your camcorder in optimum state for a long time, turn it on and let it run by recording and playing back images about once a month.
- Use up the battery pack completely before storing it.

### **Note on the camcorder/battery pack temperature**

- When the temperature of the camcorder or battery pack becomes extremely high or extremely low, you may not be able to record or play back on the camcorder, due to the protection features of the camcorder being activated in such situations. In this case, an indicator appears on the LCD screen or the viewfinder.

### **Notes on charging through the USB cable**

- Charging may not be possible with all computers.
- If you connect the camcorder to a laptop computer that is not connected to a power source, the battery of the laptop computer will continue to use up its charge. Do not leave the camcorder connected to a computer in this manner.
- Charging with a personally assembled computer, with a converted computer, or through a USB hub are not guaranteed. The camcorder may not function correctly depending on the USB device which is used with the computer.

### **When the camcorder is connected to a computer or accessories**

- Do not try to format the recording media of the camcorder with a computer. If you do so, your camcorder may not operate correctly.
- When connecting the camcorder to another device with communication cables, be sure to insert the connector plug in the correct way. Pushing the plug forcibly into the terminal will damage the terminal and may result in a malfunction of the camcorder.
- When the camcorder is connected to other devices through a USB connection and the power of the camcorder is turned on, do not close the LCD panel. The image data that has been recorded may be lost.

## Notes on optional accessories

- We recommend using genuine Sony accessories.
- Genuine Sony accessories may not be available in some countries/regions.

## Multi interface shoe

- When using a dedicated microphone or portable speaker, their power turns on or off according to the power of your camcorder.
- Refer to the operating instructions supplied with the accessory used for details.
- To attach an accessory, insert and fix the accessory to the Multi interface shoe by pressing down and sliding until it stops.
- When you are recording movies with an external flash (sold separately) connected to the accessory shoe, turn off the power of the external flash to prevent charging noise from being recorded.
- You cannot use an external flash (sold separately) and the built-in flash at the same time.
- When an external microphone (sold separately) is connected, it takes precedence over the built-in microphone.

## Notes on the Wireless Remote Commander

- Remove the insulation sheet (A) before using the Wireless Remote Commander.

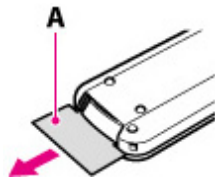

- Point the Wireless Remote Commander towards the remote sensor to operate your camcorder.
- When no commands have been sent from the Wireless Remote Commander within a certain period, the light blue frame disappears. When you press any of ◀ / ▶ / ▲ / ▼ , or ENTER again, the frame appears at the position where it was last displayed.
- You cannot select some buttons on the LCD screen or on the viewfinder using ◀ / ▶ / ▲ / ▼ .

## To change the battery of the Wireless Remote Commander

- ① While pressing on the tab (A), inset your fingernail into the slit to pull out the battery case.
- ② Place a new battery with the + side facing up.
- ③ Insert the battery case back into the Wireless Remote Commander until it clicks.



### WARNING

Battery may explode if mistreated. Do not recharge, disassemble or dispose of in fire.

- When the lithium battery becomes weak, the operating distance of the Wireless Remote Commander may shorten, or the Wireless Remote Commander may not function properly. In this case, replace the battery with a Sony CR2025 lithium battery. Use of another battery may present a risk of fire or explosion.

## On handling the LCD screen

- If you leave fingerprints, hand cream, etc. on the LCD screen, the coating of the LCD screen will come off easily. Wipe those off as soon as possible.
- If you wipe the LCD screen strongly with a tissue, etc., the coating of the LCD screen may be scratched.
- If the LCD screen becomes dirty with fingerprints or dust, it is recommended that you gently remove those from the screen then clean it with a soft cloth, etc.

## **LCD screen**

- Do not apply excessive pressure on the LCD screen, as it may cause uneven color and other damage.
- If your camcorder is used in a cold place, a residual image may appear on the LCD screen. This is not a malfunction.
- While using your camcorder, the back of the LCD screen may heat up. This is not a malfunction.

## **To clean the casing and the projector lens**

- Wipe the casing and the lens gently with a soft cloth such as a cleaning cloth or eyeglass cleaning cloth.
- If the casing and the projector lens is very dirty, clean the camcorder casing and the lens with a soft cloth lightly moistened with water, and then wipe the casing and the projector lens with a dry soft cloth.
- Avoid the following so as not to deform the casing, damage the finish or scratch the lens:
  - Using chemicals such as thinner, benzene, alcohol, chemical cloths, insect repellent, insecticide and sunscreen
  - Handling the camcorder with the above substances on your hands
  - Leaving the camcorder in contact with rubber or vinyl objects for a long period of time

## **Carl Zeiss lens**

- Your camcorder is equipped with a Carl Zeiss lens, which was developed jointly by Carl Zeiss, in Germany, and Sony Corporation, and produces superior images. It adopts the MTF measurement system for video cameras and offers a quality typical of a Carl Zeiss lens. Also, the lens for your camcorder is T\*<sup>\*</sup>-coated to suppress unwanted reflections and faithfully reproduce colors. MTF= Modulation Transfer Function. The number value indicates the amount of light from a subject coming into the lens.

## **To clean the flash**

- If the LCD screen becomes dirty with fingerprints or dust, it is recommended that you use a soft cloth to clean it.

## **About care and storage of the lens**

- Wipe the surface of the lens clean with a soft cloth in the following instances:
  - When there are fingerprints on the lens surface
  - In hot or humid locations
  - When the lens is exposed to salty air such as at the seaside
- Store in a well-ventilated location subject to little dirt or dust.
- To prevent mold, periodically clean and store the lens as described above.

---

### **Related topics**

Information on your camcorder model: [Model Information](#)

[▲ Back to top](#)

- ▶ Operation Search
- ▶ Before use
- ▶ Getting started
- ▶ Recording
- ▶ Playback
- ▶ Playing images on a TV
- ▶ Saving images with an external device
- ▶ Using the Wi-Fi function
- ▶ Customizing your camcorder
- ▶ Troubleshooting
- ▶ Maintenance and precautions

[→ Contents list](#)

## On moisture condensation

---

If your camcorder is brought directly from a cold place to a warm place, moisture may condense inside your camcorder. This may cause a malfunction to your camcorder.

- If moisture condensation occurs, leave your camcorder for about 1 hour without turning it on.
- Note on moisture condensation  
Moisture may condense when you bring your camcorder from a cold place into a warm place (or vice versa) or when you use your camcorder in a humid place as follows:
  - You bring your camcorder from a ski slope into a place warmed up by a heating device.
  - You bring your camcorder from an air conditioned car or room into a hot place outside.
  - You use your camcorder after a squall or a rain.
  - You use your camcorder in a hot and humid place.
- How to prevent moisture condensation

When you bring your camcorder from a cold place into a warm place, put your camcorder in a plastic bag and seal it tightly. Remove the bag when the air temperature inside the plastic bag has reached the surrounding temperature (after about 1 hour).

[▲ Back to top](#)

- ▶ Operation Search
- ▶ Before use
- ▶ Getting started
- ▶ Recording
- ▶ Playback
- ▶ Playing images on a TV
- ▶ Saving images with an external device
- ▶ Using the Wi-Fi function
- ▶ Customizing your camcorder
- ▶ Troubleshooting
- ▶ Maintenance and precautions

[→ Contents list](#)

[Top page](#) > [Maintenance and precautions](#) > [About handling of your camcorder](#) > [On charging the pre-installed rechargeable battery](#)

## On charging the pre-installed rechargeable battery

---

Your camcorder has a pre-installed rechargeable battery to retain the date, time, and other settings even when the LCD screen is closed. The pre-installed rechargeable battery is always charged while your camcorder is connected to the wall outlet (wall socket) via the AC Adaptor or while the battery pack is attached. The rechargeable battery will be fully discharged in about 3 months if you do not use your camcorder at all. Charge the pre-installed rechargeable battery before you start using your camcorder. However, even if the pre-installed rechargeable battery is not charged, the camcorder operation other than date recording will not be affected.

### How to charge the pre-installed rechargeable battery

Connect your camcorder to a wall outlet (wall socket) using the supplied AC Adaptor, and leave it with the LCD screen closed for more than 24 hours.

[▲ Back to top](#)

[Top page](#) > [Maintenance and precautions](#) > [About handling of your camcorder](#) > [Notes on disposal/transfer the ownership of the camcorder](#)

▶ Operation Search

▶ Before use

▶ Getting started

▶ Recording

▶ Playback

▶ Playing images on a TV

▶ Saving images with an external device

▶ Using the Wi-Fi function

▶ Customizing your camcorder

▶ Troubleshooting

▶ Maintenance and precautions

[→ Contents list](#)

## Notes on disposal/transfer the ownership of the camcorder

---

### Note on disposal/transfer the ownership of the camcorder

Even if you delete all movies and still images, or perform [Format], data on the internal memory may not be completely erased. It is recommended that you perform [Empty] to prevent the recovery of your data. [\[Details\]](#)

[▲ Back to top](#)

- ▶ [Operation Search](#)
- ▶ [Before use](#)
- ▶ [Getting started](#)
- ▶ [Recording](#)
- ▶ [Playback](#)
- ▶ [Playing images on a TV](#)
- ▶ [Saving images with an external device](#)
- ▶ [Using the Wi-Fi function](#)
- ▶ [Customizing your camcorder](#)
- ▶ [Troubleshooting](#)
- ▶ [Maintenance and precautions](#)

[→ Contents list](#)

## Charging time

Approximate time (min.) required when you fully charge a fully discharged battery pack.

Battery pack	Charging time	
	AC Adaptor	Built-in USB Cable* (when using your computer)
NP-FV50 (supplied)	155	280
NP-FV70	195	545
NP-FV100	390	1,000

- The charging times shown in the table above are measured when charging the camcorder at a temperature of 25 °C (77 °F). It is recommended that you charge the battery in a temperature range of 10 °C to 30 °C (50 °F to 86 °F).

\* The charging times are measured without using the USB Connection support cable.

[▲ Back to top](#)

[Top page](#) > [Maintenance and precautions](#) > [Recording time of movies/number of recordable photos](#) > [Expected time of recording and playback with each battery pack](#)

- ▶ Operation Search
- ▶ Before use
- ▶ Getting started
- ▶ Recording
- ▶ Playback
- ▶ Playing images on a TV
- ▶ Saving images with an external device
- ▶ Using the Wi-Fi function
- ▶ Customizing your camcorder
- ▶ Troubleshooting
- ▶ Maintenance and precautions

[→ Contents list](#)

## Expected time of recording and playback with each battery pack

### ▼ Recording time

### ▼ Playing time

"HD" stands for high definition image quality, and "STD" stands for standard definition image quality.

### Recording time

Approximate time available when you use a fully charged battery pack.  
(unit: minute)

Battery pack	Continuous recording time			Typical recording time			
	Image quality	HD	MP4	STD	HD	MP4	STD
NP-FV50 (supplied)		110	125	115	55	60	55
		115	130	120	55	65	60
NP-FV70		230	260	240	115	130	120
		240	270	250	120	135	125
NP-FV100		455	515	485	225	255	240
		485	535	500	240	265	250

- Top: When the LCD screen is opened  
Bottom: When recording with the viewfinder without opening the LCD screen
- Each recording time is measured when the camcorder is recording high definition image quality (HD) movies with [REC Mode] set to [Standard **HQ**].
- Typical recording time shows the time when you repeat recording start/stop, switching the [Shooting Mode], and zooming.
- Times measured when using the camcorder at 25 °C (77 °F). 10 °C to 30 °C (50 °F to 86 °F) is recommended.
- The recording and playback time will be shorter, depending on the conditions under which you use your camcorder, such as when use your camcorder in low temperatures.

### Playing time

Approximate time available when you use a fully charged battery pack.  
(unit: minute)

Battery pack			
Image quality	HD	MP4	STD
NP-FV50 (supplied)	190	200	215
	215	225	240
NP-FV70	395	415	440
	440	465	490



NP-FV100	785	830	870
	870	925	980

- Top: When the LCD screen is opened  
Bottom: When recording with the viewfinder without opening the LCD screen

[▲ Back to top](#)

---

Copyright 2013 Sony Corporation

[Top page](#) > [Maintenance and precautions](#) > [Recording time of movies/number of recordable photos](#) > [Expected recording time of movies](#)

- ▶ Operation Search
- ▶ Before use
- ▶ Getting started
- ▶ Recording
- ▶ Playback
- ▶ Playing images on a TV
- ▶ Saving images with an external device
- ▶ Using the Wi-Fi function
- ▶ Customizing your camcorder
- ▶ Troubleshooting
- ▶ Maintenance and precautions

[→ Contents list](#)

## Expected recording time of movies

▼ [Expected recording time of movies](#)

▼ [Bit-rate and recording pixels](#)

### Expected recording time of movies

#### Internal memory

##### HDR-PJ780E/ PJ780VE

High definition image quality (HD) in h (hour) and min (minute)

Recording mode	Recording time	
	HDR-PJ780E	HDR-PJ780VE
[60p Quality $\overline{\text{PS}}$ ] / [50p Quality $\overline{\text{PS}}$ ]	2 h 30 min (2 h 30 min)	2 h 15 min (2 h 15 min)
[Highest Quality $\overline{\text{FX}}$ ]	3 h (3 h)	2 h 40 min (2 h 40 min)
[High Quality $\overline{\text{FH}}$ ]	4 h 5 min (4 h 5 min)	3 h 40 min (3 h 40 min)
[Standard $\overline{\text{HQ}}$ ]	7 h 15 min (5 h 30 min)	6 h 30 min (4 h 55 min)
[Long Time $\overline{\text{LP}}$ ]	12 h 30 min (10 h 15 min)	11 h 15 min (9 h 15 min)

#### MP4 in h (hour) and min (minute)

Recording time	
HDR-PJ780E	HDR-PJ780VE
10 h 55 min (10 h 55 min)	9 h 55 min (9 h 55 min)

#### Standard definition image quality (STD) in h (hour) and min (minute)

Recording mode	Recording time	
	HDR-PJ780E	HDR-PJ780VE
[Standard $\overline{\text{HQ}}$ ]	7 h 30 min (6 h 55 min)	6 h 45 min (6 h 15 min)

##### HDR-PJ790/ PJ790E/ PJ790V/ PJ790VE

### High definition image quality (HD) in h (hour) and min (minute)

Recording mode	Recording time	
	HDR-PJ790/ PJ790E	HDR-PJ790V/ PJ790VE
[60p Quality $\overline{PS}$ ] / [50p Quality $\overline{PS}$ ]	7 h 45 min (7 h 45 min)	7 h 30 min (7 h 30 min)
[Highest Quality $\overline{FX}$ ]	9 h 5 min (9 h 5 min)	8 h 50 min (8 h 50 min)
[High Quality $\overline{FH}$ ]	12 h 25 min (12 h 25 min)	12 h (12 h)
[Standard $\overline{HQ}$ ]	21 h 50 min (16 h 35 min)	21 h 10 min (16 h 5 min)
[Long Time $\overline{LP}$ ]	37 h 45 min (31 h)	36 h 30 min (30 h)

### MP4 in h (hour) and min (minute)

Recording time	
HDR-PJ790/ PJ790E	HDR-PJ790V/ PJ790VE
33 h (33 h)	32 h (32 h)

### Standard definition image quality (STD) in h (hour) and min (minute)

Recording mode	Recording time	
	HDR-PJ790/ PJ790E	HDR-PJ790V/ PJ790VE
[Standard $\overline{HQ}$ ]	22 h 40 min (20 h 50 min)	21 h 55 min (20 h 10 min)

- If you want to record up to the maximum recording time indicated in the table, you need to delete the demonstration movie on your camcorder.

### Memory card

#### High definition image quality (HD)

(unit: minute)

Recording mode	16 GB	32 GB	64 GB
[60p Quality $\overline{PS}$ ] / [50p Quality $\overline{PS}$ ]	75 (75)	150 (150)	305 (305)
[Highest Quality $\overline{FX}$ ]	85 (85)	180 (180)	360 (360)
[High Quality $\overline{FH}$ ]	120 (120)	245 (245)	490 (490)
[Standard $\overline{HQ}$ ]	210 (160)	430 (325)	865 (655)
[Long Time $\overline{LP}$ ]	370 (300)	740 (610)	1490 (1225)

#### MP4

(unit: minute)

16 GB	32 GB	64 GB
320 (320)	650 (650)	1305 (1305)

### Standard definition image quality (STD)

(unit: minute)

Recording mode	16 GB	32 GB	64 GB
[Standard $\overline{HQ}$ ]	220 (200)	445 (410)	895 (825)

- When using a Sony memory card.

#### Notes

- The recordable time may vary depending on the recording and subject conditions, [REC Mode] [Details] and [Frame Rate] [Details].
- The number in ( ) is the minimum recordable time.
- You can record movies of a maximum of 3,999 scenes with high definition image quality (HD) and 9,999 scenes with standard definition image quality (STD). And you can record a maximum of 40,000 MP4 movies and photos collectively.
- The maximum continuous recording time of movies is approximately 13 hours.
- Your camcorder uses the VBR (Variable Bit Rate) format to automatically adjust image quality to suit the recording scene. This technology causes fluctuations in the recording time of the media. Movies containing quickly moving and complex images are recorded at a higher bit-rate, and this reduces the overall recording time.

## Bit-rate and recording pixels

The following list shows the bit-rate, pixels and aspect ratio of each recording mode for movies (movie + audio, etc.).

Models with the NTSC color system:

- High definition image quality (HD):
  - PS: Max. 28 Mbps 1,920 × 1,080 pixels/ 60p, AVC HD 28 M (PS), 16:9
  - FX: Max. 24 Mbps 1,920 × 1,080 pixels/ 60i or 1,920 × 1,080 pixels/24p, AVC HD 24 M (FX), 16:9
  - FH: Approx. 17 Mbps (average) 1,920 × 1,080 pixels/ 60i or 1,920 × 1,080 pixels/24p, AVC HD 17 M (FH), 16:9
  - HQ: Approx. 9 Mbps (average) 1,440 × 1,080 pixels/ 60i, AVC HD 9 M (HQ), 16:9
  - LP: Approx. 5 Mbps (average) 1,440 × 1,080 pixels/ 60i, AVC HD 5 M (LP), 16:9
- MP4:
  - Approx. 6 Mbps (average) 1,280 × 720 pixels/ 30p
- Standard definition image quality (STD):
  - HQ: Approx. 9 Mbps (average) 720 × 480 pixels/ 60i, STD 9 M (HQ), 16:9/ 4:3

Models with the PAL color system:

- High definition image quality (HD):
  - PS: Max. 28 Mbps 1,920 × 1,080 pixels/ 50p, AVC HD 28 M (PS), 16:9
  - FX: Max. 24 Mbps 1,920 × 1,080 pixels/ 50i, 1,920 × 1,080 pixels/25p or 1,920 × 1,080 pixels/24p ([24p Mode]), AVC HD 24 M (FX), 16:9
  - FH: Approx. 17 Mbps (average) 1,920 × 1,080 pixels/ 50i, 1,920 × 1,080 pixels/25p or 1,920 × 1,080 pixels/24p ([24p Mode]), AVC HD 17 M (FH), 16:9
  - HQ: Approx. 9 Mbps (average) 1,440 × 1,080 pixels/ 50i, AVC HD 9 M (HQ), 16:9
  -

- LP: Approx. 5 Mbps (average) 1,440 × 1,080 pixels/ 50i, AVC HD 5 M (LP), 16:9
  - MP4:
    - Approx. 6 Mbps (average) 1,280 × 720 pixels/ 25p
  - Standard definition image quality (STD):
    - HQ: Approx. 9 Mbps (average) 720 × 576 pixels/ 50i, STD 9 M (HQ), 16:9/ 4:3
- 

#### **Related topics**

Information on your camcorder model: [Model Information](#)

[Expected number of recordable photos](#)

[▲ Back to top](#)

---

Copyright 2013 Sony Corporation

[Top page](#) > [Maintenance and precautions](#) > [Recording time of movies/number of recordable photos](#) > [Expected number of recordable photos](#)

- ▶ Operation Search
- ▶ Before use
- ▶ Getting started
- ▶ Recording
- ▶ Playback
- ▶ Playing images on a TV
- ▶ Saving images with an external device
- ▶ Using the Wi-Fi function
- ▶ Customizing your camcorder
- ▶ Troubleshooting
- ▶ Maintenance and precautions

[→ Contents list](#)

## Expected number of recordable photos

### Internal memory

You can record a maximum of 40,000 MP4 movies and photos collectively.

### Memory card

	16:9 24.1M
16 GB	1,600
32 GB	3,250
64 GB	6,500

- When using a Sony memory card.
- The number of recordable photos of memory card shown is for the maximum image size of your camcorder. The actual number of recordable photos is displayed on the LCD screen during recording. [\[Details\]](#)
- The number of recordable photos of memory card may vary depending on the recording conditions.

### Recording pixels

The photo recording pixels and the aspect ratio.

- Photo recording mode, Dual capture:
  - 6,544 × 3,680 dots/16:9
  - 4,912 × 3,680 dots/4:3
  - 4,672 × 2,628 dots/16:9
  - 2,592 × 1,944 dots/4:3
  - 1,920 × 1,080 dots/16:9
  - 640 × 480 dots/4:3
- Capturing a photo from a movie:
  - 1,920 × 1,080 dots/16:9
  - 640 × 360 dots/16:9
  - 640 × 480 dots/4:3

#### Notes

- The unique pixel array of Sony's ClearVid and the image processing system (BIONZ) allow still image resolution equivalent to the sizes described.

[▲ Back to top](#)

[Top page](#) > [Maintenance and precautions](#) > [Using your camcorder abroad](#) > [Using your camcorder abroad](#)

- ▶ Operation Search
- ▶ Before use
- ▶ Getting started
- ▶ Recording
- ▶ Playback
- ▶ Playing images on a TV
- ▶ Saving images with an external device
- ▶ Using the Wi-Fi function
- ▶ Customizing your camcorder
- ▶ Troubleshooting
- ▶ Maintenance and precautions

[→ Contents list](#)

## Using your camcorder abroad

### Power supply

You can use your camcorder in any countries/regions using the AC Adaptor supplied with your camcorder within the AC 100 V to 240 V, 50 Hz/60 Hz range.

### Viewing high definition image quality (HD) movies

In countries/regions where high definition image quality (HD) broadcasts are supported, you can view recorded movies on a TV at the same high definition image quality (HD) as they were recorded with the camcorder.

To view images at the same high definition image quality (HD) as they were recorded with the camcorder, you need an HDMI cable and a high definition TV (or monitor) that supports the signal format for your camcorder and is equipped with an HDMI jack.

### Viewing standard definition image quality (STD) movies

To view on a TV images recorded in standard image quality (STD) with your camcorder, you need to connect your camcorder using an AV cable to a TV (or monitor) that supports the signal format of your camcorder and is equipped with AUDIO/VIDEO input jacks.

### On TV color systems

For signal formats supported by your camcorder, refer to "[Model Information](#)".

To view images in your camcorder on TV, use a TV (or monitor) that supports the signal format of your camcorder.

System	Used in
PAL	Australia, Austria, Belgium, China, Czech Republic, Denmark, Finland, Germany, Holland, Hong Kong, Hungary, Italy, Kuwait, Malaysia, New Zealand, Norway, Poland, Portugal, Singapore, Slovak Republic, Spain, Sweden, Switzerland, Thailand, United Kingdom, etc.
PAL-M	Brazil
PAL-N	Argentina, Paraguay, Uruguay
NTSC	Bahama Islands, Bolivia, Canada, Central America, Chile, Colombia, Ecuador, Guyana, Jamaica, Japan, Korea, Mexico, Peru, Surinam, Taiwan, the Philippines, the USA, Venezuela, etc.
SECAM	Bulgaria, France, Guiana, Iran, Iraq, Monaco, Russia, Ukraine, etc.

### Setting to the local time

You can easily set the clock to the local time by setting a time difference when using your camcorder abroad. Select **MENU** → [Setup] → [Clock Settings] → [Date & Time Setting] → [Summer Time] [\[Details\]](#), and **MENU** → [Setup] → [Clock Settings] → [Area Setting] [\[Details\]](#).

### Models with GPS

When [Auto Clock ADJ] [\[Details\]](#) and [Auto Area ADJ] [\[Details\]](#) are set to [On], the clock is set to the local time automatically by the GPS function.

### World time difference

Time-zone differences	Area setting
GMT	Lisbon/London
+01:00	Berlin/Paris
+02:00	Helsinki/Cairo/Istanbul
+03:00	Nairobi
+03:30	Tehran
+04:00	Moscow/Abu Dhabi/Baku
+04:30	Kabul
+05:00	Karachi/Islamabad
+05:30	Kolkata/New Delhi
+06:00	Almaty/Dhaka
+06:30	Yangon
+07:00	Bangkok/Jakarta
+08:00	HongKong/Singapore/Beijing
+09:00	Tokyo/Seoul
+09:30	Adelaide/Darwin
+10:00	Melbourne/Sydney
+11:00	Solomon Is
+12:00	Fiji/Wellington
-11:00	Midway Island
-10:00	Hawaii
-09:00	Alaska
-08:00	LosAngeles/Tijuana
-07:00	Denver/Arizona
-06:00	Chicago/MexicoCity
-05:00	New York/Bogota
-04:00	Santiago
-03:30	St. John's
-03:00	Brasilia/Montevideo
-02:00	Fernando de Noronha
-01:00	Azores/Cape Verde Is.

---

#### Related topics

Information on your camcorder model: [Model Information](#)

[▲ Back to top](#)

---

Copyright 2013 Sony Corporation



- ▶ Operation Search
- ▶ Before use
- ▶ Getting started
- ▶ Recording
- ▶ Playback
- ▶ Playing images on a TV
- ▶ Saving images with an external device
- ▶ Using the Wi-Fi function
- ▶ Customizing your camcorder
- ▶ Troubleshooting
- ▶ Maintenance and precautions

[→ Contents list](#)

## On trademarks

- "Handycam" and **HANDYCAM** are registered trademarks of Sony Corporation.
- "AVCHD," "AVCHD" logotype, "AVCHD Progressive" and "AVCHD Progressive" logotype are trademarks of Panasonic Corporation and Sony Corporation.
- "Memory Stick," , "Memory Stick Duo," **MEMORY STICK DUO**," "Memory Stick PRO Duo," **MEMORY STICK PRO DUO**," "Memory Stick PRO-HG Duo," **MEMORY STICK PRO-HG DUO**," "Memory Stick XC-HG Duo," **MEMORY STICK XC-HG DUO**," "MagicGate," **MAGICGATE**," "MagicGate Memory Stick" and "MagicGate Memory Stick Duo" are trademarks or registered trademarks of Sony Corporation.
- "InfoLITHIUM" is a trademark of Sony Corporation.
- "x.v.Color" and "x.v.Colour" are trademarks of Sony Corporation.
- "BIONZ" is a trademark of Sony Corporation.
- **S-MASTER** is a registered trademark of Sony Corporation.
- "BRAVIA" is a trademark of Sony Corporation.
- Blu-ray Disc <sup>TM</sup> and Blu-ray <sup>TM</sup> are trademarks of the Blu-ray Disc Association.
- Dolby and the double-D symbol are trademarks of Dolby Laboratories.
- The terms HDMI and HDMI High-Definition Multimedia Interface, and the HDMI Logo are trademarks or registered trademarks of HDMI Licensing LLC in the United States and other countries.
- Microsoft, Windows, Windows Vista, and DirectX are either registered trademarks or trademarks of Microsoft Corporation in the United States and/or other countries.
- Mac, Mac OS and App Store are registered trademarks of Apple Inc.
- Intel, Intel Core, and Pentium are trademarks or registered trademarks of Intel Corporation or its subsidiaries in the United States and other countries.
-  and "PlayStation" are registered trademarks of Sony Computer Entertainment Inc.
- NAVTEQ and the NAVTEQ Maps logo are trademarks of NAVTEQ in the US and other countries.
- SDXC logo is a trademark of SD-3C, LLC.
- MultiMediaCard is a trademark of MultiMediaCard Association.
- Facebook and the "f" logo are trademarks or registered trademarks of Facebook, Inc.
- YouTube and the YouTube logo are trademarks or registered trademarks of Google Inc.
- Android and Google Play are trademarks or registered trademarks of Google Inc.
- iOS is a registered trademark or trademark of Cisco Systems, Inc. and/or its affiliates in the United States and certain other countries.
- Wi-Fi, the Wi-Fi logo, Wi-Fi PROTECTED SET-UP, Wi-Fi Direct, WPA and WPA2 are registered trademarks of the Wi-Fi Alliance.

All other product names mentioned herein may be the trademarks or registered trademarks of their respective companies. Furthermore, <sup>TM</sup> and ® are not mentioned in each case in this manual.

[▲ Back to top](#)

- ▶ Operation Search
- ▶ Before use
- ▶ Getting started
- ▶ Recording
- ▶ Playback
- ▶ Playing images on a TV
- ▶ Saving images with an external device
- ▶ Using the Wi-Fi function
- ▶ Customizing your camcorder
- ▶ Troubleshooting
- ▶ Maintenance and precautions

[➔ Contents list](#)

## Notes on the License

---

ANY USE OF THIS PRODUCT IN ANY MANNER OTHER THAN PERSONAL USE THAT COMPLIES WITH THE MPEG-2 STANDARD FOR ENCODING VIDEO INFORMATION FOR PACKAGED MEDIA IS EXPRESSLY PROHIBITED WITHOUT A LICENSE UNDER APPLICABLE PATENTS IN THE MPEG-2 PATENT PORTFOLIO, WHICH LICENSE IS AVAILABLE FROM MPEG LA, L.L.C., 6312 S. Fiddler's Green Circle, Suite 400E, Greenwood Village, CO 80111 U.S.A.

THIS PRODUCT IS LICENSED UNDER THE AVC PATENT PORTFOLIO LICENSE FOR THE PERSONAL USE OF A CONSUMER OR OTHER USES IN WHICH IT DOES NOT RECEIVE REMUNERATION TO

- (i) ENCODE VIDEO IN COMPLIANCE WITH THE AVC STANDARD ( "AVC VIDEO") AND/OR
- (ii) DECODE AVC VIDEO THAT WAS ENCODED BY A CONSUMER ENGAGED IN A PERSONAL ACTIVITY AND/OR WAS OBTAINED FROM A VIDEO PROVIDER LICENSED TO PROVIDE AVC VIDEO.

NO LICENSE IS GRANTED OR SHALL BE IMPLIED FOR ANY OTHER USE.  
ADDITIONAL INFORMATION MAY BE OBTAINED FROM MPEG LA, L.L.C.  
SEE <[HTTP://WWW.MPEGLA.COM](http://www.mpegla.com)>

We provide the software in your camcorder based on license agreements with the owners of the respective copyrights. Based on requests by the owners of copyright of these software applications, we have an obligation to inform you of the following. Please read the following sections.

Copies of the licenses (in English) are stored in the internal memory of your camcorder. Establish a Mass Storage connection between your camcorder and a computer, and read the files in the "LICENSE" folder in "PMHOME."

### On GNU GPL/LGPL applied software

The software that is eligible for the following GNU General Public License (hereinafter referred to as "GPL") or GNU Lesser General Public License (hereinafter referred to as "LGPL") are included in the camcorder.

This informs you that you have a right to have access to, modify, and redistribute source code for these software programs under the conditions of the supplied GPL/LGPL.

Source code is provided on the web. Use the following URL to download it. When downloading the source code, select HDR-CX390 as the model for your camcorder.

<http://www.sony.net/Products/Linux/>

We would prefer you do not contact us about the contents of source code.

Copies of the licenses (in English) are stored in the internal memory of your camcorder. Establish a Mass Storage connection between your camcorder and a computer, and read the files in the "LICENSE" folder in "PMHOME."

[▲ Back to top](#)