

Getting Started 12

Basic Operations 21

Dubbing/Editing 39

Using a "Memory Stick
Duo" media 45

Customizing your VCR 54

Troubleshooting 66

Additional Information 76

Quick Reference 90

Spanish Quick Guide/
Guía rápida en español 98*Digital HD Videocassette Recorder*

Operating Guide

GV-HD700/1**GV-HD700E/1****HDV****HDV 1080i**Mini DV Digital
Video
Cassette**HDMI**InfoLITHIUM™ L
SERIESInfoLITHIUM™ M
SERIES
MEMORY STICK™

Owner's Record

The model and serial numbers are located on the bottom. Record the serial number in the space provided below. Refer to these numbers whenever you call your Sony dealer regarding this product.

Model No. GV-

Serial No.

Model No. AC-

Serial No.

WARNING

To reduce fire or shock hazard, do not expose the unit to rain or moisture.

Do not expose the batteries to excessive heat such as sunshine, fire or the like.

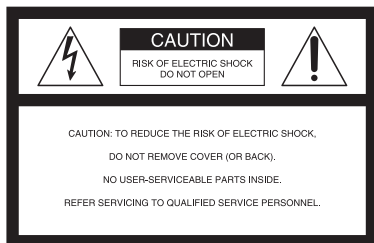

This symbol is intended to alert the user to the presence of uninsulated “dangerous voltage” within the product’s enclosure that may be of sufficient magnitude to constitute a risk of electric shock to persons.



This symbol is intended to alert the user to the presence of important operating and maintenance (servicing) instructions in the literature accompanying the appliance.

IMPORTANT SAFETY INSTRUCTIONS

SAVE THESE INSTRUCTIONS.

DANGER - TO REDUCE THE RISK OF FIRE OR ELECTRIC SHOCK, CAREFULLY FOLLOW THESE INSTRUCTIONS.

- Read these instructions.
- Keep these instructions.
- Heed all warnings.
- Follow all instructions.
- Do not use this apparatus near water.
- Clean only with dry cloth.
- Do not block any ventilation openings. Install in accordance with the manufacturer's instructions.
- Do not install near any heat sources such as radiators, heat registers, stoves, or other apparatus (including amplifiers) that produce heat.
- Do not defeat the safety purpose of the polarized or grounding-type plug. A polarized plug has two blades with one wider than the other. A grounding type plug has two blades and a third grounding prong. The wide blade or the third prong are provided for your safety. If the provided plug does not fit into your outlet, consult an electrician for replacement of the obsolete outlet.
- Protect the power cord from being walked on or pinched particularly at plugs, convenience receptacles, and the point where they exit from the apparatus.
- Only use attachments/accessories specified by the manufacturer.
- Use only with the cart, stand, tripod, bracket, or table specified by the manufacturer, or sold with the apparatus. When a cart is used, use caution when moving the cart/apparatus combination to avoid injury from tip-over.



- Unplug this apparatus during lightning storms or when unused for long periods of time.
- Refer all servicing to qualified service personnel. Servicing is required when the apparatus has been damaged in any way, such as power-supply cord or plug is damaged, liquid has been spilled or objects have fallen into the apparatus, the apparatus has been exposed to rain or moisture, does not operate normally, or has been dropped.
- If the shape of the plug does not fit the power outlet, use an attachment plug adaptor of the proper configuration for the power outlet.

Read this first

Before operating the unit, please read this manual thoroughly, and retain it for future reference.

CAUTION

Excessive sound pressure from earphones and headphones can cause hearing loss.

Battery pack

If the battery pack is mishandled, the battery pack can burst, cause a fire or even chemical burns. Observe the following cautions.

- Do not disassemble.
- Do not crush and do not expose the battery pack to any shock or force such as hammering, dropping or stepping on it.
- Do not short circuit and do not allow metal objects to come into contact with the battery terminals.
- Do not expose to high temperature above 60°C (140°F) such as in direct sunlight or in a car parked in the sun.
- Do not incinerate or dispose of in fire.
- Do not handle damaged or leaking lithium ion batteries.
- Be sure to charge the battery pack using a genuine Sony battery charger or a device that can charge the battery pack.
- Keep the battery pack out of the reach of small children.
- Keep the battery pack dry.
- Replace only with the same or equivalent type recommended by Sony.
- Dispose of used battery packs promptly as described in the instructions.

Replace the battery with the specified type only. Otherwise, fire or injury may result.

AC Adaptor

Do not use the AC Adaptor placed in a narrow space, such as between a wall and furniture.

Use the nearby wall outlet (wall socket) when using the AC Adaptor. Disconnect the AC Adaptor from the wall outlet (wall socket) immediately if any malfunction occurs while using your VCR.

Even if your VCR is turned off, AC power (house current/mains) is still supplied to it while connected to the wall outlet (wall socket) via the AC Adaptor.

For customers in the U.S.A. and CANADA

RECYCLING LITHIUM-ION BATTERIES

Lithium-Ion batteries are recyclable.

You can help preserve our environment by returning your used rechargeable batteries to the collection and recycling location nearest you.

For more information regarding recycling of rechargeable batteries, call toll free 1-800-822- 8837, or visit <http://www.rbrcc.org/>



Caution: Do not handle damaged or leaking Lithium-Ion batteries.

Battery pack

This device complies with Part 15 of the FCC Rules. Operation is subject to the following two conditions: (1) This device may not cause harmful interference, and (2) this device must accept any interference received, including interference that may cause undesired operation.

This Class B digital apparatus complies with Canadian ICES-003.

For customers in the U.S.A.

UL is an internationally recognized safety organization.

The UL Mark on the product means it has been UL Listed.

If you have any questions about this product, you may call:

Sony Customer Information Center 1-800-222-SONY (7669).

The number below is for the FCC related matters only.

Regulatory Information

Declaration of Conformity

Trade Name: SONY

Model No.: GV-HD700/1

Responsible Party: Sony Electronics Inc.

Address: 16530 Via Esprillo, San Diego, CA 92127 U.S.A

Telephone number: 858-942-2230

This device complies with Part 15 of the FCC Rules.

Operation is subject to the following two conditions:

(1) This device may not cause harmful interference, and (2) this device must accept any interference received, including interference that may cause undesired operation.

Declaration of Conformity

Trade Name: SONY

Model No.: GV-HD700E/1

Responsible Party: Sony Electronics Inc.

Address: 16530 Via Esprillo, San Diego, CA 92127 U.S.A

Telephone number: 858-942-2230

This device complies with Part 15 of the FCC Rules.

Operation is subject to the following two conditions:

(1) This device may not cause harmful interference, and (2) this device must accept any interference received, including interference that may cause undesired operation.

CAUTION

You are cautioned that any changes or modifications not expressly approved in this manual could void your authority to operate this equipment.

Note

This equipment has been tested and found to comply with the limits for a Class B digital device, pursuant to Part 15 of the FCC Rules. These limits are designed to provide reasonable protection against harmful interference in a residential installation. This equipment generates, uses, and can radiate radio frequency energy and, if not installed and used in accordance with the instructions, may cause harmful interference to radio communications.

However, there is no guarantee that interference will not occur in a particular installation. If this equipment does cause harmful interference to radio or television reception, which can be determined by turning the equipment off and on, the user is encouraged to try to correct the interference by one or more of the following measures:



- Reorient or relocate the receiving antenna.
- Increase the separation between the equipment and receiver.
- Connect the equipment into an outlet on a circuit different from that to which the receiver is connected.
- Consult the dealer or an experienced radio/TV technician for help.

The supplied interface cable must be used with the equipment in order to comply with the limits for a digital device pursuant to Subpart B of Part 15 of FCC Rules.

Read this first (Continued)

Notice for customers in the United Kingdom

A moulded plug complying with BS 1363 is fitted to this equipment for your safety and convenience.

Should the fuse in the plug supplied need to be replaced, a fuse of the same rating as the supplied one and approved by ASTA or BSI to BS 1362 (i.e., marked with an  or  mark) must be used.

If the plug supplied with this equipment has a detachable fuse cover, be sure to attach the fuse cover after you change the fuse. Never use the plug without the fuse cover. If you should lose the fuse cover, please contact your nearest Sony service station.

For customers in Europe

< Notice for the customers in the countries applying EU Directives >

The manufacturer of this product is Sony Corporation, 1-7-1 Konan Minato-ku Tokyo, 108-0075 Japan. The Authorized Representative for EMC and product safety is Sony Deutschland GmbH, Hedelfinger Strasse 61, 70327 Stuttgart, Germany. For any service or guarantee matters please refer to the addresses given in separate service or guarantee documents.

This product has been tested and found compliant with the limits set out in the EMC Directive for using connection cables shorter than 3 meters (9.8 feet).

ATTENTION

The electromagnetic fields at the specific frequencies may influence the picture and sound of this unit.

Notice

If static electricity or electromagnetism causes data transfer to discontinue midway (fail), restart the application or disconnect and connect the communication cable (USB, etc.) again.



Disposal of Old Electrical & Electronic Equipment (Applicable in the European Union and other European countries with separate collection systems)

This symbol on the product or on its packaging indicates that this product shall not be treated as household waste. Instead it shall be handed over to the applicable collection point for the recycling of electrical and electronic equipment.

By ensuring this product is disposed of correctly, you will help prevent potential negative consequences for the environment and human health, which could otherwise be caused by inappropriate waste handling of this product. The recycling of materials will help to conserve natural resources. For more detailed information about recycling of this product, please contact your local Civic Office, your household waste disposal service or the shop where you purchased the product.

Applicable Accessory: Remote Commander

Notes on use

Types of cassette you can use in your VCR

You can use mini DV cassettes marked with . Your VCR is not compatible with the Cassette Memory function (p. 79).

Types of "Memory Stick" media you can use in your VCR

You can use "Memory Stick Duo" media marked with **MEMORY STICK DUO** or **MEMORY STICK PRO DUO** (p. 80).

“Memory Stick Duo” media
(This size can be used with your VCR.)



“Memory Stick” media
(You cannot use it in your VCR.)



- You cannot use any type of memory card except “Memory Stick Duo” media.
- “Memory Stick PRO” media and “Memory Stick PRO Duo” media can be used only with “Memory Stick PRO” media compatible equipment.
- Do not attach a label or the like on a “Memory Stick Duo” media or a “Memory Stick Duo” media adaptor.

When using a “Memory Stick Duo” media with “Memory Stick” media compatible equipment

Be sure to insert the “Memory Stick Duo” media into the “Memory Stick Duo” media adaptor.

“Memory Stick Duo” media adaptor



On using the VCR

- Do not hold the VCR by the following parts.

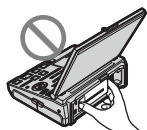

Battery pack



LCD panel

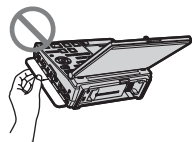

Jack cover

- The VCR is not dustproofed, dripproofed or waterproofed. See “About handling of your VCR” (p. 84).
- When connecting the VCR to another device with a cable, be sure to insert the connector plug in the correct way. Pushing the plug forcibly into the terminal will damage the terminal and may result in a malfunction of the VCR.

About menu items and the LCD panel

- A menu item that is grayed out is not available under the current recording or playback conditions.
- The LCD screen is manufactured using extremely high-precision technology, so over 99.99% of the pixels are operational for effective use. However, there may be some tiny black points and/or bright points (white, red, blue, or green in color) that appear constantly on the LCD screen. These points are normal results of the manufacturing process and do not affect the recording in any way.

Read this first (Continued)

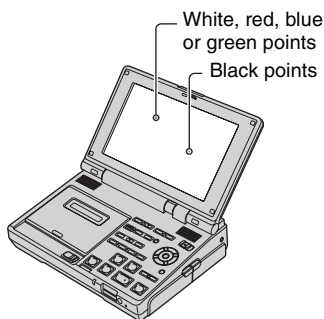

- Exposing the LCD screen to direct sunlight for long periods of time may cause malfunctions.

About language setting

- The on-screen displays in each local language are used for illustrating the operating procedures. Change the screen language before using the VCR if necessary (p. 19).

About temperature of your VCR and battery pack

- Your VCR features a protective circuit that disables recording or playback if the VCR or battery pack reaches a certain temperature. In this case, a message appears on the screen (p. 73).

On recording

- Before starting to record, test the recording function to make sure the picture and sound are recorded without any problems.
- Compensation for the contents of recordings cannot be provided, even if recording or playback is not possible due to a malfunction of the VCR, storage media, etc.
- TV color systems differ depending on the countries/regions. To view recorded pictures on a TV, you need to use a NTSC

TV (for GV-HD700/1 owners) or a PAL TV (for GV-HD700E/1 owners).

- Television programs, films, video tapes, and other materials may be copyrighted. Unauthorized recording of such materials may be contrary to the copyright laws.

On playing back the tapes recorded in the HDV format on other devices

The tape recorded in the HDV format cannot be played back on a video camera only compatible with the DV format or a mini-DV player.

Check the contents of tapes by playing them back on this VCR prior to playing them back on other devices.

Notes on the icons used in this manual

 Features available for the HDV format only

 Features available for the DV format only

 Feature available when the VCR connects to other devices via the i.LINK cable

 Feature available when the VCR connects to via the USB cable

About this manual

- The images of the LCD screen used in this manual for illustration purposes are captured using a digital still camera, and therefore may appear different.
- The indicators on the LCD screen shown in this manual may look different from what you actually see.
- Design and specifications of recording media and other accessories are subject to change without notice.

Table of Contents

IMPORTANT SAFETY INSTRUCTIONS	3
Read this first	4
What you can do with your VCR	11

Getting Started

Step 1: Checking supplied items	12
Step 2: Preparing the power supply	13
Step 3: Turning the power on, and setting the date and time	18
Changing the language setting	19
Step 4: Inserting a cassette tape or a “Memory Stick Duo” media	19

Basic Operations

Playback on your VCR	21
Using the Remote Commander	22
Playing the picture on a TV	24
Recording the picture from TV, VCR, etc.	29
Locating a scene on the tape	32
Locating a desired scene quickly (Zero set memory)	32
Searching for the last scene of the most recent recording (End search)	33
Searching for a scene by date of recording (Date search)	33
Searching for the point where the index signal is recorded (Index search)	34
Changing/checking the settings in your VCR	35
Turning off the LCD screen	35
Switching the information display on the screen	35

Displaying the settings in your VCR (Status check)	35
Displaying all area surrounding the picture frame (All scan)	36

Assigning the functions to the ASSIGN buttons	36
Using PB zoom	37
Recording an index signal	38

Dubbing/Editing

Dubbing to VCR, DVD/HDD recorder, etc.	39
Using with an analog video unit and your computer (Signal convert function)	43

Using a “Memory Stick Duo” media

Capturing a still image to a “Memory Stick Duo” media from a picture recorded on a tape	45
Viewing a still image on a “Memory Stick Duo” media (Memory photo playback).....	46
Copying still images on the “Memory Stick Duo” media to a computer...47	
Deleting recorded still images from the “Memory Stick Duo” media ...50	
Printing recorded images (PictBridge compliant printer)	51

Customizing your VCR

Using the menu items	54
List of the menu items	55
⇌ (IN/OUT REC) menu	56
Recording settings, input and output settings (HDV/DV SEL/DV REC MODE/TV TYPE, etc.)	

 (DISPLAY SET) menu	58
Display settings of the LCD screen (LCD SET/COLOR BAR/DATA CODE, etc.)	
 (AUDIO SET) menu	61
Settings for the audio recording (DV AU.MODE/DV AUDIO MIX, etc.)	
 (MEMORY SET) menu	62
Settings for the "Memory Stick Duo" media (QUALITY/ALL ERASE, etc.)	
 (OTHERS) menu	64
Other basic settings (BEEP/USB SELECT, etc.)	

Troubleshooting

Troubleshooting	66
Warning indicators and messages	73

Additional Information

Using your VCR abroad	76
Maintenance and precautions	79
HDV format and recording/playback	
.....	79
About the "Memory Stick" media	80
About the "InfoLITHIUM" battery pack	81
About i.LINK	82
About x.v.Color	84
About handling of your VCR	84
Specifications	86

Quick Reference

Identifying parts and controls	90
Indicators displayed during recording/ playback	94
Index	96

Spanish Quick Guide/Guía rápida en español 98

What you can do with your VCR

Trying out the HDV format!

The HDV format has about more than 2 times the horizontal resolution of a standard TV, and providing high quality images. Being the HDV format compliant, your VCR is ready to record/play back crystal clear, high-definition images.

? What is the HDV format?

The HDV format is a new video format for recording and playing back high definition images on popular DV standard cassette tapes.

- **The VCR adopts the HDV1080i specification, which utilizes 1,080 effective scanning lines, within the HDV standards,** and records pictures at the image bit rate of about 25 Mbps.



1,080 effective scanning lines

- This “Operating Guide” refers to the HDV1080i specification as HDV format unless there is a need to specify.

Features of this VCR

1 Compatible with HDV/DV formats

The VCR is compatible with both the HDV and DV formats. You can record or play back a tape in the desired format.

2 Equipped with a 7 widescreen LCD monitor

The VCR is equipped with a widescreen monitor with a crystal clear display.

3 Connectable with 2 types of battery packs

The VCR is compatible with both the L series battery pack and the M series pack to suit your needs.

4 Connectable with various devices

On the side of the VCR, an i.LINK HDV/DV (i.LINK) interface, an HDMI OUT jack, a COMPONENT OUT jack, and A/V jacks are equipped. Various external terminals such as a USB jack, a “Memory Stick Duo” media slot, etc. are also provided.

5 Equipped with functions for professional use

The VCR is featured with the all scan function, the ASSIGN buttons, the status check function, etc. The functions are also designed for professional use.

6 Capturing 1.2 million pixels still images from movies

You can select your best shot from HD (high definition) movies on the tape, and capture it as a still image that has a maximum size of 1.2 million pixels (1440 × 810 dots) to the “Memory Stick Duo” media.

Step 1: Checking supplied items

Make sure that you have the following items supplied with your VCR. The number in the parentheses indicates the number of that item supplied.

AC Adaptor (1) (p. 13)

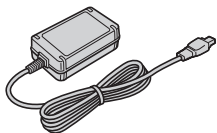

Power cord (Mains lead) (1) (p. 13)



Wireless Remote Commander (1) (p. 93)



Size R6 (AA) battery for the supplied Remote Commander (2)
For details on how to change the battery, see page 93.

A/V connecting cable (1) (p. 24, 26, 41)



Component video cable (1) (p. 24, 26)

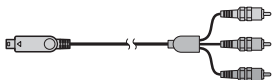

USB cable (1) (p. 48)

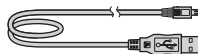

Rechargeable battery pack NP-F570 (1) (p. 13, 81)

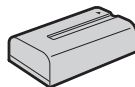

Operating Guide (This manual) (1)

Step 2: Preparing the power supply

Provide an outside power source to use the VCR. You can either connect the AC Adaptor to a wall outlet (wall socket) or charge the battery pack to use your VCR.

Using an outside power source from a wall outlet (wall socket) with the AC Adaptor

When recording/editing or using the VCR for a long time, connect the AC Adaptor to a wall outlet (wall socket) to obtain a power source.

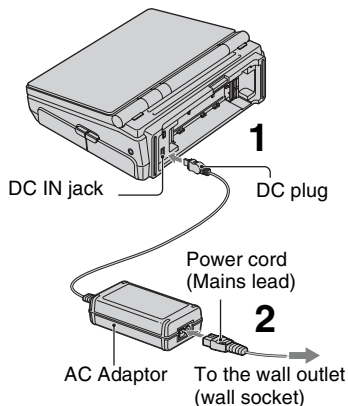

1 Connect the AC Adaptor to the DC IN jack on the VCR. Make sure that the ▲ mark on the DC plug is facing to the ▲ mark on the VCR.

2 Connect the power cord (mains lead) to the AC Adaptor and the wall outlet (wall socket).

Notes

- Disconnect the AC Adaptor from the DC IN jack by holding both the VCR and the DC plug.
- Do not pull the power cord (mains lead) connected to a wall outlet (wall socket). The DC plug may be removed from the wall outlet (wall socket).
- Keep the AC Adaptor away from the VCR if the picture is disturbed.

Tips

- You can use the VCR with an outside power source from the wall outlet (wall socket) even if attaching the battery pack. The battery pack will not lose its charge in this case.

Charging the battery pack

You can attach the exclusive “InfoLITHIUM” battery pack L series (on version supplied) or the M series (optional) (p. 15) to the VCR and charge it. For the types of battery packs compatible with the VCR, see page 16.

1 Attach the battery pack by holding the center part (①) and sliding it in the direction of the arrow (②) until it clicks.

L series:

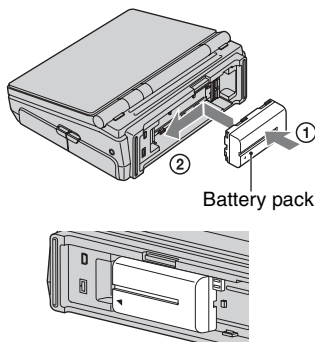

Step 2: Preparing the power supply (Continued)

Make sure that the battery pack is not inclined and is locked to the VCR securely.

- 2 Slide the OPEN → lever and open the LCD panel.

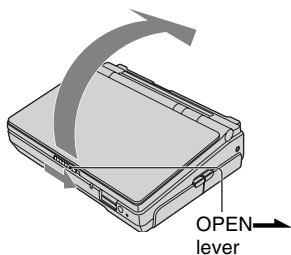

- 3 Set the POWER switch to OFF (CHG) (The default setting).

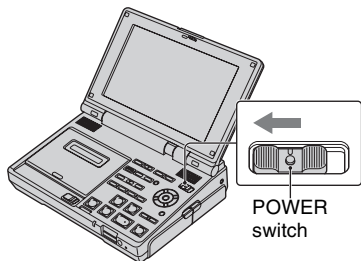

- 4 Connect the AC Adaptor to the DC IN jack on the VCR. Make sure that the ▲ mark on the DC plug is facing to the ▲ mark on the VCR.

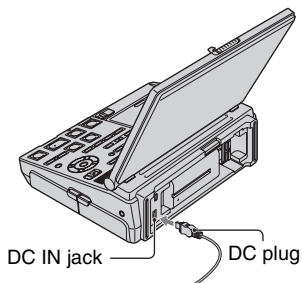

5 Connect the power cord (mains lead) to the AC Adaptor and the wall outlet (wall socket).

The POWER/CHARGE lamp turns on orange and charging starts.

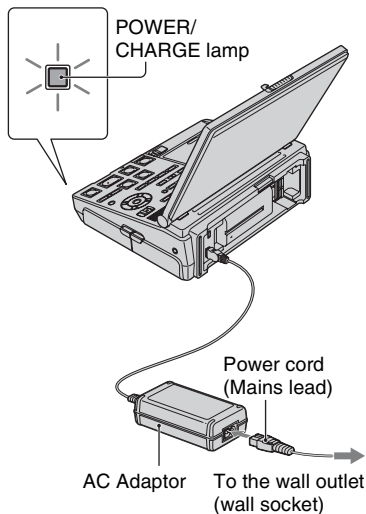

The POWER/CHARGE lamp turns off when the battery pack is fully charged. After charging the battery pack, disconnect the AC Adaptor from the DC IN jack on the VCR.

Notes

- The direction to attach the L series is different from that of the M series (optional) (p. 15). Make sure to attach your battery in the correct direction. If you attempt to attach it in the wrong direction forcibly, a malfunction may occur.
- Make sure not to come in contact with the other battery terminal available for other battery packs when charging your battery pack.
- Disconnect the AC Adaptor from the DC IN jack by holding both the VCR and the DC plug.

To remove the battery pack

Set the POWER switch to OFF (CHG). Push and hold the **▲BATT RELEASE** button and remove the battery pack.

L series:

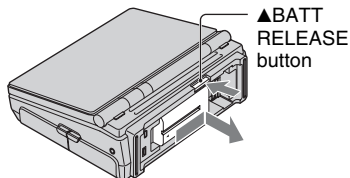

Notes

- When you remove the battery pack or disconnect the AC Adaptor, make sure that the POWER/CHARGE lamp is turned off.

To use the “InfoLITHIUM” battery pack M series (optional)

To attach:

Attach the battery pack by holding the center part (1) and sliding it in the direction of the arrow (2) until it clicks.

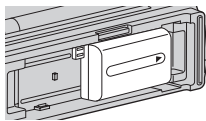
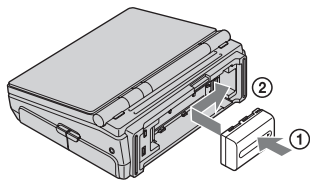

Make sure that the battery pack is not inclined and is locked to the VCR securely.

Step 2: Preparing the power supply (Continued)

To remove:

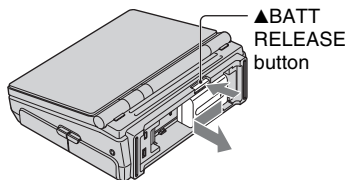

When storing the battery pack

Fully discharge the battery pack before storing it for an extended period (see page 82 for details of storage).

To check the remaining battery (Battery Info)

Set the POWER switch to OFF (CHG), then press DISPLAY/BATT INFO.

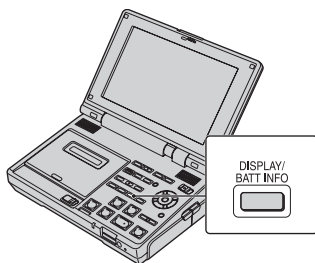

After a while, the approximate available playback time and battery information appear for about 7 seconds. You can view the battery information for up to 20 seconds by pressing DISPLAY/BATT INFO again, while the information is displayed.

Remaining battery (approx.)

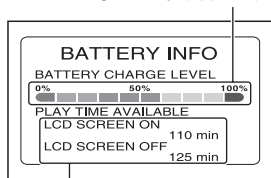

Available playback time (approx.)

Charging time

Approximate time (min.) required when you fully charge a fully discharged battery pack.

Battery pack	Charging time
NP-FM50	150
NP-QM71D	260
NP-QM91D	360
NP-F570 (supplied)	260
NP-F770	370
NP-F970	485

Notes

- You cannot use the battery pack NP-FM30/F330/F530/500/510/710 on the VCR. Do not attach an incompatible battery pack forcibly. Doing so may cause the VCR to malfunction.

Available playback time

Approximate time (min.) available when you use a fully charged battery pack.

HDV format pictures (GV-HD700/1)

Battery pack	LCD panel opened	LCD panel closed
NP-FM50	75	115
NP-QM71D	190	285
NP-QM91D	290	430
NP-F570 (supplied)	150	225
NP-F770	310	460
NP-F970	465	690

DV format pictures (GV-HD700/1)

Battery pack	LCD panel opened	LCD panel closed
NP-FM50	80	130
NP-QM71D	205	315
NP-QM91D	315	475
NP-F570 (supplied)	160	245
NP-F770	335	510
NP-F970	500	760

HDV format pictures (GV-HD700E/1)

Battery pack	LCD panel opened	LCD panel closed
NP-FM50	75	115
NP-QM71D	190	285
NP-QM91D	290	430
NP-F570 (supplied)	150	225
NP-F770	310	460
NP-F970	465	690

DV format pictures (GV-HD700E/1)

Battery pack	LCD panel opened	LCD panel closed
NP-FM50	80	130
NP-QM71D	205	315
NP-QM91D	315	475
NP-F570 (supplied)	160	245
NP-F770	335	510
NP-F970	500	760

On the battery pack

- Before changing the battery pack, set the POWER switch to OFF (CHG) and turn off the POWER/CHARGE lamp (p. 14).
- The POWER/CHARGE lamp flashes during charging, or Battery Info (p. 16) will not be correctly displayed under the following conditions:
 - The battery pack is not attached correctly.
 - The battery pack is damaged.
 - The battery pack is worn-out (For Battery Info only).
 - The battery pack is too cold.
Replace the battery pack, or remove it and put it in a warm place.
 - The battery pack is too hot.
Replace the battery pack, or remove it and put it in a cool place.
- The power will not be supplied from the battery as long as the AC Adaptor is connected to the DC IN jack of the VCR, even when the power cord (mains lead) is disconnected from the wall outlet (wall socket).

On the charging/playback time

- Times measured with the VCR at 25 °C (77 °F) (10 to 30 °C (50 °F to 86 °F)) is recommended).
- The available playback time will be shorter when you use the VCR in low temperatures.
- The available playback time will be shorter depending on the conditions under which you use the VCR.

On the AC Adaptor

- Do not short-circuit the DC plug of the AC Adaptor or battery terminal with any metallic objects. This may cause a malfunction.

Step 3: Turning the power on, and setting the date and time

Set the date and time when using your VCR for the first time. If you do not set the date and time, the [CLOCK SET] screen appears every time you turn on your VCR.

- 1 Slide the OPEN → lever and open the LCD panel.

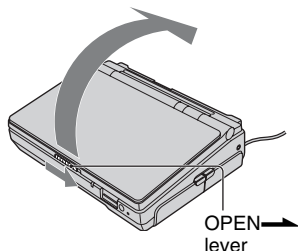

- 2 While pressing the green button, set the POWER switch to ON.

The POWER/CHARGE lamp on the front turns on green and the [CLOCK SET] screen appears.

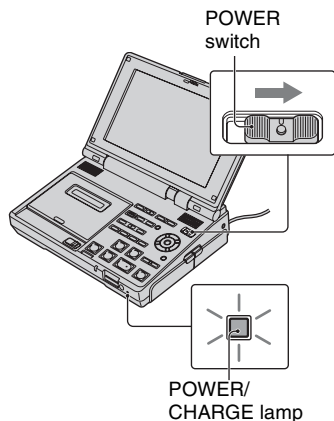

- 3 Set [Y] (year) using ↑/↓, then press EXEC.

You can set any year up to the year 2079.

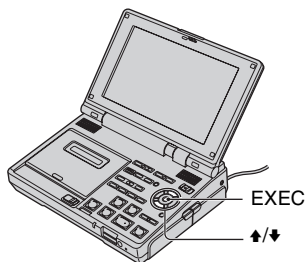

GV-HD700/1:

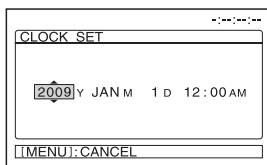

12:00 AM stands for midnight.

12:00 PM stands for noon.

GV-HD700E/1:

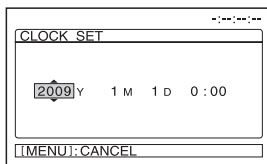

- 4 Set [M] (month), [D] (day), the hours and minutes in the same way, then press EXEC.

The clock starts.

To turn off the power

Set the POWER switch to OFF (CHG).

To reset the date and time

Press MENU and select  (OTHERS) → [CLOCK SET], then set the date and time.

Notes

- If you do not use the VCR for **about 3 months**, the built-in rechargeable battery gets discharged and the date and time settings may be cleared from the memory. In this case, charge the built-in rechargeable battery and then set the date and time again (p. 86).
- It takes a few seconds for the VCR to be ready to record or playback after the power is turned on. You cannot operate the VCR during this time.

Changing the language setting

Press MENU and select  (OTHERS) → [LANGUAGE], then set the desired language (p. 64).

Step 4: Inserting a cassette tape or a “Memory Stick Duo” media

Cassette tape

You can use mini DV ^{Mini DV} cassettes only (p. 79).

- 1 Slide EJECT lever in the direction of the arrow.

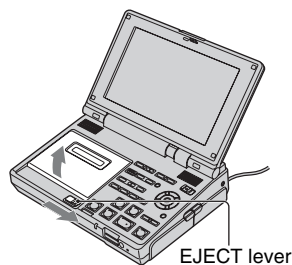

The cassette compartment automatically comes out and opens up.

- 2 Insert a cassette tape with its window facing up.

Push the center of the back of the cassette tape lightly.

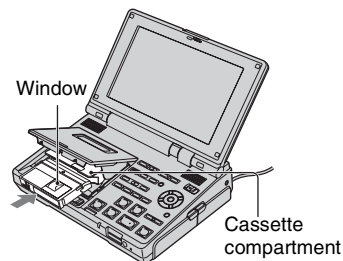

Step 4: Inserting a cassette tape or a “Memory Stick Duo” media (Continued)

3 Close the cassette compartment lid by pressing **(PUSH)** mark.

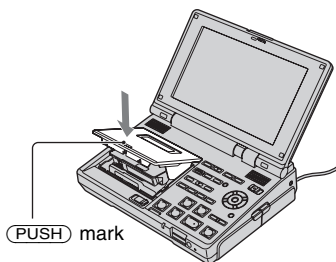

The cassette compartment automatically slides back in.

⚡ Notes

- Do not insert your fingers or touch the inside of the cassette compartment when it is open. It may cause a malfunction.
- If you touch any part of the VCR other than the **(PUSH)** mark when closing the cassette compartment, the cassette compartment may not be closed properly.
- Do not close the cassette compartment until it opens completely. It may cause a malfunction.

💡 Tips

- The recordable time varies depending on [DV REC MODE] (p. 56). **(DV)**

To eject the cassette tape

Open the cassette compartment following the same procedure as described in step 1 and remove the cassette tape.

“Memory Stick Duo” media

You can use a “Memory Stick Duo” media marked with **MEMORY STICK DUO** or **MEMORY STICK PRO DUO** only (p. 80).

Insert the “Memory Stick Duo” media into the “Memory Stick Duo” media slot in the right direction until it clicks.

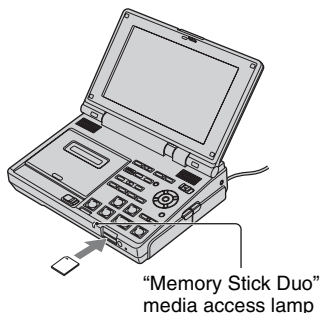

⚡ Notes

- If you insert the “Memory Stick Duo” media into the slot in the wrong direction, the “Memory Stick Duo” media, the “Memory Stick Duo” media slot or image data may be damaged.

To eject the “Memory Stick Duo” media

Lightly push the “Memory Stick Duo” media once.

⚡ Notes

- When the access lamp is lit or flashing, the VCR is reading/writing data. Do not shake or knock the VCR, turn the power off, eject the “Memory Stick Duo” media, or remove the battery pack. Otherwise, image data may be damaged.
- When inserting or ejecting the “Memory Stick Duo” media, be careful with the “Memory Stick Duo” media from popping out and dropping.

Playback on your VCR

You can play back movies as follows.

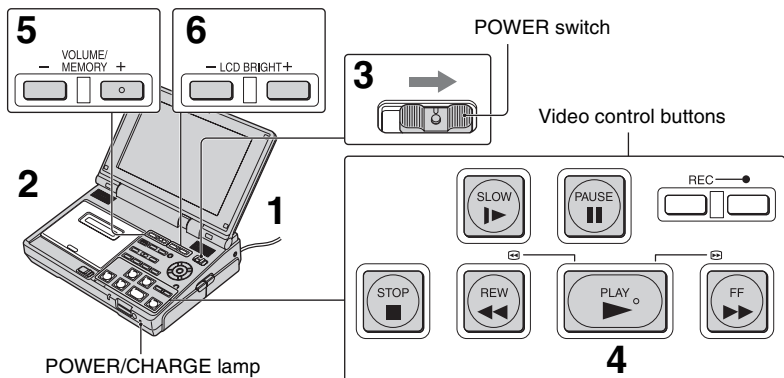

1 Prepare the power supply (p. 13).

2 Insert a cassette tape for playback (p. 19).

3 While pressing the green button, set the **POWER** switch to **ON**.

The **POWER/CHARGE** lamp on the front turns on green.

4 Press **PLAY** ►.

Playback starts.

5 Adjust the sound volume using **VOLUME/MEMORY** (–/+).

6 Adjust the brightness of the LCD screen using **LCD BRIGHT** (–/+).

Notes

- When you play back a tape recorded in the HDV and DV formats, the picture and sound are temporarily interrupted when the signal switches between the HDV and DV formats.
- The tape recorded in the HDV format cannot be played back on a video camera only compatible with the DV format or a mini-DV player.

Tips

- Indicators displayed on the screen during playback are shown on page 35, 94.
- You can also adjust the brightness of the LCD screen by setting (DISPLAY SET) → [LCD SET] → [BRIGHTNESS] (p. 58).
- If you adjust the brightness of the LCD screen during recording or playback, the recorded and original picture will not be affected.
- To play back the tape recorded on the other VCR using an external monaural microphone connected, see [MULTI-SOUND] (p. 61).
- When using headphones (optional), connect headphones to the (headphones) jack (p. 91).

To stop playback

Press **STOP** ■.

Playback on your VCR (Continued)

To pause playback

Press PAUSE **||** during playback. To resume playback, press PAUSE **||** or PLAY **▶**.

💡 Tips

- Playback automatically stops if pause is engaged for more than 3 minutes.

To fast forward/rewind the tape

To fast forward the tape while playback is stopped, press FF **▶▶**. To rewind the tape while playback is stopped, press REW **◀◀**.

💡 Tips

- During fast forward/rewind the tape, the LCD screen becomes dim. This is not a malfunction.

To search for a scene while viewing a picture

Press FF **▶▶**/REW **◀◀** during playback (Picture Search). To view a desired scene during fast forward, press and hold FF **▶▶**, and to view a desired scene during rewind, press and hold REW **◀◀** (Skip Scan).

To play back the picture at slow speed (Slow playback)

Press SLOW **▶** during playback. To resume normal playback, press PLAY **▶**.

📌 Notes

- During playback pause or in any playback mode other than normal playback, no sound is produced and the previous picture may remain on the screen as a mosaic image.
- Note the following when playing back the picture recorded in the HDV format:
 - Pictures recorded in the HDV format are not output from the **i** HDV/DV (i.LINK) interface during playback pause or in any playback mode other than normal playback.
 - Pictures may be distorted during picture search.

Using the Remote Commander

You can operate the VCR with the Remote Commander. The buttons on the Remote Commander have the same functions with the video control buttons on the VCR, and some of the functions are available exclusively by the Remote Commander only.

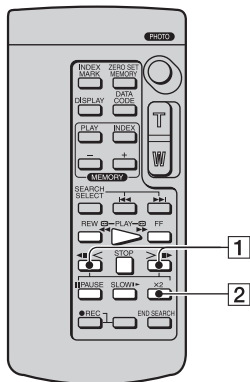

To reverse playback direction

Press **◀|| < 1** during playback. To slow playback in reverse direction, press **◀|| < 1** during playback, then press SLOW **▶**.





💡 Tips

- When you play back a tape in reverse direction, horizontal noise may appear at the center or the top and bottom of the screen. This is not a malfunction.

To view the picture frame-by-frame

Press **> ||▶ (+) 1** during playback pause. For frame-by-frame playback in reverse direction, press **◀|| < (-) 1** during playback pause.

To view the picture at double speed (Double speed playback)

Press $\times 2$  during playback. To double the speed of playback in reverse direction, press  $<$ , then press $\times 2$ .

Notes

- For more details about the Remote Commander, see page 32, 93.
- During playback pause or in any playback mode other than normal playback, no sound is produced and the previous picture may remain on the screen as a mosaic image.
- Note the following when playing back the picture recorded in the HDV format:
 - Reverse slow playback and reverse frame-by-frame playback do not function.
 - Pictures recorded in the HDV format are not output from the  HDV/DV (i.LINK) interface during playback pause or in any playback mode other than normal playback.
 - Pictures may be distorted during reverse playback.
 - Pictures may be distorted during picture search.

Playing the picture on a TV

Connection methods and image quality differ depending on what type of TV is connected and connectors are used.

It is recommended to connect your VCR to the wall outlet (wall socket) using the supplied AC Adaptor for this operation (p. 13). Refer also to the instruction manual supplied with the device to be connected.

💡 Tips

- You can play back pictures recorded in x.v.Color on the TV supporting x.v.Color (p. 84). To playing back the pictures, the settings of the TV may be needed.

Jacks on the VCR

Open the jack cover and connect the cable.

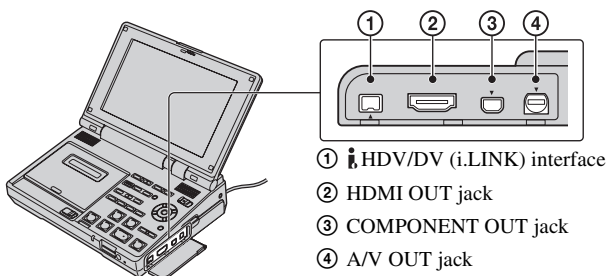

🔔 Notes

- Disconnect the i.LINK cable before changing [HDV/DV SEL] and [i.LINK CONV] settings. Otherwise, the TV may not recognize the video signal from the VCR.

Connecting to a high definition TV

Images recorded with HD (high definition) image quality are played back with HD (high definition) image quality. Images recorded with SD (standard definition) image quality are played back with SD (standard definition) image quality.

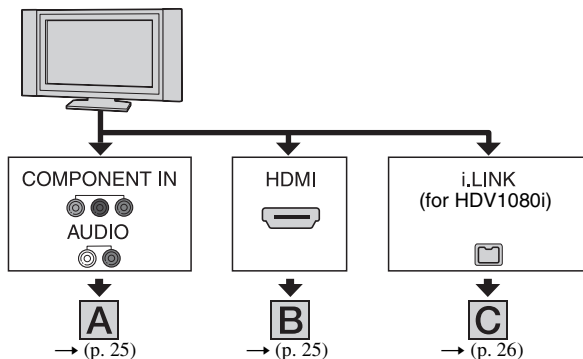

↔ : Signal flow

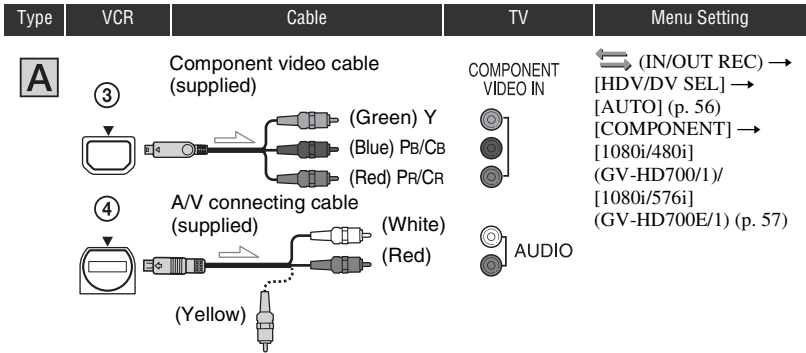

Notes

- An A/V connecting cable is also needed to output audio signals. Connect the white and red plugs of the A/V connecting cable to the audio input jack of your TV.

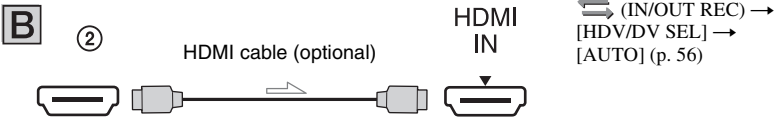

Notes

- Use an HDMI cable with the HDMI logo.
- Pictures in the DV format are not output from the HDMI OUT jack, if copyright protection signals are recorded in the pictures.
- DV format pictures input to the VCR via i.LINK cable (p. 29) cannot be output.
- Your TVs may not function correctly (for example, no sound or image). Do not connect the HDMI OUT jack of the VCR and HDMI jack of the external device with the HDMI cable. This may cause a malfunction.

Playing the picture on a TV (Continued)

 : Signal flow

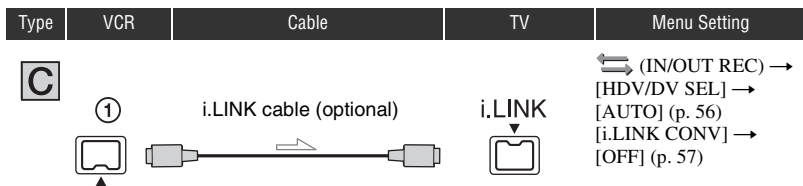

Notes

- Your TV needs to have an i.LINK jack compatible with HDV1080i. For details, confirm the specifications of the TV.
- If your TV is not compatible with HDV1080i, connect the VCR and TV with the supplied component video cable and A/V connecting cable as illustrated in **A**.
- The TV needs to be set to recognize the connection of the VCR. See the instruction manual supplied with your TV.
- This VCR has a 4-pin i.LINK terminal. Select a cable that fits the terminal on the device to be connected.

Connecting to a non-high-definition 16:9 (wide) or 4:3 TV

Images recorded with HD (high definition) quality are converted to SD (standard definition) and played back. Images recorded with SD (standard definition) image quality are played back with SD (standard definition) image quality.

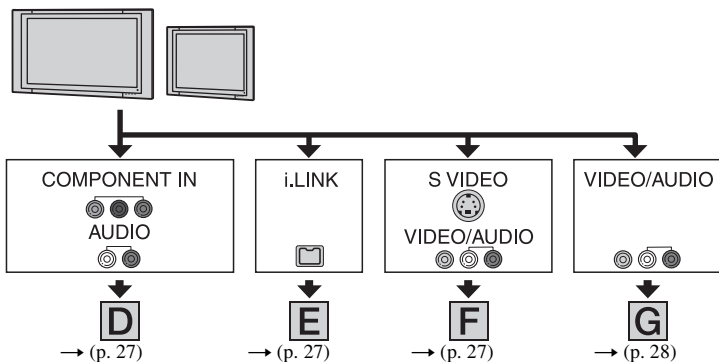

To set the aspect ratio according to the connected TV (16:9/4:3)

Set [TV TYPE] to [16:9] or [4:3] according to your TV type (p. 57).

↔ : Signal flow

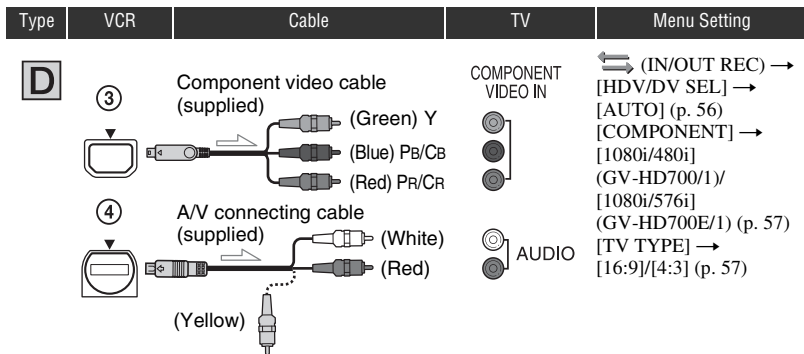

Notes

- An A/V connecting cable is also needed to output audio signals. Connect the white and red plugs of the A/V connecting cable to the audio input jack of your TV.

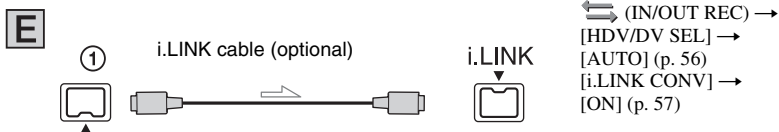

Notes

- The TV needs to be set so that it recognizes that the VCR is connected. See the instruction manual supplied with your TV.
- The VCR has a 4-pin i.LINK terminal. Select a cable that fits the terminal on the device to be connected.

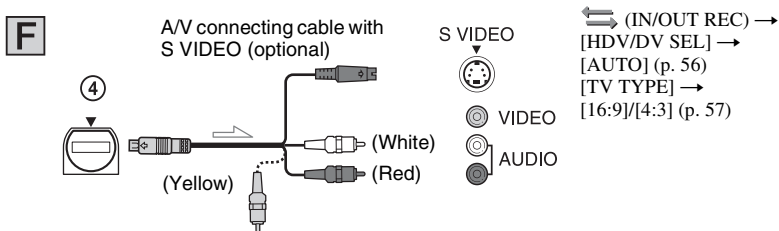

Notes

- When the S VIDEO plug (S VIDEO channel) is connected, audio signals are not output. To output audio signals, connect the white and red plugs of an A/V connecting cable with S VIDEO to the audio input jack of your TV.
- This connection produces higher resolution pictures compared with the A/V connecting cable (Type **G**).

Playing the picture on a TV (Continued)

 : Signal flow

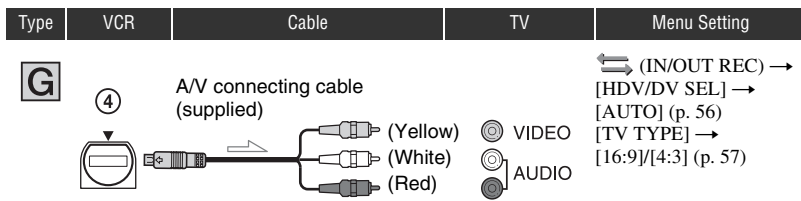

When connecting to your TV via the other VCR

Select the desired connecting method according to the input jack of the other VCR. Connect the VCR to the LINE IN input on the other VCR using the A/V connecting cable. Set the input selector on the other VCR to LINE (VIDEO 1, VIDEO 2, etc.).

When your TV is monaural (When your TV has only one audio input jack)

Connect the yellow plug of the A/V connecting cable to the video input jack, then connect the white (left channel) or red (right channel) plug to the audio input jack of your TV.

If your TV/VCR has a 21-pin adaptor (EUROCONNECTOR) (GV-HD700E/1 only)

Use a 21-pin adaptor (optional) to view playback pictures.

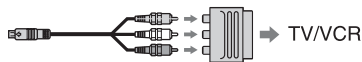

Notes

- When the A/V connecting cable is used to output images, images are output with SD (standard definition) image quality.

Tips

- If you connect the VCR to a TV using more than one type of cable to output pictures from a jack other than the i.LINK jack, the order of priority of the output signal is as follows:
HDMI OUT → COMPONENT OUT → A/V OUT
- HDMI (High-Definition Multimedia Interface) is an interface to send both video/audio signals. The HDMI OUT jack outputs high quality images and digital audio.

Recording the picture from TV, VCR, etc.

Connect the VCR to the wall outlet (wall socket) using the supplied AC Adaptor for this operation (p. 13). Refer also to the instruction manual supplied with the device to be connected.

Connecting to external devices

The connection method and the image quality will differ depending on the TV, VCR and the connectors used.

Jacks on the VCR

Open the jack cover and connect the cable.

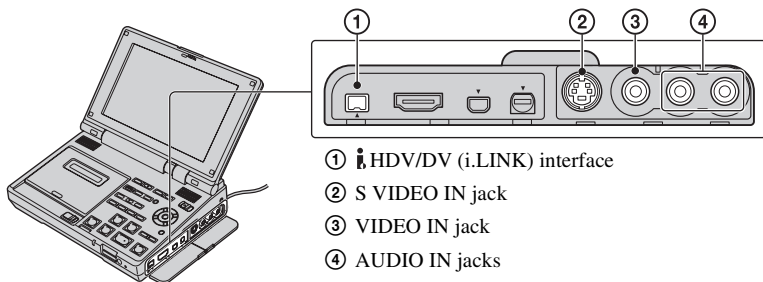

Using an i.LINK cable (optional)

↗: Signal flow

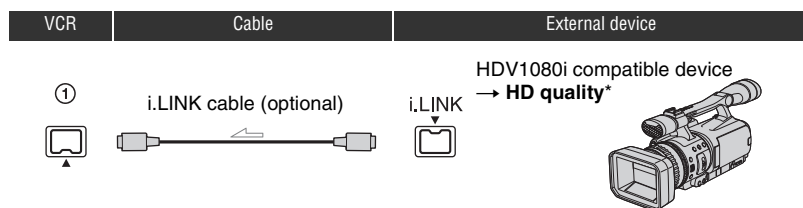

* The external device should come equipped with an i.LINK jack compatible with HDV1080i.

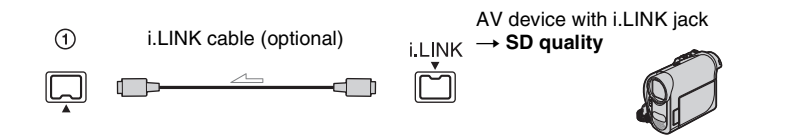

* Pictures recorded in the DV format are recorded in the SD (standard definition) quality.

Recording the picture from TV, VCR, etc. (Continued)

🔊 Notes

- Disconnect the i.LINK cable before changing [HDV/DV SEL] and [i.LINK CONV] settings. Otherwise, the VCR may not recognize the video signal from the connected device.
- This VCR has a 4-pin i.LINK terminal. Select a cable that fits the terminal on the device to be connected.

💡 Tips

- When you use an i.LINK cable, the video and sound signals are transmitted digitally, producing high quality pictures.

Using an S VIDEO cable and A/V connecting cable, or an A/V connecting cable alone

↗ : Signal flow

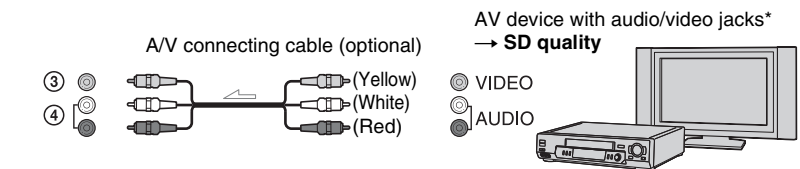
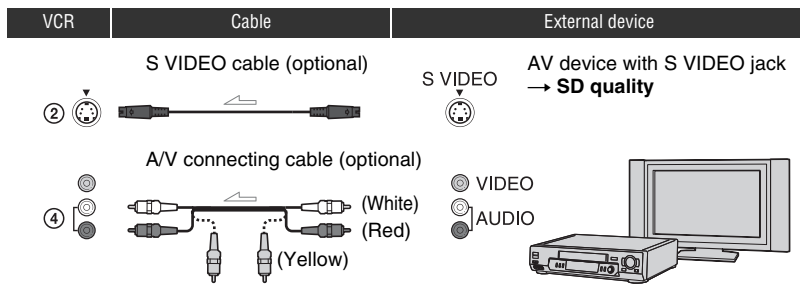

* When connecting the VCR to a monaural device, connect the yellow plug of the A/V connecting cable to the video jack on the device, and connect the white (left channel) or red (right channel) plug to the audio jack on the device.

🔊 Notes

- Select a cable that fits the terminal on the device to be connected.

💡 Tips

- When you connect the VCR to an external device via the S VIDEO jack by using an S VIDEO cable (optional), higher quality DV format pictures can be produced than when using an A/V connecting cable. When you connect with an S VIDEO cable (optional) alone, audio will not be output.
- If you connect the VCR to a TV using more than one type of cable to input pictures from a jack other than the HDV/DV (i.LINK) interface, the order of priority of the input signal is as follows:
S VIDEO IN → VIDEO IN

Recording the picture on your VCR

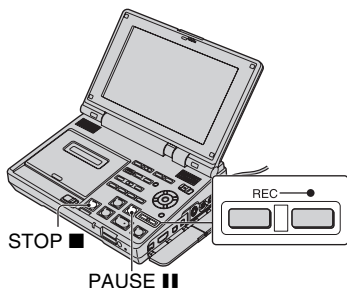

1 Prepare the VCR for recording.

Insert a cassette tape for recording. Set the POWER switch to ON.

2 When connecting with an i.LINK cable, set the input signal to the VCR (p. 56).

Normally set [HDV/DV SEL] to [AUTO] (the default setting).

3 Connect the VCR to the playback device or TV.

For details about connection, see page 29.

4 Prepare the playback device or TV.

Turn on the playback device or TV. When recording the picture from the other VCR, insert a cassette tape for playback.

When you connect to the TV, pictures from the TV is displayed on the screen of the VCR.

When you connect to devices with an i.LINK cable, the format of the input signal (**HDV IN i.LINK** or **DV IN i.LINK**) will be indicated on the screen of the VCR (this indicator may appear on the screen of the playback device, however, it will not be recorded).

5 Press two REC buttons simultaneously, then immediately press PAUSE **||** on the VCR.

The recording is paused.

6 When recording the picture from the other VCR, start playback.

The picture from the playback device is displayed on the screen of the VCR.

7 Press PAUSE **||** at the desired scene on the VCR, then start recording.

8 Press STOP **■** to finish recording on the VCR, and stop playback on the playback device.

Using the Remote Commander

In step 5, press two REC buttons simultaneously then immediately press PAUSE **||**. And in step 7, press **||** at the point where you want to start recording from.

ⓘ Notes

- You cannot record TV programs from the **i.LINK** HDV/DV (i.LINK) interface.
- You can record pictures from DV devices only in the DV format.

Recording the picture from TV, VCR, etc. (Continued)

- When you record the picture from a tape recorded in the HDV and DV formats by setting [HDV/DV SEL.] to [AUTO], the picture and sound are temporarily interrupted when the signal switches between the HDV and DV formats.
- To record the part recorded in the HDV format on the tape in the HDV and DV formats, set [HDV/DV SEL.] to [HDV] on the VCR. To record the part recorded in the DV format, set [HDV/DV SEL.] to [DV] on the VCR (p. 56). The rest of the parts recorded in the undefined format will remain unrecorded then.
- When you also use the another GV-HD700/1, GV-HD700E/1 for playback, set [HDV/DV SEL.] to [AUTO] on the GV-HD700/1, GV-HD700E/1 for playback as well.
- Note the following when connecting with an i.LINK cable:
 - During recording, the color of the display may look uneven. However, this does not affect the recorded picture.
 - The recorded picture becomes rough when a picture is paused on the devices for playback while recording to the VCR.
 - If you restart recording after pausing or stopping the VCR, the picture may not be recorded smoothly.
 - Data codes (date/time/camera settings data) may not be recorded depending on the connected device or application.
 - You cannot record the picture and sound separately.
- When recording is performed using the Remote Commander, the other VCR may malfunction. In this case, change the commander code to other than VTR2 on the other VCR or cover the sensor of the other VCR with black paper.
- If you use the fast forward or the slow playback function on the VCR when connecting with an A/V connecting cable with S VIDEO, the picture being recorded may fluctuate.

Locating a scene on the tape

You can locate a desired scene on the tape using the Remote Commander.

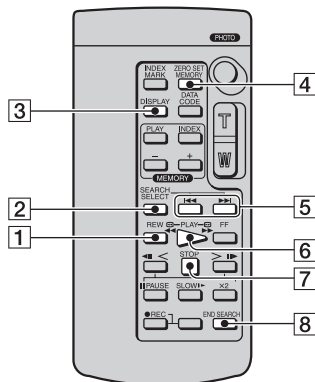

Notes

- For more details about the Remote Commander, see page 22, 93.

Locating a desired scene quickly (Zero set memory)

1 During playback, press ZERO SET MEMORY [4] at a point you want to locate later on.

The tape counter displays “0:00:00” and →0+ appears on the screen.

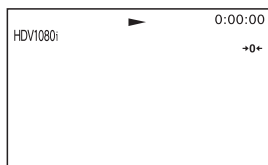

If the tape counter is not displayed, press DISPLAY [3].

2 Press STOP [7] when you want to stop playback.

3 Press REW ◀◀ [1].

The tape stops automatically when the tape counter reaches “0:00:00”.

The tape counter returns to the time code display, and →+ disappears.

4 Press PLAY [6].

Playback starts from the point designated “0:00:00” on the tape counter.

⚙ Notes

- There may be a discrepancy of several seconds between the time code and the tape counter.
- The zero set memory function will not work correctly when there is a blank section between recorded sections on the tape.
- During setting the zero set memory function, it is automatically canceled when you perform the following operations:
 - Pressing MEMORY PHOTO
 - Performing the end search
 - Performing the index search

💡 Tips

- When setting [ZEROMEMORY] to ASSIGN buttons (p. 36), you can use the zero set memory function on the VCR without using the Remote Commander.

To cancel the operation

Press ZERO SET MEMORY [4] again before rewinding.

Searching for the last scene of the most recent recording (End search)

Press END SEARCH [8].

The last scene of the most recent recording is played back for about 5 seconds.

⚙ Notes

- Once you eject the tape, the end search will not function.
- The end search function does not function correctly, if a blank section between recorded sections on the tape is detected.

💡 Tips

- When setting [END SEARCH] to ASSIGN buttons (p. 36), you can use the end search function on the VCR without using the Remote Commander.

Searching for a scene by date of recording (Date search)

You can locate the point where the recording date changes.

1 Press SEARCH SELECT [2] repeatedly to select [DATE SEARCH].

2 Press ◀◀ (previous)/▶▶ (next) [5] to select a recording date.

You can select the previous or the next date of the present point on the tape.

Playback starts automatically from the point where the date changes.

⚙ Notes

- The date search functions only with the tape recorded with date data.
- You need to record more than 2 minutes after the date is changed. The VCR may not accurately detect the point where the recording date changes.
- The date search function will not function correctly, if a blank section between recorded sections on the tape is detected.

Locating a scene on the tape (Continued)

Tips

- When setting [SEARCH SEL], [SEARCH I◀◀] and [SEARCH ▶▶] to ASSIGN buttons (p. 36), you can use the date search function on the VCR without using the Remote Commander.

To cancel the operation

Press STOP [7].

Searching for the point where the index signal is recorded (Index search)

You can locate the point where the index signal (p. 38) is recorded by the VCR or other devices.

1 Press SEARCH SELECT [2] repeatedly to select [INDEX SEARCH].

2 Press I◀◀ (previous)/▶▶I (next) [5] to select an index point.

You can select the previous or the next index signal of the present point on the tape.

Playback starts automatically from the point where the selected index signal is recorded.

Notes

- If an index recording is less than 2 minutes, the VCR may not accurately detect the index point.
- The index search function will not function correctly, if a blank section between recorded sections on the tape is detected.

Tips

- When setting [SEARCH SEL], [SEARCH I◀◀] and [SEARCH ▶▶] to ASSIGN buttons (p. 36), you can use the date search function on the VCR without using the Remote Commander.

To cancel the operation

Press STOP [7].

Changing/checking the settings in your VCR

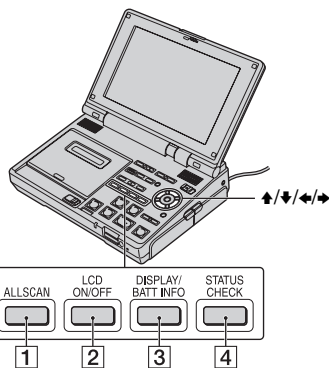

Turning off the LCD screen

You can turn off the LCD screen to make the battery last longer.

Press **LCD ON/OFF** [2].

To turn on the LCD screen, press **LCD ON/OFF** [2] again.

💡 Tips

- If you turn off the LCD screen during recording or playback, the recorded and original picture will not be affected.

Switching the information display on the screen

You can turn on and off the display of the time code and other information on the screen.

Press **DISPLAY/BATT INFO** [3].

The information display is switched on (display) → counter display → off (no display), each time you press **DISPLAY/BATT INFO** [3].

In the counter display, you can move the position where the counter is displayed using $\uparrow/\downarrow/\leftarrow/\rightarrow$.

💡 Tips

- You can display the information during playback on a TV. Set [DISP OUTPUT] to [V-OUT/PANEL] (p. 59).
- The time code is recorded for easy scene search on the tape. The VCR records the time code during recording.
- The time code starts counting from "0:00:00:00" at the beginning of the tape.
- When a blank section between recorded sections on the tape is detected, "--:--:--:--" is displayed at the blank section. The time code starts counting from "0:00:00:00" again after the blank section is detected.
- You cannot rewrite the time code later.
- The time code function of the VCR is a drop frame system. It may skip some frames to adjust the time code.

Displaying the settings in your VCR (Status check)

You can check the setup value of the following items.

- Audio setup (p. 61)
- Output signal setup ([HDV/DV SEL], etc.) (p. 56)
- Functions assigned to the ASSIGN buttons (p. 36)
- LCD SET (p. 58)

1 Press **STATUS CHECK** [4].

2 Select the desired item using \uparrow/\downarrow .

The item is displayed in the following order each time you press \uparrow/\downarrow :

AUDIO ↔ OUTPUT ↔ ASSIGN
↔ LCD SET

Changing/checking the settings in your VCR (Continued)

To turn off the setup value

Press STATUS CHECK [4] again.

Displaying all area surrounding the picture frame (All scan)

You can check all area surrounding the picture frame, which you cannot check on a TV screen.

Press ALLSCAN [1].

All the area surrounding the picture frame is displayed on the screen.

To return to the previous screen, press ALLSCAN [1] again.

Notes

- During the all scan display, a black frame appears around the screen.
- All scan display does not affect to the original picture.
- If ALLSCAN is displayed while inputting signals with HDV/DV jack or VIDEO IN/S VIDEO IN jack, fluctuation may appear around the picture frame. This is not malfunction, and there is no problem with pictures recorded on the tape.

Assigning the functions to the ASSIGN buttons

You may need to assign some functions to the ASSIGN buttons. You can assign a single function to each the ASSIGN button 1 to 3.

Functions you can assign to the ASSIGN buttons

- DV WIDE DISP (p. 59)
- PB ZOOM (p. 37)
- LCD PROFILE (p. 58)
- INDEX MARK (p. 38)
- ZEROMEMORY (p. 32)
- i.LINK CONV (p. 57)
- COMPONENT (p. 57)
- A/V→DV OUT (p. 43)
- END SEARCH (p. 33)
- DATA CODE (p. 60)
- COLOR BAR (p. 59)
- SEARCH SEL (p. 33, 34)
- SEARCH ►►► (p. 33, 34)
- SEARCH ◀◀◀ (p. 33, 34)

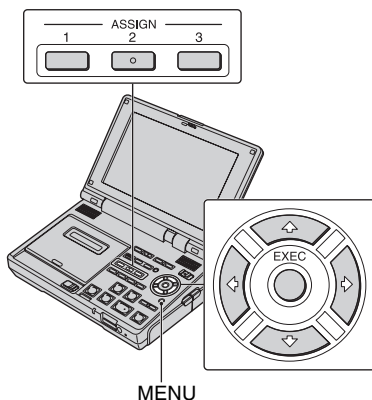

1 Press MENU.

2 Select  (OTHERS) using \uparrow/\downarrow , then press EXEC.

3 Select [ASSIGN BTN] using \uparrow/\downarrow , then press EXEC.

4 Select the number of the ASSIGN button (ASSIGN 1-3) you want to assign the function using \uparrow/\downarrow , then press EXEC.

[-----] is displayed at the number that no function is assigned.

5 Select the function to be assigned using \uparrow/\downarrow , then press EXEC.

6 Select [OK] using \uparrow/\downarrow , then press EXEC.

7 Press MENU to hide the menu screen.

Using PB zoom

You can magnify movies from about 1.1 to 5 times the original size, or still images from about 1.5 to 5 times.

1 Assign [PB ZOOM] to one of the ASSIGN buttons in advance (p. 36).

2 Press the ASSIGN button assigned to [PB ZOOM].

The center of the picture is magnified.

3 Adjust the magnification using \downarrow (Wide angle)/ \uparrow (Telephoto).



4 Press EXEC, then move the zoom frame using $\uparrow/\downarrow/\leftarrow/\rightarrow$.

By pressing EXEC again, the zoom frame is fixed, and you can adjust the magnification using \uparrow/\downarrow .

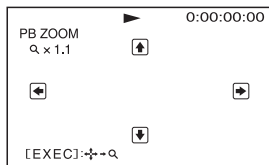

Notes

- You cannot magnify pictures that are input externally.
- Magnified picture cannot be output via the  HDV/DV (i.LINK) interface when you playback the picture recorded in the HDV/DV format.
- During magnifying a movie, the PB zoom function is automatically canceled when you press MENU.

Assigning the functions to the ASSIGN buttons (Continued)

- During magnifying a still image, the PB zoom function is automatically canceled when you press the following buttons:
 - MENU
 - MEMORY PLAY
 - MEMORY INDEX
 - VOLUME/MEMORY (-/+)

Tips

- You can also magnify a picture with the zoom button W (Wide angle)/T (Telephoto) on the Remote Commander.
- You can switch the display of the time code, arrows, etc. on or off when you press DISPLAY/BATT INFO during the PB zoom.
- You cannot capture still images to a “Memory Stick Duo” media from a picture while using [PB ZOOM] (p. 45).

To cancel the operation

Either press the ASSIGN button assigned to [PB ZOOM], or stop playback.

Recording an index signal

If you make an index for a scene, you can easily search for the scene later (p. 34). The index function allows you to easily check the transition of recording or edit your pictures using index signals.

1 Assign [INDEX MARK] to one of the ASSIGN buttons in advance (p. 36).

2 Press the ASSIGN button assigned to [INDEX MARK].

When pressed during recording

 appears for about 7 seconds and an index signal is recorded.

When pressed before recording

 flashes.

When recording starts,  appears for about 7 seconds and an index signal is recorded.

To cancel the operation before recording

During  flashing, press the ASSIGN button assigned to [INDEX MARK] again.

Notes

- You cannot record an index signal on a recorded tape afterward.

Dubbing to VCR, DVD/HDD recorder, etc.

Connect your VCR to the wall outlet (wall socket) using the supplied AC Adaptor for this operation (p. 13). Refer also to the instruction manual supplied with the devices to be connected.

Connecting to external devices

The connection method and the image quality will differ depending on the VCR, DVD/HDD recorder and the connectors used.

Jacks on the VCR

Open the jack cover and connect the cable.

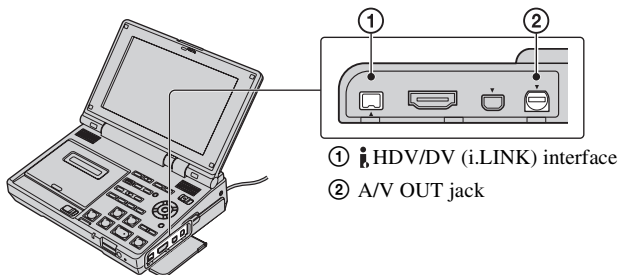

Notes

- You cannot dub pictures using the HDMI cable.

Using an i.LINK cable (optional)

↗ : Signal flow

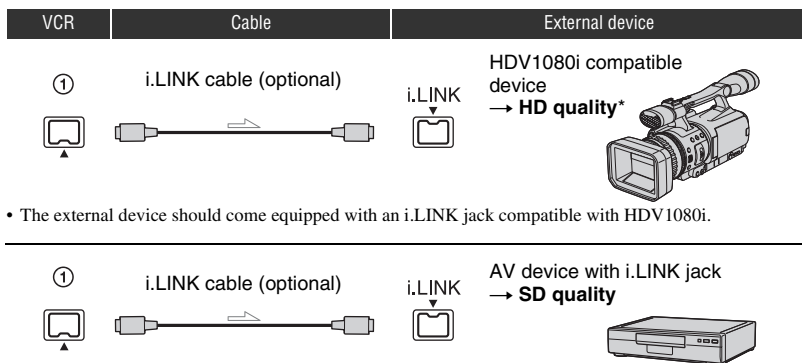

* Pictures recorded in the DV format are dubbed in the SD (standard definition) quality, regardless of the connection.

Recording format

The dubbed format (HDV/DV) differs depending on the recorded picture or the format supported by the VCR, DVD/HDD recorder. See the table below for selecting the appropriate settings, and perform necessary menu setting.

Copy format	Playback picture format	Format supported by the external device		Menu setting	
		HDV format* ¹	DV format	[HDV/DV SEL] (p. 56)	[i.LINK CONV] (p. 57)
Copy HDV recording as HDV	HDV	HDV	—* ³		[OFF]
Convert HDV recording to DV	HDV	DV	DV	[AUTO]	[ON]
Copy DV recording as DV	DV	DV	DV		[OFF]
When tape is recorded in both HDV and DV formats					
Convert both HDV and DV format to DV	HDV/DV	DV	DV	[AUTO]	[ON]
Copy only portions recorded in HDV format	HDV	HDV	—* ³	[HDV]	[OFF]
	DV	—* ²	—* ³		
Copy only portions recorded in DV format	HDV	—* ²	—* ²	[DV]	[OFF]
	DV	DV	DV		

*¹ Recording device compliant with the HDV1080i specification.

*² The tape advances, but no video or sound is recorded (blank).

*³ Picture is not recognized (no recording is made).

Notes

- When you play back a tape recorded in the HDV and DV formats by setting [HDV/DV SEL] to [AUTO], the picture and sound are temporarily interrupted when the signal switches between the HDV and DV formats.
- Disconnect the i.LINK cable before changing [HDV/DV SEL] and [i.LINK CONV] settings. Otherwise, the VCR, DVD/HDD recorder may not be able to recognize the video signal from the VCR.
- This VCR has a 4-pin i.LINK terminal. Select a cable that fits the terminal on the device to be connected.

Tips

- When you use an i.LINK cable, the video and sound signals are transmitted digitally, producing high quality pictures.

Using an A/V connecting cable with S VIDEO or an A/V connecting cable

↗ : Signal flow

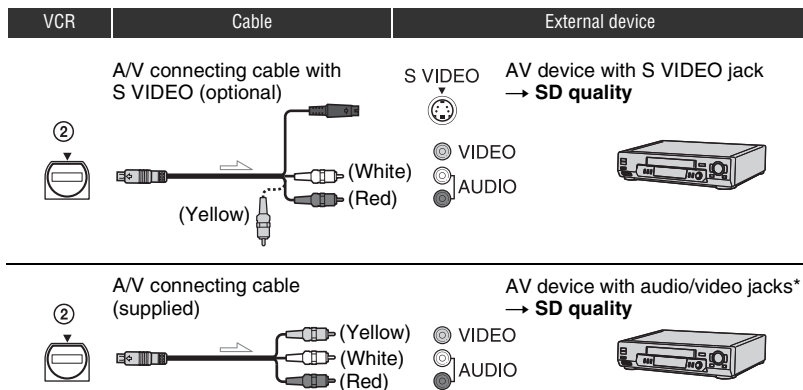

* When connecting the VCR to a monaural device, connect the yellow plug of the A/V connecting cable to the video jack on the device, then connect the white (left channel) or red (right channel) plug to the audio jack on the device.

Notes

- Set [DISP OUTPUT] to [LCD PANEL] (the default setting) when connecting with an A/V connecting cable (p. 59).
- When connecting with an A/V connecting cable, set [TV TYPE] (p. 57) according to the display device to play back recorded picture.
- To record the picture displaying the date/time data on the screen when connected with an A/V connecting cable, set [DISP OUTPUT] to [V-OUT/PANEL] (p. 59).

Tips

- When you connect the VCR to the other VCR or DVD/HDD recorder via the S VIDEO jack by using an A/V connecting cable with S VIDEO (optional), higher quality DV format pictures can be produced than when using an A/V connecting cable. When you make an S VIDEO connection only, audio will not be output.

Dubbing to another device

1 Prepare the VCR for playback.

Insert a recorded tape for playback. Set the POWER switch to ON.

2 Connect the VCR to the recording device.

For details about connection, see page 39.

3 Prepare the recording device.

Turn on the recording device. When dubbing the picture to the other VCR, insert a cassette tape for recording. When dubbing the picture to the DVD recorder, insert a DVD for recording.

If your recording device has an input selector, set it to the appropriate input (such as video input1 and video input2).

4 Start playback on the VCR, and recording on the recording device.

When you connect to devices with an i.LINK cable, the format of the output signal (HDVout **i.LINK** or DVout **i.LINK**) will be indicated on the screen of the VCR.

Refer to the instruction manual supplied with your recording device for details.

5 Stop recording on the recording device, and press STOP ■ to finish playback on the VCR.

ⓘ Notes

- Pictures recorded in the HDV format are not output from the **i.LINK** HDV/DV (i.LINK) interface during playback pause or in any playback mode other than normal playback.
- Note the following when connecting with an i.LINK cable:
 - The recorded picture becomes rough when a picture is paused on the VCR while recording to a VCR, DVD/HDD recorder.
 - If you connect the VCR to the HDV1080i compatible device and restart recording after pausing or stopping, the picture may not be recorded smoothly.
 - You cannot record any information display such as time code, or titles that are recorded on other device.
 - Data codes (date/time/camera settings data) may not be displayed or recorded depending on the device or application.
 - You cannot record the picture and sound separately.
- When dubbing to a DVD/HDD recorder from the VCR via an i.LINK cable, you may not operate the VCR on your DVD/HDD recorder even you were instructed by the operation manual. If you can set the input mode to HDV or DV on your DVD/HDD recorder and can input/output pictures, follow the steps in “Dubbing to another device.”

Using with an analog video unit and your computer (Signal convert function) DV

You can capture pictures from an analog video unit connected to your computer which has the i.LINK (DV) jack via your VCR.

Connect the VCR to the wall outlet (wall socket) using the supplied AC Adaptor for this operation (p. 13). You need to install software to capture video signals on your computer, if necessary. Refer to the instruction manual of your computer and software.

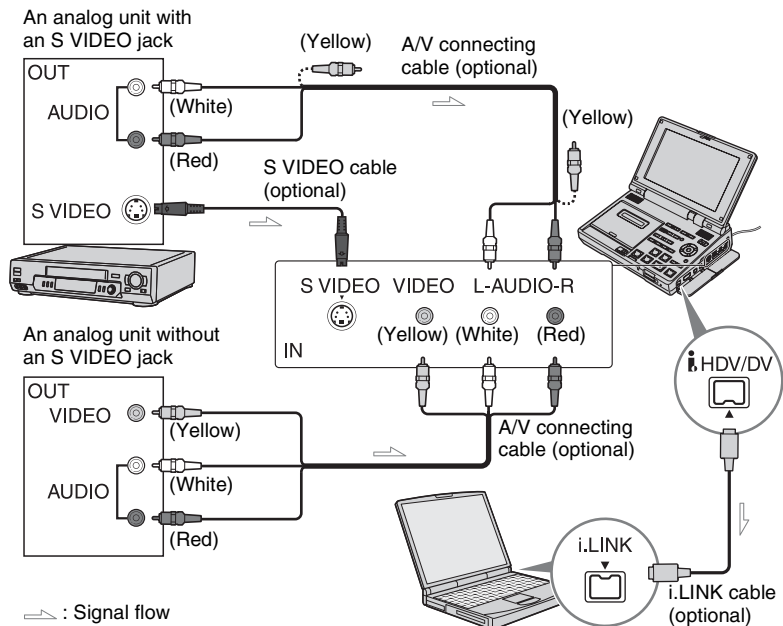

1 Connect the VCR to an analog video unit and your computer.

2 Set the POWER switch to ON.

3 Press MENU.

The menu screen appears.

4 Select \leftrightarrow (IN/OUT REC) using \uparrow/\downarrow , then press EXEC.

5 Set [A/V→DV OUT] to [ON].
A/V→DV appears on the screen.

6 Start playback on the analog video unit.

7 Start capturing procedures on your computer.

The operation procedures depend on your computer and the software you use. For details on how to capture pictures, refer to the instruction manual of your computer and software.

8 Stop capturing procedures on your computer, and stop the playback on the analog video unit.

Notes

- Depending on the condition of the analog video signals, the computer may not import images correctly when you convert analog video signals into digital video signals via the VCR.
- You cannot record or capture video output via the VCR when the video includes copyright protection signals such as the ID-2 system (GV-HD700/1 only).
- You cannot record or capture video output via the VCR when the video includes copyright protection signals (GV-HD700E/1 only).
- If ALLSCAN is displayed while inputting signals with VIDEO IN/S VIDEO IN jack, fluctuation may appear around the picture frame. This is not malfunction, and there is no problem with outputting pictures from HDV/DV jack.

Tips

- When you connect the VCR to an external device via the S VIDEO jack by using an S VIDEO cable (optional), higher quality DV format pictures can be produced than when using an A/V connecting cable. When you connect with an S VIDEO cable (optional) alone, audio will not be output.

Capturing a still image to a "Memory Stick Duo" media from a picture recorded on a tape

You can capture a still image to a "Memory Stick Duo" media from a picture recorded on a tape. Make sure to insert a recorded tape and a "Memory Stick Duo" media in your VCR.

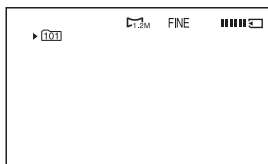
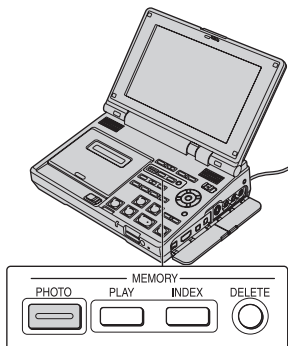

Recording is complete when the bar scroll indicator disappears.

1 Set the **POWER** switch to **ON**.

2 Press **PLAY** ►.

Playback starts.

3 Press **MEMORY PHOTO**.

[CAPTURE] appears on the screen. The picture displayed on the screen will be recorded on a "Memory Stick Duo" media as a still image.

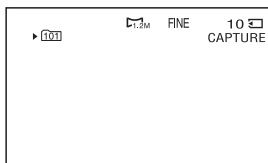

Notes

- The recording date and time of the picture and the capturing date and time of the still image to the "Memory Stick Duo" media will be recorded. On the VCR, the date and time of the picture recorded on the tape will be displayed. Camera setting data recorded on the tape cannot be stored on the "Memory Stick Duo" media.
- The image size is fixed depending on the format or the aspect ratio of movies as follows:
 - When capturing from a movie in the HDV format: 1.2M
 - When capturing from a movie in the DV format (16:9): 0.2M
 - When capturing from a movie in the DV format (4:3): VGA (0.3M)
- You cannot capture a still image from a picture while using [PB ZOOM] (p. 37).

To capture a still image from the TV, VCR or DVD/HDD device, etc.

- ① Insert a "Memory Stick Duo" media to record.
- ② Perform steps **3** and **4** in "Recording the picture on your VCR" (p. 31).
- ③ Start playback on the connected device.
- ④ Press **MEMORY PHOTO** at the scene you want to record as a still image.

Notes

- Depending on the connected device, still images captured on the VCR may be recorded with the edges masked in black.

Viewing a still image on a “Memory Stick Duo” media (Memory photo playback)

You can play back still images recorded on a “Memory Stick Duo” media. Insert a “Memory Stick Duo” media into your VCR before this operation.

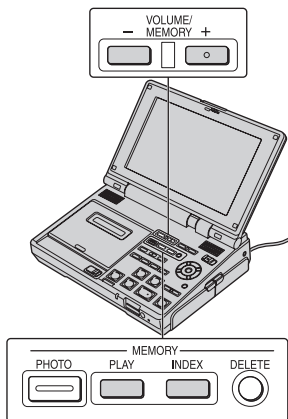

1 Set the POWER switch to ON.

2 Press MEMORY PLAY.

The last recorded image is displayed.

3 Select a still image with VOLUME/MEMORY (-/+).

To see the previous image, press VOLUME/MEMORY (-).

To see the next image, press VOLUME/MEMORY (+).

To stop playback

Press MEMORY PLAY again.

Notes

- You may not play back image data modified on a computer. Also, you may not play back image data recorded with other devices.

- Only the file name but not the directory name may be displayed, if the structure of the directory does not conform to the DCF standard.

Tips

- You can magnify still images. See page 37 for details.
- When connecting the VCR to the TV, you can playback still images on the TV (p. 24).

Playing back six recorded images at a time (Index screen)

You can play back six recorded images at a time. This function is especially useful when searching for a particular image.

1 Set the POWER switch to ON.

2 Press MEMORY INDEX.

A red ► mark appears above the image that is displayed before changing to the index screen mode.

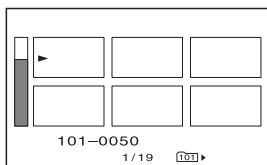

You can move ► mark using VOLUME/MEMORY (-/+).

To display the previous six images, move ► mark to the upper left image, then press VOLUME/MEMORY (-).

To display the next six images, move ► mark to the lower right image, then press VOLUME/MEMORY (+).

Notes

- When the index screen is displayed, a number appears above each image. This indicates the order in which images are recorded on the “Memory Stick Duo” media. These numbers are different from the data file names (p. 49).
- You may not display image data on the index screen modified on a computer, or image data recorded with other device.

To display a single image

Move ► to that image using VOLUME/MEMORY (–/+) and press MEMORY PLAY.

To stop displaying the index screen

Press MEMORY INDEX again.

Copying still images on the “Memory Stick Duo” media to a computer USB

You can copy still images on the “Memory Stick Duo” media to a connected computer.

System requirements

For Windows users

- OS: Windows 2000 Professional/Windows XP Home Edition/Windows XP Professional/Windows Vista*

* 64-bit editions and Starter (Edition) are not supported.

Standard installation is required. Operation is not assured if the above OS has been upgraded.

- CPU: MMX Pentium 200MHz or faster
- Others: USB port (provided as standard).

For Macintosh users

- OS: Mac OS 9.1/9.2 or Mac OS X (v10.1/v10.2/v10.3/v10.4)
- Others: USB port (provided as standard).

Tips

- You can do this operation with the standard driver on your computer. You do not need to install any software.
- If your computer has a “Memory Stick” media slot, insert the “Memory Stick Duo” media on which pictures are recorded into the “Memory Stick Duo” media adaptor (optional), then insert it into the “Memory Stick” media slot on your computer to copy still images to the computer.
- When using a “Memory Stick PRO Duo” media and your computer is not compatible with it, connect the VCR with the USB cable instead of using the “Memory Stick” media slot on the computer.

Copying still images on the “Memory Stick Duo” media to a computer (Continued)

Step:1 Using the USB cable

1 Turn on the computer.

Close down all applications running on the computer.

**For Windows 2000/Windows XP/
Windows Vista**

Log on as an Administrator.

2 Insert the “Memory Stick Duo” media into the VCR.

3 Connect the VCR to the wall outlet (wall socket) using the supplied AC Adaptor (p. 13).

4 Set the POWER switch to ON.

5 Press MENU.

The menu screen appears.

6 Select (OTHERS) → [USB SELECT] → Memory Stick (p. 65).

7 Connect the USB cable to the USB jacks on the VCR and your computer.

It may take a while until your computer recognizes the VCR for the first time.

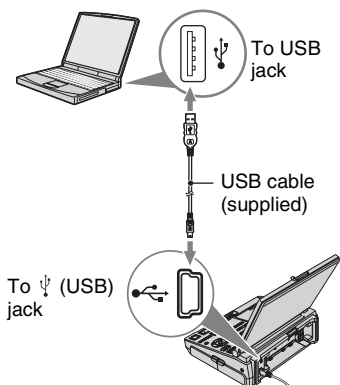

⚠ Notes

- When using a USB cable to connect the VCR to a computer, make sure to connect the jack in the correct direction. If you insert the jack forcibly, it may be damaged, and cause a malfunction of the VCR.
- The computer may not recognize the VCR if you connect them with the USB cable before turning on the VCR.

Recommended connection

Check the following to ensure the VCR is operated correctly to establish connection.

- Connect the VCR to a computer via the USB cable. Make sure no other USB devices are connected to the computer.
- If your computer has a USB keyboard and a USB mouse as standard equipment, leave them connected and connect the VCR to an available USB jack with the USB cable.
- Operation is not guaranteed if you connect two or more USB devices to the computer.

- Operation is not guaranteed if you connect the USB cable to the USB jack on a keyboard or USB hub.
- Make sure to connect the cable to the USB jack on the computer.
- Operation is not guaranteed even for the recommended environments.

Step:2 Copying still images

For Windows users

Double-click the [Removable Disk] icon displayed in [My Computer]. Then, drag and drop a picture in the folder onto the hard disk drive of your computer.

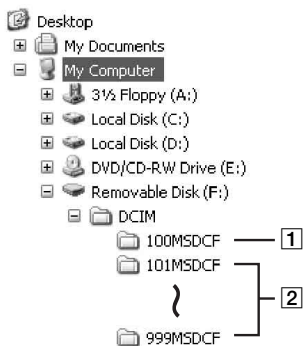

- 1 Folder containing image files recorded by other VCRs without the folder creation function (for playback only).
- 2 Folder containing image files recorded by the VCR when no new folders have been created, only [101MSDCF] is displayed.

Folder	File	Meaning
101MSDCF (up to 999MSDCF)	DSC0□□□ □□.JPG	Still image file

□□□□ are numbers between 0001 and 9999.

For Macintosh users

Double-click the drive icon, then drag and drop the desired picture file onto the hard disk of your computer.

Notes

- "Memory Stick Duo" media operations on the VCR cannot be assured if a "Memory Stick Duo" media formatted on your computer is used on the VCR, or if the "Memory Stick Duo" media in the VCR was formatted from your computer when the USB cable was connected.
- Do not compress the data on the "Memory Stick Duo" media. Compressed files cannot be played back on the VCR.
- When you load an image modified using retouching software from your computer to the VCR or when you directly modify the image on the VCR, the image format will differ. A file error indicator may appear and you may not open the file.
- Communications between the VCR and your computer may not recover after recovering from Suspend, Resume, or Sleep.

Disconnecting the USB cable

For Windows users

If [USB CONNECTING] appears on the LCD screen, follow the procedure below to disconnect the USB cable.

- 1 Click the [Unplug or eject hardware] icon on the task tray.

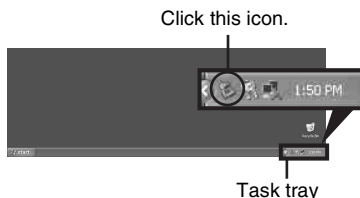

- 2 Click [Safely remove USB Mass Storage Device-Drive].



Copying still images on the “Memory Stick Duo” media to a computer (Continued)

- Click [OK].
- Disconnect the USB cable from the VCR and computer.

If [USB CONNECTING] does not appear on the LCD screen, do only step ④.

For Macintosh users

- Close down all applications running on the computer.
- Drag and drop the drive icon on the desktop onto the [Trash] icon.
- Disconnect the USB cable from the VCR and computer.

Notes

- Disconnect the USB cable according to the correct procedure, otherwise files in the “Memory Stick Duo” media may not be updated correctly. Also, this may cause a malfunction of the “Memory Stick Duo” media.
- Do not disconnect the USB cable while the access lamp is lit.
- Make sure to disconnect the USB cable before turning off the VCR.
- If you are using Mac OS X, turn off the computer before disconnecting the USB cable and ejecting the “Memory Stick Duo” media.

Deleting recorded still images from the “Memory Stick Duo” media

You can delete still images recorded on a “Memory Stick Duo” media using your VCR. Insert a “Memory Stick Duo” media into your VCR before this operation (p. 20).

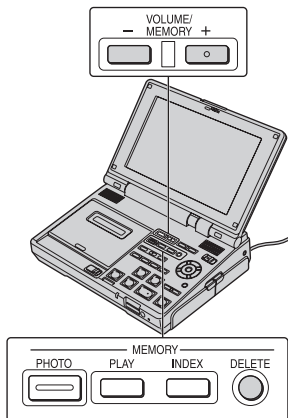

1 Set the POWER switch to ON.

2 Playback a still image you want to delete (p. 46).

3 Press MEMORY DELETE.

[Delete this image?] will be displayed.

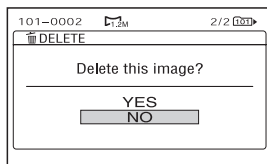

4 Select [YES] using \uparrow/\downarrow , then press EXEC.

The still image is deleted.

Notes

- Still images cannot be restored once they are deleted.
- Still images cannot be deleted when a “Memory Stick Duo” media with the write-protect tab is set to the write-protect position (p. 80), or when the selected picture is protected.

Tips

- To delete images from the index screen, press VOLUME/MEMORY (-/+) to move the \blacktriangleright mark to the image you want to delete and perform steps 3 and 4.
- To delete all still images from the “Memory Stick Duo” media or in the selected folder at once, perform [\square] ALL ERASE] (p. 62).

Printing recorded images (PictBridge compliant printer) [USB]

You can print out pictures using a PictBridge compliant printer without connecting the VCR to a computer.

PictBridge

Connect the VCR to the wall outlet (wall socket) using the supplied AC Adaptor (p. 13).

Insert the “Memory Stick Duo” media, containing still images into the VCR and turn on the printer.

Connecting your VCR to the printer

1 Set the POWER switch to ON.

2 Press MENU.

The menu screen appears.

3 Select (OTHERS) \rightarrow [USB SELECT] \rightarrow [PictBridge PRINT] (p. 65).

4 Connect the USB cable to the USB jacks of the VCR and the printer.

Printing recorded images (PictBridge compliant printer) (Continued)

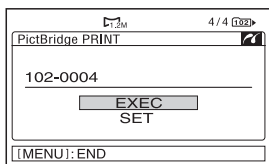
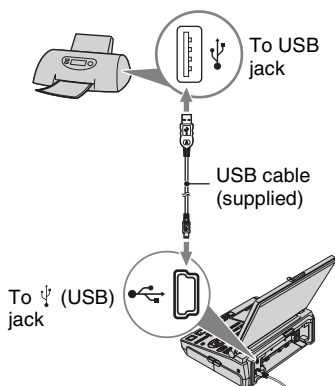

One of the images stored on the “Memory Stick Duo” media will be displayed.

Printing

1 Select the image you want to print using VOLUME/MEMORY (-/+).

2 Set the number of copies you want to print if necessary.

If you do not want to set the number, go to step **3** (the number will be automatically set to 1).

① Select [SET] → [COPIES], then press EXEC.

② Select the number using ▲/▼, then press EXEC.

You can set the number up to 20.

③ Select [↵ RETURN], then press EXEC.

3 Set the printing date/time on the image if necessary.

If you do not want to print the date/time, go to step **4**.

① Select [SET] → [DATE/TIME] → [DATE] or [DAY & TIME], then press EXEC.

② Select [↵ RETURN], then press EXEC.

4 Select [EXEC] → [YES], then press EXEC.

When printing is finished, [Printing...] disappears and the image selection screen appears again.

Press MENU when printing is completed.

Notes

- We can guarantee the operation of only models that are PictBridge compatible.
- Refer also to the operating instructions for the printer to be used.
- Do not attempt the following operations when the printer is connected (☑ is on the screen). The operations may not be performed properly.
 - Set the POWER switch to OFF (CHG).
 - Disconnect the USB cable from the VCR or the printer.
 - Eject the “Memory Stick Duo” media from the VCR.
- If the printer stops working, disconnect the USB cable, turn the printer off and on again and restart the operation from the beginning.

- On some printer models, the top, bottom, right, and left edges of images may be trimmed. If you print a still image recorded in a 16:9 (wide) ratio, the left and right ends of the image may be trimmed widely.
- Some printer models may not support the date/time printing function. Refer to your printer's operating instructions for details.
- We cannot guarantee the printing of images recorded with a device other than the VCR.

Tips

- PictBridge is an industry standard established by the Camera & Imaging Products Association (CIPA). You can print still images without using a computer by connecting a printer directly to a digital video camera or digital still camera, regardless of model or manufacturer.

Using the menu items

You can change various settings or make detailed adjustments using the menu items displayed on the screen.

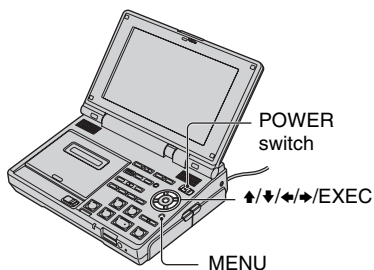

1 Set the POWER switch to ON.

2 Press MENU to display the menu screen.

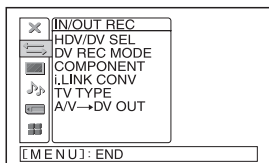

3 Select the icon of the desired menu using ▲/▼, then press EXEC.

- IN/OUT REC (p. 56)
- DISPLAY SET (p. 58)
- AUDIO SET (p. 61)
- MEMORY SET (p. 62)
- OTHERS (p. 64)

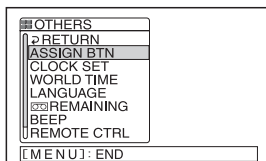

4 Select the desired item using ▲/▼, then press EXEC.

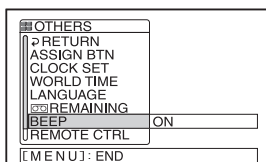

Unavailable items will be grayed out.

You can also determine the desired items by pressing ▲.

To return to the previous screen, select [RETURN] or press ◀.

5 Select the desired setting using ▲/▼, then press EXEC.

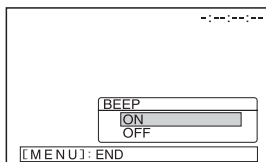



6 Press MENU to hide the menu screen.

List of the menu items



(IN/OUT REC) menu (p. 56)

Items	Page
HDV/DV SEL	56
DV REC MODE 	56
COMPONENT	57
i.LINK CONV	57
TV TYPE	57
A/V→DV OUT	43



(DISPLAY SET) menu (p. 58)

Items	Page
LCD SET	58
DV WIDE DISP 	59
DISP OUTPUT	59
COLOR BAR	59
DV BARS 	60
DATA CODE	60

(AUDIO SET) menu (p. 61)

Items	Page
DV AU.MODE 	61
MULTI-SOUND	61
DV AUDIO MIX 	61

(MEMORY SET) menu (p. 62)

Items	Page
 QUALITY	62
 ALL ERASE	62
 FORMAT	63
FILE NO.	63
NEW FOLDER	63
REC FOLDER	63
PB FOLDER	63

(OTHERS) menu (p. 64)

Items	Page
ASSIGN BTN	36
CLOCK SET	18
WORLD TIME	64
LANGUAGE	64
 REMAINING	64
BEEP	64
REMOTE CTRL	64
USB SELECT	65

⇔ (IN/OUT REC)

menu

Recording settings, input and output settings (HDV/DV SEL/DV REC MODE/TV TYPE, etc.)

The default settings are marked with ►. The indicators in parentheses appear when the items are selected.

See page 54 for details on selecting menu items.

Press MENU → select ⇔ (IN/OUT REC) using ▲/▼ → press EXEC.

HDV/DV SEL

You can select the playback signal. Normally set to [AUTO].

When the VCR is connected to another device using an i.LINK cable, select the signal to input/output from the  HDV/DV (i.LINK) interface. The selected signal is recorded or played back.

► AUTO

Switches the signals between the HDV and DV formats automatically when playing back a tape.

During i.LINK connection, switches the signals between the HDV and DV formats automatically, and inputs/outputs from the  HDV/DV (i.LINK) interface.

HDV (HDV1080i)

Plays back only the portions recorded in the HDV format.

During i.LINK connection, inputs/outputs only the HDV formatted signals from the  HDV/DV (i.LINK) interface. You can also select this when connecting the VCR to a computer, etc.

DV (DV)

Plays back only the portions recorded in the DV format.

During i.LINK connection, inputs/outputs only the DV formatted signals from the  HDV/DV (i.LINK) interface. You can also select this when connecting the VCR to a computer, etc.

⚙ Notes

- Disconnect the i.LINK cable before changing [HDV/DV SEL] setting. Otherwise, the connected video device may not be able to recognize the video signal from the VCR.
- When [AUTO] is selected and the signal switches between the HDV and DV formats, the picture and sound are interrupted temporarily.
- When [i.LINK CONV] is set to [ON], pictures are output as follows:
 - Setting to [AUTO], an HDV signal is converted to the DV format and output; a DV signal is output as it is.
 - Setting to [HDV], an HDV signal is converted to the DV format and output; a DV signal is not output.
 - Setting to [DV], a DV signal is output as it is; an HDV signal is not output.

DV REC MODE (DV Recording mode) DV

When recording a picture in the DV format, you can set the DV recording mode.

► SP (SP)

Records in the SP (Standard Play) mode on a cassette.

LP (LP)

Increases the recording time to 1.5 times the SP mode (Long Play).

⚙ Notes

- If you record in the LP mode, a mosaic-like noise may appear or sound may be interrupted when you play back the tape on other VCRs or camcorders.
- When you mix recordings in the SP mode and in the LP mode on one tape, the playback picture may be distorted or the time code may not be written properly between the scenes.

COMPONENT

You can select the type of connection when connecting the VCR to a TV with the component input jack.

GV-HD700/1:

480i

Select when connecting the VCR to a TV with the component input jack.

▶ 1080i/480i

Select when connecting the VCR to a TV that has the component input jack and is capable of displaying the 1080i signal.

GV-HD700E/1:

576i

Select when connecting the VCR to a TV with the component input jack.

▶ 1080i/576i

Select when connecting the VCR to a TV that has the component input jack and is capable of displaying the 1080i signal.

i.LINK CONV

You can convert signals in the HDV format to the DV format, and output pictures in the DV format from the  HDV/DV (i.LINK) interface.

▶ OFF

Outputs the pictures from the  HDV/DV (i.LINK) interface in accordance with the setting in [HDV/DV SEL].

ON

Pictures in the HDV format are converted to the DV format, and pictures in the DV format are output in the DV format.

Notes

- For input signal via an i.LINK connection, see [HDV/DV SEL] (p. 56).

- Disconnect the i.LINK cable before setting [i.LINK CONV]. Otherwise, the connected video device may not be able to recognize the video signal from the VCR.

TV TYPE

You need to convert the signal depending on the TV connected when playing back the picture. The recorded pictures output from the VCR are played back as follows.

▶ 16:9

Select to view pictures on a 16:9 (wide) TV.

HDV/DV (16:9) format pictures



DV (4:3) format pictures



4:3

Select to view pictures on a 4:3 standard TV.

HDV/DV (16:9) format pictures



DV (4:3) format pictures



Notes

- This is not effective when pictures are output from the  HDV/DV (i.LINK) interface.
- When you connect the VCR to a TV compatible with the ID-1 system for playing back the tape, set [TV TYPE] to [16:9]. The TV automatically switches the aspect ratio according to the playback picture. Refer also to the manual supplied with your TV (GV-HD700/1).
- The aspect ratio of color bars in the DV format is set to the setting of [DV BARS] (p. 60), regardless of the setting of [TV TYPE].

A/V → DV OUT

See page 43.

(DISPLAY SET) menu

Display settings of the LCD screen (LCD SET/COLOR BAR/DATA CODE, etc.)

The default settings are marked with ►.
The indicators in parentheses appear when the items are selected.

See page 54 for details on selecting menu items.

Press MENU → select  (DISPLAY SET) using ▲/▼ → press EXEC.

LCD SET

You can select the desired LCD panel setups. The recorded picture will not be affected.

BRIGHTNESS

You can adjust the LCD bright using ◀/▶.

Tips

- You can also turn off the LCD screen (p. 35).
- You can also adjust the LCD brightness using the LCD BRIGHT buttons (-/+) (p. 21).

CONTRAST

You can adjust the LCD contrast using ◀/▶.

COLOR LEVEL

You can adjust the LCD color intensity using ◀/▶.

COLOR PHASE

You can adjust the desired hue of the LCD panel using ◀/▶.

SHARPNESS

You can adjust the sharpness of the image outline using ◀/▶.

LCD PROFILE

You can save up to six kinds of LCD panel setups in the VCR as LCD profiles. Using these saved profiles lets you quickly obtain suitable LCD panel settings later.

LOAD

You can load the LCD profile settings and use the VCR with the settings.

- ① Select [LOAD].

- ② Select the LCD profile which you want to load.
- ③ Select [YES] in the check screen.
The selected LCD profile becomes effective.

SAVE

You can save the current LCD panel setups as a new LCD profile settings.

- ① Select [SAVE].
- ② Select [NEW FILE] or an existing profile name.
- ③ Select [YES] in the check screen.
The LCD profile settings are saved.

- If you select [NEW FILE], profile name is set to [LCD1]-[LCD6].
- If you select an existing LCD profile as a destination, the LCD profile is overwritten.

PROFILE NAME

You can change the LCD profile name.

- ① Select [PROFILE NAME].
- ② Select the LCD profile that you want to change the name.
The profile name screen appears.

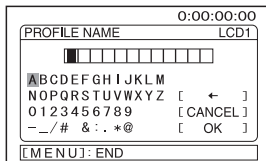

- ③ Select a letter using ▲/▼/◀/▶, then press EXEC.
Repeat this operation until a complete name is entered.
- Each name can be up to 12 characters long.
 - Characters that can be used in profile names:
 - A-Z
 - 0-9
 - -_/# & : . * @
- ④ Select [OK], then press EXEC.
The profile name is changed.

DELETE

You can delete the panel profile settings.

- ① Select [DELETE].
- ② Select the panel profile you want to delete.
- ③ Select [YES] in the check screen.
The panel profile settings are deleted.

RESET

You can restore the default settings for [LCD SET].

- ① Select [RESET].
 - ② Select [YES] in the check screen.
The LCD panel setups are restored to the default settings.
- LCD profiles stored on the VCR are retained even when the [RESET] operation is performed.

Tips

- The items that can be saved in the LCD profile are set values of [BRIGHTNESS], [CONTRAST], [COLOR LEVEL], [COLOR PHASE], and [SHARPNESS]. You can save these set values all in the LCD profile.
- When you move the cursor on the LCD profile stored on the VCR while selecting [LOAD], [PROFILE NAME], or [DELETE], the settings of the LCD profile will be effective on the screen.
- When you move the cursor on the LCD profile stored on the VCR and press \blacktriangleright , the settings of the LCD profile will be displayed on the screen.

DV WIDE DISP DV

You can select the desired aspect ratio of the DV format picture displayed on the screen.

▶ AUTO

Switches the aspect ratio automatically.

WIDE ($\leftarrow \rightarrow$)

Sets the aspect ratio to 16:9.

4:3 ($\rightarrow \leftarrow$)

Sets the aspect ratio to 4:3.

Notes

- You cannot change the aspect ratio of the HDV format picture and the still image displayed on the screen.
- When setting [DV WIDE DISP] to [WIDE] or [4:3] while displaying the color bar, the aspect ratio of the picture will not change even if $\leftarrow \rightarrow$ or $\rightarrow \leftarrow$ appears.
- When capturing a still image to “Memory Stick Duo” media from a movie, the DV wide display function does not work for the recorded still image. The aspect ratio of the recorded still image may differ from the image actually displaying on the screen.
- The DV wide display function does not work for output signals from the VCR.
- You cannot change the current setting while displaying the color bar.

DISP OUTPUT

▶ LCD PANEL

Shows displays such as the time code on the LCD screen.

V-OUT/PANEL

Shows displays such as the time code on the TV screen and the LCD screen.

COLOR BAR

You can display the color bar or record it on the tape by setting to [ON]. It is convenient to adjust the color on the monitor connected (the default setting is [OFF]).

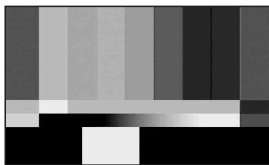

Notes

- This is automatically set to [OFF] when you turn on the VCR at the next time or press REW $\leftarrow \leftarrow$ /PLAY $\blacktriangleright \blacktriangleright$ /FF $\blacktriangleright \blacktriangleright$.

Press MENU → select  (DISPLAY SET) using  → press EXEC.

DV BARS

You can select the aspect ratio of color bars in the DV format.

▶ 16:9

Sets the aspect ratio of color bars to 16:9.

4:3

Sets the aspect ratio of color bars to 4:3.

Notes

- You cannot change the current setting during recording.

DATA CODE

During playback, you can display the information (data code) recorded automatically at the time of recording.

▶ OFF

Data code is not displayed.

DATE

Displays the date and time.

Notes

- In the DATE display, [-- -- ----] and [--:--:--] is displayed if you record a picture without setting the clock.

🎵 (AUDIO SET) menu

Settings for the audio recording (DV AU.MODE/DV AUDIO MIX, etc.)

The default settings are marked with ▶. The indicators in parentheses appear when the items are selected.

See page 54 for details on selecting menu items.

Press MENU → select 🎵 (AUDIO SET) using ▲/▼ → press EXEC.

DV AU.MODE (DV Audio mode) DV

▶ 12BIT

Records in the 12-bit mode (2 stereo sounds).

16BIT (🎵16b)

Records in the 16-bit mode (1 stereo sound with high quality).

🔗 Notes

- When recording in the HDV format, sound is automatically recorded in [16BIT] mode.

MULTI-SOUND

You can select whether to play back audio recorded using other devices with dual sound or stereo sound.

▶ STEREO

Plays back with main and sub sound (or stereo sound).

1

Plays back with main sound (or the left channel sound).

2

Plays back with sub sound (or the right channel sound).

🔗 Notes

- You can play back, but cannot record a dual sound track cassette on the VCR.

DV AUDIO MIX DV

You can monitor the sound recorded on the tape with audio dubbing or 4ch microphone recording during playback.

▶ ST1

Select to output only the originally recorded sound.

MIX

Select to synthesize and output the originally recorded sound and the sound added afterwards.

ST2

Select to output only the sound added afterwards.

🔗 Notes

- You cannot adjust the balance of the sound recorded on a tape in the 16-bit DV audio mode.

(MEMORY SET)

menu

Settings for the “Memory Stick Duo” media (QUALITY/ALL ERASE, etc.)

The default settings are marked with ►. The indicators in parentheses appear when the items are selected.

See page 54 for details on selecting menu items.

Press MENU → select  (MEMORY SET) using ▲/▼ → press EXEC.

QUALITY



► FINE (FINE)



Records still images at the fine image quality level.

STANDARD (STD)

Records still images at the standard image quality level.

Capacity of the “Memory Stick Duo” media (MB) and the number of recordable still images

	1.2M 1440 × 810 	VGA 640 × 480 	0.2M 640 × 360 
64MB	100 240	390 980	490 980
128MB	205 490	780 1970	980 1970
256MB	370 890	1400 3550	1750 3550
512MB	760 1800	2850 7200	3600 7200
1GB	1550 3650	5900 14500	7300 14500
2GB	3150 7500	12000 30000	15000 30000
4GB	6300 14500	23500 59000	29500 59000

	1.2M 1440 × 810 	VGA 640 × 480 	0.2M 640 × 360 
8GB	12500 30000	48000 115000	60000 115000

Top: [FINE] is selected for image quality.
Bottom: [STANDARD] is selected for image quality.

The image size is fixed depending on the format or the aspect ratio of movies as follows:

- When capturing from a movie in the HDV format: 1.2M
- When capturing from a movie in the DV format (16:9): 0.2M
- When capturing from a movie in the DV format (4:3): VGA (0.3M)

Notes

- All numbers measured when using a “Memory Stick Duo” media made by Sony Corporation. The number of still images may vary depending on the recording environment or the recording media.

ALL ERASE

You can delete all the still images on a “Memory Stick Duo” media without image protection, or in the selected folder.

- ① Select [ALL FILES] or [CURRENT FLDR].
[ALL FILES]: Deletes all the still images on the “Memory Stick Duo” media.
[CURRENT FLDR]: Deletes all the still images in the selected folder.
- ② Select [YES] → [YES].
[Erasing all data...] is displayed.
[Completed.] is displayed when all unprotected still images are deleted.

Notes

- Release the write-protect tab on the “Memory Stick Duo” media beforehand when using the “Memory Stick Duo” media with the write-protect tab (p. 80).
- The folder will not be deleted even when you delete all the still images.

- Do not attempt the following operations while [Erasing all data...] is on the screen:
 - Operate the POWER switch/operation buttons.
 - Eject the “Memory Stick Duo” media.

FORMAT

You can delete all the still images on the “Memory Stick Duo” media to recover recordable free space to allow you to write in. If you want to format the “Memory Stick Duo” media, select [YES]→[YES].

Notes

- Do not attempt the following operations while [Formatting...] is on the screen:
 - Operate the POWER switch/operation buttons.
 - Eject the “Memory Stick Duo” media.
- Formatting erases everything on the “Memory Stick Duo” media including protected image data and newly created folders.

Tips

- The “Memory Stick Duo” media has been formatted at the factory, and does not require formatting at purchase.

FILE NO.

► SERIES

Assigns file numbers in sequence even if the “Memory Stick Duo” media is replaced with another one. The file number is reset when a new folder is created or the recording folder is replaced with another.

RESET

Assigns file numbers in sequence, following the largest file number existing on the current “Memory Stick Duo” media.

NEW FOLDER

When you select [YES], you can create a new folder (102MSDCF to 999MSDCF) on a “Memory Stick Duo” media. When a folder is full (a maximum of 9,999 still images are stored), a new folder is automatically created.

Notes

- You cannot delete the created folders using the VCR. You will have to format the “Memory Stick Duo” media (p. 63), or delete them using your computer.
- The number of recordable still images on a “Memory Stick Duo” media may decrease as the number of folders increases.

REC FOLDER (Recording folder)

You can select the folder to be used for recording using , then press EXEC.

Tips

- As the default setting, still images are saved in the 101MSDCF folder.
- Once you record a still image in a folder, the same folder will be set as the default folder for playback.

PB FOLDER (Playback folder)

You can select the playback folder using , then press EXEC.

(OTHERS) menu

Other basic settings (BEEP/USB SELECT, etc.)

The default settings are marked with ►. The indicators in parentheses appear when the items are selected.

See page 54 for details on selecting menu items.

Press MENU → select  (OTHERS) using ▲/▼ → press EXEC.

ASSIGN BTN

See page 36.

CLOCK SET

See page 18.

WORLD TIME

When you use the VCR abroad, you can adjust the clock to the local time by setting the time difference using ▲/▼ and EXEC. When you set the time difference to 0, the clock returns to the original setting.

LANGUAGE

You can select the language to be used on the screen. See page 19.

Tips

- The VCR offers [ENG[SIMP]] (simplified English) for when you cannot find your native tongue among the options.

REMAINING

► AUTO

Displays the remaining tape indicator for about 8 seconds in situations such as those described below.

- When you set the POWER switch to ON with a cassette inserted.
- When you press PLAY ► or DISPLAY/BATT INFO.

ON

Always displays the remaining tape indicator.

BEEP

► ON

A melody sounds when you operate the menus.

OFF

Cancels the melody.

REMOTE CTRL (Remote control)

You can operate the VCR with the supplied Remote Commander or the one supplied by other Sony products.

► VTR2

You can operate the VCR with the supplied Remote Commander or the one supplied by other Sony products with the remote control code VTR2.

VTR4

You can operate the VCR with the Remote Commander of other Sony products with the remote control code VTR4.

OFF

You cannot operate the VCR with a remote commander. You can prevent mis-operation of the VCR caused by the remote commander of other devices.

USB SELECT

You can connect the VCR to a computer with a USB cable and copy still images on the “Memory Stick Duo” media to the computer (p. 47). You can also connect the VCR to a PictBridge compatible printer (p. 51) using this function.

▶ **Memory Stick**

Select to view still images on a “Memory Stick Duo” media on the computer or to copy them to the computer.

PictBridge PRINT

Select to connect the VCR to a PictBridge compatible printer to print out directly (p. 51).

Troubleshooting

If you run into any problems using your VCR, use the following table to troubleshoot the problem. If the problem persists, disconnect the power source and contact your Sony dealer.

- Overall operations/Remote Commander66
- Batteries/Power sources66
- LCD screen.....67
- Cassette tapes/“Memory Stick Duo” media67
- Playback68
- Recording69
- Connecting to TV70
- Dubbing/Editing/Connecting to other devices.....70
- Connecting to a computer71

Overall operations/Remote Commander

The power does not turn on or abruptly turns off.

- Attach a charged battery pack to the VCR (p. 13).
- Use the AC Adaptor to connect to a wall outlet (wall socket) (p. 13).

The VCR does not operate even when the power is set to on.

- Disconnect the AC Adaptor from the wall outlet (wall socket) or remove the battery pack, then reconnect it after about 1 minute.
- Press the **RESET** button (p. 90) using a sharp-pointed object.

The VCR gets warm.

- The VCR may get warmer while you use it. This is not a malfunction.

The Remote Commander does not function.

- Changing the [REMOTE CTRL] setting according to the Remote Commander (p. 64).
- Remove any obstructions between the Remote Commander and the remote sensor.
- Keep strong light sources, such as sunlight or overhead lighting, away from the remote sensor, otherwise the Remote Commander may not function properly.
- Insert fresh batteries in the compartment with its +/- terminals matching those of the compartment (p. 93).

The other VCR malfunctions when you use the Remote Commander.

- Select a commander mode other than VTR2 for the VCR.
- Cover the sensor of the other VCR with black paper.

Batteries/Power sources

The POWER/CHARGE lamp does not light while the battery pack is being charged.

- Set the POWER switch to OFF (CHG) (p. 13).
- Attach the battery pack to the VCR correctly (p. 13).
- Connect the power cord (mains lead) to the wall outlet (wall socket) properly.
- The battery charge is completed (p. 13).

The POWER/CHARGE lamp flashes while the battery pack is being charged.

- When the battery pack is too hot or cold, the POWER/CHARGE lamp may flash slowly, indicating that the battery pack cannot be charged.
- Attach the battery pack to the VCR correctly (p. 13). If the problem persists, disconnect the AC Adaptor from the wall outlet (wall socket) and contact your Sony dealer. The battery pack may be damaged.

The remaining battery time indicator does not indicate the correct time.

- Ambient temperature is too high or too low, or the battery pack has not been charged enough. This is not a malfunction.
- Fully charge the battery again. If the problem persists, the battery may be worn-out. Replace it with a new one (p. 13, 81).
- The indicated time may not be correct in certain circumstances. For example, when you open or close the LCD panel, it takes about 1 minute to display the correct remaining battery time.

The battery pack discharges too quickly.

- Ambient temperature is too high or too low, or the battery pack has not been charged enough. This is not a malfunction.
- Fully charge the battery again. If the problem persists, the battery may be worn-out. Replace it with a new one (p. 13, 81).

LCD screen

Menu items are grayed out.

- You cannot select grayed items in the current recording/playback situation.

The picture remains on the LCD screen.

- This occurs if you disconnect the DC plug or remove the battery pack without turning off the power first. This is not a malfunction.

Pictures and information display are not displayed.

- The LCD screen has been turned off. Press LCD ON/OFF (p. 35).
- The information display has been set to off. Press DISPLAY/BATT INFO (p. 35).

Cassette tapes/“Memory Stick Duo” media

The cassette tape cannot be ejected from the compartment.

- Make sure the power source (battery pack or AC Adaptor) is connected correctly (p. 13).
- Moisture condensation has occurred inside the VCR (p. 84).

The Cassette Memory indicator or title display does not appear while using a cassette tape with Cassette Memory.

- This VCR does not support Cassette Memory, so the indicator does not appear.

The remaining tape indicator is not displayed.

- Set [REMAINING] to [ON] to always display the remaining tape indicator (p. 64).

You cannot delete the recorded picture on the tape.

- You cannot delete the recorded picture on the tape. You can only rewind the tape and record again. The new recording overwrites the existing one.
-

You cannot delete any or all still images at once stored on the “Memory Stick Duo” media.

- The still images are protected. Release the protect function on your computer, etc.
-

You cannot record on the “Memory Stick Duo” media.

- The “Memory Stick Duo” media is full. Delete unnecessary still images recorded on the “Memory Stick Duo” media (p. 50).
 - Format the “Memory Stick Duo” media on the VCR (p. 63) or insert another “Memory Stick Duo” media (p. 20).
-

Playback

Refer also to the Cassette tapes/“Memory Stick Duo” media section (p. 67).

You cannot play back tape.

- Set the POWER switch to ON.
 - Rewind the tape (p. 22).
 - Eject the tape and insert it again (p. 19)
-

Image data stored on a “Memory Stick Duo” media cannot be played back correctly.

- Image data cannot be played back if you have modified file names or folders, or if you have edited the data on a computer (In this case, the file name flashes). This is not a malfunction (p. 81).
 - Still images recorded by other devices may not be played back in actual size or displayed correctly. This is not a malfunction.
-

The data file name is displayed incorrectly, or flashing.

- The file is damaged.
 - The file format is not supported on the VCR (p. 80).
-

Horizontal lines appear on the picture. The displayed pictures are not clear or do not appear.

- Video head is dirty. Clean the head using the cleaning cassette (optional) (p. 85).
-

You cannot hear the sound recorded with 4CH MIC REC on another device. (DV)

- Set [DV AUDIO MIX] (p. 61).
-

No sound or only a low sound is heard.

- Turn up the volume (p. 21).
- Set [MULTI-SOUND] to [STEREO] (p. 61).
- Set [DV AUDIO MIX] (p. 61).
- When you are using an S VIDEO plug or component video cable, make sure the red and white plugs of the A/V connecting cable are also connected (p. 26).

The picture or sound breaks off.

- The tape was recorded in both of the HDV and DV formats. This is not a malfunction.

The movies freeze for a while, or the sound breaks off.

- This occurs if the tape or video head is dirty (p. 85).
- Use the Sony mini DV cassette.

“-:-:--:--” is displayed on the screen.

- The tape you are playing was recorded without setting the date and time.
- A blank section on the tape is being played back.
- The data code on a tape with a scratch or noise cannot be read.

Noises appear and **PAL or **50i** is displayed on the screen (GV-HD700/1).**

- The tape was recorded in a TV color system other than that of the VCR (NTSC) (p. 78). This is not a malfunction.

Noises appear and **NTSC or **60i** is displayed on the screen (GV-HD700E/1).**

- The tape was recorded in a TV color system other than that of the VCR (PAL) (p. 78). This is not a malfunction.

Date search does not work correctly.

- Make sure to record more than 2 minutes after the date changed. If one day's recording is too short, the VCR may not accurately find the point where the recording date changes.
- There is a blank section between recorded sections of the tape. This is not a malfunction.

End search does not work.

- Do not eject the cassette after recording (p. 33).
- Nothing is recorded on the tape before performing end search after inserting the tape.
- There is a blank section between recorded sections of the tape. This is not a malfunction.

No picture appears during End search.

- The tape was recorded in both of the HDV and DV formats. This is not a malfunction.

New sound added to a recorded tape on another device is not heard.

- Adjust [DV AUDIO MIX] from [ST1] (original sound) side until the sound is heard appropriately (p. 61).

4ch-12b appears on the screen.

- This appears when you play back a tape recorded on other recording devices using a 4ch microphone (4CH MIC REC). This VCR does not comply with the 4ch microphone recording standard.

Recording**The recording does not start when you press REC.**

- Set the POWER switch to ON (p. 18).
- The tape has reached the end. Rewind it, or insert a new cassette.
- Set the write-protect tab of the cassette to REC or insert a new cassette (p. 79).
- The tape is stuck to the drum due to moisture condensation. Remove the cassette and leave the VCR for at least 1 hour, then re-insert the cassette (p. 84).

Connecting to TV

You cannot view the picture on the TV connected with the i.LINK cable.

- You cannot view the picture in the HD (high definition) quality on the TV, if an i.LINK jack of the TV is not compatible with the HDV1080i specification (p. 24). Refer to the instruction manual supplied with your TV.
- Down convert the pictures recorded in the HDV format and play back in the DV format (SD image quality) (p. 57).
- Play back pictures using another connecting cable (p. 24).

You cannot hear the sound on the TV connected with the S VIDEO plug (S VIDEO channel).

- When you are using an S VIDEO plug, make sure the red and white plugs of the A/V connecting cable are also connected (p. 27).

You cannot view the picture or hear the sound on the TV connected with the component video cable.

- Set [COMPONENT] according to the requirements of the connected device (p. 57).
- When you are using the component video cable, make sure the red and white plugs of the A/V connecting cable are also connected (p. 25, 27).

You cannot view the picture or hear the sound on the TV connected with the HDMI cable.

- Pictures are not output from the HDMI OUT jack, if copyright protection signals are recorded in the pictures.
- DV format pictures input to the VCR via i.LINK cable (p. 29) cannot be output.

- This occurs if you record on a tape in both of the HDV and DV formats. Disconnect and connect the HDMI cable, or set the POWER switch to ON again.

The picture appears distorted on the 4:3 TV.

- This occurs when viewing a picture recorded in the 16:9 (wide) mode on a 4:3 TV. Set [TV TYPE] (p. 57) and play back the picture.

Black zone appears at top and bottom of a 4:3 TV screen.

- This occurs when viewing a picture recorded in the 16:9 (wide) mode on a 4:3 TV. This is not a malfunction.

Dubbing/Editing/Connecting to other devices

Pictures from connected devices cannot be magnified.

- You cannot magnify pictures from connected devices on the VCR (p. 37).

Time code and other information appear on the display of the connected device.

- Set [DISP OUTPUT] to [LCD PANEL] while connected with an A/V connecting cable (p. 59).

You cannot dub pictures correctly using the A/V connecting cable.

- The A/V connecting cable is not connected properly. Make sure that the A/V connecting cable is connected to the input jack of the other device for dubbing a picture from the VCR.

When connected using an i.LINK cable, no picture appears on the monitor screen or the picture is distorted during dubbing.

- Set [HDV/DV SEL] according to the requirements of the connected device (p. 56).
- If the connected device is not compatible with HDV1080i specification, you cannot dub pictures in the HD (high definition) image quality (p. 39). For details, refer to the instruction manual supplied with the connected device.
- Set [i.LINK CONV] to [ON] (p. 57) and dub pictures in the SD (standard definition) image quality.

You cannot add sound to the recorded tape.

- You cannot add sound to the recorded tape on the VCR.

You cannot dub pictures correctly using the HDMI cable.

- You cannot dub pictures using the HDMI cable.

Still images cannot be captured from a tape to a “Memory Stick Duo” media.

- You cannot capture still images at all or good-quality images from the tape that has been used repeatedly for recording.

When you play back and output a picture recorded in wide (16:9) format using an i.LINK cable, the screen stretches vertically.

- You cannot output the aspect ratio setting using an i.LINK cable. Set the aspect ratio of the TV instead.
- Connect using an A/V connecting cable instead, and set [TV TYPE] (p. 57).

Connecting to a computer

The computer does not recognize the VCR. [USB] [i.LINK]

- Disconnect the cable from the computer and the VCR, then connect it again securely.
- Disconnect USB devices other than the keyboard, the mouse, and the VCR from the USB jack on the computer.
- Disconnect the cable from the computer and the VCR, restart the computer, then connect them again correctly.

You cannot view or copy the video recorded on a tape on the computer. [i.LINK]

- Connect the i.LINK cable because you cannot copy video with the USB cable.
- Disconnect the i.LINK cable, turn on the VCR, then connect it again.

You cannot view or copy still images recorded on a “Memory Stick Duo” media on the computer. [USB]

- Insert a “Memory Stick Duo” media in the correct direction, then push it all the way in.
- You cannot use an i.LINK cable. Connect the VCR and the computer using the USB cable.
- Set the POWER switch to ON and set [USB SELECT] to [Memory Stick] (p. 65).
- The computer does not recognize the “Memory Stick Duo” media during VCR operations such as tape playback or editing. Finish any VCR operations and then connect the VCR to the computer again.
- Disconnect USB devices other than the keyboard, the mouse, and the VCR from the USB jack on the computer.

Your computer freezes.

- Set [HDV/DV SEL] correctly according to the connected device (p. 56).
- Disconnect the cable from your computer and VCR. Reboot your computer, then connect your computer and VCR following the steps in the correct order (p. 49).

Warning indicators and messages

Self-diagnosis display/Warning indicators

If indicators appear on the LCD screen, check the following.

You can fix some symptoms by yourself. If the problem persists even after you have tried a couple of times, contact your Sony dealer or local authorized Sony service facility.

C: (or E:) □□:□□ (Self-diagnosis display)

C:04:□□

- The battery pack is not an "InfoLITHIUM" battery pack. Use an "InfoLITHIUM" battery pack (p. 81).
- Connect the DC plug of the AC Adaptor to the DC IN jack of your VCR securely (p. 13).

C:06:□□

- The battery pack is too warm. Replace the battery pack, or remove it and put it in a cool place.

C:21:□□

- Moisture condensation has occurred. Remove the cassette and leave your VCR for at least 1 hour, then re-insert the cassette (p. 84).

C:22:□□

- Clean the head using a cleaning cassette (optional) (p. 85).

C:31:□□ / C:32:□□

- Symptoms that are not described above have occurred. Remove and insert the cassette, then operate your VCR again. Do not perform this procedure if moisture condensation has occurred (p. 84).
- Remove the power source. Reconnect it and operate your VCR again.
- Change the cassette. Press the **RESET** button (p. 90), and operate your VCR again.

E:92:□□

- Turn on the power again to restore your VCR by pressing **RESET** (p. 90).

101-1001(Warning indicator pertaining to files)

- The file is damaged.
- The file is unreadable (p. 81).

(Battery level warning)

- The battery pack is nearly used up.
- Depending on the operating, environment, or battery conditions,  may flash, even if there are approximately 5 to 10 minutes remaining.

(Warning indicator pertaining to battery pack temperature)

- The battery pack is too hot. Replace the battery pack, or remove it and put it in a cool place.

(Warning indicator pertaining to battery pack temperature)

- The battery pack is too cold. Replace the battery pack, or remove it and put it in a warm place.

(Moisture condensation warning)*

- Eject the cassette, remove the power source, and then leave it for about 1 hour with the cassette compartment lid open (p. 84).

(Warning indicators pertaining to the tape)

Slow flashing:

- There is less than 5 minutes remaining on the tape.
- No cassette is inserted.*
- The write-protect tab on the cassette is set to lock (p. 79).*

Fast flashing:

- The tape has run out.*

(Eject cassette warning)*

Slow flashing:

- The write-protect tab on the cassette is set to lock (p. 79).

Fast flashing:

- Moisture condensation has occurred (p. 84).
- The self-diagnosis display code is displayed (p. 73).

(Warning indicator pertaining to “Memory Stick Duo” media)

- A “Memory Stick Duo” media is not inserted (p. 20).

(Warning indicators pertaining to “Memory Stick Duo” media formatting)*

- The “Memory Stick Duo” media is damaged.
- The “Memory Stick Duo” media is not formatted correctly (p. 63, 80).

(Warning indicators pertaining to unsupported “Memory Stick Duo” media)*

- A “Memory Stick Duo” media that cannot be used in your VCR is inserted (p. 80).

(Warning indicator pertaining to the write-protect of the “Memory Stick Duo” media)*



- The write-protect tab on the “Memory Stick Duo” media is set to lock (p. 80).

* You hear a melody when the warning indicators appear on the screen (p. 64).

Description of warning messages

If messages appear on the screen, follow the instructions.

■ Moisture condensation

  **Moisture condensation. Eject the cassette** (p. 84)

 **Moisture condensation. Turn off for 1H.** (p. 84)

■ Cassette/Tape

 **Reinsert the cassette.** (p. 19)

- Check if the cassette is damaged.

  **The tape is locked - check the tab.** (p. 79)

■ “Memory Stick Duo” media

 **Reinsert the Memory Stick.** (p. 20, 80)

- Reinsert the “Memory Stick Duo” media a few times. If even then the indicator flashes, the “Memory Stick Duo” media might be damaged. Try with another “Memory Stick Duo” media.

 **This Memory Stick is not formatted correctly.**

- Check the format, then format the “Memory Stick Duo” media with your VCR if necessary (p. 63, 80).

Memory Stick folders are full.

- You cannot create folders exceeding 999MSDCF. You cannot delete created folders using your VCR.
- You will have to format the “Memory Stick Duo” media (p. 63), or delete them using your computer.

■ **PictBridge compliant printer**

Check the connected device.

- Switch off the printer and switch it on again, then disconnect the USB cable and reconnect it.

Error. Cancel the task.

- Switch off the printer and switch it on again, then disconnect the USB cable and reconnect it.

■ **Others**

Change to correct tape format.

- The pictures cannot be played back because of an incompatible format.

**No signal display in “HDV/DV SEL”.
Change setting.**

- Stop playback or signal input, or change [HDV/DV SEL] setting (p. 56).

  **Dirty video head. Use a cleaning cassette.** (p. 85)

Using your VCR abroad

Power supply

You can use your VCR in any country/region using the AC Adaptor supplied with the VCR within the AC 100 V to 240 V, 50/60 Hz range.

Use a commercially available AC plug adaptor [a], if necessary, depending on the design of the wall outlet (wall socket) [b].

Representative plug of power supply cord of countries/regions around the world.



A Type
(American Type)



B Type
(British Type)



BF Type
(British Type)



B3 Type
(British Type)



C Type
(CEE Type)



SE Type
(CEE Type)



O Type
(Ocean Type)

The representative supply voltage and plug type are described in this chart.

Depend on an area, Different type of plug and supply voltage are used.

Attention: Power cord meeting demands from each country shall be used.

-For only the United States

Use a UL Listed, 1.5-3 m (5-10 ft.), Type SPT-2 or NISPT-2, AWG no. 18 power supply cord, rated for 125 V 7 A, with a NEMA 1-15P plug rated for 125 V 15 A.”

Europe

Countries/regions	Voltage	Frequency (Hz)	Plug type
Austria	230	50	C
Belgium	230	50	C
Czech	220	50	C
Denmark	230	50	C
Finland	230	50	C
France	230	50	C
Germany	230	50	C
Greece	220	50	C
Hungary	220	50	C
Iceland	230	50	C
Ireland	230	50	C/BF
Italy	220	50	C
Luxembourg	230	50	C
Netherlands	230	50	C
Norway	230	50	C
Poland	220	50	C
Portugal	230	50	C
Romania	220	50	C
Russia	220	50	C
Slovak	220	50	C
Spain	127/230	50	C
Sweden	230	50	C
Switzerland	230	50	C
UK	240	50	BF

Asia

Countries/regions	Voltage	Frequency (Hz)	Plug type
China	220	50	A
Hong Kong	200/220	50	BF
India	230/240	50	C
Indonesia	127/230	50	C
Japan	100	50/60	A
Korea (rep)	220	60	C
Malaysia	240	50	BF
Philippines	220/230	60	A/C
Singapore	230	50	BF
Taiwan	110	60	A
Thailand	220	50	C/BF
Vietnam	220	50	A/C

Oceania

Countries/regions	Voltage	Frequency (Hz)	Plug type
Australia	240	50	O
New Zealand	230/240	50	O

North America

Countries/regions	Voltage	Frequency (Hz)	Plug type
Canada	120	60	A
USA	120	60	A

Central America

Countries/regions	Voltage	Frequency (Hz)	Plug type
Bahamas	120/240	60	A
Costa Rica	110	60	A
Cuba	110/220	60	A/C
Dominican (rep)	110	60	A
El Salvador	110	60	A
Guatemala	120	60	A
Honduras	110	60	A
Jamaica	110	50	A
Mexico	120/127	60	A
Nicaragua	120/240	60	A
Panama	110/220	60	A

South America

Countries/regions	Voltage	Frequency (Hz)	Plug type
Argentina	220	50	C/BF/O
Brazil	127/220	60	A/C
Chile	220	50	C
Colombia	120	60	A
Peru	220	60	A/C
Venezuela	120	60	A

Middle East

Countries/regions	Voltage	Frequency (Hz)	Plug type
Iran	220	50	C/BF
Iraq	220	50	C/BF
Israel	230	50	C
Saudi Arabia	127/220	50	A/C/BF
Turkey	220	50	C
UAE	240	50	C/BF

Africa

Countries/regions	Voltage	Frequency (Hz)	Plug type
Algeria	127/220	50	C
Congo (dem)	220	50	C
Egypt	220	50	C
Ethiopia	220	50	C
Kenya	240	50	C/BF
Nigeria	230	50	C/BF
South Africa	220/230	50	C/BF
Tanzania	230	50	C/BF
Tunisia	220	50	C

On TV color systems

GV-HD700/1:

Your VCR is NTSC system, so its picture can only be viewed on an NTSC system TV with an AUDIO/VIDEO input jack.

GV-HD700E/1:

Your VCR is PAL system, so its picture can only be viewed on a PAL system TV with an AUDIO/VIDEO input jack.

System	Used in
NTSC	Bahama Islands, Bolivia, Canada, Central America, Chile, Colombia, Ecuador, Guyana, Jamaica, Japan, Korea, Mexico, Peru, Surinam, Taiwan, the Philippines, the U.S.A., Venezuela, etc.
PAL	Australia, Austria, Belgium, China, Czech Republic, Denmark, Finland, Germany, Holland, Hong Kong, Hungary, Italy, Kuwait, Malaysia, New Zealand, Norway, Poland, Portugal, Singapore, Slovak Republic, Spain, Sweden, Switzerland, Thailand, United Kingdom, etc.
PAL - M	Brazil
PAL - N	Argentina, Paraguay, Uruguay.
SECAM	Bulgaria, France, Guiana, Iran, Iraq, Monaco, Russia, Ukraine, etc.

Viewing HDV format pictures recorded in the HDV format

You need an HDV1080i compatible TV (or monitor) with a component jack and AUDIO/VIDEO input jack. A component video cable and A/V connecting cable are also needed.

Viewing DV format pictures recorded in the DV format

You need a TV with the AUDIO/VIDEO input jack. A connecting cable is also needed.

Simple setting of the clock by time difference

When you are abroad, you can easily adjust the clock to the local time by setting the time difference. Select [WORLD TIME], then set the time difference (p. 64).

Maintenance and precautions

HDV format and recording/ playback

Your VCR is capable of recording in both HDV and DV formats.
You can use mini DV format cassettes only.
Use a cassette with the Mini DV mark.
Your VCR is not compatible with the Cassette Memory function.

What is the HDV format?

The HDV format is a video format developed to record and play back digital high definition (HD) video signals on a DV cassette.

Your VCR adopts the Interlace mode with 1,080 effective scan lines of screen ruling (1080i, number of pixels 1,440 × 1,080 dots).

The video bit rate for recording is about 25 Mbps.

i.LINK is adopted for the digital interface, enabling a digital connection with an HDV compatible TV or computer.

- HDV signals are compressed in MPEG2 format, which is adopted in BS (broadcast satellite) digital, terrestrial digital HDTV broadcastings, in Blu-ray Disc recorders, etc.

Playback

Your VCR can play back pictures in both the HDV1080i specification and DV format.

Your VCR can play back pictures recorded in the HDV 720/30p format, but cannot output it from the  HDV/DV (i.LINK) interface.

To prevent a blank section from being created on the tape

Go to the end of the recorded section using the end search (p. 33) before you begin the next recording when you have played back the tape.

Copyright signal

■ When you play back

If the cassette you play back on your VCR contains copyright signals, you cannot copy it to a tape in another device connected to your VCR.

■ When you record

You cannot record software on your VCR that contains copyright control signals for copyright protection of software. [Cannot record due to copyright protection.] appears on the LCD screen, if you try to record such software. Your VCR does not record copyright control signals on the tape when it records.

Notes on use

■ When not using your VCR for a long time

Remove the cassette and store it.

■ To prevent accidental erasure

Slide the write-protect tab on the cassette to set it to SAVE.



REC: The cassette can be recorded.

SAVE: The cassette cannot be recorded (write-protected).



■ When labeling the cassette

Make sure to place the label only on the locations shown in the following illustration so as not to cause a malfunction of your VCR.

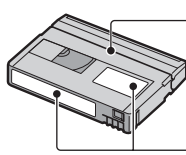

Do not put a label along this border.

Labeling position

Maintenance and precautions (Continued)

■ After using the cassette

Rewind the tape to the beginning to avoid distortion of the picture or the sound. The cassette should then be put in its case, and stored in an upright position.

■ When cleaning the gold-plated connector

Generally, clean the gold-plated connector on a cassette with a cotton-wool swab after every 10 times it has been ejected.

If the gold-plated connector on the cassette is dirty or dusty, the remaining tape indicator may not show correctly.

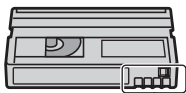

Gold-plated connector

About the “Memory Stick” media

A “Memory Stick” media is a compact, portable IC recording medium with a large data capacity.

You can use the following types of “Memory Stick” media listed below on the VCR. However, we do not guarantee the operation of all types of “Memory Stick” media on your VCR. (See the list below for more details.)

Types of “Memory Stick” media	Recording /Playback
“Memory Stick Duo” (with MagicGate)	○
“Memory Stick PRO Duo”	○

- This product does not support high speed data transfer via a parallel interface.
- This product cannot record or play data that uses “MagicGate” technology. “MagicGate” is a copyright protection technology that records and transfers the contents in an encrypted format.
- This product is compatible with “Memory Stick Micro” media (“M2”). “M2” is the abbreviation for the “Memory Stick Micro” media.

- Still image format: Your VCR compresses and records image data in the JPEG (Joint Photographic Experts Group) format. The file extension is “.JPG.”
- A “Memory Stick Duo” media formatted by a computer (Windows OS/Mac OS) does not have guaranteed compatibility with your VCR.
- Data read/write speed may vary depending on the combination of the “Memory Stick Duo” media and “Memory Stick Duo” media compliant product you use.
- You can prevent accidental erasure of images when you slide the write-protect tab on the “Memory Stick Duo” media with a small tapered object, to the write-protect position.
- Damaged or lost image data will not be compensated for, and may occur in the following cases:
 - If you eject the “Memory Stick Duo” media, turn the power off on your VCR, or remove the battery pack for replacement while your VCR is reading or writing image files on the “Memory Stick Duo” media (while the access lamp is lit or flashing).
 - If you use the “Memory Stick Duo” media near magnets or magnetic fields.
- It is recommended to make a back-up of important data on the hard disk of a computer.
- Be careful not to apply excessive force when writing on a memo area on a “Memory Stick Duo” media.
- Do not attach a label or the like on a “Memory Stick Duo” media or a “Memory Stick Duo” media adaptor.
- When you carry or store a “Memory Stick Duo” media, put it in its case.
- Do not touch, or allow metallic objects to come into contact with the terminals.
- Do not bend, drop or apply strong force to the “Memory Stick Duo” media.
- Do not disassemble or modify the “Memory Stick Duo” media.
- Do not let the “Memory Stick Duo” media get wet.
- Be careful to keep “Memory Stick Duo” media out of the reach of small children. There is danger that a child might swallow it.
- Do not insert anything other than a “Memory Stick Duo” media into the “Memory Stick Duo” media slot. Doing so may cause a malfunction.

- Do not use or keep the “Memory Stick Duo” media in the following locations:
 - Places subject to extremely high temperature, such as a car parked outside in the summer.
 - Places under direct sunlight.
 - Places with extremely high humidity or subject to corrosive gases.

■ On the “Memory Stick Duo” media adaptor

- When using a “Memory Stick Duo” media with a “Memory Stick” media compliant device, make sure to insert the “Memory Stick Duo” media into a “Memory Stick Duo” media adaptor.
- When inserting a “Memory Stick Duo” media into a “Memory Stick Duo” media adaptor, make sure the “Memory Stick Duo” media is inserted facing in the correct direction, then insert it all the way in. Note that improper use may cause a malfunction. Also, if you force the “Memory Stick Duo” media into the “Memory Stick Duo” media adaptor in the wrong direction, it may be damaged.
- Do not insert a “Memory Stick Duo” media adaptor without a “Memory Stick Duo” media attached. Doing so may result in malfunctions of the unit.

■ On a “Memory Stick PRO Duo” media

- The maximum memory capacity of a “Memory Stick PRO Duo” media that can be used on your VCR is 8 GB.

Notes on using “Memory Stick Micro” media

- To use a “Memory Stick Micro” media with the VCR, you need a Duo-sized M2 Adaptor. Insert the “Memory Stick Micro” media into the Duo-sized M2 Adaptor, then insert the adaptor into the “Memory Stick Duo” media slot. If you insert a “Memory Stick Micro” media into the VCR without using a Duo-sized M2 Adaptor, you might not be able to remove it from the VCR.
- Do not leave the “Memory Stick Micro” media within the reach of small children. They might accidentally swallow it.

On image data compatibility

- Image data files recorded on a “Memory Stick Duo” media by your VCR conform to the



“Design rule for Camera File system” universal standard established by the JEITA (Japan Electronics and Information Technology Industries Association).

- On your VCR, you cannot play back still images recorded on other devices (DCR-TRV900 or DSC-D700/D770) that do not conform to the universal standard. (These models are not sold in some regions.)
- If you cannot use a “Memory Stick Duo” media that has been used with another device, format it with your VCR (p. 63). Note that formatting erases all information on the “Memory Stick Duo” media.
- You may not be able to play back images with your VCR:
 - When playing back image data modified on your computer.
 - When playing back image data recorded with other devices.

About the “InfoLITHIUM” battery pack

This unit is compatible with an “InfoLITHIUM” battery pack (L series/M series).

Your VCR operates only with an “InfoLITHIUM” battery pack.

“InfoLITHIUM” battery pack L series have the  mark, and M series have the  mark.

What is an “InfoLITHIUM” battery pack?

An “InfoLITHIUM” battery pack is a lithium-ion battery pack that has functions for communicating information related to operating conditions between your VCR and an optional AC Adaptor/charger.

The “InfoLITHIUM” battery pack calculates the power consumption according to the operating conditions of your VCR, and displays the remaining battery time in minutes.

With an AC Adaptor/charger, the remaining battery time and charging time appear.

Maintenance and precautions (Continued)

To charge the battery pack

- Make sure to charge the battery pack before you start using your VCR.
- We recommend charging the battery pack in an ambient temperature of between 10 °C to 30 °C (50 °F to 86 °F) until the POWER/CHARGE lamp turns off. If you charge the battery pack outside of this temperature range, you may not be able to charge it efficiently.
- After charging is complete, disconnect the cable from the DC IN jack on your VCR or remove the battery pack.

To use the battery pack effectively

- Battery pack performance decreases when the surrounding temperature is 10 °C (50 °F) or below, and the length of time you can use the battery pack becomes shorter. In this case, do one of the following to use the battery pack for a longer time.
 - Put the battery pack in a pocket to warm it up, and insert it in your VCR right before you start recording.
 - Use a large capacity battery pack: NP-QM71D/QM91D/F770/F970 (optional).
- Frequent use of the LCD screen or a frequent playback, fast forward or rewind operation wears out the battery pack faster.
We recommend using a large capacity battery pack: NP-QM71D/QM91D/F770/F970.
- Make sure to set the POWER switch to OFF (CHG) when not recording or playing back on your VCR. The battery pack is also consumed when your VCR is in recording pause or playback pause.
- Have spare battery packs ready for two or three times the expected recording time, and make trial recordings before making the actual recording.
- Do not expose the battery pack to water. The battery pack is not water resistant.

About the remaining battery time indicator

- When the power goes off even though the remaining battery time indicator indicates that the battery pack has enough power to operate, charge the battery pack fully again. Remaining battery time will be indicated correctly. Note, however, that the battery indication will not be restored if it is used in high temperatures for a

long time, or if left in a fully charged state, or when the battery pack is frequently used. Use the remaining battery time indication as a rough guide only.

- The  mark that indicates low battery flashes even if there are still 5 to 10 minutes of battery time remaining, depending on the operating conditions or ambient temperature.

About storage of the battery pack

- If the battery pack is not used for a long time, fully charge the battery pack and use it up on your VCR once a year to maintain proper function. To store the battery pack, remove it from your VCR and put it in a dry, cool place.
- To discharge the battery pack on the VCR completely, leave the VCR turning on without a tape inserted into the VCR until the power goes off.

About battery life

- Battery capacity decreases over time and through repeated use. If decreased usage time between charges becomes significant, it is probably time to replace it with a new one.
- Each battery's life is governed by storage, operating and environmental conditions.

About i.LINK

The  HDV/DV (i.LINK) interface on this unit is an i.LINK-compliant interface. This section describes the i.LINK standard and its features.

What is i.LINK?

i.LINK is a digital serial interface for transferring digital video, digital audio, and other data to other i.LINK-compatible devices. You can also control other devices using the i.LINK.

i.LINK-compatible devices can be connected using an i.LINK cable. Possible applications are operations and data transactions with various digital AV devices.

When two or more i.LINK-compatible devices are daisy-chained with the unit, operation becomes possible from any device in the chain. Note that operation method may vary, or data transactions may not be possible, depending on specifications and characteristics of the connected devices.

🔊 Notes

- Normally, only one device can be connected to this unit with an i.LINK cable. When connecting this unit to an HDV/DV compatible device having two or more i.LINK interfaces, refer to the operating instructions of the device to be connected.

💡 Tips

- i.LINK is a more familiar term for the IEEE 1394 data transport bus proposed by Sony, and is a trademark approved by many corporations.
- IEEE 1394 is an international standard standardized by the Institute of Electrical and Electronics Engineers.

About the i.LINK Baud rate

i.LINK's maximum baud rate varies according to the device. There are 3 types.

S100 (approx. 100Mbps*)

S200 (approx. 200Mbps)

S400 (approx. 400Mbps)

The baud rate is listed under "Specifications" in the operating instructions of each piece of equipment. It is also indicated near the i.LINK interface on some devices.

The baud rate may differ from the indicated value when the unit is connected to a device with a different maximum baud rate.

* What is Mbps?

Mbps stands for "megabits per second," or the amount of data that can be sent or received in one second. For example, a baud rate of 100 Mbps means that 100 megabits of data can be sent in one second.

To use i.LINK functions on this unit

For details on how to dub when this unit is connected to other video devices having an i.LINK interface, see page 39.

This unit can also be connected to other i.LINK-compatible devices made by Sony (for example, a VAI0 series personal computer) as well as to video devices. Some i.LINK compatible video devices, such as Digital Televisions, DVD, MICROMV or HDV recorders/players are not compatible with this unit. Before connecting to other devices, make sure to confirm whether the device is compatible with an HDV/DV device or not. For details on precautions and compatible application software, refer also to the operating instructions for the device to be connected.

🔊 Notes

- Do not connect cables to your VCR with their terminals placed the wrong way. Forcing the connectors into your VCR's jacks may damage them or result in a malfunction of your VCR. When using the 4 pin jacks, align the ▲ mark on the i.LINK cable plug with the ▼ mark on HDV/DV jack or DV jack before connecting.
- Connect the i.LINK cable to the other device first, then to your VCR. Connecting to your VCR first may cause static discharge, resulting in a malfunction of your VCR.
- If you connect a device that has an i.LINK terminal to your VCR via an i.LINK cable, switch off the device and unplug it from the power socket before connecting/disconnecting the i.LINK cable; otherwise, high voltage current may be present at the i.LINK terminal of the device, which could create a malfunction.

About the required i.LINK cable

Use the Sony i.LINK 4-pin-to-4-pin cable (during HDV/DV dubbing).

Maintenance and precautions (Continued)

About x.v.Color

- x.v.Color is a more familiar term for the xvYCC standard proposed by Sony, and is a trademark of Sony.
- xvYCC is an international standard for color space in video. This standard can express a wider color range than the currently used broadcast standard.

About handling of your VCR

On use and care



- Do not use or store the VCR and accessories in the following locations.
 - Anywhere extremely hot, cold or humid. Never leave them exposed to temperatures above 60 °C (140 °F), such as under direct sunlight, near heaters or in a car parked in the sun. They may malfunction or become deformed.
 - Near strong magnetic fields or mechanical vibration. The VCR may malfunction.
 - Near strong radio waves or radiation. The VCR may not be able to record properly.
 - Near AM receivers and video equipment. Noise may occur.
 - On a sandy beach or anywhere dusty. If sand or dust gets in your VCR, it may malfunction. Sometimes this malfunction cannot be repaired.
 - Near windows or outdoors, where the LCD screen may be exposed to direct sunlight. This damages the inside of the LCD screen.
- Operate your VCR on DC 7.2 V (battery pack) or DC 8.4 V (AC Adaptor).
- For DC or AC operation, use the accessories recommended in these operating instructions.
- Do not let your VCR get wet, for example, from rain or sea water. If your VCR gets wet, it may malfunction. Sometimes this malfunction cannot be repaired.
- If any solid object or liquid gets inside the casing, unplug your VCR and have it checked by a Sony dealer before operating it any further.
- Avoid rough handling, disassembling, modifying, physical shock, or impact such as hammering, dropping or stepping on the product.
- Do not use a deformed or damaged battery pack.

- Keep the POWER switch setting to OFF (CHG) when you are not using your VCR.
- Do not wrap your VCR with a towel, for example, and operate it. Doing so might cause heat to build up inside.
- When disconnecting the power cord (mains lead), pull it by the plug and not the cord (lead).
- Do not damage the power cord (mains lead) such as by placing anything heavy on it.
- Keep metal contacts clean.
- Keep the Remote Commander and button-type battery out of children's reach. If the battery is accidentally swallowed, consult a doctor immediately.
- If the battery electrolytic liquid has leaked:
 - consult your local authorized Sony service facility.
 - wash off any liquid that may have contacted your skin.
 - if any liquid gets in your eyes, wash with plenty of water and consult a doctor.

■ When not using your VCR for a long time

- Periodically turn on the VCR and play a cassette for about 3 minutes.
- Use up the battery pack completely before storing it.



Moisture condensation

If your VCR is brought directly from a cold place to a warm place, moisture may condense inside your VCR, on the surface of the tape. In this state, the tape may stick to the head drum and be damaged or your VCR may not operate correctly. If there is moisture inside your VCR, [] Moisture condensation. Eject the cassette] or [] Moisture condensation. Turn off for 1H.] appears.

■ If moisture condensation has occurred

None of the functions except cassette ejection will work. Eject the cassette, turn off your VCR, and leave it for about one hour with the cassette compartment lid open. Your VCR can be used again when both of the following conditions are met:

- The warning message does not appear when the power is turned on.

- Neither  nor  flashes when a cassette is inserted and the video operation buttons are pressed.

If moisture starts to condense, your VCR sometimes cannot detect condensation. If this happens, the cassette is sometimes not ejected for 10 seconds after the cassette compartment lid is opened. This is not a malfunction. Do not close the cassette compartment lid until the cassette is ejected.

■ Note on moisture condensation

Moisture may condense when you bring your VCR from a cold place into a warm place (or vice versa) or when you use your VCR in a humid place as follows:

- You bring your VCR from a ski slope into a place warmed up by a heating device.
- You bring your VCR from an air conditioned car or room into a hot place outside.
- You use your VCR after a squall or a shower.
- You use your VCR in a hot and humid place.

■ How to prevent moisture condensation

When you bring your VCR from a cold place into a warm place, put your VCR in a plastic bag and seal it tightly. Remove the bag when the air temperature inside the plastic bag has reached the surrounding temperature (after about 1 hour).

Video head

If you play back a tape recorded in the HDV format, the image and sound may freeze for a while (about 0.5 seconds). This occurs if the HDV signals cannot be recorded or played back correctly because of dirt on the tape or video head. Depending on the cassette, this fairly infrequently occurs even if the cassette is brand new or is not used a lot.

If this freezing point is created while playing back, you can solve this problem and see the pictures by rewinding after slightly forwarding. Such a freezing point cannot be recovered if it was created while recording.

To prevent such a problem, use the Sony mini DV cassette.

- If the following problem occurs, clean the video heads for 10 seconds with a cleaning cassette (optional).
 - Playback pictures do not move.
 - Playback pictures do not appear.
 - The sound breaks off.
 -  Dirty video head. Use a cleaning cassette.] appears on the screen during recording.
 - The following phenomenon occurs in the HDV format.



The playback screen pauses.



The playback screen goes blank.

- The following phenomenon occurs in the DV format.



Block-noise appears.



The playback screen goes blank.

- The video heads will be worn after long use. If you cannot obtain a clear image even after using a cleaning cassette (optional), the video heads may be worn out. Please contact your Sony dealer or local authorized Sony service facility to have the video heads replaced.

LCD screen

- Do not exert excessive pressure on the LCD screen, as it may cause damage.
- If your VCR is used in a cold place, a residual image may appear on the LCD screen. This is not a malfunction.
- While using your VCR, the back of the LCD screen may heat up. This is not a malfunction.

Maintenance and precautions (Continued)

■ To clean the LCD screen

If fingerprints or dust make the LCD screen dirty, it is recommended you use a soft cloth to clean it. When you use the LCD Cleaning Kit (optional), do not apply the cleaning liquid directly to the LCD screen. Use cleaning paper moistened with the liquid.

On handling the casing

- If the casing is soiled, clean the VCR body with a soft cloth lightly moistened with water, and then wipe the casing with a dry soft cloth.
- Avoid the following to avoid damage to the finish:
 - Using chemicals such as thinner, benzine, alcohol, chemical cloths, repellent, insecticide and sunscreen.
 - Handling the VCR with above substances on your hands.
 - Leaving the casing in contact with rubber or vinyl objects for a long period of time.

On charging the pre-installed rechargeable battery

Your VCR has a pre-installed rechargeable battery to retain the date, time, and other settings even when the POWER switch is set to OFF (CHG). The pre-installed rechargeable battery is always charged while your VCR is connected to the wall outlet (wall socket) via the AC Adaptor or while the battery pack is attached. The rechargeable battery will be fully discharged in about **3 months** if you do not use your VCR at all without the AC Adaptor connected or the battery pack attached. Use your VCR after charging the pre-installed rechargeable battery. However, even if the pre-installed rechargeable battery is not charged, the VCR operation will not be affected as long as you are not recording the date.

■ Procedures

Connect your VCR to a wall outlet (wall socket) using the supplied AC Adaptor, then leave it with the POWER switch set to OFF (CHG) for more than 24 hours.

Specifications

System

Video recording system (HDV)

2 rotary heads, Helical scanning system

Video recording system (DV)

2 rotary heads, Helical scanning system

Still image recording system

Exif Ver. 2.2*

Audio recording system (HDV)

Rotary heads, MPEG-1 Audio Layer -2,
Quantization: 16 bits (Fs 48 kHz,
stereo)
transfer rate: 384 kbps

Audio recording system (DV)

Rotary heads, PCM system
Quantization: 12 bits (Fs 32 kHz, stereo
1, stereo 2), 16 bits (Fs 48 kHz, stereo)

Video signal

GV-HD700/1:
NTSC color, EIA standards
1080/60i specification
GV-HD700E/1:
PAL color, CCIR standards
1080/50i specification

Usable cassette

Mini DV cassette with the ^{Mini} **DV** mark
printed

Tape speed

GV-HD700/1:
HDV Approx. 18.812 mm/s
DV SP Approx. 18.812 mm/s
DV LP Approx. 12.555 mm/s
GV-HD700E/1:
HDV Approx. 18.831 mm/s
DV SP Approx. 18.831 mm/s
DV LP Approx. 12.568 mm/s

Recording/playback time (HDV)

60 min (using a DVM60 cassette)

Recording/playback time (DV)

SP: 60 min (using a DVM60 cassette)
LP: 90 min (using a DVM60 cassette)

Fast forward/rewind time

Approx. 2 min 40 s (using a DVM60
cassette and rechargeable battery pack)

Approx. 2 min 40 s (using a DVM60 cassette and AC Adaptor)

* "Exif" is a file format for still images, established by the JEITA (Japan Electronics and Information Technology Industries Association). Files in this format can have additional information such as your VCR's setting information at the time of recording.

Input/Output connectors

S VIDEO IN jack

GV-HD700/1:

4-pin mini DIN

Luminance signal: 1 Vp-p, 75 Ω (ohms)

Chrominance signal: 0.286 Vp-p, 75 Ω (ohms)

GV-HD700E/1:

4-pin mini DIN

Luminance signal: 1 Vp-p, 75 Ω (ohms)

Chrominance signal: 0.3 Vp-p, 75 Ω (ohms)

VIDEO IN jack

Pin jack

1 Vp-p, 75 Ω (ohms)

AUDIO IN jacks

Pin jack (L/R)

500 mV, input impedance more than 47 kΩ (kilohms)

A/V OUT jack

GV-HD700/1:

10-pin connector

Video signal: 1 Vp-p, 75 Ω (ohms)

Luminance signal: 1 Vp-p, 75 Ω (ohms)

Chrominance signal: 0.286 Vp-p, 75 Ω (ohms)

Audio signal: 500 mV (at load impedance 47 kΩ (kilohms)), Output impedance with less than 2.2 kΩ (kilohms)

GV-HD700E/1:

10-pin connector

Video signal: 1 Vp-p, 75 Ω (ohms)

Luminance signal: 1 Vp-p, 75 Ω (ohms)

Chrominance signal: 0.3 Vp-p, 75 Ω (ohms)

Audio signal: 500 mV (at load impedance 47 kΩ (kilohms)), Output impedance with less than 2.2 kΩ (kilohms)

COMPONENT OUT jack

Y: 1 Vp-p, 75 Ω (ohms)

PB/PR, CB/CR: ± 350 mV, 75 Ω (ohms)

HDMI OUT jack

HDMI Connector

i.LINK interface

i.LINK interface (IEEE 1394, 4-pin connector S100)

USB jack

mini-B

Headphone jack

Stereo minijack (ø 3.5 mm)

LCD screen

Picture

17.5 cm (7 type) WIDE

LCD panel

TFT LCD panel

Total dot number

1 152 000 (800 × 480 × 3(RGB))

Effective dot number

1 137 600 (800 × 474 × 3(RGB))

General

Power requirements

DC 7.2 V (battery pack)

DC 8.4 V (AC Adaptor)

Average power consumption

LCD panel opened:

HDV recording 5.7 W

DV recording 5.5 W

HDV playback 6.1 W

DV playback 5.7 W

LCD panel closed:

HDV recording 3.8 W

DV recording 3.6 W

HDV playback 4.2 W

DV playback 3.8 W

Specifications (Continued)

Operating temperature

0 °C to 40 °C (32 °F to 104 °F)

Storage temperature

-20 °C to +60 °C (-4 °F to +140 °F)

Dimensions (approx.)

201 × 64 × 162 mm

(8 × 2 5/8 × 6 1/2 in.) (w/h/d)

including the projecting parts

Mass (approx.)

1.2 kg (2 lb 9 oz)

Mass in use (approx.)

1.3 kg (2 lb 13 oz) including a tape (DVM80RM3), a battery pack (NP-F570) and the “Memory Stick Duo” media (128MB).

Supplied accessories

See page 12.

AC Adaptor AC-L100C

Power requirements

AC 100 V - 240 V, 50 Hz/60 Hz

Power consumption

18 W

Output voltage

DC 8.4 V*

Operating temperature

0 °C to 40 °C (32 °F to 104 °F)

Storage temperature

-20 °C to +60 °C (-4 °F to +140 °F)

Dimensions (approx.)

48 × 29 × 81 mm

(1 15/16 × 1 3/16 × 3 1/4 in.) (w/h/d)

excluding the projecting parts

Mass (approx.)

170 g (6.0 oz) excluding the power cord (mains lead)

* See the label on the AC Adaptor for other specifications.

Rechargeable battery pack NP-F570

Maximum output voltage

DC 8.4 V

Output voltage

DC 7.2 V

Maximum charge voltage

DC 8.4 V

Maximum charge current

3.0 A

Capacity

typical: 15.8 Wh (2 200 mAh)

minimum: 15.0 Wh (2 100 mAh)

Dimensions (approx.)

38.4 × 20.6 × 70.8 mm

(1 9/16 × 13/16 × 2 7/8 in.) (w/h/d)

Mass (approx.)

100 g (3.5 oz)

Operating temperature



0 °C to 40 °C (32 °F to 104 °F)

Type

Lithium ion

Design and specifications are subject to change without notice.

On trademarks

- “Memory Stick,” “,” “Memory Stick Duo,” “**MEMORY STICK DUO**,” “Memory Stick PRO Duo,” “**MEMORY STICK PRO DUO**,” “Memory Stick Micro,” “MagicGate,” “**MAGICGATE**,” “MagicGate Memory Stick” and “MagicGate Memory Stick Duo” are trademarks of Sony Corporation.
- HDV and the HDV logo are trademarks of Sony Corporation and Victor Company of Japan, Ltd.
- HDMI, HDMI logo, and High-Definition Multimedia Interface are trademarks or registered trademarks of HDMI Licensing LLC.
- “InfoLITHIUM” is a trademark of Sony Corporation.
- “x.v.Color” is a trademark of Sony Corporation.
- “x.v.Colour” is a trademark of Sony Corporation.
- i.LINK and  are trademarks of Sony Corporation.
- Mini  Digital Video Cassette is a trademark.
- Microsoft, Windows, Windows Media, and Windows Vista are trademarks or registered trademarks of U.S. Microsoft Corporation in the U.S. and other countries.
- Macintosh and Mac OS are trademarks of Apple Inc. in the U.S. and other countries.
- Pentium is a trademark or registered trademark of Intel Corporation.

All other product names mentioned herein may be the trademarks or registered trademarks of their respective companies. Furthermore, TM and [®] are not mentioned in each case in this manual.

Notes on the License

ANY USE OF THIS PRODUCT OTHER THAN CONSUMER PERSONAL USE IN ANY MANNER THAT COMPLIES WITH THE MPEG-2 STANDARD FOR ENCODING VIDEO INFORMATION FOR PACKAGED MEDIA IS EXPRESSLY PROHIBITED WITHOUT A LICENSE UNDER APPLICABLE PATENTS IN THE MPEG-2 PATENT PORTFOLIO, WHICH LICENSE IS AVAILABLE FROM MPEG LA, L.L.C., 250 STEELE STREET, SUITE 300, DENVER, COLORADO 80206.

For Customers in Europe

Disposal of waste batteries (applicable in the European Union and other European countries with separate collection systems)



This symbol on the battery or on the packaging indicates that the battery provided with this product shall not be treated as household waste.

On certain batteries this symbol might be used in combination with a chemical symbol. The chemical symbols for mercury (Hg) or lead (Pb) are added if the battery contains more than 0.0005%

mercury or 0.004% lead.

By ensuring these batteries are disposed of correctly, you will help prevent potentially negative consequences for the environment and human health which could otherwise be caused by inappropriate waste handling of the battery.

The recycling of the materials will help to conserve natural resources.

In case of products that for safety, performance or data integrity reasons require a permanent connection with an incorporated battery, this battery should be replaced by qualified service staff only. To ensure that the battery will be treated properly, hand over the product at end-of-life to the applicable collection point for the recycling of electrical and electronic equipment. For all other batteries, please view the section on how to remove the battery from the product safely.

Hand the battery over to the applicable collection point for the recycling of waste batteries.

For more detailed information about recycling of this product or battery, please contact your local Civic Office, your household waste disposal service or the shop where you purchased the product.

Identifying parts and controls

The numbers in () are reference pages.

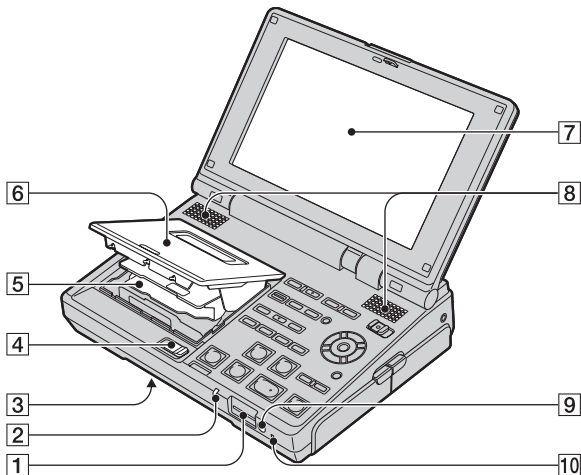

1 “Memory Stick Duo” media slot (20)

2 “Memory Stick” media access lamp (20)

3 **RESET** button (bottom)
Press the **RESET** button using a sharp-pointed object.

If you press the **RESET** button, all settings including the clock setting (except the LCD profile settings) return to the default.

4 EJECT lever (19)

5 Cassette compartment (19)

6 Cassette compartment lid (19)





7 LCD screen (18)

8 Stereo speakers (21)

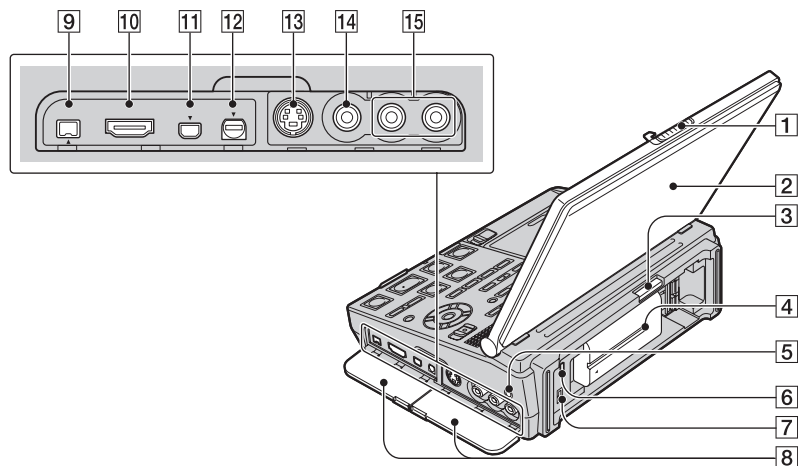
9 Remote sensor (93)

10 POWER/CHARGE lamp (15, 18)



- 1** OPEN  lever (18)
- 2** LCD panel (18)
- 3** ▲BATT RELEASE button (15)
- 4** Battery pack (13)
- 5**  (headphones) jack
Use a headphone with a stereo mini-plug. When you use headphones, the speaker on the VCR is silent.
- 6**  (USB) jack (47, 51)
- 7** DC IN jack (13)
- 8** Jack cover (24, 29, 39)
- 9**  HDV/DV (i.LINK) interface (24, 29, 39)
- 10** HDMI OUT jack (24)
- 11** COMPONENT OUT jack (24)
- 12** A/V OUT jack (24, 29, 39)
- 13** S VIDEO IN jack (29)
- 14** VIDEO IN jack (29)
- 15** AUDIO IN jack (L/R) (29)

Identifying parts and controls (Continued)

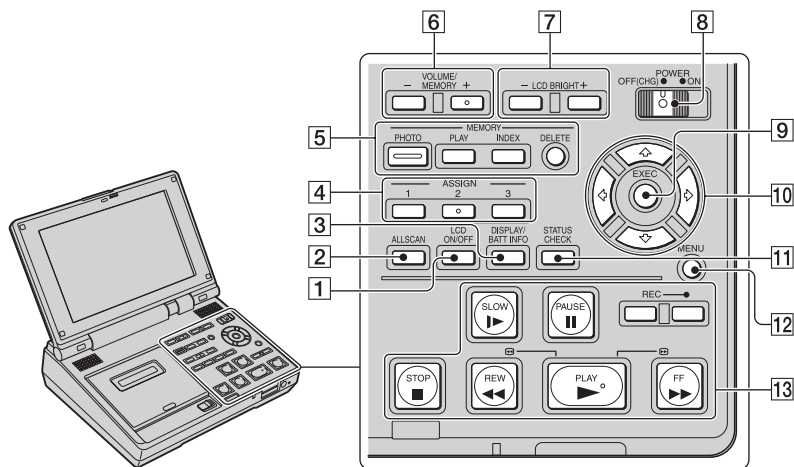

- 1 LCD ON/OFF button (35)
- 2 ALLSCAN button (36)
- 3 DISPLAY/BATT INFO button (16, 35)
- 4 ASSIGN buttons (1/2*/3) (36)
- 5 Memory control buttons (PHOTO, PLAY, INDEX, DELETE) (45, 46, 50)
- 6 VOLUME/MEMORY buttons* (21, 46)
- 7 LCD BRIGHT buttons (21)
- 8 POWER switch (18)
- 9 EXEC button (54)
- 10 $\uparrow/\downarrow/\leftarrow/\rightarrow$ buttons (54)
- 11 STATUS CHECK button (35)
- 12 MENU button (54)
- 13 Video control buttons (PLAY \blacktriangleright *, REW \blacktriangleleft , FF \blacktriangleright , PAUSE \parallel , STOP \blacksquare , SLOW \blacktriangleright , REC) (21, 31)

* Each of the PLAY \blacktriangleright button, VOLUME/MEMORY (+) button and ASSIGN2 button has a raised tactile dot. Use it to identify the location of the buttons.

Remote Commander

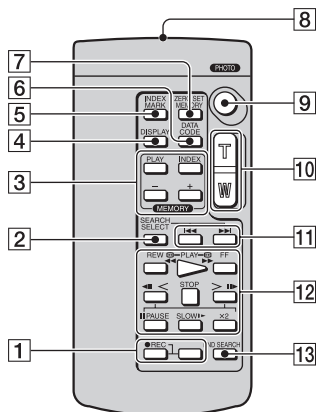

- 1 REC (31)
- 2 SEARCH SELECT (33, 34)
- 3 Memory control buttons (PLAY, INDEX, -/+) (46)
- 4 DISPLAY (35)
- 5 INDEX MARK (38)
- 6 DATA CODE (60)
- 7 ZERO SET MEMORY (32)
- 8 Transmitter
- 9 PHOTO (45)
- 10 Power Zoom (37)
- 11 \lll \ggg (33, 34)
- 12 Video control buttons (REW, PLAY, FF, \lll \ll , STOP, \gg \ggg , PAUSE, SLOW, x2) (21, 22)
- 13 END SEARCH (33)

Notes

- Aim the Remote Commander towards the remote sensor to operate the VCR.
- Point the remote sensor away from strong light sources such as direct sunlight or overhead lighting. Otherwise, the Remote Commander may not function properly.
- When operating your VCR with the supplied Remote Commander, the other VCR may malfunction. In this case, change the commander code to other than VTR2 on the other VCR or cover the sensor of the other VCR with black paper.

To change the battery of the Remote Commander

- ① Slide the battery cover while holding it.

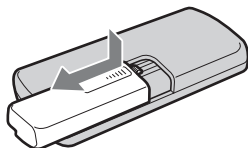

- ② Remove the old R6 (size AA) batteries, then replace them with the new one.

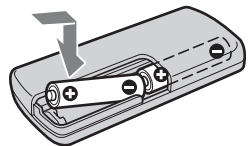

- ③ Close the battery cover. Insert it until it clicks.

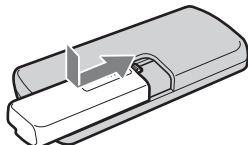

Indicators displayed during recording/playback

The numbers in () are reference pages.

The indicators will not be recorded on the tape during recording.

Recording movies

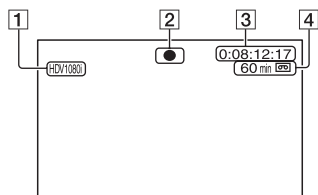

- 1 Recording format (HDV1080i or DV) (56)
Recording mode (SP or LP) is also displayed in the DV format.
- 2 Recording status ([STBY] (standby) or [●] (recording))
- 3 Time code (hour: minute: second: frame)/Tape counter (hour: minute: second)
- 4 Recording capacity of the tape (approx.)
- 5 Recording folder (63)

Recording still images

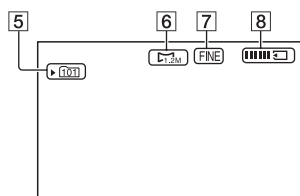

- 6 Image size (62)
- 7 Quality (FINE or STD) (62)
- 8 Recording indicator (45)
- 9 Remaining battery (approx.)
- 10 Tape transport indicator
- 11 Data file name
- 12 Picture number/Total number of recorded pictures in the current playback folder

Viewing movies

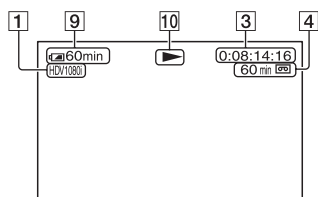

- 13 Playback folder (63)
- 14 Previous/Next folder icon
The [Left Arrow], [Right Arrow], [Double Left Arrow], and [Double Right Arrow] appear when the first or last picture of the current folder is displayed and when there are multiple folders on the same "Memory Stick Duo" media. You can move to Previous/Next folder with the VOLUME/MEMORY button.

Viewing still images

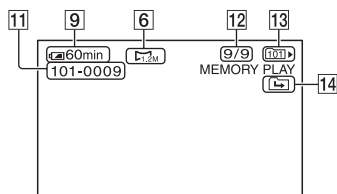

Indicators when you made changes

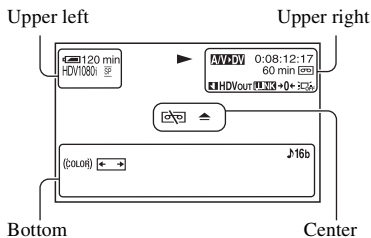

Upper left

Indicator	Meaning
HDV1080i DV	Recording format (56)
SP LP	DV REC MODE (56)*

Upper right

Indicator	Meaning
FINE STD	QUALITY (62)
INDEX MARK	INDEX MARK (38)
HDV IN DV IN	HDV input/ DV input (31)
HDV OUT DV OUT	HDV output/ DV output (42)
i.LINK	i.LINK connection (24, 29, 39)
A/V → DV	A/V → DV OUT (43)
+0+	Zero set memory (32)
LCD OFF	LCD off (35)

Center

Indicator	Meaning
Warning	Warning (73)

Bottom

Indicator	Meaning
J16b	DV AU.MODE (DV Audio mode) (61)*
(COLOR)	x.v.Color (84)
← →	DV WIDE DISP (59)*

* The settings can be made only for the pictures in the DV format.

💡 Tips

- Indicators and their positions are approximate and differ from what you actually see.

Index

Numeric

1080i/480i.....	57
1080i/576i.....	57
12BIT.....	61
16BIT.....	61
16:9.....	57
480i.....	57
4:3.....	57
576i.....	57

A

AC Adaptor.....	13
ALL ERASE.....	62
All scan.....	36
ASSIGN BTN.....	36
AUDIO IN jacks.....	29
AUDIO SET.....	61
Available playback time.....	16
A/V connecting cable.....	25, 27, 30, 41, 43
A/V connecting cable with S VIDEO.....	27, 41
A/V→DV OUT.....	43
A/V OUT jack.....	24, 39

B

Battery pack.....	13
BEEP.....	64
BRIGHTNESS.....	58

C

Cassette tape.....	19, 79
Charging the battery pack.....	13
Charging time.....	16
Cleaning cassette.....	85
CLOCK SET.....	18
COLOR BAR.....	59
COLOR LEVEL.....	58
COLOR PHASE.....	58
COMPONENT.....	57
COMPONENT OUT jack.....	24

Component video cable.....	25, 27
Computer.....	43, 47
Connection	
DVD/HDD recorder.....	39
High definition TV.....	24
Printer.....	51
VCR.....	29, 39
CONTRAST.....	58

D

DATA CODE.....	60
DATE.....	60
Date search.....	33
DC IN jack.....	13
DISP OUTPUT.....	59
Display indicator.....	94
DISPLAY SET.....	58
Double speed playback.....	23
Dubbing.....	39
DV.....	56
DV AUDIO MIX.....	61
DV AU. MODE.....	61
DV BARS.....	60
DV REC MODE.....	56
DV WIDE DISP.....	59

E

End search.....	33
-----------------	----

F

FILE NO.....	63
FINE.....	62
FORMAT.....	63, 80
Frame-by-frame playback.....	22

H

HD (high definition) image quality.....	11, 79
HDMI cable.....	25
HDMI OUT jack.....	24

HDV.....	11, 56, 79
HDV1080i.....	56
HDV/DV SEL.....	56
HDV/DV (i.LINK) interface.....	24, 29, 39
High definition TV.....	24

I

Image size.....	45, 62
Index mark.....	38
Index screen.....	46
Index search.....	34
Index signal.....	38
“InfoLITHIUM” battery pack.....	81
IN/OUT REC.....	56
i.LINK.....	82
i.LINK cable.....	26, 27, 29, 39, 43
i.LINK CONV.....	57

J

JPEG.....	80
-----------	----

L

LANGUAGE.....	64
LCD panel	
BRIGHTNESS.....	58
COLOR LEVEL.....	58
COLOR PHASE.....	58
CONTRAST.....	58
SHARPNESS.....	58
LCD PROFILE.....	58
LCD SET.....	58
Locating a scene on the tape.....	32
LP.....	56

M

Macintosh.....	47
Mains lead.....	13
Maintenance.....	79

Memory photo playback46
 MEMORY SET62
 “Memory Stick Duo” media
6, 80
 Number of recordable still
 images.....62
 Write-protect tab.....80
 “Memory Stick” media
6, 65, 80
 Menu
 AUDIO SET61
 DISPLAY SET58
 IN/OUT REC.....56
 MEMORY SET62
 OTHERS64
 MIX61
 Moisture condensation84
 MPEG279
 MULTI-SOUND.....61

N
 NEW FOLDER.....63
 NTSC78

O
 Operation confirmation beep
 See BEEP
 OTHERS64

P
 PAL.....78
 PB FOLDER.....63
 PB zoom37
 PictBridge51
 PictBridge PRINT.....65
 Picture search.....22
 Playback.....21
 Playing the picture on a TV
24
 Power cord.....13
 Pre-installed rechargeable
 battery86

Print51
 PROFILE NAME.....58

Q

QUALITY62

R

REC FOLDER63
 Recording29
 Remaining battery16
 REMAINING (tape)64
 Remote Commander93
 REMOTE CTRL64
 RESET button90
 Reversal playback22

S

S VIDEO cable.....30, 43
 S VIDEO IN jack29
 SD (standard definition) image
 quality24, 26
 Self-diagnosis display73
 SHARPNESS58
 Signal convert43
 Skip scan22
 Slow playback22
 SP56
 Specifications86
 ST161
 ST261
 STANDARD62
 Status check.....35
 STEREO.....61
 Still image
 Capturing45
 Deleting.....50
 Image size45, 62
 Playback.....46

T

Tape counter.....32, 94

Tape See Cassette tape
 Time code94
 TV color system78
 TV TYPE.....57

U

USB cable.....48, 52
 USB jack.....48, 52
 USB SELECT.....65
 Using abroad.....76

V

VIDEO IN jack29
 Volume adjustment.....21
 VTR264
 VTR464

W

Warning indicators73
 Warning message.....74
 Windows47
 WORLD TIME.....64
 Write-protect tab.....79, 80

X

x.v.Color24, 84

Z

Zero set memory.....32

Paso 1: Comprobación de los artículos suministrados

Asegúrese de que dispone de los siguientes componentes suministrados con su videograbadora.

El número entre paréntesis indica la cantidad de elementos suministrados de cada artículo.

Adaptador de ca (1)

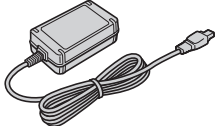

Cable de alimentación (1)



Mando a distancia inalámbrico (1)



Pila de tamaño R6 (AA) para el mando a distancia suministrado (2)

Cable de conexión de A/V (1)



Cable de vídeo componente (1)

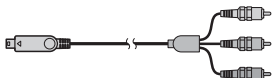

Cable USB (1)

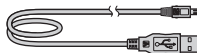

Batería recargable NP-F570 (1)

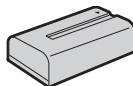

Manual de instrucciones (este manual) (1)

Paso 2: Preparación del suministro eléctrico

Proporcione una fuente de alimentación externa para utilizar su videograbadora. Para usar la videograbadora puede conectar el adaptador de ca a la toma de corriente mural o cargar la batería.

Uso de una toma de corriente y del adaptador de ca como fuente de alimentación externa

Si desea utilizar las funciones de grabación o edición de su videograbadora, o pretende utilizarla por períodos de tiempo prolongados, conecte el adaptador de ca a una toma de corriente mural para obtener una fuente de energía.

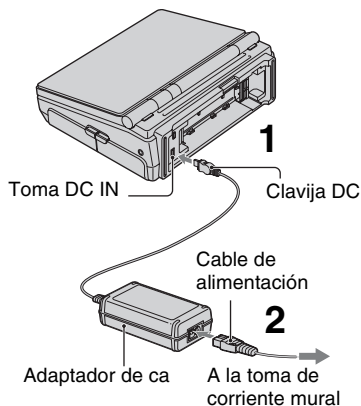

1 Conecte el adaptador de ca a la toma DC IN de la videograbadora. Asegúrese de que la indicación ▲ de la clavija DC coincide con la indicación ▲ de la videograbadora.

2 Conecte el cable de alimentación al adaptador de ca y a la toma de corriente mural.

Notas

- Para desconectar el adaptador de ca de la toma DC IN, sujete tanto la videograbadora como la clavija DC.
- No tire del cable de alimentación conectado a una toma de corriente mural. Desconecte la clavija DC de la toma de corriente mural.
- Si la imagen sufre interferencias, aleje el adaptador de ca de la videograbadora.

Sugerencias

- La videograbadora se puede conectar a una fuente de alimentación externa mediante una toma de corriente mural incluso si se utiliza la batería. En este caso, la batería no pierde su carga.

Carga de la batería

Conecte una de las baterías exclusivas de la serie “InfoLITHIUM” L (en la versión suministrada) o de la serie M (opcional) en la videograbadora y cárguela. Para ver los tipos de baterías compatibles con la videograbadora, consulte la página 102.

1 Para conectar la batería, sujétela de la parte central (①) y deslícela en la dirección que indica la flecha (②) hasta que se oiga un “clíc”.

Serie L:

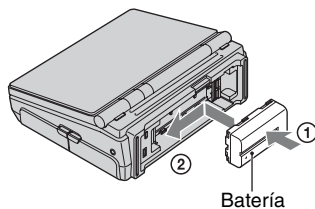

Paso 2: Preparación del suministro eléctrico (continuación)

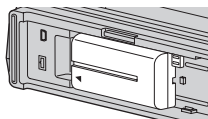

Asegúrese de que la batería encaja perfectamente y de que queda firmemente sujeta a la videograbadora.

- 2** Desplace la palanca OPEN → y abra el panel LCD.

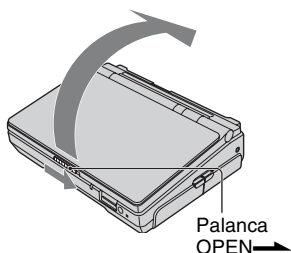

- 3** Ajuste el interruptor POWER en OFF (CHG) (su posición predeterminada).

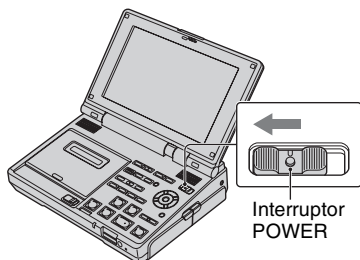

- 4** Conecte el adaptador de ca a la toma DC IN en la videograbadora. Asegúrese de que la indicación ▲ de la clavija DC coincide con la indicación ▲ de la videograbadora.

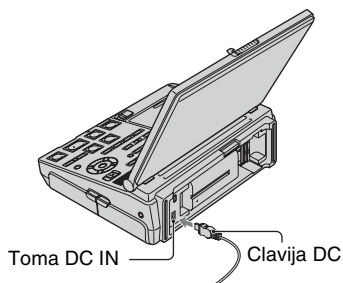

5 Conecte el cable de alimentación al adaptador de ca y a la toma de corriente mural.

El indicador POWER/CHARGE se enciende de color naranja y se inicia el proceso de carga.

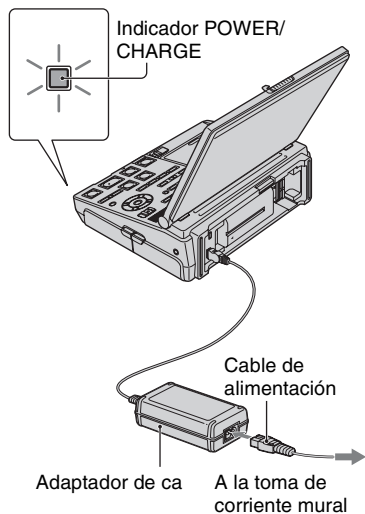

El indicador POWER/CHARGE se apaga cuando la batería está completamente cargada. Después de cargar la batería, desconecte el adaptador de ca de la toma DC IN de la videgrabadora.

⚡ Notas

- La dirección adecuada para conectar una batería de la serie L es distinta a la de una batería de la serie M (opcional). Asegúrese de conectar la batería en la dirección adecuada. Si intenta conectar una batería en la dirección equivocada forzándola, es posible que el equipo no funcione correctamente.

- Asegúrese de no entrar en contacto con el terminal de carga de baterías disponible para las otras baterías durante el proceso de carga de la batería.
- Para desconectar el adaptador de ca de la toma DC IN, sujete tanto la videgrabadora como la clavija DC.

Extracción de la batería

Ajuste el interruptor POWER en OFF (CHG). Mantenga pulsado el botón ▲BATT RELEASE y extraiga la batería.

Serie L:

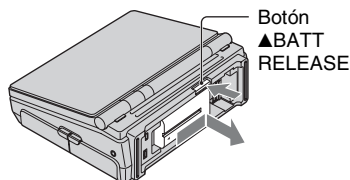

⚡ Notas

- Al extraer la batería o desconectar el adaptador de ca, asegúrese de que el indicador de POWER/CHARGE está apagado.

Uso de la batería "InfolITHIUM" de la serie M (opcional)

Conexión:

Para conectar la batería, sujétela de la parte central (①) y deslícela en la dirección que indica la flecha (②) hasta que se oiga un clic.

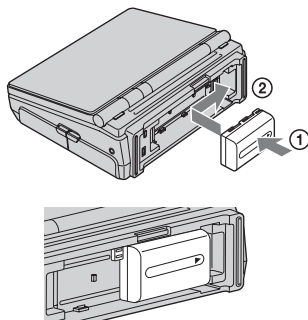

Paso 2: Preparación del suministro eléctrico (continuación)

Asegúrese de que la batería encaja perfectamente y de que queda firmemente sujeta a la videgrabadora.

Extracción:

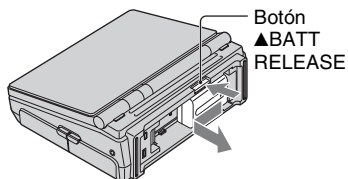

Almacenamiento de la batería

Antes de guardar la batería durante un período prolongado de tiempo, descárguela completamente.

Comprobación del nivel de carga de la batería (Battery Info)

Ajuste el interruptor POWER en OFF (CHG) y, a continuación, pulse DISPLAY/BATT INFO.

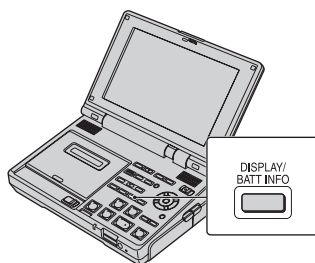

Al poco tiempo, el tiempo de reproducción restante aproximado y la información de la batería se muestran durante unos 7 segundos. Si vuelve a presionar el botón DISPLAY/BATT INFO mientras la información está en pantalla, ésta permanecerá visible hasta 20 segundos.

Carga restante de la batería (aprox.)

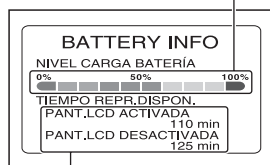

Tiempo de reproducción disponible (aprox.)

Tiempo de carga

Tiempo aproximado (min.) necesario para cargar por completo una batería totalmente descargada.

Batería	Tiempo de carga
NP-FM50	150
NP-QM71D	260
NP-QM91D	360
NP-F570 (suministrada)	260
NP-F770	370
NP-F970	485

Notas

- Las baterías NP-FM30/F330/F530/500/510/710 no se pueden utilizar en esta videgrabadora. No conecte una batería incompatible a la fuerza, ya que podría provocar fallos de funcionamiento en la videgrabadora.

Tiempo de reproducción disponible

Tiempo aproximado (min.) disponible con una batería completamente cargada.

Imágenes en formato HDV (GV-HD700/1)

Batería	Panel LCD abierto	Panel LCD cerrado
NP-FM50	75	115
NP-QM71D	190	285
NP-QM91D	290	430
NP-F570 (suministrada)	150	225
NP-F770	310	460
NP-F970	465	690

Imágenes en formato DV (GV-HD700/1)

Batería	Panel LCD abierto	Panel LCD cerrado
NP-FM50	80	130
NP-QM71D	205	315
NP-QM91D	315	475
NP-F570 (suministrada)	160	245
NP-F770	335	510
NP-F970	500	760

Imágenes en formato HDV (GV-HD700E/1)

Batería	Panel LCD abierto	Panel LCD cerrado
NP-FM50	75	115
NP-QM71D	190	285
NP-QM91D	290	430
NP-F570 (suministrada)	150	225
NP-F770	310	460
NP-F970	465	690

Imágenes en formato DV (GV-HD700E/1)

Batería	Panel LCD abierto	Panel LCD cerrado
NP-FM50	80	130
NP-QM71D	205	315
NP-QM91D	315	475
NP-F570 (suministrada)	160	245
NP-F770	335	510
NP-F970	500	760

Acerca de la batería

- Antes de cargar la batería, ajuste el interruptor POWER en OFF (CHG) y apague el indicador POWER/CHARGE.
- El indicador POWER/CHARGE parpadea durante la carga. La información sobre la batería no se mostrará correctamente en las siguientes circunstancias:
 - Si la batería no está conectada correctamente.
 - Si la batería está dañada.
 - Si la batería está completamente gastada (sólo para la información sobre la batería).
- La batería no suministrará energía eléctrica mientras el adaptador de ca esté conectado a la toma DC IN de la videograbadora, incluso si el cable de alimentación no está conectado a la toma de corriente mural.

Tiempo de carga/reproducción

- Tiempos medidos con la videograbadora a 25 °C (la temperatura de uso recomendada es de 10 a 30 °C).
- El tiempo de reproducción será más corto si la videograbadora se utiliza en condiciones de baja temperatura.
- El tiempo de reproducción se verá reducido en función de las condiciones en las que utilice la videograbadora.

Acerca del adaptador de ca

- Utilice una toma de pared cercana al usar el adaptador de ca. Desconecte el adaptador de ca de la toma de pared inmediatamente si se produce algún fallo al utilizar la videograbadora.
- No utilice el adaptador de ca en un lugar estrecho (por ejemplo, entre la pared y un mueble).

Paso 2: Preparación del suministro eléctrico (continuación)

- Tenga cuidado de no provocar un cortocircuito en la clavija DC del adaptador de ca ni en el terminal de la batería con algún objeto metálico. Podría producir una avería.
- Incluso con la videgrabadora apagada, ésta seguirá recibiendo alimentación de ca (corriente) mientras esté conectada a la toma de pared mediante el adaptador de ca.

Paso 3: Encendido y configuración de la fecha y hora

Cuando utilice su videgrabadora por primera vez, introduzca la fecha y la hora. Si no configura la fecha y la hora, la pantalla [AJUSTE RELOJ] aparecerá cada vez que encienda la videgrabadora.

- 1** Desplace la palanca OPEN → y abra el panel LCD.

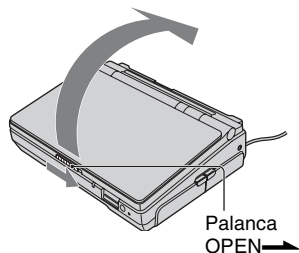

- 2** Pulse el botón verde y, sin soltarlo, deslice el interruptor POWER a ON.

El indicador POWER/CHARGE que está en la parte frontal se enciende de color verde y se muestra la pantalla [AJUSTE RELOJ].

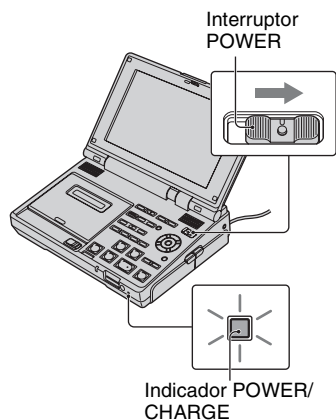

3 Defina el valor de [A] (año) con \uparrow/\downarrow y, a continuación, pulse EXEC.

Puede seleccionar cualquier año hasta 2079.

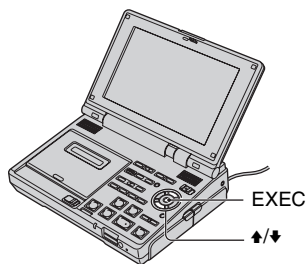

GV-HD700/1:

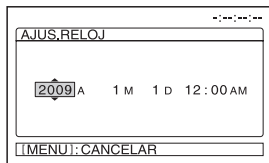

12:00 AM representa la medianoche.
12:00 PM representa el mediodía.

GV-HD700E/1:

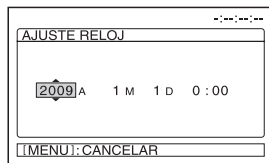

4 Defina los valores de [M] (mes), [D] (día), hora y minutos y, a continuación, pulse EXEC.

El reloj empezará a funcionar.

Procedimiento para apagar el equipo

Deslice el interruptor POWER a OFF (CHG).

Procedimiento para restablecer la fecha y la hora

Pulse MENU y seleccione OTROS (OTROS) \rightarrow [AJUSTE RELOJ], a continuación defina la hora y fecha.

Notas

- Si no utiliza la videograbadora por un período de **aproximadamente 3 meses**, la batería recargable incorporada se descargará y es posible que los ajustes de fecha y hora se borren de la memoria. En este caso, cargue la batería recargable incorporada y vuelva a configurar la fecha y la hora.
- Al encender la videograbadora, ésta tarda unos segundos en estar lista para grabar o reproducir un videocasete. Durante esta fase no es posible utilizar la videograbadora.

Configuración del idioma

Pulse MENU y seleccione OTROS (OTROS) \rightarrow [LANGUAGE], a continuación, seleccione el idioma deseado.

Paso 4: Procedimiento para insertar un videocasete o un "Memory Stick Duo"

Cinta de videocasete

Este equipo sólo admite videocasetes de formato mini DV ^{Mini} DV.

- 1 Deslice la palanca EJECT en la dirección que indica la flecha.



El compartimiento del videocasete se eleva y se abre de forma automática.

- 2 Introduzca un videocasete con su ventana hacia arriba.

Presione ligeramente el centro de la parte posterior del videocasete.

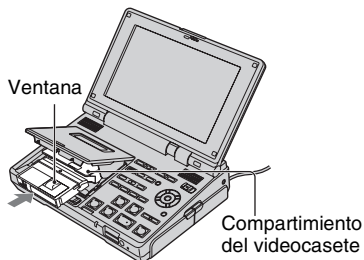

- 3 Para cerrar el compartimiento del videocasete, presione el indicador (PUSH) de la tapa del compartimiento.

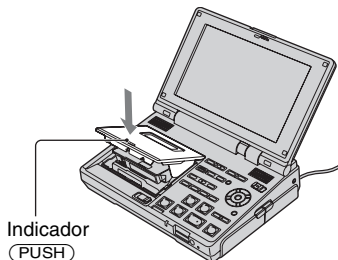

El compartimiento del videocasete se desliza automáticamente a su posición de cierre.

Notas

- No introduzca los dedos ni toque la parte interior del compartimiento del videocasete cuando esté abierto. Puede producir una avería.
- Si toca cualquier elemento de la videograbadora que no sea el indicador (PUSH) para cerrar el compartimiento del videocasete, es posible que éste no se cierre correctamente.
- No intente cerrar el compartimiento del videocasete hasta que éste no se haya abierto completamente. Puede producir una avería.

Sugerencias

- El tiempo de grabación varía en función del [MODO GRAB.DV]. (DV)

Expulsión del videocasete

Abra el compartimiento del videocasete siguiendo el mismo procedimiento descrito en el paso 1 y, a continuación, extraiga el videocasete.

“Memory Stick Duo”

Este equipo sólo admite el uso de “Memory Stick Duo” del tipo MEMORY STICK DUO o MEMORY STICK PRO DUO.

Introduzca el “Memory Stick Duo” en la ranura para Memory Stick Duo en la dirección adecuada hasta que se oiga un clic.



⚡ Notas

- Si introduce el “Memory Stick Duo” en la ranura en la dirección equivocada, es posible que el “Memory Stick Duo”, la ranura para Memory Stick Duo o los datos de las imágenes resulten dañados.

Extracción del “Memory Stick Duo”

Presione ligeramente el “Memory Stick Duo” una vez.

⚡ Notas

- Si el indicador de acceso se enciende o parpadea, significa que la videgrabadora está leyendo o grabando datos. Durante esta fase, no sacuda ni golpee la videgrabadora ni la apague, extraiga el “Memory Stick Duo” ni la batería. Si lo hace, los datos de imágenes pueden resultar dañados.

- Al insertar o extraer el “Memory Stick Duo”, tenga cuidado de que el “Memory Stick Duo” no se salga accidentalmente de la ranura y se caiga.

Reproducción con la videograbadora

Para reproducir películas, siga el procedimiento a continuación.

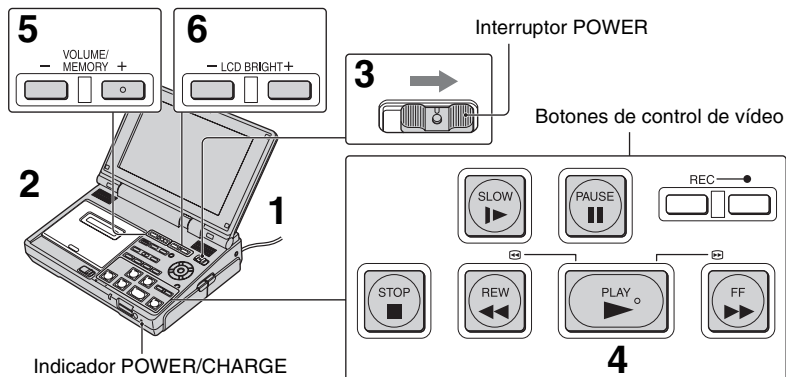

1 Prepare la fuente de energía.

2 Inserte una cinta de videocasete.

3 Pulse el botón verde y, sin soltarlo, deslice el interruptor POWER a ON.

El indicador POWER/CHARGE en la parte frontal se enciende de color verde.

4 Pulse PLAY ►.

La reproducción se inicia.

5 Ajuste el volumen con VOLUME/MEMORY (-/+).

6 Ajuste el brillo de la pantalla LCD con LCD BRIGHT (-/+).

⚙ Notas

- Si el videocasete que desea reproducir es de formato HDV o DV, la imagen y el sonido se interrumpen temporalmente mientras la señal alterna entre HDV y DV.
- Las cintas grabadas en formato HDV no se pueden reproducir con una videocámara que sólo sea compatible con el formato DV ni con un reproductor de mini DV.

💡 Sugerencias

- El brillo de la pantalla LCD también se puede ajustar mediante [AJUSTE PANT.] → [AJUSTE LCD] → [BRILLO].
- Ajustar el brillo de la pantalla LCD durante la grabación o reproducción no afecta en modo alguno a la imagen grabada original.
- Para reproducir una cinta grabada con otro equipo usando un micrófono monoaural externo, consulte [MULTISONIDO].
- Para utilizar auriculares (opcional), conéctelos a la toma [auriculares].

Detención de la reproducción

Pulse STOP ■.

Pausa en la reproducción

Pulse PAUSE **||** durante la reproducción. Para reanudar la reproducción, pulse PAUSE **||** o PLAY **▶**.

Sugerencias

- La reproducción se detiene automáticamente si la pausa permanece activada durante más de 3 minutos.

Avance rápido o rebobinado de la cinta

Para utilizar la función de avance rápido mientras la reproducción está detenida, pulse FF **▶▶**. Para utilizar la función de rebobinado mientras la reproducción está detenida, pulse REW **◀◀**.

Sugerencias

- Al utilizar las funciones de avance rápido o rebobinado, la imagen de la pantalla LCD se atenúa. No se trata de un fallo de funcionamiento.

Búsqueda de escenas durante la reproducción

Pulse FF **▶▶**/REW **◀◀** durante la reproducción (búsqueda de imágenes). Para ver una escena concreta durante el avance rápido, mantenga pulsado FF **▶▶**; para ver una escena concreta durante el rebobinado, mantenga pulsado REW **◀◀** (exploración con salto).

Reproducción lenta (cámara lenta)

Pulse SLOW **▶** durante la reproducción. Para reanudar la reproducción, pulse PLAY **▶**.

Notas

- Durante la pausa en la reproducción o en cualquier modo de reproducción distinto a la reproducción normal, no se emite ningún sonido y es posible que la imagen se quede estática en forma de mosaico.

- Durante la reproducción de imágenes grabadas en formato HDV tenga en cuenta que:

- Las imágenes grabadas en formato HDV no se emiten a través de la interfaz  HDV/DV (i.LINK) durante la pausa en la reproducción ni en ningún otro modo de reproducción distinto al modo normal.
- Es posible que las imágenes se vean distorsionadas durante la búsqueda de imágenes.

Utilización del mando a distancia

La videogradora se puede controlar con un mando a distancia. Los botones en el mando a distancia son equivalentes a los botones de control de la reproducción en la videogradora, sin embargo, algunas funciones sólo están disponibles a través del mando a distancia.

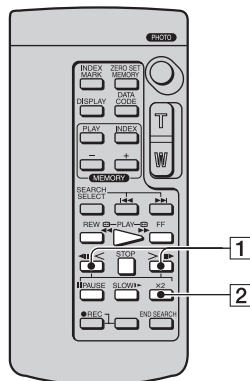

Cambio de la dirección de reproducción

Pulse ◀◀ < [1] durante la reproducción. Para disminuir la velocidad de reproducción cuando ésta se realiza en sentido inverso, pulse ◀◀ < [1] durante la reproducción y, a continuación, pulse SLOW ▶▶.

🔔 Sugerencias

- Al reproducir una cinta en sentido inverso, es posible que la pantalla muestre ruido horizontal en las partes superior e inferior. No se trata de un fallo de funcionamiento.

Procedimiento para ver una película fotograma por fotograma

Con la reproducción en modo de pausa, pulse > ||▶ (+) [1]. Para reproducir una película en modo de fotograma por fotograma durante la reproducción en modo inverso, pulse ◀◀ < (-) [1] con la reproducción en pausa.

Reproducción de una película al doble de la velocidad (reproducción en modo de doble velocidad) (DV)

Pulse ×2 [2] durante la reproducción. Para que la cinta se reproduzca al doble de la velocidad durante la reproducción inversa, pulse ◀◀ < [1] y, a continuación, pulse ×2 [2].

🔊 Notas

- Durante la pausa en la reproducción o en cualquier modo de reproducción distinto a la reproducción normal, no se emite ningún sonido y es posible que la imagen se quede estática en forma de mosaico.
- Durante la reproducción de imágenes grabadas en formato HDV tenga en cuenta que:
 - Ni la reproducción a cámara lenta en modo de reproducción inversa ni la reproducción de fotograma a fotograma son posibles.

- Las imágenes grabadas en formato HDV no se emiten a través de la interfaz i.LINK (i.LINK) durante la pausa en la reproducción ni en ningún otro modo de reproducción distinto al modo normal.
- Es posible que las imágenes se vean distorsionadas durante la reproducción en dirección inversa.
- Es posible que las imágenes se vean distorsionadas durante la búsqueda de imágenes.

Additional information on this product and answers to frequently asked questions can be found at our Customer Support Website.

<http://www.sony.net/>

Printed on 70% or more recycled paper
using VOC (Volatile Organic Compound)-
free vegetable oil based ink.

Printed in Japan



4 152362 110