

Home Theatre System

Operating Instructions

HT-SF1200
HT-SS1200

WARNING

To reduce the risk of fire or electric shock, do not expose this apparatus to rain or moisture.

To prevent fire, do not cover the ventilation of the apparatus with newspapers, table-cloths, curtains, etc. And don't place lighted candles on the apparatus.

To prevent fire or shock hazard, do not place objects filled with liquids, such as vases, on the apparatus. Batteries or batteries installed apparatus shall not be exposed to excessive heat such as sunshine, fire or the like.

Do not install the appliance in a confined space, such as a bookcase or built-in cabinet.

Install this system so that the power cord can be unplugged from the wall socket immediately in the event of trouble.

For customers in Europe

Disposal of Old Electrical & Electronic Equipment (Applicable in the European Union and other European countries with separate collection systems)



This symbol on the product or on its packaging indicates that this product shall not be treated as household waste. Instead it shall be handed over to the applicable collection point for the recycling of electrical and electronic equipment. By ensuring this product is disposed of correctly, you will help prevent potential negative consequences for the environment and human health, which could otherwise be caused by inappropriate waste handling of this product. The recycling of materials will help to conserve natural resources. For more detailed information about recycling of this product, please contact your local Civic Office, your household waste disposal service or the shop where you purchased the product.

The manufacturer of this product is Sony Corporation, 1-7-1 Konan Minato-ku Tokyo, 108-0075 Japan. The Authorized Representative for EMC and product safety is Sony Deutschland GmbH, Hedelfinger Strasse 61, 70327 Stuttgart, Germany. For any service or guarantee matters please refer to the addresses given in separate service or guarantee documents.

About This Manual

- The instructions in this manual are for model HT-SF1200 and HT-SS1200. In this manual, models of area code CEL is used for illustration purposes unless stated otherwise. Any difference in operation is clearly indicated in the text, for example, “Models of area code CEL only”.

The HT-SF1200 consists of:

- Receiver STR-KS1200
- Speaker system^{a)}
 - Front speakers SS-MSP2200
 - Center speaker SS-CNP2200
 - Surround speakers SS-SRP2200
 - Sub woofer SS-WP2200

The HT-SS1200 consists of:

- Receiver STR-KS1200
- Speaker system^{a)}
 - Front speakers SS-MSP1200
 - Center speaker SS-CNP1200
 - Surround speakers SS-SRP1200
 - Sub woofer SS-WP1200

^{a)} Be sure to use only the supplied speakers.

- The instructions in this manual describe the controls on the supplied remote. You can also use the controls on the receiver if they have the same or similar names as those on the remote.

About area codes

The area code of the receiver you purchased is shown on the lower portion of the rear panel (see the illustration below).

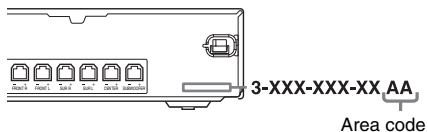

Any differences in operation, according to the area code, are clearly indicated in the text, for example, “Models of area code AA only”.

This receiver incorporates Dolby* Digital and Pro Logic Surround and the DTS** Digital Surround System.

- * Manufactured under license from Dolby Laboratories.
“Dolby”, “Pro Logic” and the double-D symbol are trademarks of Dolby Laboratories.
- ** “DTS” and “DTS Digital Surround” are registered trademarks of DTS, Inc.

This receiver incorporates High-Definition Multimedia Interface (HDMI™) technology. HDMI, the HDMI logo and High-Definition Multimedia Interface are trademarks or registered trademarks of HDMI Licensing LLC.

Note for the supplied remote

(RM-AAU017)

The VIDEO 3 button on the remote is not available for receiver operation.

Table of Contents

Getting Started

Description and location of parts.....	5
1: Installing speakers	11
2: Connecting speakers.....	14
3: Connecting the audio/video components.....	16
4: Connecting the antennas.....	21
5: Preparing the receiver and the remote	22
6: Calibrating the appropriate settings automatically (AUTO CALIBRATION)	23
7: Adjusting the speaker levels and balance (TEST TONE).....	28

Playback

Selecting a component.....	29
Listening/Watching a component.....	30

Amplifier Operations

Navigating through menus	32
Adjusting the level (LEVEL menu)	36
Adjusting the tone (TONE menu)	37
Settings for the surround sound (SUR menu).....	37
Settings for the tuner (TUNER menu).....	38
Settings for the audio (AUDIO menu)	38
Settings for the video (VIDEO menu).....	39
Settings for the system (SYSTEM menu) ..	40

Enjoying Surround Sound

Enjoying Dolby Digital and DTS Surround sound (AUTO FORMAT DIRECT).....	42
Selecting a pre-programmed sound field.....	44
Using only the front speakers and sub woofer (2CH STEREO)	46
Resetting sound fields to the initial settings.....	47

Tuner Operations

Listening to FM/AM radio.....	47
Presetting radio stations	49
Using the Radio Data System (RDS).....	50

Other Operations

Switching between digital and analog audio (IN MODE).....	52
Enjoying the DIGITAL MEDIA PORT (DMPORT)	53
Listening to digital sound from other inputs (DIGITAL ASSIGN)	55
Using the Sleep Timer	56

Using the Remote

Changing button assignments	57
-----------------------------------	----

Additional Information

Glossary	58
Precautions.....	59
Troubleshooting	60
Specifications.....	63
Index	66

Description and location of parts

Receiver

Front panel

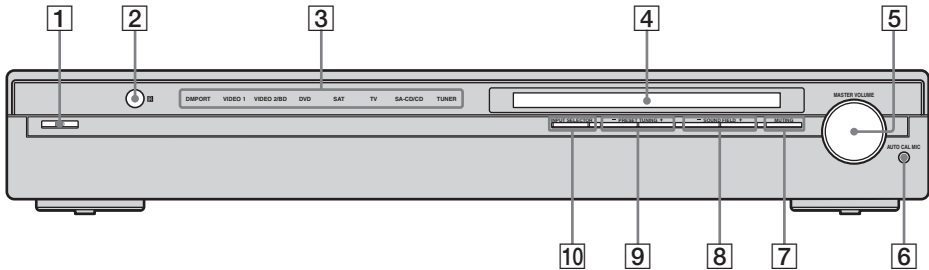

Name	Function
1 I/O (on/standby)	Press to turn the receiver on or off (page 22, 30, 31, 47).
2 Remote sensor	Receives signals from remote commander.
3 Input lamps	The lamp of the chosen input source lights up (page 29).
4 Display	The current status of the selected component or a list of selectable items appears here (page 6).
5 MASTER VOLUME	Turn to adjust the volume level of all speakers at the same time (page 28, 29, 30, 31).
6 AUTO CAL MIC jack	Connects to the supplied optimizer microphone for the Auto Calibration function (page 24).
7 MUTING	Press to mute the sound (page 29).
8 SOUND FIELD +/-	Press to select a sound field (page 42, 44, 46, 47).

Name	Function
9 PRESET TUNING +/-	Press to select a preset station (page 50).
10 INPUT SELECTOR	Press to select the input source to playback (page 29, 30, 31, 48, 49, 50, 60).

About the indicators on the display

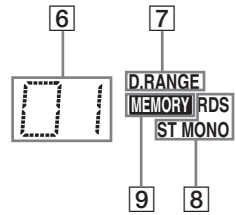
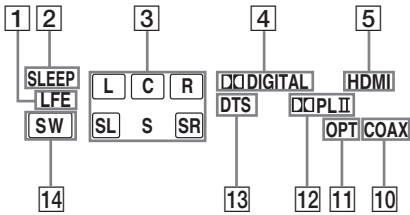

Name	Function
1 LFE	Lights up when the disc being played back contains an LFE (Low Frequency Effect) channel and the LFE channel signal is actually being reproduced.
2 SLEEP	Lights up when the sleep timer is activated (page 56).
3 Playback channel indicators	The letters (L, C, R, etc.) indicate the channels being played back. The boxes around the letters vary to show how the receiver downmixes the source sound. L Front Left R Front Right C Center (monaural) SL Surround Left SR Surround Right S Surround (monaural or the surround components obtained by Pro Logic processing) Example: Recording format (Front/ Surround): 3/2.1 Sound Field: A.F.D. AUTO
4 DIGITAL	Lights up when receiver is decoding Dolby Digital signals. Note When playing a Dolby Digital format disc, be sure that you have made digital connections.
5 HDMI	Lights up when a playback component is connected to this receiver using a HDMI jack (page 19).
6 Preset station indicators	Lights up when using the receiver to tune in radio stations you have preset. For details on presetting radio stations, see page 49.

Name	Function
7 D.RANGE	Lights up when dynamic range compression is activated (page 33).
8 Tuner indicators	Lights up when using the receiver to tune in radio stations (page 47), etc.
9 MEMORY	Lights up when a memory function, such as Preset Memory (page 49), etc., is activated.
10 COAX	Lights up when IN MODE is set to "AUTO IN" and the source signal is a digital signal being input through the COAX IN jack, or when IN MODE is set to "COAX IN" (page 52).
11 OPT	Lights up when IN MODE is set to "AUTO IN" and the source signal is a digital signal being input through the OPT IN jack, or when IN MODE is set to "OPT IN" (page 52).
12 DOLBY PL (II)	"DOLBY PL" lights up when the receiver applies Pro Logic processing to 2 channel signals in order to output the center and surround channel signals. "DOLBY PLII" lights up when the Pro Logic II Movie/Music decoder is activated.
13 DTS	Lights up when the receiver is decoding DTS signals. Note When playing a DTS format disc, be sure that you have made digital connections.
14 SW	Lights up when the audio signal is output from the SUBWOOFER jack.

Rear panel

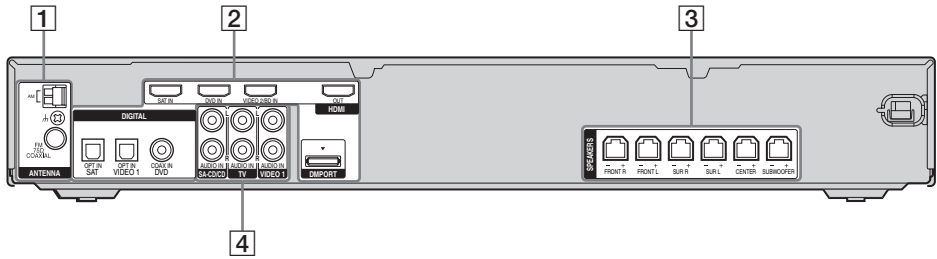

1 ANTENNA section



FM ANTENNA jack

Connects to the FM wire antenna supplied with this receiver (page 21).



AM ANTENNA terminals

Connects to the AM loop antenna supplied with this receiver (page 21).

2 DIGITAL INPUT/OUTPUT section



OPT IN jack

Connects to a DVD player, etc. The COAX IN jack



COAX IN jack

provides a better quality of loud sound (page 17).



HDMI IN/OUT jack

Connects to a DVD player or a satellite tuner. An image and the sound are output to a TV or a projector (page 19).



DMPORT jack

Connect to a DIGITAL MEDIA PORT adapter (page 53).

3 SPEAKERS section



Connects to speakers (page 14). The following table shows the respective color for the speaker jacks.

Speaker jack	Color
FRONT R (Front right speaker)	Red
FRONT L (Front left speaker)	White
SUR R (Surround right speaker)	Grey
SUR L (Surround left speaker)	Blue
CENTER (Center speaker)	Green
SUBWOOFER (Sub woofer)	Purple

4 AUDIO INPUT section



White (L) jack

Connects to a Super Audio CD player, CD player, etc. (page 16, 17).



Red (R) jack

Remote commander

You can operate the receiver with the supplied remote. You can also use the remote to control the Sony audio/video components that the remote is assigned to operate (page 57).



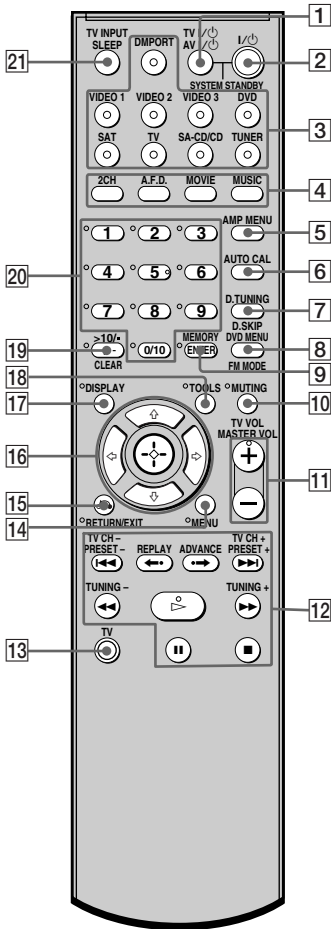







RM-AAU017





Name	Function
1 TV I/⏻ (on/standby)	Press TV I/⏻ and TV (13) at the same time to turn the TV on or off.
AV I/⏻ (on/standby)	Press to turn on or off the Sony audio/video components that the remote is assigned to operate. If you press I/⏻ (2) at the same time, it will turn off the receiver and other components (SYSTEM STANDBY). Note The function of the AV I/⏻ switch changes automatically each time you press the input buttons (3).
2 I/⏻ (on/standby)	Press to turn the receiver on or off. To turn off all components, press I/⏻ and AV I/⏻ (1) at the same time (SYSTEM STANDBY).
3 Input buttons	Press one of the buttons to select the component you want to use. When you press any of the input buttons, the receiver turns on. The buttons are factory assigned to control Sony components as follows. You can change the button assignment following the steps in “Changing button assignments” on page 57.
Button	Assigned Sony component
VIDEO 1	VCR (VTR mode 3)
VIDEO 2	VCR (VTR mode 2)
VIDEO 3	Not assigned
DVD	DVD player
SAT	Digital Satellite Receiver
TV	TV
SA-CD/CD	Super Audio CD/ CD player
TUNER	Built-in tuner
DMPORT	DIGITAL MEDIA PORT adapter

Name	Function
4 MOVIE	Press to select sound fields (MOVIE).
MUSIC	Press to select sound fields (MUSIC).
A.F.D.	Press to select A.F.D. mode.
2CH	Press to select 2CH STEREO mode.
5 AMP MENU	Press to display the menu of the receiver. Then, use \uparrow , \downarrow , \leftarrow , \rightarrow and \odot (16) to perform menu operations.
6 AUTO CAL	Press to activate the Auto Calibration function (page 25).
7 D.TUNING	Press to enter direct tuning mode.
D.SKIP	Press to skip a disc when using a multi-disc changer.
8 DVD MENU	Press to display the menu of the DVD player on the TV screen. Then, use \uparrow , \downarrow , \leftarrow , \rightarrow and \odot (16) to perform menu operations.
FM MODE	Press to select the FM monaural or stereo reception.
9 ENTER	Press to enter the value after selecting a channel, disc or track using the numeric buttons of the TV, VCR or satellite tuner.
MEMORY	Press to store a station.
10 MUTING	Press to activate the muting function. Press MUTING and TV (13) at the same time to activate the TV's muting function.
11 TV VOL +^a/-	Press TV VOL +/- and TV (13) at the same time to adjust the TV volume level.
MASTER VOL +^a/-	Press to adjust the volume level of all speakers at the same time.

Name	Function
12 TV CH +/-	Press TV CH +/- and TV (13) at the same time to select preset TV channels.
PRESET +/-	Press to select – preset stations. – preset channels of the VCR or satellite tuner.
◀◀/▶▶^b	Press to skip a track of the CD player, DVD player or Blu-ray disc player.
REPLAY ◀-/ ADVANCE ▶→	Press to replay the previous scene or fast forward the current scene of the VCR, DVD player or Blu-ray disc player.
◀◀/▶▶^b	Press to – search tracks in the forward/reverse direction of the DVD player. – start fast forward/rewind of the VCR, CD player or Blu-ray disc player.
TUNING +/-	Press to scan a station.
▷^ab	Press to start playback of the VCR, CD player, DVD player or Blu-ray disc player.
 ^b	Press to pause playback or recording of the VCR, CD player, DVD player or Blu-ray disc player. (Also starts recording with components in recording standby.)
■^b	Press to stop playback of the VCR, CD player, DVD player or Blu-ray disc player.
13 TV	Press TV and the button you want at the same time to activate the buttons with orange printing.
14 MENU	Press to display the menu of the VCR, DVD player, satellite tuner or Blu-ray disc player on the TV screen. Press MENU and TV (13) at the same time to display the TV's menu. Then, use \uparrow , \downarrow , \leftarrow , \rightarrow and \odot (16) to perform menu operations.

Name	Function
15 RETURN/ EXIT 	Press to – return to the previous menu. – exit the menu while the menu or on-screen guide of the VCR, DVD player, satellite tuner or Blu-ray disc player is displayed on the TV screen. Press RETURN/EXIT  and TV (13) at the same time to return to the previous menu or exit the TV's menu while the menu is displayed on the TV screen.
16  , 	After pressing AMP MENU (5), DVD MENU (8), or MENU (14), press  ,  ,  or  to select the settings. Then, press  to enter the selection for DVD MENU or MENU. Press  also to enter the selection of the receiver, VCR, satellite tuner, CD player, DVD player or Blu-ray disc player.
17 DISPLAY	Press to select information displayed on the TV screen of the VCR, satellite tuner, CD player, DVD player or Blu-ray disc player. Press DISPLAY and TV (13) at the same time to select TV information displayed on the TV screen.
18 TOOLS	Press to display options applicable to the entire disc (e.g. disc protection), recorder (e.g. audio settings during recording), or multiple items on a list menu (e.g. erasing multiple titles). Press TOOLS and TV (13) at the same time to display options applicable to the TV.

Name	Function
19 >10/ 	Press to select – track numbers over 10 of the VCR, satellite tuner or CD player. – channel numbers of the Digital CATV terminal.
-/--	Press -/-- and TV (13) at the same time to select the channel entry mode, either one or two digits of the TV.
CLEAR	Press to clear a mistake when you press the incorrect numeric button.
20 Numeric buttons (number 5 ^{a)})	Press to – preset/tune to preset stations. – select track numbers of the CD player, DVD player or Blu-ray disc player. Press 0/10 to select track number 10. – select channel numbers of the VCR or satellite tuner. Press the numeric buttons and TV (13) at the same time to select the TV channels.
21 TV INPUT	Press TV INPUT and TV (13) at the same time to select the input signal (TV input or video input).
SLEEP	Press to activate the Sleep Timer function and the duration which the receiver turns off automatically.

^{a)}The number 5, MASTER VOL +, TV VOL + and  buttons have tactile dots. Use the tactile dots as references when operating the receiver.

^{b)}This button is also available for DIGITAL MEDIA PORT adapter operation. For details on the function of the button, see the operating instructions supplied with the DIGITAL MEDIA PORT adapter.

Notes

- The VIDEO 3 button on the remote is not available for receiver operation.
- Some functions explained in this section may not work depending on the model.
- The above explanation is intended to serve as an example only. Therefore, depending on the component, the above operation may not be possible or may operate differently than described.

1: Installing speakers

This receiver allows you to use a 5.1 channel speaker system. To fully enjoy theater-like multi channel surround sound requires five speakers (two front speakers, a center speaker, and two surround speakers) and a sub woofer (5.1 channel).

HT-SF1200 only

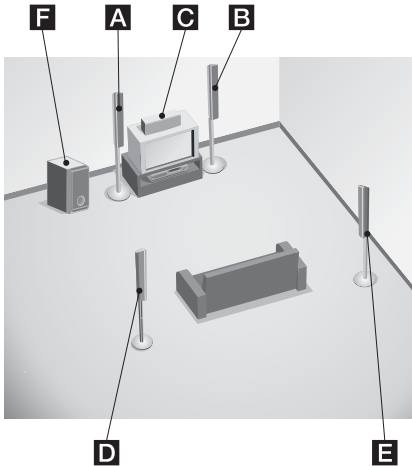

- A** Front speaker (Left)
- B** Front speaker (Right)
- C** Center speaker
- D** Surround speaker (Left)
- E** Surround speaker (Right)
- F** Sub woofer

HT-SS1200 only

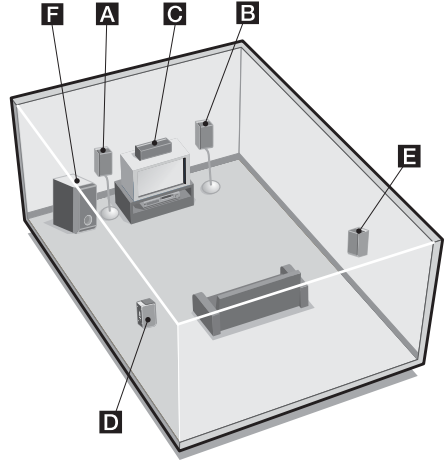

- A** Front speaker (Left)
- B** Front speaker (Right)
- C** Center speaker
- D** Surround speaker (Left)
- E** Surround speaker (Right)
- F** Sub woofer

Tip

Since the sub woofer does not emit highly directional signals, you can place it wherever you want.

Installing the speakers on a flat surface

Before you install the speaker and sub woofer, be sure to attach the supplied foot pads to prevent vibration or movement as shown in the illustration below.

Example of HT-SS1200 front speaker

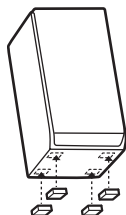

HT-SF1200 only

You need to attach the supplied foot pads to the center speaker and sub woofer only.

HT-SS1200 only

You need to attach the supplied foot pads to all the speakers and sub woofer.

Installing the speakers on the speaker stand

HT-SS1200 only

For greater flexibility in positioning the speakers, use the optional WS-FV11 or WS-FV10D speaker stand (available only in certain countries). Be sure to detach the screw from the speaker and use it when you install the speaker to the speaker stand. For details, refer to operating instructions supplied with the speaker stand.

HT-SF1200 only

For greater flexibility in positioning the speakers, use the supplied speaker stand. For details, refer to supplied speaker stand installation guide.

Installing the speakers on the wall

You can install your speakers on the wall.

- 1 Prepare screws (not supplied) that are suitable for the hook on the back of each speaker. See the illustrations below.**

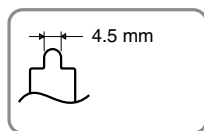
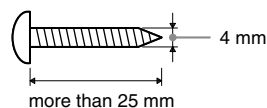

Hook on the back of the speaker

- 2 Fasten the screws to the wall. The screws should protrude 5 to 7 mm.**

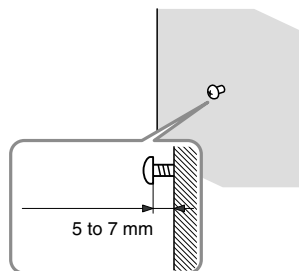

- 3 Hang the speakers on the screws.**

Example of installing the speakers on the wall

Hook on the back of the speaker

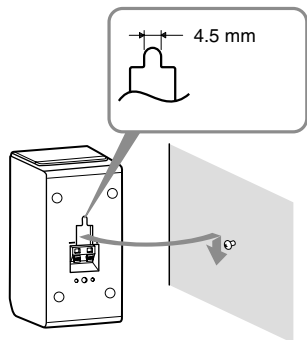

Notes

- Use screws that are suitable for the wall material and strength. As a plaster board wall is especially fragile, attach the screws securely to a beam and fasten them to the wall. Install the speakers on a vertical and flat wall where reinforcement is applied.
- Contact a screw shop or installer regarding the wall material or screws to be used.
- Sony is not responsible for accident or damage caused by improper installation, insufficient wall strength or improper screw installation, natural calamity, etc.
- For HT-SF1200, if you install the speakers on the wall, you do not need to attach the supplied speaker stand.

2: Connecting speakers

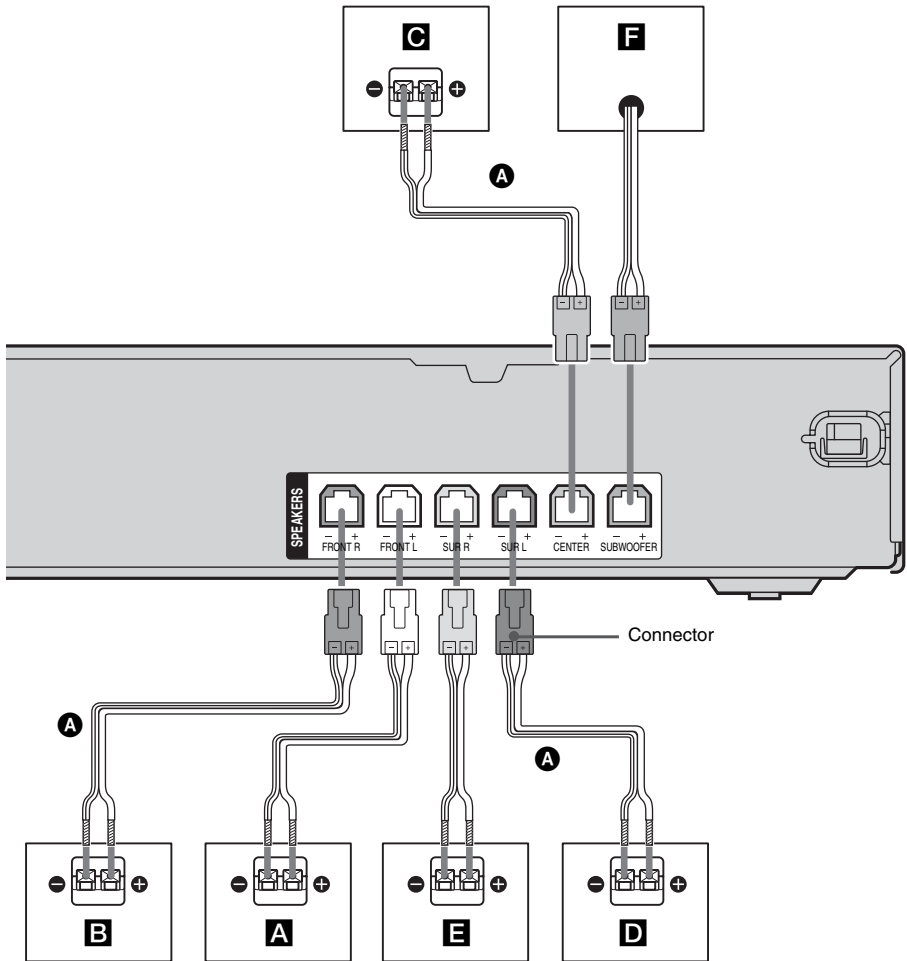

A Speaker cord (supplied)

- A** Front speaker (Left)
- B** Front speaker (Right)
- C** Center speaker
- D** Surround speaker (Left)
- E** Surround speaker (Right)
- F** Sub woofer

Note on speaker cords

The connector of the speaker cords are the same color as the speaker jack to be connected. When connecting a speaker cord, be sure to match the colored connector to the speaker jack on the receiver:

Connector	Speaker jack
Red	FRONT R
White	FRONT L
Grey	SUR R
Blue	SUR L
Green	CENTER
Purple	SUBWOOFER

Note on speakers

To connect the speakers correctly, be sure to check the type of speakers by referring to the speaker label* at the rear panel or bottom of the speakers.

Character on speaker label	Speaker type
L	Front left
R	Front right
SL	Surround left
SR	Surround right

* The center speaker and sub woofer do not have the character on the speaker label. For details on the speaker type, see page 3.

3: Connecting the audio/video components

How to hook up your components

This section describes how to hook up your components to this receiver. Before you begin, refer to “Component to be connected” below for the pages which describe how to connect the audio/video components.

After hooking up all your components, proceed to “4: Connecting the antennas” (page 21).

Component to be connected

To connect	See
Audio components <ul style="list-style-type: none">• Super Audio CD player/CD player	page 16
Video components <ul style="list-style-type: none">• DVD player/DVD recorder• Blu-ray disc player• Satellite tuner/Set-top box• VCR• TV	page 17
Components with HDMI jack	page 19

Connecting audio components

The following illustration shows how to connect audio components such as Super Audio CD player or CD player.

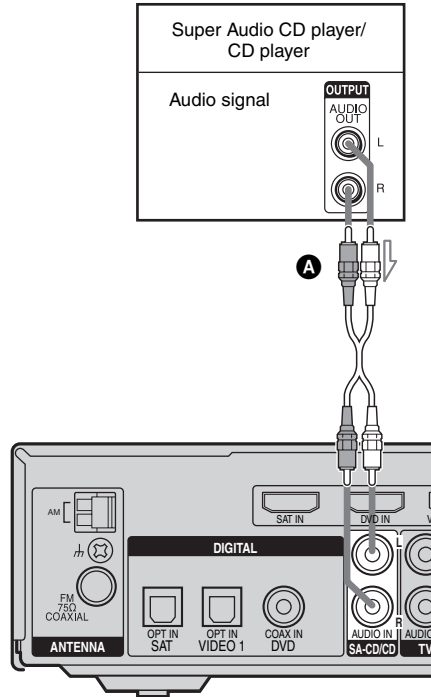

A Audio cord (not supplied)

Connecting video components

The following illustration shows how to connect video components such as DVD player, DVD recorder, satellite tuner or VCR.

If you connect a DVD recorder

Be sure to change the factory setting of the DVD input button on the remote so that you can use the button to control your DVD recorder. For details, see “Changing button assignments” (page 57).

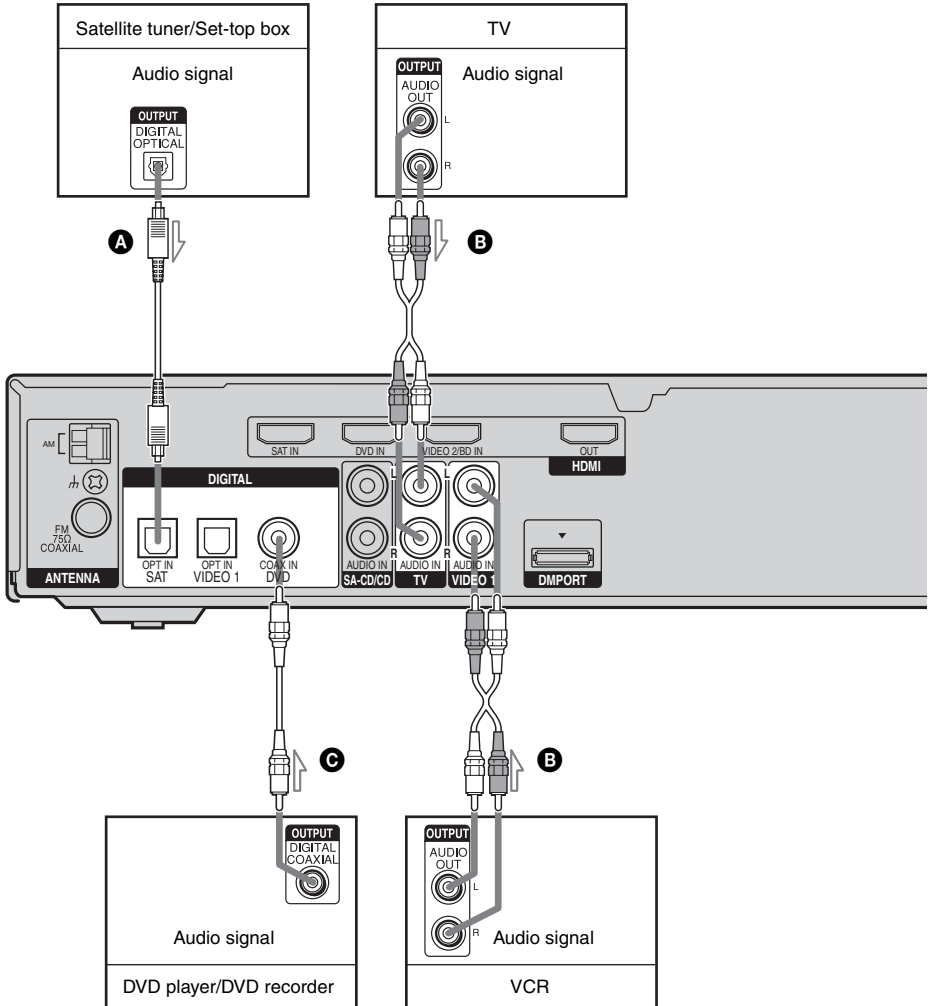

- A** Optical digital cord (not supplied)
- B** Audio cord (not supplied)
- C** Coaxial digital cord (supplied)

Notes

- You cannot do recording on the DVD recorder or VCR via this receiver. For details, refer to the operating instructions supplied with the DVD recorder or VCR.
- To input multi channel digital audio from the DVD player, set the digital audio output setting on the DVD player. Refer to the operating instructions supplied with the DVD player.
- As this receiver does not have analog audio input jack for DVD, connect your DVD player to the DIGITAL COAX IN DVD jack on the receiver. To output sound from the front left/right speakers and sub woofer only, press 2CH.
- When connecting optical digital cords, insert the plugs straight in until they click into place.
- Do not bend or tie optical digital cords.

Tip

All the digital audio jacks are compatible with 32 kHz, 44.1 kHz, 48 kHz, and 96 kHz sampling frequencies.

Connecting components with HDMI jacks

HDMI is the abbreviated name for High-Definition Multimedia Interface. It is an interface which transmits video and audio signals in digital format.

HDMI feature

A digital audio signals transmitted by HDMI can be output from the speakers connected to the receiver. This signal supports Dolby Digital, DTS and linear PCM.

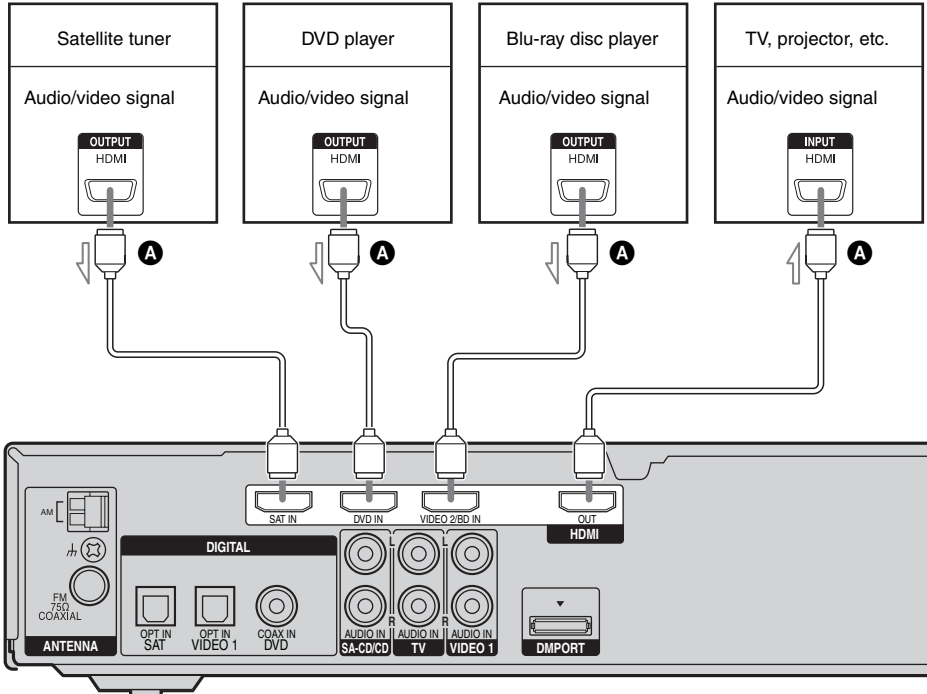

A HDMI cable (not supplied)

We recommend that you use a Sony HDMI cable.

If you connect a Blu-ray disc player

Be sure to change the factory setting of the VIDEO 2 input button on the remote so that you can use the button to control your Blu-ray disc player. For details, see “Changing button assignments” (page 57).

Notes on HDMI connections

- Use a HDMI cable with the HDMI logo (made by Sony).
- An audio signal input to the HDMI IN jack is output from the SPEAKERS jacks and HDMI OUT jack. It is not output from any other audio jacks.
- Video signals input to the HDMI IN jack can only be output from the HDMI OUT jack.
- When you want to listen to the sound from the TV speaker, set “AUDIO” to “TV+AMP” in the VIDEO menu (page 39). If you cannot play back multi channel software, set to “AMP”. However, the sound will not output from the TV speaker.
- The multi/stereo area audio signals of a Super Audio CD are not output.
- Be sure to turn on the receiver when the video and audio of a playback component are being output to a TV via the receiver. If the power supply of the receiver is not turned on, neither video nor audio is transmitted.
- Audio signals (sampling frequency, bit length, etc.) transmitted from a HDMI jack may be suppressed by the connected component. Check the setup of the connected component if the image is poor or the sound does not come out of a component connected via the HDMI cable.
- Sound may be interrupted when the sampling frequency or the number of channels of audio output signals from the playback component is switched.

- When the connected component is not compatible with copyright protection technology (HDCP), the image and/or the sound from the HDMI OUT jack may be distorted or may not be output. In this case, check the specification of the connected component.
- Set the resolution of the image of the playback component to 720p or 1080i when you output 96 kHz multi channel sound over a HDMI connection.
- We do not recommend using a HDMI-DVI conversion cable. When you connect a HDMI-DVI conversion cable to a DVI-D component, the sound and/or the image may not be output.
- For details on HDMI setup of the connected component, refer to the operating instructions supplied with the connected component.

4: Connecting the antennas

Connect the supplied AM loop antenna and FM wire antenna.

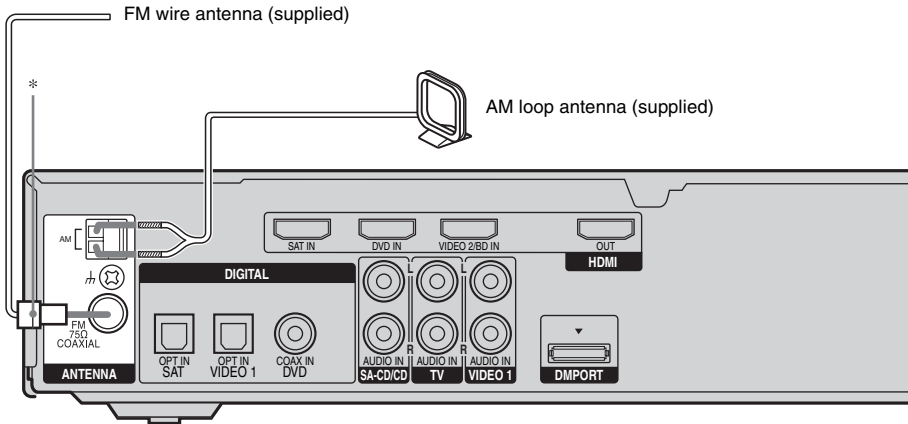

* The shape of the connector varies depending on the area code of this receiver.

Notes

- To prevent noise pickup, keep the AM loop antenna away from the receiver and other components.
- Be sure to fully extend the FM wire antenna.
- After connecting the FM wire antenna, keep it as horizontal as possible.

5: Preparing the receiver and the remote

Connecting the AC power cord

Connect the AC power cord to a wall outlet.

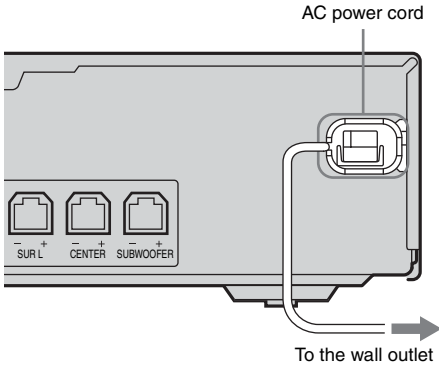

Performing initial setup operations

Before using the receiver for the first time, initialize the receiver by performing the following procedure. This procedure can also be used to return settings you have made to their factory defaults.

Be sure to use the buttons on the receiver for this operation.

1,2



1 Press I/⏻ to turn off the receiver.

2 Hold down I/⏻ for 5 seconds.

“CLEARING” appears on the display for a while, then “CLEARED” appears.

The following items are reset to their factory settings.

- All settings in the LEVEL, TONE, SUR, TUNER, AUDIO, VIDEO, SYSTEM and A. CAL menus.
- The sound field memorized for each input and preset station.
- All sound field parameters.
- All preset stations.
- MASTER VOLUME is set to “VOL MIN”.
- Input is set to “DVD”.

Inserting batteries into the remote

Insert two R6 (size-AA) batteries in the RM-AAU017 remote commander. Observe the correct polarity when installing batteries.

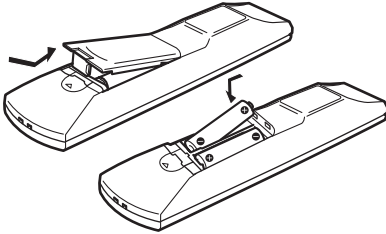

Notes

- Do not leave the remote in an extremely hot or humid place.
- Do not use a new battery with old ones.
- Do not mix alkaline batteries and other kinds of batteries.
- Do not expose the remote sensor to direct sunlight or lighting apparatuses. Doing so may cause a malfunction.
- If you do not intend to use the remote for an extended period of time, remove the batteries to avoid possible damage from battery leakage and corrosion.
- When you replace the batteries, the remote buttons may be reset to their factory settings. If this happens, reassign the buttons again (page 57).

Tip

Under normal conditions, the batteries should last for about 3 months. When the remote no longer operates the receiver, replace all the batteries with new ones.

6: Calibrating the appropriate settings automatically (AUTO CALIBRATION)

This receiver is equipped with DCAC (Digital Cinema Auto Calibration) Technology which allows you to perform automatic calibration as follows:

- Check the connection between each speaker and the receiver.
- Adjust the speaker level.
- Measure the distance of each speaker to your listening position.
- Measure the speaker polarity.
- Measure the frequency characteristics.*

* The measurement result is not utilized for signals with a sampling frequency of more than 96 kHz.

The DCAC is designed to obtain proper sound balance in your room. However, you can adjust the speaker levels and balance manually according to your preference. For details, see “7: Adjusting the speaker levels and balance (TEST TONE)” (page 28).

Before you perform Auto Calibration

Before you perform the Auto Calibration, set up and connect the speakers (page 11, 14).

- The AUTO CAL MIC jack is used for the supplied optimizer microphone only. Do not connect other microphones to this jack. Doing so may damage the receiver and the microphone.
- During the calibration, the sound that comes out of the speakers is very loud. Pay attention to the presence of children or to the effect on your neighborhood.
- Perform the Auto Calibration in a quiet environment to avoid the effect of noise and to get a more accurate measurement.
- If there are any obstacles in the path between the optimizer microphone and the speakers, the calibration cannot be performed correctly. Remove any obstacles from the measurement area to avoid measurement error.

Note

If the Muting function is on when we perform Auto Calibration, it will turn off automatically.

Example: HT-SS1200

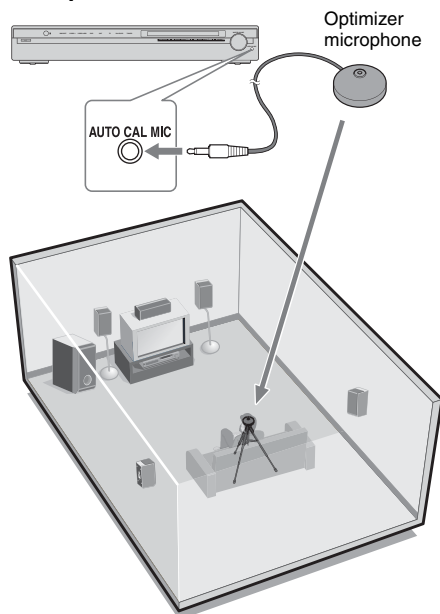

1 Connect the supplied optimizer microphone to the AUTO CAL MIC jack on the front panel.

2 Set up the optimizer microphone.

Place the optimizer microphone at your listening position. You can also use a stool or tripod so that the optimizer microphone remains at the same height as your ears.

Tip

When you face the speaker towards the optimizer microphone, you will get a more accurate measurement.

Performing Auto Calibration

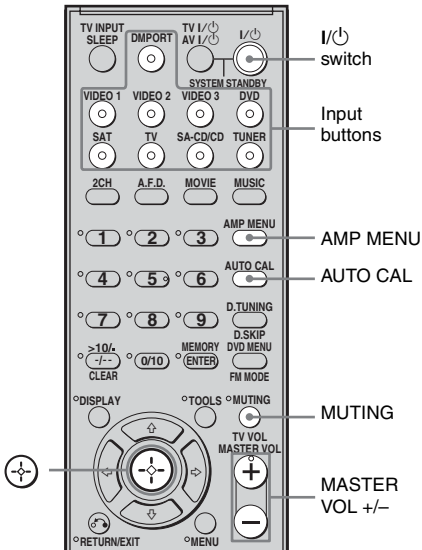

Press AMP MENU, then press AUTO CAL.

You can also select “A.CAL YES” in the A. CAL menu.

The following appears on the display.
A.CAL [5] → A.CAL [4] → A.CAL [3] →
A.CAL [2] → A.CAL [1]

The measurement process will take approximately 30 seconds to complete. The table below shows the display when measurement starts.

Measurement for	Display
Speaker existance	TONE
Speaker gain, distance, frequency response	T.S.P.
Sub woofer gain and distance	WOOFER

Note

You cannot measure the speaker height of the surround speakers. Set this value using “SUR POS.” parameters in the SYSTEM menu (page 34).

Tip

When Auto Calibration starts:

- Stand some distance from the speakers and the listening position to avoid measurement failure. This is because test signals are output from the speakers during measurement.
- Avoid making noise to get a more accurate measurement.

To cancel Auto Calibration

The Auto Calibration function will be canceled when you do the following during the measurement process:

- Press I/⏻ or MUTING.
- Press input buttons on the remote or INPUT SELECTOR on the receiver.
- Change the volume level.
- Press AUTO CAL again.

Confirming/saving the measurement results

1 Confirm the measurement result.

When the measurement ends, a beep sounds and the measurement result appears on the display.

Measurement result	Display	Explanation
When the measurement process completes properly	SAVE	Proceed to step 2.
When the measurement process fails	ERROR XXXX	See “When error codes appear” (page 26).

2 Press \uparrow/\downarrow repeatedly to select the item. Then, press \oplus .

Item	Explanation
RETRY	Performs the Auto Calibration again.
SAVE	Saves the measurement results and exits the setting process.
WARN CHK	Displays warning concerning the measurement results. See “When you select “WARN CHK”” (page 26).
PHASE	Displays the phase of each speaker (in phase/out of phase). See “When you select “PHASE”” (page 27).
DISTANCE	Displays the measurement result for speaker distance.
LEVEL	Displays the measurement result for speaker level.
EXIT	Exits the setting process without saving the measurement results.

3 Save the measurement result.

Select “SAVE” in step 2.

The measurement results are saved.

When error codes appear

Try the remedies and perform the Auto Calibration again.

Error code	Cause and remedies
ERROR 32	None of the speakers were detected. Make sure that the optimizer microphone is connected properly and perform the Auto Calibration again. If the optimizer microphone is connected properly but the error code appears, the optimizer microphone cable may be damaged or improperly connected.
ERROR F 33	<ul style="list-style-type: none"> None of the front speakers are connected or only one front speaker is connected. The optimizer microphone is not connected.

Error code	Cause and remedies
ERROR SR 33	Either the left or right surround speakers is not connected.
ERROR SW 33	Sub woofer is not connected. Connect the sub woofer to the SUBWOOFER terminal.
ERROR 33	Wrong speaker detection due to noise. Make sure the environment is quiet during Auto Calibration.

To rectify the error

- 1 Record down the error code.
- 2 Press \oplus , “RETRY Y” appears on the display.
- 3 Rectify the error.
For details, see “When error codes appear” above.
- 4 Press \oplus to perform Auto Calibration again.

When you select “WARN CHK”

If a warning on the measurement result is present, detailed information is displayed.

Press \oplus to return to step 2 of “Confirming/saving the measurement results”.

Warning code	Explanation
WARN 40	The Auto Calibration has completed. However, the noise level is high. You may be able to perform the Auto Calibration properly if you try it again, even though the measurement cannot be performed in all environments. Try to perform the Auto Calibration in a quiet environment.
WARN 41	The sound input from the optimizer microphone is out of the acceptable range. It is louder than the loudest sound that can be measured. Try to perform the Auto Calibration when the environment is quiet enough to allow proper measurement.

Warning code	Explanation
WARN 42	The volume of the receiver is out of the acceptable range. Try to perform the Auto Calibration when the environment is quiet enough to allow proper measurement.
WARN 43	The distance and position of a sub woofer cannot be detected. This may be caused by noise. Try to perform the Auto Calibration in a quiet environment.
NO WARN	There is no warning information.

When you select “PHASE”

You can check the phase of each speaker (in phase/out of phase).

Press \uparrow/\downarrow repeatedly to select a speaker, then press \oplus to return to step 2 in “Confirming/saving the measurement results”.

Display	Explanation
■ ■ * IN	The speaker is in phase.
■ ■ * OUT	The speaker is out of phase. The “+” and “-” terminals of the speaker may be connected the other way around.

* ■ ■ represent a speaker channel

FL	Front left
FR	Front right
C	Center
SL	Surround left
SR	Surround right
SW	Sub woofer

Tip

Depending on the position of the sub woofer, the measurement results for polarity may vary. However, there will be no problems even if you continue to use the receiver with that value.

After you have finished

Disconnect the optimizer microphone from the receiver.

Note

If you have changed the position of the speakers, it is recommended you to perform Auto Calibration again in order to enjoy the surround sound.

A. CAL menu parameters

You can use the A. CAL menu to make settings for the Auto Calibration function to suit your preference.

Select “8-A. CAL” in the amplifier menus. For details on adjusting the parameters, see “Navigating through menus” (page 32) and “Overview of the menus” (page 33).

■ AUTO CAL (Auto Calibration on/off)

- A.CAL NO
The Auto Calibration function is turned off.
- A.CAL YES
The Auto Calibration function start.

■ CAL LOAD (Calibration load)*

- LOAD YES
Select this when you want to load the saved Auto Calibration result.
- LOAD NO
Select this when you do not want to load the saved Auto Calibration result.

* You can select this parameter only when you have performed the Auto Calibration and saved the settings.

7: Adjusting the speaker levels and balance (TEST TONE)

You can adjust the speaker levels and balance while listening to the test tone from your listening position.

Tip

The receiver employs a test tone with a frequency centered at 800 Hz.

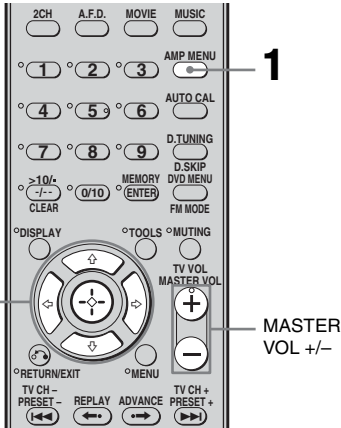

5 Press \uparrow/\downarrow repeatedly to select “T. TONE Y”.

The test tone is output from each speaker in sequence as follows:

Front left \rightarrow Center \rightarrow Front right \rightarrow
Surround right \rightarrow Surround left \rightarrow
Sub woofer

6 Adjust the speaker levels and balance using the LEVEL menu so that the level of the test tone sounds the same from each speaker.

For details, see “Adjusting the level (LEVEL menu)” (page 36).

Tips

- To adjust the level of all speakers at the same time, press MASTER VOL +/- . You can also use MASTER VOLUME on the receiver.
- The adjusted value are shown on the display during adjustment.

To turn off the test tone

Repeat steps 1 to 5 above. Then, select “T. TONE N” in step 5.

1 Press AMP MENU.

“1-LEVEL” appears on the display.

2 Press $\left(\begin{smallmatrix} \uparrow \\ \downarrow \\ \leftarrow \\ \rightarrow \end{smallmatrix}\right)$ or \rightarrow to enter the menu.

3 Press \uparrow/\downarrow repeatedly to select “T. TONE”.

4 Press $\left(\begin{smallmatrix} \uparrow \\ \downarrow \\ \leftarrow \\ \rightarrow \end{smallmatrix}\right)$ or \rightarrow to enter the parameter.

Selecting a component

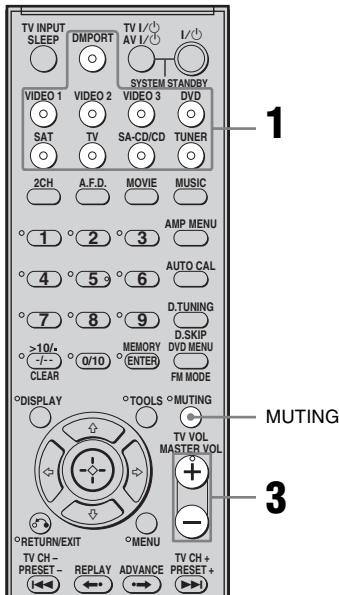

1 Press the input button to select a component.

You can also use INPUT SELECTOR on the receiver.

The selected input appears on the display.

Selected input [Display]	Components that can be played back
DMPORT [DMPORT]	DIGITAL MEDIA PORT adapter connected to DMPORT jack
VIDEO 1 [VIDEO 1]	VCR, etc., connected to the VIDEO 1 jack
VIDEO 2 [VIDEO 2/BD]*	Blu-ray disc player, etc., connected to the VIDEO 2/BD jack
DVD [DVD]	DVD player, etc., connected to DVD jack
SAT [SAT]	Satellite tuner, set-top box, etc., connected to SAT jack
TV [TV]	TV, etc., connected to TV jack
SA-CD/CD [SA-CD/CD]	Super Audio CD/CD player, etc., connected to the SA-CD/CD jack
TUNER [FM or AM band]	Built-in radio tuner

* "VIDEO 2/BD" scrolls across the display, then "VIDEO 2" appears.

2 Turn on the component and start playback.

3 Press MASTER VOL +/- to adjust the volume.

You can also use MASTER VOLUME on the receiver.

To mute the sound

Press MUTING.

The muting function will be canceled when you do the following.

- Press MUTING again.
- Increase the volume.
- Turn off the receiver.

To avoid damaging your speakers

Before you turn off the receiver, be sure to turn down the volume level.

Listening/Watching a component

Listening to a Super Audio CD/CD

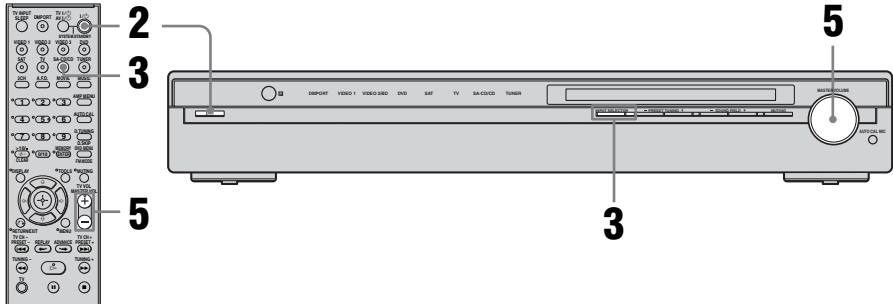

Notes

- The operation is described for a Sony Super Audio CD player.
- Refer to the operating instructions supplied with the Super Audio CD player or CD player.

Tips

- You can select the sound field to suit the music. Refer to page 44 for details.
Recommended sound fields:
Classical: HALL
Jazz: JAZZ
Live concert: CONCERT
- You can listen to the sound that was recorded in the 2 channel format from all speakers (multi channel). Refer to page 42 for details.

1 Turn on the Super Audio CD player/CD player, then place the disc on the tray.

2 Turn on the receiver.

3 Press SA-CD/CD.

You can also use INPUT SELECTOR on the receiver to select "SA-CD/CD".

4 Playback the disc.

5 Adjust to a suitable volume.

6 After you have finished listening to the Super Audio CD/CD, eject the disc and turn off the receiver and Super Audio CD player/CD player.

Watching a DVD

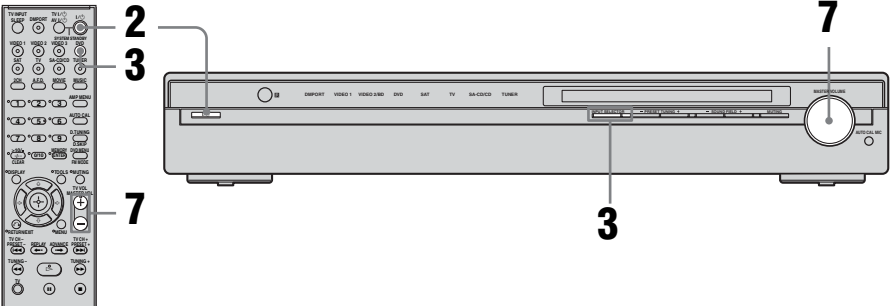

Notes

- Refer to the operating instructions supplied with the TV and DVD player.
- Check the following if you cannot listen to multi channel sound.
 - Be sure this receiver is connected to the DVD player via a digital connection.
 - Be sure the digital audio output of the DVD player is set up properly.

Tips

- Select the audio format of the disc to be played, if necessary.
- You can select the sound field to suit the movie/music. Refer to page 44 for details.
Recommended sound fields:
Movie: C.ST.EX
Music: CONCERT

1 Turn on the TV and DVD player.

2 Turn on the receiver.

3 Press DVD.

You can also use INPUT SELECTOR on this receiver to select “DVD”.

4 Switch the input of the TV so that an image of the DVD is displayed.

If no image is displayed on the TV screen, make sure that the video output of the DVD player is connected to the TV.

5 Set up the DVD player.

Refer to “Quick Setup Guide” supplied with the receiver.

6 Playback the disc.

7 Adjust to a suitable volume.

8 After you have finished watching the DVD, eject the disc and turn off the receiver, TV and DVD player.

Amplifier Operations

Navigating through menus

By using the amplifier menus, you can make various adjustments to customize the receiver.

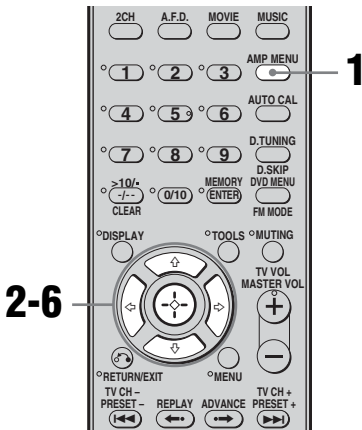

To return to the previous display



Press ←.

To exit the menu

Press AMP MENU.

Note

Some parameters and settings may appear dimmed on the display. This means that they are either unavailable or fixed and unchangeable.

- 1 Press AMP MENU.**
“1-LEVEL” appears on the display.
- 2 Press ↑/↓ repeatedly to select the menu you want.**
- 3 Press  or → to enter the menu.**
- 4 Press ↑/↓ repeatedly to select the parameter you want to adjust.**
- 5 Press  or → to enter the parameter.**
- 6 Press ↑/↓ repeatedly to select the setting you want.**
The setting is entered automatically.

Overview of the menus

The following options are available in each menu. For details on navigating through menus, see page 32.

Menu [Display]	Parameters [Display]	Settings	Initial setting
LEVEL [1-LEVEL] (page 36)	Test tone ^{a)} [T. TONE]	T. TONE Y, T. TONE N	T. TONE N
	Front speaker balance ^{a)} [FRT BAL]	BAL. L +1 to BAL. L +10, BALANCE, BAL. R +1 to BAL. R +10	BALANCE
	Center speaker level [CNT LVL]	CNT -10 dB to CNT +10 dB (1 dB step)	CNT 0 dB
	Surround left speaker level [SL LVL]	SUR L -10 dB to SUR L +10 dB (1 dB step)	SUR L 0 dB
	Surround right speaker level [SR LVL]	SUR R -10 dB to SUR R +10 dB (1 dB step)	SUR R 0 dB
	Sub woofer level [SW LVL]	SW -10 dB to SW +10 dB (1 dB step)	SW 0 dB
	Dynamic range compressor ^{a)} [D. RANGE]	COMP. OFF, COMP. STD, COMP. MAX	COMP. OFF
TONE [2-TONE] (page 37)	Front speaker bass level [BASS LVL]	BASS -10 dB to BASS +10 dB (0.5 dB step)	BASS 0 dB
	Front speaker treble level [TRE LVL]	TRE -10 dB to TRE +10 dB (0.5 dB step)	TRE 0 dB
SUR [3-SUR] (page 37)	Sound field selection ^{a)} [S.F. SELCT]	2CH ST., A.F.D. AUTO, DOLBY PL, PLII MV, PLII MS, MULTI ST., C.ST.EX A, C.ST.EX B, C.ST.EX C, PORTABLE, HALL, JAZZ, CONCERT	A.F.D. AUTO
	Effect level ^{a)b)} [EFFECT]	EFCT. MIN, EFCT. STD, EFCT. MAX	EFCT. STD
TUNER [4-TUNER] (page 38)	FM station receiving mode ^{a)} [FM MODE]	FM AUTO, FM MONO	FM AUTO

Menu [Display]	Parameters [Display]	Settings	Initial setting
AUDIO [5-AUDIO] (page 38)	Digital audio input decoding priority ^{a)} [DEC. PRI.]	DEC. AUTO, DEC. PCM	DEC. AUTO for: VIDEO 1, VIDEO 2/BD, SAT, TV, DVD; DEC. PCM for: SA-CD/CD
	Digital broadcast language selection ^{a)} [DUAL]	DUAL M/S, DUAL M, DUAL S, DUAL M+S	DUAL M
	Synchronizes audio with video output ^{a)} [A.V. SYNC.]	A.V.SYNC. 0 to A.V.SYNC. 20	A.V.SYNC. 0
	Digital audio input assignment ^{a)} [D. ASSIGN]	For details, see page 55.	
	Switching the audio input mode ^{a)} [IN MODE]	For details, see page 52.	
VIDEO [6-VIDEO] (page 39)	HDMI AUDIO ^{a)c)} [AUDIO]	AMP, TV+AMP	AMP
	HDMI CONTROL ^{a)c)} [CONTROL]	CTRL ON, CTRL OFF	CTRL OFF
SYSTEM [7-SYSTEM] (page 40)	Front left speaker distance ^{a)d)} [FL DIST.]	DIST. 1.0 m to DIST. 7.0 m (0.1 m step)	DIST. 3.0 m
	Front right speaker distance ^{a)d)} [FR DIST.]	DIST. 1.0 m to DIST. 7.0 m (0.1 m step)	DIST. 3.0 m
	Center speaker distance ^{a)d)} [CNT DIST.]	DIST. 1.0 m to DIST. 7.0 m (0.1 m step)	DIST. 3.0 m
	Surround left speaker distance ^{a)d)} [SL DIST.]	DIST. 1.0 m to DIST. 7.0 m (0.1 m step)	DIST. 3.0 m
	Surround right speaker distance ^{a)d)} [SR DIST.]	DIST. 1.0 m to DIST. 7.0 m (0.1 m step)	DIST. 3.0 m
	Sub woofer distance ^{a)d)} [SW DIST.]	DIST. 1.0 m to DIST. 7.0 m (0.1 m step)	DIST. 3.0 m
	Surround speaker position ^{a)} [SUR POS.]	BEHD/HI, BEHD/LO, SIDE/HI, SIDE/LO	SIDE/LO
	Brightness of the display ^{a)} [DIMMER]	0% dim, 40% dim, 70% dim	0% dim

Menu [Display]	Parameters [Display]	Settings	Initial setting
A. CAL [8-A. CAL] (page 27)	Auto calibration on/off ^{a)e)} [AUTO CAL]	A.CAL YES, A.CAL NO	A.CAL NO
	Calibration load ^{a)d)} [CAL LOAD]	LOAD NO, LOAD YES	LOAD YES

- a) For details, refer to the page in the parentheses.
- b) The surround effect is not available for 2CH STEREO and A.F.D. mode.
- c) When you select this parameter, the “HDMI” indicator flashes in the display.
- d) When you set “CAL LOAD” in A. CAL menu to “LOAD YES”, the setting is displayed as ■.■.■ m and you can adjust the setting in 0.01 meter increment.
- e) After you have select the setting, press  to confirm the selection.

Adjusting the level

(LEVEL menu)

You can use the LEVEL menu to adjust the balance and level of each speaker.

Select “1-LEVEL” in the amplifier menus. For details on adjusting the parameters, see “Navigating through menus” (page 32) and “Overview of the menus” (page 33).

LEVEL menu parameters

■ T. TONE (Test tone)

Lets you adjust the speaker levels and balance while listening to the test tone from your listening position. For details, see “7: Adjusting the speaker levels and balance (TEST TONE)” (page 28).

■ FRT BAL (Front speaker balance)

Lets you adjust the balance between front left and right speakers.

■ CNT LVL (Center speaker level)

■ SL LVL (Surround left speaker level)

■ SR LVL (Surround right speaker level)

■ SW LVL (Sub woofer level)

■ D. RANGE (Dynamic range compressor)

Lets you compress the dynamic range of the sound track. This may be useful when you want to watch movies at low volumes late at night. Dynamic range compression is possible with Dolby Digital sources only.

- COMP. OFF

The dynamic range is not compressed.

- COMP. STD

The dynamic range is compressed as intended by the recording engineer.

- COMP. MAX

The dynamic range is compressed dramatically.

Tip

Dynamic range compressor lets you compress the dynamic range of the soundtrack based on the dynamic range information included in the Dolby Digital signal.

“COMP. STD” is the standard setting, but it only enacts light compression. Therefore, we recommend using the “COMP. MAX” setting. This greatly compresses the dynamic range and lets you view movies late at night at low volumes. Unlike analog limiters, the levels are predetermined and provide a very natural compression.

Adjusting the tone (TONE menu)

You can use the TONE menu to adjust the tonal quality (bass/treble level) of the front speakers.

Select “2-TONE” in the amplifier menus. For details on adjusting the parameters, see “Navigating through menus” (page 32) and “Overview of the menus” (page 33).

TONE menu parameters

- **BASS LVL (Front speaker bass level)**
- **TRE LVL (Front speaker treble level)**

Settings for the surround sound (SUR menu)

You can use the SUR menu to select the sound field you want for your listening pleasure.

Select “3-SUR” in the amplifier menus. For details on adjusting the parameters, see “Navigating through menus” (page 32) and “Overview of the menus” (page 33).

SUR menu parameters

■ **S.F. SELECT (Sound field selection)**

Lets you select the sound field you want. For details, see “Enjoying Surround Sound” (page 42).

Note

The receiver lets you apply the last selected sound field to an input whenever it is selected (Sound Field Link). For example, if you select “HALL” for the SA-CD/CD input, then change to a different input and then return to SA-CD/CD, “HALL” will automatically be applied again.

■ **EFFECT (Effect level)**

Lets you adjust the “presence” of the surround effect for sound fields selected with the MOVIE or MUSIC button.

- **EFCT. MIN**
The surround effect is minimum.
- **EFCT. STD**
The surround effect is standard.
- **EFCT. MAX**
The surround effect is maximum.

Settings for the tuner

(TUNER menu)

You can use the TUNER menu to set the FM station receiving mode.

Select “4-TUNER” in the amplifier menus. For details on adjusting the parameters, see “Navigating through menus” (page 32) and “Overview of the menus” (page 33).

TUNER menu parameters

■ FM MODE (FM station receiving mode)

- FM AUTO
This receiver will decode the signal as stereo signal when the radio station is broadcast in stereo.
- FM MONO
This receiver will decode the signal as mono signal regardless of the broadcast signal.

Settings for the audio

(AUDIO menu)

You can use the AUDIO menu to make settings for the audio to suit your preference. Select “5-AUDIO” in the amplifier menus. For details on adjusting the parameters, see “Navigating through menus” (page 32) and “Overview of the menus” (page 33).

AUDIO menu parameters

■ DEC. PRI. (Digital audio input decoding priority)

Lets you specify the input mode for the digital signal input to the DIGITAL IN and HDMI IN jacks.

- DEC. AUTO
Automatically switches the input mode between DTS, Dolby Digital, or PCM.
- DEC. PCM
PCM signals are given priority (to prevent interruption when playback starts). However, when other signals are input, there may be no sound depending on the format. In this case, set to “DEC. AUTO”.
When signals from the HDMI IN jack are selected, only PCM signals are output from the connected player. When signals in other format are received, set to “DEC. AUTO”.

Note

When set to “DEC. AUTO” and the sound from the digital audio jacks (for CD, etc.) is interrupted when playback starts, set to “DEC. PCM”.

■ DUAL (Digital broadcast language selection)

Lets you select the language you want to listen to during digital broadcast. This feature only functions for Dolby Digital sources.

- DUAL M/S (Main/Sub)
Sound of the main language will be output through the front left speaker and sound of the sub language will be output through the front right speaker simultaneously.
- DUAL M (Main)
Sound of the main language will be output.
- DUAL S (Sub)
Sound of the sub language will be output.
- DUAL M+S (Main + Sub)
Mixed sound of both the main and sub languages will be output.

■ A.V. SYNC. (Synchronizes audio with video output)

Lets you delay the audio output so that the time gap between the audio output and visual display is minimized. You can adjust from 0 (0 ms) to 20 (200 ms) in 1 (10 ms) steps.

Notes

- This parameter is useful when you use a large LCD or plasma monitor or a projector.
- This parameter is not valid when the multi-channel PCM signals are received via a HDMI IN jack.

■ D. ASSIGN (Digital audio input assignment)

Lets you assign the digital audio input to other input source. For details, see “Listening to digital sound from other inputs (DIGITAL ASSIGN)” (page 55).

■ IN MODE (Switching the audio input mode)

Lets you set the audio input mode of inputs. For details, see “Switching between digital and analog audio (IN MODE)” (page 52).

Settings for the video (VIDEO menu)

You can use the VIDEO menu to make various adjustments for HDMI settings.

Select “6-VIDEO” in the amplifier menus. For details on adjusting the parameters, see “Navigating through menus” (page 32) and “Overview of the menus” (page 33).

VIDEO menu parameters

■ AUDIO (HDMI AUDIO)*

Lets you set the HDMI audio output from the playback component connected to the receiver via a HDMI connection.

- AMP
The HDMI audio signals from the playback component is only output to speakers connected to the receiver. Multi-channel sound can be played back as it is.

Note

Audio signals are not output from the TV’s speakers.

- TV+AMP
The sound is output from TV’s speaker and the speakers connected to the receiver.

Notes

- The sound quality of the playback component depends on the TV’s sound quality, such as the number of channels, and the sampling frequency, etc. When the TV has stereo speakers, the sound output from the receiver is also stereo as that of the TV, even if you play multi-channel software.
- When you connect the receiver to a video component (projector, etc.), sound may not be output from the receiver. In this case, select “AMP”.

■ CONTROL (HDMI CONTROL)*

Lets you turn the HDMI CONTROL function on or off.

For details, refer to the HDMI CONTROL Guide supplied with the receiver.

* When you select this parameter, the “HDMI” indicator flashes in the display.

Settings for the system (SYSTEM menu)

You can use the SYSTEM menu to set the distance of the speakers connected to this system.

Select “7-SYSTEM” in the amplifier menus. For details on adjusting the parameters, see “Navigating through menus” (page 32) and “Overview of the menus” (page 33).

SYSTEM menu parameters

■ **FL DIST. (Front left speaker distance)**

■ **FR DIST. (Front right speaker distance)**

■ **CNT DIST. (Center speaker distance)**

■ **SL DIST. (Surround left speaker distance)**

■ **SR DIST. (Surround right speaker distance)**

■ **SW DIST. (Sub woofer distance)**

Lets you set the distance from your listening position to the speakers and sub woofer.

Tips

- If you set “CAL LOAD” in A. CAL menu to “LOAD YES”, you can adjust the speakers distance in 0.01 meter increment.
 - The distance between the center speaker and the listening position **[B]** cannot be more than 1.5 meters closer than the one between the listening position and the front speaker **[A]**. Place the speakers so that the difference in the length of **[B]** in the following diagram is no more than 1.5 meters closer than the length of **[A]**.
 Example: Adjust the distance **[B]** to 4.5 meters or more when the distance **[A]** is 6 meters.
- Also, the distance between the surround speakers and the listening position **[C]** cannot be more than 4.5 meters closer than the distance between the listening position and the front speakers **[A]**. Place the speakers so that the difference in the length of **[C]** in the following diagram is no more than 4.5 meters closer than the length of **[A]**.
 Example: Adjust the distance **[C]** to 1.5 meters or more when the distance **[A]** is 6 meters.
- This is important because incorrect speaker placement is not conducive to the enjoyment of surround sound. Please note that placing the speakers closer than the required will cause a delay in the output of the sound from that speaker. In other words, the speaker will sound like it is farther away.

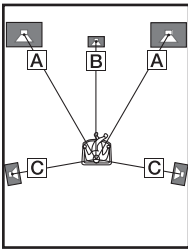

■ SUR POS. (Surround speaker position)

Lets you specify the location of your surround speakers for proper implementation of the surround effects in the CINEMA STUDIO EX modes (page 45).

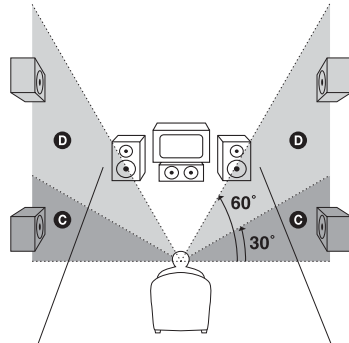
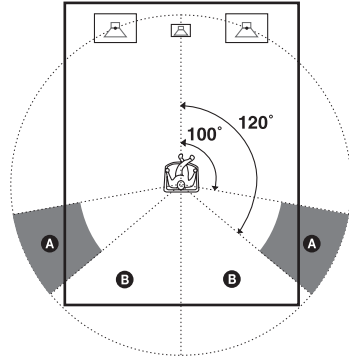

- BEHD/HI
 Select if the location of your surround speakers corresponds to sections **[B]** and **[D]**.
- BEHD/LO
 Select if the location of your surround speakers corresponds to sections **[B]** and **[C]**.
- SIDE/HI
 Select if the location of your surround speakers corresponds to sections **[A]** and **[D]**.
- SIDE/LO
 Select if the location of your surround speakers corresponds to sections **[A]** and **[C]**.

continued

Tip

Surround speaker position is designed specifically for implementation of the CINEMA STUDIO EX modes. For other sound fields, speaker position is not so critical.

Those sound fields were designed under the premise that the surround speakers would be located behind the listening position, but presentation remains fairly consistent even with the surround speakers positioned at a rather wide angle. However, if the speakers are pointing toward the listener from the immediate left and right of the listening position, the surround effects become unclear unless set to “SIDE/LO” or “SIDE/HI”.

Nevertheless, each listening environment has many variables, such as wall reflections, and you may obtain better results using “BEHD/HI” if your speakers are located high above the listening position, even if they are located to the immediate left and right.

Therefore, although it may result in a setting contrary to the above explanation, we recommend that you playback multi channel surround encoded software and select the setting that provides a good sense of spaciousness and that best succeeds in forming a cohesive space between the surround sound from the surround speakers and the sound of the front speakers. If you are not sure which sounds best, select “BEHD/LO” or “BEHD/HI” and then use the speaker distance parameter and speaker level adjustments to obtain proper balance.

■ DIMMER (Brightness of the display)

Lets you adjust the brightness in 3 steps.

Enjoying Surround Sound

Enjoying Dolby Digital and DTS Surround sound (AUTO FORMAT DIRECT)

The Auto Format Direct (A.F.D.) mode allows you to listen to higher fidelity sound and select the decoding mode for listening to a 2 channel stereo sound as multi channel sound.

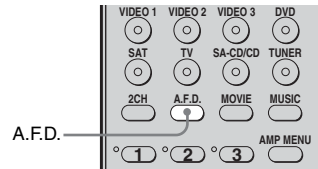

Press A.F.D. repeatedly to select the sound field you want.

You can also use SOUND FIELD +/- on the receiver.

For details, see “Types of A.F.D. mode” (page 43).

Types of A.F.D. mode

Decoding mode	A.F.D. mode [Display]	Multi channel audio after decoding	Effect
(Detecting automatically)	A.F.D. AUTO [A.F.D. AUTO]	(Detecting automatically)	Presents the sound as it was recorded/ encoded without adding any surround effects. However, this receiver will generate a low frequency signal for output to the sub woofer when there is no LFE signals.
Dolby Pro Logic	PRO LOGIC [DOLBY PL]	4 channel	Performs Dolby Pro Logic decoding. The source recorded in 2 channel format is decoded into 4.1 channels.
Dolby Pro Logic II	PRO LOGIC II MOVIE [PLII MV]	5 channel	Performs Dolby Pro Logic II Movie mode decoding. This setting is ideal for movies encoded in Dolby Surround. In addition, this mode can reproduce sound in 5.1 channel for watching videos of overdubbed or old movies.
	PRO LOGIC II MUSIC [PLII MS]	5 channel	Performs Dolby Pro Logic II Music mode decoding. This setting is ideal for normal stereo sources such as CDs.
(Multi Stereo)	MULTI STEREO [MULTI ST.]	(Multi Stereo)	Outputs 2 channel left/right signals from all speakers.

Selecting a pre-programmed sound field

You can take advantage of surround sound simply by selecting one of the receiver's pre-programmed sound fields. They bring the exciting and powerful sound of movie theaters and concert halls into your home.

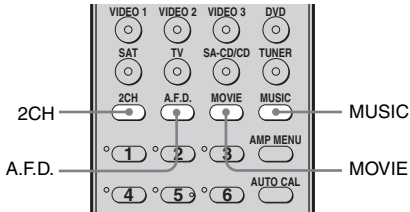

Press MOVIE repeatedly to select a sound field for movies or press MUSIC repeatedly to select a sound field for music.

You can also use SOUND FIELD +/- on the receiver.

For details, see “Types of sound field available” (page 45).

Types of sound field available

Sound field for	Sound field [Display]	Effect
Movie	CINEMA STUDIO EX A DCS [C.ST.EX A]	Reproduces the sound characteristics of the Sony Pictures Entertainment "Cary Grant Theater" cinema production studio. This is a standard mode, great for watching almost any type of movie.
	CINEMA STUDIO EX B DCS [C.ST.EX B]	Reproduces the sound characteristics of the Sony Pictures Entertainment "Kim Novak Theater" cinema production studio. This mode is ideal for watching science-fiction or action movies with lots of sound effects.
	CINEMA STUDIO EX C DCS [C.ST.EX C]	Reproduces the sound characteristics of the Sony Pictures Entertainment scoring stage. This mode is ideal for watching musicals or films where orchestra music is featured in the soundtrack.
Music	PORTABLE AUDIO [PORTABLE]	Reproduces a clear enhanced sound image from your portable audio device. This mode is ideal for MP3 and other compressed music.
	HALL [HALL]	Reproduces the acoustics of a classical concert hall.
	JAZZ CLUB [JAZZ]	Reproduces the acoustics of a jazz club.
	LIVE CONCERT [CONCERT]	Reproduces the acoustics of a 300-seat live house.

About DCS (Digital Cinema Sound)

Sound fields with **DCS** mark use DCS technology. DCS is a unique sound reproduction technology for home theater developed by Sony, in cooperation with Sony Pictures Entertainment, for enjoying the exciting and powerful sound of movie theaters at home. With this "Digital Cinema Sound" developed by integrating a DSP (Digital signal processor) and measured data, the ideal sound field intended by film makers can be experienced at home.

About CINEMA STUDIO EX modes

CINEMA STUDIO EX modes are suitable for watching motion picture DVDs (etc.), with multi channel surround effects. You can reproduce the sound characteristics of Sony Pictures Entertainment's dubbing studio in your home.

The CINEMA STUDIO EX modes consist of the following three elements.

- Virtual Multi Dimension
Creates 5 sets of virtual speakers from a single pair of actual surround speakers.
- Screen Depth Matching
Creates the sensation that the sound is coming from inside the screen like in theaters.
- Cinema Studio Reverberation
Reproduces the type of reverberation found in theaters.



The CINEMA STUDIO EX modes integrate these three elements simultaneously.

Notes

- The effects provided by the virtual speakers may cause increased noise in the playback signal.
- When listening with sound fields that employ the virtual speakers, you will not be able to hear any sound coming directly from the surround speakers.
- This function does not work in the following cases:
 - For signals with a sampling frequency of more than 48 kHz.
 - The multi channel PCM signals are received via a HDMI IN jack.

Tip

You can identify the encoding format of DVD software, etc., by looking at the logo on the package.

-  : Dolby Digital discs
-  : Dolby Surround encoded programs
-  : DTS Digital Surround encoded programs

To turn off the surround effect for movie/music

Press 2CH to select “2CH ST.” or press A.F.D. repeatedly to select “A.F.D. AUTO”.

Using only the front speakers and sub woofer (2CH STEREO)

In this mode, the receiver outputs the sound from the front left/right speakers and sub woofer only.

When multi channel surround formats are input, the signals are downmixed to 2 channel with bass frequencies being output from the sub woofer.

When standard 2 channel stereo sources are input, the receiver’s bass redirection circuitry will be activated. The front channel bass frequencies will be output from the sub woofer.

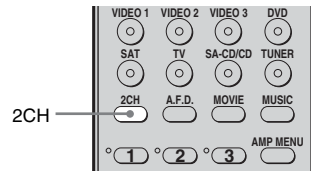

Press 2CH.

You can also use SOUND FIELD +/- on the receiver.

Resetting sound fields to the initial settings

Be sure to use the buttons on the receiver for this operation.

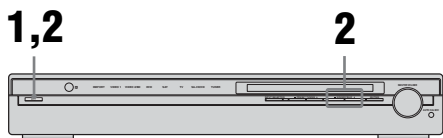

- 1** Press I/O to turn off the receiver.
- 2** While holding down SOUND FIELD +, press I/O.
“S.F. CLR.” appears on the display and all sound fields are reset to their initial setting.

Tuner Operations

Listening to FM/AM radio

You can listen to FM and AM broadcasts through the built-in tuner. Before operation, make sure you have connected the FM and AM antennas to the receiver (page 21).

Tip

The tuning scale for direct tuning differs depending on the area code as shown in the following table. For details on area codes, see page 3.

Area code	FM	AM
CEL, CEK	50 kHz	9 kHz

Automatic tuning

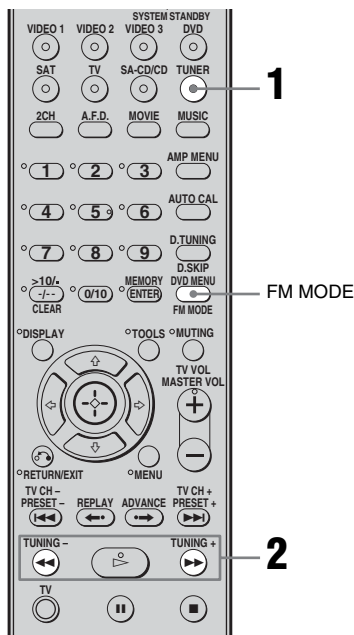

1 Press TUNER repeatedly to select the FM or AM band.

You can also use INPUT SELECTOR on the receiver.

2 Press TUNING + or TUNING –.

Press TUNING + to scan from low to high; press TUNING – to scan from high to low.

The receiver stops scanning whenever a station is received.

In case of poor FM stereo reception

If the FM stereo reception is poor and “ST” flashes on the display, select monaural audio so that the sound will be less distorted.

To select monaural audio, you can

- press FM MODE repeatedly until the “MONO” indicator lights up on the display.
- set “FM MODE” in TUNER menu to “FM MONO” (page 38).

To return to stereo mode, you can

- press FM MODE repeatedly until the “MONO” indicator on the display do not light up.
- set “FM MODE” in TUNER menu to “FM AUTO” (page 38).

Direct tuning

You can enter the frequency of a station directly by using the numeric buttons.

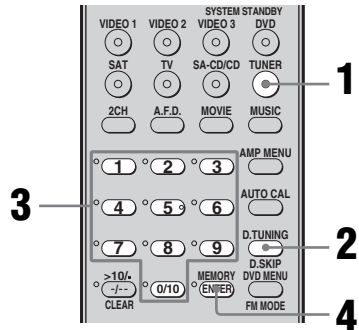

1 Press TUNER repeatedly to select the FM or AM band.

You can also use INPUT SELECTOR on the receiver.

2 Press D.TUNING.

3 Press the numeric buttons to enter the frequency.

Example 1: FM 102.50 MHz

Select 1 → 0 → 2 → 5 → 0

Example 2: AM 1,350 kHz

Select 1 → 3 → 5 → 0

If you have tuned in an AM station, adjust the direction of the AM loop antenna for optimum reception.

4 Press ENTER.

If you cannot tune in a station

Make sure you have entered the right frequency. If not, repeat steps 2 to 4. If you still cannot tune in a station, the frequency is not used in your area.

Presetting radio stations

You can preset up to 30 FM stations and 30 AM stations. Then you can easily tune in the stations you often listen to.

Presetting radio stations

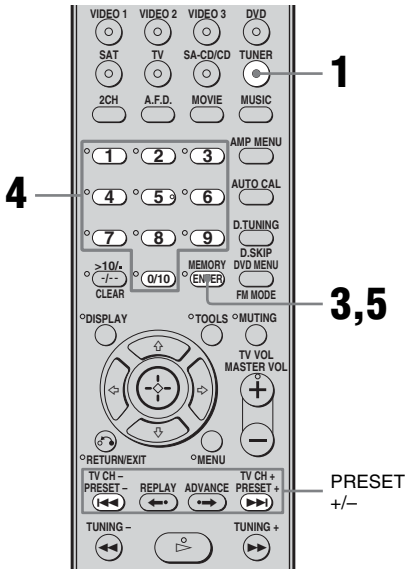

4 Press the numeric buttons to select a preset number.

You can also press the PRESET + or PRESET - to select a preset number. If “MEMORY” goes out before you select the preset number, start again from step 3.

5 Press ENTER.

The station is stored as the selected preset number.

If “MEMORY” goes out before you press ENTER, start again from step 3.

6 Repeat steps 1 to 5 to preset another station.

1 Press TUNER repeatedly to select the FM or AM band.

You can also use INPUT SELECTOR on the receiver.

2 Tune in the station that you want to preset using automatic tuning (page 47) or direct tuning (page 48).

Switch the FM reception mode, if necessary (page 48).

3 Press MEMORY.

“MEMORY” lights up for a few seconds.

Perform steps 4 and 5 before

“MEMORY” goes out.

Tuning to preset stations

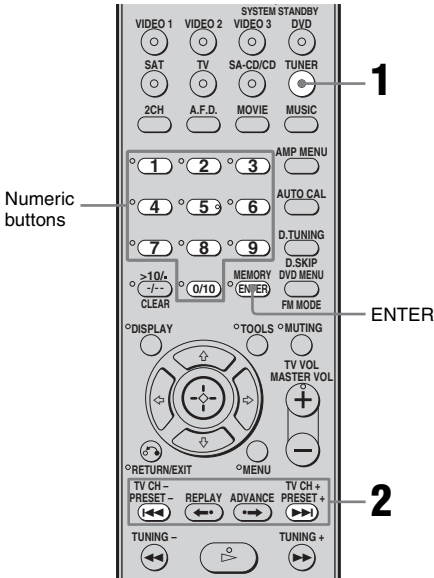

- 1 Press TUNER repeatedly to select the FM or AM band.**
- 2 Press PRESET + or PRESET – repeatedly to select the preset station you want.**

Each time you press the button, you can select a preset station as follows:

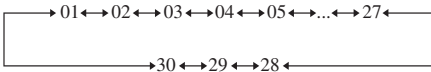

You can also press the numeric buttons to select the preset station you want. Then, press ENTER to enter the selection.

Using the controls on the receiver

- 1 Press INPUT SELECTOR repeatedly to select the FM or AM band.**
- 2 Press PRESET TUNING + or PRESET TUNING – repeatedly to select the preset station you want.**

Using the Radio Data System (RDS)

This receiver also allows you to use RDS (Radio Data System), which enables radio stations to send additional information along with the regular program signal. You can display RDS information.

Notes

- RDS is operable only for FM stations.
- Not all FM stations provide RDS service, nor do they provide the same type of services. If you are not familiar with the RDS services in your area, check with your local radio stations for details.

Receiving RDS broadcasts

Simply select a station on the FM band using direct tuning (page 48), automatic tuning (page 47), or preset tuning (page 50).

When you tune in a station that provides RDS services, “RDS” lights up and the program service name appears on the display.

Note

RDS may not work properly if the station you tuned to is not transmitting the RDS signal properly or if the signal strength is weak.

Displaying RDS information

While receiving an RDS station, press DISPLAY repeatedly.

Each time you press the button, RDS information on the display changes cyclically as follows:

Program Service name → Frequency → Program Type indication^{a)} → Radio Text indication^{b)} → Current Time indication (in 24-hour system mode) → Sound field currently applied → Volume level

^{a)}Type of program being broadcast (page 51).

^{b)}Text messages sent by the RDS station.

Notes

- If there is an emergency announcement by government authorities, "ALARM" flashes in the display.
- When the message consists of 9 characters or more, the message scrolls across the display.
- If a station does not provide a particular RDS service, "NO XXXX" (such as "NO TEXT") appears on the display.

Description of program types

Program type indication	Description
NEWS	News programs
AFFAIRS	Topical programs that expand on current news
INFO	Programs offering information on a wide spectrum of subjects, including consumer affairs and medical advice
SPORT	Sports programs
EDUCATE	Educational programs, such as "how-to" and advice programs
DRAMA	Radio plays and serials
CULTURE	Programs about national or regional culture, such as language and social concerns
SCIENCE	Programs about the natural sciences and technology

Program type indication	Description
VARIED	Other types of programs such as celebrity interviews, panel games, and comedy
POP M	Popular music programs
ROCK M	Rock music programs
EASY M	Easy Listening
LIGHT M	Instrumental, vocal, and choral music
CLASSICS	Performances of major orchestras, chamber music, opera, etc.
OTHER M	Music that does not fit into any categories above, such as Rhythm & Blues and Reggae
WEATHER	Weather information
FINANCE	Stock market reports and trading, etc.
CHILDREN	Programs for children
SOCIAL	Programs about people and the things that affect them
RELIGION	Programs of religious content
PHONE IN	Programs where members of the public express their views by phone or in a public forum
TRAVEL	Programs about travel. Not for announcements that are located by TP/TA.
LEISURE	Programs on recreational activities such as gardening, fishing, cooking, etc.
JAZZ	Jazz programs
COUNTRY	Country music programs
NATION M	Programs featuring the popular music of the country or region
OLDIES	Programs featuring oldies music
FOLK M	Folk music programs
DOCUMENT	Investigative features
NONE	Any programs not defined above

Switching between digital and analog audio (IN MODE)

You can select the audio input mode setting when you connect components to both digital and analog audio input jacks on the receiver.

- 1 Press AMP MENU.**
“1-LEVEL” appears on the display.
- 2 Press \uparrow/\downarrow repeatedly to select “5-AUDIO”.**
- 3 Press \odot or \rightarrow to enter the menu.**
- 4 Press \uparrow/\downarrow repeatedly to select “IN MODE”.**
- 5 Press \odot or \rightarrow to enter the parameter.**
- 6 Press \uparrow/\downarrow repeatedly to select the audio input you want.**

To return to the previous display

Press \leftarrow .

Audio input modes

■ AUTO IN

Gives priority to digital audio signals when there are both digital and analog connections. If there are no digital audio signals, analog audio signals are selected.

■ HDMI IN

Specifies the audio signals input to the HDMI jack.

■ COAX IN

Specifies the digital audio signals input to the DIGITAL COAX IN jack.

■ OPT IN

Specifies the digital audio signals input to the DIGITAL OPT IN jack.

■ ANALOG

Specifies the analog audio signals input to the AUDIO IN (L/R) jacks.

Note

Some audio input modes may not be set up depending on the input.

Enjoying the DIGITAL MEDIA PORT (DMPORT)

The DIGITAL MEDIA PORT (DMPORT) allows you to enjoy sound from a network system such as a portable audio source or computer.

By connecting a DIGITAL MEDIA PORT adapter (not supplied), you can enjoy sound from the connected component on the receiver.

For details, see the operating instructions supplied with the DIGITAL MEDIA PORT adapter.

Notes

- Do not connect an adapter other than the DIGITAL MEDIA PORT adapter.
- Do not connect or disconnect the DIGITAL MEDIA PORT adapter while the receiver is turned on.
- Depending on the DIGITAL MEDIA PORT adapter, video output may not be possible.
- The DIGITAL MEDIA PORT adapters are available for purchase depending on the area.

Connecting the DIGITAL MEDIA PORT adapter

You can listen to the sound from the component connected through the DIGITAL MEDIA PORT adapter to the DMPORT jack on the receiver.

You can also view the images on the TV screen by connecting the video output of the DIGITAL MEDIA PORT adapter to the video input of the TV.

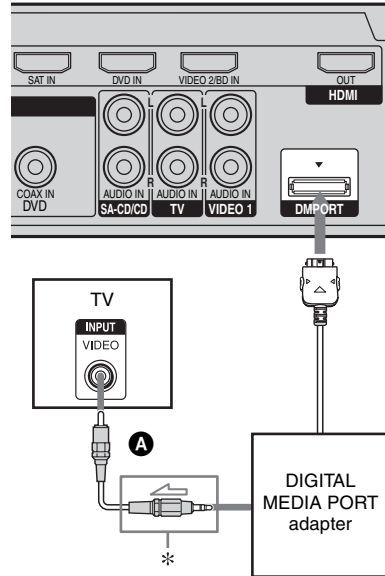

* The type of connector varies depending on the DIGITAL MEDIA PORT adapter. For details, see the operating instructions supplied with the DIGITAL MEDIA PORT adapter.

A Video cord (not supplied)

To detach the DIGITAL MEDIA PORT adapter from DMPORT jack

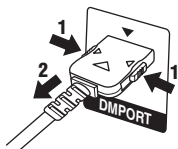

Press and hold both sides of the connector and then pull out the connector.

Notes

- When connecting the DIGITAL MEDIA PORT adapter, be sure the connector is inserted with the arrow mark facing toward the arrow mark on the DMPORT jack.
- Be sure to make DMPORT connections firmly, insert the connector straight in.
- As the connector of the DIGITAL MEDIA PORT adapter is fragile, be sure to handle with care when placing or moving the receiver.

Listening to a connected component through DMPORT connection

1 Press DMPORT.

You can also use the INPUT SELECTOR on the receiver to select “DMPORT”.

2 Start playback of the connected component.

The sound is played back on the receiver. For details, see the operating instructions supplied with the DIGITAL MEDIA PORT adapter.

Note

Depending on the type of DIGITAL MEDIA PORT adapter, you can operate the connected component by using the remote. For details on remote button operation, see page 8.

Tip

When listening to MP3 or other compressed music using a portable audio source, you can enhance the sound. Press MUSIC repeatedly to select “PORTABLE” (page 44).

Listening to digital sound from other inputs

(DIGITAL ASSIGN)

You can reassign digital audio input that has OPTICAL or COAXIAL (SAT IN, VIDEO 1 IN, DVD IN) signals to another input when they are not currently being used.

For example, to output the sound source for the DVD player using the OPTICAL IN jack on the receiver:

- Connect the optical output jack of the DVD player to the OPTICAL VIDEO 1 IN jack of the receiver.
- Assign “VD1 OPT” to DVD function in the “D. ASSIGN” setting.

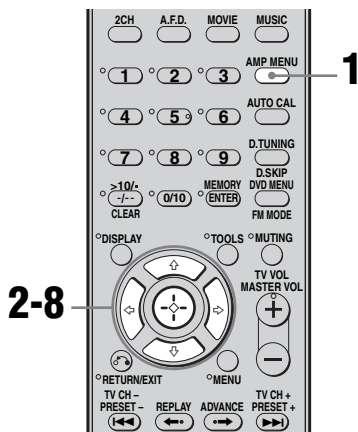

- 1 Press AMP MENU.**
“1-LEVEL” appears on the display.
- 2 Press \uparrow/\downarrow repeatedly to select “5-AUDIO”.**
- 3 Press \odot or \rightarrow to enter the menu.**
- 4 Press \uparrow/\downarrow repeatedly to select “D. ASSIGN”.**

- 5 Press \odot or \rightarrow to enter the parameter.**
- 6 Press \uparrow/\downarrow repeatedly to select the digital audio input you want to reassign (for example, “VD1 OPT”).**
- 7 Press \odot or \rightarrow to enter your selection.**
- 8 Press \uparrow/\downarrow repeatedly to select the input you want the digital audio input selected in step 6 to be reassigned to (for example, “VD1-DVD”).**

The input you can reassign to varies for each digital audio input. For details, see “Assignable inputs for digital audio input” (page 56) .

To return to the previous display
Press \leftarrow .

Assignable inputs for digital audio input

The initial setting is marked with an underscore.

Digital audio input [Display]	Assignable inputs	Display
VIDEO 1 OPTICAL [VD1 OPT]	VIDEO 1	<u>VD1– VD1</u>
	VIDEO 2/BD	VD1– VD2
	DVD	VD1– DVD
	TV	VD1– TV
	SA-CD/CD	VD1– CD
DVD COAXIAL [DVD COAX]	VIDEO 1	DVD– VD1
	VIDEO 2/BD	DVD– VD2
	DVD	<u>DVD– DVD</u>
	SAT	DVD– SAT
	TV	DVD– TV
	SA-CD/CD	DVD– CD
SAT OPTICAL [SAT OPT]	VIDEO 2/BD	SAT– VD2
	DVD	SAT– DVD
	SAT	<u>SAT– SAT</u>
	TV	SAT– TV
	SA-CD/CD	SAT– CD

Notes

- You cannot reassign several digital audio inputs to the same input.
- You cannot use the digital audio input for the original input when it is reassigned to another input.
- When you reassign the digital audio input, you may need to adjust the IN MODE setting in order to output the sound from the receiver (page 52).
- You cannot reassign the digital audio input to TUNER and DMPORT.

Using the Sleep Timer

You can set the receiver to turn off automatically at a specified time.

Press SLEEP repeatedly while the power is on.

Each time you press the button, the display changes cyclically as follows:

2-00-00 → 1-30-00 → 1-00-00 → 0-30-00
→ OFF

When sleep timer is activated, the display dims and “SLEEP” indicator lights up.

Note

If you press any buttons on the remote or receiver after the display dims, the display brightens up. After a while, the display dims again if no button is pressed.

Tip

To check the remaining time before the receiver turns off, press SLEEP. The remaining time appears on the display. If you press SLEEP again, the sleep timer will be canceled.

Changing button assignments

You can change the factory settings of the input buttons to suit the components in your system. For example, if you connect a DVD recorder to the VIDEO 1 jacks on the receiver, you can set the VIDEO 1 button on this remote to control the DVD recorder.

1 Hold down the input button of which you want to change the assignment.

Example: Hold down VIDEO 1.

2 Referring to the table below, press the corresponding button for the category you want.

Example: Press 4.

Now you can use the VIDEO 1 button to control the DVD recorder.

Categories and the corresponding buttons

Categories	Press
VCR (command mode VTR 3) ^{a)}	1
VCR (command mode VTR 2) ^{a)}	2
DVD player/DVD recorder (command mode DVD1) ^{b)}	3
DVD recorder (command mode DVD3) ^{b)}	4
CD player	5
Euro Digital Satellite Receiver	6
DVR (Digital CATV terminal)	7
DSS (Digital Satellite Receiver)	8
Blu-ray disc player (command mode BD1) ^{c)}	9
Blu-ray disc recorder (command mode BD3) ^{c)}	0/10
TV	-/--
Not assigned	ENTER/ MEMORY

^{a)} Sony VCRs are operated with a VTR 2 or VTR 3 setting which correspond to 8 mm and VHS respectively.

^{b)} Sony DVD recorders are operated with a DVD1 or DVD3 setting. For details, refer to the operating instructions supplied with the DVD recorders.

^{c)} For details on the BD1 or BD3 setting, refer to the operating instructions supplied with the Blu-ray disc player or Blu-ray disc recorder.

To clear all remote button assignments

Press I/⏏, DMPORT and MASTER VOL – at the same time.

The remote is reset to its factory settings.

Glossary

■ Dolby Digital

Digital audio encoding/decoding technology developed by Dolby Laboratories, Inc. It consists of front (Left/Right), center, surround (Left/Right) and sub woofer channels. It is a designated audio standard for DVD-video and also known as 5.1 channel surround. Since surround information is recorded and reproduced in stereo, more realistic sound with fuller presence is delivered than with Dolby surround.

■ Dolby Pro Logic II

This technology converts 2 channel stereo recorded audio into 5.1 channel for playback. There is a MOVIE mode for movies and MUSIC mode for stereo sources such as music. Old movies encoded in the traditional stereo format can be enhanced with 5.1 channel surround sound.

■ Dolby Surround (Dolby Pro Logic)

Audio processing technology developed by Dolby Laboratories, Inc. Center and mono surround information is matrixed into two stereo channels. When reproduced, audio is decoded and output in 4 channel surround sound. This is the most common audio processing method for DVD-video.

■ DTS Digital Surround

Digital audio encoding/decoding technology for theaters developed by DTS, Inc. It compresses audio less than Dolby Digital, delivering a higher quality sound reproduction.

■ HDMI (High-Definition Multimedia Interface)

HDMI is an interface that supports both video and audio on a single digital connection. The HDMI connection carries standard to high definition video signals and multi-channel audio signals to audio/video components, such as HDMI equipped TVs, in digital form without degradation. The HDMI specification supports HDCP (High-bandwidth Digital Contents Protection), a copy protection technology that incorporates coding technology for digital video signals.

■ Sampling frequency

To convert analog audio to digital, analog data should be quantified. This process is called sampling, and the number of times per second the analog data is quantified is called the sampling frequency. A standard music CD stores data quantified at 44,100 times per second, which is expressed as a sampling frequency of 44.1 kHz. Generally speaking, a higher sampling frequency means better sound quality.

■ TSP (Time Stretched Pulse)

A TSP signal is a highly precise measuring signal that utilizes impulse energy, measuring a wide band, from low to high, in a short period. The amount of energy used to measure signals is important to ensure measurement accuracy in a normal indoor environment. Using TSP signals makes it possible to measure signals effectively.

Precautions

On safety

Should any solid object or liquid fall into the cabinet, unplug the receiver and have it checked by qualified personnel before operating it any further.

On power sources

- Before operating the receiver, check that the operating voltage is identical with your local power supply.
The operating voltage is indicated on the nameplate on the back of the receiver.
- The unit is not disconnected from the AC power source (mains) as long as it is connected to the wall outlet, even if the unit itself has been turned off.
- If you are not going to use the receiver for a long time, be sure to disconnect the receiver from the wall outlet. To disconnect the AC power cord, grasp the plug itself; never pull the cord.
- The AC power cord must be changed only at a qualified service shop.

On heat buildup

Although the receiver heats up during operation, this is not a malfunction. If you continuously use this receiver at a large volume, the cabinet temperature of the top, side and bottom rises considerably. To avoid burning yourself, do not touch the cabinet.

On placement

- Place the receiver in a location with adequate ventilation to prevent heat buildup and prolong the life of the receiver.
- Do not place the receiver near heat sources, or in a place subject to direct sunlight, excessive dust, or mechanical shock.
- Do not place anything on top of the cabinet that might block the ventilation holes and cause malfunctions.
- Do not place the receiver near equipment such as a TV, VCR, or tape deck. (If the receiver is being used in combination with a TV, VCR, or tape deck, and is placed too close to that equipment, noise may result, and picture quality may suffer. This is especially likely when using an indoor antenna. Therefore, we recommend using an outdoor antenna.)
- Use caution when placing the receiver or speakers on surfaces that have been specially treated (with wax, oil, polish, etc.) as staining or discoloration of the surface may result.

On operation

Before connecting other components, be sure to turn off and unplug the receiver.

If you encounter color irregularity on a nearby TV screen

The front speakers, center speaker and the sub woofer are magnetically shielded to allow it to be installed near a TV set. However, color irregularities may still be observed on certain types of TV sets. As the surround speakers are not magnetically shielded, we recommend that you place the surround speakers slightly further away from TV set (page 11).

If color irregularity is observed...

Turn off the TV set, then turn it on again after 15 to 30 minutes.

If color irregularity is observed again...

Place the speaker further away from the TV set.

If howling occurs

Reposition the speakers or turn down the volume on the receiver.

On cleaning

Clean the cabinet, panel, and controls with a soft cloth slightly moistened with a mild detergent solution. Do not use any type of abrasive pad, scouring powder, or solvent, such as alcohol or benzine.

If you have any questions or problems concerning your receiver, please consult your nearest Sony dealer.

Troubleshooting

If you experience any of the following difficulties while using the receiver, use this troubleshooting guide to help you remedy the problem.

Audio

There is no sound, no matter which component is selected, or only a very low-level sound is heard.

- Check that the speakers and components are connected securely.
- Check that both the receiver and all components are turned on.
- Check that MASTER VOLUME is not set to "VOL MIN".
- Press MUTING to cancel the muting function.
- Check that you have selected the correct component with the input buttons on the remote or INPUT SELECTOR on the receiver.
- The protective device on the receiver has been activated. Turn off the receiver, eliminate the short-circuit problem, and turn on the power again.
- Check that the IN MODE setting is correct.

There is no sound from a specific component.

- Check that the component is connected correctly to the audio input jacks for that component.
- Check that the cord(s) used for the connection is (are) fully inserted into the jacks on both the receiver and the component.
- Check that you have selected the correct component with the input buttons on the remote or INPUT SELECTOR on the receiver.

There is no sound from one of the front speakers.

- Make sure you have connected to both the L and R jacks of an analog component, and not only to either the L or R jack. Use an audio cord (not supplied).

The source sound input to the HDMI jack on the receiver is not output from the TV speaker.

- Check the setting of HDMI AUDIO in the VIDEO menu (page 39).
- Check the HDMI connection.
- You cannot listen to the Super Audio CD by connecting HDMI.
- Depending on the playback component, you may need to set up the component. Refer to the operating instructions supplied with each component.

The left and right sounds are unbalanced or reversed.

- Check that the speakers and components are connected correctly and securely.
- Adjust the balance parameters using the LEVEL menu (page 36).

There is severe hum or noise.

- Check that the speakers and components are connected securely.
- Check that the connecting cords are away from a transformer or motor, and at least 3 m (10 ft) away from a TV set or fluorescent light.
- Move your audio components away from the TV.
- The plugs and jacks are dirty. Wipe them with a cloth slightly moistened with alcohol.

There is pop noise from a specific component connected to this receiver when you turn on the component.

- Check that the IN MODE is not set to “AUTO IN” for the selected input (page 52).

There is no sound, or only a very low-level sound is heard from the center/surround speakers.

- Select a CINEMA STUDIO EX mode (page 45).
- Adjust the speaker level (page 28).
- Check that the speakers are connected securely.

There is no sound from the sub woofer.

- Check that the sub woofer is connected correctly and securely.

The surround effect cannot be obtained.

- Make sure you have selected a sound field with MOVIE or MUSIC button.
- Sound fields do not function for signals with a sampling frequency of more than 48 kHz.

Dolby Digital or DTS multi channel sound is not reproduced.

- Check that the DVD, etc. you are playing is recorded in Dolby Digital or DTS format.
- When connecting the DVD player, etc., to the digital input jacks of this receiver, check the audio setting (the settings for the audio output) of the connected component.

Video

There is no picture or an unclear picture appears on the TV screen or monitor.

- Make sure you have connected the video output of your video component to the TV.
- Move your audio components away from the TV.

The source image input to the HDMI jack on the receiver is not output from the TV.

- Check the HDMI connection.
- Depending on the playback component, you may need to set up the component. Refer to the operating instructions supplied with each component.

Tuner

The FM reception is poor.

- Use a 75-ohm coaxial cable (not supplied) to connect the receiver to an outdoor FM antenna as shown below. If you connect the receiver to an outdoor antenna, ground it against lightning. To prevent a gas explosion, do not connect the ground wire to a gas pipe.

Outdoor FM antenna

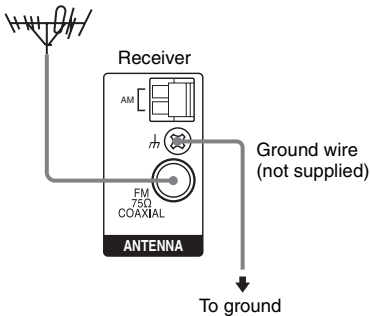

Radio stations cannot be tuned in.

- Check that the antennas are connected securely. Adjust the antennas and connect an external antenna, if necessary.
- The signal strength of the stations is too weak (when tuning in with automatic tuning). Use direct tuning (page 48).
- Make sure you set the tuning interval correctly (when tuning in AM stations with direct tuning).
- No stations have been preset or the preset stations have been cleared (when tuning by scanning preset stations). Preset the stations (page 49).

RDS does not work.

- Make sure that you are tuned to an FM RDS station.
- Select a stronger FM station.

The RDS information that you want does not appear.

- Contact the radio station and find out whether they actually provide the service in question. If so, the service may be temporarily out of order.

Remote control

The remote does not function.

- For receiver operation, you can only use the DISPLAY button when the TUNER input is selected.
- Point the remote at the remote sensor on the receiver.
- Remove any obstacles in the path between the remote and the receiver.
- Replace all the batteries in the remote with new ones, if they are weak.
- Make sure you select the correct input on the remote.
- The VIDEO 3 button on the remote is not available for receiver operation.

Error messages

If there is a malfunction, the display shows a message. You can check the condition of the system by the message. Refer to the following table to solve the problem. If any problem persists, consult your nearest Sony dealer. If an error message appears while you perform Auto Calibration, see “When error codes appear” (page 26) to solve the problem.

PROTECT

Irregular current is output from the speakers. The receiver will automatically turn off after a few seconds. Check the speaker connection and turn on the power again.

If you are unable to remedy the problem using the troubleshooting guide

Clearing the receiver's memory may remedy the problem (page 22). However, note that all memorized settings will be reset to their factory settings and you will have to readjust all settings on the receiver.

If the problem persist

Consult your nearest Sony dealer. Note that if service personnel changes some parts during repair, these parts may be retained.

Reference sections for clearing the receiver's memory

To clear	See
All memorized settings	page 22
Customized sound fields	page 47

Specifications

Amplifier section

Power Output¹⁾

Stereo mode (rated) 108 W + 108 W
(3 ohms at 1 kHz,
THD 1%)

Surround mode (reference)

RMS Output
(3 ohms at 1 kHz,
THD 10%)
FRONT²⁾: 143 W/ch
CENTER²⁾: 143 W
SUR²⁾: 143 W/ch
(1.5 ohms at 80 Hz,
THD 10%)
SUBWOOFER²⁾: 285 W

¹⁾Measured under the following conditions:

Area code	Power requirements
CEL, CEK	230 V AC, 50 Hz

²⁾Reference power output for front, center, surround speakers and sub woofer. Depending on the sound field settings and the source, there may be no sound output.

Inputs

Analog Sensitivity: 1 V/50 kohms
Digital (Coaxial) Impedance: 75 ohms

Tone

Gain levels ±10 dB, 0.5 dB step

Reproduction frequency range:

28 – 20,000 Hz

FM tuner section

Tuning range 87.5 – 108.0 MHz

Antenna FM wire antenna

Antenna terminals 75 ohms, unbalanced

Intermediate frequency

10.7 MHz

AM tuner section

Tuning range

Models of area code CEL, CEK

With 9-kHz tuning scale:

531 – 1,602 kHz

Antenna Loop antenna

Intermediate frequency

450 kHz

General

Power requirements

Area code	Power requirements
CEL, CEK	230 V AC, 50/60 Hz

Power output (DIGITAL MEDIA PORT)

DC OUT: 5 V, 700 mA

Power consumption

Area code	Power consumption
CEL, CEK	165 W

Power consumption (during standby mode)

0.3 W (When
“CONTROL” in VIDEO
menu is set to “CTRL
OFF”)

Dimensions (w/h/d) (Approx.)

430 × 66.5 × 335 mm
including projecting parts
and controls

Mass (Approx.) 3.6 kg

Speaker section

HT-SF1200 only

• **Front speakers (SS-MSP2200)**

• **Center speaker (SS-CNP2200)**

• **Surround speakers (SS-SRP2200)**

Front speakers 2 way, magnetically shielded

Center speaker Full range, magnetically shielded

Surround speakers Full range

Speaker units

Front speakers 65 mm cone type,
25 mm Balance Dome
Tweeter

Center speaker 65 mm cone type

Surround speakers 65 mm cone type

Enclosure type Bass reflex

Rated Impedance 3.0 ohms

Dimension (w/h/d) (Approx.)

Front/surround speakers

92 × 538 × 74 mm
300 × 1,229 (max.) ×
300 mm with stand

Center speaker 260 × 91 × 80 mm

Mass (Approx.)

Front/surround speakers

1.1 kg
2.8 kg with stand

Center speaker 0.6 kg

• **Sub woofer (SS-WP2200)**

Speaker system Magnetically shielded

Speaker unit 160 mm cone type

Enclosure type Bass reflex

Rated Impedance 1.5 ohms

Dimensions (w/h/d) (Approx.)

196 × 320 × 400 mm
including front panel

Mass (Approx.) 5.6 kg

HT-SS1200 only

- **Front speakers (SS-MSP1200)**
- **Center speaker (SS-CNP1200)**
- **Surround speakers (SS-SRP1200)**

Front/center speakers

Full range, magnetically shielded

Surround speakers

Full range

Speaker units

57 mm cone type

Enclosure type

Bass reflex

Rated Impedance

3.0 ohms

Dimension (w/h/d) (Approx.)

Front/surround speakers

80 × 150 × 88 mm

Center speaker

250 × 85 × 88 mm

Mass (Approx.)

Front speakers

0.5 kg

Center speaker

0.7 kg

Surround speakers

0.4 kg

• **Sub woofer (SS-WP1200)**

Speaker system

Magnetically shielded

Speaker unit

160 mm cone type

Enclosure type

Bass reflex

Rated Impedance

1.5 ohms

Dimensions (w/h/d) (Approx.)

200 × 382 × 337 mm
including front panel

Mass (Approx.)

4.5 kg

Supplied speakers

Front speakers (2)

Center speaker (1)

Surround speakers (2)

Sub woofer (1)

Supplied accessories

FM wire antenna (1)

AM loop antenna (1)

Remote commander RM-AAU017 (1)

R6 (size-AA) batteries (2)

Optimizer microphone (ECM-AC2) (1)

Speaker cords (5)

Coaxial digital cord (1)

Foot pads

• Speakers

– HT-SS1200 only (20)

– HT-SF1200 only (4)

• Sub woofer (4)

Screws (silver) (HT-SF1200 only) (8)

Screws (black) (HT-SF1200 only) (8)

For details on the area code of the component you are using, see page 3.

Design and specifications are subject to change without notice.

Index

Numerics

- 2 channel 46
- 2CH STEREO 46
- 5.1 channel 11

A

- AUTO CALIBRATION 23
- AUTO FORMAT DIRECT (A.F.D.) 42

B

- Blu-ray disc player connecting 19

C

- CD player connecting 16 playback 30

D

- DIGITAL ASSIGN 55
- Digital Cinema Sound (DCS) 45
- DIGITAL MEDIA PORT connecting 53
- Dolby Digital 58
- DVD player connecting 17 playback 31
- DVD recorder connecting 17

E

- Error messages 63

H

- HDMI connecting 19

I

- IN MODE 52
- Initial setup 22

M

- Menu
 - A. CAL 27
 - AUDIO 38
 - LEVEL 36
 - SUR 37
 - SYSTEM 40
 - TONE 37
 - TUNER 38
 - VIDEO 39
- Muting 29

R

- RDS 50

S

- Satellite tuner/Set-top box connecting 17
- Selecting
 - component 29
 - sound field 44
- Sleep Timer 56
- Sound fields
 - resetting 47
 - selecting 44
- Speakers
 - connecting 14
 - installing 11
- Super Audio CD player
 - connecting 16
 - playback 30

T

- TEST TONE 28
- Tuner
 - connecting 21
- Tuning
 - automatically 47
 - directly 48
 - to preset stations 50
- TV
 - connecting 17

V

- VCR
 - connecting 17



* 3 2 1 0 7 6 7 1 2 * (2)