

# SONY®

Digital HD Video Camera Recorder

## HVR-V1P



# HDV™

## HDV 1080i

# Adding 1080-25p Image Capture to the Sony HDV Family of Camcorders – the HVR-V1P HDV Camcorder

Since their sensational debut in 2004, Sony's HDV™ products adopting the HDV 1080i specification have continued to exploit new possibilities in cost-effective HD program production. With high picture performance and superb functionality, they are trusted around the world for a wide range of HD applications.

In line with its commitment to the HDV format, Sony introduces the HVR-V1P – a stunning new model that extends the HDV agenda into the world of drama productions.

The HVR-V1P offers 25p progressive scanning, in addition to 50i interlaced. The images captured at 25p are recorded on tape at a 50i field rate by dividing each frame into two fields. Using a compatible nonlinear editor\*<sup>1</sup>, these are reverted back to their original progressive frames, allowing precise 25p editing of the HDV material. This approach also allows the progressive images of the HVR-V1P to be easily integrated into existing HDV systems operating in 50i mode.

In its compact, lightweight, and ergonomically designed chassis, the HVR-V1P camcorder integrates advanced technologies such as the newly developed 3 ClearVid CMOS Sensor imaging system – which is only made possible by Sony's industry-leading semiconductor technology – and a stunning optical 20x Carl Zeiss Vario-Sonnar T\*® zoom lens. Such features ensure operators can make the most of the HDV format quality with an extreme level of mobility, ease of use, and operational comfort suited for any shooting scenario.

In addition to HDV 1080i recording and playback, the camcorder also offers DVCAM™/DV recording and playback capabilities, as well as down-conversion of recordings made in HDV 1080i. These bridges between HD and SD allow the camcorder to be used in any DV-based system, whether it uses the HDV, DVCAM, or DV format.

And for even greater power, the optional HVR-DR60 Hard Disk Recording Unit – which is optimized for use on the HVR-V1P camcorder – streamlines the subsequent editing and archiving processes.

Adding this unit allows images captured by the camcorder to be simultaneously recorded to tape and hard disk. After a shoot is complete, simply connecting the HVR-DR60 to a compatible nonlinear editing system provides quick access to files from the editing software and completely eliminates the time-consuming digitizing process. In addition to a maximum recording time of 4.5 hours on the HVR-DR60, this hybrid tape and hard disk recording system offers a multitude of benefits for shooting, editing, and archiving operations.

Available at a price comparable to Sony DVCAM handheld camcorders, the HVR-V1P offers new creative shooting opportunities to both the HD and SD worlds.

\*<sup>1</sup> Please contact your nearest Sony office or authorized dealer for compatible nonlinear editors.

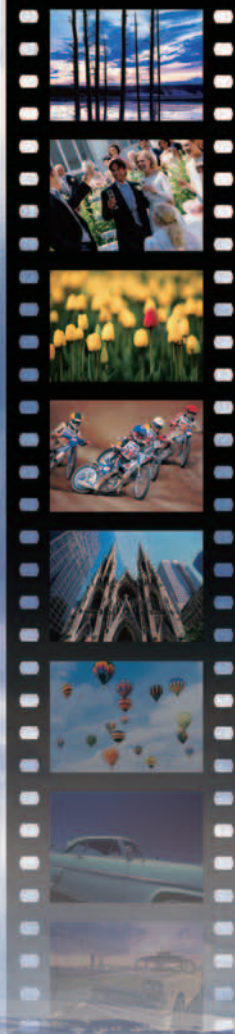





# HDV

HDV 1080i

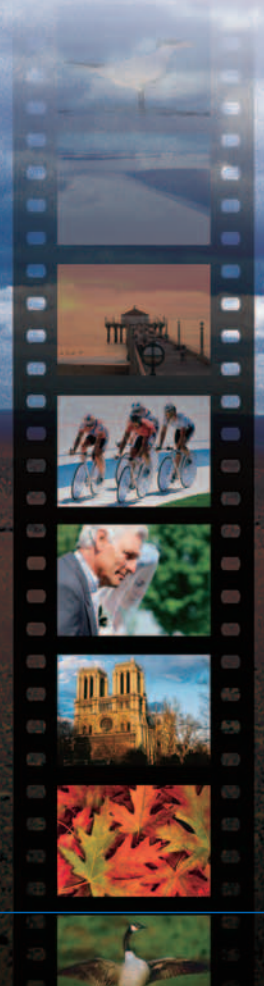

## HDV FORMAT

From the outset, the HDV 1080i specification of the HDV\*<sup>2</sup> format has been developed to record stunning HD images with 1080 active scanning lines on DV-specification cassette tapes. It adopts the MPEG-2 compression format, using 8-bit digital component recording at approximately 25 Mb/s, which is the same data rate as the DVCAM/DV format, enabling a long recording time on compact DV cassettes.

For example, more than 60 minutes of high-quality HD images can be recorded on a mini DV cassette. As with the DVCAM and DV formats, the HDV format allows an i.LINK connection to compatible nonlinear editors, enabling a cost-effective

HD production system. The sheer volume of HDV 1080i professional and consumer equipment used around the world is a clear indication that HDV 1080i has become one of the most popular HD formats.

<sup>\*2</sup> Although not used in Sony HDV products, the HDV format also defines the HDV 720p specification, which features 720 effective scanning lines (progressive scanning system).

### Long Recording Time

The HVR-V1P uses mini cassette tapes and provides a maximum recording time of 63 minutes with the PHDVM-63DM.

## INNOVATIVE TECHNOLOGIES

### 3 ClearVid CMOS Sensor Imaging System

The ClearVid CMOS Sensor™ has been developed using the most advanced technologies in the semiconductor industry. Thanks to the unique grid arrangement of the photo diode sensors, in which each is rotated by 45 degrees, sensor resolution has been optimized and the photosensitive surface area has been maximized.

The HVR-V1P employs a 3-chip ClearVid CMOS Sensor imaging system, which processes high-resolution (1920 x 1080) images with rich and natural colors. The combined use of the 3 ClearVid CMOS Sensor imaging system and the Enhanced Imaging Processor™ has enabled a most precise interpolation scheme, which concludes within each R, G, and B channel. This allows a higher resolution for each R, G, and B channel than is offered by equivalent-class camcorders that resort to spatial offset techniques to improve resolution.

Unlike CCD sensors, there is no vertical smear in the ClearVid CMOS Sensor when shooting high-intensity subjects, further reducing shooting-condition constraints.

**3 ClearVid**  
CMOS sensor

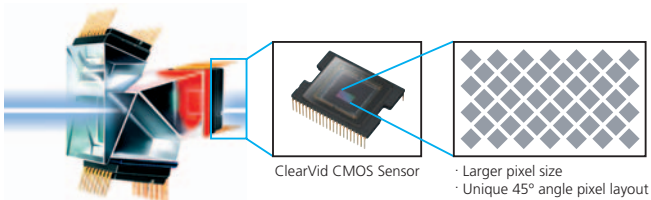

### Enhanced Imaging Processor (EIP)



The EIP is a newly developed imaging processor that brings out the full power of the 3 ClearVid CMOS Sensor imaging system. It handles video data in 1920 x 1080p and 4:2:2 color space for high-quality signal processing before recording it to tape in the HDV format\*<sup>3</sup>. Combined use of the EIP and 3 ClearVid CMOS Sensor imaging system allows the camcorder to provide extremely high image quality with a high level of gradation and detailed image reproduction.

<sup>\*3</sup> The HDV recording is in 1440 x 1080i and 4:2:0 color space.

### Carl Zeiss Vario-Sonnar T\* Lens

The HVR-V1P is equipped with a high-quality Carl Zeiss Vario-Sonnar T\* lens. Thanks to its multi-layer coating and extra-low dispersion glass, this lens offers excellent spectral characteristics, which result in virtually negligible chromatic aberrations.

### Optical 20x Lens and Optional 0.8x Wide Conversion Lens

The Vario-Sonnar T\* lens of the HVR-V1P features a 20x zoom function. Moreover, the built-in digital extender\*<sup>4</sup> increases the zoom ratio to approximately 30x. The optional VCL-HG0868K 0.8x wide conversion lens uses the bayonet mount system for instant attachment or detachment. Combining these lens features, operators can effortlessly capture close-up or wide-angle shots as their video production requires.

<sup>\*4</sup> The digital extender function is not available in progressive scan mode.

### Super SteadyShot (Optical)

The HVR-V1P employs the Super SteadyShot™ system, which has sensors that detect horizontal and vertical movements independently. It uses a prism system located behind the lens to adjust and optically compensate for unsteady camera handling.





## Switchable Recording and Playback – HDV 1080i/DVCAM/DV

The HVR-V1P can switch between HDV 1080i, DVCAM, and DV\*5 recording, providing the full flexibility to record in either standard- or high-definition format according to different production needs.

\*5 The HVR-V1P supports DV SP mode only; DV LP mode is not available.

## Down-conversion Playback Capabilities

The HVR-V1P has a built-in down-conversion capability, allowing 1080i recordings to be output as 576i signals. The 576i signals can be output from the i.LINK\*6 connector. In addition, these signals can also be output from either the analog component, composite, or S-Video connectors. This allows 1080i recordings to be edited using nonlinear editing systems running DV editing software, and viewing the 1080i recording on an SD monitor.

When down-converting these signals, the aspect ratio displayed can be converted from 16:9 to 4:3. Display modes can be selected from Squeeze, Letterbox\*7, or Edge crop.\*8

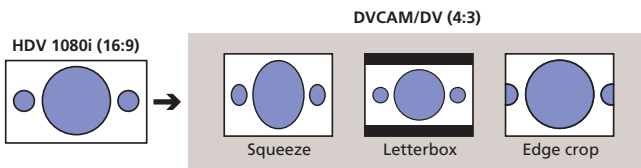

### Recording, Playback and Down-conversion Formats

Recording Format	Playback/Down Conversion Format	Output				
		i.LINK	Analog Component	HDMI	Analog Composite	S-Video
HDV1080i	1080/50i	○	○	○	—	—
	576/50i (SQ/EC)	○	△ 1	△ 2	△ 3	—
	576/50i (LB)	—	△ 1	△ 2	△ 3	—
DVCAM/DV (576/50i)	576/50i	○	△ 1	△ 2	△ 3	—

○ : Available  
 △ : Either △1 or △2 or △3 connection is available. When cables are connected to these outputs, the △ connection with a smaller number has priority.  
 SQ=Squeeze, EC=Edge Crop, LB=Letter Box

\*6 i.LINK is a trademark of Sony used only to designate that a product contains an IEEE 1394 connector. Not all products with an i.LINK connector will necessarily communicate with each other. For information on compatibility, operating conditions, and proper connection, please refer to the documentation supplied with any device with an i.LINK connector. For information on devices that include an i.LINK connection, please contact your nearest Sony office.

\*7 Letterbox mode is not available from the i.LINK connector.

\*8 Edge crop mode from the i.LINK connector will be available by a firmware upgrade. For details, please contact your nearest Sony office or authorized dealer.

## 16:9 Widescreen Acquisition in DVCAM and DV Formats

When recording in DVCAM and DV formats, standard-definition images can be captured in either 16:9 or 4:3 aspect ratio.

## 2-channel XLR Audio Input

The HVR-V1P has two XLR audio input connectors for connecting professional microphones or for receiving external-line audio sources. Microphone power of approximately 48 V can be supplied for the external condenser microphone. INPUT 1 audio can be recorded either on CH1 only or on both CH1 and CH2 audio tracks.



## Time Code Preset

The time code can be manually preset using any number in H/M/S/F (hours/minutes/seconds/frames) to record desired tape-position information. The time code mode can be selected between "REC RUN" and "FREE RUN". In addition to time code, user bits can also be set and recorded.

## Interval Recording

Interval recording is a unique function that records signals at pre-determined intervals (longer than 30 seconds) for pre-determined durations (longer than 0.5 seconds). This is ideal for recording subjects over long periods, such as the movement of clouds or the blossoming of flowers.

## Smooth Slow Rec

The Smooth Slow Rec\*<sup>9</sup> function enables clean slow-motion playback by capturing images at four times faster than the normal field rate (200 fields/s). For example, when setting the function to Fine mode, quad-speed images are captured for three seconds, stored in the built-in buffer memory, and then recorded to tape (in either HDV, DVCAM, or DV format) as slow-motion pictures lasting 12 seconds. The Smooth Slow Rec function also supports Standard and Low modes, which can record high-speed images for 6 and 12 seconds, respectively.

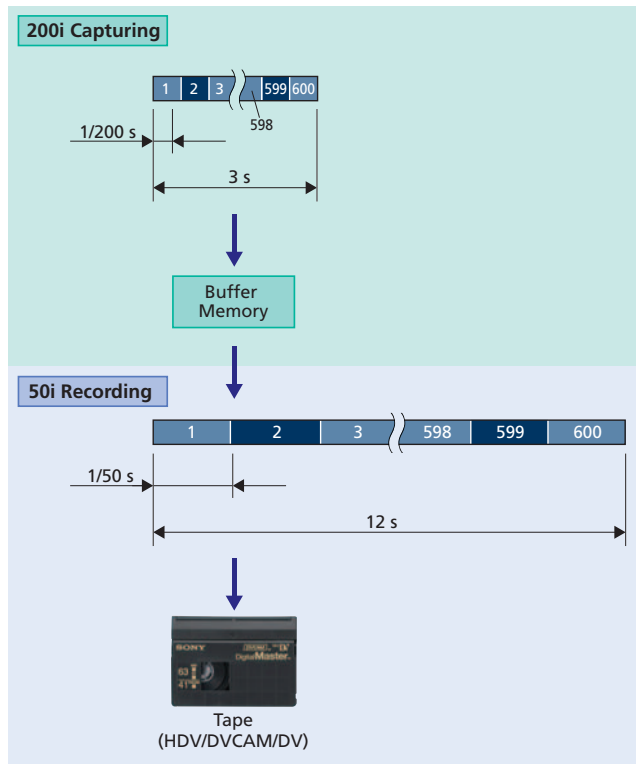

\*<sup>9</sup> When using the Smooth Slow Rec function, the resolution of the camera image decreases. For example, the resolution at Fine mode is 640 x 360 pixels. Also, audio recording is not available.

## Shot Transition Function

The Shot Transition™ function allows for smooth automatic scene transitions. After an operator has programmed a shot's start and end settings (e.g., for zoom, focus, iris, gain, shutter speed, and white balance) and pressed the start button, it ensures a smooth transition takes place over the duration of the shot by automatically calculating intermediate setting values. This is very useful when complex camera settings are required during the scene transition – for example, when panning the camcorder from a distant subject to a close subject.



Shot A

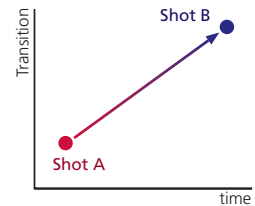

### LINEAR

Makes a linear transition.

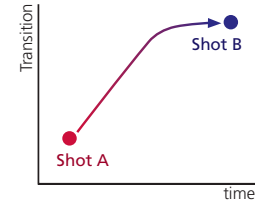

### SOFT STOP

Makes the transition slow at the end.

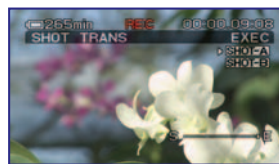

Shot B

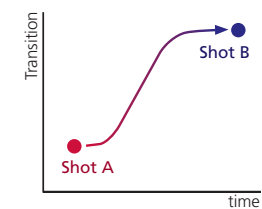

### SOFT TRANSITION

Makes the transition slow at the beginning and end, and linearly in between.

## Picture Profile™

Up to six different picture-tonal settings can be registered in the memory with desired names as picture profiles on the HVR-V1P and displayed on the LCD monitor at the touch of a button. This allows operators to easily call up customized picture-tonal settings to suit particular shooting conditions, rather than having to readjust the camera each time. The factory default setting includes six pre-loaded picture profiles for typical shooting conditions.

## Last Scene Review

At the touch of a button, the video and audio of the last shot can be instantly played back on the LCD monitor. This is achieved without even having to switch from "Camera mode" to "VTR mode". After playback, the tape is automatically cued up to the end of the last shot to continue back space editing. These features allow operators to seamlessly shoot and review material.

## Playback Zoom

Using the playback zoom function, a selected area of the recorded HD images can be enlarged and played back on the LCD monitor and viewfinder, allowing operators to check them for certain details. These enlarged images can also be output in SD format via the i.LINK and analog connectors, allowing operators to cut out parts of the HD image and use them as SD material.

## TC LINK Function for Multi-camera Operations

Using the TC LINK function, the time code of the HVR-V1P can be synchronized with another camcorder such as an HVR-Z1P, a DSR-PD170P, or a second HVR-V1P. By connecting to the other camcorder via an i.LINK cable and activating this function, the HVR-V1P's time code generator will switch to free-run mode and reset its time code to that provided from the connected camcorder. Once the time code is synchronized\*<sup>10</sup>, the i.LINK cable can be disconnected, and the next HVR-V1P that needs synchronized time code can be set up.

TC LINK is a convenient function when using the HVR-V1P in multi-camera operations, such as live-event recording and stage-shooting applications.

\*<sup>10</sup> The synchronization accuracy is within one frame.

## Long Operating Time

With the optional NP-F970 InfoLiTHIUM™ Rechargeable Battery Pack attached, the HVR-V1P can operate continuously for up to around 7 hours.

### Battery Life

Continuous Recording Time*	With LCD** Viewfinder On		With LCD** Monitor On		With LCD** Viewfinder and Monitor On	
	HDV	DVCAM/DV	HDV	DVCAM/DV	HDV	DVCAM/DV
NP-F570 (supplied)	135 min	135 min	135 min	135 min	130 min	130 min
NP-F770 (optional)	280 min	290 min	280 min	290 min	265 min	275 min
NP-F970 (optional)	415 min	430 min	415 min	430 min	395 min	410 min

\* Continuous recording time, indoors at 25C°.

\*\*With the LCD backlight on



## OPERATIONAL CONVENIENCE

### Compact and Lightweight Design

The HVR-V1P is designed to be very compact and lightweight, for a high level of mobility in the field. It weighs approximately 1.5 kg (3 lb 6 oz) (camcorder only).

### Ergonomic Design

The design of the HVR-V1P is based on years of Sony experience in camera ergonomics, and provides ease of use and operational comfort.

### Audio Level Dials

Two audio level dials are located on the carrying handle where they are easy to adjust, while avoiding inadvertent operations. The microphone power can be easily turned on and off via the mechanical switches.

### Zoom Ring and Focus Ring

The motorized zoom ring and focus rings provide a smooth and natural operational feel for fine adjustments of zoom and focus settings.

### EXPOSURE/IRIS Dial

The EXPOSURE/IRIS dial is located near the zoom and focus rings for smooth camera operations. The dial can be used to set the iris, AE shift, and exposure compensation functions, giving operators manual exposure control during auto exposure mode. The rotation direction and response for controlling these functions can be selected via the menu according to operators' preference.

### One-push AF Button

The one-push auto focus button, which is used for temporary auto focus adjustments, is located near the EXPOSURE/IRIS dial and the zoom and focus rings.

### Carrying Handle

A rubber coating is used on the bottom of the handle for slip resistance. A large space of 34.3 mm (1 3/8 inches) is offered below the handle for secure carrying of the camcorder, even when wearing gloves.

### On-handle Zoom Lever and Rec Start/Stop Button

In order to facilitate zoom control and recording operations during low-angle shooting, an additional zoom lever and a rec start/stop button are available on the carrying handle.

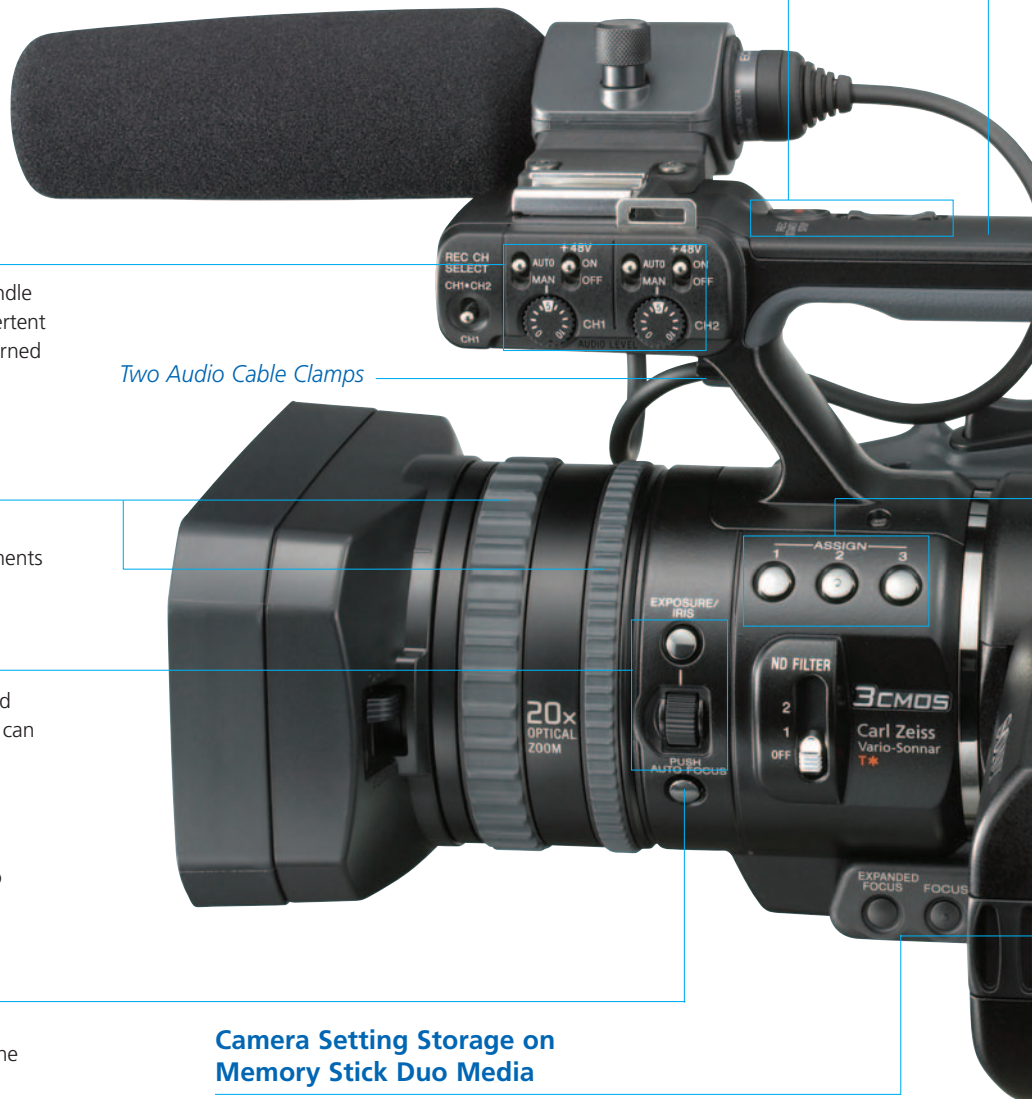

Two Audio Cable Clamps

### Camera Setting Storage on Memory Stick Duo Media

The HVR-V1P provides a convenient function to store camera setting data. It can store and recall 20 different setting configurations using Memory Stick Duo™ media, and a further two using its built-in memory. This is useful for sharing the same setting configurations among multiple cameras.



## Side Grip

The side grip is located near the camcorder's center of gravity. By tilting it to the front by approximately 10 degrees, it lightens the load on the operator's wrist during shooting.

## Color Viewfinder with Large-size Eye Cup

The HVR-V1P is equipped with a high-resolution color LCD viewfinder of approximately 211,000 pixels in a widescreen aspect ratio of 16:9. Operators can choose to display pictures in color or in black and white. In addition to a standard-size eye cup, a large-size eye cup is also supplied. This can be attached to the standard-size eye cup to provide superb light-blocking capability, easy focusing, and more comfortable use of the viewfinder.



## HDMI (High-Definition Multimedia Interface) Output Connector

The HDMI output connector transfers non-compressed, high-definition digital video and audio signals to other HDMI-equipped devices, such as consumer HDTV monitors, via a single cable.

Headphone Connector



## 3.5-inch Type Widescreen, Clear Photo LCD plus™ Monitor

The HVR-V1P is equipped with a 3.5-inch\*<sup>11</sup> type widescreen color LCD monitor, which provides enhanced brightness and a high level of color reproduction.

\*<sup>11</sup> Viewable area, measured diagonally.



With the Optional SH-L35WBP LCD Hood

## Marker

When shooting in 16:9 aspect ratio mode, markers such as 4:3, 13:9, 14:9, and 15:9 can be displayed on the LCD monitor and viewfinder, allowing scenes to be captured to match the aspect ratio of the edited master.

## Six Assign Buttons

Functions frequently used in the field can be assigned to six Assign Buttons (push buttons), allowing operators to make rapid changes depending on the shooting conditions.

The assignable functions include: Last Scene Review, Marker, Hyper Gain, Digital Extender, All Scan Mode, Spot Light, Focus Infinity, Rec Review, End Search, Index, Peaking, SteadyShot, Color Bar, Back Light, Fader, Display, and Picture Profile.

## Manual/Auto Setting Switches

Iris, gain, shutter speed, white balance, and menu buttons are located on the left side of the rear panel to avoid them being accidentally pressed during operation.

## Video Connectors

Video connectors such as i.LINK, analog component output, and multi-AV output connectors are located on the right side of the rear panel where they do not get in the way of camera operations during shooting.



**25p Progressive Shooting Capability**

Thanks to the 3 ClearVid CMOS Sensor imaging system and Enhanced Imaging Processor (EIP), the HVR-V1P supports 25p progressive scan mode, in addition to typical 50i. The signals generated by the 3 ClearVid CMOS Sensor imaging system are processed in the progressive domain as 1920 x 1080p signals, allowing high-resolution progressive footage to be captured.

The 25p progressive scan signals are recorded to tape as 50i signals by dividing each frame into two fields. This HDV material can be reverted to its original 25p form, as captured by the camera, upon ingestion to a compatible nonlinear editor\*12. This approach allows 25p progressive footage to be played back or fed to an editing suite using any of the thousands of Sony HDV solutions already in use throughout the world.

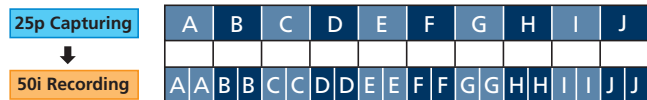

\*12 Please contact your nearest Sony office or authorized dealer for information on compatible nonlinear editors.



## A Variety of Gamma Settings

The HVR-V1P offers a choice of various gamma setting functions, which makes it ideal for use in creative productions such as cinema films and drama programs.

### ■ Cinematone Gamma

The HVR-V1P provides a special gamma feature – the Cinematone Gamma™ – which allows operators to quickly set up and load a gamma curve with similar contrast characteristics to a film gamma curve. Three gamma curves can be selected from “OFF” (normal gamma), “TYPE1”, or “TYPE2”.

#### Gamma Characteristics

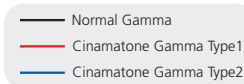
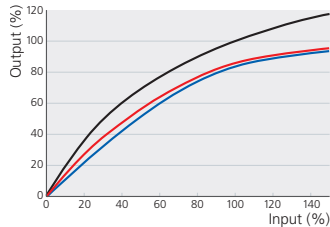

## Cinematone Color

The Cinematone Color™ function has been developed based on a thorough analysis of the color tone of cinema film, and the voices of colorists engaged in digital cinema productions.

The Cinematone Color function provides cinematic color for deep-color and high-contrast images approaching cinema film. In combined use with the Cinematone Gamma function, more cinema-quality images can be captured.



## Easy Operation for Cinematographers

The HVR-V1P can display setting values in a format that film camera operators are familiar with.

### ■ Focal Length Display in Meters or Feet

The focal length can be displayed on the LCD monitor and viewfinder in either feet (ft) or meters (m).

### ■ Shutter Speed Display in Units of Rotation Angles

Shutter speeds can also be displayed on the LCD monitor and viewfinder in units of rotation angles converted from shutter speeds.

### ■ Black Stretch and Black Compress

**Black Stretch:** Enhances the video signal levels in dark picture areas for clear reproduction of dark contrast, without sacrificing highlight contrast of the same picture.

**Black Compress:** Suppresses video signal levels in dark picture areas to emphasize the depth of dark picture tones.

### ■ Knee Correction

The knee correction function compresses the wide dynamic range acquired by the CMOS sensors into the standard video-level range. The knee point is the video level from which the signal is compressed. By changing the knee point, the image contrast above the knee point can be changed. The HVR-V1P can select knee points from high, middle, low, and auto modes to meet various production needs.

## OTHER CONVENIENT FUNCTIONS

Still Picture Recording to Memory Stick Duo Media, 2-channel Independent Audio Level Control with Audio Level Meter on LCD Monitor, Simultaneous Operation of LCD Monitor and Viewfinder, AE Shift, Hyper Gain, All Scan Mode, AF Assist, Expanded Focus, Peaking, Status Check, Battery Info, Histogram Indicator, Zebra Patterns (100% or 70%)

## HVR-DR60 HARD DISK RECORDING UNIT

Mountable on Sony HDV and DVCAM camcorders, the HVR-DR60 Hard Disk Recording Unit can streamline the entire production process.



### Long Recording Time of 4.5 Hours

Via a simple i.LINK connection, the HVR-DR60 Hard Disk Recording Unit developed by Sony allows recording of HDV 1080i signals from an HDV camcorder, or DV signals from a DVCAM camcorder. The internal 1.8-inch hard disk drive (HDD) offers a large capacity of 60 GB, which translates into a long recording time of 4.5 hours (270 minutes) for both formats.

HDV 1080i signals are recorded as native HDV files (.m2t)\*<sup>13</sup>, while DVCAM or DV signals are recorded as DV-AVI (type1)\*<sup>13</sup> or RAW-DV\*<sup>13</sup> files.

*HDV Files Stored on the HVR-DR60 Displayed on a PC Monitor*

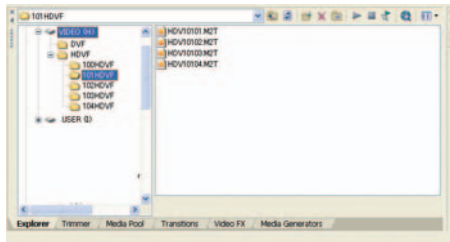

\*<sup>13</sup> During playback, interruptions in video may appear between recordings. These interruptions do not occur after the recordings are copied to an i.LINK compatible nonlinear editor system via the i.LINK connection, and the recordings can be correctly edited. For information on compatible nonlinear editors, please contact your nearest Sony office or authorized dealer.

### Hybrid Operation for Reliable Recording and Archiving

The HVR-DR60 offers a hybrid recording function, in which video and audio material is recorded simultaneously to the hard disk and tape, so important shots are always secured against loss or accidental deletion. This hybrid function also facilitates instant archiving of source footage – which in most cases does not allow for retakes. After a shoot, operators can immediately archive the source tape and use the HVR-DR60 material as work footage. This saves the time and effort required to copy the original data to a separate high-capacity medium.

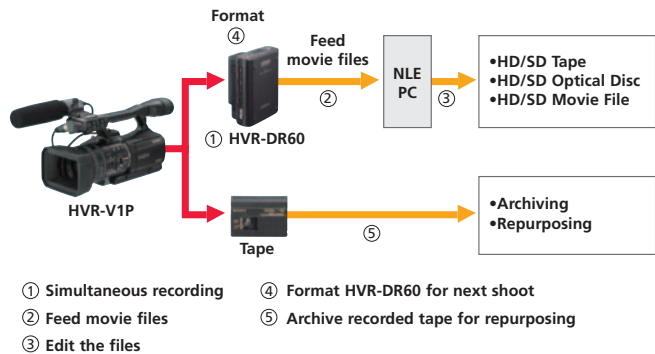



## Direct File Access from a PC

When connected to a PC via i.LINK, the HVR-DR60 is recognized as a standard external drive, and its recorded footage can be accessed directly like any normal video file. This saves the time previously required for digitizing material from the tape to PC.



Furthermore, video files stored on the HVR-DR60 can be transferred to a PC running compatible nonlinear editing software at a high speed of approximately 80 Mb/s (around three times faster than real time), which drastically reduces the time needed to copy source material to the editor's local drive. These features allow operators to focus on more creative and productive editing tasks.

## Ideal Companion for the HVR-V1P

The HVR-DR60 can be used with existing HDV/DV-CAM camcorders equipped with an i.LINK interface such as the HVR-Z1P and DSR-PD170P. However, when used with the HVR-V1P, it offers some additional features only available in this combination.

### ■ Checking the Operational Status on the HVR-V1P

On the LCD monitor and viewfinder of the HVR-V1P, the operational status of the HVR-DR60 – such as connection, recording format, battery level, remaining recording time, recording folder name, etc. – can be checked. This keeps operators informed of both the camcorder and hard drive status, without taking their eyes away from what is being shot.



HVR-DR60 Status Check

### ■ Tapeless Recording

To trigger recording of the HVR-DR60, most HDV camcorders require a tape to be loaded. However, this is not the case with the HVR-V1P. The HVR-V1P sends the same rec start/stop trigger that controls its tape transport to the HVR-DR60. This feature offers operators the choice of tapeless operation or hybrid operation.

## HDD Smart Protection – Robust Recording and Shock Resistance

Three advanced technologies are used to ensure the reliable recording performance of the HVR-DR60:

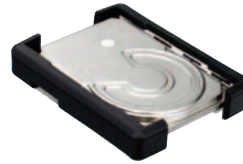

Shock Absorbers

1) Rubber shock absorbers hold the HDD unit in place, preventing external shock from being transmitted when the HVR-DR60 chassis is subject to impact.

2) A 3G sensor detects gravitational acceleration in three dimensions, so however the HVR-DR60 may be oriented, the sensor can detect if it has been dropped. Should this occur, power to the HDD is shut off and the recording heads are retracted from the disk platter, pausing read/write operations.



3G Sensor

This protects the HDD from being damaged when the unit is accidentally dropped and subject to strong impact.

3) A buffer memory can store approximately 14 seconds of video and audio footage. Recordings are made by first writing the data to the buffer, and then writing the buffer data to the disk platter. Consequently, if the 3G sensor temporarily interrupts disk writes, video footage is not lost.

Thanks to such advanced technologies, the HVR-DR60 will continue to record stably even when dropped from as high as 100 cm (39 3/8 inches).

## Long Operating Hours Using Common Camcorder Batteries

The HVR-DR60 uses the same inoLITHIUM L Series batteries as the HVR-V1P, HVR-Z1P, and DSR-PD170P camcorders. With the smallest capacity NP-F570 battery, the HVR-DR60 can run continuously for 5.5 hours (330 min), and with the largest capacity NP-F970, this increases to 18 hours (1080 min). Long operating hours are offered using such camcorder batteries that HDV operators already have at hand.

## Compact and Perfect Balance

The HVR-DR60 measures just 81 x 45 x 100 mm (3 1/4 x 1 3/4 x 4 inches) in size and only about 230 g (8 oz) in weight. It can be mounted on a camcorder's cold shoe using the supplied shoe adapter, or attached using an optional VCT-1BP Bracket.

# SYSTEM DIAGRAM

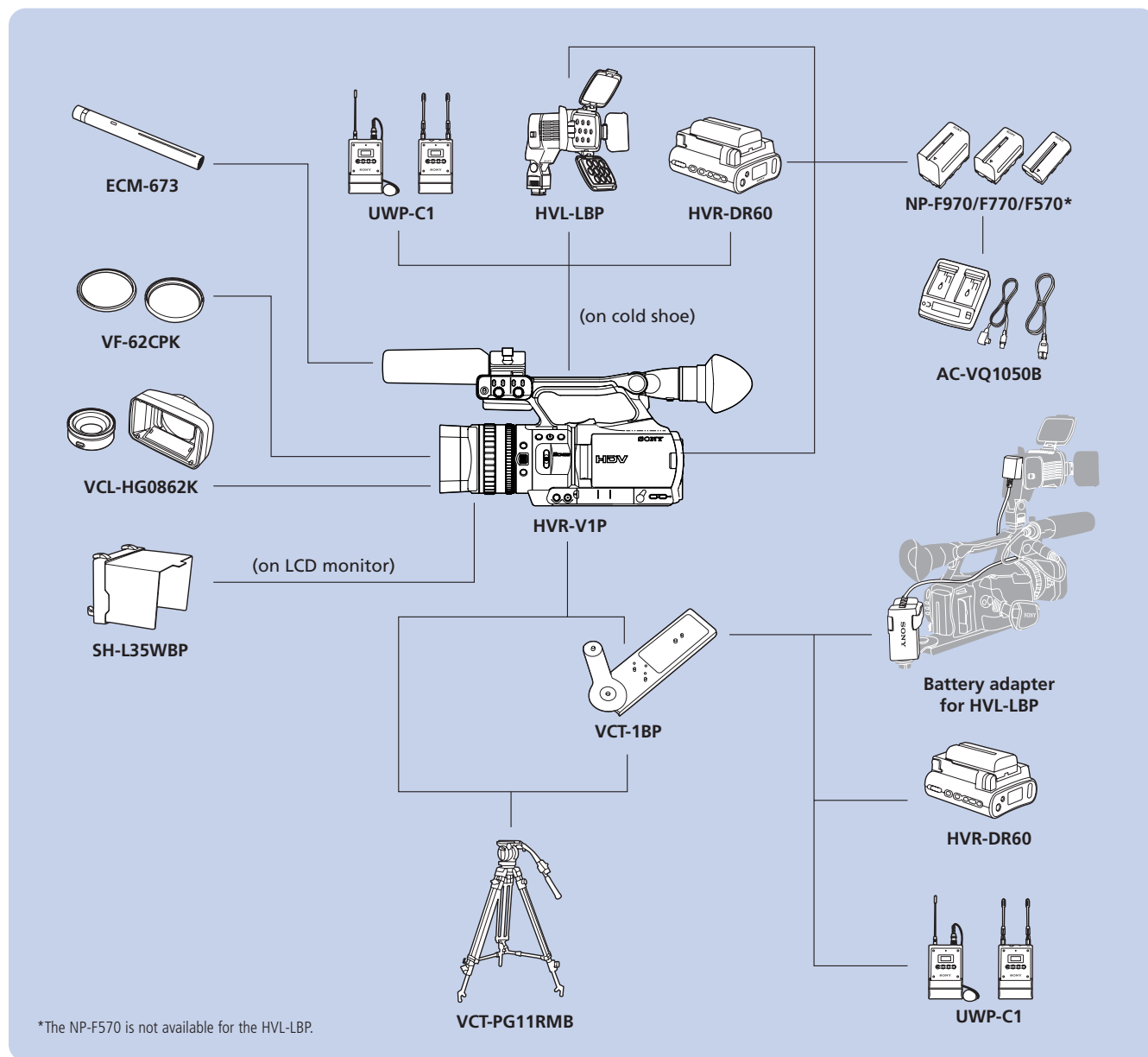

# DIMENSIONS

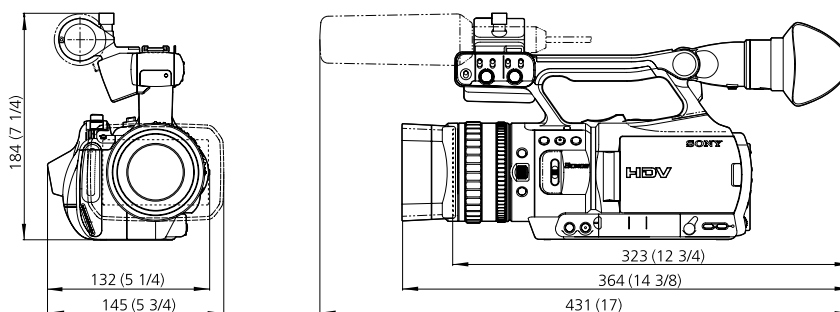

Unit: mm (inches)



# ACCESSORIES

A range of accessories for the HVR-V1P broadens shooting opportunities.



**VCL-HG0862K**  
0.8x Wide Conversion Lens

- Bayonet mount for easy attachment and detachment
- Lens hood supplied
- $\phi 86$  mm filter available without attaching the lens hood



**HVL-LBP**  
LED Light

- Brightness of 600 lx (1 m), life of approx. 10,000 hours (whole unit), and power consumption of 16 W
- Ideal for wide-angle shooting
- Uniform lighting over the entire projected area
- Spotlight projection with supplied condensing lens attached
- Light diffuser attached to soften shadows and reduce contrast
- Compatible with HVR-V1P batteries, such as the NP-F770/F970
- Long operating time: approximately 3 hours with the NP-F970 (at maximum brightness)



**2NP-F970**  
InfoLITHIUM Rechargeable Battery Pack



**NP-F570/F770/F970**  
InfoLITHIUM Rechargeable Battery Pack



**VF-62CPK PL**  
Filter Kit ( $\phi 62$  mm)



**RM-1BP**  
LANC Remote Controller



**VCT-PG11RMB**  
Video Tripod with RM-1BP Remote Control



**SH-L35WBP**  
LCD Hood



**VCT-1BP**  
bracket



**LCS-G1BP**  
Soft Carrying Case



**LCH-FXA**  
Hard Carrying Case



**PHDVM-63DM**  
DigitalMaster™ Mini Cassette Tape



**UWP-C1**  
UHF Synthesized Wireless Microphone Package



**ECM-673**  
Electret Condenser Microphone



**AC-VQ1050B**  
Battery Charger



**VMC-IL4408A/IL4415/IL4435**  
i.LINK Cable (4-pin to 4-pin)



**VMC-IL4615/IL4635**  
i.LINK Cable (4-pin to 6-pin)



**DLC-HM15/HM30/HM50**  
HDMI Cable (1.5/3/5 m)

# SPECIFICATIONS

Camera section	
Lens	Carl Zeiss Vario-Sonnar T* zoom lens, 20x (optical), f = 3.9 to 78 mm, f = 37.4 to 748 mm* at 16:9 mode f = 45.7 to 914 mm* at 4:3 mode, F = 1.6 to 2.8, filter diameter: 62 mm
Built-in filter	1/4 ND, 1/16 ND
Focus	Auto, manual (focus ring/one push auto/infinity)
Imaging system	1/4-inch type, 3 ClearVid CMOS Sensor system
Picture elements	Approx. 1,037,000 pixels (effective), approx. 1,120,000 pixels (total)
White balance	Auto, one-push auto (2 positions), indoor (3200 K), outdoor (5800 K +15steps)
Manual shutter speed	1/3, 1/6, 1/12, 1/25, 1/50, 1/60, 1/100, 1/120, 1/150, 1/215, 1/300, 1/425, 1/600, 1/1000, 1/1250, 1/1750, 1/2500, 1/3500, 1/6000, 1/10000 s
Exposure	Auto, manual (Type1/Type2)
Gain	0, 3, 6, 9, 12, 15, 18 dB
Minimum illumination	4 lx with F1.6 at 18 dB
VTR section	
Recording format	1080/50i, 576/50i (PAL)
Play out/Down conversion format	1080/50i, 576/50i (PAL)
Tape speed	HDV/DV SP Max. 18.812 mm/s DVCAM Max. 28.218 mm/s
Playback/Recording time	HDV/DV SP Max. 63 min with PHDVM-63DM cassette DVCAM Max. 41 min with PHDVM-63DM cassette
Fast forward/Rewind time	Approx. 1 min 45 s with PHDVM-63DM cassette (AC adaptor) Approx. 2 min 40 s with PHDVM-63DM cassette (battery pack)
Input/Output connectors	
Audio/Video output	A/V OUT jack, 10-pin connector Composite video: 1 Vp-p, 75 Ω unbalanced, sync negative Y: 1 Vp-p, 75 Ω unbalanced C: 0.3 Vp-p (burst signal), 75 Ω unbalanced Audio: 327 mV input impedance more than 47 kΩ, output impedance less than 2.2 kΩ
Component video output	COMPONENT OUT jack Y: 1 Vp-p, 75 Ω unbalanced Pr/Pb (Cr/Cb): 700 mVp-p, 75 Ω unbalanced
HDV/DV input/output	i.LINK interface (IEEE 1394, 4-pin connector S100)
XLR audio input	XLR 3-pin female x 2, 327 mV, -60 dBu: 3 kΩ, +40 dBu: 10.8 kΩ, power supply: approx. 48 V
Headphone	Stereo mini jack (φ3.5 mm)
LANC	Stereo mini-mini jack (φ2.5 mm)
USB	Mini-B connector
HDMI output	HDMI connector
Built-in output devices	
LCD viewfinder	0.54-inch** type, approx. 252,000 dots, 16:9 aspect ratio
LCD monitor	3.5-inch** type, Clear Photo LCD plus, approx. 211,200 dots, hybrid type, 16:9 aspect ratio
Speaker	φ16mm
General	
Mass	Approx. 1.5 kg (3 lb 6 oz) (camcorder only)
Power requirements	DC 7.2 V (battery pack), DC 8.4 V (AC adaptor)
Power consumption	HDV Approx. 6.8 W (recording mode with LCD viewfinder or monitor on) DVCAM/DV Approx. 6.6 W (recording mode with LCD viewfinder or monitor on)
Operating temperature	0 to 40 °C (32 to 104 °F)
Storage temperature	-20 to +60 °C (-4 to +140 °F)
Supplied accessories	AC-L15 AC adaptor Power cord NP-F570 infoLITHIUM rechargeable battery pack A/V connecting cable, component video cable, USB cable lens hood with lens cover RMT-831 wireless Remote Commander™ ECM-NV1 monaural electrolet condenser microphone Operating instructions(CD-ROM) Printed operating instructions

\* These values are calculated to be equivalent to the 35 mm film.

\*\* Viewable area, measured diagonally.

## Distributed by

© 2007 Sony Corporation of Hong Kong Ltd. All rights reserved.  
Sony is a registered trademark of the Sony Corporation.  
Reproduction in whole or in part without permission is prohibited.  
Features and specifications are subject to change without notice.  
All non-metric weights and measurements are approximate.  
Sony, DVCAM, ClearVid CMOS Sensor, Enhanced Imaging Processor, DigitalMaster, SteadyShot, i.LINK, InfoLITHIUM, Memory Stick Duo, and their respective logos are trademarks of Sony Corporation.  
Picture Profile, Shot Transition, Clear Photo LCD plus, Cinematone Gamma, and Cinematone Color are trademarks of Sony Corporation.  
3 ClearVid CMOS Sensor logo is a trademark of Sony Corporation.  
HDV and the HDV logo are trademarks of Sony Corporation and Victor Company of Japan, Limited.  
Vario-Sonnar T\* is a trademark of Carl Zeiss AG.