

FM/AM Clock Radio

ICF-C1iP

Operating Instructions

DREAM MACHINE

Dream Machine is a trademark of Sony Corporation.



No Power No problem is a trademark of Sony Corporation.

Owner's Record

The model number and the serial number are located on the rear exterior. Record the serial number in the space provided below. Refer to them whenever you call upon your Sony dealer regarding this product.

Model No. ICF-C1iP

Serial No. _____

For customers who purchased this product in the USA
Please register this product on line at <http://www.sony.com/productregistration>. Proper registration will enable us to send you periodic mailings about new products, services, and other important announcements. Registering your product will also allow us to contact you in the unlikely event that the product needs adjustment or modification. Thank you.

WARNING

To reduce the risk of fire or electric shock, do not expose this apparatus to rain or moisture. To reduce the risk of electrical shock, do not open the cabinet. Refer servicing to qualified personnel only.

To reduce the risk of fire, do not cover the ventilation of the apparatus with newspapers, tablecloths, curtains, etc. And do not place lighted candles on the apparatus.

The apparatus shall not be exposed to dripping or splashing and that no objects filled with liquids, such as vases, shall be placed on the apparatus.

Do not install the appliance in a confined space, such as a bookcase or built-in cabinet.

As the main plug is used to disconnect the unit from the mains, connect the unit to an easily accessible AC outlet. Should you notice an abnormality in the unit, disconnect the main plug from the AC outlet immediately.

You are cautioned that any changes or modifications not expressly approved in this manual could void your authority to operate this equipment.

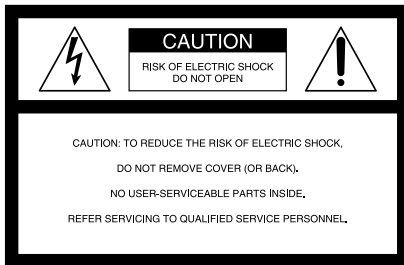

This symbol is intended to alert the user to the presence of uninsulated "dangerous voltage" within the product's enclosure that may be of sufficient magnitude to constitute a risk of electric shock to persons.

This symbol is intended to alert the user to the presence of important operating and maintenance (servicing) instructions in the literature accompanying the appliance.

INFORMATION

This equipment has been tested and found to comply with the limits for a Class B digital device, pursuant to Part 15 of the FCC Rules. These limits are designed to provide reasonable protection against harmful interference in a residential installation. This equipment generates, uses and can radiate radio frequency energy and, if not installed and used in accordance with the instructions, may cause harmful interference to radio communications. However, there is no guarantee that interference will not occur in a particular installation. If this equipment does cause harmful interference to radio or television reception, which can be determined by turning the equipment off and on, the user is encouraged to try to correct the interference by one or more of the following measures:

- Reorient or relocate the receiving antenna.
- Increase the separation between the equipment and receiver.
- Connect the equipment into an outlet on a circuit different from that to which the receiver is connected.
- Consult the dealer or an experienced radio/TV technician for help.

WARNING

- Danger of explosion if battery is incorrectly replaced. Replace only with the same or equivalent type.
- Replace the battery for the clock backup with a Sony CR2032 lithium battery, and the battery for the remote commander with a Sony CR2025 lithium battery. Use of another battery may present a risk of fire or explosion.
- Battery may explode if mistreated. Do not recharge, disassemble or dispose of in fire.
- Do not expose the battery to excessive heat such as direct sunlight, fire or the like.
- Dispose of used battery promptly. Keep away from children.

Important Safety Instructions

- 1) Read these instructions.
- 2) Keep these instructions.
- 3) Heed all warnings.
- 4) Follow all instructions.
- 5) Do not use this apparatus near water.
- 6) Clean only with dry cloth.
- 7) Do not block any ventilation openings. Install in accordance with the manufacturer's instructions.
- 8) Do not install near any heat sources such as radiators, heat registers, stoves, or other apparatus (including amplifiers) that produce heat.
- 9) Do not defeat the safety purpose of the polarized or grounding-type plug. A polarized plug has two blades with one wider than the other. A grounding type plug has two blades and a third grounding prong. The wide blade or the third prong are provided for your safety. If the provided plug does not fit into your outlet, consult an electrician for replacement of the obsolete outlet.
- 10) Protect the power cord from being walked on or pinched particularly at plugs, convenience receptacles, and the point where they exit from the apparatus.
- 11) Only use attachments/accessories specified by the manufacturer.
- 12) Use only with the cart, stand, tripod, bracket, or table specified by the manufacturer, or sold with the apparatus. When a cart is used, use caution when moving the cart/apparatus combination to avoid injury from tip-over.



13) Unplug this apparatus during lightning storms or when unused for long periods of time.

14) Refer all servicing to qualified service personnel. Servicing is required when the apparatus has been damaged in any way, such as power-supply cord or plug is damaged, liquid has been spilled or objects have fallen into the apparatus, the apparatus has been exposed to rain or moisture, does not operate normally, or has been dropped.

For the state of california, USA only

Perchlorate Material—special handling may apply. See www.dtsc.ca.gov/hazardouswaste/perchlorate
Perchlorate Material: Lithium battery contains perchlorate

Features

- Dual alarm FM/AM Clock radio with iPod dock.
- Various type of alarms- iPod, radio and buzzer.
- Automatic time set — When you plug the clock in for the first time, the current time will be shown in the display.
- Automatic Daylight Saving Time/Summer time adjustment.
- CLOCK button to display month, day and year.
- Brightness control (High/Middle/Low).
- No Power No Problem™ alarm system to keep the clock and the alarm operating during a power interruption with a CR2032 battery installed.

Troubleshooting

Should any problem occur with the unit, make the following simple checks to determine whether or not servicing is required.

If the problem persists, consult your nearest Sony dealer.

The clock displays "AM 12:00" due to a power interruption.

- The battery is low. Replace the battery. Remove the old battery and install a new one.

When daylight saving time begins, the clock does not employ the daylight saving time automatically.

- Make sure the clock is set correctly.
- Press and hold **CLOCK** and **TIME ZONE/ALARM DISPLAY** simultaneously for at least two seconds to employ the DST function.

The alarm does not sound at the preset alarm time.

- Has the desired alarm been activated? (i.e., Does the **ALARM A** (or **B**) indicator light up?)

The radio or iPod alarm is activated but no sound comes on at the preset alarm time.

- Has **VOLUME** been adjusted?

There is no sound from the iPod.

- Make sure the iPod is securely connected.
- Adjust the **VOLUME**.

The iPod cannot be operated with this unit.

- Make sure the iPod is securely connected.

The iPod cannot be charged.

- Make sure the iPod is securely connected.

Precautions

- Operate the unit on the power sources specified in "Specifications".
- To disconnect the power cord (mains lead), pull it out by the plug, not the cord.
- The unit is not disconnected from the AC power source (mains) as long as it is connected to the wall outlet, even if the unit itself has been turned off.
- Do not leave the unit in a location near a heat source, such as a radiator or airduct, or in a place subject to direct sunlight, excessive dust, mechanical vibration, or shock.
- Allow adequate air circulation to prevent internal heat build-up. Do not place the unit on a surface (a rug, blanket, etc.) or near materials (a curtain) that might block the ventilation holes.
- Should any solid object or liquid fall into the unit, unplug the unit and have it checked by qualified personnel before operating it any further.
- To clean the casing, use a soft cloth dampened with a mild detergent solution.

NOTES ON LITHIUM BATTERY

- Wipe the battery with a dry cloth to assure a good contact.
- Be sure to observe the correct polarity when installing the battery.
- Do not hold the battery with metallic tweezers, otherwise a short-circuit may occur.

If you have any questions or problems concerning your unit, please consult your nearest Sony dealer.

Specifications

Time display

12-hour System

Frequency range

Band	Frequency
FM	87.5 – 108 MHz
AM	530 – 1 710 kHz

Speaker

Approx. 5.1 cm (2 inches) dia., 12 Ω

Power output

3 W + 3 W (at 10% harmonic distortion)

Power requirements

120 V AC, 60 Hz

For clock backup: 3 V DC, one CR2032 battery

Dimensions

Approx. 300 × 130 × 139 mm (w/h/d)
(11 7/16 × 5 1/8 × 5 1/2 inches) incl. projecting parts and controls

Mass

Approx. 1.86 kg (4 lb 1.61 oz) incl. CR2032 battery

Supplied accessories

Remote commander (1)
Audio connecting cable (1)
AM loop antenna (1)

Design and specifications are subject to change without notice.

Connecting the antenna

To connect the AM loop antenna

The shape and the length of the antenna is designed to receive AM signals. Do not dismantle or roll up the antenna.

- 1 Remove only the loop part from the plastic stand.
- 2 Set up the AM loop antenna.

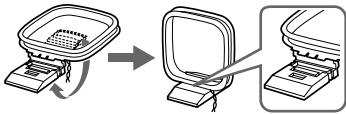

- 3 Connect the cords to the AM antenna terminals. The cords (A and B) can be connected to either terminal.

Insert the cord while pushing down the terminal clamp.

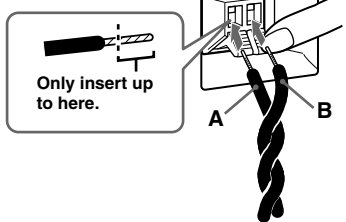

Only insert up to here.

- 4 Make sure the AM loop antenna is connected firmly by pulling softly.

Adjusting the AM loop antenna

Find a place and an orientation that provide good reception.

- Do not place the AM loop antenna near the unit or other AV equipment, as noise may result.
- If you use an external polarized AM antenna, be sure to connect the ground cord to the θ terminal. The supplied AM antenna cord has no polarity.

Tip

Adjust the direction of the AM loop antenna for best AM broadcast sound.

SONY

Portable Audio

LIMITED WARRANTY (U.S. Only)

Sony Electronics Inc. ("Sony") warrants this product against defects in material or workmanship for the time periods and as set forth below. Pursuant to this Limited Warranty, Sony will, at its option, (i) repair the product using new or refurbished parts or (ii) replace the product with a new or refurbished product. For purposes of this Limited Warranty, "refurbished" means a product or part that has been returned to its original specifications. **In the event of a defect, these are your exclusive remedies.**

Labor: For a period of one (1) year from the original date of purchase of the product ("Labor Warranty"), Sony will, at its option, repair or replace with new or refurbished product, product determined to be defective. If Sony elects to replace the product after this Labor Warranty has expired but while the Parts Warranty below is still in effect, it will do so for the applicable labor charge.

Parts: For a period of one (1) year from the original date of purchase of product ("Parts Warranty"), Sony will supply new or refurbished replacement parts in exchange for parts determined to be defective.

This Limited Warranty covers only the hardware components packaged with the Product. It does not cover technical assistance for hardware or software usage and it does not cover any software products whether or not contained in the Product; any such software is provided "AS IS" unless expressly provided for in any enclosed software Limited Warranty. Please refer to the End User License Agreements included with the Product for your rights and obligations with respect to the software.

Instructions: To obtain warranty service, you must deliver the product, freight prepaid, in either its original packaging or packaging affording an equal degree of protection to the Sony authorized service facility specified. **It is your responsibility to backup any data, software or other materials you may have stored or preserved on your unit. It is likely that such data, software, or other materials will be lost or reformatted during service and Sony will not be responsible for any such damage or loss.** A dated purchase receipt is required. For specific instructions on how to obtain warranty service for your product,

Visit Sony's Web Site:
www.sony.com/service

Or call the **Sony Customer Information Service Center**
1-800-222-SONY (7669)

For an accessory or part not available from your authorized dealer, call:
1-800-488-SONY (7669)

Repair / Replacement Warranty: This Limited Warranty shall apply to any repair, replacement part or replacement product for the remainder of the original Limited Warranty period or for ninety (90) days, whichever is longer. Any parts or product replaced under this Limited Warranty will become the property of Sony.

This Limited Warranty only covers product issues caused by defects in material or workmanship during ordinary consumer use; it does not cover product issues caused by any other reason, including but not limited to product issues due to commercial use, acts of God, misuse, limitations of technology, or modification of or to any part of the Sony product. This Limited Warranty does not cover Sony products sold AS IS or WITH ALL FAULTS or consumables (such as fuses or batteries). This Limited Warranty is invalid if the factory-applied serial number has been altered or removed from the product. This Limited Warranty is valid only in the United States.

LIMITATION ON DAMAGES: SONY SHALL NOT BE LIABLE FOR ANY INCIDENTAL OR CONSEQUENTIAL DAMAGES FOR BREACH OF ANY EXPRESS OR IMPLIED WARRANTY ON THIS PRODUCT.

DURATION OF IMPLIED WARRANTIES: EXCEPT TO THE EXTENT PROHIBITED BY APPLICABLE LAW, ANY IMPLIED WARRANTY OF MERCHANTABILITY OR FITNESS FOR A PARTICULAR PURPOSE ON THIS PRODUCT IS LIMITED IN DURATION TO THE DURATION OF THIS WARRANTY.

Some states do not allow the exclusion or limitation of incidental or consequential damages, or allow limitations on how long an implied warranty lasts, so the above limitations or exclusions may not apply to you. This Limited Warranty gives you specific legal rights and you may have other rights which vary from state to state.

D455714503

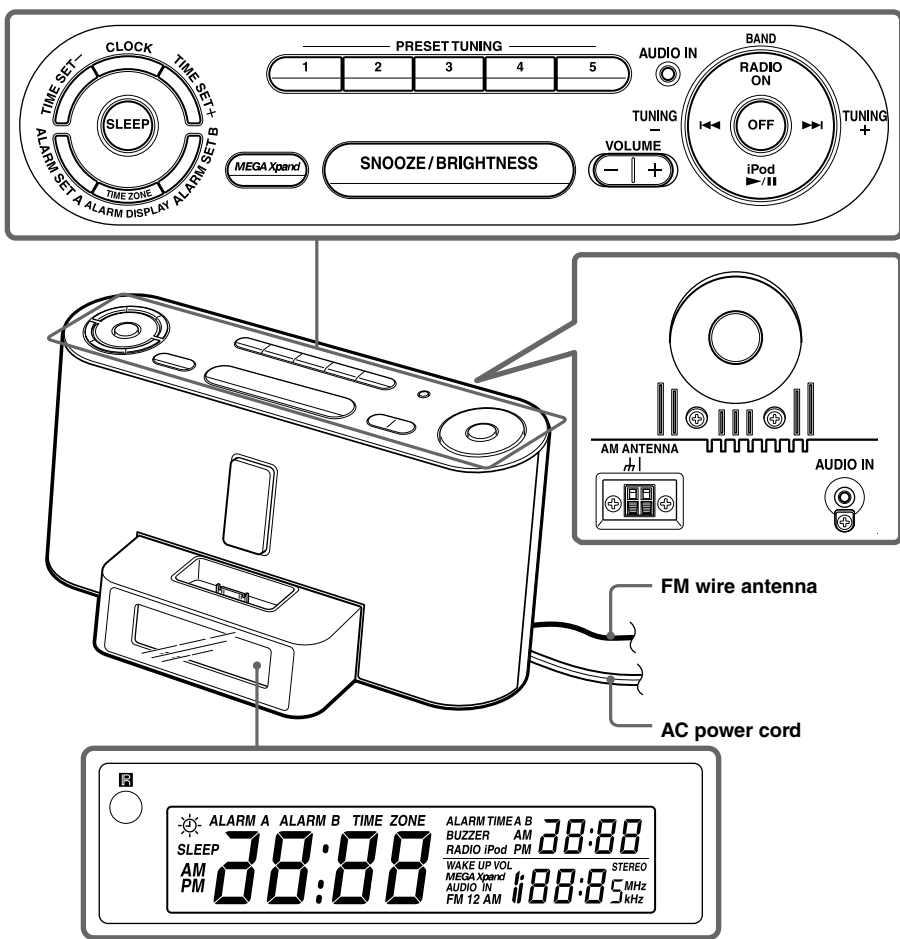

There is a tactile dot on the VOLUME +, ►/II and PRESET TUNING 3 button.

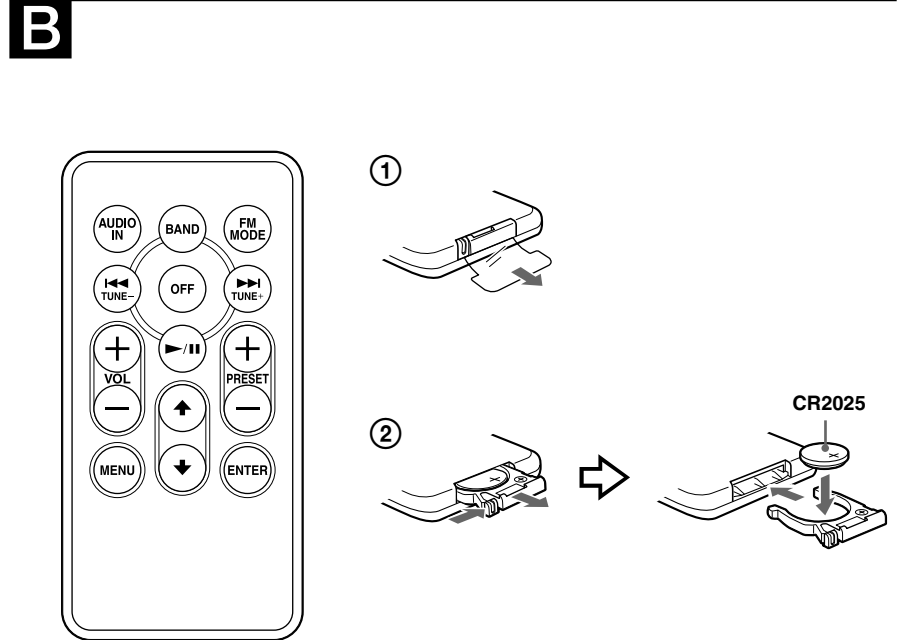
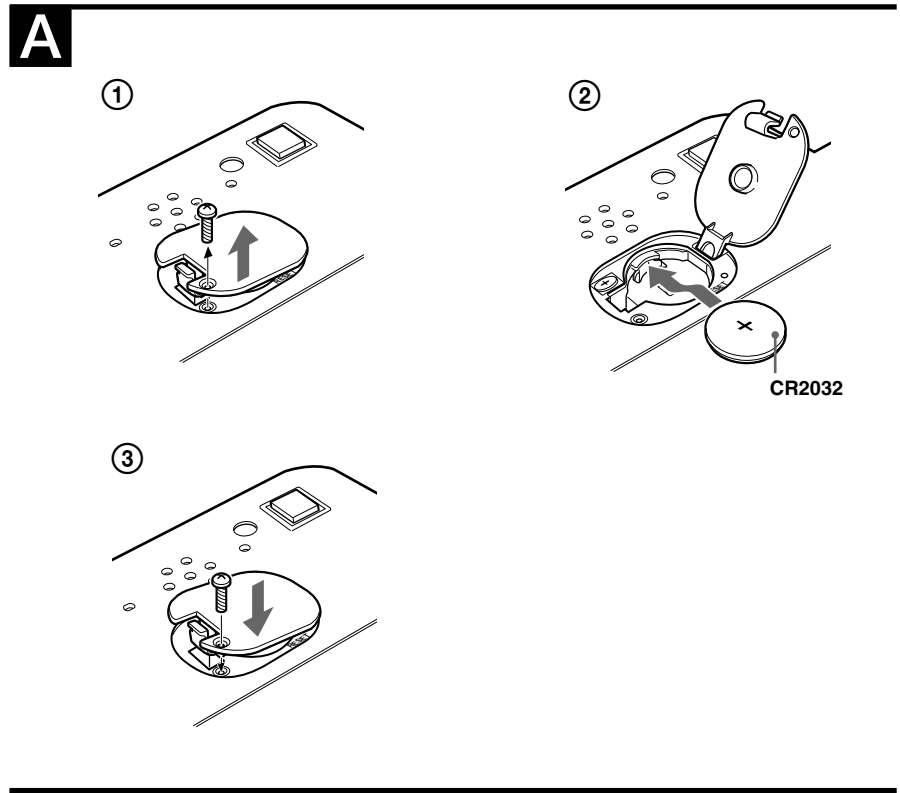

There is a tactile dot on the VOL +, ►/II, ↑ and PRESET + button.

About the backup battery

To keep good time, as a backup power source, this unit has one CR2032 battery inside of the unit in addition to the house current. The battery keeps the clock and the alarm operating in the event of a power interruption.

Knowing when to replace the battery

If a power interruption occurs when the battery is weak, the brightness of characters in the display darkens. If the battery runs out during the interruption, the current time and alarm functions will be initialized.

Replace the battery with a Sony CR2032 lithium battery. Use of another battery may present a risk of fire or explosion.

Replacing the backup battery

- Keep the AC plug connected to the AC outlet, remove the screw that secures the battery compartment at the bottom of the unit using a screwdriver, and remove the battery compartment. (See Fig. A-①)
- Insert a new battery in the battery compartment with the + side facing up. To remove the battery from the battery compartment, push it out from the side marked PUSH. (See Fig. A-②)
- Insert the battery compartment back into the unit and secure it with the screw. (See Fig. A-③)

Note

When you replace the battery, keep the AC plug connected to a wall outlet. Otherwise, current time and alarms will be initialized if the replacement is not completed within around one minute.

If the time in the display is incorrect after the battery is changed (RESET)

Push the Reset switch with the pointed device. The Reset switch is in the small hole located in the battery compartment.

Notes

- You cannot reset unless the lithium battery is installed.
- Set the clock again after the unit is reset.

Battery Warning

When the unit will be left unplugged for a long time, remove the battery to avoid undue battery discharge and damage to the unit from battery leakage.

Preparing the remote commander

Before using the card remote commander for the first time, remove the insulation film. (See Fig. B-①)

When to replace the battery

With normal use, the battery (CR2025) should last for about six months. When the remote commander no longer operates the unit, replace the battery with new ones. (See Fig. B-②)

Notes

- Do not charge the battery.
- When you are not going to use the remote commander for a long time, remove the battery to avoid any damage caused by leakage and corrosion.

Setting the clock for the first time

This unit is preset to the current date and time at the factory, and is powered by the back up battery. All you need to do the first time is just plug it in and select your time zone.

- Plug in the unit.
- Press **TIME ZONE** for more than two seconds. Area number "2" appears in the display. If you live in the Eastern Time zone, you do not need to adjust the area setting.

Area number	Time zone
1	Atlantic Standard/Daylight Time
2	Eastern Standard/Daylight Time (default)
3	Central Standard/Daylight Time
4	Mountain Standard/Daylight Time
5	Pacific Standard/Daylight Time
6	Yukon Standard/Daylight Time
7	Hawaiian Standard/Daylight Time

- Press **TIME SET +** or **-** repeatedly until the desired number appears.
- Press **TIME ZONE** to complete the setting.

Note

During the shipment and your first use, a clock error may occur. In this case, refer to "Setting the clock and date" to set the correct time.

When daylight saving time (summer time) begins

This model employs the Automatic Daylight Saving Time/Summer Time adjustment. The DST indicator in the display appears in the display at the beginning of the daylight saving time (summer time), and disappears at the end of it.

- Daylight saving time begins at: 2:00 AM on the second Sunday of March.
- Standard time begins at: 2:00 AM on the first Sunday of November.

To deactivate the Automatic DST/Summer Time adjustment during the daylight saving time (summer time) period.

The Automatic DST/Summer Time adjustment can be cancelled. Press **CLOCK** and **TIME ZONE/ALARM DISPLAY** for more than two seconds. The Automatic DST/Summer Time adjustment will be cancelled. To activate the Automatic DST/Summer Time adjustment again, repeat the same operation.

Setting the clock and date

To change the setting manually, follow the procedure from step 1.

- Press **CLOCK** for more than 2 seconds. The year will start to flash in the display.
- Press **TIME SET +** or **-** until the correct year appears in the display.
- Press **CLOCK**.
- Repeat steps 2 and 3 to set the month, day and time. After setting the minute the clock starts from 0 seconds. But if you do not set "Minute", the clock does not start from 0 second flat.

- Pressing and holding **+** or **-** changes the year, month, day or time rapidly.
- While setting the clock, you must perform each step within about 65 seconds, or the clock setting mode will be cancelled.

To display the year and date

Press **CLOCK** once for the date, and within about 5 seconds press it again for the year. The display shows the date or year for about 5 seconds and then changes back to the current time.

Setting the brightness of the display

Three levels of brightness are available by pressing **SNOOZE/BRIGHTNESS**.

High (default) → Middle → Low

Playing the iPod

You can enjoy iPod audio by connecting this unit. To use an iPod, refer to the user's guide of your iPod.

Compatible iPod models

The compatible iPod models are as follows. Update your iPod to use the latest software before you use it.

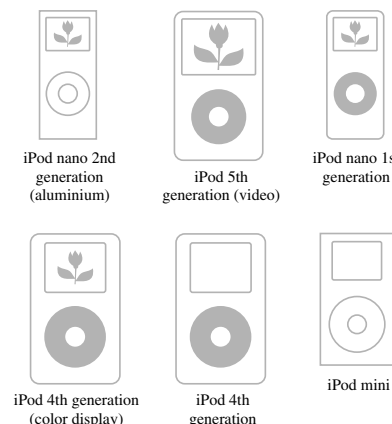

Notes

- The connector of the unit is for sole use for iPod. When you use the devices do not match with the connector, connect it to the **AUDIO IN** terminal of this unit with the supplied audio connecting cable.
- Sony cannot accept responsibility in the event that data recorded to iPod is lost or damaged when using an iPod connected to this unit.

- Put the iPod into the unit's connector.

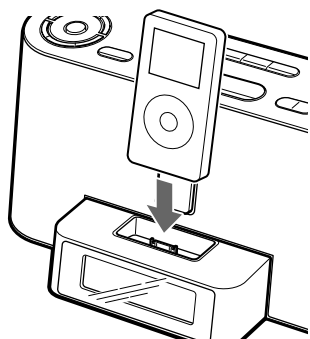

Adjust the rear support forward or backward checking the back of the iPod fits snugly against the rear support to protect the connector.

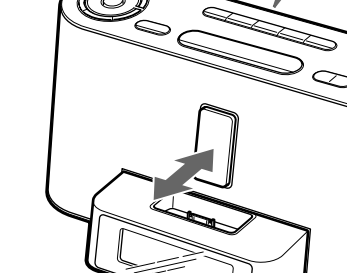
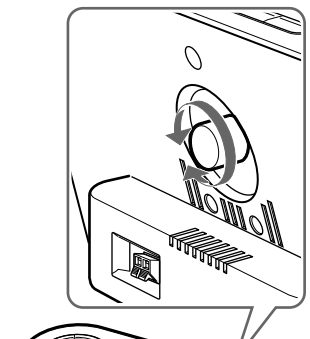

- Press **►/II**.

The iPod begins to play automatically. You can operate the connected iPod by the unit or iPod buttons.

To	Press
Turn off the iPod	OFF , or press and hold ►/II
Pause playback	►/II To resume play, press it again.
Go to the next track	►►
Go back to the previous track	◄◄
Locate a point while listening to the sound	►► (forward) or ◄◄ (backward) while playing and hold it until you find the point.
Locate a point while observing the display	►► (forward) or ◄◄ (backward) in pause and hold it until you find the point.
Go back to the previous menu	MENU*
Select a menu item or a track for playback	↑/↓*
Execute the selected menu or the playback	ENTER*

* These operations are available only when using the supplied remote commander.

Notes

- When placing or removing the iPod, keep it straight and parallel with the rear support.
- Do not carry the unit with an iPod set on the connector. Doing so may cause a malfunction.
- When placing or removing the iPod, brace the unit with one hand and take care not to press the controls of the iPod by mistake.
- Do not pull on the rear support strongly as it cannot be detached from the unit and may cause a malfunction.
- To use an iPod, refer to the user's guide of your iPod.
- Before disconnecting the iPod, pause playback.

Tip

Apple's iPod Universal Dock Adapter can be used with this unit.

To use the unit as a battery charger

You can use the unit as a battery charger. The charging begins when the iPod is placed on the connector. The charging status appears in the iPod display. For details, see the user's guide of your iPod.

On copyrights

- iPod is a trademark of Apple Inc., registered in the U.S. and other countries.
- All other trademarks and registered trademarks are of their respective holders. In this manual, TM and [®] marks are not specified.

Playing the radio —Manual Tuning

- Press **RADIO ON** to turn on the radio. The display shows the band and frequency.



- Press **RADIO ON** repeatedly to select the desired band. Each press changes the band as follows:

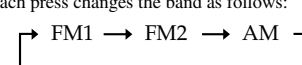

FM1 and FM2 are the same frequency bands.

- Use **TUNING +** or **-** to tune into the desired station. The FM frequency advances or reverses in 0.1 MHz channel steps and the AM frequency in 10 kHz channel steps.

- Adjust volume using **VOLUME**.

To turn off the radio, press **OFF**.

Improving the Reception

- FM:** Extend the FM wire antenna fully to increase reception sensitivity.
- AM:** Connect the supplied AM loop antenna to the unit. Rotate the antenna horizontally for optimum reception.

Keep away iPod from the AM loop antenna or the FM wire antenna, as this may lead to interference of reception.

Tip

If the FM broadcast is noisy, press **FM MODE** on the remote commander to turn off "STEREO" in the display. The radio becomes clearer although the sound becomes monaural.

Presetting Your Favourite Station —Preset Tuning

You can preset up to 10 stations in FM (5 stations in FM1, 5 stations in FM2), and 5 stations in AM.

Presetting a Station

- Follow steps 1 to 4 in "Playing the Radio" and manually tune into the station you wish to preset.
- Press and hold the desired **PRESET TUNING** button for more than two seconds for registration. After the preset has finished, the preset number appears on the display.

Example: To preset AM 1 260 kHz onto preset 2 button.



a few seconds after ↓

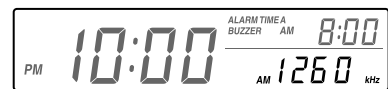

To preset another station, repeat these steps.

To change the preset station, tune into the desired station and hold down the **PRESET TUNING 1** to **5** button. The new station will replace the previous station on the preset button.

Tuning into a preset station

- Press **RADIO ON** to turn on the radio.
- Press one of the **PRESET TUNING** buttons where the desired station is stored.
- Adjust volume using **VOLUME**.

Setting the alarm

The dual alarm function allows you to set two alarm programs (ALARM A and ALARM B). The alarm time can be set for each program and the alarm sound is selectable from RADIO, BUZZER or iPod.

Notes

- Before setting the alarm, make sure to set the clock (see "Setting the clock and date").
- The factory setting alarm time is "AM 12:00".
- To set the radio alarm, first tune in to a station (see "Playing the radio").

To set the alarm time

To set **ALARM A**

- Press **ALARM SET A** for a few seconds.
- Press **TIME SET +/-** to set the desired hour, and press **ALARM SET A**.
- Press **TIME SET +/-** to set the desired minute, and press **ALARM SET A**.
- Press **TIME SET +/-** to set the desired alarm mode (RADIO, BUZZER or iPod) and press **ALARM SET A**.
- If you select the RADIO or iPod, press **TIME SET +/-** to set the wake up volume and press **ALARM SET A**.

To set **ALARM B**, follow the same steps above using **ALARM B** instead of **ALARM A**.

To change the display between **ALARM TIME A** and **ALARM TIME B**, press **TIME ZONE/ALARM DISPLAY**.

Notes

- When you use the radio alarm, the timed alarm sounds with the last broadcasting station tuned to before the power went off. When you set the radio alarm, select the desired broadcasting station before turning the power off.
- The **ALARM A** (or **B**) indicator flashes in the display when the alarm sounds.
- If a second alarm sounds during a first (or the **SNOOZE** function is active), the second alarm takes priority.
- The alarm function works as usual at the beginning and end day of the daylight saving time (summer time). While the Automatic DST/Summer Time adjustment is set, as a result, if the alarm is set at a time skipped when the daylight saving time (summer time) begins, the alarm is skipped, or if the alarm is set at a time overlapped when the daylight saving time (summer time) ends, the alarm sounds twice.
- If the same alarm time is set for both alarm (ALARM A and B), the ALARM A takes priority.

To activate the alarm

After setting the alarm time, follow these steps: To activate the **ALARM A**, press **ALARM SET A** to display **ALARM A**. To activate the **ALARM B**, press **ALARM SET B** to display **ALARM B**.

Notes

- The alarm sounds at the set time even if the unit is on.
- Make sure the iPod is installed correctly after setting the iPod alarm.

To doze for a few more minutes

Press **SNOOZE/BRIGHTNESS**. The sound turns off but will automatically come on again after about 5 minutes. The maximum length of the snooze time is 40 minutes.

To stop the Alarm

Press **OFF** to turn off the alarm. The alarm will come on sound again at the same time the next day. If **OFF** is not pressed, the buzzer alarm sounds continuously for about 3 minutes, and then it stops automatically. The RADIO and iPod sound continuously until **OFF** is pressed.

To deactivate the Alarm

Press **ALARM SET A** (or **B**) to turn off the **ALARM A** (or **B**) indicator from the display.

Note on alarm in the event of a power interruption

- When the alarm sound is set to RADIO or iPod, it will change to **BUZZER** automatically.
- If the backup battery is exhausted, the alarm will not work in the event of power interruption. Replace the battery periodically.

Setting the sleep timer

You can fall asleep to the sound using the built-in sleep timer that turns off the unit automatically after a preset duration.

- Press **SLEEP** while the unit is turned on. **SLEEP** appears in the display.
- Press **SLEEP** to set the sleep timer duration. Each time you press **SLEEP**, the duration changes as follows:

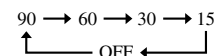

The display returns to clock mode five seconds after you have finished setting the duration setting and released **SLEEP**, and then the sleep timer starts. The unit will play for the duration you set, and then shut off.

To turn off the unit before the preset time

Press **OFF**.

To use both sleep timer and alarm

You can fall asleep to the radio and also be awakened by the radio or buzzer alarm at the preset time.

- Set the alarm. (See "Setting the alarm".)
- Set the sleep timer. (See "Setting the sleep timer".)

Other useful functions

To get the MEGA Xpand effect

Press **MEGA Xpand**. "MEGA Xpand" appears in the display. You can get the effect of expansion of the sound field. To return to normal sound, press the button again.

Connecting external equipment

To listen to sound

- Connect the **AUDIO IN** jack of the unit to the line out jack or headphone jack of the external equipment using the audio connecting cable (supplied).

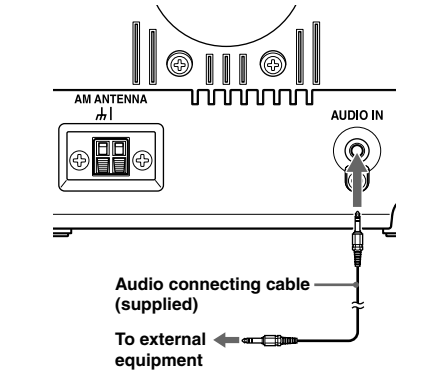

- Press **AUDIO IN** to display "AUDIO IN".
- Play the equipment connected to the **AUDIO IN** jack.
- Adjust the volume using **VOLUME**.

To return to the radio

Press **RADIO ON**. The frequency is shown in the display.

To return to the iPod

Press **►/II**.

To stop listening

Press **OFF**, and stop playback on the connected unit.