

LCD Color TV

Operating Instructions

WEGA

KLVS19A10 KLVS26A10
KLVS23A10 KLVS32A10

Owner's Record

The model and serial numbers are located at the rear of the TV. Record these numbers in the spaces provided below. Refer to them whenever you call upon your Sony dealer regarding this product.

Model No. _____

Serial No. _____

Contacting Sony

If, after reading these operating instructions, you have additional questions related to the use of your Sony TV, please call our Customer Information Services Center at 1-800-222-SONY (7669) (US residents only) or 1-877-899-SONY (7669) (Canadian residents only).

WARNING

To reduce the risk of fire or electric shock, do not expose this apparatus to rain or moisture.



This symbol is intended to alert the user to the presence of uninsulated "dangerous voltage" within the product's enclosure that may be of sufficient magnitude to constitute a risk of electric shock to persons.



This symbol is intended to alert the user to the presence of important operating and maintenance (servicing) instructions in the literature accompanying the appliance.

The apparatus shall not be exposed to dripping or splashing and no objects filled with liquids, such as vases, shall be placed on the apparatus.

CAUTION

To prevent electric shock, do not use this polarized AC plug with an extension cord, receptacle or other outlet unless the blades can be fully inserted to prevent blade exposure.

Note on Caption Vision

This TV provides display of TV closed captioning in accordance with §15.119 of the FCC rules.

For Customers in the United States

If you have any questions about this product, you may call; Sony Customer Information Services Center 1-800-222-7669 or <http://www.sony.com/>

Declaration of Conformity

Trade Name: SONY
Model: KLV-S19A10/KLV-S23A10/
KLV-S26A10/KLV-S32A10
Responsible Party: Sony Electronics Inc.
Address: 16450 W. Bernardo Dr,
San Diego, CA 92127 U.S.A.
Telephone Number: 858-942-2230

This device complies with part 15 of the FCC rules. Operation is subject to the following two conditions: (1) This device may not cause harmful interference, and (2) this device must accept any interference received, including interference that may cause undesired operation.

NOTIFICATION

This equipment has been tested and found to comply with the limits for a Class B digital device, pursuant to Part 15 of the FCC Rules. These limits are designed to provide reasonable protection against harmful interference in a residential installation. This equipment generates, uses and can radiate radio frequency energy and, if not installed and used in accordance with the instructions, may cause harmful interference to radio communications. However, there is no guarantee that interference will not occur in a particular installation. If this equipment does cause harmful interference to radio or television reception, which can be determined by turning the equipment off and on, the user is encouraged to try to correct the interference by one or more of the following measures:

- Reorient or relocate the receiving antenna.
- Increase the separation between the equipment and receiver.
- Connect the equipment into an outlet on a circuit different from that to which the receiver is connected.
- Consult the dealer or an experienced radio/TV technician for help.

You are cautioned that any changes or modifications not expressly approved in this manual could void your authority to operate this equipment.

For Customers in Canada

This Class B digital apparatus complies with Canadian ICES-003.

Safety

- Operate the TV only on 120 V-240 V AC.
- Use the AC power cord specified by Sony and suitable for the voltage where you use it.
- The plug is designed, for safety purposes, to fit into the wall outlet only one way. If you are unable to insert the plug fully into the outlet, contact your dealer.

- If any liquid or solid object should fall inside the cabinet, unplug the TV immediately and have it checked by qualified service personnel before operating it further.
- If you will not be using the TV for several days, disconnect the power by pulling the plug itself. Never pull on the cord.
- For details concerning safety precautions, see "Important Safety Instructions" on page 4 and "Important Safeguards" on page 5.

Installing

- The TV should be installed near an easily accessible power outlet.
- To prevent internal heat buildup, do not block the ventilation openings.
- Do not install the TV in a hot or humid place, or in a place subject to excessive dust or mechanical vibration.
- Avoid operating the TV at temperatures below 5°C (41°F).
- If the TV is transported directly from a cold to a warm location, or if the room temperature changes suddenly, the picture may be blurred or show poor color due to moisture condensation. In this case, please wait a few hours to let the moisture evaporate before turning on the TV.
- To obtain the best picture, do not expose the screen to direct illumination or direct sunlight. It is recommended to use spot lighting directed down from the ceiling or to cover the windows that face the screen with opaque drapery. It is desirable to install the TV in a room where the floor and walls are not of a reflective material.

CAUTION

Use the following Sony appliance(s) only with the following WALL-MOUNT BRACKET.

Use with other WALL-MOUNT BRACKET may cause instability and possibly result in injury.

SONY APPLIANCE MODEL NO.

KLV-S19A10

KLV-S23A10

KLV-S26A10

KLV-S32A10

SONY WALL-MOUNT BRACKET MODEL NO.

SU-WL11 (KLV-S19A10)

SU-WL31 (KLV-S23A10/KLV-S26A10/
KLV-S32A10)

To Customers

Sufficient expertise is required for installing the specified product. Be sure to subcontract the installation to Sony dealers or licensed contractors and pay adequate attention to safety during the installation.

(Continued)

For Customers in the United States

This product contains mercury. Disposal of this product may be regulated if sold in the United States. For disposal or recycling information, please contact your local authorities or the Electronics Industries Alliance (<http://www.eiae.org>).

To Sony Dealers

For installation of SONY WALL-MOUNT BRACKET, be sure to read and follow the instructions supplied with those optional products.

Trademark Information

“PlayStation” is a trademark of Sony Computer Entertainment, Inc.

TruSurround, SRS and the  symbol are trademarks of SRS Labs, Inc. TruSurround technology is incorporated under license from SRS Labs, Inc.

Licensed by BBE Sound, Inc. under USP4638258, 4482866. “BBE” and BBE symbol are trademarks of BBE Sound, Inc.

Macintosh is a trademark licensed to Apple Computer, Inc., registered in the U.S.A and other countries.

Wega, Steady Sound and CineMotion are registered trademarks of Sony Corporation.

For KLV-S23A10/KLV-S26A10/KLV-S32A10





As an ENERGY STAR® Partner, Sony Corporation has determined that this product meets the ENERGY STAR® guidelines for energy efficiency.

ENERGY STAR® is a U.S. registered mark.

HDMI This TV incorporates High-Definition Multimedia Interface (HDMI™) technology. HDMI, the HDMI logo and High-Definition Multimedia Interface are trademarks or registered trademarks of HDMI Licensing LLC.

Important Safety Instructions

- 1) Read these instructions.
 - 2) Keep these instructions.
 - 3) Heed all warnings.
 - 4) Follow all instructions.
 - 5) Do not use this apparatus near water.
 - 6) Clean only with dry cloth.
 - 7) Do not block any ventilation openings. Install in accordance with the manufacturer's instructions.
 - 8) Do not install near any heat sources such as radiators, heat registers, stoves, or other apparatus (including amplifiers) that produce heat.
- 
- The diagram shows a television set with several wavy lines radiating from its back, representing heat. The lines are labeled with the words "HEAT" and "SOURCES".
- 9) Do not defeat the safety purpose of the polarized or grounding-type plug. A polarized plug has two blades with one wider than the other. A grounding type plug has two blades and a third grounding prong. The wide blade or the third prong are provided for your safety. If the provided plug does not fit into your outlet, consult an electrician for replacement of the obsolete outlet.
 - 10) Protect the power cord from being walked on or pinched particularly at plugs, convenience receptacles, and the point where they exit from the apparatus.
 - 11) Only use attachments/accessories specified by the manufacturer.
 - 12) Use only with the cart, stand, tripod, bracket, or table specified by the manufacturer, or sold with the apparatus. When a cart is used, use caution when moving the cart/apparatus combination to avoid injury from tip-over.
- 
- The icon shows a lightning bolt striking a power plug, enclosed in a circle with a diagonal slash, indicating a warning against using the device during lightning storms.
- 13) Unplug this apparatus during lightning storms or when unused for long periods of time.
 - 14) Refer all servicing to qualified service personnel. Servicing is required when the apparatus has been damaged in any way, such as power-supply cord or plug is damaged, liquid has been spilled or objects have fallen into the apparatus, the apparatus has been exposed to rain or moisture, does not operate normally, or has been dropped.

Important Safeguards

Before using your TV, please read these instructions completely, and keep this manual for future reference.

Carefully observe and comply with all warnings, cautions and instructions placed on the unit or described in the operating instructions or service manual.

WARNING

To guard against injury, the following basic safety precautions should be observed in the installation, use and servicing of the unit.

Use

Power Sources

This unit should be operated only from the type of power source indicated on the information label. If you are not sure of the type of electrical power supplied to your home, consult your dealer or local power company.



Grounding or Polarization

This unit is equipped with a polarized AC power cord plug (a plug having one blade wider than the other), or with a three-wire grounding type plug (a plug having a third pin for grounding). Follow the instructions below:

For the unit with a polarized AC power cord plug

This plug will fit into the power outlet only one way. This is a safety feature. If you are unable to insert the plug fully into the outlet, try reversing the plug.

If the plug still fails to fit, contact your electrician to have a suitable outlet installed. Do not defeat the safety purpose of the polarized plug by forcing it in.

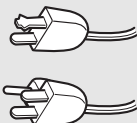

Wall outlet

Do not use a poor fitting outlet.

Insert the plug fully into the outlet. If it is loose, it may cause arcing and result in fire.

Contact your electrician to have the outlet changed.



Wiring

For your safety, unplug the AC power cord when wiring cables.

Electric shock

Do not touch the AC power cord or the unit with a wet hand. If you plug/unplug the AC power cord from the unit with a wet hand, it may cause electric shock.



Cleaning

- Clean the AC power plug regularly. If the plug is covered with dust and it picks up moisture, its insulation may deteriorate and result in fire. Unplug the AC power plug and clean it regularly.



- Unplug the AC power cord when cleaning this unit. If not, it may result in electric shock.



- Clean the cabinet of the TV with a dry soft cloth. To remove dust from the screen, wipe it gently with a soft cloth. Stubborn stains may be removed with a cloth slightly dampened with a solution of mild soap and warm water. Never use strong solvents such as thinner or benzene for cleaning.
- If using a chemically pretreated cloth, please follow the instruction provided on the package.
- If the picture becomes dark after using the TV for a long period of time, it may be necessary to clean the inside of the TV. Consult qualified service personnel.

Overloading

Do not overload wall outlets, extension cords or convenience receptacles beyond their capacity, since this can result in fire or electric shock.



Power

Always turn the unit off when it is not being used. When the unit is left unattended and unused for long periods of time, unplug it from the wall outlet as a precaution against the possibility of an internal malfunction that could create a fire hazard.



Sound

If a snapping or popping sound from the TV is continuous or frequent while the TV is operating, unplug the TV and consult your dealer or service technician. It is normal for TV's to make occasional snapping or popping sounds, particularly when being turned on or off.



AC Power Cord

If you damage the AC power cord, it may result in fire or electric shock.

- Do not pinch, bend, or twist the cord excessively. The core lines may be bared and cut, and cause short-circuit, resulting in fire or electric shock.
- Do not convert or damage the AC power cord.
- Do not put anything heavy on the AC power cord. Do not pull the AC power cord.
- Keep the AC power cord away from heat sources.
- Be sure to grasp the plug when disconnecting the AC power cord.

If the AC power cord is damaged, stop using it and ask your dealer or Sony service center to exchange it.

Batteries

Do not dispose of batteries in a fire.

Do not short circuit, disassemble or overheat the batteries.

Disposal of used batteries

To preserve our environment, dispose of used batteries according to your local laws or regulations.

Ventilation holes

Never push objects of any kind into the unit through the cabinet slots as they may touch dangerous voltage points or short out parts that could result in a fire or electric shock. Never spill liquid of any kind on the unit.



Objects and Liquid Entry

Do not place any objects on the unit.

The apparatus shall not be exposed to dripping or splashing and no objects filled with liquids, such as vases, shall be placed on the apparatus.



Attachments

Do not use attachments not recommended by the manufacturer, as they may cause hazards.

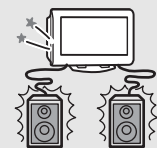

(Continued)

Medical institution

Do not place this unit in a place where medical equipment is in use.

It may cause malfunction of medical instruments.



Moisture and flammable objects

- Do not use plugged sets near water — for example, near a bathtub, washbowl, kitchen sink, or laundry tub, in a wet basement, or near a swimming pool, etc. It may result in fire or electric shock.
- Do not let this unit get wet. Never spill liquid of any kind on the unit. If any liquid or solid object does fall through, do not operate the unit. It may result in electric shock or damage to the unit. Have it checked immediately by qualified personnel.
- To prevent fire, keep flammable objects or open flame (e.g. candles) away from the unit.



Accessories

Do not place the unit on an unstable cart, stand, table or shelf. The unit may fall, causing serious injury to a child or an adult and serious damage to the unit. No part of the TV should overhang any edge of the TV cart or stand; any overhanging edge is a safety hazard. An appliance and cart combination should be moved with care. Quick stops, excessive force, and uneven surfaces may cause the appliance and cart combination to overturn.



Broken pieces

Do not throw anything at the unit.

The screen glass may break by the impact and cause serious injury.

Cable wiring

Take care not to catch your feet on the cables. It may damage the unit.

Heat

Do not touch the surface of the TV.

It remains hot, even for some time after the TV is turned off.

Volume adjustment

- Adjust the volume so as not to trouble your neighbors. Sound carries very easily at night time. Therefore, closing the windows or using headphones is suggested.
- When using headphones, adjust the volume so as to avoid excessive levels, as hearing damage may result.

Disposal of the TV

- Do not dispose the TV with general household waste.
- The LCD contains a small amount of liquid crystal. The fluorescent tube used in this display contains mercury. Follow your local ordinances and regulations for disposal.

Handling of broken glass and liquid crystal leakage

If the LCD panel gets damaged, crystalline liquid leakage may occur, or scattered broken glass may result. Do not touch broken glass or crystalline liquid (which is toxic), with bare hands as cuts or poisoning/skin irritation may occur. Also, do not let glass fragments or leaked crystalline liquid get into your eyes or mouth. Should either contact your eyes or mouth, rinse the contacted area thoroughly with water and consult your doctor.

LCD screen

- Although the LCD screen is made with high-precision technology and has effective pixels of 99.99% or more, black dots may appear or bright points of light (red, blue, or green) may appear constantly on the LCD screen. This is a structural property of the LCD panel and is not a malfunction.
- Do not expose the LCD screen surface to the sun. Doing so may damage the screen surface.
- Do not push or scratch the LCD screen, or place objects on top of the TV. The image may be uneven or the LCD panel may be damaged.
- If the TV is used in a cold place, a smear may occur in the picture or the picture may become dark. This does not indicate a failure. These phenomena improve as the temperature rises.
- Ghosting may occur when still pictures are displayed continuously. It may disappear after a few moments.
- The screen and cabinet get warm when the TV is in use. This is not a malfunction.
- Avoid spraying insect repellent with volatile material to the screen.
- Avoid prolonged contact with rubber or plastic made material.

Fluorescent lamp

This TV uses a special fluorescent lamp as its light source. If the screen image becomes dark, flickers, or does not appear, the fluorescent lamp has run down and should be replaced. For replacement, consult qualified service personnel.

Installation

Installation

- When installing or removing the TV on the wall, be sure to use qualified contractors. Wall mount installation requires the use of a wall-mount bracket. If the TV is installed or removed from the wall by a person other than a qualified contractor, the unit may fall and cause serious injury if the unit is not installed securely.
- To prevent injury, this apparatus must be securely attached to the stand/wall in accordance with the installation instructions.
- Carrying the model KLV-S32A10 requires two or more people.



Placement for viewing

It is recommended to watch the TV at a distance of 3 to 7 times that of the screen height, and in moderate brightness. Watching the TV for too long or in a dark room will cause eye fatigue.

Optional accessories

- Observe the following when installing the TV using a wall-mount bracket. If the TV is not secured properly, it may fall and cause injury.
- Be sure to follow the operating instructions supplied with the wall-mount bracket when installing the unit.
 - Be sure to attach the brackets supplied with the wall-mount bracket.



Protruding location

Do not install the TV in protruding locations. If you install the unit in the following locations, injury may result.

- Do not install the unit in a location where the unit protrudes, such as pillars.
- Do not install the unit in a location that may cause injury.

Oils

Do not install this unit in restaurants where oily vapors occur. Dust absorbing oil may enter into the unit and damage the unit.

Corrosion

Use of this TV near the seashore may subject the set to excessive salt, corrosion and internal damage and result in deterioration of the TV's performance. If the set will be subjected to these conditions, steps should be taken to reduce the humidity and temperature of the area where the TV is located.

Ventilation

The slots and openings in the TV are provided for necessary ventilation. To ensure reliable operation of the unit, and to protect it from overheating, these slots and openings must never be blocked or covered. Unless proper ventilation is provided, the unit may gather dust and get dirty. For proper ventilation, observe the following:

- Do not install the unit turned backward or sideways.
- Do not install the unit turned over or upside down.
- Never cover the slots and openings with a cloth or other materials.

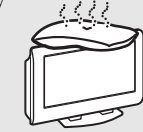

- Never block the slots and openings by placing the unit on a bed, sofa, rug or other similar surface.



- Never place the unit in a confined space, such as a bookcase or built-in cabinet, unless proper ventilation is provided.

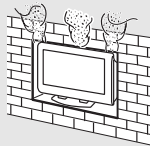

- Leave some space around the unit and the AC power adaptor. Otherwise, adequate air-circulation may be blocked causing overheating and cause fire or damage the unit.

When installing the unit on the wall, allow this much space.

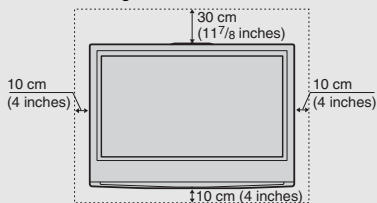

When installing the unit using a stand, allow this much space.

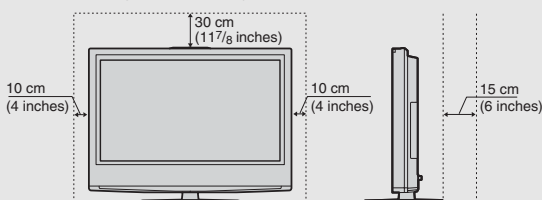

KLVS19A10 only

When installing the AC power adaptor, allow this much space.

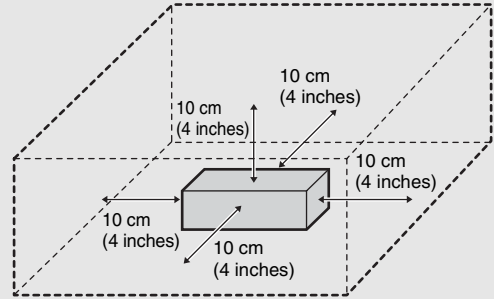

Never install the unit as follows:

Air circulation is blocked.

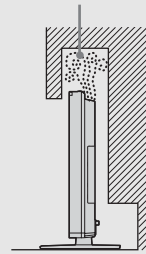

Air circulation is blocked.

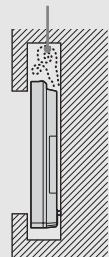

Outdoor use

Do not install this unit outdoors. If the unit is exposed to rain, it may result in fire or electric shock. If the unit is exposed to direct sunlight, the unit may heat up and cause damage to the unit.



Vehicle and ceiling

Do not install this unit in a vehicle or hang from the ceiling.

Bumping of the vehicle may cause the unit to fall down and cause injury.



Ship and vessel

Do not install this unit in a ship or vessel. If the unit is exposed to seawater, it may cause fire or damage the unit.



Preventing the TV from toppling over

Take measures to prevent the unit from toppling over and causing injury. To prevent the unit from toppling over, secure the unit to the wall or pillar.

Installing on a level surface

If you install the unit on a non-level surface, the unit may fall or drop and cause injury or damage.



(Continued)

Placing on a stable surface

If you place the unit on an unstable surface, the unit may fall and cause injury or damage.



Fall

Do not hang anything on the unit. The unit may fall from the stand or wall-mount bracket, causing damage or serious injury.



AC power cord

Unplug the AC power cord when moving the unit. Do not move the unit with the AC power cord plugged in. It may damage the AC power cord and result in fire or electric shock. Do not allow anything to rest on or roll over the power cord, and do not place the unit where the power cord is subject to wear or abuse.

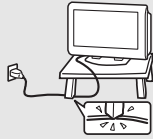

Antennas

Outdoor Antenna Grounding

If an outdoor antenna is installed, follow the precautions below. An outdoor antenna system should not be located in the vicinity of overhead power lines or other electric light or power circuits, or where it can come in contact with such power lines or circuits.

WHEN INSTALLING AN OUTDOOR ANTENNA SYSTEM, EXTREME CARE SHOULD BE TAKEN TO KEEP FROM CONTACTING SUCH POWER LINES OR CIRCUITS AS CONTACT WITH THEM IS ALMOST INVARIABLY FATAL.

Be sure the antenna system is grounded so as to provide some protection against voltage surges and built-up static charges.

Section 810 of the National Electrical Code (NEC) in USA and Section 54 of the Canadian Electrical Code in Canada provides information with respect to proper grounding of the mast and supporting structure, grounding of the lead-in wire to an antenna discharge unit, size of grounding conductors, location of antenna discharge unit, connection to grounding electrodes, and requirements for the grounding electrode.

Antenna Grounding According to the National Electrical Code, ANSI/NFPA 70

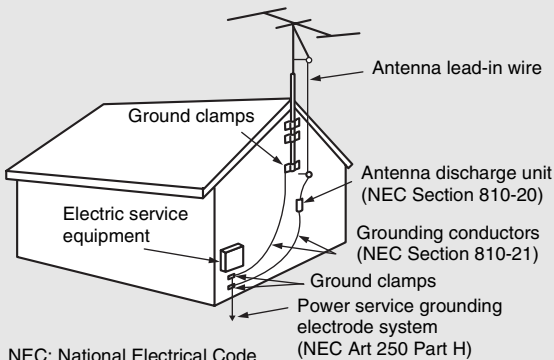





Lightning

For added protection for this TV during a lightning storm, or when it is left unattended and unused for long periods of time, unplug it from the wall outlet and disconnect the antenna. This will prevent damage to the receiver due to lightning and power-line surges.

Service

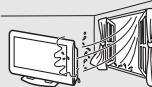
Damage requiring service

Unplug the unit from the wall outlet and refer servicing to qualified service personnel under the following conditions:

- When the power cord or plug is damaged or frayed. 
- If liquid has been spilled into the unit.
- If the surface of the TV cracks, do not touch it, unplug the AC power cord.
- If the unit has been exposed to rain or water. 
- If the unit has been subjected to excessive shock by being dropped, or the cabinet has been damaged. 
- If the unit does not operate normally when following the operating instructions. Adjust only those controls that are specified in the operating instructions. Improper adjustment of other controls may result in damage and will often require extensive work by a qualified technician to restore the unit to normal operation. 
- When the unit exhibits a distinct change in performance, it indicates need for service. 

Servicing

Do not attempt to service the unit yourself since opening the cabinet may expose you to dangerous voltages or other hazards. Refer all servicing to qualified service personnel.



Replacement parts

When replacement parts are required, be sure the service technician certifies in writing that he/she has used replacement parts specified by the manufacturer that have the same characteristics as the original parts. Unauthorized substitutions may result in fire, electric shock or other hazards.



Safety check

Upon completion of any service or repairs to the unit, ask the service technician to perform routine safety checks (as specified by the manufacturer) to determine that the unit is in safe operating condition, and to so certify. Ask a qualified service technician to dispose of the unit.



Contents

Introducing the TV

Welcome	10
Package Contents.....	10
Features.....	10
Installing the TV	11
Preventing the TV from Toppling Over	11
Bundling the Connecting Cables.....	12
Adjusting the Viewing Angle of the TV.....	12
TV Controls and Connectors	13
Front and Top Panel	13
Side Panel.....	14
Rear Panel.....	15

Connecting the TV

Making Video and Audio Connections	17
Basic Connections	18
Cable System or VHF/UHF Antenna System	18
Cable Box/Digital Cable Box.....	18
Satellite Receiver and Cable/Antenna	19
HD Equipment.....	20
Connecting Optional Equipment	22
VCR, Cable and Antenna.....	22
DVD Player	24
HDMI-Equipped Device	26
DVI-HDTV-Equipped Device.....	27
Personal Computer	28
Camcorder or "PlayStation"	29
Setting Up the Channel List	30
Using Initial Setup	30

Watching the TV

Button Descriptions	32
Programming the Remote Control	34
Using Other Equipment with Your Remote Control	36
Special Buttons on the Remote Control	38
Using the Wide Screen Mode	38
Using the Jump Function	39
Using the Freeze Function.....	39

Using the Power Saving Function	39
Using the Sleep Function	40

Introducing WEGA GATE

Overview of WEGA GATE	42
Navigating and Select	44
Using Favorites in WEGA GATE	44
Using TV List in WEGA GATE	45
Using External Inputs in WEGA GATE	45
Using Settings in WEGA GATE	45

Using the Settings

Overview of the Settings	46
Using the Video Settings	48
Selecting Video Options	48
Using the Audio Settings	49
Selecting Audio Options	49
Using the Screen Settings	51
Selecting Screen Options.....	51
Using the Channel Settings	53
Selecting Channel Options.....	53
Using the Parent Settings	55
Selecting Parent Options.....	55
US Models: Selecting Custom Rating Options	56
Viewing Blocked Programs	56
Canadian Models: Selecting Custom Rating Options	57
Viewing Blocked Programs	57
Using the Clock/Timers Settings	58
Selecting Clock/Timers Options	58
Using the Setup Settings	60
Selecting Setup Options.....	60

Other Information

Troubleshooting	62
Trouble Symptoms and Remedies	62
Contacting Sony	64
Specifications	65
Index	67

Introducing the TV

Welcome

Thank you for purchasing this Sony HDTV Ready LCD TV. This manual is for models KLV-S19A10, KLV-S23A10, KLV-S26A10 and KLV-S32A10.

Package Contents

Along with your new TV, the packaging box contains a remote control, size AA batteries, 75-ohm coaxial cable (ferrite core attached), AC power cord, AC power adaptor (KLV-S19A10 only), HD15-HD15 cable, Support belt, securing screw, wood screw, Operating Instructions, Quick Setup Guide, Leaflet (Installing the Wall-Mount Bracket, KLV-S19A10 only) and warranty card.

See page 66 for the quantity of each supplied accessory.

Features

Some of the features that you will enjoy with your new TV include:

- WEGA GATE:** WEGA GATE is a new feature that allows you to easily navigate to the most convenient TV functions: favorite channels, TV channel list, external input list, or settings.
- CineMotion®:** Provides an optimized display by automatically detecting film content and applying a reverse 3:2 pulldown process. Moving pictures will appear clearer and more natural-looking.
- Wide Screen Mode:** Watch conventional 4:3 aspect ratio broadcasts in wide screen (16:9) mode.
- Favorite Channels:** With the WEGA GATE function, allows you to select from 8 of your favorite channels.
- Steady Sound®:** Equalizes volume levels so there is consistent output between programs and commercials.
- Component Video Input:** Offers the best video quality for DVD (480p and 480i), and digital set-top box (1080i, 720p, 480p and 480i) connections.
- Parental Control:** V-Chip technology allows parents to block unsuitable programming from younger viewers.
- HDMI (High-Definition Multimedia Interface):** Provides an uncompressed, all-digital audio/video interface between this TV and any HDMI-equipped audio/video component, such as a set-top box, DVD player, and A/V receiver. HDMI supports enhanced, or high-definition video, plus two-channel digital audio.
- Light Sensor:** Allows the picture brightness level to be optimized to ambient light. The effect from the Light Sensor depends on the setting of Picture Mode and Power Saving. The factory setting is Off.
- Caption Vision/ Info Banner:** Allows Closed Caption and/or Channel Programming Information to be displayed.



Installing the TV

Preventing the TV from Toppling Over

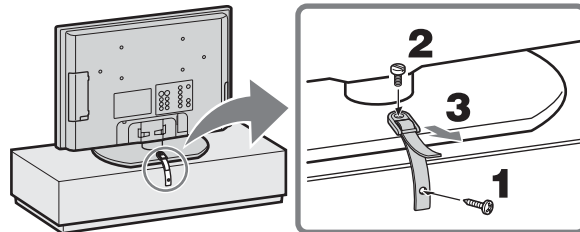
Attaching the Support Belt



- 1** Screw the support belt (supplied) to the TV stand with a wood screw (supplied).
- 2** Attach the support belt to the stand, and screw the belt with a securing screw (supplied) using a coin, etc.
- 3** Adjust the length by pulling the support belt towards you while holding the TV stand.

-  Be sure to take measures to prevent the TV from toppling over and causing injury.
-  The supplied wood screw may not be used depending on the type of TV stand. In this case, or when the securing strength is not enough, prepare commercial screws to fit to the TV stand. Use commercial screws of 3 to 4 mm diameter. Consult your dealer about the types of screw.

When Mounting on a Wall

Be sure to use the following optional wall-mount brackets to hang the TV on the wall.

KLV-S19A10: SU-WL11

KLV-S23A10/KLV-S26A10/KLV-S32A10: SU-WL31

See the Instruction Guide supplied with the wall-mount bracket on how to mount the TV on the wall.

Bundling the Connecting Cables

You can bundle the connecting cables as illustrated below.

- 1 Bundle the connecting cables.

KLV-S19A10

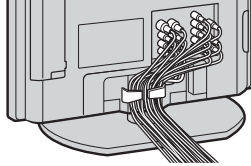

KLV-S23A10

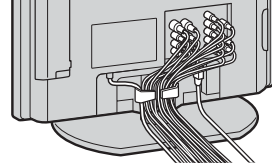

KLV-S26A10

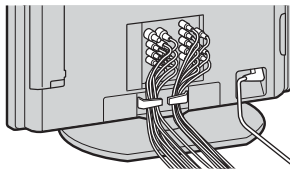

KLV-S32A10

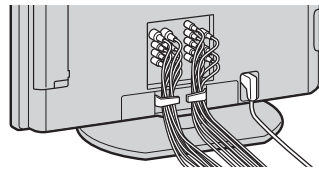

- 2 Route the connecting cables through the hook.

 Do not bundle the AC power cord for KLV-S23A10, KLV-S26A10 and KLV-S32A10 in the stand with other connecting cables.

Adjusting the Viewing Angle of the TV

This TV can be adjusted within the angles shown below.

Adjust the angle back and forth (tilt)

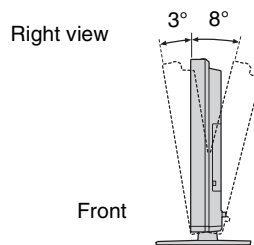

Adjust the angle left and right (swivel)

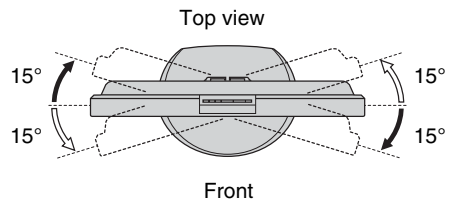

 When adjusting the angle, hold the stand with one hand to avoid slipping or tipping the stand.



TV Controls and Connectors

Front and Top Panel

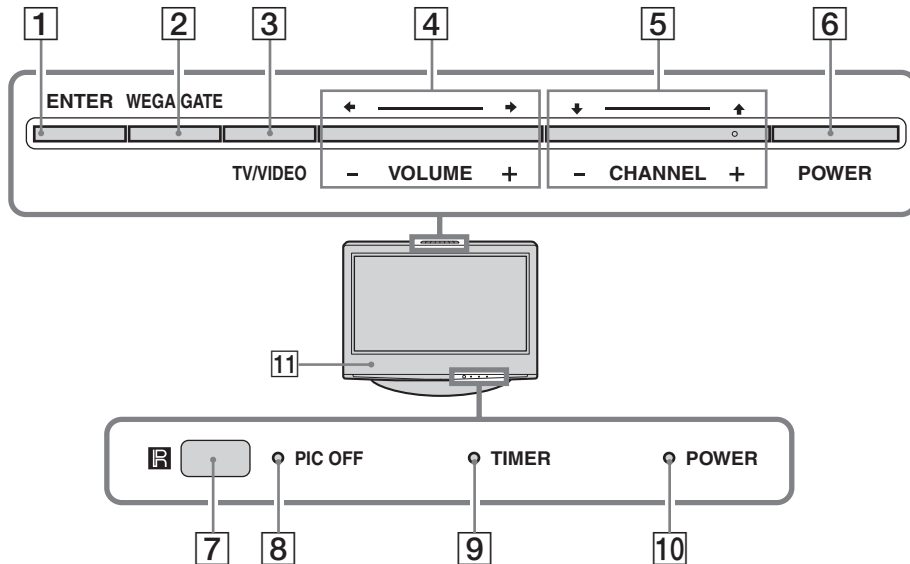

Item	Description
1	ENTER Press to confirm the selection or setting.
2	WEGA GATE Press to display WEGA GATE. Press again to exit WEGA GATE.
3	TV/VIDEO Press repeatedly to cycle through the video equipment connected to the TV's video inputs.
4	← → - VOLUME + Press to adjust the volume. In the WEGA GATE screen, these buttons serve as left/right buttons.
5	↓ ↑ - CHANNEL + Press to scan through channels. To scan quickly through channels, press and hold down either CHANNEL. In the WEGA GATE screen, these buttons serve as up/down buttons.
6	POWER Press to turn on and off the TV.
7	(IR) Infrared Receiver/Light Sensor Receives IR signals from the remote control. Senses room light level and adjusts the screen brightness accordingly (see page 61 for details). Do not put anything near the sensor, as its function may be affected.
8	PIC OFF LED When lit, indicates that the Picture Off feature is activated. For details, see page 61.
9	TIMER LED When lit, indicates one of the timers is set. When the timer is set, this LED will remain lit even if the TV is turned off. For details, see page 58.
10	POWER LED Lights up in green when the TV is turned on. If the LED blinks in red continuously, this may indicate the display unit needs servicing (see "Contacting Sony" on page 2).
11	Speaker Outputs audio signal.

 The CHANNEL + button has a tactile dot. Use it as a reference when operating the TV.

Side Panel

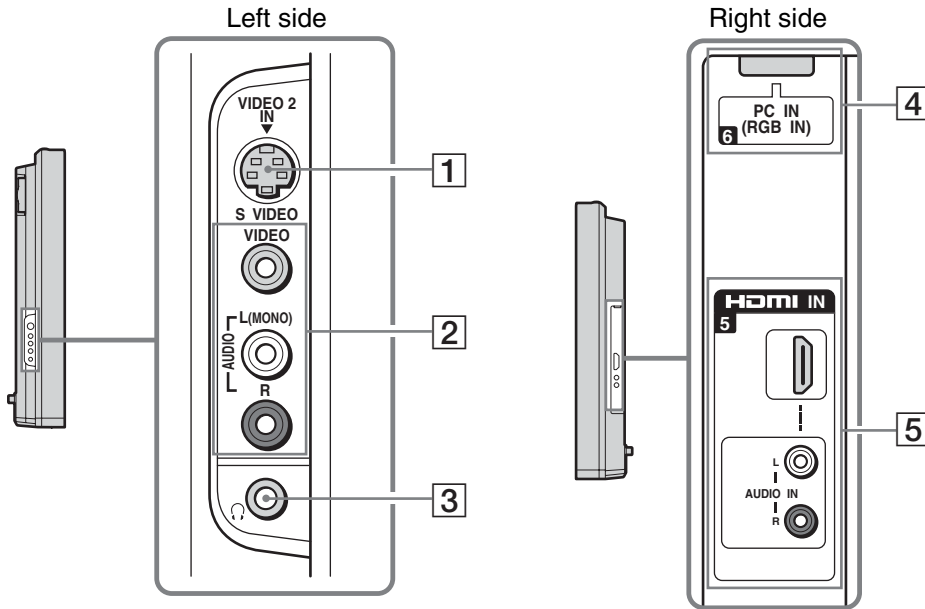

Item	Description
1 VIDEO 2 IN S VIDEO	Connects to the S VIDEO output jack on your camcorder or other video equipment that has S VIDEO. Provides better picture quality than composite video (2).
2 VIDEO 2 IN VIDEO/ AUDIO L (MONO)/ AUDIO R	Connect to the composite video and audio output jacks on your camcorder or other video equipment.
3 Headphones jack	Connects to your headphones. If your headphones do not match the jack, use a suitable plug adaptor (not supplied). See page 49 for details.
4 PC IN (RGB IN) 6	Connect to a personal computer's video output connector. Can be connected to other Analog RGB devices such as Video Conferencing or Set-top Boxes. See "PC Input Signal Compatibility Chart" on page 52 for the signal to be displayed.
5 HDMI IN 5 HDMI/ L-AUDIO-R	HDMI (High-Definition Multimedia Interface) provides an uncompressed, all-digital audio/video interface between this TV and any HDMI-equipped audio/video component, such as a set-top box, DVD player, and A/V receiver. HDMI supports enhanced, or high-definition video, plus two-channel digital audio. The AUDIO IN (L/R) of HDMI IN is for DVI connection. See page 27 for details.

Rear Panel

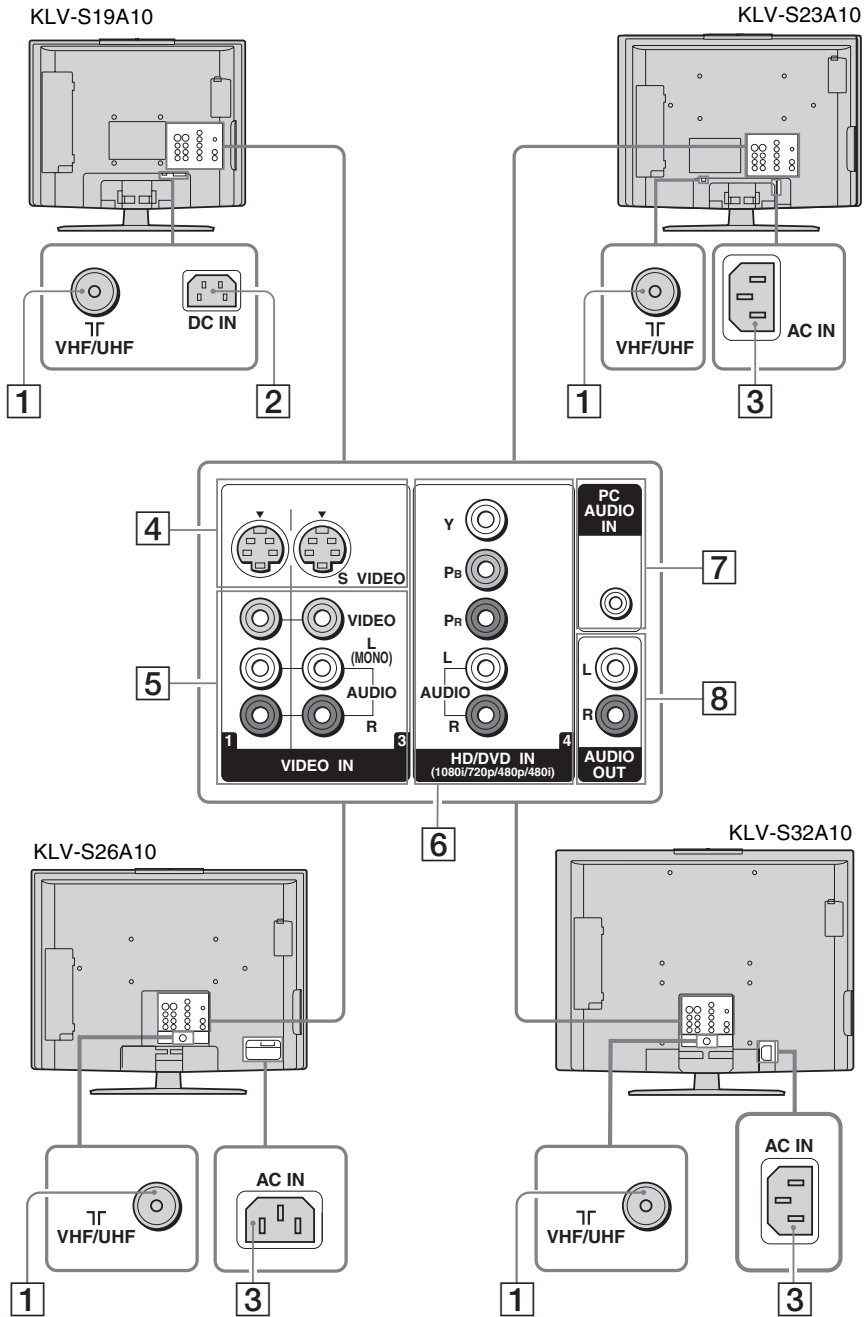

(Continued)

Introducing the TV

<i>Jack</i>	<i>Description</i>
1 VHF/UHF	RF input that connects to your VHF/UHF antenna.
2 DC IN (KLV-S19A10)	Connects the supplied AC power adaptor.
3 AC IN (KLV-S23A10/ KLV-S26A10/ KLV-S32A10)	Connects the supplied AC power cord.
4 VIDEO IN 1/3 S VIDEO	Connects to the S VIDEO output jack of your VCR or other video equipment that has S VIDEO. S VIDEO provides better picture quality than the composite video (5).
5 VIDEO IN 1/3 VIDEO/ L-AUDIO-R	Connect to the composite video and audio output jacks on your VCR or other video component. A third composite video and audio (VIDEO 2) is located on the left side panel of the TV.
6 HD/DVD IN 4 (1080i/720p/ 480p/480i)/ L-AUDIO-R	Connect to your DVD player's or digital set-top box's component video (YPbPr) and audio (L/R) jacks. Component video provides better picture quality than the S VIDEO (4) or the composite video (5) connections.
7 PC AUDIO IN	Connects to a personal computer's audio output connector.
8 AUDIO OUT (L/R)	Connect to the left and right audio input jacks of your audio or video equipment. You can use these outputs to listen to your TV's audio through your stereo system.

Connecting the TV





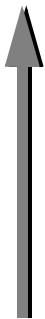

To display clear crisp pictures, first you must connect your TV correctly and also need to choose the correct display format (see “Changing the wide screen mode” on page 38). It is strongly recommended to connect the antenna using the supplied 75-ohm coaxial cable to receive optimum picture quality signal. A 300-ohm twin lead cable can be easily affected by radio noise and the like, resulting in signal deterioration. If you use a 300-ohm twin lead cable, keep it as far away as possible from the TV.

Making Video and Audio Connections

Your TV includes several types of video inputs. When connecting your TV, use the inputs that are available on your devices that provide the best video performance, as described below.

Best Video Performance



	<i>Connector type</i>	<i>Separate audio connection required</i>
	HDMI (High-Definition Multimedia Interface)	No
	Component video (480i/480p/720p/1080i)	Yes 
	S VIDEO	
	Composite video	
	RF/Coaxial	No

 When you connect video equipment to both the VIDEO and the S VIDEO input jacks, make sure Auto YC in the Setup settings is set to On to view the S VIDEO input (see page 61).

Basic Connections

Cable System or VHF/UHF Antenna System

Cable or VHF only or VHF/UHF

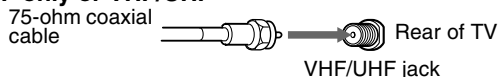

From the Channel settings, select Cable On or Cable Off for your type of input signal.

- A ferrite core is factory attached to the supplied 75-ohm coaxial cable. Do not detach the ferrite core from the coaxial cable.
- The ferrite core is attached to one end of (not the center of) the supplied 75-ohm coaxial cable. When connecting the cable to the TV, insert the end with the ferrite core into the VHF/UHF jack.

Cable Box/Digital Cable Box

The supplied remote control can be programmed to operate your cable box (see “Programming the Remote Control” on page 34).

To change channels using the cable box, set your TV to channel 3 or 4 depending on the cable box channel output.

If you will be controlling all channel selection through your cable box, consider using the Channel Fix feature to set your TV to channel 3 or 4 (see page 53).

Use this hookup if:

- You subscribe to a cable TV system that uses scrambled or encoded signals requiring a cable box to view all channels, and
- You do not intend to hook up any other audio or video equipment to your TV.

- 1** Connect the coaxial connector from your cable service to the cable box’s IN jack.
- 2** Using the supplied 75-ohm coaxial cable, connect the cable box’s OUT jack to the TV’s VHF/UHF jack.

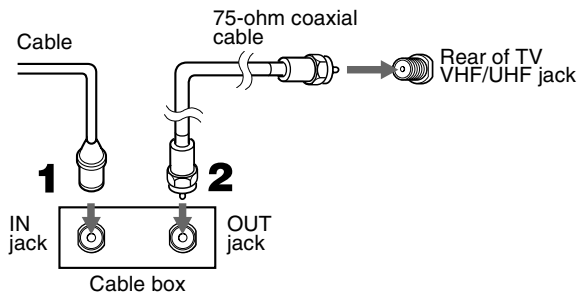

Also, set Cable to On in the Channel settings (see page 53).

Notes on Using This Connection

To Do This ...	Do This ...
Use the cable box/digital cable box	Tune the TV to the channel the cable box is set to and then use the cable box to switch channels.
Set up the remote control to operate the cable box/digital cable box	Program the remote control. See “Programming the Remote Control” on page 34.
Activate the remote control to operate the cable box/digital cable box	Press SAT/CABLE (FUNCTION).
Control cable box/digital cable box functions with the remote control	See “Operating a Cable Box” on page 36.
Prevent the accidental switching of TV channels	When using the cable box, you need the TV to stay on the channel the cable box is set to. You can use the TV’s Channel Fix feature to lock in a specific channel. For details, see “Using the Channel Settings” on page 53.

Satellite Receiver and Cable/Antenna

 If you connect the Digital Satellite Receiver with component video cables, see page 20.

This scenario shows a SAT Box connected through the video inputs and the Cable/Antenna connected through the VHF/UHF input. Satellite signals are selected by the SAT Box through the video inputs while TV signal is selected by the TV tuner.

To connect a satellite receiver

- 1** Connect the satellite antenna cable to the satellite receiver's satellite input jack.
- 2** Use an A/V and S VIDEO cables to connect the satellite receiver's AUDIO and S VIDEO output jacks to the TV's AUDIO and S VIDEO input jacks (VIDEO 1 or 3).
- 3** Connect the supplied 75-ohm coaxial cable from the antenna to the TV's VHF/UHF input jack.
- 4** Run the Initial Setup program, as described in "Setting Up the Channel List" on page 30.

 If your satellite receiver is not equipped with S VIDEO, use a VIDEO cable (yellow) instead of the S VIDEO cable.

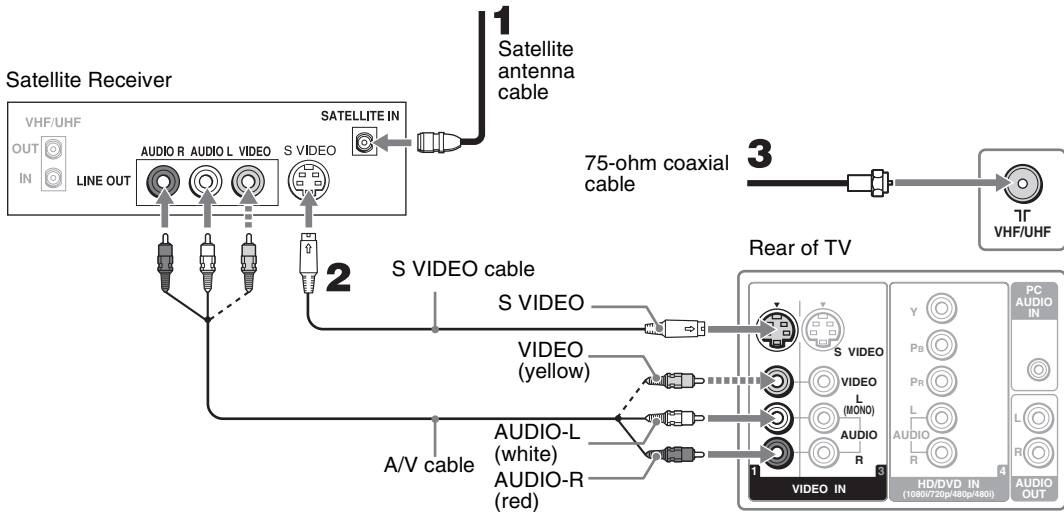

Notes on Using This Connection

To Do This ...	Do This ...
Watch the satellite receiver	Press WEGA GATE to select the Satellite input (Video 1, 2 or 3) in the External Inputs list. or Press TV/VIDEO repeatedly to select the satellite receiver input (Video 1, 2 or 3).
Set up the remote control to operate the satellite receiver	You must program the remote control. See "Programming the Remote Control" on page 34.
Activate the remote control to operate the satellite receiver	Press SAT/CABLE (FUNCTION).
Control satellite receiver functions with the remote control	See "Operating a Satellite Receiver" on page 36.
Label video inputs to easily identify equipment connected to the TV	See the instructions for setting up Label Video Inputs on page 61.

HD Equipment

💡 If your equipment has an HDMI or DVI connector, see page 26.

Disconnect all power sources before making any connections.

1 Using a component video cable, connect your equipment's YPbPr output jacks to the TV's YPbPr input jacks. Use the HD/DVD IN 4 connections.

🔧 Component video (YPbPr) connection is necessary to view 480p, 720p, and 1080i formats. Note that this TV displays all format types of picture in a resolution of 1,280 dots × 768 lines (KLV-S19A10) and 1,366 dots × 768 lines (KLV-S23A10, KLV-S26A10 and KLV-S32A10).

2 Using an audio cable, connect your equipment's AUDIO output jacks to the TV's AUDIO input jacks.

🔧 The YPbPr jacks do not provide audio, so audio cables must be connected to provide sound.

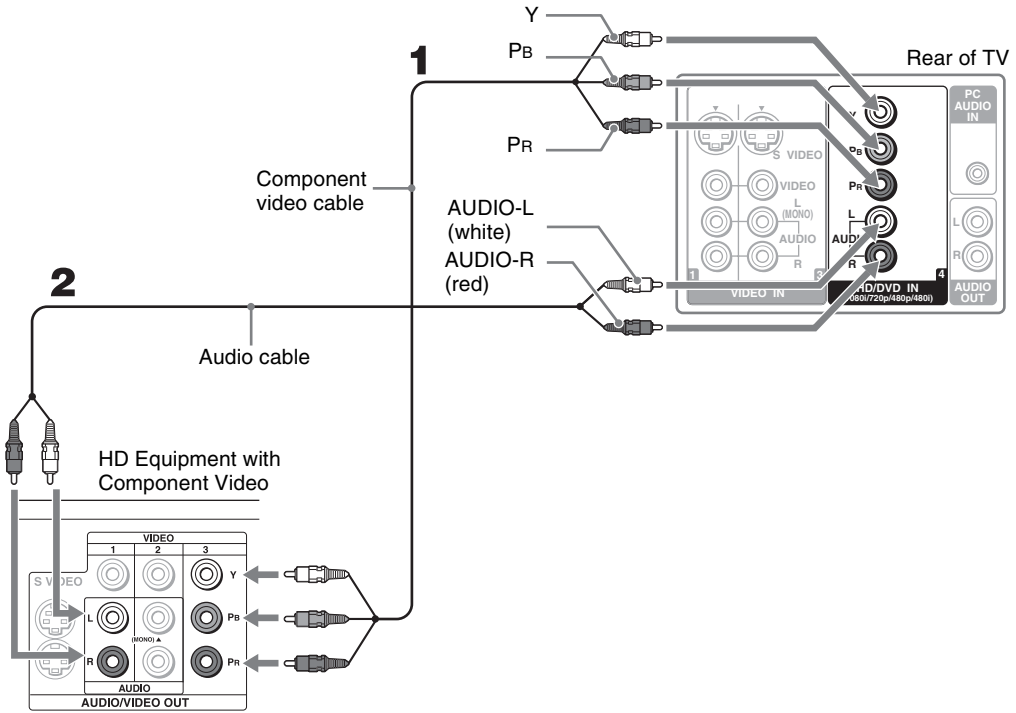

🔧 Some of the HD equipment you can connect to receive the broadcasting signals are digital cable box, digital satellite receiver and digital TV receiver.

Notes on Using This Connection

<i>To Do This ...</i>	<i>Do This ...</i>
Watch the HD equipment	Press WEGA GATE to select the HD equipment input (Video 4) in the External Inputs list. or Press TV/VIDEO repeatedly to select the HD equipment input (Video 4).
Set up the remote control to operate the HD equipment	You must program the remote control. See “Programming the Remote Control” on page 34.
Activate the remote control to operate the HD equipment	Press SAT/CABLE (FUNCTION) .
Control HD equipment functions with the remote control	See “Using Other Equipment with Your Remote Control” on page 36.
Label video inputs to easily identify equipment connected to the TV	See the instructions for setting up Label Video Inputs on page 61.

Connecting Optional Equipment

You can connect a variety of optional equipment to your TV. This section provides some of the individual connections you can make. For multiple connections, please refer to the Quick Setup Guide.

VCR, Cable and Antenna

 The most common setup is the Cable input into the VCR Antenna IN, the VCR Antenna Out to the VHF/UHF input.

This scenario shows a VCR with Cable signals connected through the video inputs and the Antenna connected through the VHF/UHF input. The Cable or VCR signals are selected by the VCR through the video inputs while TV signal (Antenna) is selected by the TV tuner.

To connect the VCR and cable

- 1 Connect the CATV cable to the VCR's VHF/UHF input jack.
- 2 Connect the supplied 75-ohm coaxial cable from the antenna to the TV's VHF/UHF input jack.
- 3 Use an A/V and S VIDEO cables to connect the VCR's AUDIO and S VIDEO output jacks to the TV's AUDIO and S VIDEO input jacks (VIDEO 1 or 3).
- 4 Run the Initial Setup Program, as described in "Setting Up the Channel List" on page 30.

 If your VCR is not equipped with S VIDEO, use a VIDEO cable (yellow) instead of the S VIDEO cable.

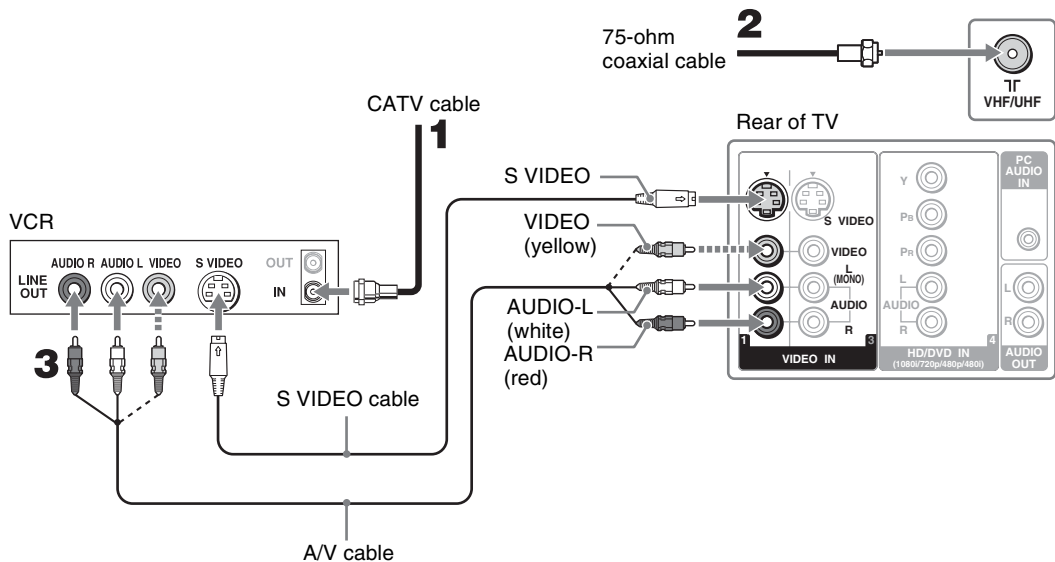

Notes on Using This Connection

<i>To Do This ...</i>	<i>Do This ...</i>
Watch the VCR	Press WEGA GATE to select the VCR input (Video 1, 2 or 3) in the External Inputs list. or Press TV/VIDEO repeatedly to select the VCR input (VIDEO 1, 2 or 3).
Watch cable channels	Press WEGA GATE to select the VCR input (Video 1, 2 or 3) in the External Inputs list. or Press TV/VIDEO repeatedly to select the VCR input (VIDEO 1, 2 or 3).
Set up the remote control to operate the VCR	You must program the remote control. See “Programming the Remote Control” on page 34.
Activate the remote control to operate the VCR	Press DVD/VCR (FUNCTION) .
Control VCR functions with the remote control	See “Operating a VCR” on page 36.
Label video inputs to easily identify equipment connected to the TV	See the instructions for setting up Label Video Inputs on page 61.

DVD Player

For best results, use this connection if your DVD player has component video (YPbPr) jacks.

To connect a DVD player with component video connectors

- 1 Use a component video cable to connect the DVD player's YPbPr output jacks to the TV's YPbPr input jacks (HD/DVD IN 4).

 The YPbPr jacks on your DVD player are sometimes labeled Y, CB and CR, or Y, B-Y and R-Y. If so, connect the cables to their matching color jacks.

- 2 Use an audio cable to connect the DVD player's AUDIO output jacks to the TV's AUDIO input jacks (HD/DVD IN 4).

 The YPbPr jacks do not provide audio, so audio cables must be connected to provide sound.

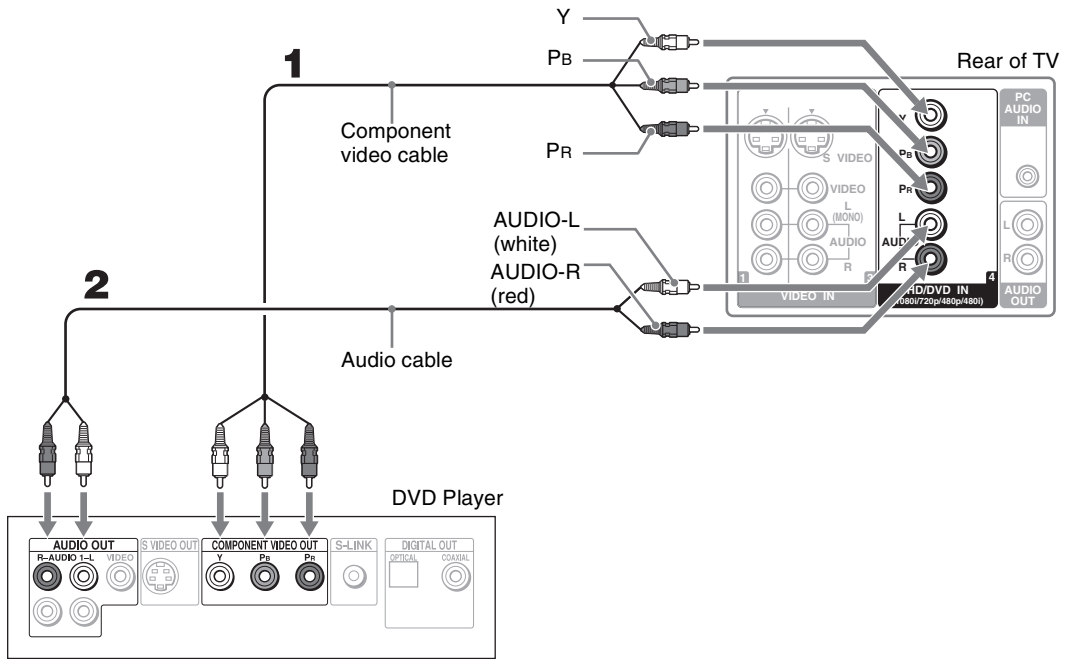

Notes on Using This Connection

To Do This ...	Do This ...
Watch the DVD player	Press WEGA GATE to select the DVD player input (Video 4) in the External Inputs list. or Press TV/VIDEO repeatedly to select the DVD player input (Video 4).
Set up the remote control to operate the DVD player	You must program the remote control. See “Programming the Remote Control” on page 34.
Activate the remote control to operate the DVD player	Press DVD/VCR (FUNCTION) .
Control DVD functions with the remote control	See “Operating a DVD Player or DVD Changer” on page 36.
Label video inputs to easily identify equipment connected to the TV	See the instructions for setting up Label Video Inputs on page 61.

To connect a DVD player with S VIDEO and audio connectors

If your DVD player does not have component video (YPbPr) jacks, or the component video inputs are already connected to another device, use this connection.



- 1** Use an S VIDEO cable to connect the DVD player’s S VIDEO output jack to the TV’s S VIDEO input jack (VIDEO 1 or 3).
- 2** Use an audio cable to connect the DVD player’s AUDIO output jacks to the TV’s AUDIO input jacks (VIDEO 1 or 3).

 If your DVD player is not equipped with S VIDEO, use a VIDEO cable (yellow) instead of the S VIDEO cable.

HDMI-Equipped Device

To connect a device with HDMI connector

Use an HDMI cable to connect the device's HDMI output connector to the TV's HDMI IN connector on the right side panel.

-  HDMI cables transmit both audio and video signals. (Separate audio cables are not necessary.) You can purchase HDMI cables at your local electronics store.
-  Do not connect a PC to the TV's HDMI input. Use the PC IN (RGB IN) connector instead when connecting a PC.

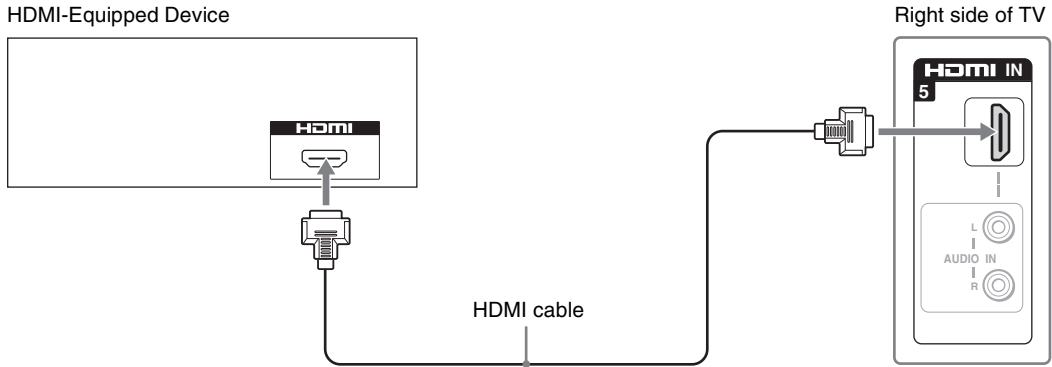

Notes on Using This Connection

To Do This ...	Do This ...
Watch the device	Press WEGA GATE to select the HDMI-equipped device input (Video 5) in the External Inputs list.
	or
	Press TV/VIDEO repeatedly to select the HDMI-equipped device input (Video 5).
Label video inputs to easily identify equipment connected to the TV	See the instructions for setting up Label Video Inputs on page 61.

DVI-HDTV-Equipped Device

To connect a device with DVI-HDTV connector

If the device does not have an HDMI connector, you can connect the TV's HDMI IN connector to the device's DVI-HDTV output connector using a DVI to HDMI cable.

- 1 Use a DVI to HDMI adapter or cable to connect the device's DVI-HDTV output connector to the TV's HDMI IN connector on the right side panel.

 The DVI-HDTV VIDEO connector does not provide audio, so audio cables must be connected to provide sound when a DVI to HDMI adapter is used.

 Do not connect a PC to the TV's HDMI input. Use the PC IN (RGB IN) connector instead when connecting a PC.

- 2 Use an Audio cable to connect the device's AUDIO output jacks to the TV's AUDIO input jacks on the right side panel.

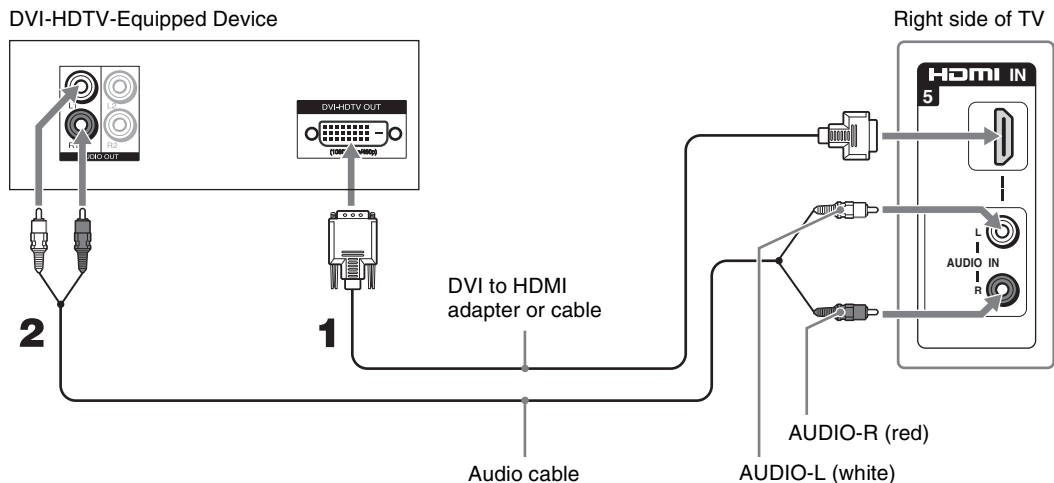

Notes on Using This Connection

To Do This ...

Watch the device

Do This ...

Press WEGA GATE to select the DVI-HDTV-equipped input (Video 5) in the External Inputs list.

or

Press TV/VIDEO repeatedly to select the DVI-HDTV-equipped device input (Video 5).

Label video inputs to easily identify equipment connected to the TV

See the instructions for setting up Label Video Inputs on page 61.

Personal Computer

💡 When connecting to an Apple Macintosh computer, use the supplied HD15-HD15 cable to connect PC IN of the TV to video output connector of the computer. For some Apple Macintosh computers, it may be necessary to use an adapter (not supplied). If this is the case, connect the adapter to the computer before connecting the HD15-HD15 cable.

💡 If the picture is noisy, flickering or not clear adjust the Phase and Pitch in the Screen Settings on page 52.

To connect a PC (personal computer)

If you connect your PC to the TV, you can watch your personal computer's display on the TV.

When your PC is connected to the TV with the supplied HD15-HD15 cable and optional audio cable, you can view and listen to the PC's video and audio output on the TV.

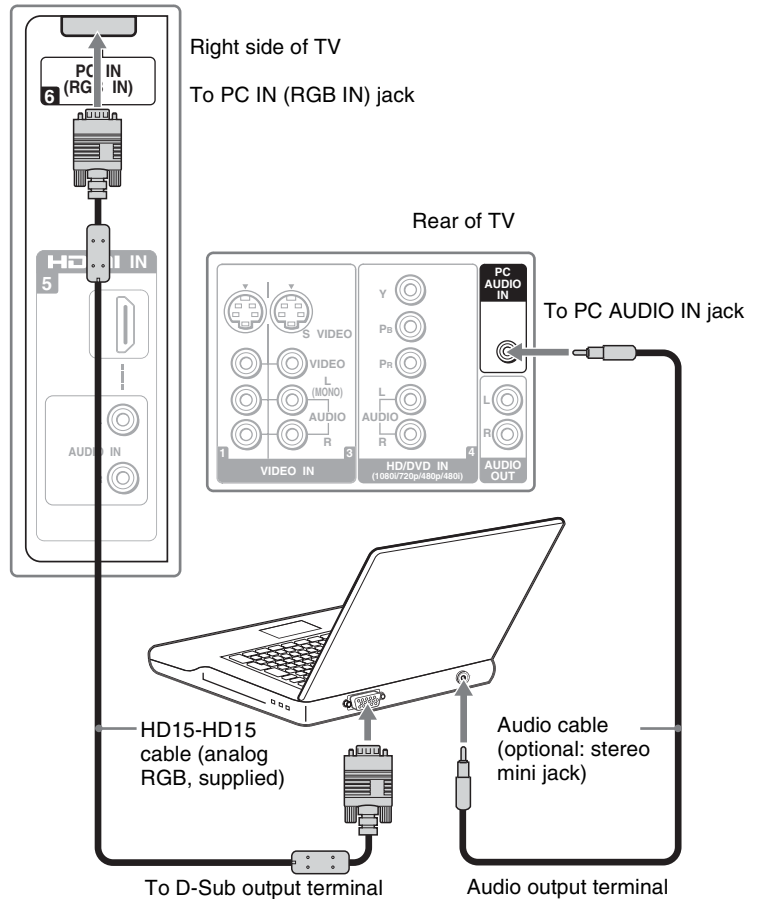

Notes on Using This Connection



To Do This ...	Do This ...
Watch the PC	Press WEGA GATE to select the PC input (Video 6) in the External Inputs list. or Press TV/VIDEO repeatedly to select the PC input (Video 6).
Label video inputs to easily identify equipment connected to the TV	See the instructions for setting up Label Video Inputs on page 61.

Camcorder or "PlayStation"

For easy connection to a camcorder or "PlayStation", the TV has left side A/V input jacks. If you prefer, you can connect the camcorder to the TV's rear A/V input jacks.

To connect a camcorder or "PlayStation"

Use an A/V and S VIDEO cables to connect the camcorder or "PlayStation" AUDIO and S VIDEO output jacks to the TV's AUDIO and S VIDEO input jacks (VIDEO 2) on the left side of panel.

-  If your camcorder is not equipped with S VIDEO, use a VIDEO cable (yellow) instead of the S VIDEO cable.
-  If you have a mono camcorder, connect its audio output jack to the TV's L MONO audio input jack.

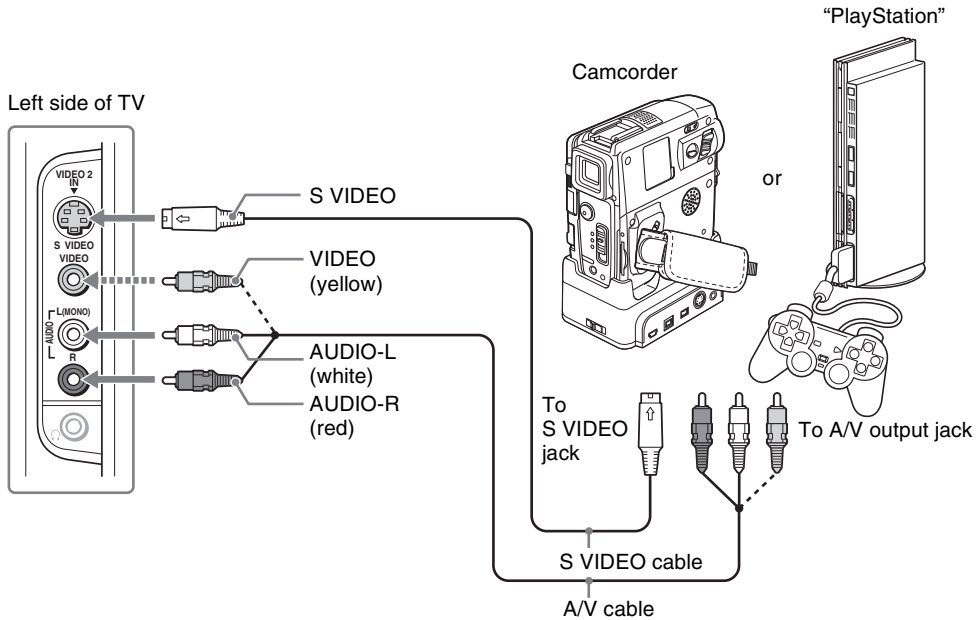



Notes on Using This Connection

To Do This ...	Do This ...
Watch the camcorder or "PlayStation"	Press WEGA GATE to select the camcorder or game input (Video 2) in the External Inputs list. or Press TV/VIDEO repeatedly to select the camcorder or game input (Video 2).
Label video inputs to easily identify equipment connected to the TV	See the instructions for setting up Label Video Inputs on page 61.



Setting Up the Channel List

After you finish connecting your TV, you need to run Initial Setup, which automatically sets up available channels. The Initial Setup screen appears when you turn on your TV for the first time after hooking it up. If you do not want to set up the channels at this time, you can do it later by selecting the Auto Program option in the Channel settings (see page 53).

-  The Auto Program feature does not apply for installations that use a cable box.
-  The factory default setting for channel selection is Cable On. For antenna connections, run the Auto Program again after selecting Cable Off from the settings.

Using Initial Setup

To run Initial Setup the first time you turn on your TV

- 1** Press POWER to turn on the TV.
The Initial Setup screen appears.
- 2** Press  or  to select the on-screen display language. Then press .
The message “First please connect cable/antenna” appears.

 By default, Auto Program is set to scan cable TV channels.

- 3** Press CH + to start Auto Program.

Auto Program automatically creates a list of receivable channels. When finished, the lowest numbered channel is displayed. When all the receivable channels are stored, the Show/Hide Channels settings appear.

To scan available VHF/UHF antenna channels instead of the cable TV channels

- 1** Select Settings in WEGA GATE, then go to Channel settings.
- 2** Set Cable to Off.
- 3** Start Auto Program by pressing CH +.

To perform Auto Program again, follow the above instructions. Depending on your signal source, be sure to set Cable to On or Off accordingly (see page 53).

 The Initial Setup menu will appear each time the TV is turned on until you complete the scanning for the available channels.

Watching the TV

Button Descriptions

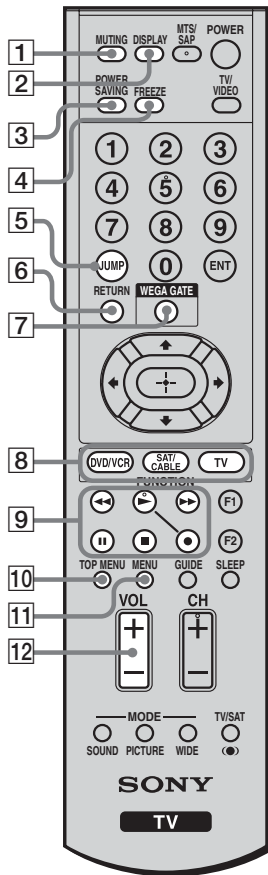

The 5 button, CH + button, (Play) button and MTS/SAP button have a tactile dot. Use them as a reference when operating the TV.

Button	Description
1 MUTING	Press to mute the sound. Press again or press VOL + to restore the sound.
2 DISPLAY	Press once to display the current channel number, channel label, time and Wide Mode settings. The OSD (on screen display) will be canceled after a few seconds or press again to immediately cancel the display.
3 POWER SAVING	Press repeatedly to cycle through the power saving modes: Standard, Reduced, Picture Off. See Power Saving on page 61.
4 FREEZE	Press to freeze the picture. The current program appears in the sub screen when freeze is selected. Press repeatedly to restore the picture. You can use this feature to write down information such as phone numbers, recipes, etc. Some functions will not be available in freeze.
5 JUMP	Press to jump back and forth between two channels. The TV alternates between the current channel and the last channel that was selected.
6 RETURN	Press to go back to the previous screen when displaying settings.
7 WEGA GATE	Press to navigate to TV functions. See “Introducing WEGA GATE” on page 42.
8 FUNCTION Buttons	Press to have the remote control operate the equipment you want. See “Programming the Remote Control” on page 34.
9 DVD/VCR Operating Buttons	When FUNCTION is switched on DVD/VCR, these buttons operate the video equipment you have programmed into the remote control. See “Using Other Equipment with Your Remote Control” on page 36. ◀◀ Rewind ▶▶ Play ▶▶▶ Fast forward Pause ■ Stop ● Record
10 TOP MENU	Press to display the top menu of your DVD/VCR.
11 MENU	Press to display the menu of your DVD or Satellite Receiver. Press again to exit from the menu.
12 VOL +/-	Press to adjust the volume.

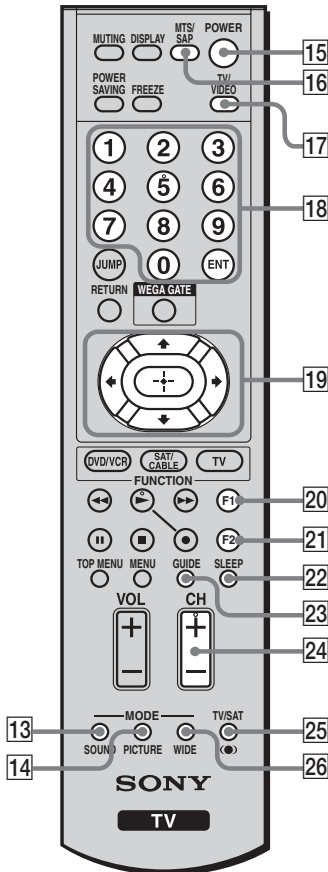

The 5 button, CH + button, (Play) button and MTS/SAP button have a tactile dot. Use them as a reference when operating the TV.

Button	Description
13 SOUND	Press repeatedly to cycle through the sound modes: Dynamic, Natural, Clear Voice. See “Selecting Audio Options” on page 49.
14 PICTURE	Press repeatedly to cycle through the available video picture modes: Vivid, Standard, Pro. The video picture modes can be also accessed in the Video settings. See “Selecting Video Options” on page 48.
15 POWER	Press to turn on and off the TV.
16 MTS/SAP	Press repeatedly to cycle through the Multi-channel TV Sound (MTS) options: Stereo, Auto SAP (Second Audio Program), and Mono. The MTS setting can be also accessed in the Audio settings. See “Selecting Audio Options” on page 49.
17 TV/VIDEO	Press repeatedly to cycle through the video equipment connected to the TV’s video inputs. See page 61 on setting up the video input labels, including skip function.
18 0 - 9 ENT	Press 0 - 9 to select a channel; the channel changes after 2 seconds. Press ENT to change channels immediately.
19	Press to move the on-screen cursor. To select an item, press .
20 F1	Press to select the function of your video equipment which is programmed on the TV’s remote control. See pages 36, 37 for specific functions.
21 F2	Press to select the function of your video equipment which is programmed on the TV’s remote control. See pages 36, 37 for specific functions.
22 SLEEP	Press repeatedly until the TV displays the time in minutes (15, 30, 45, 60 or 90) that you want the TV to remain on before shutting off. To cancel Sleep Timer, press SLEEP repeatedly until Sleep Off appears.
23 GUIDE	Press to display the program guide of your satellite program provider.
24 CH +/-	Press to scan through channels. To scan quickly through channels, press and hold down either CH.
25 TV/SAT	Press to switch between the TV and the satellite receiver when FUNCTION is switched on SAT/CABLE.
	Press to select the sound effect modes: TruSurround, Simulated, Off. The sound effect modes can be also accessed in the Audio settings. See “Selecting Audio Options” on page 49.
26 WIDE	Press repeatedly to step through the Wide Screen Mode settings: Wide Zoom, Normal, Full, Zoom. The Wide Screen Mode settings can be also accessed in the Screen settings. See page 51.

GUIDE and TV/SAT buttons are functional when the SAT/CABLE function button is selected.

Programming the Remote Control

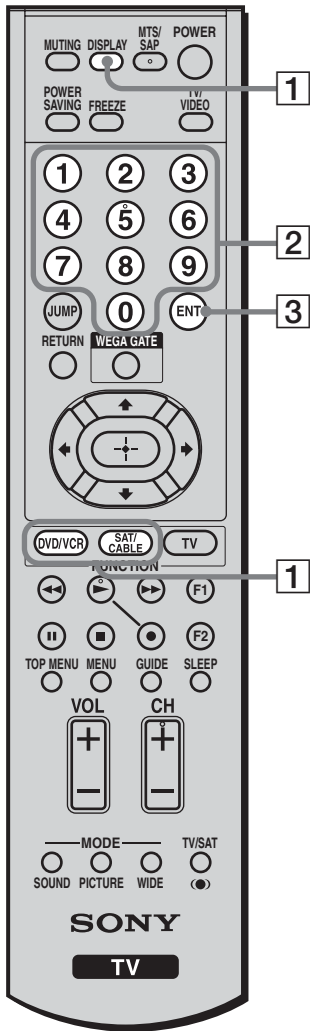

The remote control is preset to operate Sony brand video equipment.

Sony Equipment	Programmable Code Number
DVD/VCR	601 (Sony Dream System)
SAT/Cable	801 (Sony Satellite Receiver)

Follow the steps below to program your TV's remote control to operate the other video equipment.

Find the three-digit code for your equipment from the "Manufacturer's Codes" listed on page 35. If more than one code number is listed, try entering from the code listed first.

- 1 Press and hold the **DVD/VCR** or **SAT/CABLE** FUNCTION button you want to program on the remote control and press the **DISP** button simultaneously. The selected FUNCTION button (DVD/VCR or SAT/CABLE) will flash.
- 2 Enter the three-digit manufacturer's code number using the **0-9** buttons while the button is lit, approximately 10 seconds.
- 3 Press **ENT** button.

When the programming is correct, the selected FUNCTION button will flash twice slowly, and when not, flashes five times quickly.

To check if the code works

Aim your TV's remote control at the equipment, and press the green **POWER** button. If the equipment responds, the programming is completed. If not, try the next code listed.

- If no code is input within the above specified time, or an invalid or incorrect code number is input, the remote control automatically goes back to the previous setting.
- In some cases, you may not be able to program your remote control to operate other equipment. In such cases, use the equipment's own remote control.
- Dead batteries or removing the batteries may cause the programmable codes to be lost and revert back to factory settings. Reprogramming the codes may be necessary.

Insert two size AA batteries (supplied) by matching the **+** and **-** on the batteries to the diagram inside the remote control's battery compartment.

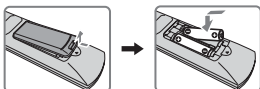

Manufacturer's Codes

DVD Players

<i>Manufacturer</i>	<i>Code</i>
Sony	751
General Electric	755
Hitachi	758
JVC	756
Magnavox	757
Mitsubishi	761
Panasonic	753
Philips	757
Pioneer	752
RCA/PROSCAN	755
Samsung	758
Toshiba	754
Zenith	760

DVD Changers

<i>Manufacturer</i>	<i>Code</i>
Sony	765
Panasonic	766

DVD/VCR Combo Units

<i>Manufacturer</i>	<i>Code</i>
Sony	767
Zenith	768
Toshiba	773
Samsung	774
JVC	775
Broksonic	776
Panasonic	777

HDD/DVD Combo Units

<i>Manufacturer</i>	<i>Code</i>
Sony	770, 771, 772

5.1ch DVD AV System

<i>Manufacturer</i>	<i>Code</i>
Sony (DAV)	601, 602, 603, 604

AV Receivers

<i>Manufacturer</i>	<i>Code</i>
Sony	764

VCRs

<i>Manufacturer</i>	<i>Code</i>
Sony	301, 302, 303
Admiral (M. Ward)	327
Aiwa*	338, 344
Audio Dynamic	314, 337
Broksonic	319, 317
Canon	309, 308

<i>Manufacturer</i>	<i>Code</i>
Citizen	332
Craig	302, 332
Curtis Mathes	304, 338, 309
Daewoo	341, 312, 309
DBX	314, 336, 337
Dimensia	304
Emerson	319, 320, 316, 317, 318, 341
Fisher	330, 335
Funai	338
General Electric	329, 304, 309
Go Video	322, 339, 340
Goldstar	332
Hitachi	306, 304, 305, 338
Instant Replay	309, 308
JC Penney	309, 305, 304, 330, 314, 336, 337
JVC	314, 336, 337, 345, 346, 347
Kenwood	314, 336, 332, 337
LG	332
LXI (SEARS)	332, 305, 330, 335, 338
Magnavox	308, 309, 310
Marantz	314, 336, 337
Marta	332
Memorex	309, 335
Minolta	305, 304
Mitsubishi/MGA	323, 324, 325, 326
Multitech	325, 338, 321
NEC	314, 336, 337
Olympic	309, 308
Optimus	327
Orion	317
Panasonic	308, 309, 306, 307
Pentax	305, 304
Philco	308, 309
Philips	308, 309, 310
Pioneer	308
Quasar	308, 309, 306
RCA/PROSCAN	304, 305, 308, 309, 311, 312, 313, 310, 329
Realistic	309, 330, 328, 335, 324, 338
Sansui	314
Samsung	322, 313, 321
Sanyo	330, 335
Scott	312, 313, 321, 335, 323, 324, 325, 326

<i>Manufacturer</i>	<i>Code</i>
Sharp	327, 328
Signature 2000 (M. Ward)	338, 327
SV2000	338
Sylvania	308, 309, 338, 310
Symphonic	338
Tashiro	332
Tatung	314, 336, 337
Teac	314, 336, 338, 337
Technics	309, 308
Toshiba	312, 311
Wards	327, 328, 335, 331, 332
Yamaha	314, 330, 336, 337
Zenith	331

Cable Boxes

<i>Manufacturer</i>	<i>Code</i>
Sony	230
Hamlin/Regal	222, 223, 224, 225, 226
Jerrold/G. I./Motorola	201, 202, 203, 204, 205, 206, 207, 208, 218, 222
Oak	227, 228, 229
Panasonic	219, 220, 221
Pioneer	214, 215
Scientific Atlanta	209, 210, 211
Tocom	216, 217
Zenith	212, 213

Satellite Receivers

<i>Manufacturer</i>	<i>Code</i>
Sony	801
Dish Network	810
Echostar	810
General Electric	802
Hitachi	805
Hughes	804
Mitsubishi	809
Panasonic	803
RCA/PROSCAN	802, 808
Toshiba	806, 807
Philips	811
Samsung	812

* If an Aiwa VCR does not work even though you enter the code for Aiwa, enter the code for Sony instead.

Using Other Equipment with Your Remote Control

To operate other connected equipment with your TV, first turn to page 35 and program the necessary code. For operating video equipment, press TV/VIDEO repeatedly until you see the video input on the screen for your connected equipment. Remote control operation tips are provided below.

 Some functions cannot be operated depending on the equipment. In that case, operate by the remote control supplied with the equipment.

Operating a Cable Box

To Do This ...	Press ...
Activate the remote control to operate the cable box	SAT/CABLE (FUNCTION)
Turn on/off	POWER

Operating a Satellite Receiver

To Do This ...	Press ...
Activate the remote control to operate the satellite receiver	SAT/CABLE (FUNCTION)
Turn on/off	POWER
Select a channel	0-9, ENT
Change channels	CH +/-
Back to previous channel	JUMP
Display channel number	DISPLAY

Operating a VCR

To Do This ...	Press ...
Activate the remote control to operate the VCR	DVD/VCR (FUNCTION)
Turn on/off	POWER
Change channels	CH +/-
Record	▶ while pressing ●
Play	▶
Stop	■

Operating a DVD Player or DVD Changer

To Do This ...	Press ...
Activate the remote control to operate the DVD	DVD/VCR (FUNCTION)
Turn on/off	POWER
If you have a DVD changer, to skip disk	F1
Play	▶
Stop	■
Pause	(press again to resume normal playback)

To Do This ...	Press ...
Select a channel	0-9, ENT
Change channels	CH +/-
Back to previous channel	JUMP

To Do This ...	Press ...
Display SAT Guide	GUIDE
Display SAT Menu	MENU
Move highlight (cursor)	▲ ▼ ◀ ▶
Select item	Ⓢ
Switch between the TV and satellite broadcasts	TV/SAT

To Do This ...	Press ...
Fast forward	▶▶
Rewind the tape	◀◀
Pause	(press again to resume normal playback)
Search the picture forward or backward	▶▶ or ◀◀ during playback (release to resume normal playback)

To Do This ...	Press ...
Step through different tracks of the disc	▶▶ to step forward or ◀◀ to step backward
Step through different chapters of the disc	CH + to step forward or CH - to step backward
Select a track directly	0-9, ENT
Display the menu (setup)	MENU
Display the top menu	TOP MENU
Operate the DVD menu	▲ ▼ ◀ ▶, Ⓢ

Operating a 5.1ch DVD AV System (Sony DAV)

To Do This ...	Press ...
Activate the remote control to operate the DVD	DVD/VCR (FUNCTION)
Turn on/off	POWER
Select other equipment connected to the DAV	F1
Skip a disk	F2
Display the DVD menu	TOP MENU
Display the menu (setup)	MENU

Operating a DVD/VCR Combo Unit

To Do This ...	Press ...
Activate the remote control to operate the DVD/VCR	DVD/VCR (FUNCTION)
Turn on/off	POWER
If you have a DVD/VCR combo component, Select the DVD	F 1
Select the VCR	F 2
Display the DVD menu	MENU
Play	▶
Stop	■
Pause	⏸

Operating a DVD/HDD Combo Unit

To Do This ...	Press ...
Activate the remote control to operate the DVD/HDD	DVD/VCR (FUNCTION)
Turn on/off	POWER
Select the HDD Select the DVD	F 1 F 2
Play	▶
Stop	■
Pause	⏸

Operating an AV Receiver

To Do This ...	Press ...
Turn on/off	POWER
Change volume	VOL +/-, MUTING

To Do This ...	Press ...
Play	▶
Stop	■
Pause	⏸
Search the picture forward or backward	▶▶ or ◀◀ during playback
Move highlight (cursor)	⬆ ⬇ ⬇ ⬆
Select item	Ⓢ
Change volume	VOL +/-, MUTING

To Do This ...	Press ...
Search the picture forward or backward	▶▶ or ◀◀ during playback
Move highlight (cursor) and select (DVD)	⬆ ⬇ ⬇ ⬆ Ⓢ
Record (VCR)	▶ while pressing ●
Change channels (VCR)	0-9, ENT (using tuner)
Specify the previous chapter/track	CH -
Specify the next chapter/track	CH +

To Do This ...	Press ...
Search the picture forward or backward	▶▶ or ◀◀ during playback
Move highlight (cursor) and select	⬆ ⬇ ⬇ ⬆ Ⓢ
Record	▶ while pressing ●
Specify the previous chapter/track	CH -
Specify the next chapter/track	CH +
Display the menu (setup)	MENU
Display the top menu	TOP MENU

Special Buttons on the Remote Control

Using the Wide Screen Mode

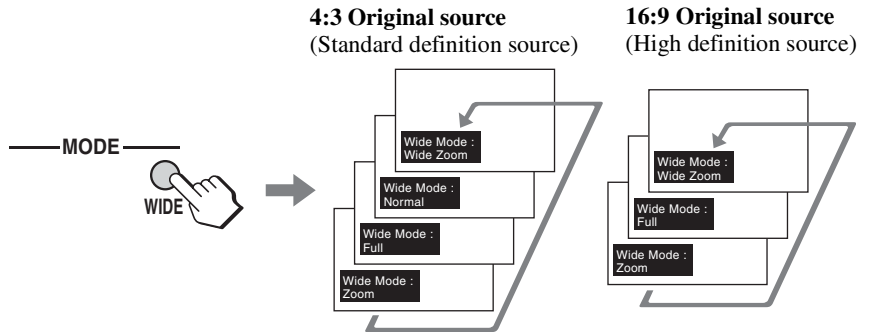







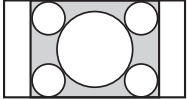

💡 When the TV receives a 720p or 1080i signal that is 4:3 aspect ratio picture with a black bar at each side, Full returns the picture to its original size.

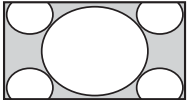
💡 You can also access the Wide Mode settings in the Screen settings. For details, see page 51.

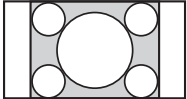
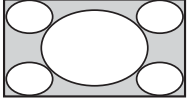
🔧 When the TV receives a 720p or 1080i signal, Normal cannot be selected.

Changing the wide screen mode

4:3 Original source Standard definition source	16:9 Original source High definition source
	
<p>Wide Zoom</p> 	<p>Wide Zoom</p> 
<p>Normal</p> 	<p>Normal</p> <p>This mode is not available</p>
<p>Full</p> 	<p>Full</p> 
<p>Zoom</p> 	<p>Zoom</p> 

Using the Jump Function

You can change or jump between the last two channels.



Previous channel

Using the Freeze Function

- While the picture is frozen, the sound continues to be output normally.

You can use this feature to write down information such as phone numbers, recipes, etc. When you press the button once, the current screen is frozen and the sub screen appears. When you press the button twice, only the frozen screen is displayed; when you press it a third time, the normal screen returns.

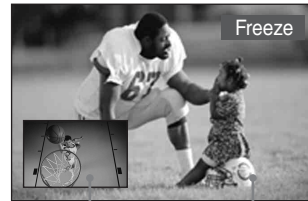

Current program

Frozen picture

Move the sub screen with ↑ ↓ ← →.

To cancel the Freeze function mode

Press FREEZE until the normal screen appears.



With Freeze function active, some functions are unavailable, such as WEGA GATE.

Using the Power Saving Function

- If you turn off the TV when the Power Saving mode is on, the mode stays on next time you turn on the TV except Picture Off.
- You can set the Power Saving mode to on using the settings screen. Select Power Saving in the Setup settings, then set it to Standard or Reduced.
- When Picture Off is selected, the PIC OFF LED lights.

You can reduce the power consumption of the TV.

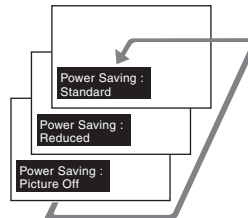

To cancel the Power Saving mode

Press POWER SAVING repeatedly until “Power Saving: Standard” appears.

Using the Sleep Function

- 💡 If you turn the TV off, and then turn it on again, the Sleep timer returns to Sleep Off.
- 💡 “TV will turn off soon” appears one minute before the TV shuts off. This message may not appear if you are performing other operations in the settings.
- 💡 You can set the Sleep timer to on using the Clock/Timers settings. Select Sleep in the Clock/Timers settings, then set it to 15, 30, 45, 60, 90 or Off.

You can set the TV to turn off automatically after a predetermined period of time (15, 30, 45, 60, or 90 minutes).

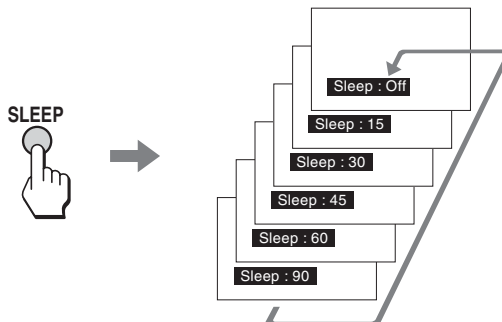

While the Sleep timer is activated, the TIMER LED on the TV lights up in red.

To cancel the Sleep timer

Press **SLEEP** repeatedly until Sleep Off appears or turn the TV power to off then turn on the TV again.

Introducing WEGA GATE

Overview of WEGA GATE

WEGA GATE provides one button access for controlling your TV. It enables you to perform a variety of tasks intuitively with a control panel on the screen rather than a variety of remote control button presses.

When you press the WEGA GATE button, you can perform basic TV operation: your favorite channels, watching TV, images from external equipment or setting menus.

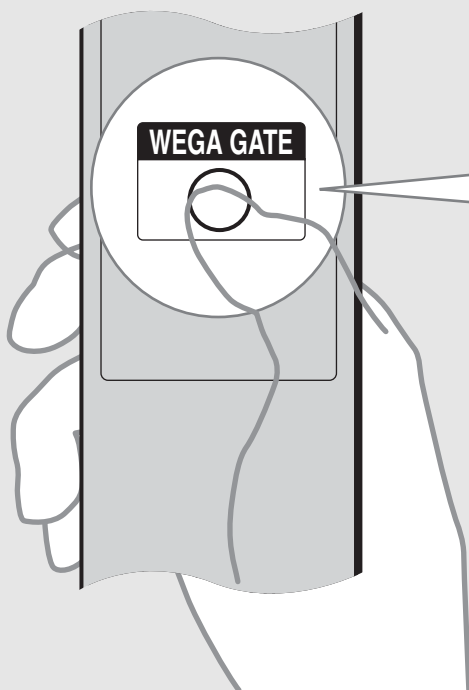

- 1 Press WEGA GATE on the remote. WEGA GATE control panel appears.

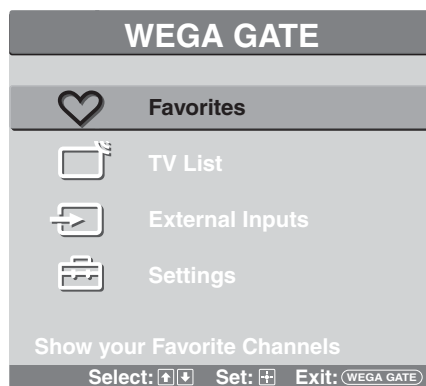



- 2 Press \uparrow/\downarrow to highlight the item.

- 3 Press $\left(\rightarrow\leftarrow\right)$ to select.

Press WEGA GATE to exit.

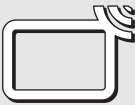
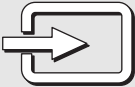
The WEGA GATE screen gives you access to the following items:

<i>Icon</i>	<i>Description</i>
 Favorites	The Favorites feature lets you select programs from a list of up to 8 favorites channels that you specify. For details, see page 44.
 TV List	The TV List feature lets you select TV programs from a list of channel labels. You can assign a label to the channel. For details, see page 45.
 External Inputs	The External Inputs feature lets you select equipment that is connected to your TV, such as a DVD player. You can assign a label to your equipment or skip unused inputs conveniently. For details, see page 45.
 Settings	The Settings feature lets you adjust the Video , Audio , Screen , Channel , Parent , Clock/Timers or Setup settings. For details, see page 45.

Navigating and Select

Use your remote control to navigate through WEGA GATE and the settings.

To Do This ...	Press ...
Display WEGA GATE control panel	Press WEGA GATE.
Display Settings	Press WEGA GATE and select Settings.
Move through Settings	Press ↑ ↓ ← → .
Select an option to change	Press (+) .
Move back to upper layer	Press RETURN or select Return in the settings.
Select (confirm) changed setting	Press (+) .
Exit WEGA GATE control panel or Settings	Press WEGA GATE.

Using Favorites in WEGA GATE

The Favorites feature lets you select programs from a list of up to 8 favorite channels that you specify. You can create a list using the Add to Favorites option.

- 1 Select Favorites from the WEGA GATE control panel and press **(+)**.

The Favorite Channels list appears. Make your selection.

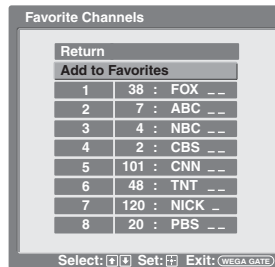



- 2 Press **↑/↓** to highlight the desired channel and press **(+)**.
 - To add the current channel to the list of Favorite Channels, highlight Add to Favorites and press **(+)**.
 - When the Favorite Channels list is full, remove a channel from your list using Favorite Channels in the Channel settings and try again. (see page 53)

Using TV List in WEGA GATE

The TV List feature lets you select TV programs from a list of channel labels. You can also assign a label using Label Channels in the Channel settings. (see page 54)

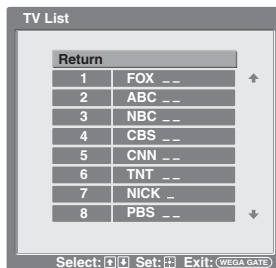
- 1 Select TV List from the WEGA GATE control panel and press  .
The TV channel list appears. Make your selection.





- 2 Press  to highlight the desired channel and press  .

Using External Inputs in WEGA GATE

The External Inputs feature lets you select the external inputs connected to your TV. You can also assign a label using Label Video Inputs in the Setup settings. (see page 61)

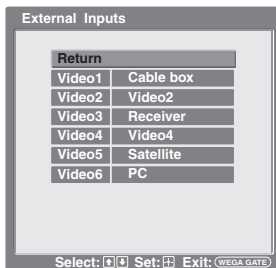
- 1 Select External Inputs from the WEGA GATE control panel and press  .
The External Inputs list appears. Make your selection.



- 2 Press  to highlight the desired external input and press  .



Using Settings in WEGA GATE

The Settings feature lets you enter to the settings screen where most of advanced settings and adjustments are performed. See “Overview of the Settings” in page 46.

Using the Settings

Overview of the Settings

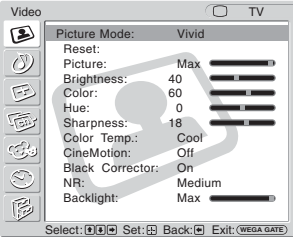
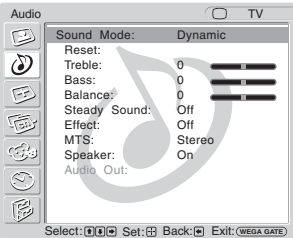
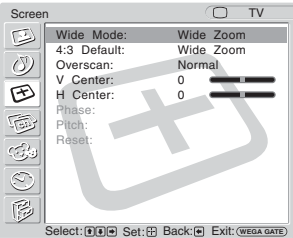
The Settings provides you access to the following features:

Settings	Allows you to set/change
Video 	Picture Mode (page 48) Reset (page 48) Picture (page 48) Brightness (page 48) Color (page 48) Hue (page 48) Sharpness (page 48) Color Temp. (page 48) CineMotion (page 48) Black Corrector (page 48) NR (pages 48) Backlight (pages 48)
Audio 	Sound Mode (page 49) Reset (page 49) Treble (page 49) Bass (page 49) Balance (page 49) Steady Sound (page 49) Effect (page 49) MTS (page 49) Speaker (page 50) Audio Out (page 50)
Screen 	Wide Mode (page 51) 4:3 Default (page 51) Overscan (page 52) V Center (page 52) H Center (page 52) Phase (page 52) Pitch (page 52) Reset (page 52)
Channel 	Favorite Channels (page 53) Cable (page 53) Channel Fix (page 53) Auto Program (page 53) Show/Hide Channels (page 54) Label Channels (page 54)

Settings

Allows you to set/change

Parent



- Lock (page 55)
- Select Country (page 55)
- Change Password (page 55)

Clock/Timers

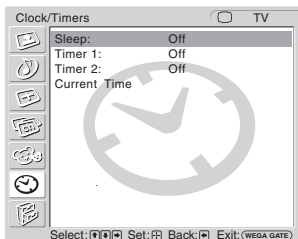

- Sleep (page 58)
- Timer 1 (page 58)
- Timer 2 (page 58)
- Current Time (page 59)

Setup

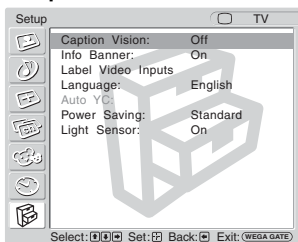

- Caption Vision (page 60)
- Info Banner (page 60)
- Label Video Inputs (page 61)
- Language (page 61)
- Auto YC (page 61)
- Power Saving (page 61)
- Light Sensor (page 61)

Using the Video Settings

To select the Video settings

1. Press WEGA GATE
2. Select Settings
3. Highlight Video
4. Press to select



To exit the Video settings, press .

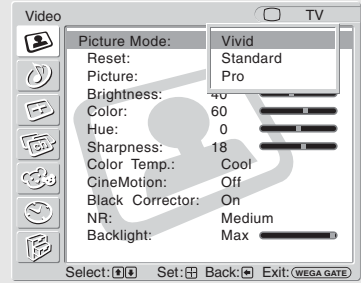

Selecting Video Options

- 💡 To change from one Picture Mode to another, use PICTURE on the remote control.
- 💡 You can alter the Picture Mode options (Vivid, Standard, Pro) for each video input (including the TV antenna input).
- 💡 You can alter the Video settings (Picture, Brightness, Color, etc.) for each Mode.

- 💡 Color, Hue, Sharpness, CineMotion, Black Corrector and NR are not available for PC input.

The Video settings includes the following options:

To highlight an option and to change settings, press $\uparrow \downarrow \leftarrow \rightarrow$.

Press  to confirm the selection.

Option	Description
Picture Mode	Vivid Select for enhanced picture contrast and sharpness.
<i>Customized picture viewing</i>	Standard Select for standard picture settings. Recommended for home entertainment.
	Pro Select for professional monitor like appearance settings.
Reset	Reset all settings and adjustments to the default setting for each Picture Mode (Vivid, Standard, Pro) (except for the options grayed out).
Picture	Adjust to increase picture contrast, or decrease picture contrast.
Brightness	Adjust to brighten or darken the picture.
Color	Adjust to increase or decrease color intensity.
Hue	Adjust to increase or decrease the green tones.
Sharpness	Adjust to sharpen or soften the picture.
Color Temp.	Cool Select to give the white colors a bluish tint.
<i>White adjustment</i>	Neutral Select to give the white colors a neutral tint.
	Warm Select to give the white colors a reddish tint.
CineMotion	Provides an optimized display by automatically detecting film content and applying a reverse 3-2 pulldown process. Moving pictures will appear clearer and more natural-looking.
Black Corrector	Select On to enhance the black colors to give the picture strong contrast.
NR (Noise reduction)	Select to reduce the noise level of connected equipment. It is also effective on the signal from the VHF/UHF jack. Select from High, Medium, Low and Off.
Backlight	Adjust to brighten or darken the backlight.

Using the Audio Settings

To select the Audio settings

1. Press
WEGA GATE
2. Select
Settings
3. Highlight
Audio
4. Press
to select



To exit the Audio settings, press .

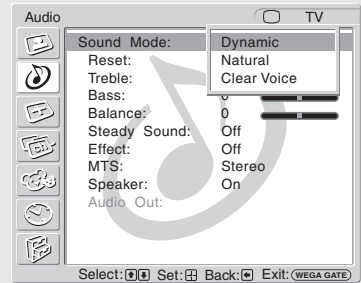

Selecting Audio Options

- To change from one Sound Mode option to another, use SOUND on the remote control.
- Treble, Bass and Balance are adjustable when the Audio Out option is set to Variable.
- Sound Mode settings are independent of Treble/Bass settings.
- To change from one Effect option to another, use (●) on the remote control.
- To change from one MTS option to another, use MTS/SAP on the remote control.
- MTS is not available when Video, Component, HDMI or PC input is selected.

The Audio settings includes the following options:

To highlight an option and to change settings, press $\uparrow \downarrow \leftarrow \rightarrow$.

Press  to confirm the selection.

Option	Description
Sound Mode	Dynamic Select to enhance treble and bass.
<i>Customized sound listening</i>	Natural Flat setting.
	Clear Voice Suitable for spoken dialogue.
Reset	Reset the following settings; Treble, Bass and Balance to the default setting.
Treble	Adjust to increase or decrease higher-pitched sounds.
Bass	Adjust to increase or decrease lower-pitched sounds.
Balance	Adjust to emphasize left or right speaker balance.
Steady Sound	Auto Select to stabilize the volume.
	Off Select to turn off Steady Sound.
Effect	TruSurround Select for surround sound (for stereo programs only).
	Simulated Adds a surround-like effect to mono programs.
	Off Select for normal stereo or mono reception.
MTS	Stereo Select for stereo reception when viewing a program broadcast in stereo.
<i>Enjoy stereo, bilingual and mono programs</i>	Auto SAP Select to automatically switch the TV to second audio programs when a signal is received. If no SAP signal is present, the TV remains in Stereo mode.
	Mono Select for mono reception. Use to reduce noise during weak stereo broadcasts.

(Continued)

Using the Settings

💡 Headphones are off when the Speaker option is set to Off.

💡 Variable in Audio Out option is available only when the Speaker option is set to Off.

<i>Option</i>	<i>Description</i>	
Speaker	On	Select to turn on the TV speakers.
	Off	Select to turn off the TV speakers and listen to the TV's sound only through your external audio receiver and speakers.
Audio Out <i>Easy control of volume adjustments</i>	Variable	The TV's speaker are turned off, and the audio output from your audio system can still be controlled by the TV's remote control.
	Fixed	The TV's speakers are turned off and the audio output of the TV is fixed. Use your audio receiver's remote control to adjust the volume (and other audio settings) through your audio system.

Using the Screen Settings

To select the Screen settings

1. Press WEGA GATE
2. Select Settings
3. Highlight Screen
4. Press to select



To exit the Screen settings, press .

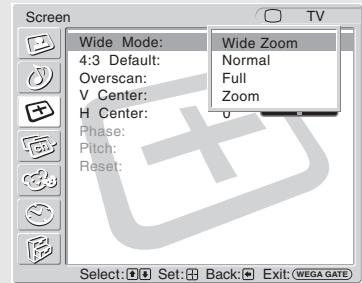



Selecting Screen Options

- To change from one Wide Mode option to another, use WIDE on the remote control.
- For Wide Zoom and Zoom modes, you can adjust the vertical position of the picture. For details, see page 52.
- Normal, Full1 and Full2 are available for Wide Mode when PC input is selected.
- 4:3 Default functions only when the TV receives 480i or 480p signals.
- If 4:3 Default option is set to anything but Off, the Wide Mode setting changes only for the current channel. When you change channels (or inputs), Wide Mode is automatically replaced with the 4:3 Default setting for 4:3 sources. To retain the current Wide Mode setting as channels and inputs are changed, set 4:3 Default to Off.

The Screen settings includes the following options:

To highlight an option and to change settings, press $\uparrow \downarrow \leftarrow \rightarrow$.

Press  to confirm the selection.

Option	Description
Wide Mode	Wide Zoom
Select a Wide Mode to use for 4:3 sources	Select to enlarge to fill screen with minimum distortion.
	Normal
	Select to display 4:3 picture in original size when the original source is 4:3 (Standard definition source).
	Full
	Select to enlarge the original picture horizontally to fill the screen when the original source is 4:3 (Standard definition source). When the original source is 16:9 (High definition source), select this mode to display 16:9 picture in original size.
	Zoom
	Select to enlarge the original picture without distorting the aspect ratio.
4:3 Default	Wide Zoom
Select the default Screen Mode to use for 4:3 sources	Select to enlarge the 4:3 picture to fill the 16:9 screen, keeping the original image as much as possible.
	Normal
	Select to return the 4:3 picture to its original size.
	Full
	Select to enlarge the 4:3 picture horizontally only, to fill the 16:9 screen.
	Zoom
	Select to enlarge the 4:3 picture horizontally and vertically to an equal aspect ratio that fills the 16:9 screen. Useful for watching Letterbox movies.
	Off
	Select to continue using the current Wide Screen Mode setting when the channel or input is changed.
	 Not available for PC input.

(Continued)







Using the Settings

 4:3 Default and Overscan are not available for PC Input.

 The setting of V Center and H Center can be between - 50 and + 50 for PC input.

 H Center feature is useful if TV is connected to game equipment.

 Adjust Phase and Pitch with Wide Mode set to Normal.

Option	Description	
Overscan	Normal	Displays a standard size picture.
	+1/+2	Allows you to adjust the viewable picture area size. This is useful for viewing ticker tape or banners at the top or bottom of the screen.
 Not available for PC input.		
V Center (Vertical Center)	Allows you to move the position of the picture up and down in the window. Available only in Wide Zoom and Zoom modes. Press  /  and press  to choose a correction between +10 and -10 (Zoom mode), and +10 and -10 (Wide Zoom mode).	
H Center (Horizontal Center)	Allows you to move the position of the picture left and right in the window. This function allows for horizontal adjustment of the picture being displayed.	
Phase	Adjust after Pitch to fine tune overall sharpness.	
 Available only for PC input.		
Pitch	Adjust uneven sharpness on screen.	
 Available only for PC input.		
Reset	Clear Wide Mode, V Center, H Center, Phase and Pitch adjustments you made to the factory settings.	
 Available only for PC input.		

PC Input Signal Compatibility Chart

Resolution Signals	Horizontal (Pixel)	×	Vertical (Line)	Horizontal frequency (kHz)	Vertical frequency (Hz)	VESA standard
VGA	640	×	480	31.5	60	—*
	640	×	480	37.9	73	✓
	640	×	480	37.5	75	✓
	720	×	400	31.5	70	—*
SVGA	800	×	600	35.2	56	✓
	800	×	600	37.9	60	✓
	800	×	600	46.9	75	✓
	800	×	600	48.1	72	✓
	848	×	480	31.0	60	✓
XGA	1024	×	768	48.4	60	✓
	1024	×	768	56.5	70	✓
	1024	×	768	60	75	✓
WXGA	1280	×	768	47.4	60	✓
	1280	×	768	47.8	60	✓
	1280	×	768	60.3	75	✓
	1360	×	768	47.7	60	✓

*: Corresponding to the VGA signal

 This TV does not support Sync on Green or Composite Sync.

 If a signal other than in the above chart is input, it may not be displayed properly or may not be displayed as you set.

 Using the Vertical frequency (Hz) of the personal computer at 60 is recommended.

Using the Channel Settings

To select the Channel settings

1. Press WEGA GATE
2. Select Settings
3. Highlight Channel
4. Press to select



To exit the Channel settings, press .







Selecting Channel Options

- Also, you can access the Favorite Channels list on the WEGA GATE control panel.

The Channel settings includes the following options:

To highlight an option and to change settings, press $\uparrow\downarrow\leftarrow\rightarrow$.

Press  to confirm the selection.

Option	Description
Favorite Channels	Lets you set up a list of up to 8 of your favorite channels. <ol style="list-style-type: none"> 1 Press  to select Program. 2 Press \uparrow/\downarrow to highlight a Favorite Channel number (1-8) which you want to make your Favorite Channel, then press  to select it. 3 Press \uparrow/\downarrow to scroll through the channels until you find the channel that you would like to edit and then press  to select it. 4 To select other Favorite Channel numbers, repeat steps 2-3. 5 Press \leftarrow to return to the Channel settings, or press WEGA GATE to exit Settings.
Cable	<p>On Select if you are receiving cable channels with a CATV cable.</p> <p>Off Select if you are using an antenna.</p> <p> You should run Auto Program after changing the cable setting.</p>
Channel Fix <i>Useful when you have a cable box or a satellite receiver connected</i>	<p>Off Turns off Channel Fix.</p> <p>2-6 Select one of these channels if something is connected to the VHF/UHF jack.</p> <p>Video 1, 4 Use this setting if you have connected the equipment to the A/V input jacks.</p>
Auto Program	Automatically sets up the channel list on the TV for all receivable channels.

(Continued)

Using the Settings

💡 Channels that you set to be hidden can be accessed only with the 0-9 buttons.

💡 Also, you can access the TV channel list on the WEGA GATE control panel.

<i>Option</i>	<i>Description</i>
Show/Hide Channels	<p>Allows you to show or hide channels that appear when you use the CH +/- buttons.</p> <ol style="list-style-type: none">1 Press ▲/▼ to scroll through the channels until you find the channel you want to show or hide. Then press (+) to select it.2 Press ▲/▼ to determine if the channel will be shown or hidden.3 To show or hide more channels, repeat steps 1 and 2.4 Press ◀ to return to the Channel settings, or press WEGA GATE to exit Settings.
Label Channels	<p>Allows you to assign labels (such as station call letters) to channel numbers.</p> <ol style="list-style-type: none">1 Press ▲/▼ to scroll through the channel numbers. Then press (+) to select the channel number that you want to assign a label.2 Press ▲ ▼ ◀ ▶ to highlight Label and press (+).3 Press ▲/▼ to scroll through the label characters (A-Z, 0-9, etc.). Then press (+) to select the highlighted character. Repeat to add up to 5 characters to the label.4 To assign labels to more channels, repeat steps 1-3.5 Press ◀ to return to the Channel settings, or press WEGA GATE to exit Settings.

Using the Parent Settings

The Parent settings allows you to set up the TV to block programs according to their content and rating levels.

To select the Parent settings

1. Press **WEGA GATE**
2. Select **Settings**
3. Highlight **Parent**
4. Press **+** to select





Use 0-9 on the remote control to enter a four-digit password.

The first time you create a password, confirm the password by entering it again.

The Parent settings options appear.

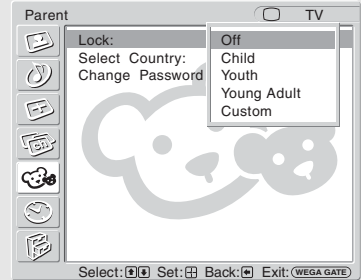
To exit the Parent settings, press .



 You need your password for any future access into the Parent settings. If you lose your password, see "Lost password." on page 64.

Selecting Parent Options

 If you are not familiar with the Parental Guideline rating system, you should select Child, Youth, or Young Adult to help simplify the rating selection. To set more specific ratings, select Custom.

 For descriptions of Child, Youth, and Young Adult ratings, see page 56.

The Parent settings includes the following options:

To change settings, press **▲▼◀▶**.

Press **(+)** to confirm the selection.

Option	Description
Lock	Off Parental lock is off. No programs are blocked from viewing.
Turn ratings on/off and select a rating system	Child Maximum ratings permitted are: <input type="checkbox"/> US: TV-Y, TV-G, G <input type="checkbox"/> Canada: C, G, TV-Y, TV-G Youth Maximum ratings permitted are: <input type="checkbox"/> US: TV-PG, PG <input type="checkbox"/> Canada: C8+, PG, 8ans+, TV-PG Young Adult Maximum ratings permitted are: <input type="checkbox"/> US: TV-14, PG-13 <input type="checkbox"/> Canada: 14+, 13ans+, TV-14 Custom Select to set ratings manually. <input type="checkbox"/> US: See page 56 for details. <input type="checkbox"/> Canada: See page 57 for details.
Select Country	U.S.A. Select to use USA ratings (see page 56). Canada Select to use Canadian ratings (see page 57).
Change Password	For changing your password.

US Models: Selecting Custom Rating Options

- 💡 The Content-Based Ratings are linked to the level of the Age-Based Rating. For example, a program with an Age-Based Rating of TV-PG V (Violence) rating may contain moderate violence, while a TV-14 V (Violence) rating may contain more intense violence.
- 💡 To ensure maximum blocking capability, set the Age-Based Ratings.
- 💡 If you block unrated TV programs, be aware that the following types of programs may be blocked: programs broadcast from another country, emergency broadcasts, political programs, sports, news, public service announcements, religious programs and weather.

For US models, the Custom Rating menu includes the following options. For Canadian models, see page 57.

Option	Description
Movie Rating	G All children and General Audience.
	PG Parental Guidance suggested.
	PG-13 Parental Guidance for children under 13.
	R Restricted viewing, parental guidance is suggested for children under 17.
	NC-17 and X No one 17 or under allowed.
TV Rating	Age-Based Ratings
<i>Block programs by their rating, content or both</i>	TV-Y All children.
	TV-Y7 Directed to children age 7 and older.
	TV-G General Audience.
	TV-PG Parental Guidance suggested.
	TV-14 Parents Strongly cautioned.
	TV-MA Mature Audience only.
	Content-Based Ratings
FV Fantasy Violence.	
D Suggestive Dialogue.	
L Strong Language.	
S Sexual situations.	
V Violence.	
Unrated	Allow Allows programs and movies that are broadcast without a rating.
	<i>Block programs or movies that are broadcast without a rating</i> Block Blocks all programs and movies that are broadcast without a rating.

Viewing Blocked Programs

You can view blocked programs by entering the password. Press ENT when tuned to a blocked program, then enter the password. This temporarily switches off Parent. To reactivate the Parent settings, turn off the TV. When the TV is turned on again, your Parent settings are reactivated.

Canadian Models: Selecting Custom Rating Options

For Canadian models, the Custom Rating menu includes the following options. For US models, see page 56.

<i>Option</i>	<i>Description</i>	
English Rating	C	All children.
	C8+	Children 8 years and older.
	G	General programming.
	PG	Parental Guidance.
	14+	Viewers 14 and older.
	18+	Adult programming.
French Rating	G	General programming.
	8ans+	Not recommended for young children.
	13ans+	Not recommended for ages under 13.
	16ans+	Not recommended for ages under 16.
	18ans+	Programming restricted to adults.
U.S.A. Rating	See "US Models" on page 56 for details.	

Viewing Blocked Programs

You can view blocked programs by entering the password. Press ENT when tuned to a blocked program, then enter the password. This temporarily switches off Parent. To reactivate the Parent settings, turn off the TV. When the TV is turned on again, your Parent settings are reactivated.

Using the Clock/Timers Settings

To Select the Clock/Timers settings

1. Press WEGA GATE
2. Select Settings
3. Highlight Clock/Timers
4. Press to select



To exit the Clock/Timers settings, press .

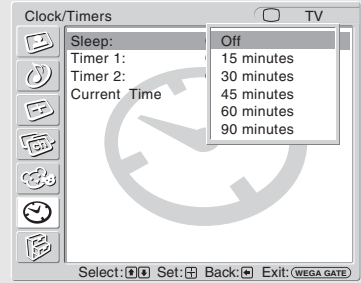



Selecting Clock/Timers Options

The Clock/Timers settings includes the following options:

To highlight an option and to change settings, press **▲▼◀▶**.







Press **(+)** to confirm the selection.

 To return to the Timer settings after programming one of the Timers or current time, press **◀**.

 Timer will be set to Off when:

- Auto Program is executed
- Channel Fix is set
- the AC power cord is disconnected and then reconnected to turn the TV on and the Current Time is displayed as ---:-- --.

Option	Description						
Sleep	Set the time in minutes (15 minutes, 30 minutes, 45 minutes, 60 minutes, 90 minutes, or Off) that you want the TV to remain on before shutting off automatically.						
Timer 1 Timer 2	You can use the Timers to program the TV to turn on and off and tune to a specific channel at two scheduled viewing times. Timer 1 and Timer 2 are not available to be set until you set the Current Time. <ol style="list-style-type: none"> 1 Press ▲/▼ to highlight Timer 1 or Timer 2. To set the timer, press ▶ or (+). 2 Press ▲/▼ to highlight one of the following options, then press (+). <table border="0" style="width: 100%;"> <tr> <td style="width: 30%;">Set</td> <td>Select to set the Timer by day, time, duration, and channel.</td> </tr> <tr> <td>On</td> <td>Select to turn on the timer.</td> </tr> <tr> <td>Off</td> <td>Select to turn off the Timer. (Your previous settings are saved.)</td> </tr> </table> 3 If you selected Set in step 2, press ▲/▼ to set the day(s), hour, minute, duration, and channel number. Press (+) or ▶ to confirm each setting and move to the next setting. Press ◀ to go back to the previous setting and select On to turn on the timer. TIMER LED on the front panel will light, indicating the timer has been set. 4 Press WEGA GATE to exit Settings. 	Set	Select to set the Timer by day, time, duration, and channel.	On	Select to turn on the timer.	Off	Select to turn off the Timer. (Your previous settings are saved.)
Set	Select to set the Timer by day, time, duration, and channel.						
On	Select to turn on the timer.						
Off	Select to turn off the Timer. (Your previous settings are saved.)						

<i>Option</i>	<i>Description</i>
Current Time	Select to set the current time (day, hour, minute, and AM/PM). 1 Press  to select Current Time. 2 Press  /  to set the current time (day, hour, minute, and AM/PM). Press  or  to confirm each setting and move to the next setting. Press  to go back to the previous setting. 3 Press WEGA GATE to exit Settings.

Using the Setup Settings

To select the Setup settings

1. Press WEGA GATE
2. Select Settings
3. Highlight Setup
4. Press to select



To exit the Setup settings, press .

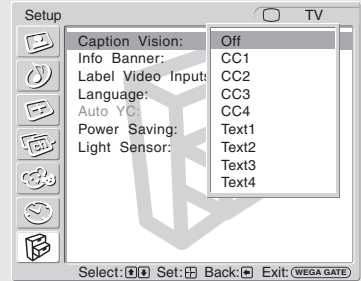

Selecting Setup Options

The Setup settings includes the following options:

To highlight an option and to change settings, press **↑ ↓ ← →**.

Press **+** to confirm the selection.











Option	Description
Caption Vision	Allows you to select from several closed caption modes (for programs that are broadcast with closed caption).
Off	Caption Vision is turned off.
CC1, CC2, CC3, CC4	Displays a printed version of the dialog or sound effects of a program. (Should be set to CC1 for most programs.)
Text1, Text2, Text3, Text4	Displays network/station information presented using either half or the whole screen (if available).
Info Banner	Set to On or Off. When on, displays the program name (if the broadcaster offers this service). Displays for up to four seconds when the channel is changed or the DISPLAY button is pressed.

 If you have assigned Video Labels, you can access the External Inputs list on the WEGA GATE control panel.

 The Skip label is useful for inputs to which no equipment is connected.

 To change from one Power Saving option to another, use POWER SAVING on the remote control.

 In low light ambient the range of the backlight control is reduced when the light sensor is set to On.

Option	Description						
Label Video Inputs	<p>Allows you to identify A/V equipment you connected to the TV, such as a VCR, DVD, etc. For example, if you have a DVD player connected to the VIDEO 4 jack, you can select the label DVD for the VIDEO 4 input. Then when you press TV/VIDEO to change inputs, the Video Label you assigned to that input appears on screen.</p> <ol style="list-style-type: none"> Press  to highlight the video input (VIDEO 1-6) to which you want to assign a label. Then press  to select the input. Press  to highlight one of the displayed labels. Then press  to select the label. <p>You can select from the following labels for each input:</p> <table border="1"> <tr> <td>Video 1-3</td> <td>Video 1-3, VHS, DVD, Receiver, Satellite, Cable Box, 8mm, DTV, Game, LD, Beta, Skip</td> </tr> <tr> <td>Video 4-5</td> <td>Video 4-5, DVD, Satellite, Cable Box, DTV, HD, Game, PVR, Skip</td> </tr> <tr> <td>Video 6</td> <td>Video 6, PC, DVD, HD, Game, Skip</td> </tr> </table> <p> If you select Skip, your TV skips this input when you press the TV/VIDEO button.</p>	Video 1-3	Video 1-3, VHS, DVD, Receiver, Satellite, Cable Box, 8mm, DTV, Game, LD, Beta, Skip	Video 4-5	Video 4-5, DVD, Satellite, Cable Box, DTV, HD, Game, PVR, Skip	Video 6	Video 6, PC, DVD, HD, Game, Skip
Video 1-3	Video 1-3, VHS, DVD, Receiver, Satellite, Cable Box, 8mm, DTV, Game, LD, Beta, Skip						
Video 4-5	Video 4-5, DVD, Satellite, Cable Box, DTV, HD, Game, PVR, Skip						
Video 6	Video 6, PC, DVD, HD, Game, Skip						
Language	Select to display all on-screen Settings in your language of choice: English, Español, Français.						
Auto YC	<p>When connecting both VIDEO IN and S VIDEO IN, you can select the jack from which the TV receives the input signal. The TV is factory set to receive S VIDEO input signals.</p> <ol style="list-style-type: none"> Press TV/VIDEO repeatedly until the desired video input appears. After selecting the Auto YC option, to watch the pictures input from the S VIDEO input jack: Press  to select On, then press . To watch the pictures input from the VIDEO input jack: Press  to select Off, then press . Press WEGA GATE to exit Settings. 						
Power Saving	<table border="1"> <tr> <td>Standard</td> <td>Select to view picture without the benefit of Power Saving.</td> </tr> <tr> <td>Reduced</td> <td>Select to view picture with reduced power consumption. It also enhances the black level.</td> </tr> <tr> <td>Picture Off</td> <td>Select to turn off the picture. Audio stays on with your selected volume setting.</td> </tr> </table>	Standard	Select to view picture without the benefit of Power Saving.	Reduced	Select to view picture with reduced power consumption. It also enhances the black level.	Picture Off	Select to turn off the picture. Audio stays on with your selected volume setting.
Standard	Select to view picture without the benefit of Power Saving.						
Reduced	Select to view picture with reduced power consumption. It also enhances the black level.						
Picture Off	Select to turn off the picture. Audio stays on with your selected volume setting.						
Light Sensor	<p>Select On to enable the automatic brightness control. The light sensor measures the room brightness which allows the TV to automatically adjust the picture brightness based on the picture settings and the ambient room light conditions.</p> <p> Be sure not to put anything around the sensor, as its function may be affected. See page 13 on the sensor.</p>						

Other Information

Troubleshooting

Trouble Symptoms and Remedies

Problem	Possible Remedies
No picture (screen not lit), no sound.	<input type="checkbox"/> If your TV does not turn on, and a red light keeps flashing, your TV may need service. Call your local Sony Service Center.
No picture.	<input type="checkbox"/> Check Power Saving settings (page 61).
Cannot receive any channels.	<input type="checkbox"/> Make sure the power cord is connected securely. <input type="checkbox"/> Turn on the power of the TV. <input type="checkbox"/> Check antenna/cable connections.
Cannot receive upper channels (UHF) when using an antenna.	<input type="checkbox"/> Set Cable to Off in the Channel settings (page 53). <input type="checkbox"/> Perform Auto Program to add receivable channels that are not presently in the TV's memory (page 53).
TV is locked to one channel.	<input type="checkbox"/> Check your Channel Fix setting (page 53). <input type="checkbox"/> Perform Auto Program to add receivable channels that are not presently in the TV's memory (page 53).
Cannot receive any channels when using cable TV.	<input type="checkbox"/> Perform Auto Program to add receivable channels that are not presently in the TV's memory (page 53). <input type="checkbox"/> Make sure Cable in the Channel settings is set to On (page 53).
Cannot receive or select channels.	<input type="checkbox"/> Perform Auto Program to add receivable channels that are not presently in the TV's memory (page 53).
The TV turns off automatically.	<input type="checkbox"/> Check if the Sleep timer is activated (page 58).
No picture from some video sources.	<input type="checkbox"/> Check the connection between the optional video equipment and the TV. <input type="checkbox"/> Press TV/VIDEO on the remote control (page 33). <input type="checkbox"/> If you connect video equipment to the S VIDEO input of the TV, set Auto YC to On in the Setup settings (page 61). <input type="checkbox"/> Press WEGA GATE on the remote control. Select your desired input from the External Inputs list.
Poor picture.	
Double images or ghosts.	<input type="checkbox"/> Check antenna/cable connections. <input type="checkbox"/> Check the antenna location and direction.

Problem	Possible Remedies
Only snow and noise appear on the screen.	<ul style="list-style-type: none"> <input type="checkbox"/> Check if the antenna is broken or bent. <input type="checkbox"/> Check if the antenna has reached the end of its serviceable life. (3-5 years in normal use, 1-2 years at the seaside.)
Dotted lines or stripes.	<ul style="list-style-type: none"> <input type="checkbox"/> Keep the TV away from noise sources such as cars, motorcycles, or hair-dryers.
No color/Dark picture/Color is not correct	<ul style="list-style-type: none"> <input type="checkbox"/> Press PICTURE to select the desired Picture mode (page 33). <input type="checkbox"/> Adjust the Picture Mode options in the Video settings (page 48).
The picture is too bright.	<ul style="list-style-type: none"> <input type="checkbox"/> Press PICTURE to select the desired Picture mode (page 33).
Noisy picture.	<ul style="list-style-type: none"> <input type="checkbox"/> Make sure that the antenna is connected using the supplied 75-ohm coaxial cable. <input type="checkbox"/> Keep the antenna cable away from other connecting cords. <input type="checkbox"/> Do not use 300-ohm twin lead cables as interference may occur.
No sound/Noisy sound	
Good picture, no sound.	<ul style="list-style-type: none"> <input type="checkbox"/> Check the volume control. <input type="checkbox"/> Press MUTING or VOL + so that "Muting" disappears from the screen (page 32). <input type="checkbox"/> Disconnect your headphones. <input type="checkbox"/> Set Speaker to On in the Audio settings (page 50). If it is set to Off, sound is not output from the TV's speakers regardless of the TV's volume control.
Audio noise.	<ul style="list-style-type: none"> <input type="checkbox"/> Make sure that the antenna is connected using the supplied 75-ohm coaxial cable. <input type="checkbox"/> Keep the antenna cable away from other connecting cords. <input type="checkbox"/> Do not use 300-ohm twin lead cables as interference may occur. <input type="checkbox"/> Press MTS/SAP to select Mono (page 33).
Striped noise during playback/recording of a VCR.	<ul style="list-style-type: none"> <input type="checkbox"/> This is caused by video head interference. Keep your VCR away from the TV. <input type="checkbox"/> Leave a space of 30 cm (11 7/8 inches) between your VCR and the TV to avoid noise. <input type="checkbox"/> Avoid installing your VCR in front of the TV or at the side of the TV.
Cannot operate settings item.	<ul style="list-style-type: none"> <input type="checkbox"/> If the option you want to select appears in a pale color, you cannot select it.
Wide Screen Mode changes automatically.	<ul style="list-style-type: none"> <input type="checkbox"/> The current Wide Screen Mode setting is automatically replaced with the 4:3 Default setting when you change the channel or video input, if 4:3 Default in the Screen settings is set to other than Off. If you want to lock in the Wide Screen Mode selected with the WIDE button, set 4:3 Default to Off in the Screen settings (page 51).
Remote control does not operate.	<ul style="list-style-type: none"> <input type="checkbox"/> The batteries could be weak. Replace the batteries. <input type="checkbox"/> Check the polarity of the batteries. <input type="checkbox"/> Press the TV (FUNCTION) button first for TV operation. <input type="checkbox"/> Point the remote control at the remote control sensor of the TV. <input type="checkbox"/> Install the TV away from fluorescent lights. <input type="checkbox"/> Press FUNCTION button for corresponding device you want to control.

(Continued)

Other Information

Problem	Possible Remedies
Cannot change channels with the remote control.	<ul style="list-style-type: none"><input type="checkbox"/> If you are using another device to change channels, be sure you have not inadvertently switched your TV from channel 3 or 4 setting. Use the Channel Fix option to “fix” the channel based on the type of hookup (page 53).<input type="checkbox"/> If you are using another device to control channels, be sure the FUNCTION button for that device has been pressed. For example, if you are using your cable box to control channels, be sure to press SAT/CABLE (page 32).
Lost password.	<ul style="list-style-type: none"><input type="checkbox"/> Select the Parent settings on the settings screen, then enter the following master password: 4357. The master password clears your previous password and allows you to enter a new password (page 55).

Contacting Sony

If, after reading these operating instructions, you have additional questions related to the use of your Sony TV, please call our Customer Information Services Center at 1-800-222-SONY (7669) (US residents only) or 1-877-899-SONY (7669) (Canadian residents only).

Before calling Sony customer support, please write down the model and serial numbers of your TV. You'll find this information on the front cover of this manual.

Specifications

Television system:

American TV standard

Channel coverage:

VHF: 2-13/UHF: 14-69/CATV: 1-125

Antenna:

75-ohm external terminal for VHF/UHF

Screen size (measured diagonally):

KLV-S19A10: 19 inches

KLV-S23A10: 23 inches

KLV-S26A10: 26 inches

KLV-S32A10: 32 inches

Panel System:

LCD (Liquid Crystal Display) Panel

Display resolution (horizontal × vertical):

KLV-S19A10: 1,280 dots × 768 lines

KLV-S23A10/KLV-S26A10/KLV-S32A10:

1,366 dots × 768 lines

VIDEO IN 1/2/3:

S VIDEO (4-pin mini DIN):

Y: 1.0 Vp-p, 75 ohms unbalanced, sync negative

C: 0.286 Vp-p (Burst signal), 75 ohms

VIDEO: 1 Vp-p, 75 ohms unbalanced, sync negative

AUDIO: 500 mVrms (100% modulation)

Impedance: 47 kilohms

HD/DVD IN 4:

YPbPr (Component Video):

Y: 1.0 Vp-p, 75 ohms unbalanced, sync negative

PB: 0.7 Vp-p, 75 ohms

Pr: 0.7 Vp-p, 75 ohms

Signal format: 480i, 480p, 720p, 1080i

AUDIO: 500 mVrms (100% modulation)

Impedance: 47 kilohms

HDMI IN 5:

HDMI: Video: 480i, 480p, 720p, 1080i

Audio: Two channel linear PCM 32, 44.1 and 48 kHz, 16, 20 and 24 bits

AUDIO: 500 mVrms (100% modulation)

Impedance: 47 kilohms

AUDIO OUT:

500 mVrms (100% modulation)

More than 1 Vrms at the maximum volume setting (Variable)

More than 500 mVrms (Fixed)

PC IN 6:

D-sub 15-pin, analog RGB, 0.7 Vp-p, 75 ohms, positive

See the PC Input Signal Compatibility Chart on page 52

PC AUDIO INPUT:

Stereo mini jack, 0.5 Vrms, 1 kilohm

Headphones:

Stereo mini jack

Impedance: 16 ohms

Speaker:

Full range: 4 × 10 cm (1⁵/₈ × 4 inches) (2)
(KLV-S19A10/KLV-S23A10)
4.2 × 15 cm (1¹¹/₁₆ × 6 inches) (2)
(KLV-S26A10)
5.5 × 15 cm (2¹/₄ × 6 inches) (2)
(KLV-S32A10)

Speaker output:

KLV-S19A10/KLV-S23A10: 5 W + 5 W

KLV-S26A10/KLV-S32A10: 10 W + 10 W

Power requirement:

KLV-S23A10/KLV-S26A10/KLV-S32A10:
120 V-240 V AC, 50/60 Hz

KLV-S19A10: 18 V DC, with AC power adaptor

AC power adaptor for KLV-S19A10:

Model name: AC-FD008

Rating: Input AC 100 V-240 V
50/60 Hz, 128 W

Output DC 18 V 6.11 A

Power consumption:

In use: KLV-S19A10: 95 W

KLV-S23A10: 110 W

KLV-S26A10: 120 W

KLV-S32A10: 155 W

In standby: KLV-S19A10: Less than 1.3 W

KLV-S23A10/KLV-S26A10/

KLV-S32A10: Less than 1 W

Dimensions (W/H/D):

KLV-S19A10: (with stand) 468 × 402 × 218 mm
(18¹/₂ × 15⁷/₈ × 8⁵/₈ inches)
(without stand) 468 × 364 × 84 mm
(18¹/₂ × 14³/₈ × 3³/₈ inches)

KLV-S23A10: (with stand) 566 × 448 × 218 mm
(22³/₈ × 17³/₄ × 8⁵/₈ inches)
(without stand) 566 × 411 × 89 mm
(22³/₈ × 16¹/₄ × 3⁵/₈ inches)

KLV-S26A10: (with stand) 658 × 517 × 309 mm
(26 × 20³/₈ × 12¹/₄ inches)
(without stand) 658 × 474 × 90 mm
(26 × 18³/₄ × 3⁵/₈ inches)

KLV-S32A10: (with stand) 792 × 608 × 309 mm
(31¹/₄ × 24 × 12¹/₄ inches)
(without stand) 792 × 564 × 99 mm
(31¹/₄ × 22¹/₄ × 4 inches)

(Continued)

Other Information

Mass:

- KLV-S19A10: (with stand) 9.9 kg (21 lb. 14 oz.)
(without stand) 6.3 kg (13 lb. 15 oz.)
- KLV-S23A10: (with stand) 12.3 kg (27 lb. 2 oz.)
(without stand) 8.7 kg (19 lb. 3 oz.)
- KLV-S26A10: (with stand) 16.6 kg (36 lb. 10 oz.)
(without stand) 12.8 kg (28 lb. 4 oz.)
- KLV-S32A10: (with stand) 20.5 kg (45 lb. 4 oz.)
(without stand) 16.7 kg (36 lb. 14 oz.)

Supplied accessories:

- Remote control RM-YA001 (1)
- Size AA batteries (2)
- 75-ohm coaxial cable (1)
- AC power cord (1)
- AC power adaptor (1) (KLV-S19A10 only)
- HD15-HD15 cable (1)
- Support belt (1), securing screw (1) and wood screw (1)
- Operating Instructions (1)
- Quick Setup Guide (1)
- Leaflet (Installing the Wall-Mount Bracket,
KLV-S19A10 only) (1)
- Warranty Card (1)

Optional accessories:

- Headphones plug adaptor
- Connecting cables
- Wall-Mount Bracket SU-WL11 (KLV-S19A10)
SU-WL31 (KLV-S23A10/KLV-S26A10/
KLV-S32A10)

 Optional accessories' availability may depend on its stock.

Design and specifications are subject to change without notice.

Index

4:3 Default, screen setting 51
5.1 Channel DVD using with
remote control 37

A

AC IN 16
Audio Out 50
AUDIO OUT jack, described 16
Audio setting 46, 49
Auto Program 30, 53
Auto SAP, MTS setting 49
Auto YC 61

B

backlight, adjusting 48
balance, adjusting 49
bass, adjusting 49
bilingual audio 49
black corrector 48
brightness, adjusting 48

C

cable
channel setting 53
with VCR, connecting 22
cable box
using with remote control 36
Camcorder connection 29
Caption Vision 10, 60
CH buttons 13, 33
Channel fix 53
Channel setting 46, 53
channels
creating labels 54
setting up 30
CineMotion 10, 48
Clear Voice, Sound Mode 49
Clock/Timers setting 47, 58
closed caption modes 60
color, adjusting 48
Cool, Color Temp. 48

D

DC IN 16
DISPLAY button 32
DVD player
using with remote control 36
with A/V connectors,
connecting 25
DVD/VCR (FUNCTION) button
32
DVI-HDTV equipped device
connection 27
Dynamic, Sound Mode 49

E

effect setting 49
ENT button 13, 33
External Inputs, WEGA GATE
43, 45

F

F1 button 33
F2 button 33
Favorite Channels 53
Favorites, WEGA GATE 43, 44
Fixed, audio setting 50
Freeze 39
FREEZE button 32
Full mode, screen setting 38, 51
Full1 mode, screen setting 51
Full2 mode, screen setting 51
FUNCTION buttons 32

G

GUIDE button 33

H

H Center, adjusting 52
HD/DVD IN jack (1080i/720p/
480p/480i), described 16
HDMI IN jack, described 14

HDMI-equipped device
connection 26
Headphones jack, described 14
High-Definition Multimedia
Interface (HDMI) 10
hue, adjusting 48

I

Info Banner 10, 60
Infrared Receiver (IR) 13

J, K

JUMP 39
JUMP button 32

L

Label
channels 54
videos 61
Language, setup setting 61
Light Sensor
described 10, 13
setting 61
Lock, parent setting 55

M

MENU button 32, 36
Mono, MTS setting 49
MTS 49
MTS/SAP button 33
MUTING button 32

N

Natural, Sound Mode 49
Neutral, Color Temp. 48
Normal mode, screen setting 38,
51
Normal mode, setting 51
NR (Noise Reduction) 48

(Continued)

- O**
off, turning off the TV 13
on, turning on the TV 13
Overscan 52
- P, Q**
Parent setting 47, 55
parental control, described 10
Password 55
PC AUDIO IN 16
PC IN 14
Personal Computer connection 28
phase, adjusting 52
PIC OFF LED 13
PICTURE button 33
Picture modes, selecting 48
Picture off, power saving 61
picture, adjusting 48
pitch, adjusting 52
POWER button 13, 33
POWER LED 13
Power Saving 39, 61
POWER SAVING button 32
Pro mode 48
problems, troubleshooting 62–64
- R**
ratings, Parent setting 56–57
ratings, viewing blocked programs 56, 57
Reduced, power saving 61
remote control programming 34–35
RETURN button 32
- S**
S VIDEO jack, described 14, 16
SAT/CABLE (FUNCTION) button 32
satellite receiver, using with remote control 36
Screen setting 46, 51
Select Country 55
setting up channels 30
- Settings
Audio 46, 49
Channel 46, 53
Clock/Timers 47, 58
Parent 47, 55
Screen 46, 51
Setup 47, 60
Video 46, 48
Settings, WEGA GATE 43, 45
Setup setting 47, 60
sharpness, adjusting 48
Show/Hide channels 54
Simulated, Effect 49
Sleep 40, 58
SLEEP button 33
SOUND button 33
Sound modes, selecting 49
speaker turning on/off 50
using external speakers 50
Standard mode 48
Standard, power saving 61
Steady Sound described 10
setting 49
Stereo, MTS setting 49
Support Belt 11
swivel 12
- T, U**
tilt 12
time, Clock/Timers setting 58
Timer 58
TIMER LED 13
TOP MENU button 32
treble, adjusting 49
troubleshooting 62–64
TruSurround, Effect 49
turning on/off the TV 13
TV (FUNCTION) button 32
TV List, WEGA GATE 43, 45
TV/SAT, (●) button 33
TV/VIDEO button 13, 33
- V**
V Center, adjusting 52
Variable, audio setting 50
- VCR
using with remote control 36
with cable, connecting 22
VHF/UHF jack, described 16
Video setting 46, 48
VIDEO/AUDIO (L/R) jacks, described 14, 16
Vivid mode 48
VOL buttons 13, 32
- W, X, Y**
Warm, Color Temp. 48
WEGA GATE 10, 42
WEGA GATE button 13, 32
WIDE button 33
Wide mode 38, 51
Wide Screen, described 10
Wide Zoom mode, screen setting 38, 51
Wide Zoom mode, setting 51
- Z**
Zoom mode, screen setting 38, 51

HDMI **SRS**  **TruSurround** **BBE**®

<http://www.sony.net/>



Printed on 100% recycled paper.



2589826130

Printed in Japan