

SERVICE MANUAL

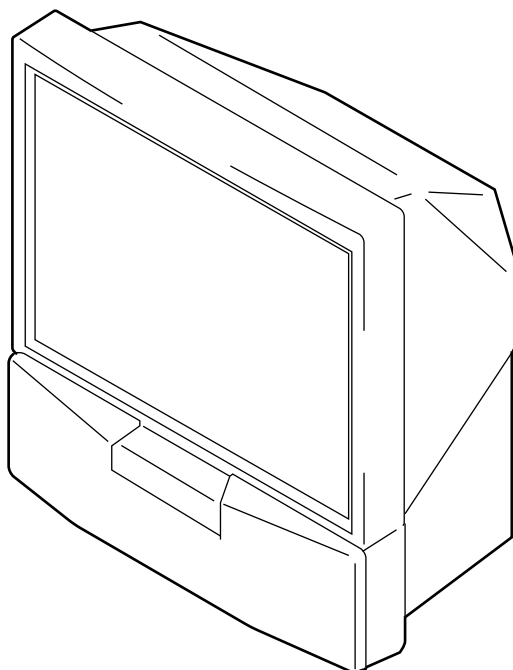

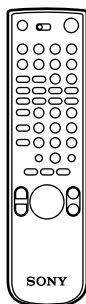





RE-2 CHASSIS





<u>MODEL</u>	<u>COMMANDER</u>	<u>DEST.</u>	<u>CHASSIS NO.</u>	<u>MODEL</u>	<u>COMMANDER</u>	<u>DEST.</u>	<u>CHASSIS NO.</u>
KP-41S5	RM-862	AEP	SCC-N60C-A	KP-41S5K	RM-862	OIRT	SCC-N62D-A
KP-41S5B	RM-862	French	SCC-N63B-A	KP-41S5R	RM-862	Russian	SCC-N62C-A
KP-41S5G	RM-862	Greek	SCC-N60D-A	KP-41S5U	RM-862	UK	SCC-N61B-A



* Please file according to model size.

SPECIFICATIONS

Television system B/G/H,D/K,I,L
Colour system PAL/SECAM
 NTSC 3.58/NTSC4.43(VIDEO IN)
Channel coverage See " Receivable channels and channel displays " on this page.
Projected picture size 41 inches
 Approx. 103cm measured diagonally
Terminals
Rear Center speaker input terminals, 2 terminals
 (L, R), audio outputs-phono jack
 1 21-pin Euro connector
 (CENELEC standard)
 - inputs for audio and video signals
 - inputs for RGB
 - outputs of TV audio and video signals
 2/  2 21-pin EURO connector
 - inputs for audio and video signals
 - inputs for S Video
 - outputs for audio and video signals
 (selectable)
 3/  3 21-pin Euro connector
 - inputs for audio and video signals
 - inputs for S video
 - outputs for audio and video signals
 (selectable, the same output source as the
 2/  2 connector)

Front  3 S video input-4-pin DIN
 3 video inputs-phono jack
 (L,R), Audio inputs-phono jacks
 Headphone jack -stereo minijack
Sound output 2 x 30W (music power)
 2 x 15W (RMS)
Centre SP input 30W (RMS)(using as the centre speaker)
Power consumption 155W
Dimensions(WxHxD) 948x992x 511 mm
 (37³/₈x 39¹/₈ x 20¹/₈ inches)
Mass Approx. 43kg (94 lbs 13 oz)
Supplied accessories See page 6.
Other features Digital comb filter (High resolution)
 FASTEXT

Design and specifications are subject to change without notice.

Receivable Channel and Channel Displays

	Receivable channel	Indication on the screen
B/G/H	E2..12 21..69	C02 C03 C04..C12 C21..C69
CABLE TV (1)	S1..41	S01 S02..S41
CABLE TV (2)	S01..S05 M1..M10 U1..U10	S42..S46 S01..S10 S11..S20
ITALY	A B C D E F G H H1 H2 21..69	C11..C69
D/K	R01..R12 R21..R69	C02..C12 C21..C69
CABLE TV (1)		S01 S02..S41
CABLE TV (2)		S42 S43..S46
CABLE TV	B.. O S21..41	S02.S03..S17. S21..S41
L	F2..F10 F21 F69	C01..C12 C21..C69
I	B21..B68	C21..C68

TABLE OF CONTENTS

Section	Title	Page	Section	Title	Page
1. GENERAL					
	Overview	4			
	Getting Started				
	Step 1 Preparation	5			
	Step 2 Tuning in to TV Stations	5			
	Step 3 Adjusting Colour Registration (Convergence)	6			
	Additional Presetting Functions	7			
	Operating Instructions				
	Watching the TV	9			
	Adjusting and Setting the TV Using the Menu	10			
	Teletext	11			
	Connecting and Operating Optional Equipment	12			
	For Your Information	14			
	Optimum Viewing Area	14			
	Troubleshooting	14			
2. DISASSEMBLY					
	2-1. Rear Board Removal	15			
	2-2. Main Bracket Section Removal	15			
	2-3. Service Position	15			
	2-4. G Board Removal	15			
	2-5. AE Board and UE Board Removal	16			
	2-6. H1 Board, H2 Board and Resistor (High Voltage)Removal	16			
	2-7. BEZNET Section Removal	17			
	2-8. High-Voltage Cable Installation and Removal	17			
	2-9. Mechasel Assy Removal	17			
	2-10. Chassis Block Removal	18			
3. SET-UP ADJUSTMENTS					
	3-1. Screen Voltage Adjustment	19			
	3-2. Focus Lens Adjustment	19			
	3-3. SCREEN (G2) Adjustment	19			
	3-4. Focus VR Adjustment	19			
	3-5. Deflection Yoke Tilt Adjustment	20			
	3-6. 2-Pole Magnet Adjustment	20			
	3-7. 4-Pole Magnet Adjustment	20			
	3-8. Defocus Adjustment (Blue)	20			
4. SAFETY RELATED ADJUSTMENT					
	4-1. HV Hold Down Adjustment	21			
5. CIRCUIT ADJUSTMENTS					
	5-1. Electrical Adjustments	22			
	How to enter into service mode	22			
	5-2. Service list	24			
	5-3. Registration (Convergence) Adjustment Method	27			
	PAL Registration Adjustment	27			
	Center Adjustment	27			
	Size Adjustment	27			
			5-4. Geometry	27	
			Main Deflection Adjustment	27	
			Sub Deflection Adjustment Item	28	
			Vertical Line Adjustment	28	
			Horizontal Line Adjustment	29	
			Size and Linearity Adjustment	29	
			Horizontal Size Adjustment	29	
			Green Vertical Linearity Adjustment	29	
			Green Vertical Size Adjustment	30	
			Green Horizontal Trapezoidal Distortion Adjustment	30	
			Green Horizontal Quaternary Adjustment	30	
			Green Horizontal Asymmetrical Pin Distortion Adjustment	30	
			Green Horizontal Symmetrical Pin Distortion Adjustment	31	
			Green Vertical Wave (3rd-Order) Distortion Adjustment	31	
			Green Vertical 4th Order Distortion Adjustment	31	
			Green Vertical Trapezoidal Distortion Adjustment	31	
			Green Vertical Asymmetrical Pin Distortion (2nd-Order Distortion) Adjustment	32	
			Green Vertical Asymmetrical Pin Distortion Adjustment	32	
			Green and Red Registration Adjustment	32	
			Green and Blue Adjustment	32	
			Registration Data Write	32	
			5-5. AGC Adjustment	32	
			5-6. White Balance Adjustment	33	
			5-7. Text Position Adjustment	33	
			6. DIAGRAMS		
			6-1. Block Diagram (1)	35	
			Block Diagram (2)	39	
			6-2. Frame Schematic Diagram	43	
			6-3. Circuit Boards Location	46	
			6-4. Printed Wiring Boards and Schematic Diagrams	46	
			• G Board	47	
			• AE(1/2) Board	55	
			• AE(2/2) Board	60	
			• H1 Board	65	
			• H2 Board	66	
			• E Board	67	
			• D Board	73	
			• ZR Board	80	
			• ZG Board	81	
			• CR Board	83	
			• CG Board	84	
			• CB Board	86	
			• UE Board	87	
			6-5. Semiconductors	88	
			7. EXPLODED VIEWS		
			7-1. SCREEN AND COVER	90	
			7-2. CABINET AND PANEL BLOCK	91	
			7-3. CHASSIS AND PICTURE TUBE	92	
			8. ELECTRICAL PARTS LIST	93	

(CAUTION)

SHORT CIRCUIT THE ANODE OF THE PICTURE TUBE AND THE ANODE CAP TO THE METAL CHASSIS, CRT SHIELD, OR CARBON PAINTED ON THE CRT, AFTER REMOVING THE ANODE.

SAFETY-RELATED COMPONENT WARNING!!
COMPONENTS IDENTIFIED BY SHADING AND MARK \triangle ON THE SCHEMATIC DIAGRAMS, EXPLODED VIEWS AND IN THE PARTS LIST ARE CRITICAL TO SAFE OPERATION. REPLACE THESE COMPONENTS WITH SONY PARTS WHOSE PART NUMBERS APPEAR AS SHOWN IN THIS MANUAL OR IN SUPPLEMENTS PUBLISHED BY SONY. CIRCUIT ADJUSTMENTS THAT ARE CRITICAL TO SAFE OPERATION ARE IDENTIFIED IN THIS MANUAL. FOLLOW THESE PROCEDURES WHENEVER CRITICAL COMPONENTS ARE REPLACED OR IMPROPER OPERATION IS SUSPECTED.

SECTION 1 GENERAL

The operating instructions mentioned here partial abstracts from the Operating Instructions Manual. The page numbers of the Operating Instruction Manual remain as in the manual

Overview

This section briefly describes the buttons and controls on the TV set and on the Remote Commander. For more information, refer to the pages given next to each description.

TV set-front

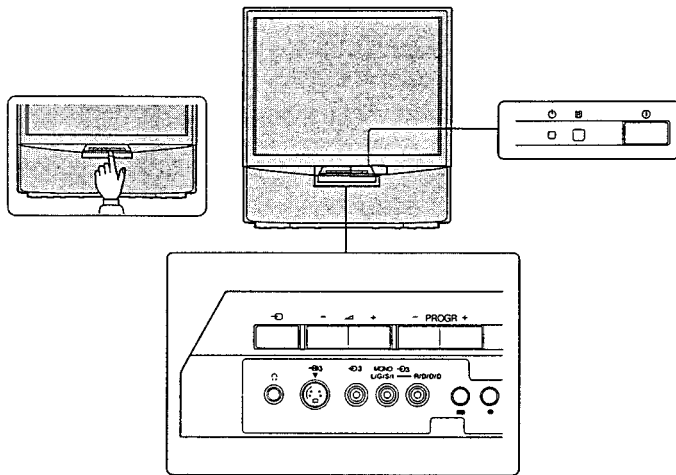

Symbol	Name	Refer to page
⏻	Main power switch	14
⏻	Standby indicator	14
PROGR +/-	Programme buttons	14
↔ +/-	Volume buttons	14
⏻	Input select buttons	15
🎧	Headphones jack	20
Ⓜ 3, Ⓜ 3, Ⓜ 3	Input jacks (S video/video/audio)	21
Ⓜ	Auto Preset button	8
Ⓜ	Auto Convergence button	9

Remote commander

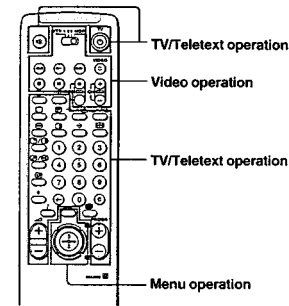

TV/Teletext operation

Symbol	Name	Refer to page
⏻	Mute on/off button	15
⏻	TV Standby button	14
Ⓜ	TV power on/TV mode selector button	14
Ⓜ	Teletext button	15
Ⓜ/Ⓜ	Input mode selector/ Teletext: Freezing the subpage	15
Ⓜ/Ⓜ	Teletext: Reveal button	18
1, 2, 3, 4, 5, 6, 7, 8, 9 and 0	Number buttons	14
Ⓜ	Double-digit entering button	14
C	Direct channel entering button	13
↔ +/-	Volume control button	14
PROGR +/-	Programme selectors	14
Ⓜ/Ⓜ	Teletext: Page up/page down buttons	18
●	Picture adjustment button	16
Ⓜ	Sound adjustment button	16
Ⓜ	On-screen display button	15
Ⓜ	Time display button	15
Ⓜ	Button to change Screen Format	15
Ⓜ	Teletext: Favourite pages button	19

Menu operation

Symbol	Name	Refer to page
MENU	Menu on/off button	See below.
Ⓜ	Joystick for Menu selection	See below.
Ⓜ	Press to confirm selection (OK function)	See below.

Video operation

Symbol	Name	Refer to page
VTR1/2/3, MDP	Video equipment selector	23
⏻ ⏩ ⏪ ⏩	Video equipment operation buttons	23
CH +/-		

No function on this set

Symbol : Ⓜ/Ⓜ, Ⓜ/Ⓜ, Ⓜ, +, Ⓜ, Ⓜ, Ⓜ/Ⓜ (for TV operation)

For the Menu System

Use the MENU button and the joystick as follows.

1 Press MENU button to switch menu on or off.



2 Use the joystick as follows:

GREEN: scroll up

RED: decrease/back to last item or to last menu

When menu is not displayed: Push to red to display the last menu screen

BLUE: scroll down

YELLOW: increase/forward to next item



Joystick: Press at its neutral position to confirm selection or store

The operable functions of the joystick are displayed on the screen.

Getting Started

Step 1 Preparation

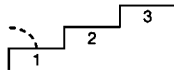

1 Check the Supplied Accessories

When you've taken everything out of the carton, check that you have these items:

- RM-862 Remote Commander
- Two IEC designation R6 batteries
- Wrench (1)
- Bracket (2)

2 Insert the Batteries into the Remote Commander

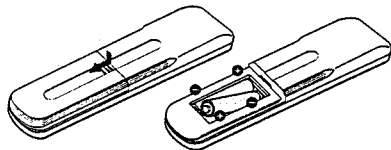

Remove the cover.

Check the correct polarities.

Note: Always remember to dispose of used batteries in an environmentally friendly way.

3 Connect the Aerial

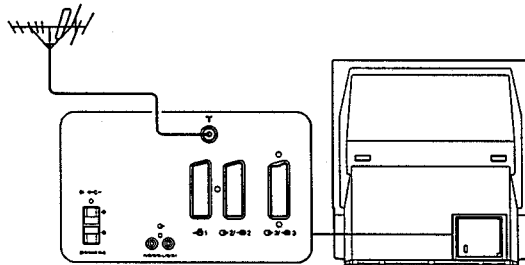

Fit an IEC aerial connector attached to 75-ohm coaxial cable (not supplied) to the 'I' socket at the rear of the TV.

Step 2 Tuning in to TV Stations

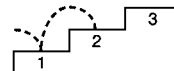

1 Choose a Language

- 1 Depress (main power switch) on the TV. The TV will switch on. If the standby indicator on the TV is lit, press or a number button on the Remote Commander.
- 2 Press MENU.
- 3 Push the joystick to blue or green to select the symbol , then push to yellow. The PRESET menu appears.
- 4 Push the joystick to blue or green to select "Language", then push to yellow.
- 5 Push the joystick to blue or green to select the language you want, then push to yellow.
- 6 Press MENU to restore the normal TV picture.

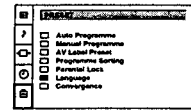
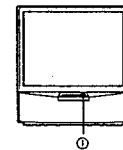
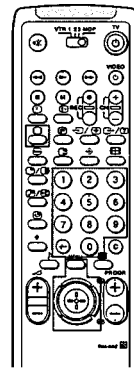

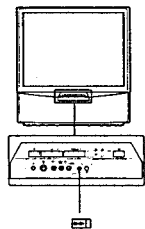
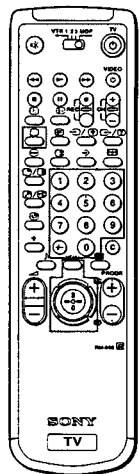

Note
You can sort the programme positions to have them appear on screen in the order you like. For details, see "Sorting Programme Positions" on page 11.

2 Preset Channels Automatically

With this function, the TV automatically searches and stores up to 100 channels onto programme positions. If you prefer "Presetting Channels Manually", please refer to page 10 in Additional Presetting Functions.

- 1 Depress (main power switch) on the TV. The TV will switch on. If the standby indicator on the TV is lit, press or a number button on the Remote Commander.

- 2 Press and hold the on the TV until the automatic menu is displayed and the search starts. After all available channels are stored, the normal TV picture is shown.

Presetting channels automatically by using the Remote Commander

- 1 Press MENU.
- 2 Push the joystick to blue or green to select the symbol , then push to yellow. The PRESET menu appears.
- 3 Push the joystick to blue or green to select "Auto Programme".
- 4 Push to yellow and hold until the AUTO PROGRAMME menu is displayed and the search starts. After all available channels have been preset, the normal TV picture is shown.

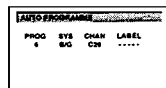
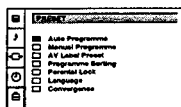

Step 3 Adjusting Colour Registration (CONVERGENCE)

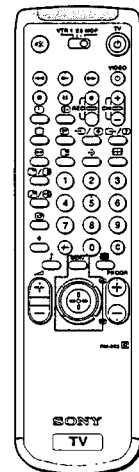
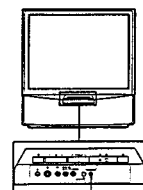
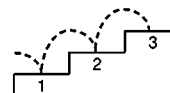

Converge the Red, Green, and Blue Lines

- 1 Press button on the TV.
- 2 The Auto Convergence function works for about 30 seconds.

When the auto convergence function does not work correctly

Adjust the colour registration by selecting the "Convergence" of the PRESET menu.

- 1 Press MENU.
- 2 Push the joystick to blue or green to select the symbol , then push to yellow. The PRESET menu appears.
- 3 Push the joystick to blue or green to select "Convergence", then push to yellow. The CONVERGENCE menu appears.
- 4 Push the joystick to blue or green to select "the line" (vertical and horizontal lines in red and blue) you want to adjust. Press the joystick to confirm.
 - + : red vertical line (left/right adjustment)
 - + : red horizontal line (up/down adjustment)
 - + : blue vertical line (left/right adjustment)
 - + : blue horizontal line (up/down adjustment)
 The line to adjust is selected.
- 5 Push the joystick to blue or green to converge the selected line with the green line in the centre. Press the joystick to confirm.
- 6 Repeat steps 4 and 5 to adjust the other lines, until all the lines have overlapped to form a white cross.
- 7 Press MENU to restore the normal TV picture.

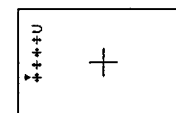
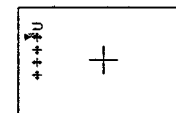
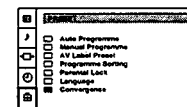
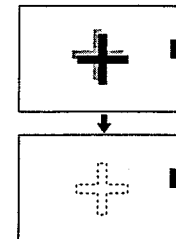

Note
The Auto Convergence function does not work:

- when no signal is input.
- when the input signal is weak.
- when the screen is exposed to spotlights or direct sunlight.
- when you watch the teletext broadcast.



Additional Presetting Functions

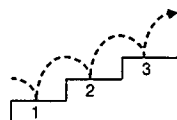

MANUAL PROGRAMME PRESET

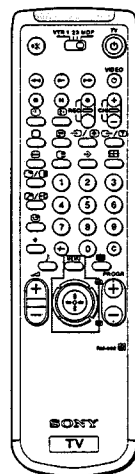

Presetting Channels Manually

Using this function, you can preset channels one by one to different programme positions. This is also convenient to allocate programme numbers to video input sources.

- 1 Press MENU.
- 2 Push the joystick to blue or green to select the symbol  on the menu screen. Push to yellow to confirm the selection.
- 3 Push to blue or green to select "Manual Programme". Push to yellow to confirm the selection.
- 4 Push to blue or green to select the programme position (PROG) to which you want to preset a channel. Push to yellow to confirm.
- 5 Push to blue or green to select the TV broadcast system (SYS) (I for U.K., B/G for western European countries, D/K for eastern European countries, L for France) or a video input source (AV1, AV2, AV3, YC2, YC3, RGB). Push to yellow to confirm.
- 6 Push to blue or green to select "C" (for terrestrial channels) or "S" (for cable channels). You can also select "C" or "S" by pressing C on the Remote Commander. For selecting "C", press C once, and for "S", press it twice. Push to yellow to confirm.

There are two options to preset channels manually:

- a) You know the channel number.
Please use method "Direct Input".
or
- b) You don't know the channel number.
Please use method "Search".

7 a) Direct Input

Select the first number digit of "CHAN" (channel), then the second number digit of "CHAN" with the number buttons on the Remote Commander (e.g. for channel 2, first press 0, then 2).

7 b) Search

Push the joystick to blue or green to search for the next available channel.

- 8 If you want to store the channel, go to step 9. If not, select a new channel using the number button on the Remote Commander or push the joystick to blue or green to resume the search.
- 9 Press the joystick to confirm.
- 10 Repeat steps 4 to 9 to preset other channels.
- 11 Press MENU to restore the normal TV picture.

7	Auto Programme	Manual Programme	AV Label Preset	Programme Sorting	Parental Lock	Language	Convergence
---	----------------	------------------	-----------------	-------------------	---------------	----------	-------------

PROG	SYS	CHAN	LABEL	AFT
0	B/G	C29	ON
1	B/G	C21	ON
2	B/G	C32	ON
3	B/G	C28	ON
4	B/G	C37	ON
5	B/G	C49	ON
6	B/G	C41	ON
7	B/G	C44	ON
8	B/G	C48	ON
9	B/G	C42	ON

MANUAL PROGRAMME PRESET

Manual Fine-Tuning

Normally, the automatic fine-tuning (AFT) function is already operating.

If the picture is distorted, however, you can manually fine-tune the TV to obtain a better picture reception.

- 1 Press MENU.
- 2 Push the joystick to blue or green to select the symbol  on the menu screen. Push to yellow to confirm.
- 3 Push to blue or green to select "Manual Programme". Push to yellow to confirm.
- 4 Push to blue or green to select the programme number which corresponds to the channel you want to manually fine-tune.
- 5 Push to yellow repeatedly until the AFT position changes colour.
- 6 Push to blue or green to fine-tune the channel frequency (-15 to +15).
- 7 Press the joystick to confirm.
- 8 Repeat steps 4 to 7 to fine-tune other channels.
- 9 Press MENU to restore the normal TV picture.

PROG	SYS	CHAN	LABEL	AFT
0	B/G	C29	ON
1	B/G	C21	ON
2	B/G	C32	ON
3	B/G	C28	ON
4	B/G	C37	ON
5	B/G	C49	ON
6	B/G	C41	ON
7	B/G	C44	ON
8	B/G	C48	ON
9	B/G	C42	ON

PROGRAMME SORTING

Sorting Programme Positions

This function enables you to sort the programme positions to a preferable order.

- 1 Press MENU.
- 2 Push the joystick to blue or green to select the symbol  on the menu screen. Push to yellow to confirm.
- 3 Push to blue or green to select "Programme Sorting". Push to yellow to confirm.
- 4 Push to blue or green to select the programme position of the channel you want to change. Press joystick to confirm.
- 5 Push to blue or green to select the programme position of the channel you want to exchange. Press joystick to confirm.
- 6 Repeat steps 4 and 5 to sort other programme positions.
- 7 Press MENU to restore the normal TV picture.

7	Auto Programme	Manual Programme	AV Label Preset	Programme Sorting	Parental Lock	Language	Convergence
---	----------------	------------------	-----------------	-------------------	---------------	----------	-------------

PROG	SYS	CHAN	LABEL
0	B/G	C26	BBC-N
1	B/G	C29	VHS-2
2	B/G	C36
3	B/G	C28
4	B/G	C49	BBC-2
5	B/G	C44	VHS-1
6	B/G	C48
7	B/G	C41
8	B/G	C37
9	B/G	C42

MANUAL PROGRAMME PRESET

Skipping Programme Positions

This function enables you to skip unused programme positions when selecting them with the PROGR +/- buttons. However, by using the number buttons you can still select the skipped programme position.

- 1 Press MENU.
- 2 Push the joystick to blue or green to select the symbol  on the menu screen. Push to yellow to confirm.
- 3 Push to blue or green to select "Manual Programme". Push to yellow to confirm.
- 4 Push to blue or green to select the programme position you want to skip. Push to yellow to confirm.
- 5 Push to blue or green to select "--" in the position SYS (system). Press the joystick to confirm.
- 6 Repeat steps 4 and 5 to skip other programme positions.
- 7 Press MENU to restore the normal TV picture.

PROG	SYS	CHAN	LABEL	AFT
0	SG	C29	OH
1	SG	C21	OH
2	SG	C28	OH
3	SG	C26	OH
4	SG	C27	OH
5	SG	C40	OH
6	SG	C41	OH
7	SG	C44	OH
8	SG	C46	OH
9	SG	C42	OH

MANUAL PROGRAMME PRESET

Captioning a Station Name

Channels are automatically labelled during presetting. You can, however, individually name a channel or a video source using up to five characters.

- 1 Press MENU.
- 2 Push the joystick to blue or green to select the symbol  on the menu screen. Push to yellow to confirm.
- 3 Push to blue or green to select "Manual Programme". Push to yellow to confirm.
- 4 Push to blue or green to select the programme position with the channel you want to label. Push to yellow repeatedly until the first element of the position LABEL is highlighted.
- 5 Push to blue or green to select a letter or a number (select "--" for a blank). Push to yellow to confirm. Select the other four characters in the same way.
- 6 After selecting all characters, press the joystick to confirm.
- 7 Repeat steps 4 to 6 to label other channels or video sources.
- 8 Press MENU to restore the normal TV picture.

PROG	SYS	CHAN	LABEL	AFT
0	SG	C29	OH
1	SG	C21	OH
2	SG	C28	OH
3	SG	C26	OH
4	SG	C27	OH
5	SG	C40	OH
6	SG	C41	OH
7	SG	C44	OH
8	SG	C46	OH
9	SG	C42	OH



PARENTAL LOCK

If you try to select a programme that has been blocked
The message "LOCKED" appears on the blank TV screen.

To unblock
Select the channel to unblock in the "PARENTAL LOCK" menu. Press the joystick. The symbol  disappears.

Using Parental Lock

This function enables you to prevent children from watching undesirable broadcasts.

- 1 Press MENU.
- 2 Push the joystick to blue or green to select the symbol  on the menu screen. Push to yellow to confirm.
- 3 Push to green or blue to select "Parental Lock". Push to yellow to confirm.
- 4 Push to green or blue to select the channel you want to block. Press the joystick to confirm. The symbol  appears before the programme position to indicate that this channel is now blocked.
- 5 Repeat step 4 to block other channels.
- 6 Press MENU to restore the normal TV picture.

PROG	SYS	CHAN	LABEL	AFT
0	SG	C29	OH
1	SG	C21	OH
2	SG	C28	OH
3	SG	C26	OH
4	SG	C27	OH
5	SG	C40	OH
6	SG	C41	OH
7	SG	C44	OH
8	SG	C46	OH
9	SG	C42	OH

PROG	SYS	CHAN	LABEL	AFT
0	SG	C29	OH
1	SG	C21	OH
2	SG	C28	OH
3	SG	C26	OH
4	SG	C27	OH
5	SG	C40	OH
6	SG	C41	OH
7	SG	C44	OH
8	SG	C46	OH
9	SG	C42	OH

PROG	SYS	CHAN	LABEL	AFT
0	SG	C29	OH
1	SG	C21	OH
2	SG	C28	OH
3	SG	C26	OH

Tuning in a Channel Temporarily

You can tune in to a channel temporarily, even though it has not been preset.

- 1 Press C on the Remote Commander. For cable channels, press C twice. The indication "C" ("S" for cable channels) appears on the screen.
- 2 Enter the double-digit channel number using the number buttons (e.g. for channel 4, first press 0, then 4). The channel appears. Note that the channel will not be stored.

PROG	SYS	CHAN	LABEL	AFT
0	SG	C29	OH
1	SG	C21	OH
2	SG	C28	OH
3	SG	C26	OH

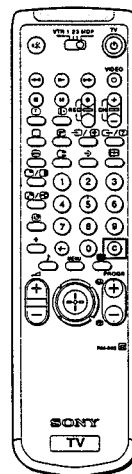

Note
After you tune in a channel temporarily, you cannot enter the manual preset mode.
To store the channel, refer to the "Presetting Channels Manually" on page 10.

Operating Instructions

Watching the TV

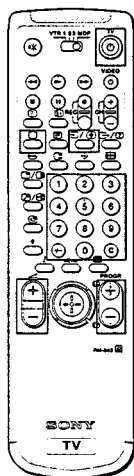

If no picture appears when you depress **⏻** on the TV and if the standby indicator on the TV is lit, the TV is in standby mode. Press **⏻**, **PROGR +/-** or one of the number buttons to switch it on.

This section explains the basic functions you use while watching the TV. Most operations are done using the Remote Commander.

Switching the TV on and off

Switching on

Depress **⏻** on the TV.

Switching off temporarily

Press **⏻** on the Remote Commander.

The TV enters standby mode and the standby indicator on the front of the TV lights up in red.

To switch on again

Press **⏻**, **PROGR +/-**, or one of the number buttons on the Remote Commander.

Switching off completely

Depress **⏻** on the TV and the indicator on the front of the TV lights up in amber.

To save energy, we recommend you switch off your TV completely when the TV is not in use.

Selecting TV Programmes

Press **PROGR +/-** or press the number buttons.

To select a double-digit number

Press **->**, then the numbers.

For example, if you want to choose 23, press **->**, 2 and 3.

Adjusting the Volume

Press **⏮ +/-**.

Operating the TV Using the Buttons on the TV

To select the programme number, press the **PROGR +/-** buttons.

To adjust the volume, press the **⏮ +/-** buttons.

To select the video input picture, press the **⏻** button.

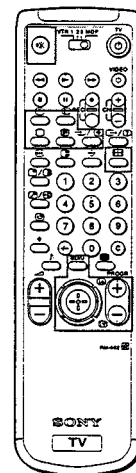
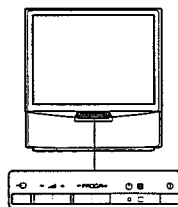

For details of the teletext operation, refer to page 18.

For details of the video input picture, refer to page 21.

Watching Teletext or Video Input

Watching teletext

- 1 Press **⏻** to view the teletext.
- 2 For teletext operation, enter a 3-digit page number with the number buttons to select a page.
For fastext operation, push the joystick to the colour mark which corresponds to the colour-coded menu.
For both operations, press **⏻** (PAGE +) for the next page or **⏻** (PAGE -) for the preceding page.
- 3 To go back to the normal TV picture, press **⏻**.

Watching a video input picture

- 1 Press **⏻** repeatedly until the desired video input appears.
- 2 To go back to the normal TV picture, press **⏻**.

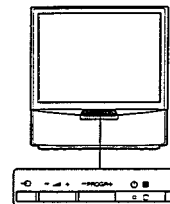

GB

More Convenient Functions

Displaying the on screen indications

Press **⏻** to display the indications.

Press again to make the indications disappear.

Muting the sound

Press **⏻**.

To resume normal sound, press **⏻** again.

Displaying the time

Press **⏻**. This function is available only when teletext is broadcast.

To make the time display disappear, press **⏻** again.

Viewing the programmes in 16:9 mode

Press **⏻**.

Press again to return to 4:3 mode.

Adjusting and Setting the TV Using the Menu

PICTURE CONTROL

SOUND CONTROL

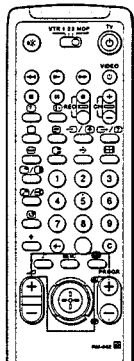

Adjusting the Picture and Sound

Although the picture and sound are adjusted at the factory, you can adjust them to suit your own taste. You can also select dual sound (bilingual) programmes when available or adjust the sound for listening with the headphones.

- Press **⏏** (for picture) or **🔊** (for sound) on the Remote Commander, or
Press **MENU** and select the symbol **📺** for Picture Control or **🔊** for Sound Control. Push to yellow to confirm. The PICTURE CONTROL or SOUND CONTROL menu appears.
- Push the joystick to blue or green to select the desired item. Push to yellow to confirm. The selected item changes its colour.
- Push to red or yellow to adjust the selected item. Press the joystick to confirm. For the effect of each control, see the table below.
- Repeat steps 2 and 3 to adjust other items.
- Press **MENU** to restore the normal TV picture.

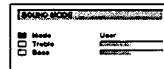
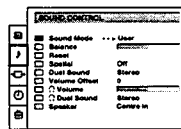
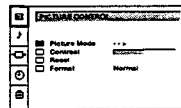

Effect of each control

PICTURE CONTROL	Effect
Picture Mode	User ↔ Game ↔ Movie ↔ Sports ↔ Live
Brightness	Darker ————— Brighter
Colour	Less ————— More
Sharpness	Softer ————— Sharper
Hue	Greenish ————— Reddish
Contrast	Less ————— More
Reset	Resets picture to the factory preset levels.
Format	4:3: normal 16:9: wide screen effect

When "User" is selected in "Picture Mode"

You can preset Brightness, Colour, Sharpness and Hue (NTSC signals only) as follows:

- Push the joystick to blue or green to select the desired item. Push to yellow to confirm.
- Push to red or yellow to adjust. Press the joystick to confirm.
- Push to red to return to the PICTURE CONTROL menu.

SOUND CONTROL	Effect
Sound Mode	Choice between different sound effects User ↔ Rock ↔ Jazz ↔ Pgp
Treble	Less ————— More
Bass	Less ————— More
Balance	More left ————— More right
Reset	Resets sound to the factory preset levels.
Spatial	Off: normal! On: acoustic sound effect
Dual Sound	A: left channel B: right channel Stereo → Mono The selected mode of the A-CD-B indicator on the TV lights up.
Volume Offset	Presets the volume level for individual programmes. -12 ————— 12
Volume	Less ————— More
Dual Sound	A: channel 1 → B: channel 2 Stereo → Mono
Speaker	Main: sound from TV set Centre in: sound from external amplifier

When "User" is selected in "Sound Mode"

You can preset Treble and Bass as follows:

- Push the joystick to blue or green to select the desired item. Push to yellow to confirm.
- Push to red or yellow to adjust. Press the joystick to confirm.
- Push to red to return to the PICTURE CONTROL menu.

TIMER

To switch off the timer
Select "OFF" in step 3.

To check the remaining time
Press **📺**.

To go back to the normal TV picture
Press **MENU**.

Using the Sleep Timer

You can select a time period after which the TV automatically switches into standby mode.

- Press **MENU**.
- Push the joystick to blue or green to select the symbol **🕒** on the menu screen. Push to yellow to confirm.
- Push to yellow. Push to red or yellow to set time delay and press the joystick to confirm.
OFF ↔ 0:30 ↔ 1:00 ↔ 1:30 3:30 ↔ 4:00
- Press the joystick to confirm.
One minute before the TV switches into standby mode, a message is displayed on the screen.



Teletext

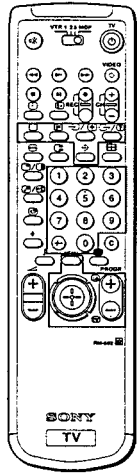

Note
Teletext errors may occur if the broadcasting signals are weak.

TV stations broadcast an information service called Teletext via the TV channels. Teletext service allows you to receive various information pages such as weather reports or news at any time you want.

Direct Access Functions

Switching Teletext on and off

- 1 Select the TV channel which carries the teletext broadcast you want to watch.
- 2 Press **⏻** to switch on teletext.
A teletext page will be displayed (usually the index page).
If there is no teletext broadcast, the indication P100 is displayed on a black screen.
- 3 Input three digits for the page number using the number buttons.
If you have made a mistake, type in any three digits. Then re-enter the correct page number.
- 4 Press **⏻** to return to the normal TV picture.

Accessing next or preceding page

Press **⏪** (PAGE+) or **⏩** (PAGE-).
The next or preceding page appears.

Superimposing the teletext display on the TV programme

- Press **⏻** once to get Teletext only.
- Press **⏻** twice for Mix mode.
The normal TV screen and the Teletext screen are overlapped.

Preventing a teletext page from being updated

- Press **⏻**.
The symbol "⏻" is displayed on the information line.
Press again to cancel.
- Press **⏻** to resume normal teletext reception.

Revealing hidden information (e.g. for a quiz)

Sometimes pages contain concealed information, such as answers to a quiz. The reveal option lets you disclose the information.

Press **⏻**. Press again to cancel.
Press **⏻** to resume normal teletext reception.

Favourite page system

You can store up to four of your favourite teletext pages per Teletext service. In this way you have quick access to the pages you frequently use.

Storing pages

- 1 Use the number buttons to select the page you would like to store.
- 2 Press **⏻** twice.
The colour prompts at the bottom of the screen flash.
- 3 Push the joystick to the desired colour to store the selected page.
The page is now stored on this colour.
Repeat steps 1 to 3 for the other 3 pages.

Displaying the favourite pages

- 1 Press **⏻**.
- 2 Push the joystick to the colour on which the desired page is stored.
Make sure you press **⏻**, otherwise the normal Fastext facility operates.

Using Fastext

With Fastext you can access pages with one key stroke.
When a Fastext page is broadcast, a colour-coded menu will appear at the bottom of the screen. The colours of this menu correspond to the red, green, yellow and blue positions on the Remote Commander.
Push the joystick to the colour mark which corresponds to the colour-coded menu. The page will be displayed after a few seconds.

Note
Fastext operation is possible, only when the TV station broadcasts Fastext signals.

GB

Connecting and Operating Optional Equipment

Connecting Optional Equipment

You can connect optional audio-video equipment to this TV such as a VCR, video disc player, and stereo system.

To connect a VCR using the T terminal
Connect the aerial output of the VCR to the aerial terminal T of the TV.
We recommend that you tune in the video signal to programme number "0".
For details, see "Presetting Channels Manually" on page 10.

If the picture or the sound is distorted
Move the VCR away from the TV.

About S video Inputs (Y/C Input)
Video signals can be separated into Y (luminance or brightness) and C (chrominance) signals.
Separating the Y and C signals prevents them from interfering with one another, therefore it improves picture quality (especially luminance).
This TV is equipped with 3 S video input jacks, through which these separated signals can be input directly.

When connecting a monaural VCR
Connect only the white S jack to both the TV and VCR.

Note
When you connect the equipment to the -E3/3/-E3 connectors on the front panel and G-3/-E3 connector on the rear panel, turn off the power of the equipment not in use.

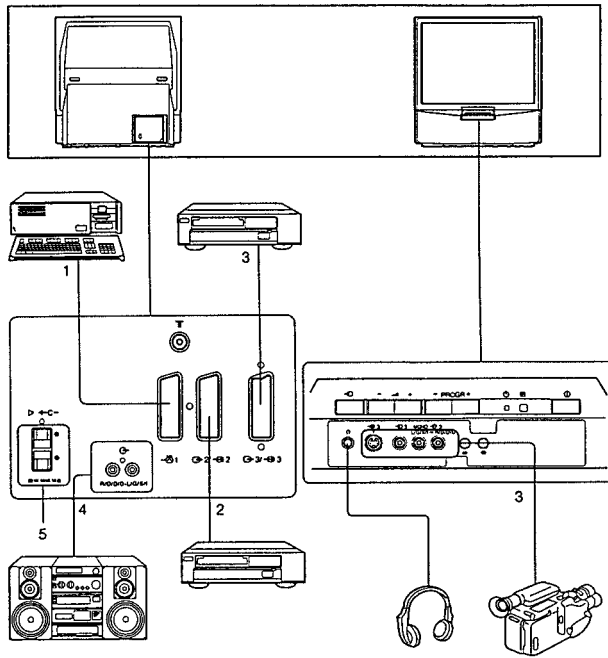

Acceptable input signal	Available output signal
1 Normal audio/video and RGB signal	Video/audio from TV tuner
2 Normal audio/video and S video signal	Video/audio from selected source
3 Normal audio/video and S video signal Normal audio/video and S video signal	No outputs Video/audio from selected source (the same output source as the G-2/-E2 connector)
4 No inputs	Audio signal
5 Centre speaker input Set "Speaker" on the SOUND CONTROL menu to "Centre in".	No outputs

Selecting input with PROGR +/- or number buttons
You can preset video input sources to the programme positions so that you can select them with PROGR +/- or number buttons. For details, see "Presetting Channels Manually" on page 10.

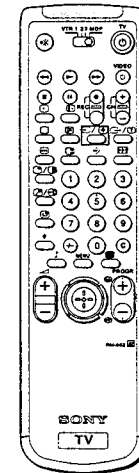

Selecting Input and Output

This section explains how to view the video input picture (of the video source connected to your TV), and how to select the output signal using direct access buttons or the menu system.

Selecting input

Press repeatedly to select the input source. The symbol of the selected input source will appear.

To go back to the normal TV picture

Press .

Input modes

Symbol	Input signal
1	Audio/video input through the -E1 1 connector
	Audio/RGB input through the -E1 1 connector
2	Audio/video input through the G-2/-E2 2 connector
2	Audio/S video input through the G-2/-E2 2 connector
3	Audio/video input through 3 and 3 connectors on the front or G-3/-E3 3 connector on the rear
3	Audio/S video input through the -E3 3 connector (4-pin connector) on the front or G-3/-E3 3 connector on the rear

You can also select the input mode using the button on the TV.

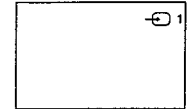

GB

AV LABEL PRESET

Using AV Label Preset

Using this function you can preset the desired input source (e.g. 1, RGB signal) to the respective AV input (AV 1-5). In this way, a connected VCR will automatically switch to the RGB signal.

- 1 Press MENU.
- 2 Push the joystick to blue or green to select the symbol  on the menu screen. Push to yellow to confirm.
- 3 Push to blue or green to select "AV Label Preset". Push to yellow.
- 4 Push to blue or green to select the desired input source. Push to yellow to confirm.
- 5 Push to blue or green to select a letter or number. Push to yellow (select "-" for a blank). Select the other four characters in the same way.
- 6 After selecting all the characters, press the joystick to confirm.
- 7 Repeat steps 4 to 6 to label other input sources.
- 8 Press the MENU button to return to the normal TV picture.

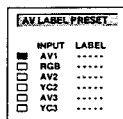
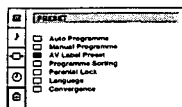

VIDEO CONNECTION

Checking and Selecting the Input and Output Sources Using the Menu

You can display the menu to see which input sources are selected for the TV screen, as well as which output source is selected. You can also select them on the menu display.

- 1 Press MENU.
- 2 Push the joystick to blue or green to select the symbol  on the menu screen. Push to yellow to confirm. The VIDEO CONNECTION menu appears. You can see which source is selected for the TV and for the output. If you want to select the input and output on this menu, go on to the next step.
- 3 Push to blue or green to select "TV Screen" (input source for TV-screen), or "Output" (output source for G-2/-E3 2 and G-3/-E3 3). Push to yellow to confirm.
- 4 Push to red or yellow to select the desired source. Press joystick to store.
- 5 Repeat steps 3 to 4 to select the source for other inputs or outputs.
- 6 Press MENU to return to the normal TV picture.

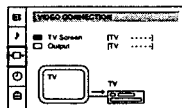

Note
If you select "AUTO" for output, the output source automatically becomes the same as the desired input source.

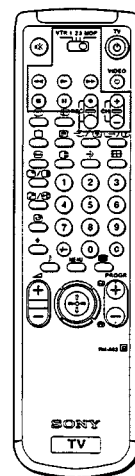

When recording
When you use the  (record) button, make sure to press this button and the one to the right of it simultaneously.

Remote Control of Other Sony Equipment

You can use the TV Remote Commander to control most of Sony remote-controlled video equipment: beta, 8 mm and VHS VCRs and video disc players.

Tuning the Remote Commander to the equipment

- 1 Set the VTR 1/2/3 MDP selector according to the equipment you want to control:
 - VTR1: Beta VCR
 - VTR2: 8 mm VCR
 - VTR3: VHS VCR
 - MDP: Video disc player
- 2 Use the buttons indicated in the illustration to operate the additional equipment. If your video equipment is furnished with a COMMAND MODE selector, set this selector to the same position as the VTR 1/2/3 MDP selector on the TV Remote Commander. If the equipment does not have a certain function, the corresponding button on the Remote Commander will not operate.

GB

For Your Information

Optimum Viewing Area

For the best picture quality, try to position the projection TV so that you can view the screen from within the areas shown below.

Horizontal viewing area

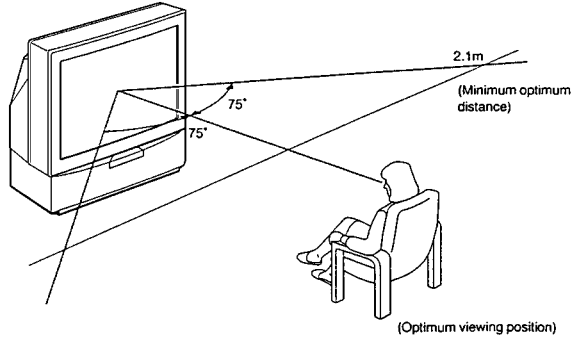

Vertical viewing area

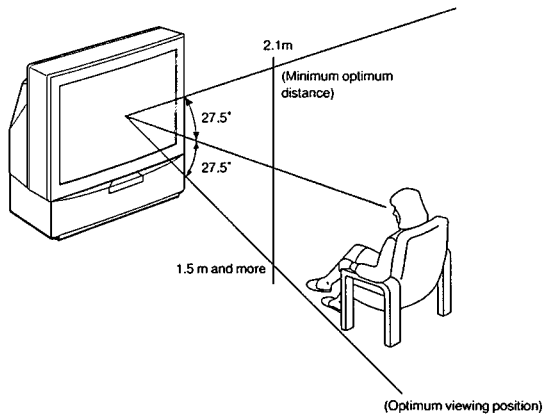

Troubleshooting

Here are some simple solutions to some problems which may affect the picture and sound.

Problem	Solution
No picture (screen is dark), no sound	<ul style="list-style-type: none"> • Plug in the TV in. • Press ⏻ on the TV (if ⏻ indicator is on, press □ or a programme number on the Remote Commander). • Check the aerial connection. • Check if the selected video source is on. • Turn the TV off for 3 or 4 seconds then turn it on again using ⏻.
Poor or no picture (screen is dark), but good sound	<ul style="list-style-type: none"> • Press ■ to enter the PICTURE CONTROL menu and adjust the brightness, contrast and colour.
The menu and picture disappear (if contrast and brightness are minimum)	<ul style="list-style-type: none"> • Press MENU on the Remote Commander or on the front panel of the TV set.
Good picture but no sound	<ul style="list-style-type: none"> • Press ⏻ +. • Check if "Center in" is selected on the SOUND CONTROL menu. • If ⊗ is displayed on the screen, press ⊗.
No colour for colour programmes	<ul style="list-style-type: none"> • Press ■ to enter the PICTURE CONTROL menu, select RESET, then press the joystick to confirm.
Remote Commander does not function	<ul style="list-style-type: none"> • The batteries are weak.

If you continue to have problems, have your TV serviced by qualified personnel. Never open the casing yourself.

SECTION 2 DISASSEMBLY

2-1. REAR BOARD REMOVAL

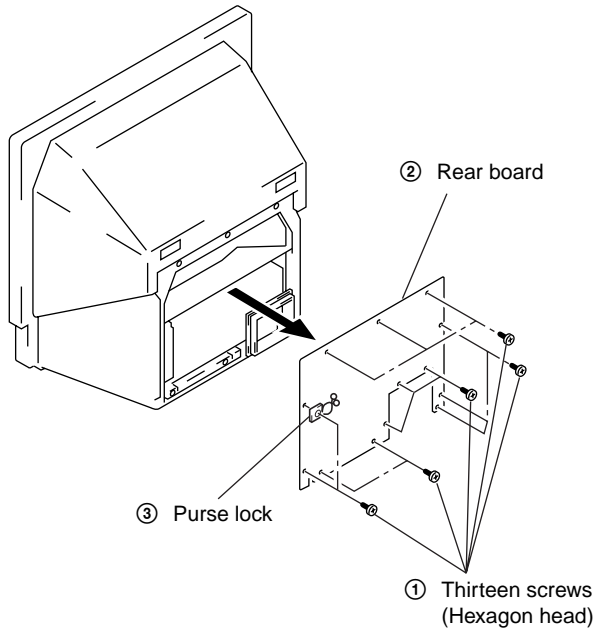

2-3. SERVICE POSITION

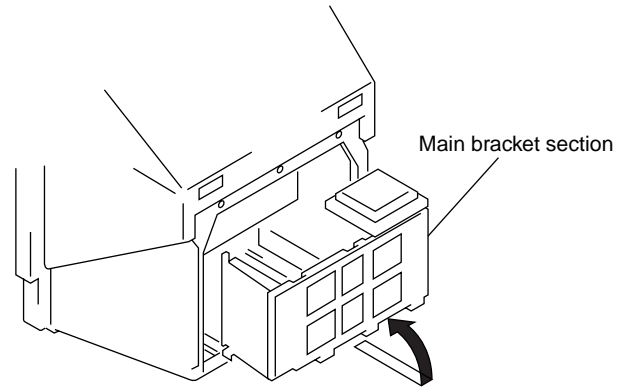

2-2. MAIN BRACKET SECTION REMOVAL

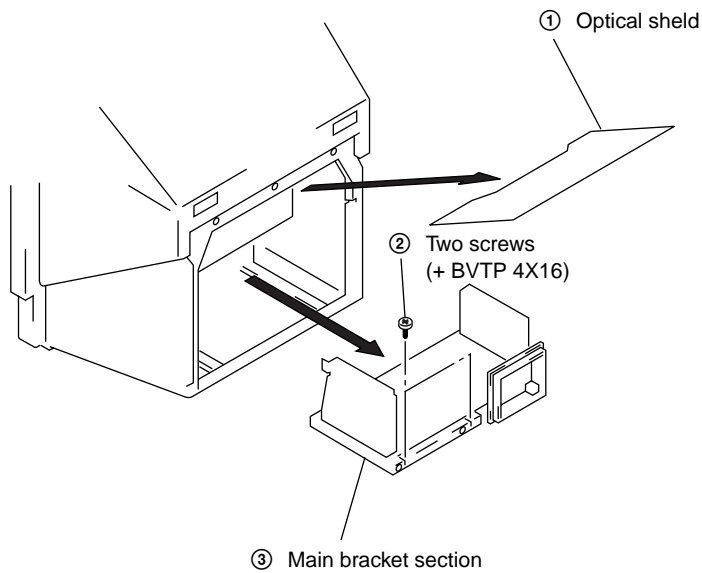

2-4. G BOARD REMOVAL

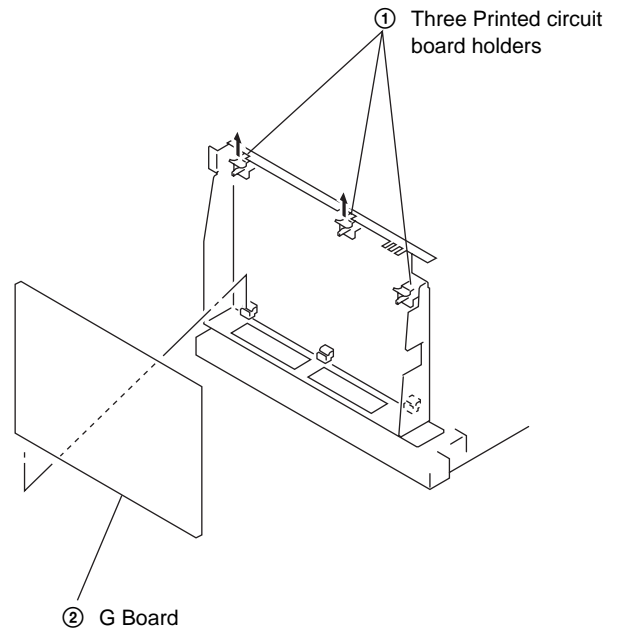

2-5. AE BOARD AND UE BOARD REMOVAL

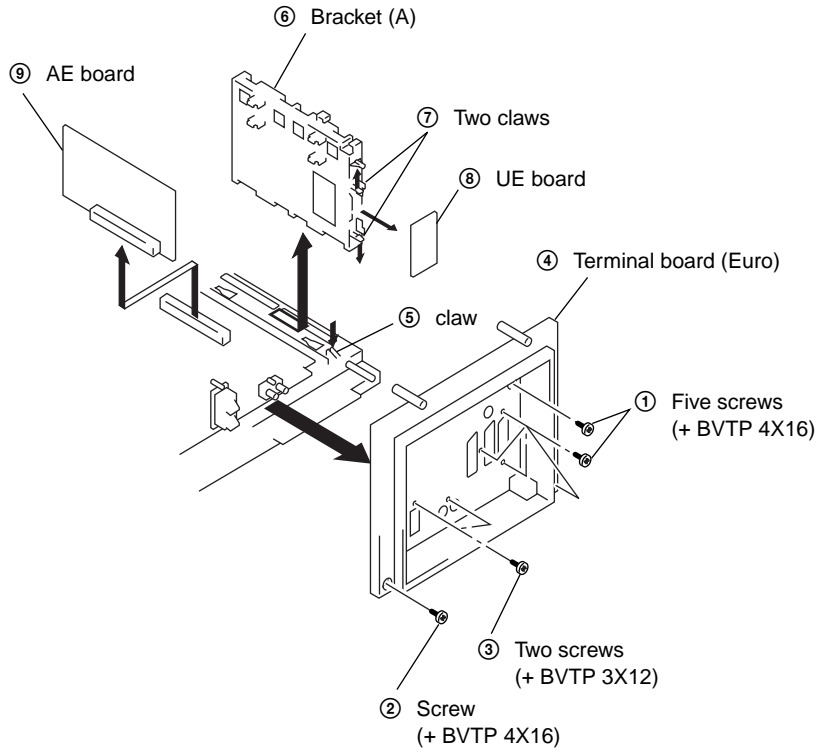

2-6. H1 BOARD, H2 BOARD AND RESISTOR (HIGHT VOLTAGE) REMOVAL

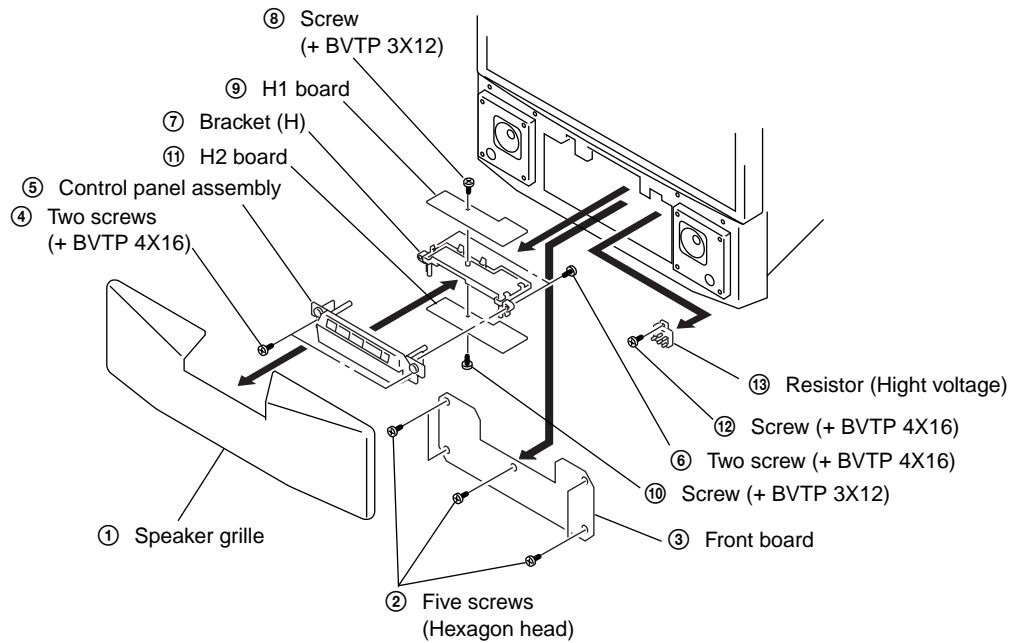

2-7. BEZNET SECTION REMOVAL

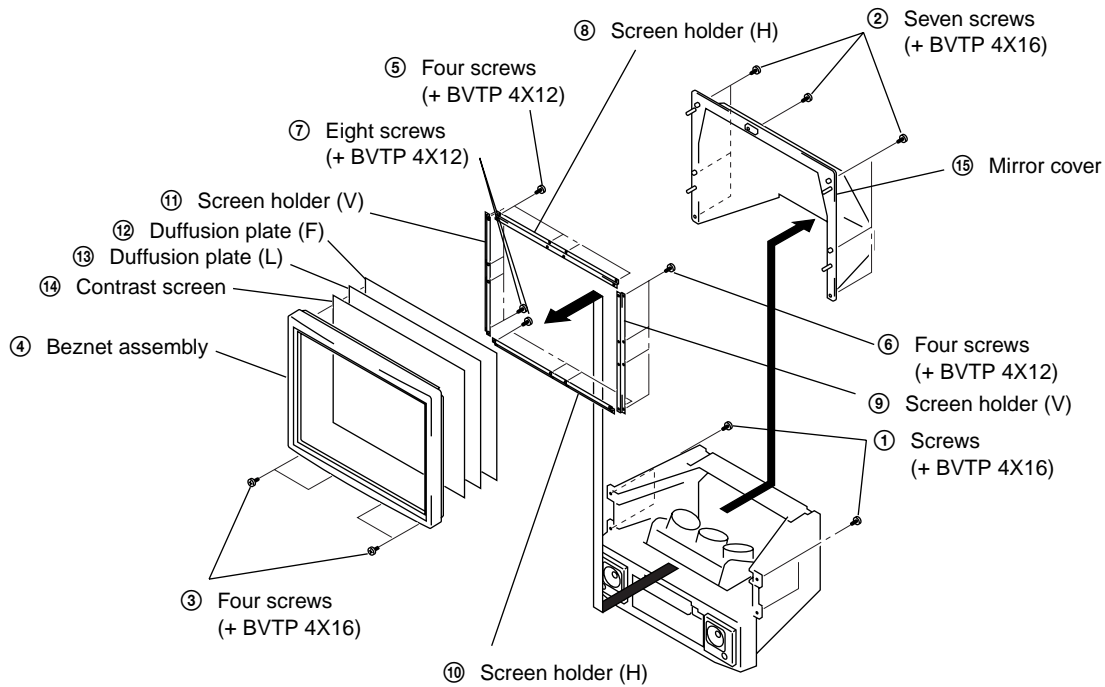

2-8. HIGH-VOLTAGE CABLE INSTALLATION AND REMOVAL

(1) Removal

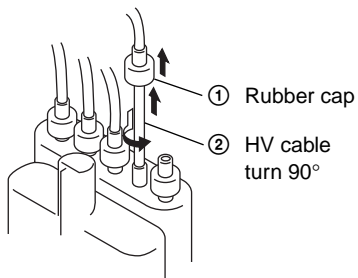

(2) Installation

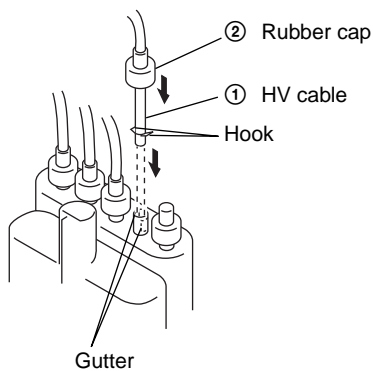

2-9. SLANT MECHASEAL ASSEMBLY REMOVAL

Removing the arrow-marked screw is strictly inhibited. If removed, it may cause liquid spill

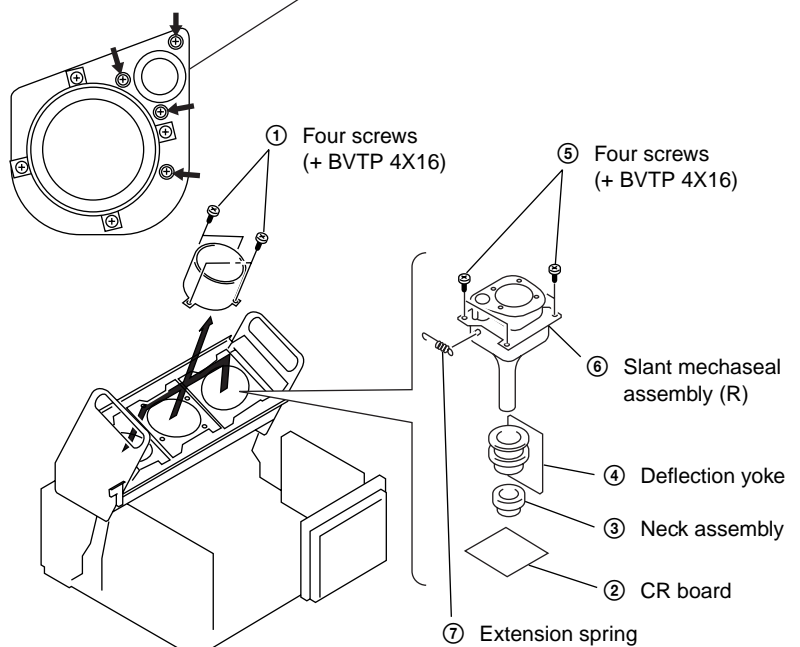

2-10. CHASSIS BLOCK REMOVAL

(1) H1, H2 BOARDS AND AND RESISTOR REMOVAL

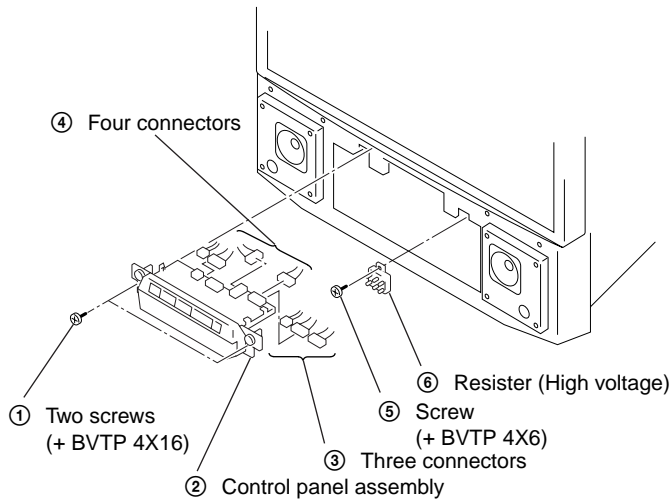

(3) CHASSIS BLOCK REMOVAL

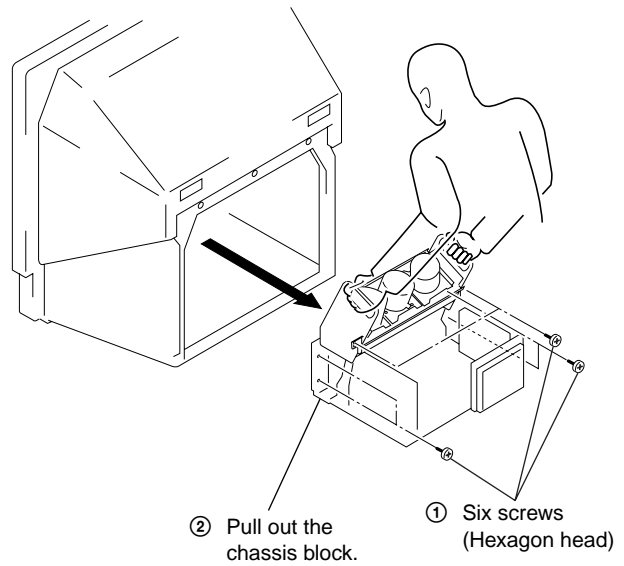

(2) MAIN BRACKET REMOVAL

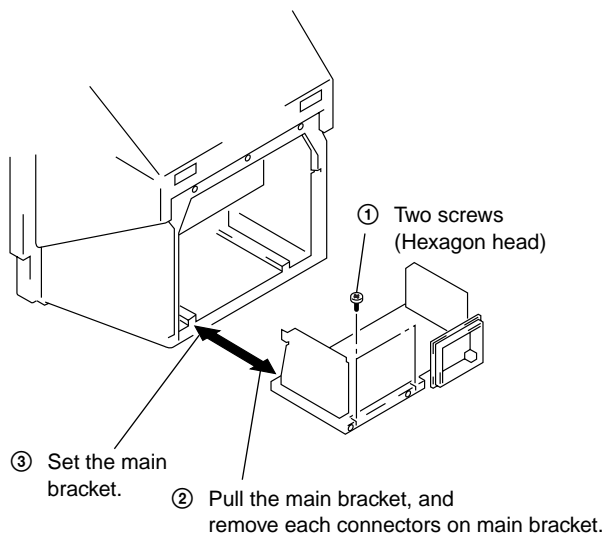

※ Pull out the chassis block by gripping the handles as shown in the diagram.

At this time, pay particular attention to the components removed in (1).

※ Pay particular attention to the wires of each Printed circuit boards when pulling out the main bracket.

SECTION 3 SET-UP ADJUSTMENTS

3-1. SCREEN VOLTAGE ADJUSTMENT (ROUGH ALIGNMENT)

1. Receive the Monoscope signal.
2. Set 50% BRIGHTNESS and minimum PICTURE.
3. Turn the red VR on the FOCUS block all the way to the left and then gradually turn it to the right until the point where you can see the retrace line.
4. Next gradually turn it to the left to the position where the retrace line disappears.

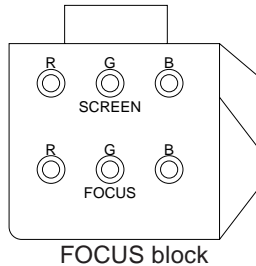

Fig. 3-1

3-2. FOCUS LENS ADJUSTMENT

1. Loose the lens screw.
2. Set in service mode.
3. Use GH (GSEL) on the service mode menu to shown only the green color.
4. Press the Commander Menu button and select TEST MENU and CONVERGENCE to display the test signal (crosshatch) on the screen.
5. Rotate the green lens and align with the optimal focus point from the test signal.
6. Use GH (GSEL) from the service mode menu to set to green and red.
7. Output the test signal and rotate the red lens to obtain the optimum focus at the point where the red and green spots overlap.
8. Use BH (BSEL) from the service mode menu to set to red and blue.
9. Output the test signal and rotate the blue lens to obtain the optimum focus at the point where the blue and red spots overlap.
10. Tighten the lens screw.

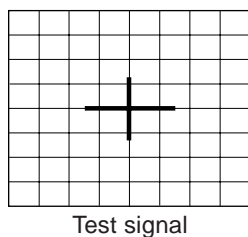

Fig. 3-2

3-3. SCREEN (G2) ADJUSTMENT

1. Connect jig (A) to 200V. In TP732, CG Board.
2. Connect jig (B) to GND. In TP733, CG Board.
3. Select with Power ON, VIDEO mode without signals.
4. Connect jig (C) to the TP701 (K.CR), TP731 (K:CG), or TP761 (K.CB) of CR, CG, and CB Board.
5. Adjust R, G, and B screen voltage to until retrace line just appears with screen VR on the Focus block

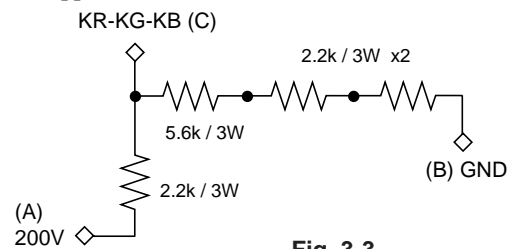

Fig. 3-3

3-4. FOCUS VR ADJUSTMENT

1. Set in service mode.
2. Use GH (GSEL) on the service mode menu to shown only the green color.
3. Press the Commander Menu button (convergence) and output the test signal (crosshach).
4. Rotate the green VR on the FOCUS block and align to obtain the optimal focus point.
5. Use GH (GSEL) from the service mode menu to set to green and red.
6. Output the test signal and rotate the red VR to obtain the optimum focus at the point where the red and green spots overlap.
7. Use BH (BSEL) from the service mode menu to set to red and blue.
8. Output the test signal and rotate the blue VR aligning to obtain the optimum focus at the point where the blue and green spots overlap.

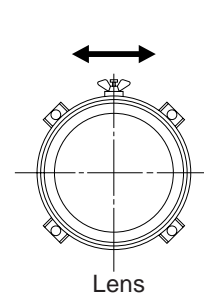

Fig. 3-4

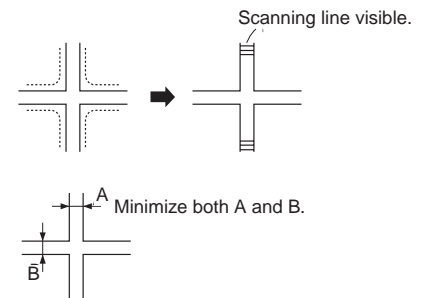
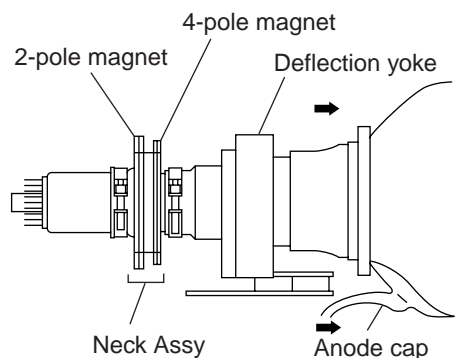

Fig. 3-5

3-5. DEFLECTION YOKE TILT ADJUSTMENT

1. Set to receive the Monoscope signal.
2. Set in service mode.
3. Place the caps on the red and blue lens so that only the green color.
4. Loosen the deflection yoke setscrew and align the tilt of the Deflection Yoke so that the bars at the center of the monoscope pattern are horizontal.
5. After aligning the deflection yoke, fasten it securely to the funnel-shaped portion (neck) of the CRT.
6. The tilt of the deflection yoke for red and Blue is aligned the same as was done for green.



Deflection yoke should be as more close to CRT as possible.

Fig. 3-6

3-6. 2-POLE MAGNET ADJUSTMENT

1. Set in service mode.
2. Set to receive the Dot signal.
3. Place the caps on the red and blue lens so that only the green color is shown.
4. Turn the green VR on the focus block to the right and set to overfocus to enlarge the spot.
5. Now align the 2-Pole Magnet so that the enlarged spot is in the center of the Just Focus spot.
6. Align the green focus VR and set for just (precise) focus.
7. Perform the same alignment for red and blue.

Use the center dot

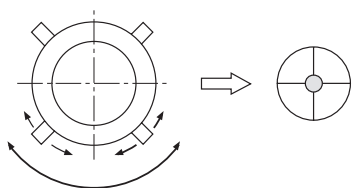

Fig. 3-7

3-7. 4-POLE MAGNET ADJUSTMENT

1. Set in service mode.
2. Set to receive the Dot signal.
3. Place the caps on the red and blue lens so that only the green color is shown.
4. Turn the green VR on the focus block to the left and set to underfocus to enlarge the spot.
5. Now align the 4-Pole Magnet so that the enlarged spot becomes a perfect circle.
6. Perform the same alignment for red and blue.

Use the center dot

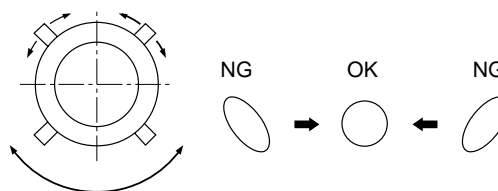

Fig. 3-8

3-8. DEFOCUS ADJUSTMENT (Blue)

1. Receive the Dot signal.
2. Place the caps on the red and green lens so that only the blue color is shown.
3. Rotate the blue focus volume on the focus pack and adjust to obtain best electrical focus.
4. Rotate Blue focus volume of focus pack clockwise, so that diameter of the Dot see Caution.

[How to Blue defocus.]

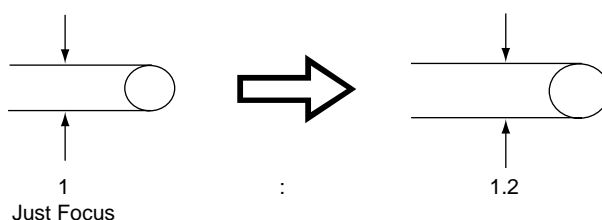

Fig. 3-9

[Change Blue Defocus]



Fig. 3-10

SECTION 4 SAFETY RELATED ADJUSTMENT

When replacing the following components marked with on the schematic diagram, always check hold-down voltage and if necessary re-adjust.

Part Replaced ()
R1

Part Replaced ()
E Board C515, C516, C554, D504, D507, L506, Q502, R1, R514, R516, R517, T502, T504 (FBT)
G Board IC6008

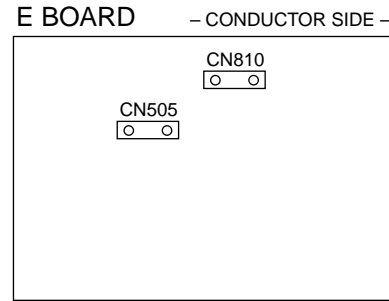

Fig. 4-3

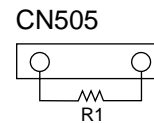

Fig. 4-4

4-1. HV HOLD-DOWN ADJUSTMENT

1. Remove CN810. Connect HV meter to HV Block.
2. Connect External Power Supply to CN810 ② pin (+135V) and ① pin (GND).

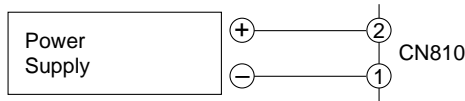

Fig. 4-1

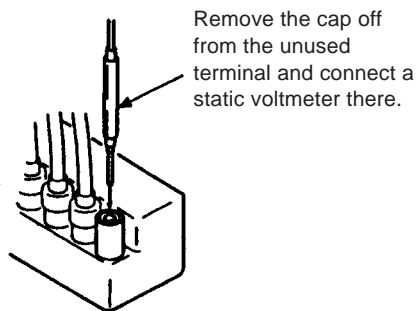

Fig. 4-2

3. Turn on the set.
4. Slowly up the supply voltage from 0V to 135V.
5. Receive dot picture and set PICTURE/BRIGHTNESS to minimum.
6. Slowly up the voltage until hold-down circuit works (picture disappear).
7. Read the HV meter of peak HV voltage.
Spec: $34.5 \pm 0.75 \text{KV}$
8. If Hold-down voltage is less than 33.75KV then solder R1=820K.
9. If hold-down voltage is over than 35.25KV then take-off R514 and solder R1=9.1K.

SECTION 5 CIRCUIT ADJUSTMENTS

5-1. ELECTRICAL ADJUSTMENTS

Service adjustment to this model can be performed with the supplied remote commander RM-862.

HOW TO ENTER INTO SERVICE MODE

1. Turn on the main power switch of the set and enter into standby mode.
2. Press the following sequence of buttons on the Remote Commander.

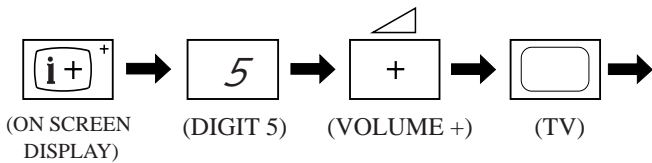

“TT—” will appear in the top right corner of the screen.
Other status information will also be displayed.

3. Press MENU on the commander to obtain the following menu on the screen.

TEST MENU

- > picture adjustment
- Geometry
- Wide
- MSP
- IC status
- Current TV status
- Convergence

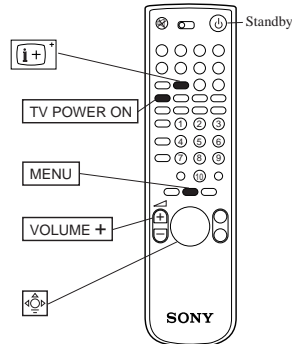

RM-862

4. Move to the corresponding adjustment using the \triangle button on the commander.
5. Move the button to the right \triangleright to enter the selected adjustment.
6. Before TURN OFF is necessary:
DATA WRITE, DATA COPY in 4 : 3 and 16 : 9 mode.
7. Turn off the power to quit the service mode when adjustments are completed.

PICTURE ADJUSTMENT

AFC mode	2
REF position	2
SCP BGR	1
SCP BGF	1
Trap Fo	0
Sub contrast	Adj
Sub colour	Adj
Sub brightness	Adj
Green drive	Adj
Blue drive	Adj
Green cutoff	Adj
Blue cutoff	Adj
Gamma	0
Pre / overshoot	0
Y delay	3

GEOMETRY ADJUSTMENT in 4 : 3 mode

UP Corn Pin	Adj
V Size	Adj
V Position	Adj
S Correction	Adj
V Linearity	Adj
H Size	Adj
H Position	Adj
Pin Amp	Adj
Pin Phase	Adj
AFC Bow	Adj
AFC Angle	Adj
EHT V	Adj
EHT H	Adj
Corner Pin	Adj
LO Corn Pin	Adj

*: Adjust only if AE board change.
For change CRT R-G-B is better CONVERGENCE
don't change in 16 : 9 mode.

WIDE

V Aspect	47
V Scroll	31
Upper V Lin	0
Lower V Lin	0
Left Blanking	1
Right Blanking	11

IC STATUS (CXA2076 / CXA2040)

CXA2076

H lock	1
IKR	1
VNG	0
X•RAY	0
Colour system	3
CV1 Sync	0

CXA2040

Sync sep	1
S1 mode pin	01
S2 mode pin	01

TUNER

Tuner status	01101011
--------------	----------

CURRENT TV STATUS

Text system	C TEXT / TV TEXT
Dolby	NO / YES
Text language set	WEST / EAST / RUSSIAN
Menu language set	WEST / EAST / RUSSIAN
Destination	B / D / U / K / L / E / A / R
Scart 16 : 9	OFF / ON
RGB priority	OFF / ON
Ageing	OFF / ON
Size	PJ
Colour trap sw	SECAM / ALL
Velocity mod	ON / OFF
AFT STATUS	WINDOW / HIGH / LOW
Lumisponder Mode	OFF

MSP

AGC ON / OFF	ON
Constant gain CDB	1
FM prescale FMP	36
Zwei mono-st WHI	36
Zwei st-mono WLO	18
Zwei mono-bi WMH	36
Zwei bi-mono WLO	18
Time zwei WML	41
Fawct limit	10
Fawct soll init FAW	12
Fawer tol	2
Nicam Err Max CCT	10
Nicam Err Min	0
Nicam Prescale NIP	97
Time Nicam	31
Carrier mute CRM	OFF
Audio clock ACO	HIZ
Scart prescale	25
Scart volume	64
NICAM Prescale I	127
NICAM Prescale L	97
NICAM Prescale BG	97
NICAM Prescale DK	97

5-2. SERVICE LIST

OSD

	Item number	Adjustment Item	Data range	Initial data	Name / Description	Device
OSD	00	CHSW	0, 1	0	HATCH DISPLAY 0 : Disp, Hatch 1 : No Disp, Hatch	
	01	OSDH	1 ~ 32	10	OSD H Position	
	02	OSDV	1 ~ 32	10	OSD V Position	
	03	VMRK	0, 1	0	V SIZE MARKER ON / OFF (cannot write to NVM)	

SFT

	Item number	Adjustment Item	Data range	Initial data	Name / Description	Device
SFT	00	SFTE	0, 1	1	SHIFT ENABLE 0 : Disable 1 : Enable	
	01	SFTF	0, 1	0	SHIFT FAST 0 : Normal 1 : Quick (cannot write to NVM)	

DP

	Item number	Adjustment Item	Data range	Initial data	Name / Description	Device
GH	00	GSEL	0, 1	0	OSD SELECT FOR GH, GV 0 : Green+Red 1 : Green	CXP86213
	01	CENT	-127 ~ +127	0	GREEN H CENTER	
	02	SKEW	-127 ~ +127	0	GREEN H SKEW	
	03	BOW	-127 ~ +127	0	GREEN H BOW	
	04	4 BOW	-127 ~ +127	0	GREEN H 4th BOW	
	05	SIZE	-127 ~ +127	0	GREEN H SIZE	
	06	LIN	-127 ~ +127	0	GREEN H LINEARITY	
	07	M SIZ	-127 ~ +127	0	GREEN H MID SIZE	
	08	M LIN	-127 ~ +127	0	GREEN H MID LINEARITY	
	09	KEY	-127 ~ +127	0	GREEN H KEYSTONE	
	10	SSKW	-127 ~ +127	0	GREEN H SUB SKEW	
	11	M PIN	-127 ~ +127	15	GREEN H MID PINCUSHION	
	12	PIN	-127 ~ +127	-12	GREEN H PINCUSHION	
	13	S BOW	-127 ~ +127	8	GREEN H SUB BOW	
	14	M BOW	-127 ~ +127	0	GREEN H MID BOW	
	15	4PIN	-127 ~ +127	0	GREEN H 4th PINCUSHION	
16	4 SBOW	-127 ~ +127	0	GREEN H 4th SUB BOW		
GV	00	CENT	-127 ~ +127	0	GREEN V CENTER	
	01	SKEW	-127 ~ +127	0	GREEN V SKEW	
	02	BOW	-127 ~ +127	0	GREEN V BOW	
	03	SIZE	-127 ~ +127	0	GREEN V SIZE	
	04	LIN	-127 ~ +127	0	GREEN V LINEARITY	
	05	M SIZ	-127 ~ +127	0	GREEN V MID SIZE	
	06	M KEY	-127 ~ +127	0	GREEN V MID KEYSTONE	
	07	KEY	-127 ~ +127	0	GREEN V KEYSTONE	
	08	S SKW	-127 ~ +127	0	GREEN V SUB SKEW	
	09	M PIN	-127 ~ +127	0	GREEN V MID PINCUSHION	
	10	PIN	-127 ~ +127	20	GREEN V PINCUSHION	
	11	S BOW	-127 ~ +127	16	GREEN V SUB BOW	
	12	WAVE	-127 ~ +127	0	GREEN V WAVE	
13	4PIN	-127 ~ +127	25	GREEN V 4th PINCUSHION		

	Item number	Adjustment Item	Data range	Initial data	Name / Description	Device
RH	00	CENT	-95~ +96	0	RED H CENTER	CXP86213
	01	SKEW	-95~ +96	0	RED H SKEW	
	02	BOW	-127 ~ +127	0	RED H BOW	
	03	4BOW	-127 ~ +127	0	RED H 4th BOW	
	04	SIZE	-127 ~ +127	25	RED H SIZE	
	05	LIN	-127 ~ +127	10	RED H LINEARITY	
	06	MSIZ	-127 ~ +127	30	RED H MID SIZE	
	07	MLIN	-127 ~ +127	-30	RED H MID LINEARTIY	
	08	KEY	-127 ~ +127	0	RED H KEYSTONE	
	09	SSKW	-127 ~ +127	0	RED H SUB SKEW	
	10	MPIN	-127 ~ +127	0	RED H MID PINCUSHON	
	11	PIN	-127 ~ +127	-10	RED H PINCUSHON	
	12	SBOW	-127 ~ +127	40	RED H SUB BOW	
	13	MBOW	-127 ~ +127	12	RED H MID BOW	
	14	4PIN	-127 ~ +127	0	RED H 4th PINCUSHON	
15	4SBOW	-127 ~ +127	0	RED H 4th SUB BOW		
RV	00	CENT	-95~ +96	-10	RED V CENTER	
	01	SKEW	-95~ +96	0	RED V SKEW	
	02	BOW	-127 ~ +127	4	RED V BOW	
	03	SIZE	-127 ~ +127	0	RED V SIZE	
	04	LIN	-127 ~ +127	0	RED V LINEARITY	
	05	MSIZ	-127 ~ +127	0	RED V MID SIZE	
	06	MKEY	-127 ~ +127	10	RED V MID KEYSTONE	
	07	KEY	-127 ~ +127	-10	RED V KEYSTONE	
	08	SSKW	-127 ~ +127	10	RED V SUB SKEW	
	09	MPIN	-127 ~ +127	0	RED V MID PINCUSHON	
	10	PIN	-127 ~ +127	10	RED V PINCUSHON	
	11	SBOW	-127 ~ +127	16	RED V SUB BOW	
	12	WAVE	-127 ~ +127	30	RED V WAVE	
	13	4PIN	-127 ~ +127	10	RED V 4th PINCUSHON	
14	MWAV	-31 ~ +31	0	MID WAVE		
BH	00	BSEL	0, 1	0	OSD SELECT FOR BH, BV 0 : Blue + Green 1 : Blue + Red	
	01	CENT	-95~ +96	0	BLUE H CENTER	
	02	SKEW	-95~ +96	0	BLUE H SKEW	
	03	BOW	-127 ~ +127	0	BLUE H BOW	
	04	4BOW	-127 ~ +127	0	BLUE H 4th BOW	
	05	SIZE	-127 ~ +127	-25	BLUE H SIZE	
	06	LIN	-127 ~ +127	-10	BLUE H LINEARITY	
	07	MSIZ	-127 ~ +127	30	BLUE H MID SIZE	
	08	MLIN	-127 ~ +127	30	BLUE H MID LINEARTIY	
	09	KEY	-127 ~ +127	0	BLUE H KEYSTONE	
	10	SSKW	-127 ~ +127	0	BLUE H SUB SKEW	
	11	MPIN	-127 ~ +127	0	BLUE H MID PINCUSHON	
	12	PIN	-127 ~ +127	-10	BLUE H PINCUSHON	
	13	SBOW	-127 ~ +127	-40	BLUE H SUB BOW	
	14	MBOW	-127 ~ +127	-16	BLUE H MID BOW	
	15	4PIN	-127 ~ +127	0	BLUE H 4th PINCUSHON	
16	4SBOW	-127 ~ +127	0	BLUE H 4th SUB BOW		

**KP-41S5/41S5B/41S5G/
41S5K/41S5R/41S5U**

RM-862

	Item number	Adjustment Item	Data range	Initial data	Name / Description	Device
BV	00	CENT	-95~ +96	-10	BLUE V CENTER	CXP86213
	01	SKEW	-95~ +96	0	BLUE V SKEW	
	02	BOW	-127 ~ +127	0	BLUE V BOW	
	03	SIZE	-127 ~ +127	0	BLUE V SIZE	
	04	LIN	-127 ~ +127	0	BLUE V LINEARITY	
	05	MSIZ	-127 ~ +127	0	BLUE V MID SIZE	
	06	MKEY	-127 ~ +127	-10	BLUE V MID KEYSTONE	
	07	KEY	-127 ~ +127	10	BLUE V KEYSTONE	
	08	SSKW	-127 ~ +127	-10	BLUE V SUB SKEW	
	09	MPIN	-127 ~ +127	0	BLUE V MID PINCUSHON	
	10	PIN	-127 ~ +127	10	BLUE V PINCUSHON	
	11	SBOW	-127 ~ +127	32	BLUE V SUB BOW	
	12	WAVE	-127 ~ +127	-30	BLUE V WAVE	
	13	4PIN	-127 ~ +127	10	BLUE V 4th PINCUSHON	
14	MWAV	-31 ~ +31	0	MID WAVE		

ACV

	Item number	Adjustment Item	Data range	Initial data	Name / Description	Device
ACV	00	ART0	1~ 8	6	DATA SAMPLE LENGTH (1 step = 1 microsec.)	
	01	AT1T	0~ 255	18	Data Sampling Start Time	
	02	AT1M	0~ 255	132	from V BLK (50Hz)	
	03	AT1B	0~ 255	240	(1 step = 64 μsec = approx. 1H)	
	04	AH51	0~ 255	18	(1 step = 1 OSD step) OSD H POS 50 (L&R)	
	05	AH52	0~ 255	130	OSD H POS 50 (UP&BOTTOM)	
	06	AV5T	0~ 255	1	(1 step = 2 lines) OSD V POS 50 (UP)	
	07	AV5M	0~ 255	60	OSD V POS 50 (L&R)	
	08	AV5B	0~ 255	130	OSD V POS 50 (BOTTOM)	
	09	AH61	0~ 255	18	(1 step = 1 OSD step) OSD H POS 60 (L&R)	
	10	AH62	0~ 255	130	OSD H POS 60 (BOTTOM)	
	11	AV6T	0~ 255	1	(1 step = 2 lines) OSD V POS 50 (UP)	
	12	AV6M	0~ 255	46	OSD V POS 50 (L&R)	
	13	AV6B	0~ 255	100	OSD V POS 50 (BOTTOM)	
	14	RHCO	-127 ~ +127	0	(8 step = 1 step) RH CENT ADJ OFFSET	
	15	BHCO	-127 ~ +127	0	BH CENT ADJ OFFSET	
	16	RVCO	-127 ~ +127	0	RV CENT ADJ OFFSET	
	17	BVCO	-127 ~ +127	0	BV CENT ADJ OFFSET	
	18	RHSO	-127 ~ +127	0	RH SKEW ADJ OFFSET	
	19	BHSO	-127 ~ +127	0	BH SKEW ADJ OFFSET	
	20	RVSO	-127 ~ +127	0	RV SKEW ADJ OFFSET	
	21	BVSO	-127 ~ +127	0	BV SKEW ADJ OFFSET	
22	AERR	0~ 255	0	(see Error Code List)		

MSC

	Item number	Adjustment Item	Data range	Initial data	Name / Description	Device
MSC	00	ACTL	0~ 255	0	Lower byte of counter value	
	01	ACTH	0~ 255	0	Higher byte of counter value	

5-3. REGISTRATION (CONVERGENCE) ADJUSTMENT METHOD

PAL REGISTRATION ADJUSTMENT

- 1) Receive the PAL SPCB signal.
- 2) Select Service mode and enter adjustment items for Green signal.

With the joystick:

↑↓ Items change
←→ Data change

In internal pattern it appears only RG or G only.

ITEM	CHSW	01	External pattern
	CHSW	00	Internal pattern

CENTER ADJUSTMENT

- 1) Adjust GH and GV CENT.

GV CENT



GH CENT

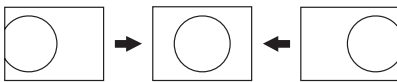

SIZE ADJUSTMENT

SPEC : H-SIZE 16.4 +/- 0.15 Sq.
V-SIZE 12.3 +/- 0.15Sq.

VSP HSIZE



VSP VSIZE

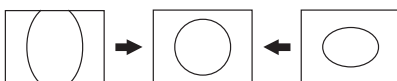

5-4. GEOMETRY

Before adjust GEOMETRY, sure the data in convergence.

- GH SIZE = 0
- GV SIZE = 0
- Adjust S correction

MAIN DEFLECTION ADJUSTMENT

- 1) Adjust VSP V-Lin.

Correct linearity of the horizontal top and bottom lines.

VSP VLINE



- 2) Adjust AFC ANGLE

Correct the vertical center line to be in parallel with the screen edges and other colors.

AFC ANGLE

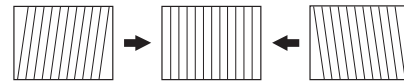

- 3) Adjust AFC BOW

Correct linearity of the vertical center line.

AFC BOW

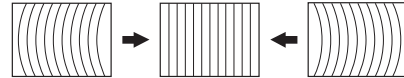

- 4) Adjust PIN AMP

Correct the vertical left and right lines and eliminate pin-cushion-shaped distortion.

PIN AMP

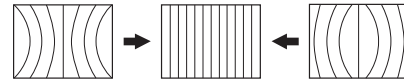

- 5) Adjust PIN PHASE

Correct the vertical left and right lines to be in parallel with each other.

PIN PHASE

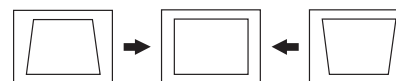

- 6) Adjust UP CORN PIN

Correct the screen top section line bow.

UP CORN PIN

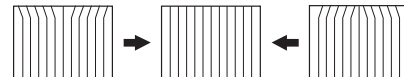

7) Adjust LO CORN PIN

Correct the screen bottom section line bow.

LO CORN PIN

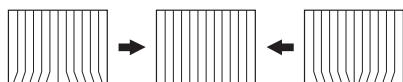

SUB DEFLECTION ADJUSTMENT ITEM

Adjustment O : Yes - : No

Display	Adjustment item	Adjustment type					
		GH	GV	RH	RV	BH	BV
BSEL	COL SELECT	-	-	-	-	O	-
CENT	CENT	O	O	O	O	O	O
SKEW	SKEW	O	O	O	O	O	O
BOW	BOW	O	O	O	O	O	O
4BOW	4TH BOW	O	-	O	-	O	-
SIZE	SIZE	O	O	O	O	O	O
LIN	LIN	O	O	O	O	O	O
MSIZ	MID SIZE	O	O	O	O	O	O
MLIN	MID LIN	O	O	O	-	O	-
MKEY	MID KEY	-	O	-	O	-	O
KEY	KEY	O	O	O	O	O	O
SSKW	SUB SKEW	O	O	O	O	O	O
MPIN	MID PIN	O	O	O	O	O	O
PIN	PIN	O	O	O	O	O	O
SBOW	SUB BOW	O	O	O	O	O	O
WAVE	WAVE	-	O	-	O	-	O
MBOW	MID BOW	O	-	O	-	O	-
4PIN	4TH PIN	O	O	O	O	O	O
4SBOW	4TH SUB BOW	O	-	O	-	O	-

VERTICAL LINE ADJUSTMENT

MENU → Convergence

1. Carefully watching out for the GH CENT screen centre section, adjust GH CENT, GH BOW, GH SKEW.
2. GH 4th Bow adjustment. Correct the corner distortion which could not be adjusted with GH BOW.

Watch out only for the GH CENT center point.

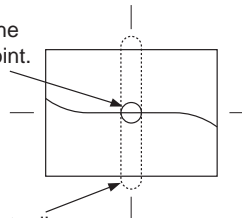

Watch the vertical center line.

GH CENT

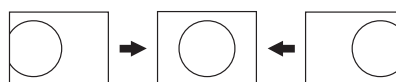

GH BOW

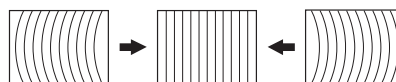

GH SKEW

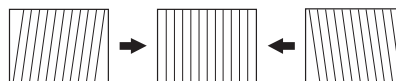

GH 4BOW

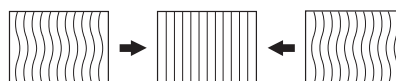

HORIZONTAL LINE ADJUSTMENT

1. Finely adjust the centre position of the vertical line at the centre of the screen with GV CENT.
2. Using GV SKEW and GV BOW, correct the tilt and bow of the horizontal line at the centre of the screen.

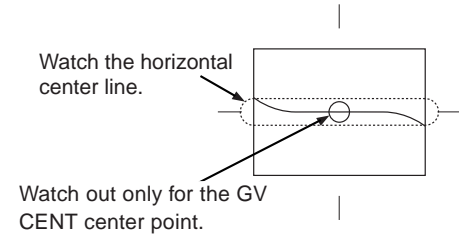

GV CENT

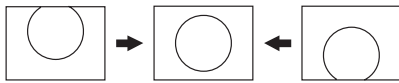

GV SKEW

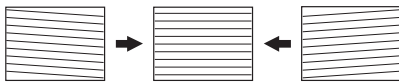

GV BOW

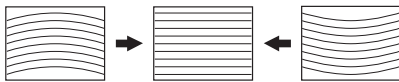

SIZE AND LINEARITY ADJUSTMENT

1. Balance the sizes at both sides of the centre section of the screen with GH MLIN.
2. Balance the sizes on both end sections of the screen with GH LIN.
3. While tracking, adjust with GH MLIN and GH LIN so that the sizes of the horizontal line at the centre of the screen are symmetrical left and right.

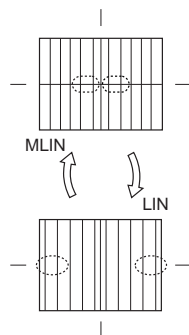

HORIZONTAL SIZE ADJUSTMENT

1. Adjust with GH MSIZE, so that the sizes of both edges and centre are equal.
2. Adjust with GH SIZE, so that the horizontal sizes of both edges and centre are equal.
3. While tracking adjust GH MSIZE and GH SIZE so that the space intervals for the horizontal section of the screen are equal.
4. Adjust again if M LIN is changed after GH MSIZE and GH SIZE are complete.

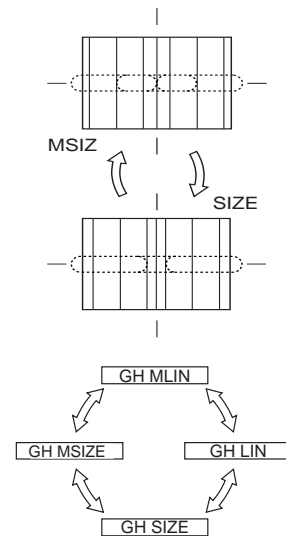

GREEN VERTICAL LINEARITY ADJUSTMENT

1. Adjust GV LIN so that the vertical lines at the top and bottom of the screen are symmetrical.

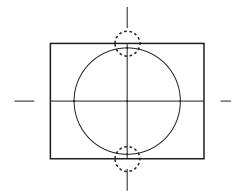

GREEN VERTICAL SIZE ADJUSTMENT

1. Adjust GV MSIZE so that the sizes at the top and bottom and centre are equal.
2. Set the vertical size to correct specification.
3. While tracking adjust GV MSIZE and GV SIZE so that the space intervals for the vertical line of the screen are equal, also the vertical size should be within space.
4. Adjust again if GV L IN has been altered after completing the above adjustments.

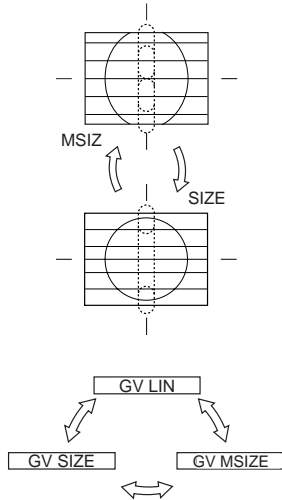

GREEN HORIZONTAL QUATERNARY ADJUSTMENT

1. Adjust GH 4PIN, to correct the 4th order distortion.
2. Adjust GH 4SBO to balance and correct the 4th order distortion at both edges of the screen.
3. While tracking adjust GH 4PIN and GH 4SBOW.

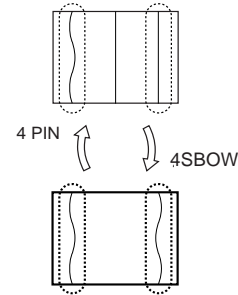

GREEN HORIZONTAL ASYMMETRICAL PIN DISTORTION ADJUSTMENT

1. Adjust GH MBOW, so that the pin asymmetry at both sides of the centre section are symmetrical left and right.
2. Adjust GH SBOW so that the bow at both edges of the screen is symmetrical left and right.
3. While tracking adjust GH MBOW and GH SBOW so that the bow of vertical lines over the entire screen is symmetrical.

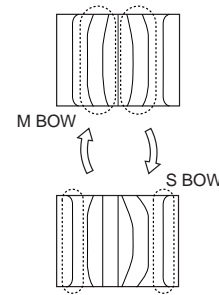

GREEN HORIZONTAL TRAPEZOIDAL DISTORTION ADJUSTMENT

1. Adjust GH SSKW so that the tilt of the vertical lines at both edges of the screen are symmetrical left and right.
2. Adjust GH KEY so that there is no tilt in the vertical lines at both edges of the screen.
3. While tracking adjust GH KEY and GH SSKW.

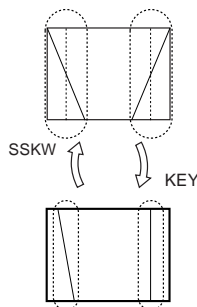

GREEN HORIZONTAL SYMMETRICAL PIN DISTORTION ADJUSTMENT

1. Adjust GH MPIN to correct pin distortion at both edges of the centre section.
2. Use GH PIN to correct pin distortion at both edges of the screen.
3. While tracking adjust GH MPIN and GH PIN so that the PIN of vertical lines on the entire screen have no bowing.
4. If there is asymmetrical distortion after adjustments, re-adjust GH MBOW and GH SBOW while tracking.

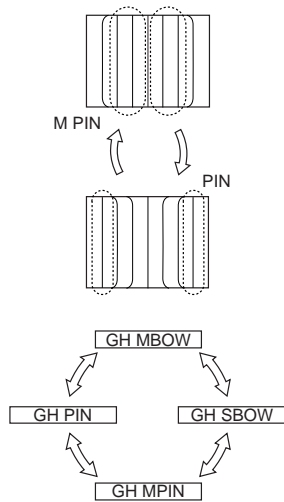

GREEN VERTICAL WAVE (3RD-ORDER) DISTORTION ADJUSTMENT

1. Check the screen at the top & bottom, and look for any 2nd or 3rd order waveform distortion of horizontal lines. Correct with GV WAVE.
2. While tracking adjust GV WAVE and GV KEY, if there are any KEY distortion.

GV WAVE

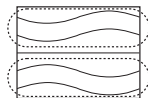

GV KEY

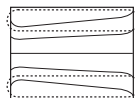

GREEN VERTICAL 4TH ORDER DISTORTION ADJUSTMENT

1. By using GV 4 PIN, 4th-Order distortion of the horizontal lines at the top & bottom can be corrected. Since there is no 4SBO for vertical correction, there will be a slight imbalance, but adjust the registration to eliminate any distortion.

GV 4PIN

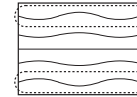

GREEN VERTICAL TRAPEZOIDAL DISTORTION ADJUSTMENT

1. Adjust GV SSKW so that the tilt of the horizontal lines at the top and bottom of the screen are symmetrical.
2. Adjust GV MKEY so that there is no tilt for the middle section.
3. Adjust GV KEY so that there is no tilt at the top and bottom of the screen.
4. While tracking adjust GV MKEY and GV KEY, so that there is no tilt over the entire screen.
5. If the tilt is unbalanced after GV MKEY and GV KEY have been adjusted, readjust GV SSKW.

GV SSKW

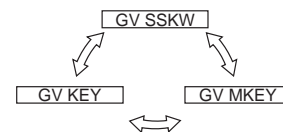
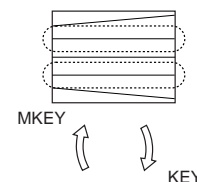
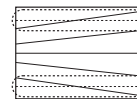

GREEN VERTICAL ASYMMETRICAL PIN DISTORTION (2ND-ORDER DISTORTION) ADJUSTMENT

1. Correct the asymmetrical pin distortion at the top and bottom of the screen with GV SBOW.

GV SBOW

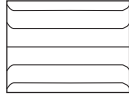

GREEN VERTICAL ASYMMETRICAL PIN DISTORTION ADJUSTMENT

1. Using GV MPIN adjust the pin distortion at both edges of the screen and at the centre.
2. Using GV PIN, adjust, so that the horizontal lines at the top & bottom of the screen are straight lines.
3. Adjust GV MPIN & GV PIN so that there is no curve in the horizontal lines on the entire screen.
4. After adjusting the items above, using tracking with GV SBOW, GV MPIN, and GV PIN to correct the entire screen.

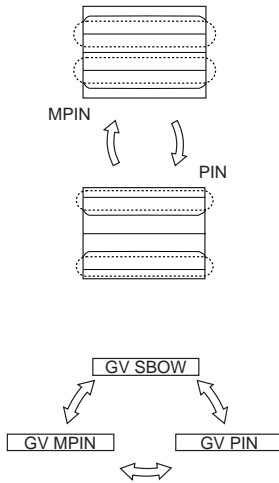

GREEN AND RED REGISTRATION ADJUSTMENT

1. Receive a PAL cross-hatch signal.
2. Adjust so that the red lines lay on the green lines.
Adjust, using the same procedure as the GREEN SUB adjustment outline above.

Note : Main registration correction should not be while adjusting Red adjustment.

BEWARE : Not to change Green Sub Items It' s easily done by mistake.

GREEN AND BLUE ADJUSTMENT

1. Adjust so that the blue and green lines are on top of each other.

Note : Main registration correction should not be while adjusting Blue adjustment.

BEWARE : Not to change Green & Red Sub Items. It' s easily done by mistake.

REGISTRATION DATA WRITE

* Points to bear in mind :

There are two independent modes of pictures 4 : 3 MODE and 16 : 9 MODE

1. Once REGISTRATION 4 : 3 has been adjusted
Press "Mute" + 0 >"Data Write"
(write data in NVM)
Press "On screen disp." + 0 >"WRT 5060" Pal to NTSC
(write data Pal/Secam to NTSC)
If 2 + 0 is pressed (Data copy) it is recording data from 4 : 3 to 16 : 9 mode.
So it should be adjusted in 16 : 9 mode.

2. Adjust REGISTRATION in 16 : 9 mode.
Press "Mute" + 0 >"Data Write"
(write data in NVM)
Press "On screen disp." + 0 >"WRT 5060"Pal to NTSC
(write Pal/Secam to NTSC)
3. Once REGISTRATION has been adjusted in both modes (4 : 3 and 16 : 9)
 - a) With picture go into service mode
 - b) Press TT and "autoconvergence" button in control panel and wait for the adjusting

* Make sure input signal is PAL. If input signal is NTSC and do this process, NTSC data are copied to PAL data!

5-5. AGC ADJUSTMENT

1. Receive an off-air signal.
2. Adjust the AGC VR (IF 1001) so that there is no snow noise and cross-modulation.

5-6. WHITE BALANCE ADJUSTMENT

1. Receive the monoscope signal and adjust the picture quality with the menu.
2. Adjust service mode S-BRIGHT so that the signal 10 IRE section barely glows.
3. Receive the all-white pattern signal.
4. Adjust the white balance with service mode G-CUTOFF and B-CUTOFF.
5. Adjust service mode S-BRIGHT so that the signal 100 IRE section barely glows.
6. Adjust the white balance with service mode G-DRIVE and B-DRIVE.
7. Repeatedly adjust the white balance for the minimum and maximum picture settings.

5-7. TEXT POSITION ADJUSTMENT

1. Receive RF signal with text.
2. Press TT74 (Text H position adjustment) of Test commander.
3. Adjust H Position of Text.

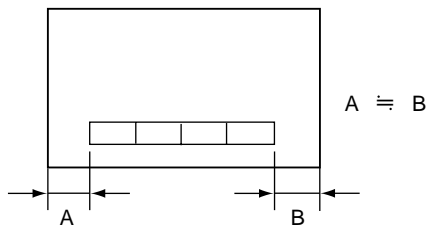

MEMO

A series of horizontal dotted lines for writing a memo, spanning the width of the page below the 'MEMO' header.

BLOCK DIAGRAM (2)

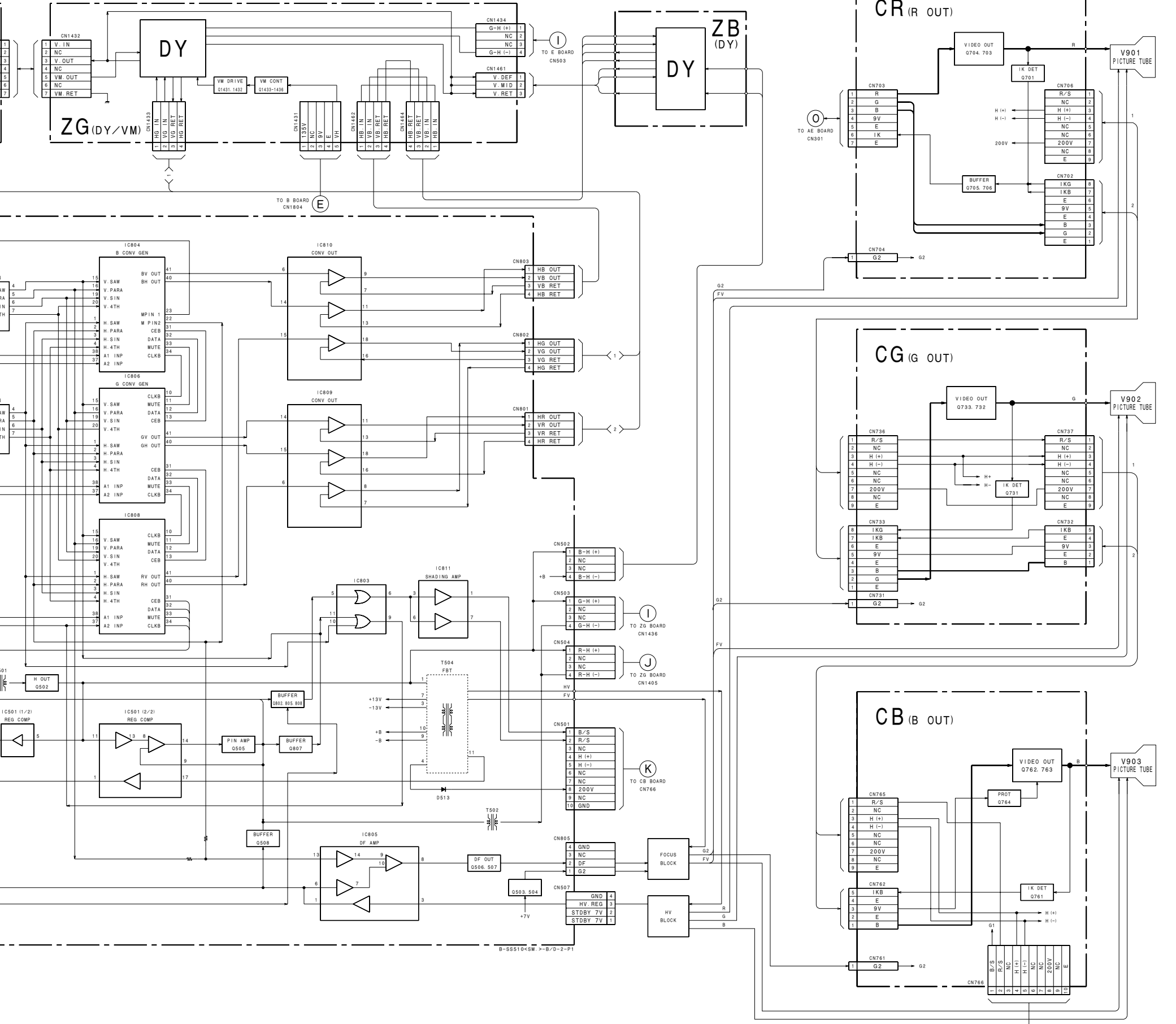
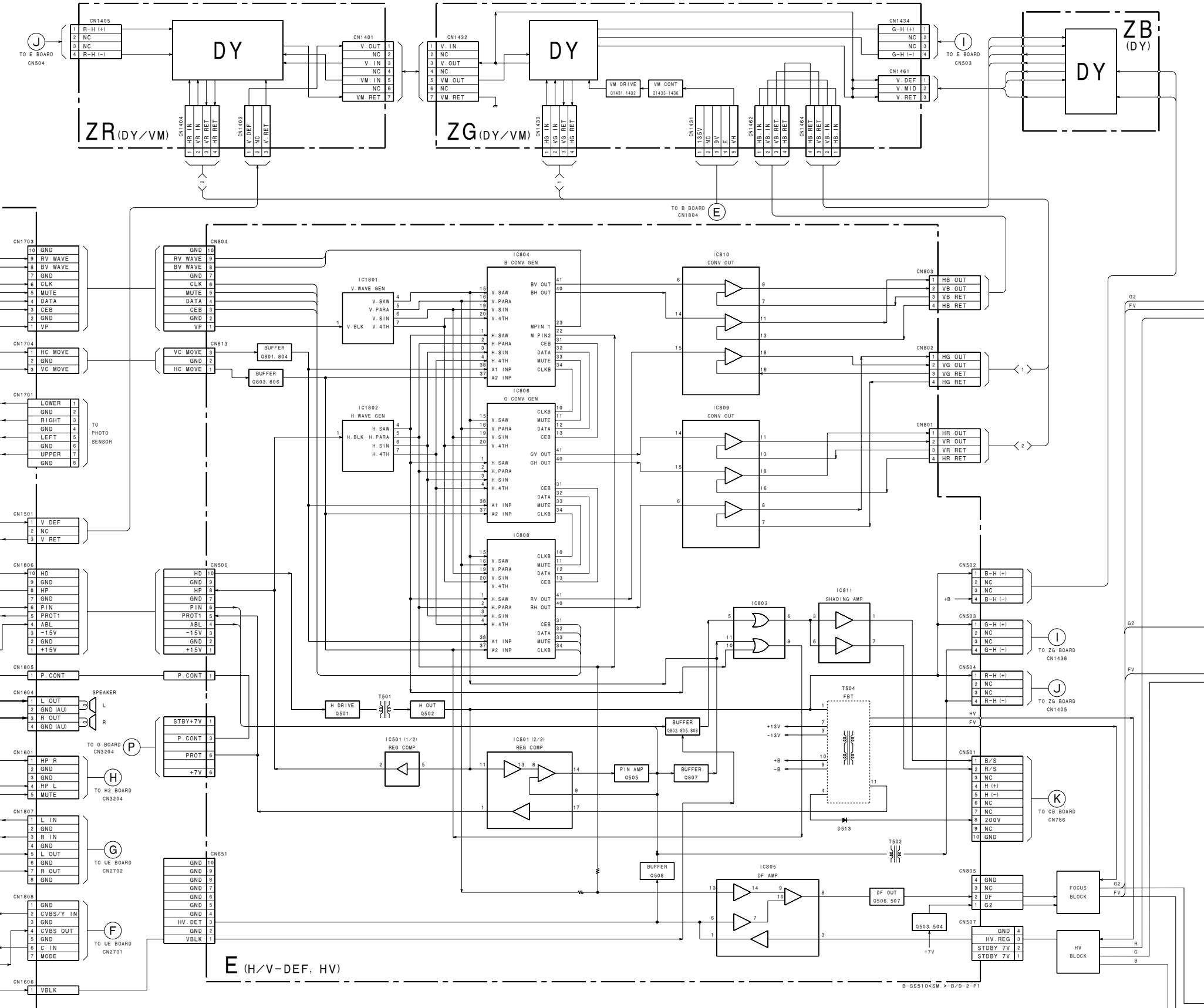
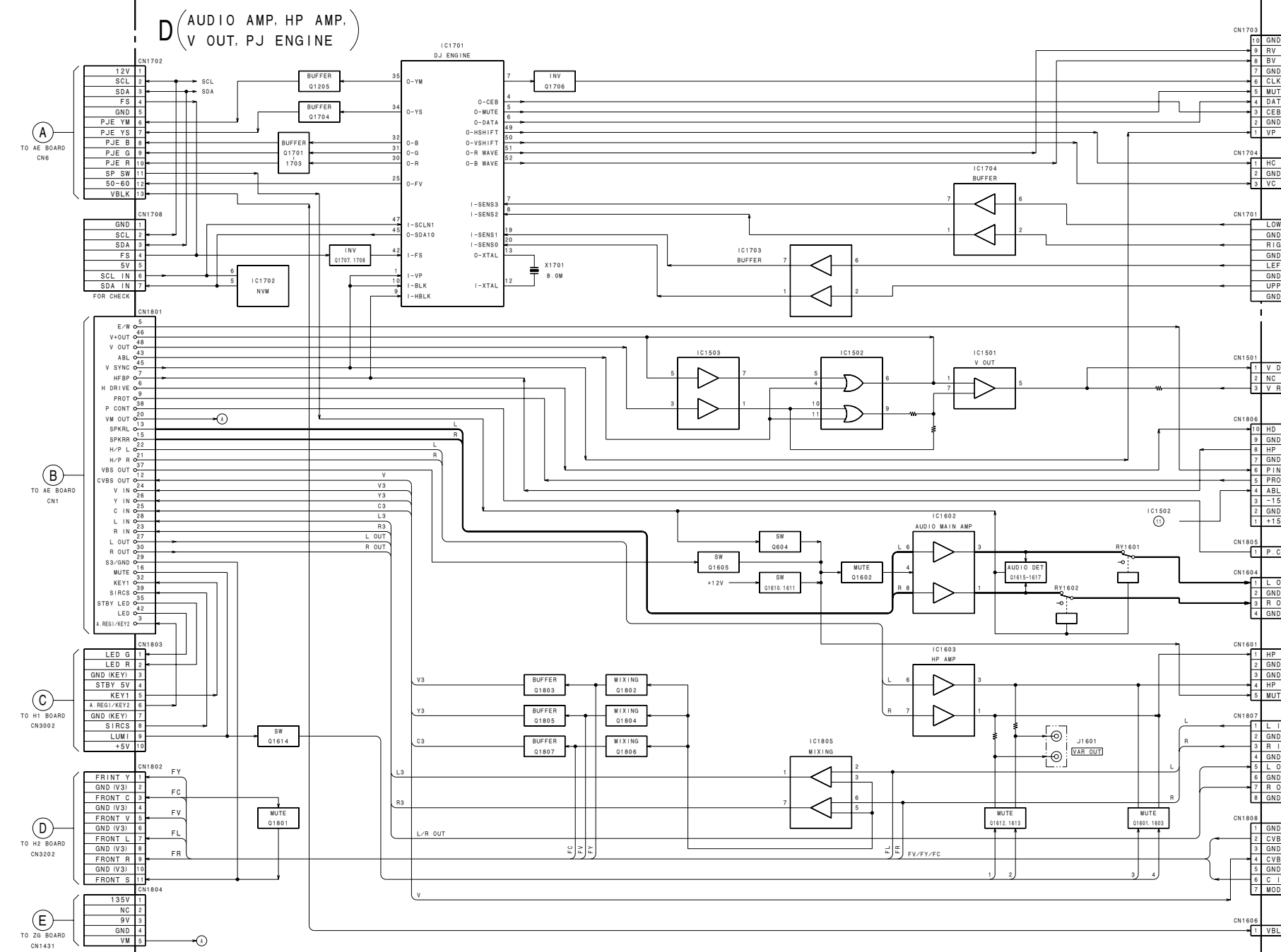

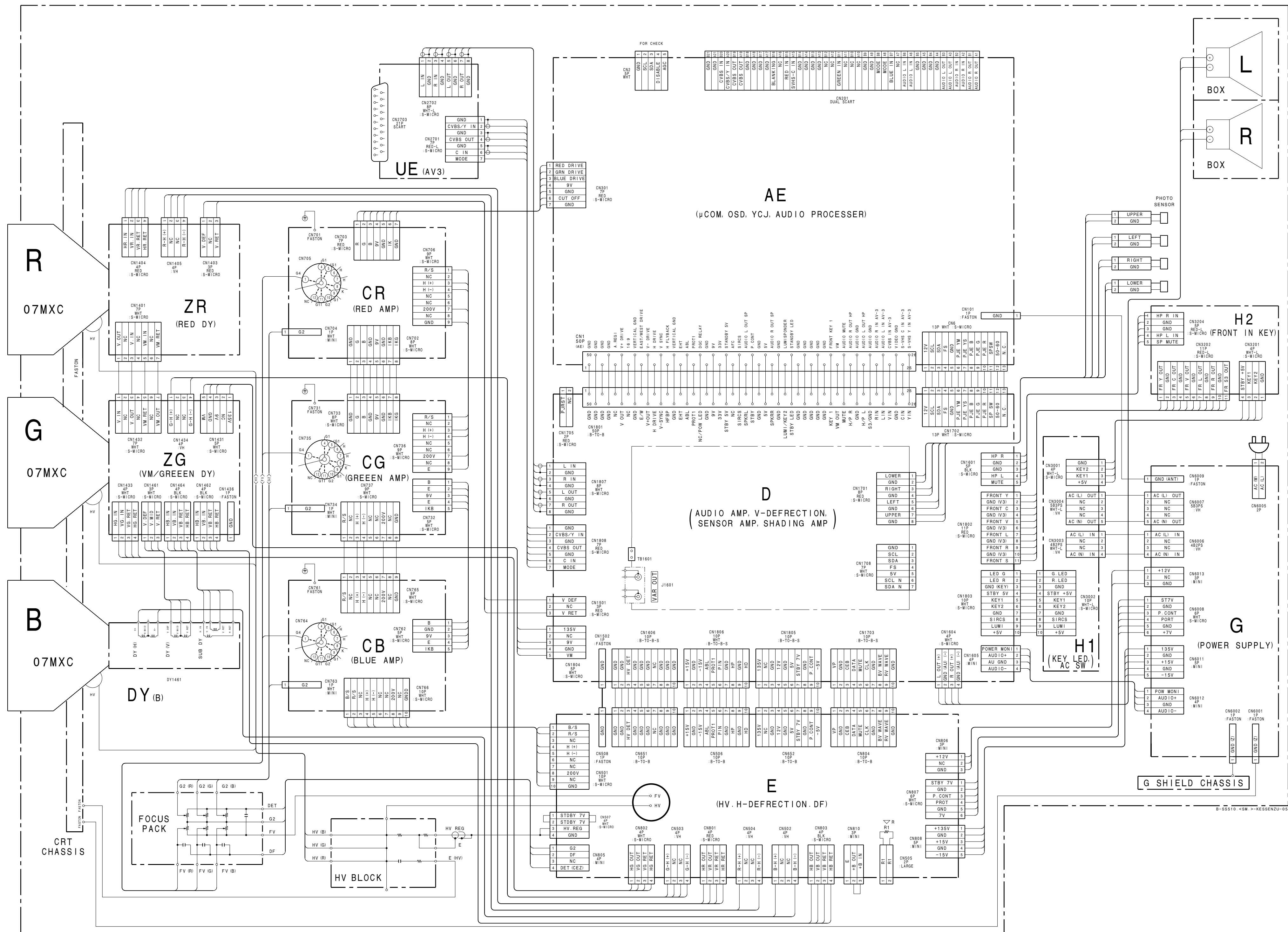

6-3. CIRCUIT BOARDS LOCATION

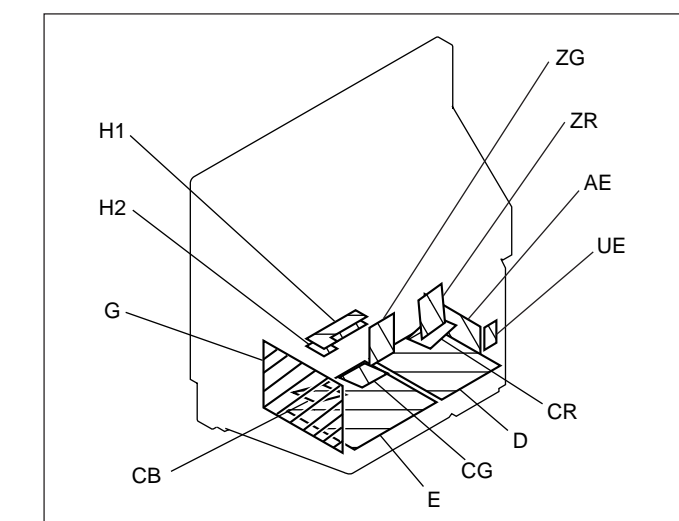

6-4. PRINTED WIRING BOARDS AND SCHEMATIC DIAGRAMS

- Note:
 • Capacitors without voltage indication are all 50V.
 • All capacitors are in μF unless otherwise noted.
 • All resistors are in ohms.
 • kΩ=1000Ω, MΩ=1000kΩ
 • Indication of resistance, which does not have one for rating electrical power, is as follows.
 [Symbol] Pitch: 5mm
 [Symbol] Rating electrical power: 1/10W (CHIP: 1/10W)
 [Symbol] : nonflammable resistor.
 [Symbol] : fusible resistor.
 [Symbol] : internal component.
 [Symbol] : panel designation and adjustment for repair.
 • All variable and adjustable resistors have characteristic curve B, unless otherwise noted.
 • As to the voltage value shown by the semiconductors on the Schematic Diagram, see the another list.
 • Readings are taken with a color-bar signal input.
 no mark : PAL/common
 < : SECAM
 () : NTSC3.58
 • Readings are taken with a 10MΩ digital multimeter.
 • Voltages are dc with respect to ground unless otherwise noted.
 • Voltage variations may be noted due to normal production tolerances.
 • All voltages are in V.
 * : Measurement impossibility.
 [Symbol] : B+line.
 [Symbol] : B-line.
 (Actual measured value may be different).
 [Symbol] : signal path.
 • Circled numbers are waveform references.
 Reference information
 RESISTOR : RN METAL FILM
 : RC SOLID
 : FRPD NONFLAMMABLE CARBON
 : FUSE NONFLAMMABLE FUSIBLE
 : RW NONFLAMMABLE WIREWOUND
 : RS NONFLAMMABLE METAL OXIDE

- :RB NONFLAMMABLE CEMENT
- :※ ADJUSTMENT RESISTOR
- :LF-8L MICRO INDUCTOR
- :TA TANTALUM
- :PS STYROL
- :PP POLYPROPYLENE
- :PT MYLAR
- :MPS METALIZED POLYESTER
- :MPP METALIZED POLYPROPYLENE
- :ALB BIPOLAR
- :ALT HIGH TEMPERATURE
- :ALR HIGH RIPPLE

Note: The components identified by shading and mark are critical for safety. Replace only with part number specified.

Terminal name of semiconductors in silk screen printed circuit (※)

Device	Printed symbol	Terminal name	Circuit
① Transistor		Collector Base Emitter	
② Transistor		Collector Base Emitter	
③ Diode		Cathode Anode	
④ Diode		Cathode Anode (NC)	
⑤ Diode		Cathode Anode (NC)	
⑥ Diode		Common Anode Cathode	
⑦ Diode		Common Anode Cathode	
⑧ Diode		Common Anode Cathode	
⑨ Diode		Common Anode Cathode	
⑩ Diode		Common Cathode Anode	
⑪ Diode		Common Cathode Anode	
⑫ Diode		Anode Cathode Anode Cathode	
⑬ Transistor (FET)		Drain Gate Source	
⑭ Transistor (FET)		Drain Gate Source	
⑮ Transistor (FET)		Source Drain Gate	
⑯ Discrete semiconductor			

(Chip semiconductors that are not actually used are included.)

G BOARD : IC6004 IR3M02

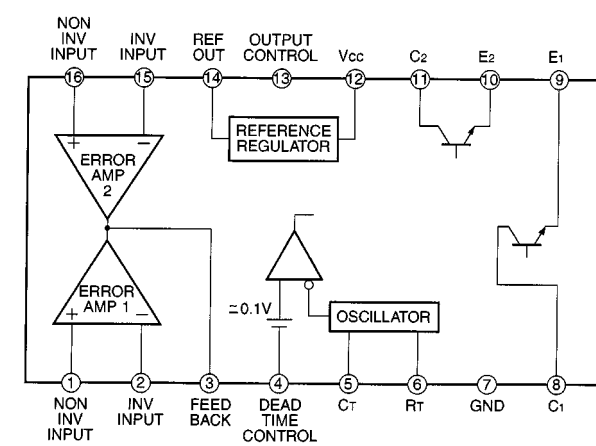

G BOARD : IC6007 IR2112

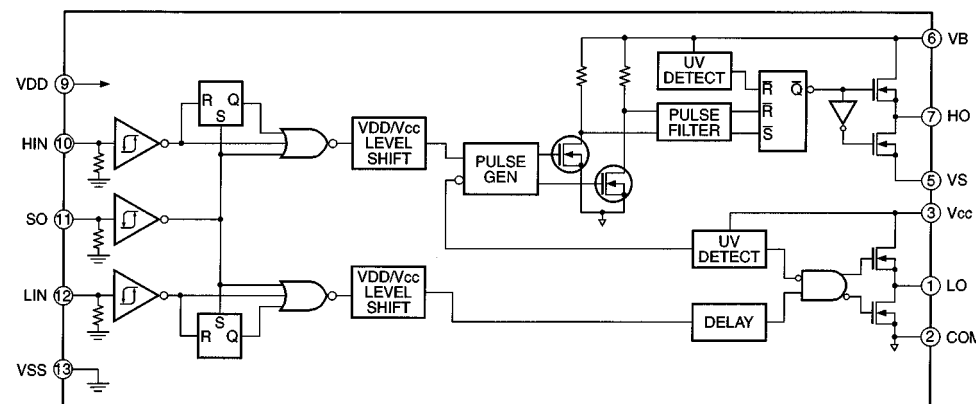

Schematic diagram
G board →

G BOARD IC VOLTAGE LIST

REF.	NO.	VOL.
●IC6001	1	GND
	2	GND
	3	GND
	4	5.9
	5	296.0
	8	GND
●IC6004	1	3.9
	2	4.8
	4	GND
	5	1.7
	6	3.9
	7	GND
	8	14.1
	9	5.8
	10	6.4
	11	14.4
	12	14.5
	13	5.3
	14	5.3
	15	5.3
	16	GND
IC6005	1	7.0
	2	5.8
	●3	13.5
	●4	13.8
IC6006	1	14.0
	2	13.0
●IC6007	●3	GND
	●4	3.0
	1	6.2
	2	GND
	3	14.5
	5	147.0
	6	150.0
	7	150.0
	9	14.5
	10	6.4
	11	GND
	12	5.8
	13	GND
IC6008	1	134.5
	2	12.5
	3	GND

●: All voltages are in V.
*Pin numbers which are not described are not used.
*The figures in the parentheses are the voltage difference from primary side ground.

G BOARD TRANSISTOR VOLTAGE LIST

REF.	VOL.
●Q6001	B 0.8
	C 0
	E 0
●Q6002	E GND
●Q6003	E 13.8
	C GND
	B 5.1
●Q6005	B 0.7
	C GND
●Q6009	E 14.5
	C 14.5
	B 0.7
Q6010	E GND
	C 0.1
Q6011	B 0
	E GND
	C 7.0
Q6012	B 7.0
	E 7.0
	C 0
Q6013	E 135.1
	C 0
●Q6014	D 147.0
	G 150.0
●Q6015	D 292.0
	S 147.0

All voltages are in V.
*The figures in the parentheses are the voltage difference from primary side ground.

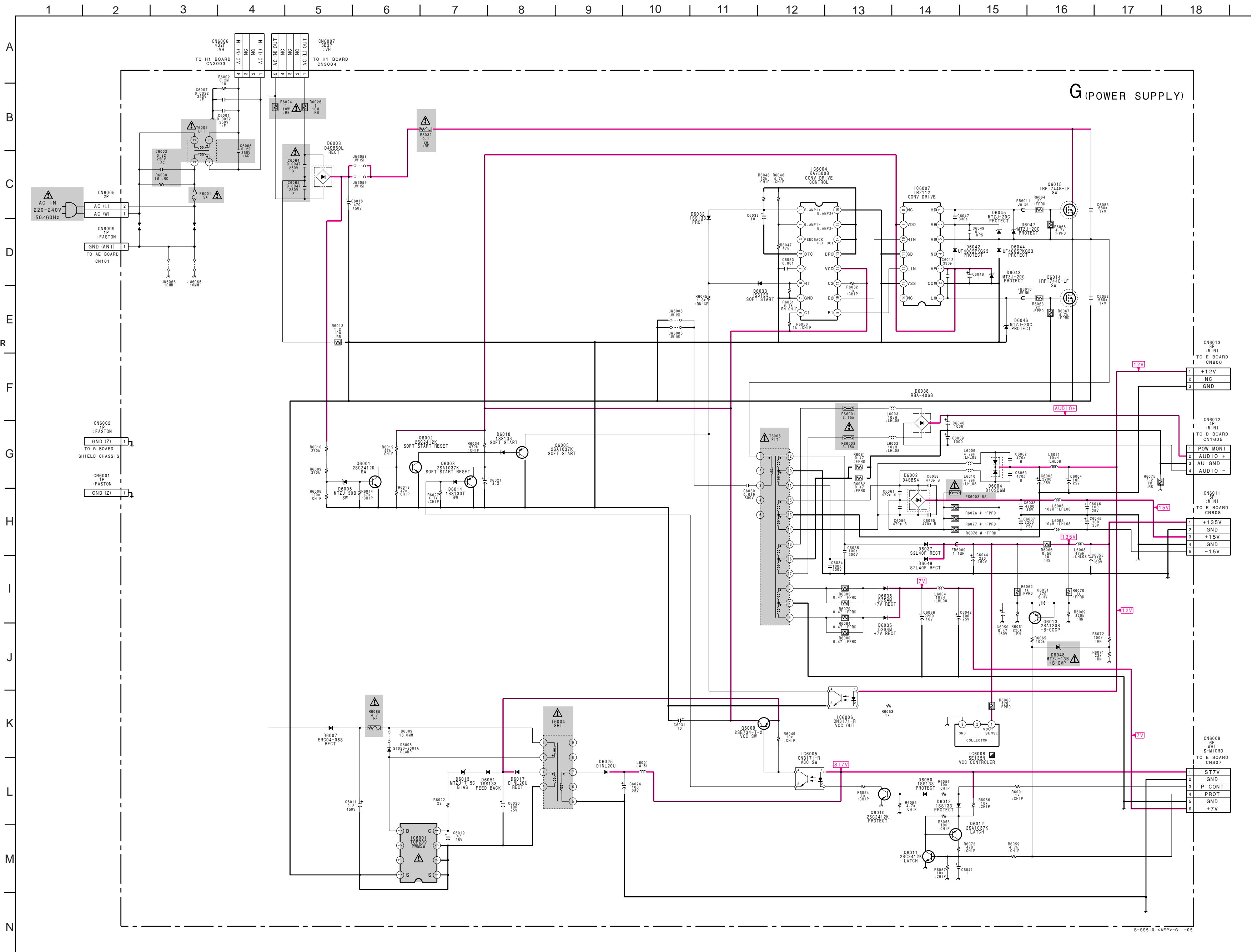

G [POWER SUPPLY]

– G Board –

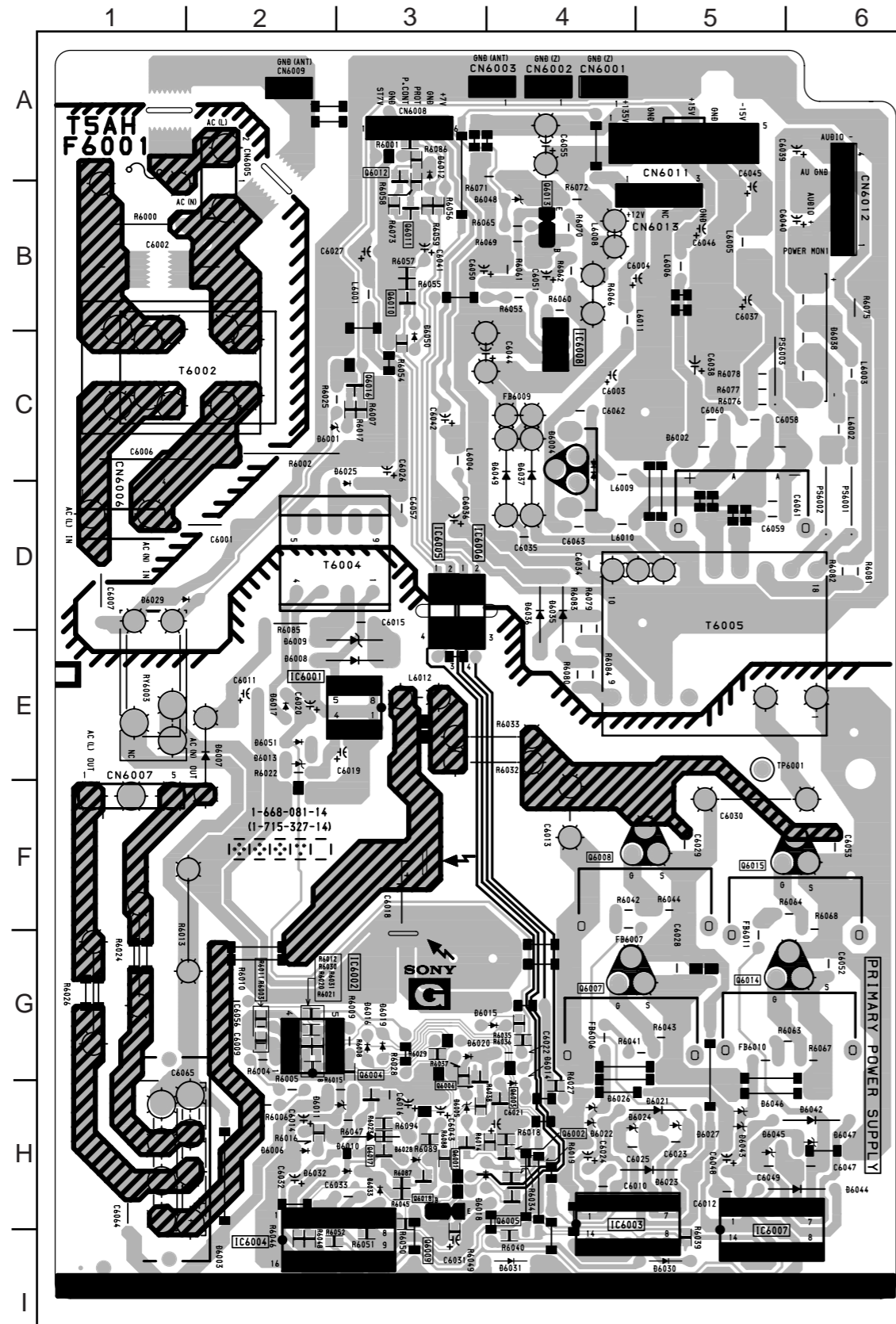

G BOARD

DIODE		*		
D6002	C-5	-	D6048	B-4
D6003	H-2	-	D6049	C-4
D6004	C-4	-	D6050	C-3
D6005	H-3	-	D6051	E-2
D6007	E-2	-	TRANSISTOR *	
D6008	E-3	-	Q6001	H-3
D6012	A-3	-	Q6002	H-4
D6013	E-2	-	Q6003	H-4
D6014	H-4	-	Q6005	H-4
D6017	E-2	-	Q6009	H-3
D6018	H-4	-	Q6010	B-3
D6025	C-3	-	Q6011	B-3
D6032	H-3	-	Q6012	A-3
D6033	H-3	-	Q6013	B-4
D6035	D-4	-	Q6014	G-6
D6036	D-4	-	Q6015	F-6
D6037	C-4	-	IC	
D6038	C-6	-	IC6001	E-3
D6042	H-6	-	IC6004	I-2
D6043	H-5	-	IC6005	D-3
D6044	H-6	-	IC6006	D-3
D6045	H-5	-	IC6007	H-5
D6046	H-5	-	IC6008	C-4
D6047	H-6	-		

*: Refer to Terminal name of semiconductors in silk screen printed circuit (see page 46)

- AE Board -

AE BOARD

DIODE		*			
D2	B-5	⑨	Q105	D-8	①
D10	B-6	⑨	Q106	F-8	①
D11	C-6	⑨	Q107	E-8	①
D12	B-6	⑨	Q108	E-8	①
D16	B-6	⑨	Q109	E-8	①
D101	G-6	⑨	Q110	G-4	②
D102	D-5	⑨	Q111	H-3	②
D201	H-9	⑨	Q112	H-4	②
D202	H-3	⑨	Q113	G-9	②
D203	H-9	⑨	Q114	G-1	②
D204	F-2	⑨	Q115	E-8	①
D205	F-2	⑨	Q116	F-8	①
D206	G-8	⑨	Q120	F-6	①
D207	G-8	⑨	Q121	F-6	①
D208	H-9	⑨	Q122	E-6	①
D209	H-8	⑨	Q124	F-6	①
D210	H-9	⑨	Q125	F-1	②
D211	H-8	⑨	Q130	F-6	①
D212	F-2	⑨	Q201	H-9	①
D213	F-2	⑨	Q202	H-1	②
D214	G-7	⑨	Q203	G-3	②
D215	G-7	⑨	Q204	G-3	②
D216	H-4	⑨	Q211	E-9	②
D217	H-4	⑨	Q212	F-1	②
D218	H-4	⑨	Q213	E-1	②
D220	H-4	⑨	Q214	G-4	②
D221	H-4	⑨	Q215	F-1	②
D222	H-9	⑨	Q216	F-9	②
D223	H-2	⑨	Q217	H-1	②
D224	H-2	⑨	Q300	C-7	①
D225	H-3	⑨	Q301	D-6	②
D226	H-3	⑨	Q302	D-4	②
D227	H-1	⑨	Q303	D-4	②
D228	H-2	⑨	Q304	C-5	①
D231	F-1	⑨	Q305	A-6	①
D251	G-2	⑨	Q306	C-8	①
D303	D-7	⑨	Q307	D-7	①
D304	D-1	⑨	Q308	D-8	①
D320	D-8	⑨	Q309	B-8	①
D370	B-2	⑨	Q330	D-7	①
D1010	A-8	⑨	Q331	D-3	②
			Q1001	A-8	①
			Q1002	B-7	①
TRANSISTOR		*	IC		
Q1	B-2	②	IC1	B-4	
Q4	A-3	②	IC2	A-3	
Q15	A-7	①	IC3	A-4,A-6	
Q17	A-3	②	IC4	B-6	
Q18	H-4	②	IC102	E-7	
Q20	D-6	①	IC103	E-3	
Q21	D-4	②	IC201	H-1	
Q22	D-4	②	IC202	F-2	
Q23	D-6	①	IC204	F-9	
Q24	D-4	②	IC205	G-3	
Q25	C-4	②	IC206	F-1	
Q101	E-7	①	IC301	C-2	
Q102	E-7	①	IC302	C-7	
Q103	E-8	②	IC303	C-3	
Q104	E-2	②	IC1001	A-2	

*: Refer to Terminal name of semiconductors in silk screen printed circuit (see page 46)

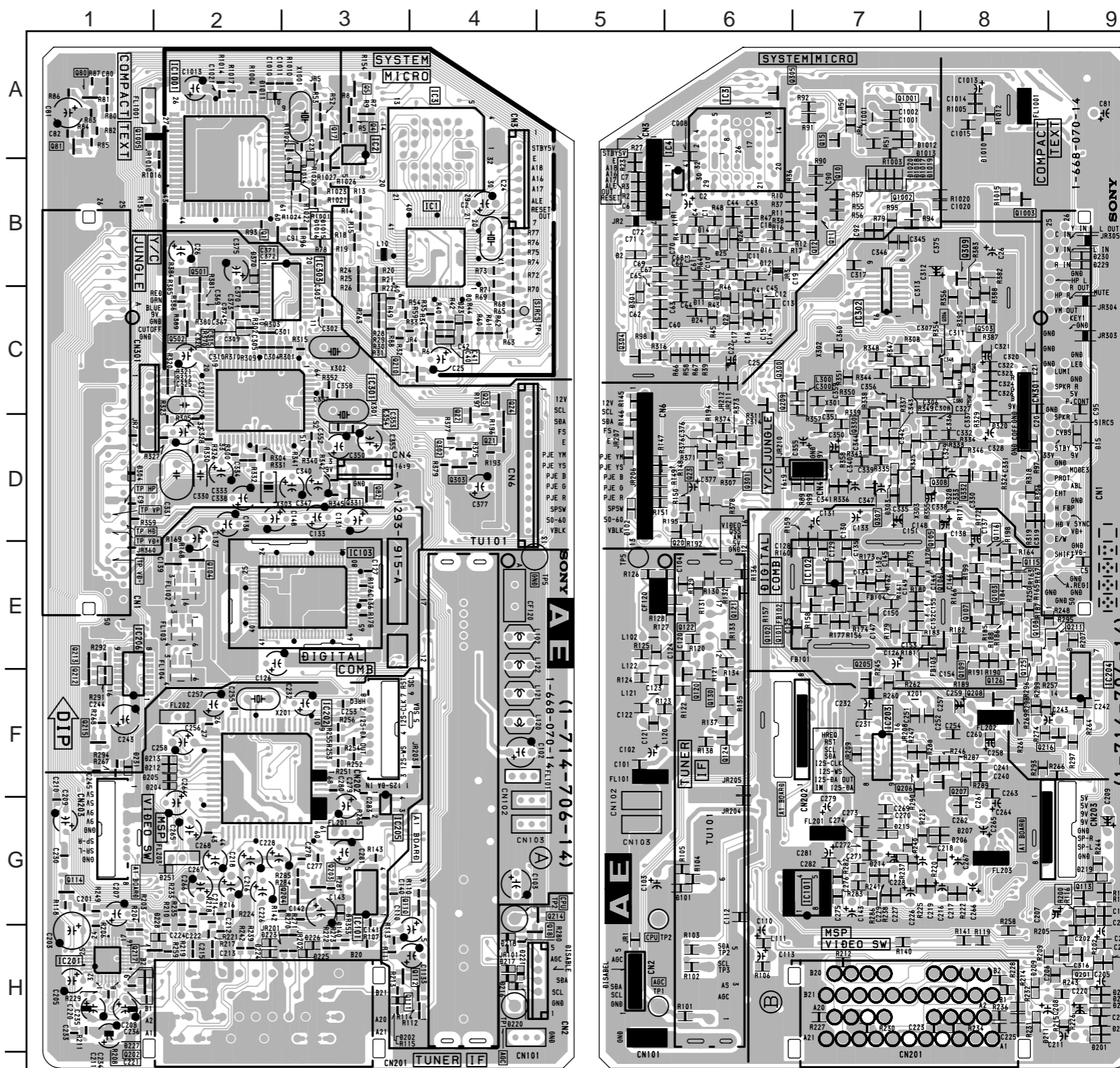

< Component Side >

< Conductor Side >

• AE(2/2) BOARD WAVEFORMS

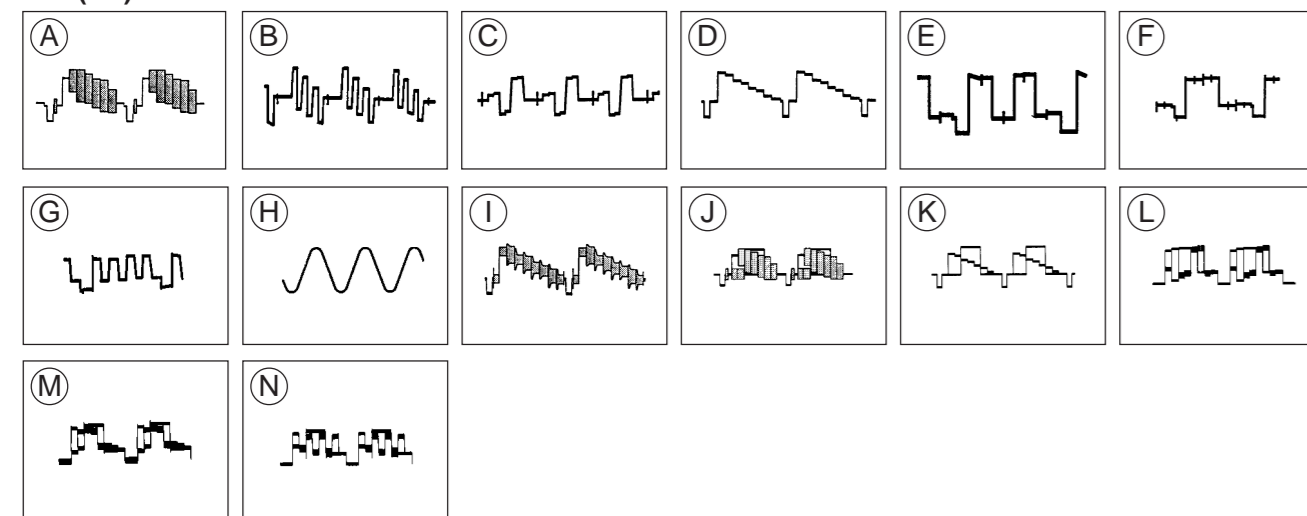

• WAVEFORMS AE(2/2) BOARD

CIRCUIT WAVEFORM REFERENCE	PAL	SECAM	NTSC
1	A 1.0Vp-p(H)	I 1.2Vp-p(H)	J 1.6Vp-p(H)
2	C 0.6Vp-p(H)	C 1.0Vp-p(H)	C 0.4Vp-p(H)
3	B 0.6Vp-p(H)	B 1.5Vp-p(H)	B 0.4Vp-p(H)
4	B 1.3Vp-p(H)	B 1.1Vp-p(H)	B 1.0Vp-p(H)
5	C 1.1Vp-p(H)	C 1.5Vp-p(H)	C 0.6Vp-p(H)
6	A 1.0Vp-p(H)	I 1.2Vp-p(H)	J 1.6Vp-p(H)
7	D 1.8Vp-p(H)	D 2.2Vp-p(H)	K 2.2Vp-p(H)
8	E 3.6Vp-p(H)	E 3.9Vp-p(H)	L 3.9Vp-p(H)
9	F 3.6Vp-p(H)	F 3.9Vp-p(H)	M 3.9Vp-p(H)
10	G 3.4Vp-p(H)	G 3.7Vp-p(H)	N 3.9Vp-p(H)
11	H 3.4Vp-p(1.5MHz)		
12	H 3.7Vp-p(2.49MHz)		

AE(2/2) BOARD IC VOLTAGE LIST

REF	NO.	VOL.	REF	NO.	VOL.	REF	NO.	VOL.
IC1	2	0	4	GND		36	8.9	
	3	5.0	5	4.4(4.6)		37	3.2	
	4	5.0	6	4.2(4.4)		38	3.4	
	5	5.0	7	4.9		39	4.7	
	6	0	8	5.0		40	4.2	
	7	0.8	1	5.0		41	2.4	
	8	0.1	2	*		42	GND	
	9	0.1	3	*		43	1.8	
	10	0	4	*		44	8.9	
	11	1.8	5	1.9		45	2.5	
	12	GND	6	*		46	4.0	
	13	5.0	7	2.8		47	3.2	
	14	2.4	8	2.5		48	4.4	
	15	2.3	9	2.2		49	6.4	
	16	4.6(5.0)	10	2.5		50	4.5	
	17	1.7	11	2.5		51	3.9(4.5)	
	18	0	12	2.5		52	4.2(3.9)	
	19	3.0	13	2.1		53	4.0(4.2)	
	20	0	14	2.0		54	5.0	
	21	2.5(2.9)	15	2.1		55	4.0	
	22	1.0	16	GND		57	4.2	
	23	3.5(3.2)	17	1.9(1.7)(1.9)		58	8.9	
	24	3.2	18	2.8		60	5.5(4.7)(5.6)	
	25	2.2(1.8)	19	2.9		61	2.4(1.4)	
	26	2.4	20	2.7		62	7.4(5.9)	
	27	2.6	21	3.0		63	GND	
	28	3.0	22	GND		64	5.3	
	29	2.7	23	GND	IC302	1	4.9	
	30	2.7	24	GND		3	GND	
	31	2.6	25	*		4	GND	
	32	2.7	26	*		8	4.6	
	33	2.7	27	*		8	GND	
	34	2.6	28	*		9	4.9	
	35	2.6	29	0.9		10	GND	
	36	3.0	30	0		31	3.1	
	37	2.5	31	5.0		12	3.0	
	38	2.8	32	5.0		14	1.4	
	39	2.2	1	5.0	IC4	1	1.4	
	40	2.8	2	GND		1.6(4.9)(1.2)		
	41	0.9(2.1)	3	5.0	IC303	5	8.1	
	42	5.0(3.0)	4	GND		6	GND	
	43	2.5(2.1)	1	1.6(4.9)(1.6)		9	3.5(3.2)	
	44	4.2(1.7)	2	GND		10	4.3	
	45	GND	3	GND		11	3.1	
	46	5.0	3	5.7(3.0)(5.7)		12	5.7(3.0)(5.7)	
	47	5.0	4	5.7(3.0)(5.7)		12	5.7(3.0)(5.7)	
	48	0	5	3.7		19	0.7	
	49	0	6	5.0		20	3.6	
	50	0	7	1.3		4	0.9	
	51	0.8	8	5.5		5	1.3	
	52	0.4(5)	9	GND	IC1001	6	1.6	
	53	0.4(4)	10	0.7		7	1.6	
	54	0.6(1.3)	11	0.1		9	GND	
	55	0.2(3)	12	5.5		10	0.9(1.1)	
	56	0	13	5.5		11	4.8	
	57	3.9	14	5.5		12	4.8	
	58	4.8	15	0		13	GND	
	59	0.8(0.1)	16	0		16	4.2	
	60	5.0	17	5.5		17	0.1	
	61	0	18	5.5		21	4.8	
	62	3.9	19	5.5		23	2.9	
	63	3.8(2.3)	19	5.5		25	4.2	
	64	GND	20	8.9		44	GND	
	65	0	21	4.4		49	GND	
	66	0	22	1.8(2.0)(1.8)		49	GND	
	67	0	23	4.4		55	GND	
	68	5.0	24	1.7(1.9)(1.7)		56	0	
	69	4.9	25	4.5		58	GND	
	70	0	26	1.6(1.9)(1.8)		59	GND	
	71	0	27	4.9(4.4)		60	GND	
	72	5.0	28	4.4(2.8)(3.5)		61	0	
	73	4.9	29	8.3		62	0	
	74	0.4(7)	30	0.6		63	0	
	75	5.0(4.6)	31	3.0		64	0	
	76	5.0(4.7)	32	3.0		66	4.3(4.8)(4.7)	
	77	5.0(3.0)	33	4.1		67	4.1(4.7)	
	78	0	34	4.0		68	3.5(3.0)(3.0)	
	79	0.8	35	4.6				
	80	5.0						
	1	GND						
	2	GND						
	3	GND						

*All voltage are in V.
 *Can not measured.
 *Pin numbers which are not defined are not used.

AE(2/2) BOARD TRANSISTOR VOLTAGE LIST

REF	VOL.	REF	VOL.
Q1	B 3.6	Q302	E 3.0
	E 3.0		C 5.7
Q4	B 0.4	Q303	E 5.1
	C 8.2		C 5.0
Q15	E 0.8	Q304	B 0
	C GND		C 5.0
Q17	E 1.4	Q305	E 0
	C GND		C 5.0
Q20	B 0.7	Q306	B 0
	C 4.9		C 0.2
Q21	E 0.2	Q307	E GND
	C 4.7		C 0
Q22	E 0.2	Q308	E GND
	C 4.8		C 3.4
Q23	B 0	Q309	B 0(4.9)
	C GND		C 3.6(0)
Q24	E 0.7	Q330	E 5.1(5.3)
	B 0		B 6.4
Q25	E 0.7	Q331	E 5.7
	C GND		C 8.9
Q300	E GND	Q1001	E GND
	B 3.7		C 0.1
Q301	E 3.0	Q1002	C 9.0
	C 7.5		C 5.3

All voltages are in V.

AE(2/2) BOARD : IC302 TDA4665T

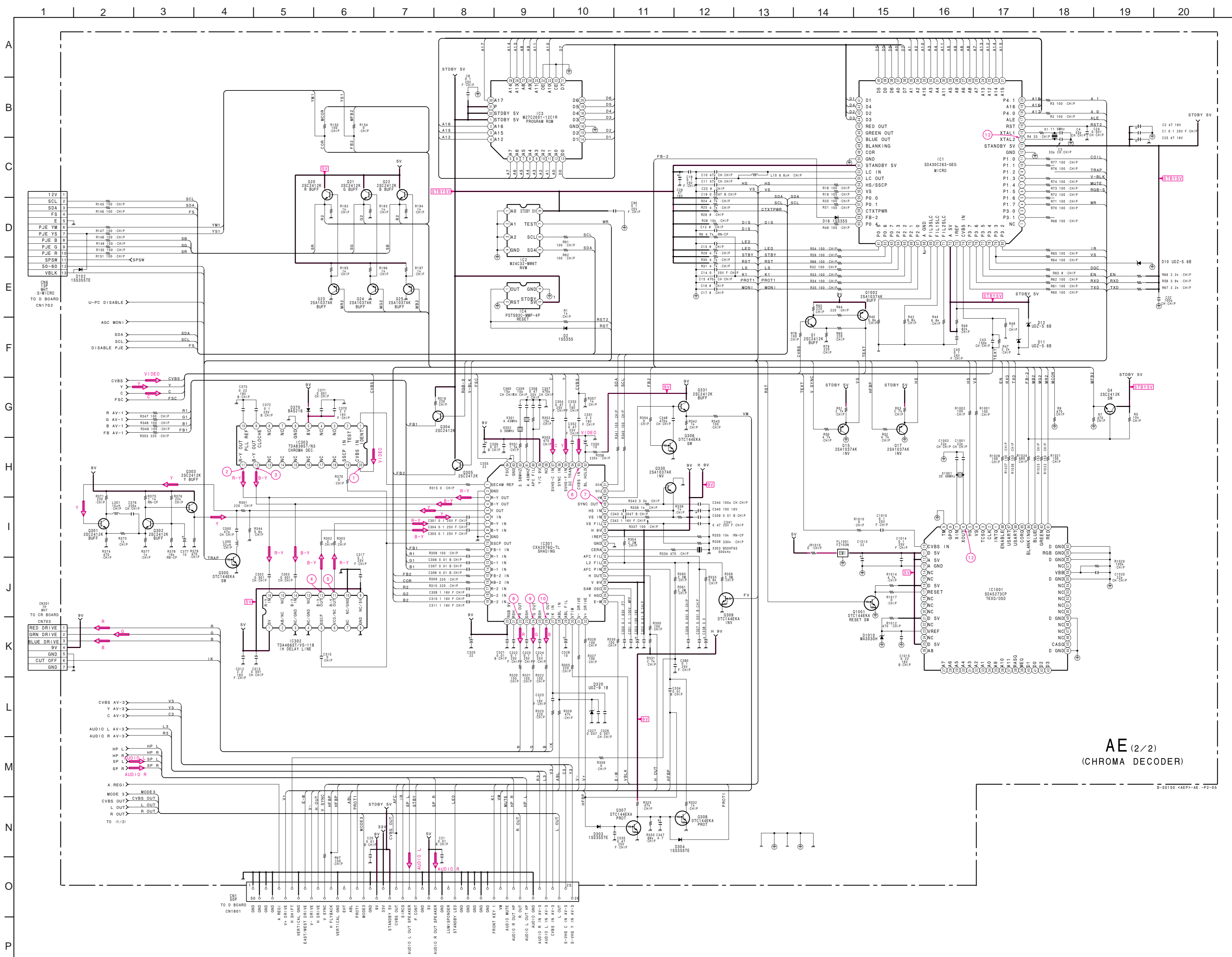
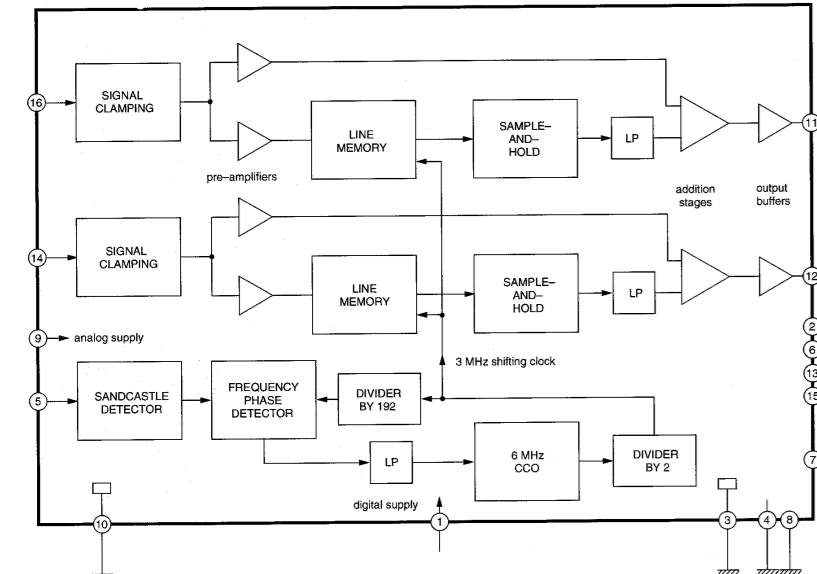

AE(2/2) (CHROMA DECODER)

© 1985 SONY ELECTRONICS INC.

1 2 3 4 5 6 7 8 9 10 11 12 13 14 15

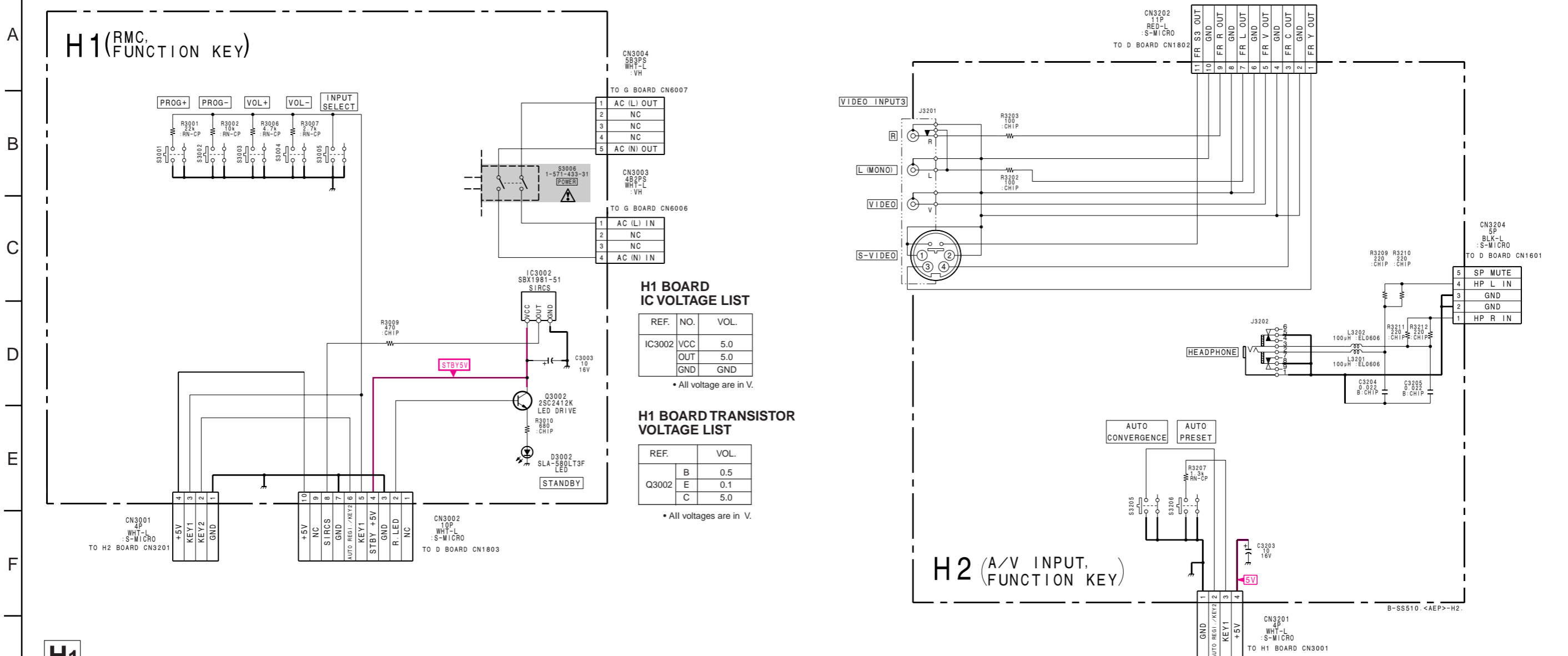

H1 [FUNCTION KEY, RMC]

- H1 Board -

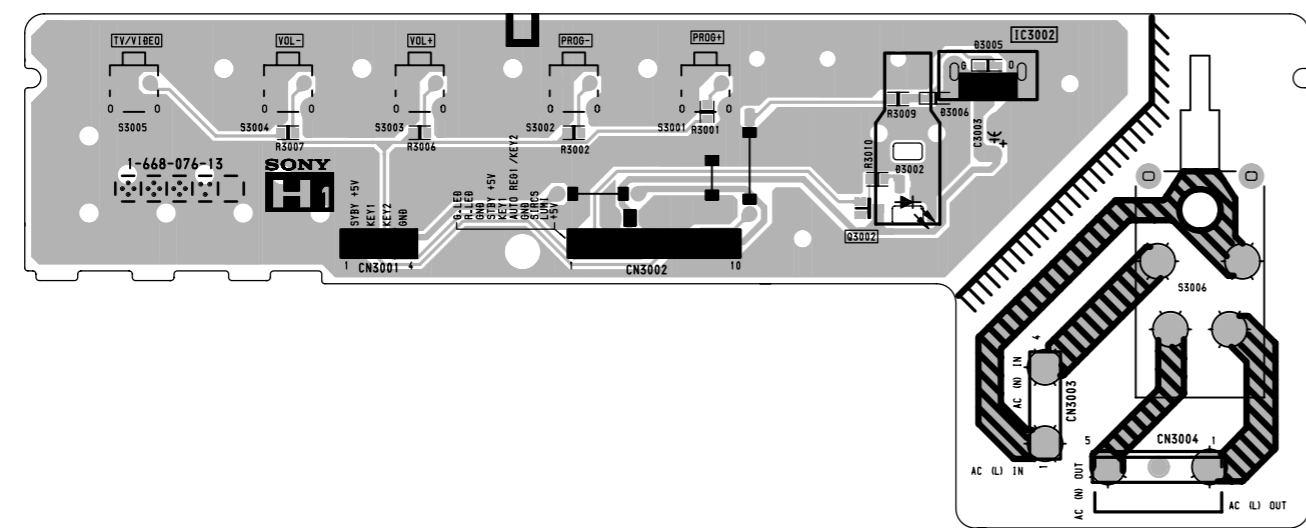

H2 [A/V INPUT, FUNCTION KEY]

- H2 Board -

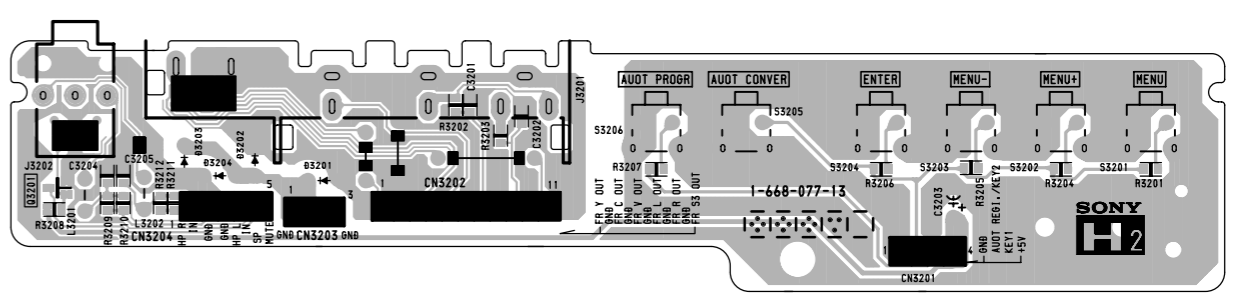

E BOARD

DIODE

D501	D-5
D502	D-5
D503	A-9
D504	D-5
D507	C-5
D508	E-8
D509	E-9
D510	H-6
D511	C-8
D512	A-9
D513	F-10
D514	H-11
D515	F-11
D517	C-10
D519	H-3
D520	F-11
D521	E-9
D522	E-3
D523	F-7
D524	D-6
D527	D-6
D701	C-1
D702	D-2
D820	D-2
D829	B-2
D835	E-5
D840	A-4
D842	A-4
D845	B-4
D846	B-4

TRANSISTOR

Q501	H-8
Q502	G-8
Q503	A-9
Q504	A-10
Q505	B-8
Q506	B-10
Q507	B-11
Q801	B-1
Q802	B-2
Q803	B-1
Q804	B-2
Q805	B-2
Q806	B-2
Q807	B-3
Q808	B-2
Q809	H-3
Q810	H-
Q811	C-3
Q812	C-3

IC

IC501	D-6
IC801	D-2
IC802	D-3
IC803	C-2
IC804	F-6
IC805	B-5
IC806	F-4
IC808	F-2
IC809	H-3
IC810	H-6
IC811	A-5
IC812	B-2
IC813	B-3

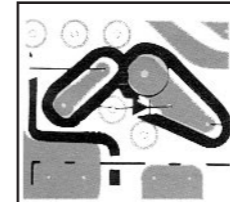
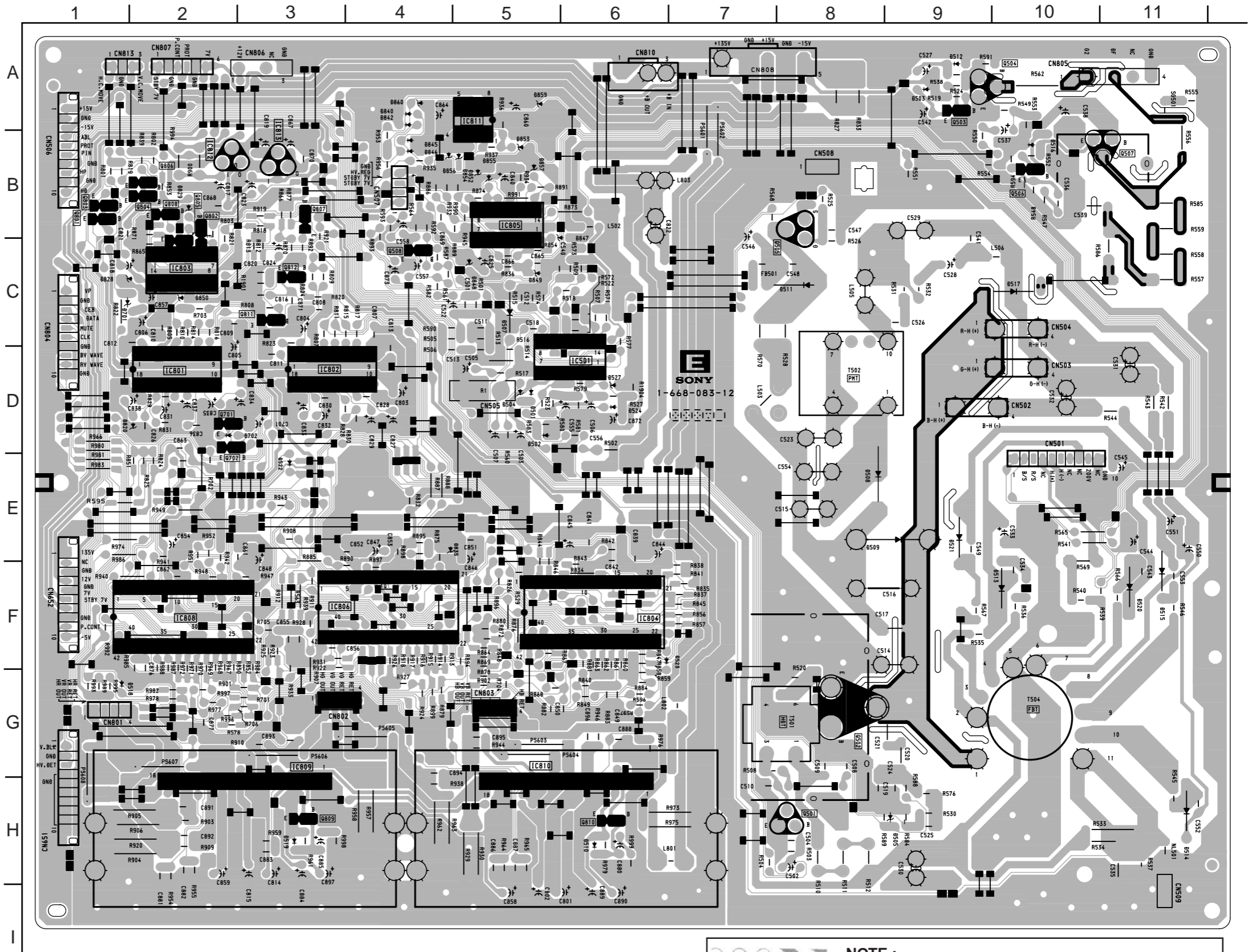

NOTE :
The circuit indicated as left contains high voltage of over 600 Vp-p. Care must be paid to prevent an electric shock in inspection or repairing.

• E BOARD WAVEFORMS

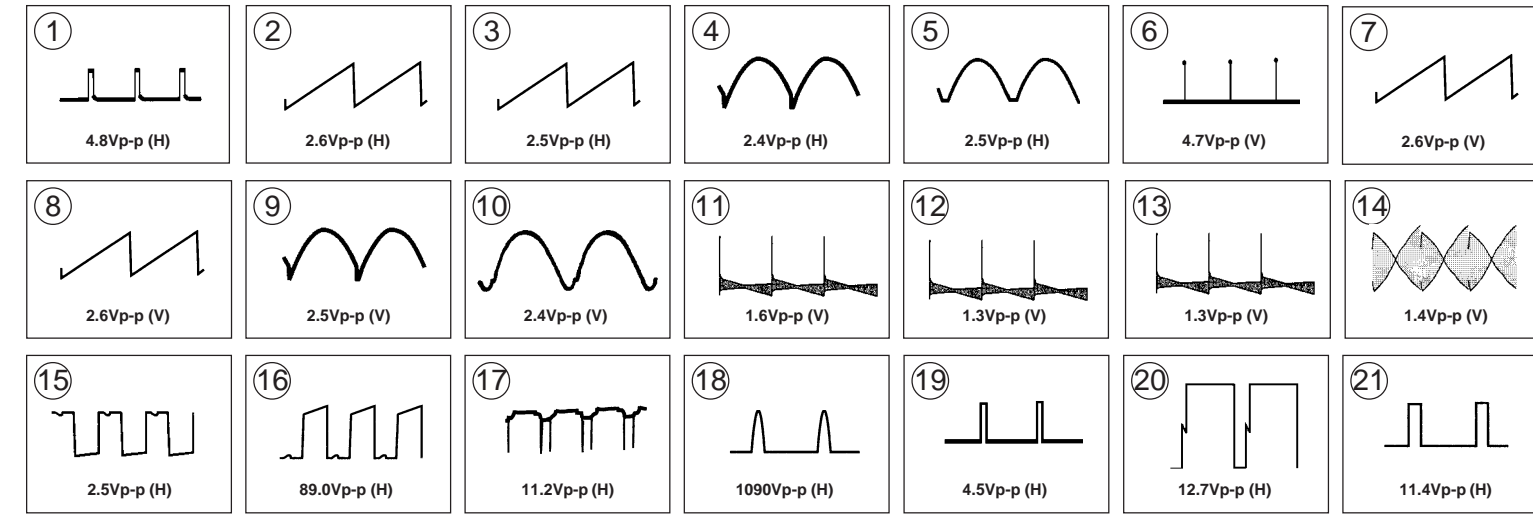

E BOARD : IC801,802 PA0053B

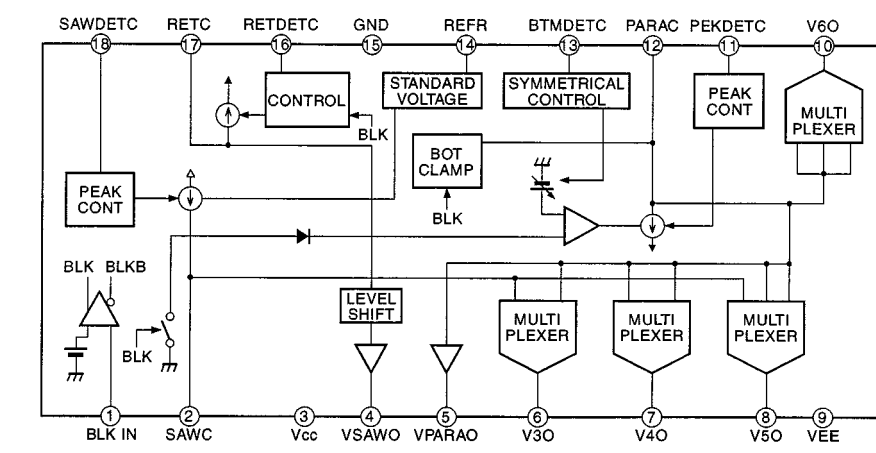

E BOARD : IC804,806,808 PM0002B

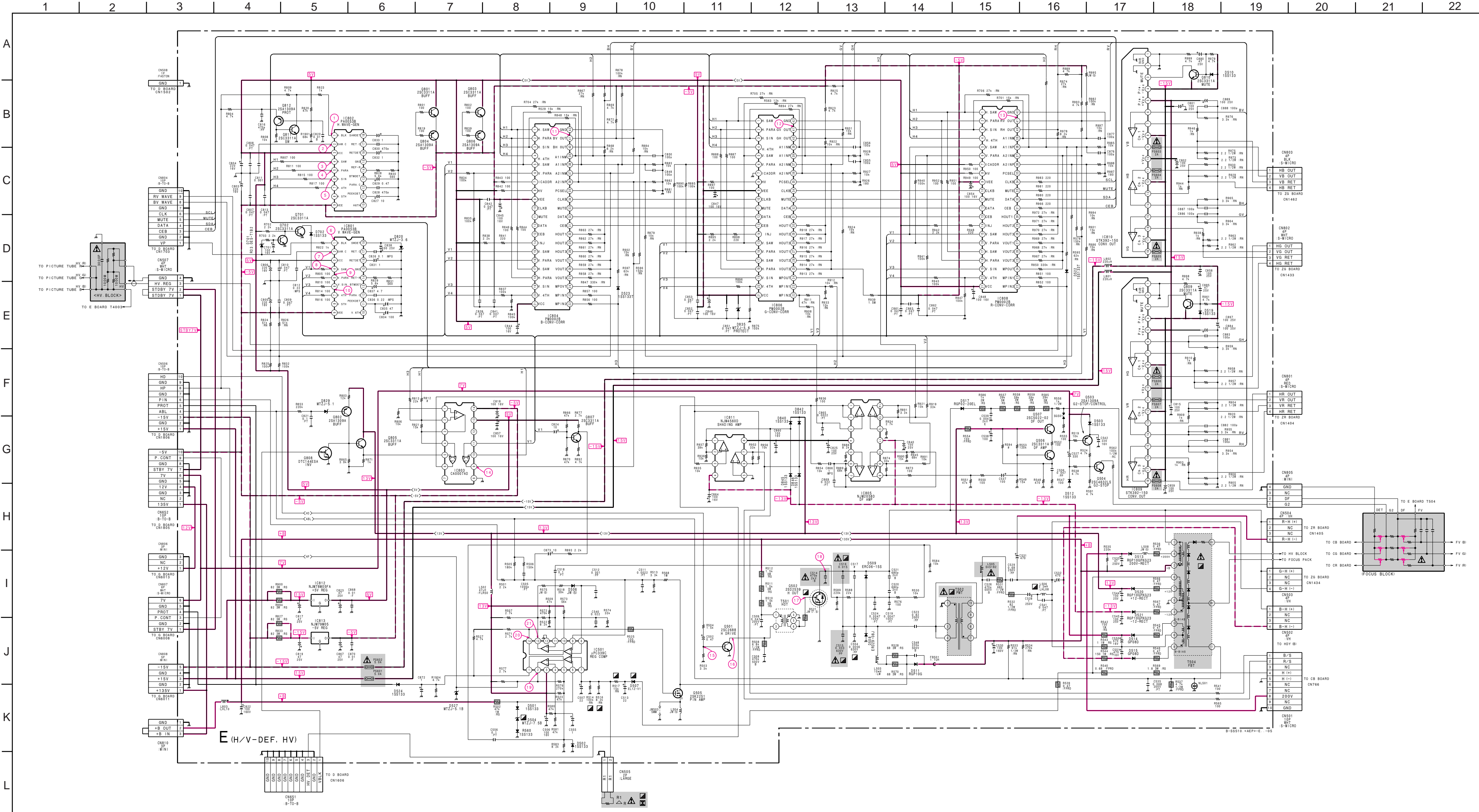
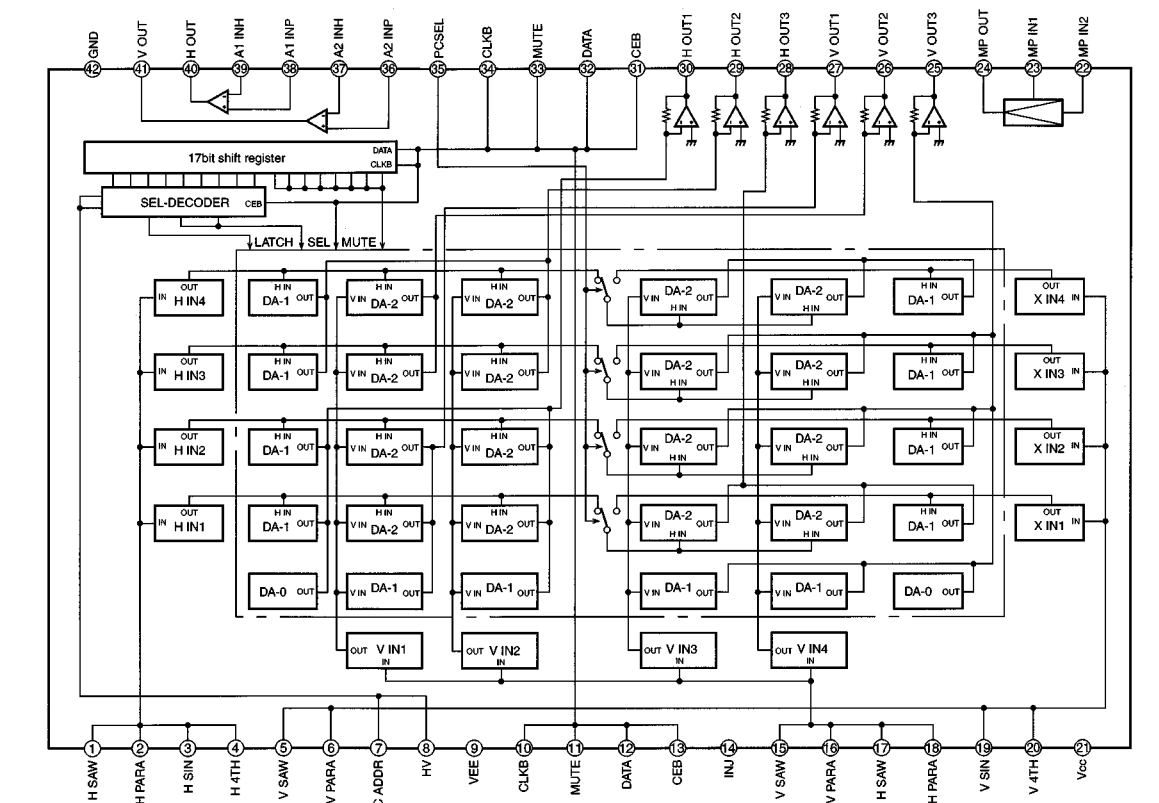

E BOARD IC VOLTAGE LIST

REF. NO.	VOL.	REF. NO.	VOL.	REF. NO.	VOL.
IC501	1 0.1	28 0.1	11 5.0		
	2 0.7	29 -0.1	12 0.2		
	3 12.2	30 -0.5	13 4.6		
	4 6.1	31 4.6	14 -2.0		
	5 1.8	32 0.2	15 0		
	6 8.3	33 5.0	16 0.8		
	7 7.9	34 4.7	17 0		
	8 1.6	35 0.1	18 -0.8		
	9 2.5	36 0.1	19 0.1		
	10 4.5	37 0	20 -0.5		
	11 1.8	38 0.1	21 5.0		
	12 GND	39 0	22 0		
	13 1.6	40 0.2	23 0		
	14 10.1	41 0	24 0.1		
	15 0.2	42 GND	25 -0.1		
IC801	2 1.1	IC805	1 7.4	26 0.1	
	3 5.0		2 7.4	27 0	
	4 0		3 7.2	28 0.1	
	5 -0.8		4 12.3	29 0.2	
	6 0		5 0	30 -0.2	
	7 -1.1		6 0	31 4.6	
	8 -5.0		7 0	32 0.2	
	9 0.5		8 -0.8	33 5.0	
	10 -0.9		9 0	34 4.7	
	11 0.3		10 0.1	35 0.1	
	12 1.2		11 -12.3	36 0.1	
	13 GND		12 0	37 0	
	14 -1.7		13 0	38 0.1	
	15 1.2		14 0.9	39 0	
	16 -1.5		1 0	40 0.2	
	17 0.4	IC806	2 -0.8	41 0	
	18 1.1		3 0	42 GND	
	19 5.0	IC809	4 -1.1	2 GND	
	20 0		5 0	3 -13.0	
	21 -0.8		6 -0.4	4 -14.2	
	22 -1.1		7 GND	5 14.3	
	23 -5.0		8 5.0	6 2.3	
	24 0.5		9 -4.9	7 0	
	25 -0.9		10 4.7	8 -14.2	
	26 0.3		11 5.0	9 -0.1	
	27 1.2		12 0.2	10 14.3	
	28 1.2		13 4.6	11 12.3	
	29 GND		14 -2.0	12 -14.2	
	30 -1.7		15 0	13 0	
	31 1.2		16 0.8	14 0	
	32 -1.5		17 GND	15 0.3	
	33 0		18 -0.8	16 0.3	
	34 0		19 0.1	17 -14.2	
	35 0		20 -0.5	18 0.4	
	36 0.1		21 5.0	19 0	
	37 0.9		22 0	2 GND	
	38 0		23 -0.4	3 -13.0	
	39 GND		24 0.1	4 -14.2	
	40 0		25 0.2	5 14.3	
	41 0		26 0.1	6 0	
	42 0		27 0	7 0	
	43 5.0		28 0.1	8 -14.2	
	44 -5.0		29 0	9 -0.1	
	45 0		30 0.3	10 14.3	
	46 -0.8		31 4.6	11 0.2	
	47 0		32 0.2	12 -14.2	
	48 -1.1		33 5.0	13 0.2	
	49 0		34 4.7	14 0.2	
	50 -0.4		35 0.1	15 0	
	51 4.9		36 0.1	16 0	
	52 5.0		37 0	17 -14.2	
	53 -4.9		38 0.1	18 -0.1	
	54 -2.0		39 0	19 0	
	55 0		40 0.2	2 0.1	
	56 -0.8		41 0	3 0	
	57 0		42 GND	4 1 -12.3	
	58 -0.8		1 0	5 GND	
	59 0.1		2 -0.8	6 0	
	60 -0.5		3 0	7 0	
	61 5.0		4 -1.1	8 12.3	
	62 0		5 0	9 0	
	63 -0.1		6 -0.4	10 GND	
	64 0.1		7 5.0	11 0.5	
	65 0.1		8 5.0	12 -11.3	
	66 0		9 -4.9	13 GND	
	67 0		10 4.7	14 -4.9	

E BOARD TRANSISTOR VOLTAGE LIST

REF.	VOL.
Q501	B -0.6
	E GND
	C -48.1
	B -0.1
Q502	E GND
	C 137.5
	B 6.9
Q503	E -0.8
	C 0
	B 0
Q504	E 0
	C 450.0
	B 1.7
Q506	E 1.2
	C 12.3
	B 12.3
Q507	E 12.3
	C 660
	B 4.1
Q508	E 3.6
	C 8.3
	B 0.7
Q701	E GND
	C 0
Q702	E GND
	C 4.8
	B 2.3
Q801	E 1.8
	C 5.0
	B 6.0
Q802	E 7.5
	C 1.6
	B 2.3
Q803	E 1.9
	C 5.0
	B 2.3
Q804	E 1.9
	C -5.0
	B 1.5
Q805	E 0.9
	C 12.3
	B 2.3
Q806	E 1.9
	C -5.0
	B 2.5
Q807	E 1.9
	C 4.0
	B 0.6
Q808	E GND
	C 1.5
	B -14.2
Q809	E -14.2
	C -13.1
	B -14.2
Q810	E -14.2
	C -13.1
	B 0.1
Q811	E GND
	C 0.4
	B 0.6
Q812	E 0
	C 0.1
Q505	G 10.2
	D 20.0
	S GND

All voltages are in V.

*All voltage are in V.
*Pin numbers which are not described are not used.

• D BOARD WAVEFORMS

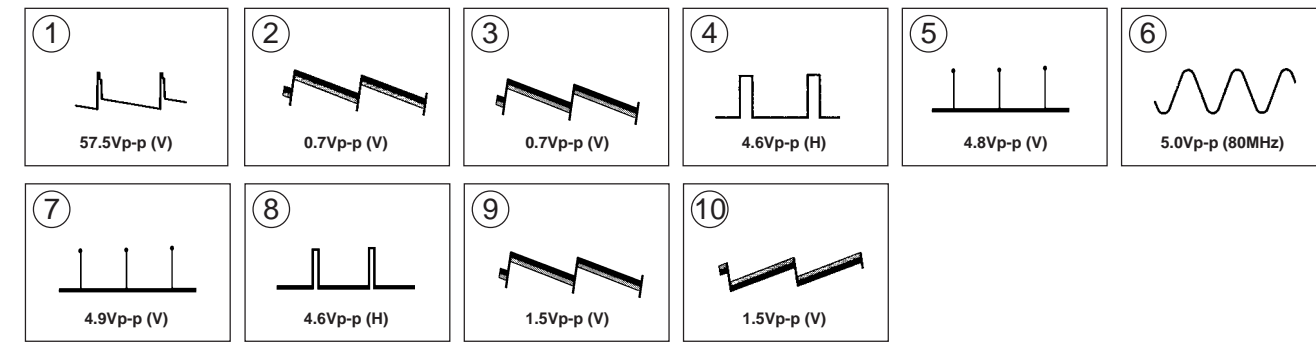

D BOARD : IC1702 ST24C08FM6TR

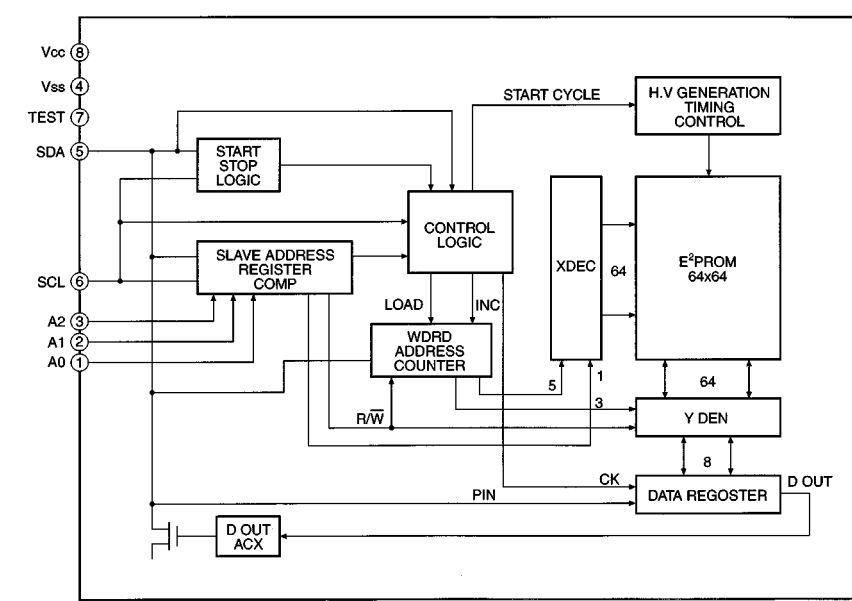

D BOARD IC VOLTAGE LIST

REF.	NO.	VOL.	REF.	NO.	VOL.	
IC1501						
1	1.1	32	0			
2	14.4	34	0.1			
3	-13.1	35	0.1			
4	-14.3	36	2.8			
5	0.2	37	2.8			
6	14.3	38	5.0			
7	1.1	39	5.0			
IC1502						
1	GND	40	GND			
2	0	42	4.9			
3	0	44	4.8			
4	0.1	45	4.8			
5	0.1	46	4.4			
6	0.1	47	4.7			
8	GND	48	4.3			
9	0	49	2.2			
10	0.1	50	2.3			
11	-0.4	51	2.3			
13	5.0	52	2.0			
14	-4.9	IC1702	1	GND		
IC1503						
1	3.1	2	GND			
2	3.1	3	GND			
3	3.1	4	GND			
4	GND	5	4.8			
5	3.0	6	4.8			
6	3.0	7	GND			
7	3.0	8	5.0			
8	5.0	IC1703	1	3.9		
9	0	2	23.0	3	GND	
10	0	4	-14.4	5	GND	
11	0	4	20.5	5	GND	
12	0	6	-23.0	6	0	
13	0	7	5.8	8	14.6	
14	0	IC1704	1	0.3		
15	4.1	2	0			
16	9.0	3	GND			
17	4.1	4	-14.4			
18	GND	5	GND			
19	0.6	6	0			
20	0	7	2.9			
21	0	8	14.6			
22	0.6	IC1706	2	GND		
23	0.2	3	GND			
24	0	4	4.9			
25	0.7	IC1802	1	0		
26	0.2	0	9.1			
27	5.0	IC1803	1	14.6		
28	GND	G	GND			
29	2.4	O	12.1			
30	2.5	IC1804	1	6.7		
31	0.2	G	GND			
32	11.7	O	5.0			
33	3.9	IC1805	1	4.8		
34	3.1	2	2.4			
35	0	3	2.4			
36	0	4	GND			
37	5.0	5	2.4			
38	5.0	6	2.4			
39	0.1	7	4.8			
40	0.1	8	9.0			

All voltage are in V.
Pin numbers which are not described are not used.

D BOARD TRANSISTOR VOLTAGE LIST

REF.	VOL.	REF.	VOL.
Q1501			
B	0.7	B	0.1
E	GND	E	0.2
C	0	C	5.0
Q1502			
B	14.5	B	0
E	0.2	E	0.2
C	2.0	C	5.0
Q1503			
B	0	B	0
E	GND	E	0.2
C	3.0	C	5.0
Q1505			
B	-0.5	B	0
E	0.2	E	0
C	14.4	C	5.0
Q1601			
B	0.7	B	0
E	GND	E	0
C	0	C	5.0
Q1602			
B	0.6	B	0
C	20.7	C	4.7
Q1603			
E	GND	E	GND
C	0	C	5.0
Q1604			
E	GND	E	5.0
C	1.1	C	0
Q1605			
B	0.8	B	4.6
E	GND	E	4.7
C	0.1	C	4.7
Q1607			
B	0.3	B	4.6
C	13.9	C	4.0
Q1608			
E	GND	E	GND
C	13.9	C	2.4
Q1609			
E	GND	E	1.8
C	0.3	C	5.0
Q1610			
B	13.9	B	5.0
E	13.7	E	4.3
C	0.1	C	9.0
Q1611			
B	0	B	2.4
E	GND	E	1.7
C	0	C	5.0
Q1612			
B	0.7	B	5.0
E	GND	E	4.4
C	0	C	9.0
Q1613			
E	GND	E	1.8
C	0	C	5.1
Q1614			
B	0.2	B	5.1
E	0.8	E	4.4
C	0.7	C	9.0
Q1615			
B	0	B	5.8
E	0	E	6.4
C	0.2	C	0.7
Q1616			
B	0.2	B	0.7
E	GND	E	GND
C	0.2	C	1.2
Q1617			
B	11.7	B	0
E	11.8	E	0
C	0.4	C	0.4

All voltages are in V.

Schematic diagram

← E board

Schematic diagram

D board →

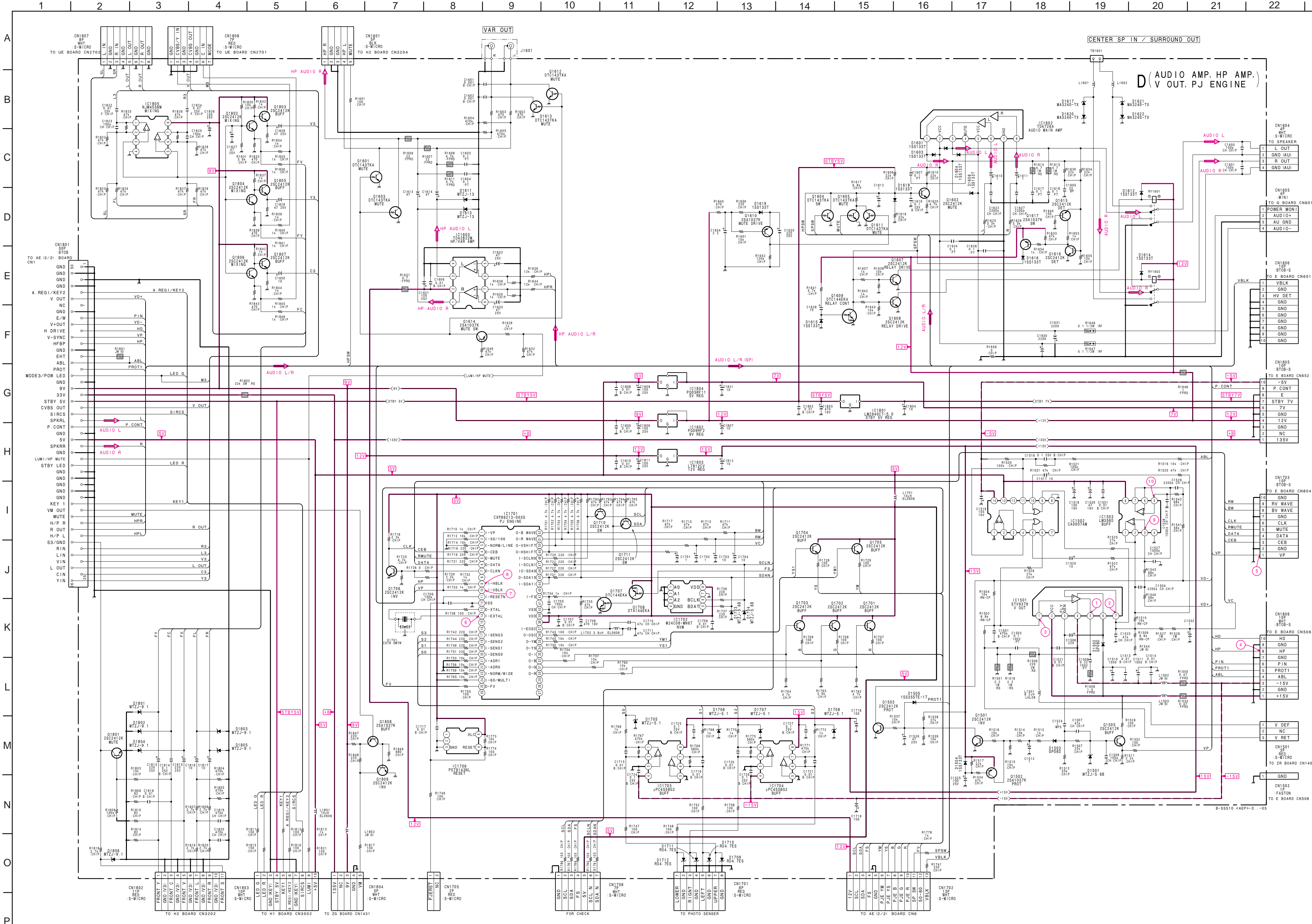

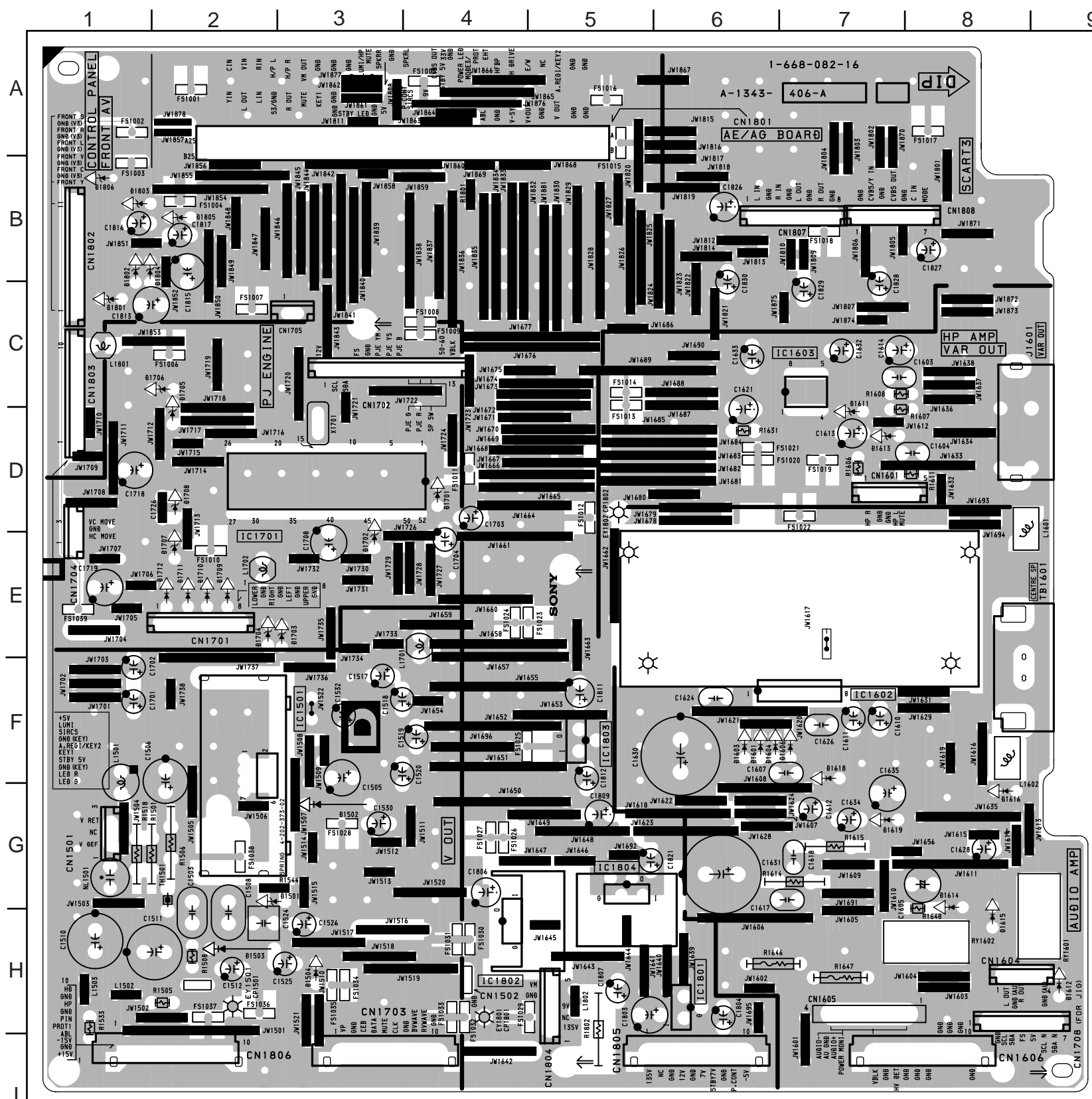

< Component Side >

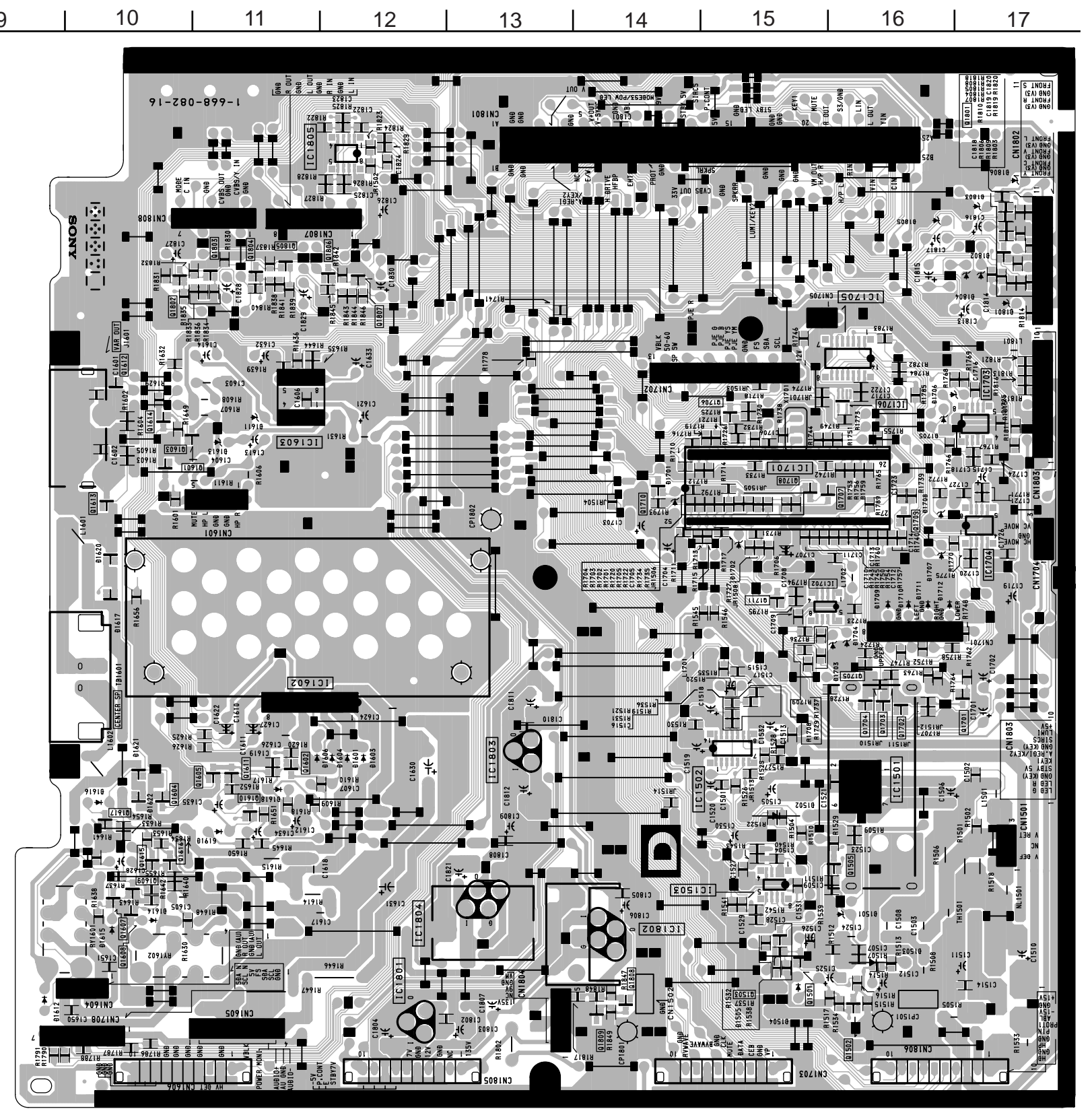

< Conductor Side >

D BOARD

DIODE		*	
D1501	G-2,G-16	-	Q1607 G-10
D1502	G-3,G-15	-	Q1608 G-10
D1503	H-2,H-16	-	Q1609 G-10
D1504	H-3,H15	-	Q1610 F-11
D1505	H-15	⊙	Q1611 F-11
D1601	F-6,F-12	-	Q1612 C-10
D1603	F-6,F-12	-	Q1613 D-10
D1604	F-6,F-12	-	Q1614 D-10
D1606	F-6,F-12	-	Q1615 G-10
D1611	D-7,D-11	-	Q1616 G-10
D1612	H-9	-	Q1617 F-10
D1613	D-7,D-11	-	Q1701 F-17
D1614	G-8,G-10	-	Q1702 F-16
D1615	H-8,H-10	-	Q1703 F-16
D1616	G-7,G-10	-	Q1704 F-16
D1618	F-7,F-11	-	Q1705 E-16
D1619	G-7,G-11	-	Q1706 C-15
D1620	E-10	⊙	Q1707 D-15
D1621	F-10	⊙	Q1708 D-15
D1622	G-10	⊙	Q1709 D-16
D1703	E-3,E-16	-	Q1710 D-14
D1704	E-2,E-16	-	Q1711 E-15
D1705	D-2,D-16	-	Q1801 B-17
D1706	C-2,C-16	-	Q1802 B-10
D1707	E-2,E-16	-	Q1803 B-11
D1708	D-2,D-16	-	Q1804 B-11
D1709	E-2,E-16	-	Q1805 B-11
D1710	E-2,E-16	-	Q1806 B-12
D1711	E-2,E-16	-	Q1807 B-12
D1712	E-2,E-16	-	Q1808 H-14
D1801	C-1,C-17	-	Q1809 H-14
D1802	B-1,B-17	-	
D1803	B-1,B-17	-	IC
D1804	B-1,B-17	-	IC1501 F-2,F-16
D1805	B-2,B-16	-	IC1502 F-15
D1806	B-1,B-17	-	IC1503 G-15
		-	IC1602 F-7,F-11
		-	IC1603 C-7,C-11
		-	IC1701 D-3,D-15
		-	IC1702 E-15
		-	IC1703 D-17
		-	IC1704 D-17
		-	IC1706 C-16
		-	IC1801 H-6,H-12
		-	IC1802 H-4,H-14
		-	IC1803 F-5,F-13
		-	IC1804 G-5,G-13
		-	IC1805 A-12
		-	
TRANSISTOR		*	
Q1501	H-15	⊙	
Q1502	H-16	⊙	
Q1503	H-15	⊙	
Q1505	G-16	⊙	
Q1601	D-10	⊙	
Q1602	F-11	⊙	
Q1603	D-10	⊙	
Q1604	F-10	⊙	
Q1605	F-10	⊙	

*: Refer to Terminal name of semiconductors in silk screen printed circuit (see page 46)

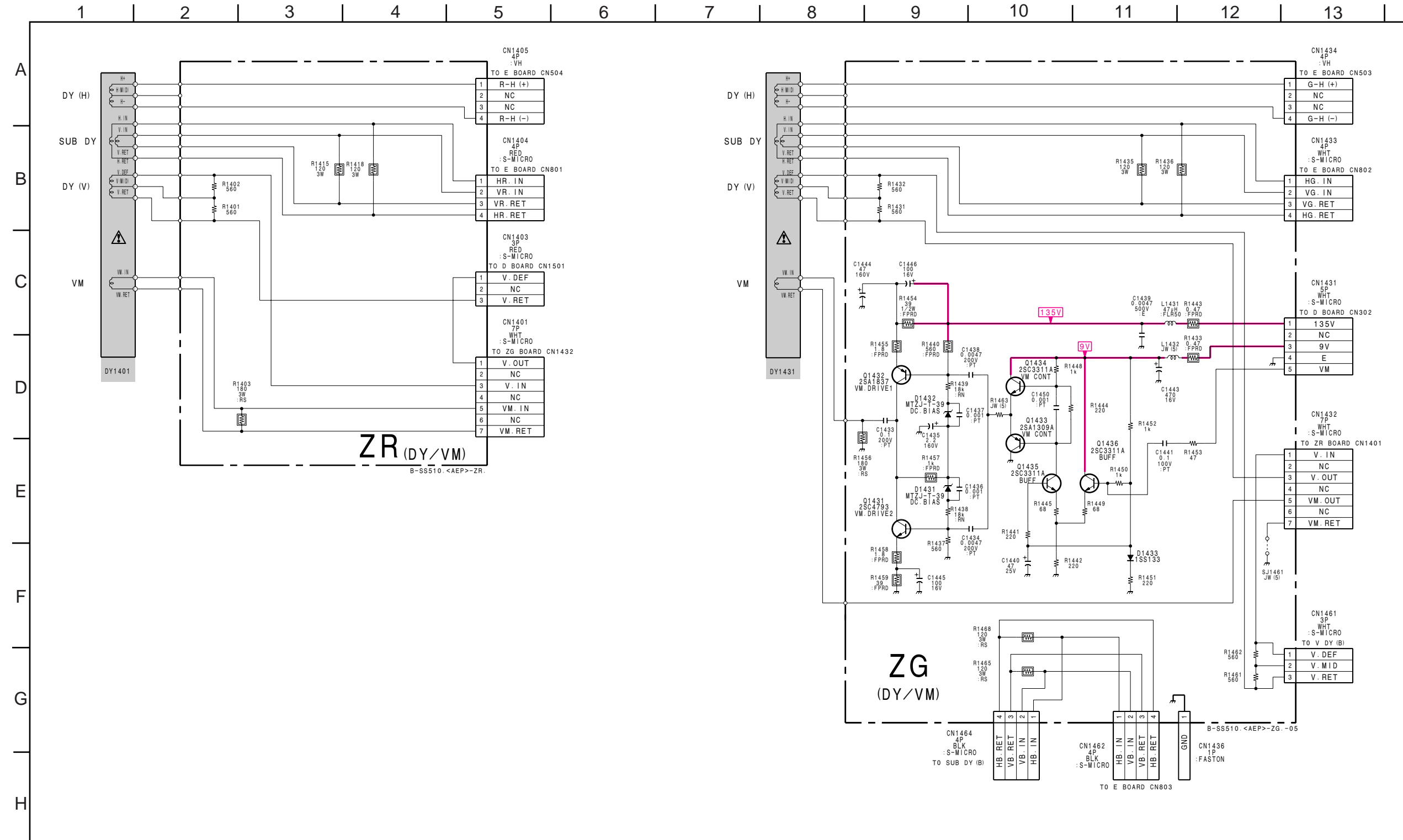

ZG BOARD TRANSISTOR VOLTAGE LIST

REF.	B	VOL.
Q1431	B	1.0
	E	0.5
	C	68.6
Q1432	B	134.5
	E	134.9
	C	68.6
Q1434	B	5.9
	E	6.1
	C	GND
Q1435	B	6.5
	E	6.1
	C	9.0
Q1436	B	2.2
	E	1.6
	C	9.0

All voltages are in V.

ZR [DY/VM]

- ZR Board -

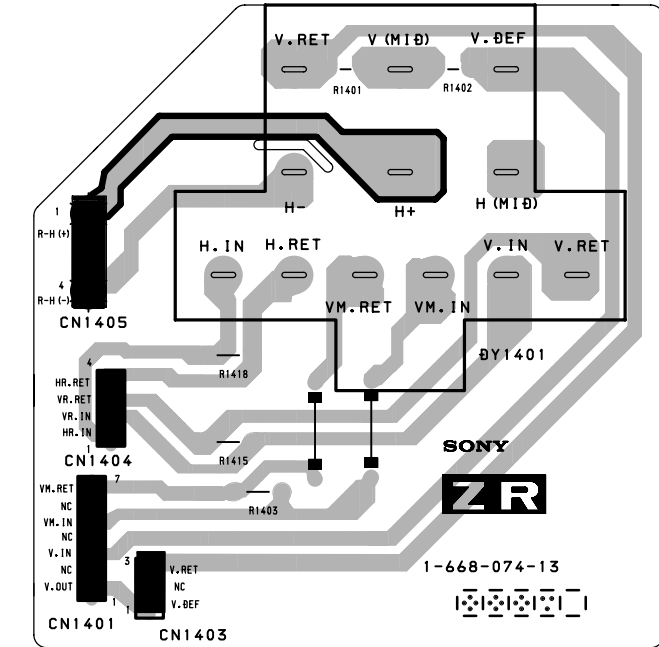

ZG [DY/VM]

- ZG Board -

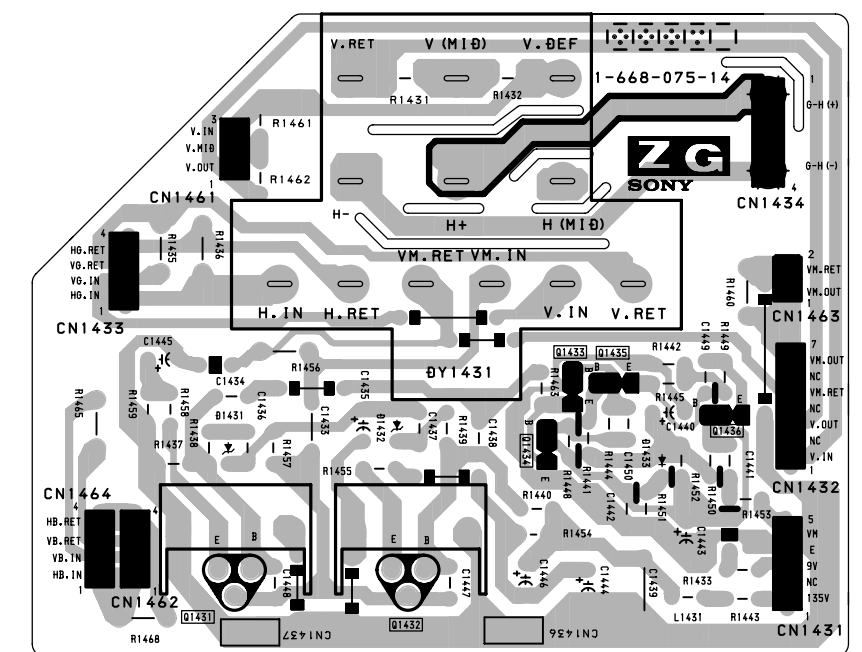

1 2 3 4 5 6 7 8 9 10 11 12 13 14 15

A
B
C
D
E
F
G
H
I
J

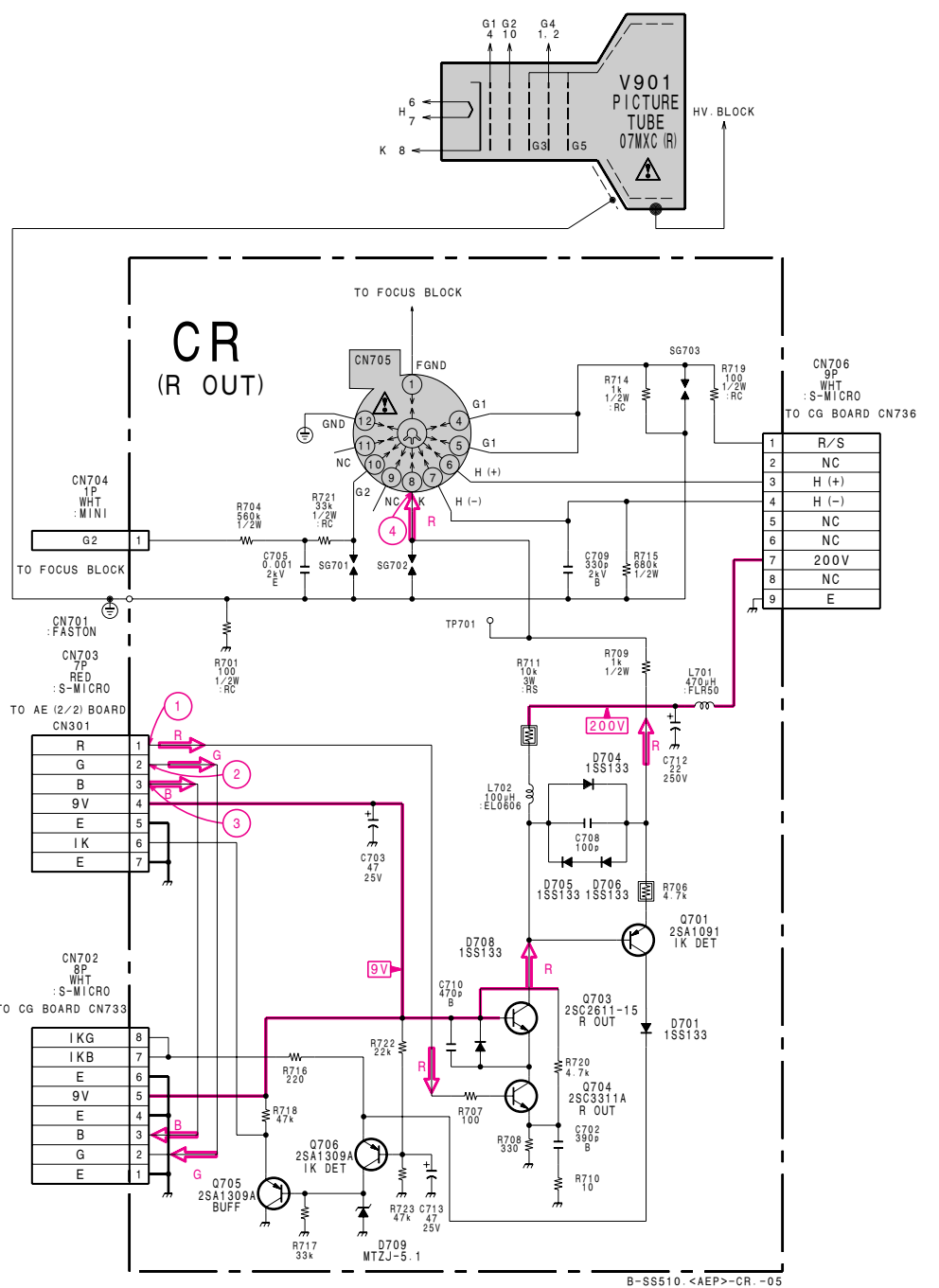

CR BOARD TRANSISTOR VOLTAGE LIST

REF.	VOL.
Q701	B 160.9
	E 156.9
	C 11.3
Q703	B 9.0
	E 8.5
	C 160.9
Q704	B 1.8
	E 1.2
	C 8.5
Q705	B 3.4
	E 3.2
	C GND
Q706	B 5.7
	E 10.9
	C 3.4

All voltages are in V.

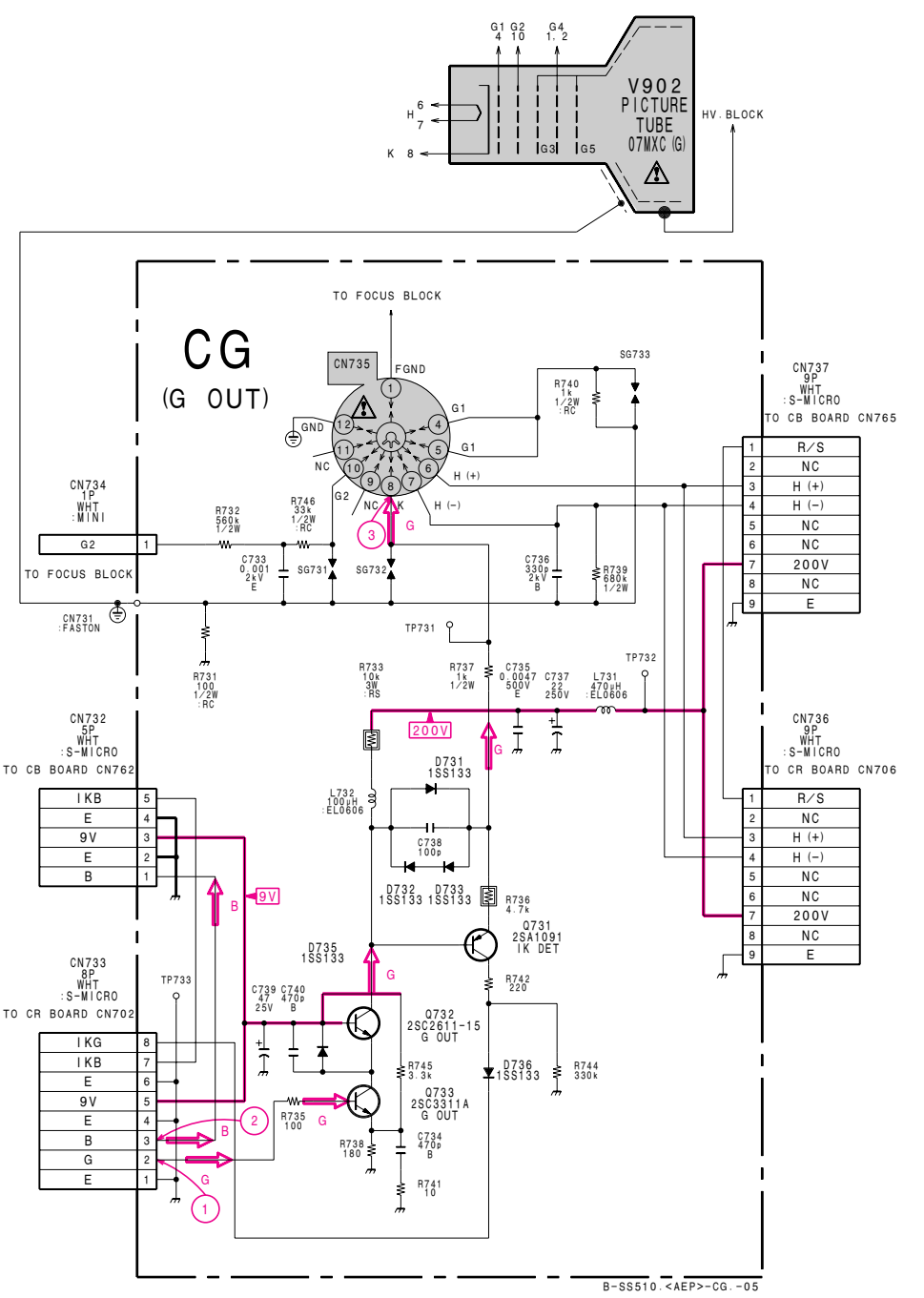

CG BOARD TRANSISTOR VOLTAGE LIST

REF.	VOL.
Q731	B 150.4
	E 144.4
	C 11.5
Q732	B 9.0
	E 8.5
	C 150.4
Q733	B 1.8
	E 1.3
	C 8.5

All voltages are in V.

• CR BOARD WAVEFORMS

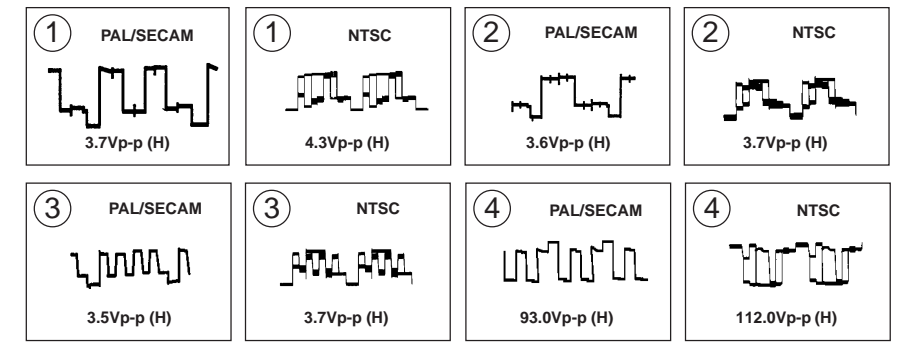

• CG BOARD WAVEFORMS

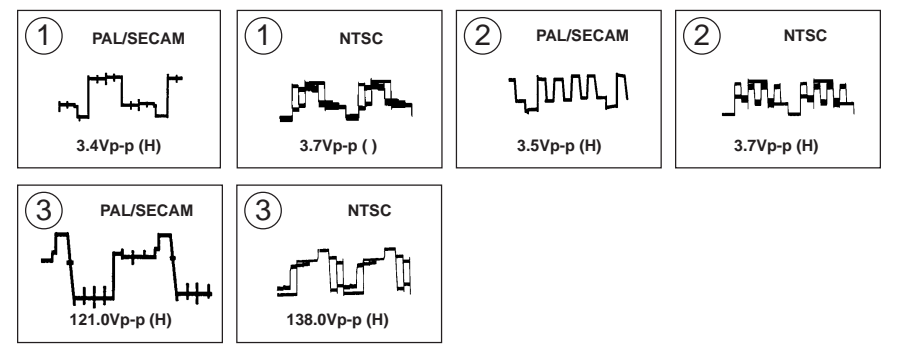

CR [R OUT]

- CR Board -

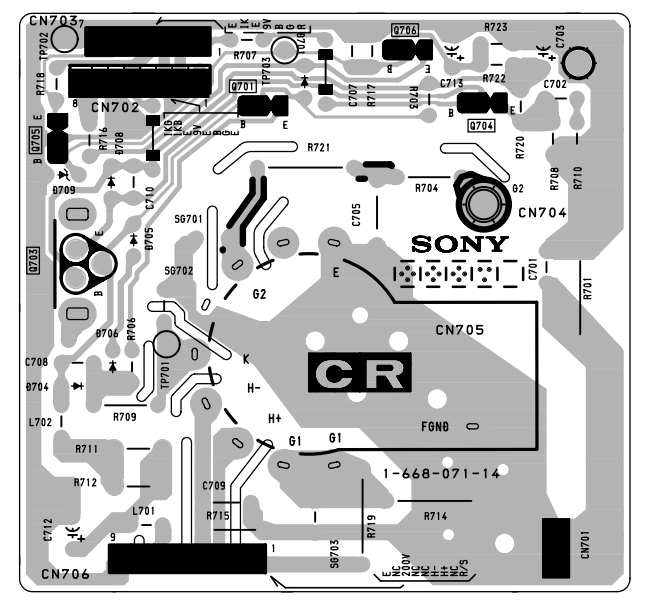

CG [G OUT]

- CG Board -

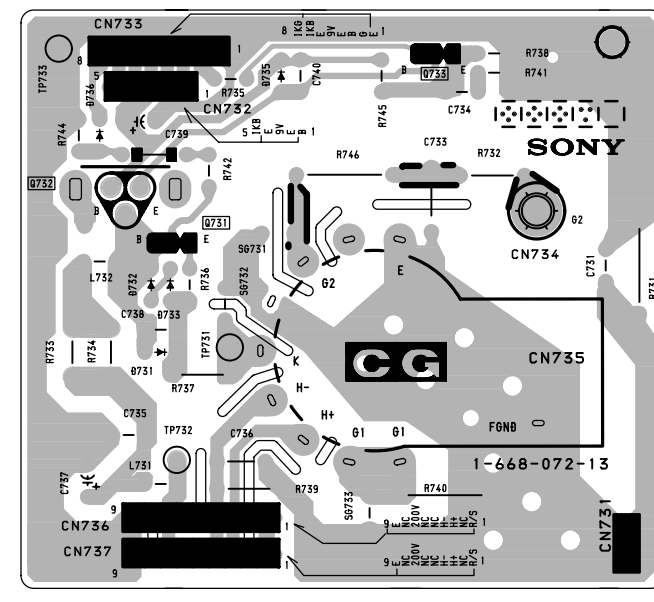

Schematic diagrams
← CG CR boards

Schematic diagrams
CB UE boards →

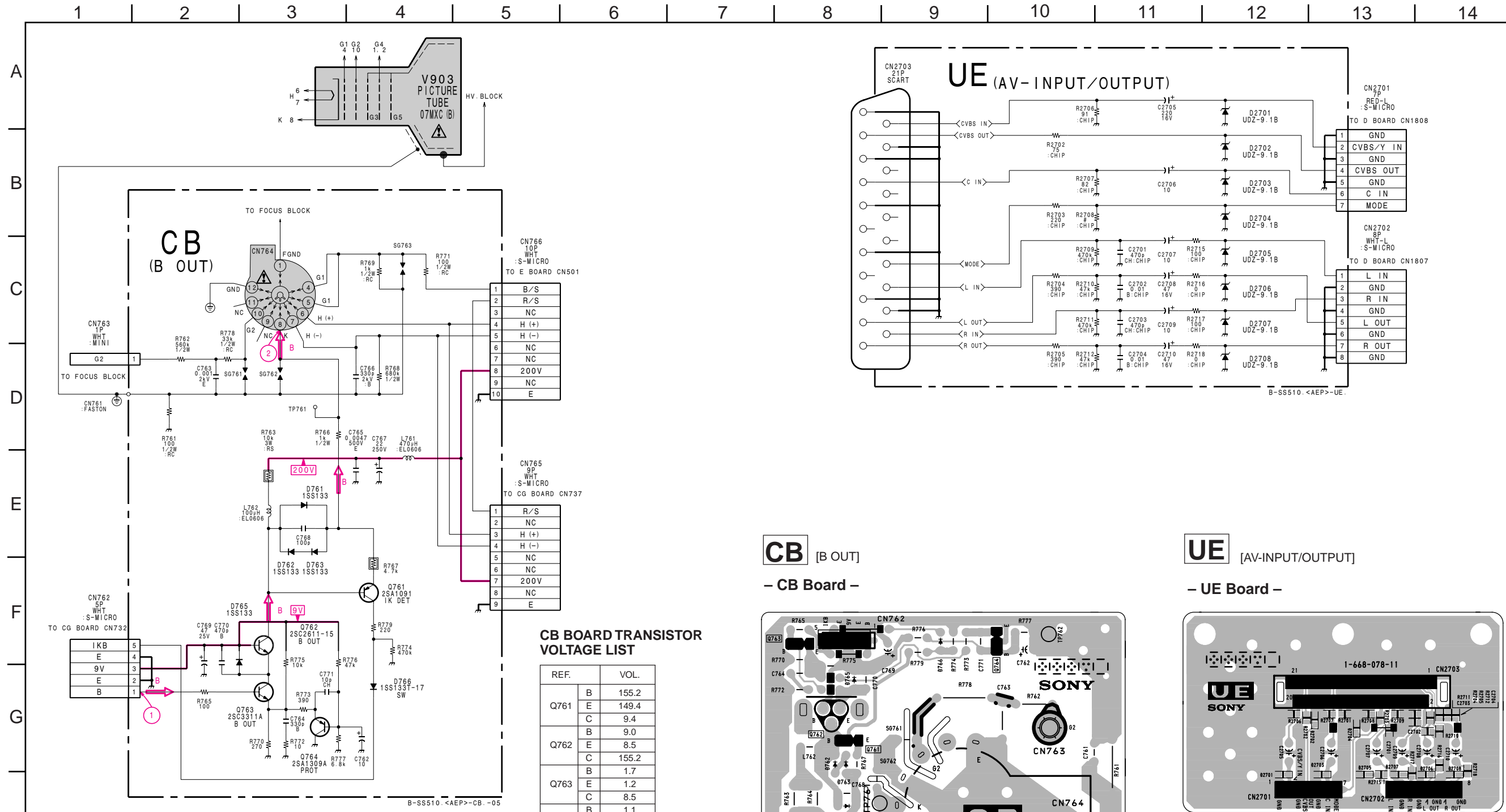

CB BOARD TRANSISTOR VOLTAGE LIST

REF.		VOL.
Q761	B	155.2
	E	149.4
	C	9.4
Q762	B	9.0
	C	155.2
	E	1.7
Q763	E	1.2
	C	8.5
	B	1.1
Q764	E	1.2
	C	GND
	B	GND

All voltages are in V.

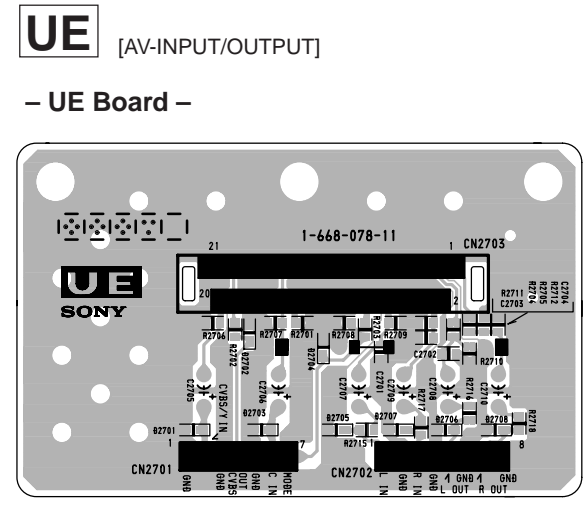
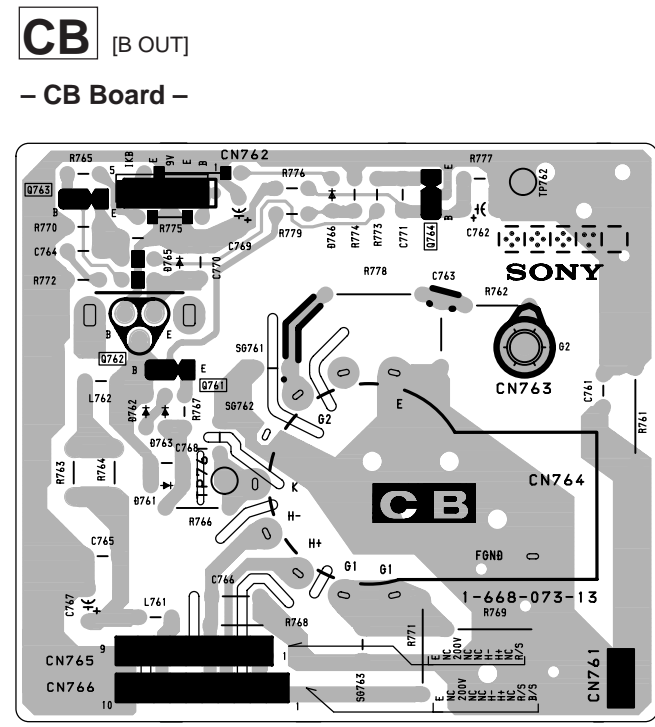
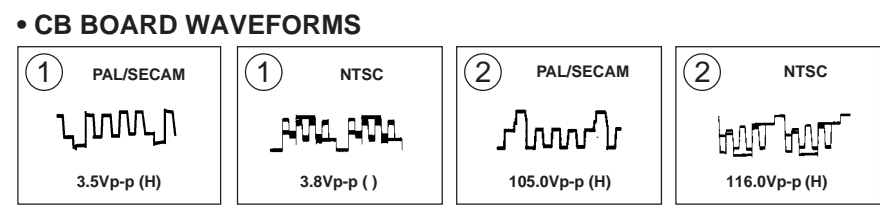

6-5. SEMICONDUCTORS

<p>CA0007AM M24C32-MW6T M24C08-MN6T μPC4558G2</p> <p>8pin</p>	<p>CXP86213-001S</p> <p>52pin</p>	<p>PM0002B</p> <p>42pin</p>	<p>STK392-150</p> <p>18pin</p>	<p>2SA1175-HFE 2SC2785-HFE</p> <p>LETTER SIDE</p>
<p>CA0007AD NJM2058D RC4560D TDA2822M TDA7264</p> <p>8pin</p>	<p>IR2112 μPC339C</p> <p>14pin</p>	<p>PQ05RF11</p> <p>12pin</p>	<p>TDA8395T/N3</p> <p>20pin</p>	<p>2SA1208 2SC1091-O</p> <p>LETTER SIDE</p>
<p>CXA1315M MC14052BDR2</p> <p>16pin</p>	<p>IR3M02A TDA4665T/V5-118</p> <p>16pin</p>	<p>PQ09RF2 TA7812S μPC2405HF</p> <p>12pin</p>	<p>M27C2001-12C1RW402</p> <p>32pin</p>	<p>2SB734-34</p> <p>LETTER SIDE</p>
<p>CXA2076Q-TL</p> <p>64pin</p>	<p>MSP3410D-PS-B4-T-ND SDA5273CP-GEG SDA5273-3CP</p> <p>68pin</p>	<p>PST593C-MMP-4P PST9143NL</p> <p>4pin</p>	<p>TOP209D</p> <p>8pin</p>	<p>2SC2611-15 2SC2688-LK</p> <p>LETTER SIDE</p>
<p>CXD2024AQ-T4 SDA30C263-GEG</p> <p>80pin</p>	<p>NJM7805FA NJM7905FA</p> <p>13pin</p>	<p>SBX1981-51</p> <p>3pin</p>	<p>DTA144EK-T146 DTC143TKA-T146 DTC144EK-T146 2SA1037K-T-146-R 2SA1162G 2SC1623-L5L6 2SC2412K-QR</p>	<p>2SC5022-02</p> <p>LETTER SIDE</p>
<p>CXD2044Q-TL</p> <p>80pin</p>	<p>PA0053B</p> <p>18pin</p>	<p>SE135N</p> <p>3pin</p>	<p>STV9379</p> <p>7pin</p>	<p>2SC4632LS-CB7 2SD2539 (LBSony-1)</p> <p>LETTER SIDE</p>
<p>PC123F2</p> <p>4pin</p>	<p>DTC144ESA-TP</p> <p>3pin</p>			

2SK2251-01-F119

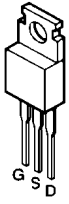

BAS216

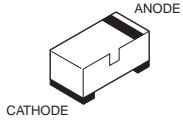

D10SC6M-4012

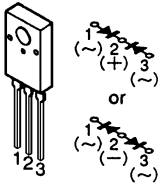

D2S4M
D4SBS4-F

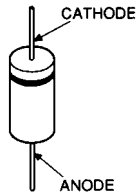

IRFI744G-LF

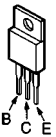

EL1Z
GP08D
MTZ-T-77-9.1A
S2L40F
UF4005PKG23

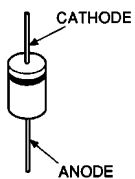

ERC06-15S
ERD29-08J
S2LA20F

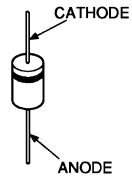

DTZ33B
DTZ6.8B
DTZ9.1
RD5.6S-B
UDZ-TE-17-6.8B
1SS355TE-17

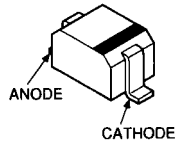

D6SB6OL
RBA-406B

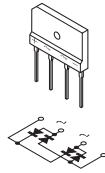

MA3030-H(TX)

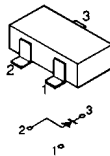

MA3240-TX

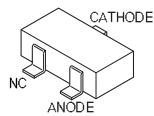

MTZJ-13
MTZJ-30B
MTZJ-7.5B
RD13ES-B2
RD20ES-B2
RD3.6ES-B1
RD39ES-B2
RD4.7ESB2
RD4.7ES-TIB
RD5.1ES-B1
RD5.1ES-B2
RD5.6ES-B2
RD7.5ES-B2
1SS119-25
1SS133T-77

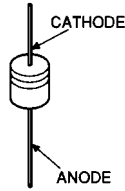

SLA-580LT3F

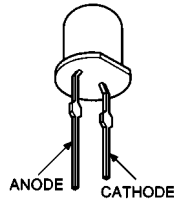

U05G

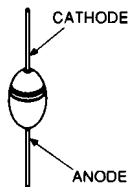

SECTION 7 EXPLODED VIEWS

The components identified by shading and mark \triangle are critical for safety. Replace only with part number specified.

NOTE:

- Items with no part number and no description are not stocked because they are seldom required for routine service.
- The construction parts of an assembled part are indicated with a collation number in the remark column.
- Items marked " * " are not stocked since they are seldom required for routine service. Some delay should be anticipated when ordering these items.

7-1. SCREEN AND COVER

- : +BVTP 4X12 7-685-661-79
- : +BVTP 4X16 7-685-663-79

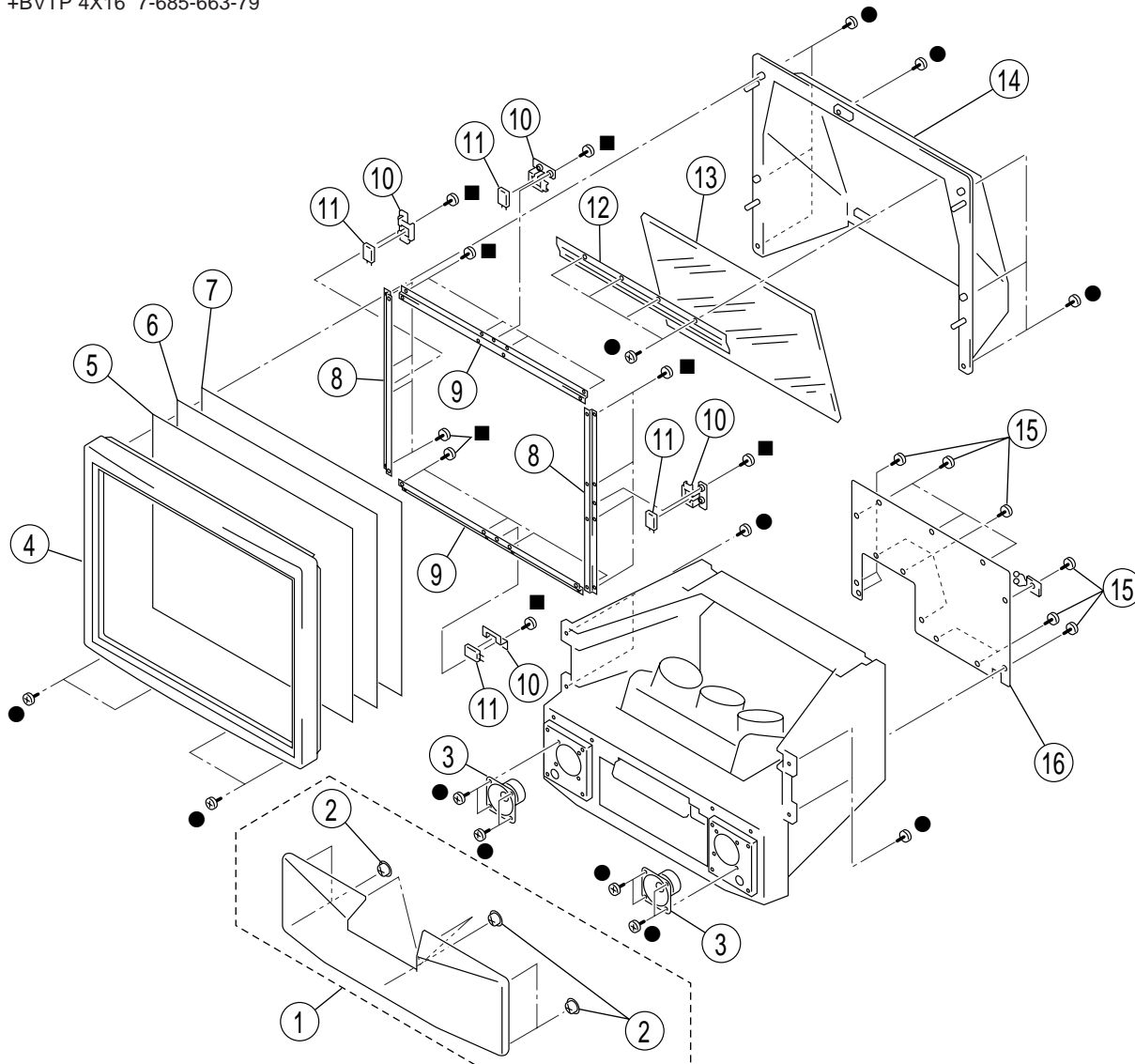

REF.NO.	PART NO.	DESCRIPTION	REMARK	REF.NO.	PART NO.	DESCRIPTION	REMARK
1	X-4036-953-1	GRILLE ASSY, SPEAKER	2	9	*4-063-160-01	HOLDER (H), SCREEN	
2	4-838-438-00	LATCH		10	*4-063-173-01	HOLDER, SENSOR	
3	1-505-426-11	SPEAKER (10.6CM)		11	1-528-864-11	BATTERY, SOLAR	
4	X-4036-951-1	BEZNET ASSY		12	*4-054-837-01	HOLDER, MIRROR	
5	4-063-365-11	SCREEN, CONTRAST		13	4-063-153-01	MIRROR (41)	
6	4-070-236-11	PLATE (L), DUFFUSION		14	*4-062-540-01	COVER, MIRROR	
7	4-070-358-11	PLATE (F), DUFFUSION		15	4-378-522-31	SCREW, TAPPING, HEXAGON HEAD	
8	*4-063-168-01	HOLDER (V), SCREEN		16	*4-063-177-01	BOARD (41), REAR	

The components identified by shading and mark ▲ are critical for safety. Replace only with part number specified.

7-2. CABINET AND PANEL BLOCK

- ▲ : +BVTP 3X12 7-685-648-79
- : +BVTP 4X16 7-685-663-71
- : +BVTP 4X16 7-685-663-79

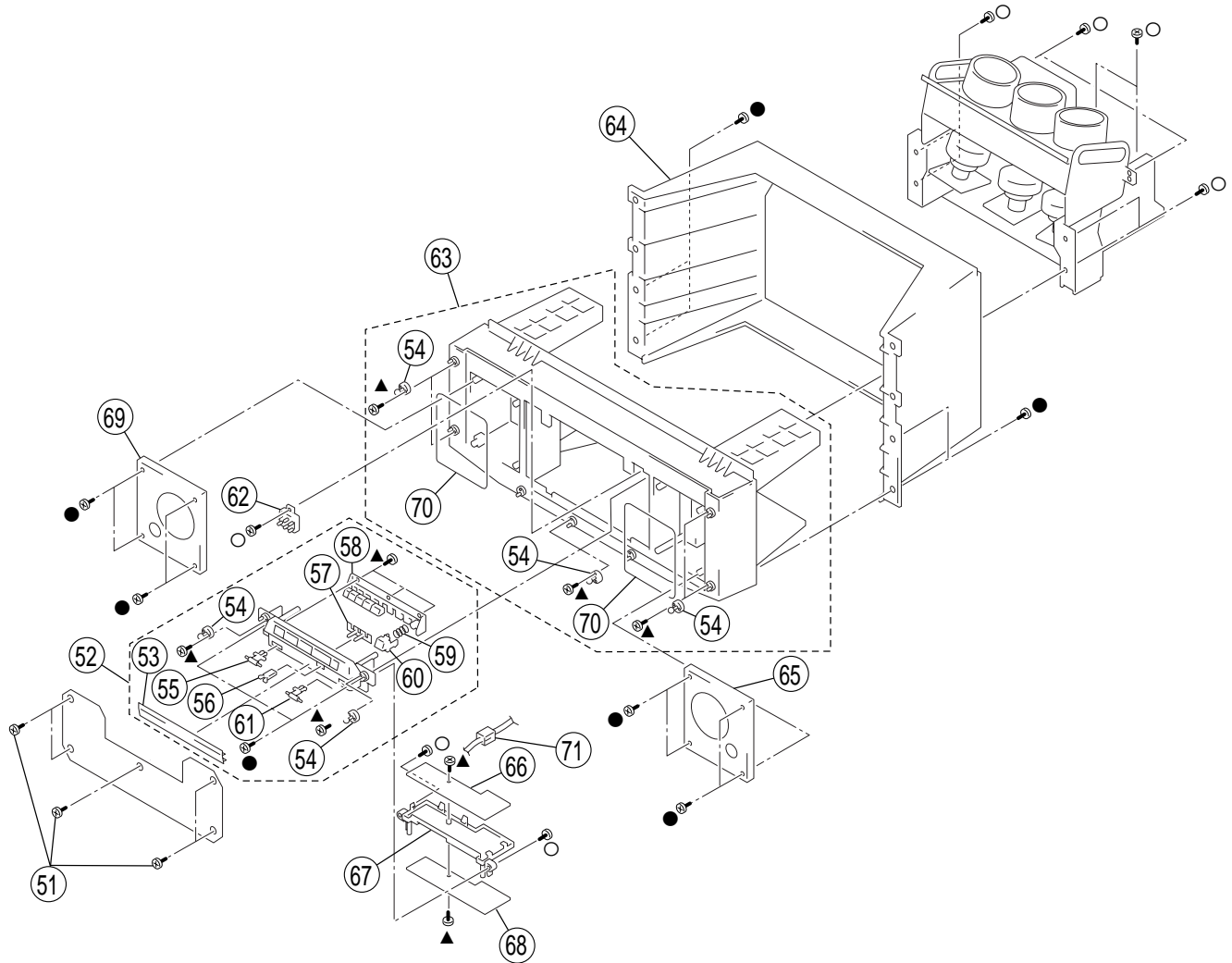

REF.NO.	PART NO.	DESCRIPTION	REMARK	REF.NO.	PART NO.	DESCRIPTION	REMARK
51	4-378-522-31	SCREW, TAPPING, HEXAGON HEAD		62	▲ 1-223-925-11	RESISTOR ASSY (HIGH-VOLTAGE)	
52	X-4036-952-1	PANEL ASSY, CONTROL	53-61	63	X-4036-954-1	CABINET ASSY, FRONT	54, 70
53	4-063-172-21	DOOR		64	4-062-539-01	CABINET (REAR)	
54	4-843-806-00	STRIKE		65	* 4-062-543-01	BOARD (R), BAFFLE	
55	3-703-035-11	SHAFT, LID		66	* A-1372-413-A	H1 BOARD, COMPLETE	
56	4-047-464-01	CATCHER, PUSH		67	* 4-063-174-01	BRACKET (H)	
57	4-063-164-01	GUIDE, LIGHT		68	* A-1375-171-A	H2 BOARD, COMPLETE	
58	4-063-170-11	BUTTON, MULTI		69	* 4-062-542-01	BOARD (L), BAFFLE	
59	4-202-964-01	SPRING		70	* 4-063-151-01	SPACER (SP)	
60	4-063-165-11	BUTTON, POWER		71	1-543-653-11	CORE ASSY, BEAD (DIVISION TYPE)	
61	4-045-250-21	DAMPER					

7-3. CHASSIS AND PICTURE TUBE

- ▲ : +BVTP 3X12 7-685-648-79
- : +BVTP 4X16 7-685-663-71
- : +BVTP 4X16 7-685-663-79

The components identified by shading and mark ▲ are critical for safety. Replace only with part number specified.

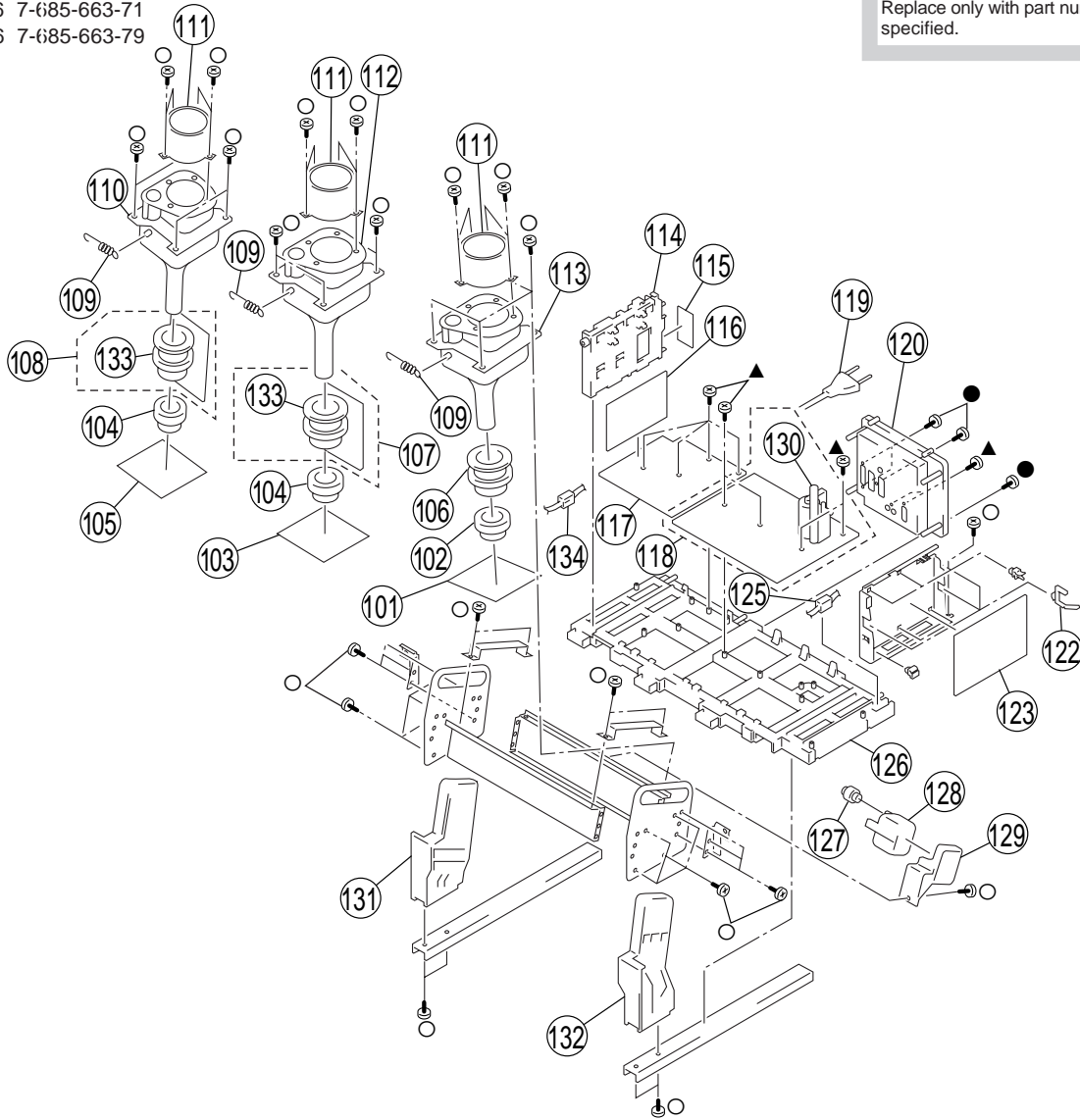

REF.NO.	PART NO.	DESCRIPTION	REMARK	REF.NO.	PART NO.	DESCRIPTION	REMARK
101	* A-1331-736-A	CB BOARD, COMPLETE		116	* A-1298-456-A	AE BOARD, COMPLETE (KP-41S5K)	
102	1-452-909-31	MAGNET ASSY, 4 POLE		116	* A-1298-457-A	AE BOARD, COMPLETE (KP-41S5R)	
103	* A-1331-735-A	CG BOARD, COMPLETE		117	* A-1346-678-A	D BOARD, COMPLETE	
104	▲ 1-452-790-11	NECK ASSY (NA-295)		118	* A-1346-679-A	E BOARD, COMPLETE	130
105	* A-1331-734-A	CR BOARD, COMPLETE		119	▲ 1-765-286-11	CORD, POWER (EXCEPT KP-41S5U)	
106	▲ 1-451-455-21	DEFLECTION YOKE (B)		119	▲ 1-776-860-11	CORD, POWER (KP-41S5U)	
107	* A-1390-785-A	ZG BOARD, COMPLETE	133	120	4-063-178-01	BOARD (EURO), TERMINAL	
108	* A-1390-784-A	ZR BOARD, COMPLETE	133	122	* 4-316-015-00	HOLDER, WIRE	
109	4-048-142-11	SPRING, EXTENSION		123	* A-1316-355-A	G BOARD, COMPLETE	
110	▲ A-1501-259-A	MECHASEAL ASSY (R), SLANT		125	4-389-201-11	HOLDER, AC CORD	
111	4-056-258-01	LENS (DELTA 78)		126	* 4-062-537-01	BRACKET, MAIN	
112	▲ A-1501-260-A	MECHASEAL ASSY (G), SLANT		127	4-373-137-01	CAP (Z), RUBBER	
113	▲ A-1501-261-A	MECHASEAL ASSY (B), SLANT		128	▲ 8-598-955-12	BLOCK ASSY, HIGH-VOLTAGE	
114	* 4-062-536-01	BRACKET (A)		129	* 4-063-176-01	HOLDER, HVR	
115	* A-1373-658-A	UE BOARD, COMPLETE		130	▲ 1-453-248-21	FBT ASSY(NX-4007//X4T4)	
116	* A-1298-318-A	E BOARD, COMPLETE (KP-41S5/41S5U/41S5B)		131	* 4-062-544-01	STAY (L), SIDE	
116	* A-1298-455-A	AE BOARD, COMPLETE (KP-41S5G)		132	* 4-062-545-01	STAY (R), SIDE	
				133	▲ 1-451-455-11	DEFLECTION YOKE (R, G)	
				134	1-543-653-11	CORE ASSY, BEAD (DIVISION TYPE)	

SECTION 8 ELECTRICAL PARTS LIST



NOTE:

The components identified by shading and mark Δ are critical for safety. Replace only with part number specified.

- The components identified by \blacktriangle in this manual have been carefully factory-selected for each set in order to satisfy regulations regarding X-ray radiation. Should replacement be required, replace only with the value originally used.
- Items marked " * " are not stocked since they are seldom required for routine service. Some delay should be anticipated when ordering these items.
- All variable and adjustable resistors have characteristic curve B, unless otherwise noted.

RESISTORS

- All resistors are in ohms
- F : nonflammable

When indicating parts by reference number, please include the board name.

CAPACITORS
PF : μ F

- There are some cases the reference number on one board overlaps on the other board. Therefore, when ordering parts by the reference number, please include the board name.

REF.NO.	PART NO.	DESCRIPTION	REMARK	REF.NO.	PART NO.	DESCRIPTION	REMARK
	* A-1298-318-A	AE BOARD, COMPLETE ***** (KP-41S5/41S5B/41S5U)		C122	1-163-137-00	CERAMIC CHIP 680pF	5% 50V
	* A-1298-455-A	AE BOARD, COMPLETE (KP-41S5G) *****		C123	1-163-113-00	CERAMIC CHIP 68pF	5% 50V
	* A-1298-456-A	AE BOARD, COMPLETE (KP-41S5K) *****		C124	1-163-038-00	CERAMIC CHIP 0.1 μ F	25V
	* A-1298-457-A	AE BOARD, COMPLETE (KP-41S5R) *****		C125	1-164-232-11	CERAMIC CHIP 0.01 μ F	10% 50V
	1-750-797-11	SOCKET, PLCC		C126	1-126-933-11	ELECT 100 μ F	20% 16V
	<CAPACITOR>			C127	1-164-232-11	CERAMIC CHIP 0.01 μ F	10% 50V
C1	1-163-038-00	CERAMIC CHIP 0.1 μ F	25V	C128	1-164-232-11	CERAMIC CHIP 0.01 μ F	10% 50V
C2	1-104-664-11	ELECT 47 μ F	20% 16V	C129	1-163-089-00	CERAMIC CHIP 6pF	0.5pF 50V
C3	1-163-239-11	CERAMIC CHIP 33pF	5% 50V	C130	1-164-232-11	CERAMIC CHIP 0.01 μ F	10% 50V
C4	1-163-239-11	CERAMIC CHIP 33pF	5% 50V	C131	1-104-664-11	ELECT 47 μ F	20% 16V
C8	1-163-038-00	CERAMIC CHIP 0.1 μ F	25V	C132	1-164-232-11	CERAMIC CHIP 0.01 μ F	10% 50V
C10	1-163-243-11	CERAMIC CHIP 47pF	5% 50V	C133	1-126-963-11	ELECT 4.7 μ F	20% 50V
C11	1-163-243-11	CERAMIC CHIP 47pF	5% 50V	C134	1-164-232-11	CERAMIC CHIP 0.01 μ F	10% 50V
C14	1-163-038-00	CERAMIC CHIP 0.1 μ F	25V	C135	1-164-232-11	CERAMIC CHIP 0.01 μ F	10% 50V
C15	1-163-133-00	CERAMIC CHIP 470pF	5% 50V	C136	1-164-232-11	CERAMIC CHIP 0.01 μ F	10% 50V
C18	1-163-038-00	CERAMIC CHIP 0.1 μ F	25V	C137	1-104-664-11	ELECT 47 μ F	20% 16V
C19	1-163-017-00	CERAMIC CHIP 0.0047 μ F	10% 50V	C138	1-126-964-11	ELECT 10 μ F	20% 50V
C20	1-164-232-11	CERAMIC CHIP 0.01 μ F	10% 50V	C139	1-164-232-11	CERAMIC CHIP 0.01 μ F	10% 50V
C21	1-164-232-11	CERAMIC CHIP 0.01 μ F	10% 50V	C143	1-104-664-11	ELECT 47 μ F	20% 16V
C22	1-163-251-11	CERAMIC CHIP 100pF	5% 50V	C144	1-164-232-11	CERAMIC CHIP 0.01 μ F	10% 50V
C24	1-163-275-11	CERAMIC CHIP 1000pF	5% 50V	C145	1-164-232-11	CERAMIC CHIP 0.01 μ F	10% 50V
C25	1-104-664-11	ELECT 47 μ F	20% 16V	C146	1-164-232-11	CERAMIC CHIP 0.01 μ F	10% 50V
C26	1-104-664-11	ELECT 47 μ F	20% 16V	C147	1-164-232-11	CERAMIC CHIP 0.01 μ F	10% 50V
C43	1-163-121-00	CERAMIC CHIP 150pF	5% 50V	C148	1-126-933-11	ELECT 100 μ F	20% 16V
C45	1-163-038-00	CERAMIC CHIP 0.1 μ F	25V	C149	1-164-232-11	CERAMIC CHIP 0.01 μ F	10% 50V
C90	1-163-038-00	CERAMIC CHIP 0.1 μ F	25V	C150	1-164-232-11	CERAMIC CHIP 0.01 μ F	10% 50V
C101	1-163-038-00	CERAMIC CHIP 0.1 μ F	25V	C151	1-164-232-11	CERAMIC CHIP 0.01 μ F	10% 50V
C102	1-126-934-11	ELECT 220 μ F	20% 16V	C152	1-164-004-11	CERAMIC CHIP 0.1 μ F	10% 25V
C103	1-126-965-11	ELECT 22 μ F	20% 50V	C153	1-164-004-11	CERAMIC CHIP 0.1 μ F	10% 25V
C104	1-163-251-11	CERAMIC CHIP 100pF	5% 50V	C154	1-164-232-11	CERAMIC CHIP 0.01 μ F	10% 50V
C110	1-104-664-11	ELECT 47 μ F	20% 16V	C155	1-164-232-11	CERAMIC CHIP 0.01 μ F	10% 50V
C112	1-163-275-11	CERAMIC CHIP 1000pF	5% 50V	C201	1-164-004-11	CERAMIC CHIP 0.1 μ F	10% 25V
C113	1-104-664-11	ELECT 47 μ F	20% 16V	C202	1-164-004-11	CERAMIC CHIP 0.1 μ F	10% 25V
C115	1-163-263-11	CERAMIC CHIP 330pF	5% 50V	C203	1-104-661-91	ELECT 330 μ F	20% 16V
C120	1-163-251-11	CERAMIC CHIP 100pF	5% 50V	C204	1-163-038-00	CERAMIC CHIP 0.1 μ F	25V
C121	1-163-113-00	CERAMIC CHIP 68pF	5% 50V	C205	1-126-965-11	ELECT 22 μ F	20% 50V
				C206	1-163-275-11	CERAMIC CHIP 1000pF	5% 50V
				C207	1-126-964-11	ELECT 10 μ F	20% 50V
				C208	1-126-965-11	ELECT 22 μ F	20% 50V
				C209	1-126-964-11	ELECT 10 μ F	20% 50V
				C210	1-216-295-00	SHORT 0	
				C211	1-126-965-11	ELECT 22 μ F	20% 50V
				C212	1-164-346-11	CERAMIC CHIP 1 μ F	16V



REF.NO.	PART NO.	DESCRIPTION	REMARK	REF.NO.	PART NO.	DESCRIPTION	REMARK
C213	1-163-133-00	CERAMIC CHIP 470pF	5% 50V	C302	1-163-275-11	CERAMIC CHIP 1000pF	5% 50V
C214	1-164-346-11	CERAMIC CHIP 1μF	16V	C303	1-163-275-11	CERAMIC CHIP 1000pF	5% 50V
C215	1-163-133-00	CERAMIC CHIP 470pF	5% 50V	C304	1-163-038-00	CERAMIC CHIP 0.1μF	25V
C216	1-104-664-11	ELECT 47μF	20% 16V	C305	1-163-038-00	CERAMIC CHIP 0.1μF	25V
C217	1-164-232-11	CERAMIC CHIP 0.01μF	10% 50V	C306	1-164-232-11	CERAMIC CHIP 0.01μF	10% 50V
C218	1-104-664-11	ELECT 47μF	20% 16V	C307	1-164-232-11	CERAMIC CHIP 0.01μF	10% 50V
C219	1-164-232-11	CERAMIC CHIP 0.01μF	10% 50V	C308	1-164-232-11	CERAMIC CHIP 0.01μF	10% 50V
C220	1-126-965-11	ELECT 22μF	20% 50V	C309	1-164-346-11	CERAMIC CHIP 1μF	16V
C221	1-164-505-11	CERAMIC CHIP 2.2μF	16V	C310	1-164-346-11	CERAMIC CHIP 1μF	16V
C222	1-164-346-11	CERAMIC CHIP 1μF	16V	C311	1-164-346-11	CERAMIC CHIP 1μF	16V
C223	1-163-133-00	CERAMIC CHIP 470pF	5% 50V	C312	1-164-505-11	CERAMIC CHIP 2.2μF	16V
C224	1-164-346-11	CERAMIC CHIP 1μF	16V	C313	1-163-275-11	CERAMIC CHIP 1000pF	5% 50V
C225	1-163-133-00	CERAMIC CHIP 470pF	5% 50V	C315	1-216-295-00	SHORT 0	
C226	1-104-664-11	ELECT 47μF	20% 16V	C316	1-163-239-11	CERAMIC CHIP 33pF	5% 50V
C227	1-164-232-11	CERAMIC CHIP 0.01μF	10% 50V	C317	1-163-038-00	CERAMIC CHIP 0.1μF	25V
C228	1-104-664-11	ELECT 47μF	20% 16V	C320	1-126-965-11	ELECT 22μF	20% 50V
C229	1-164-232-11	CERAMIC CHIP 0.01μF	10% 50V	C321	1-164-232-11	CERAMIC CHIP 0.01μF	10% 50V
C230	1-216-295-00	SHORT 0		C322	1-163-038-00	CERAMIC CHIP 0.1μF	25V
C242	1-164-232-11	CERAMIC CHIP 0.01μF	10% 50V	C323	1-163-038-00	CERAMIC CHIP 0.1μF	25V
C243	1-126-967-11	ELECT 47μF	20% 50V	C324	1-163-038-00	CERAMIC CHIP 0.1μF	25V
C244	1-164-232-11	CERAMIC CHIP 0.01μF	10% 50V	C325	1-164-346-11	CERAMIC CHIP 1μF	16V
C245	1-164-232-11	CERAMIC CHIP 0.01μF	10% 50V	C326	1-163-275-11	CERAMIC CHIP 1000pF	5% 50V
C251	1-163-087-00	CERAMIC CHIP 4pF	0.25pF 50V	C327	1-137-374-11	FILM 0.047μF	5% 50V
C252	1-163-087-00	CERAMIC CHIP 4pF	0.25pF 50V	C328	1-126-964-11	ELECT 10μF	20% 50V
C253	1-163-251-11	CERAMIC CHIP 100pF	5% 50V	C330	1-130-777-00	FILM 0.1μF	5% 63V
C254	1-163-243-11	CERAMIC CHIP 47pF	5% 50V	C331	1-137-581-11	FILM 0.1μF	5% 100V
C255	1-163-251-11	CERAMIC CHIP 100pF	5% 50V	C332	1-164-232-11	CERAMIC CHIP 0.01μF	10% 50V
C256	1-163-038-00	CERAMIC CHIP 0.1μF	25V	C333	1-126-933-11	ELECT 100μF	20% 16V
C257	1-126-965-11	ELECT 22μF	20% 50V	C334	1-164-232-11	CERAMIC CHIP 0.01μF	10% 50V
C258	1-126-964-11	ELECT 10μF	20% 50V	C335	1-164-005-11	CERAMIC CHIP 0.47μF	25V
C259	1-164-005-11	CERAMIC CHIP 0.47μF	25V	C336	1-163-009-11	CERAMIC CHIP 0.001μF	10% 50V
C260	1-163-038-00	CERAMIC CHIP 0.1μF	25V	C337	1-163-009-11	CERAMIC CHIP 0.001μF	10% 50V
C261	1-163-133-00	CERAMIC CHIP 470pF	5% 50V	C338	1-126-962-11	ELECT 3.3μF	20% 50V
C262	1-163-133-00	CERAMIC CHIP 470pF	5% 50V	C339	1-164-232-11	CERAMIC CHIP 0.01μF	10% 50V
C263	1-163-038-00	CERAMIC CHIP 0.1μF	25V	C340	1-126-933-11	ELECT 100μF	20% 16V
C264	1-126-962-11	ELECT 3.3μF	20% 50V	C341	1-164-005-11	CERAMIC CHIP 0.47μF	25V
C265	1-126-964-11	ELECT 10μF	20% 50V	C342	1-164-346-11	CERAMIC CHIP 1μF	16V
C266	1-126-964-11	ELECT 10μF	20% 50V	C343	1-163-017-00	CERAMIC CHIP 0.0047μF	10% 50V
C267	1-126-965-11	ELECT 22μF	20% 50V	C344	1-163-251-11	CERAMIC CHIP 100pF	5% 50V
C268	1-163-038-00	CERAMIC CHIP 0.1μF	25V	C347	1-126-963-11	ELECT 4.7μF	20% 50V
C269	1-163-131-00	CERAMIC CHIP 390pF	5% 50V	C348	1-163-133-00	CERAMIC CHIP 470pF	5% 50V
C270	1-163-131-00	CERAMIC CHIP 390pF	5% 50V	C350	1-126-964-11	ELECT 10μF	20% 50V
C271	1-163-275-11	CERAMIC CHIP 1000pF	5% 50V	C351	1-164-505-11	CERAMIC CHIP 2.2μF	16V
C272	1-163-275-11	CERAMIC CHIP 1000pF	5% 50V	C352	1-164-005-11	CERAMIC CHIP 0.47μF	25V
C273	1-163-275-11	CERAMIC CHIP 1000pF	5% 50V	C353	1-164-505-11	CERAMIC CHIP 2.2μF	16V
C274	1-163-275-11	CERAMIC CHIP 1000pF	5% 50V	C354	1-164-005-11	CERAMIC CHIP 0.47μF	25V
C275	1-164-346-11	CERAMIC CHIP 1μF	16V	C355	1-126-965-11	ELECT 22μF	20% 50V
C276	1-164-346-11	CERAMIC CHIP 1μF	16V	C356	1-164-232-11	CERAMIC CHIP 0.01μF	10% 50V
C277	1-164-505-11	CERAMIC CHIP 2.2μF	16V	C357	1-163-133-00	CERAMIC CHIP 470pF	5% 50V
C278	1-164-505-11	CERAMIC CHIP 2.2μF	16V	C358	1-164-005-11	CERAMIC CHIP 0.47μF	25V
C279	1-126-965-11	ELECT 22μF	20% 50V	C359	1-163-231-11	CERAMIC CHIP 15pF	5% 50V
C280	1-163-038-00	CERAMIC CHIP 0.1μF	25V	C360	1-163-231-11	CERAMIC CHIP 15pF	5% 50V
C281	1-126-965-11	ELECT 22μF	20% 50V	C370	1-164-505-11	CERAMIC CHIP 2.2μF	16V
C282	1-163-038-00	CERAMIC CHIP 0.1μF	25V	C371	1-163-275-11	CERAMIC CHIP 1000pF	5% 50V
C283	1-164-232-11	CERAMIC CHIP 0.01μF	10% 50V	C372	1-164-004-11	CERAMIC CHIP 0.1μF	10% 25V
C300	1-163-251-11	CERAMIC CHIP 100pF	5% 50V	C373	1-164-489-11	CERAMIC CHIP 0.22μF	10% 16V
C301	1-163-038-00	CERAMIC CHIP 0.1μF	25V				



REF.NO.	PART NO.	DESCRIPTION	REMARK	REF.NO.	PART NO.	DESCRIPTION	REMARK
C376	1-163-251-11	CERAMIC CHIP 100pF	5% 50V	D225	8-719-977-22	DIODE DTZ9.1	
C377	1-126-964-11	ELECT 10μF	20% 50V	D226	8-719-977-22	DIODE DTZ9.1	
C380	1-163-038-00	CERAMIC CHIP 0.1μF	25V	D227	8-719-056-83	DIODE UDZ-TE-17-6.8B	
C1001	1-163-235-11	CERAMIC CHIP 22pF	5% 50V	D228	8-719-977-12	DIODE DTZ6.8B	
C1002	1-163-235-11	CERAMIC CHIP 22pF	5% 50V	D231	8-719-158-15	DIODE RD5.6SB	
C1010	1-163-038-00	CERAMIC CHIP 0.1μF	25V	D251	8-719-047-16	DIODE BAS216	
C1013	1-126-965-11	ELECT 22μF	20% 50V	D303	8-719-988-61	DIODE 1SS355TE-17	
C1014	1-163-038-00	CERAMIC CHIP 0.1μF	25V	D304	8-719-988-61	DIODE 1SS355TE-17	
C1015	1-164-489-11	CERAMIC CHIP 0.22μF	10% 16V	D320	8-719-977-22	DIODE DTZ9.1	
C1020	1-163-235-11	CERAMIC CHIP 22pF	5% 50V	D370	8-719-047-16	DIODE BAS216	
	<FILTER>			D1010	8-719-036-58	DIODE MA3030-H(TX)	
CF120	1-409-327-00	TRAP, CERAMIC (6.5MHZ)			<FERRITE BEAD>		
	<CONNECTOR>			FB101	1-414-235-11	INDUCTOR CHIP	0μH
CN1	1-695-302-11	CONNECTOR, BOARD TO BOARD 50P		FB102	1-414-235-11	INDUCTOR CHIP	0μH
CN2	*1-564-508-11	PLUG, CONNECTOR 5P		FB103	1-414-235-11	INDUCTOR CHIP	0μH
CN6	*1-564-516-11	PLUG, CONNECTOR 13P		FB104	1-414-235-11	INDUCTOR CHIP	0μH
CN101	1-695-915-11	TAB (CONTACT)			<FILTER>		
CN201	1-766-296-11	CONNECTOR, DUAL SCART		FL101	1-236-071-11	ENCAPSULATED COMPONENT	
CN301	*1-564-510-11	PLUG, CONNECTOR 7P		FL102	1-233-765-21	FILTER	
	<DIODE>			FL103	1-233-765-21	FILTER	
D2	8-719-988-61	DIODE 1SS355TE-17		FL104	1-233-765-21	FILTER	
D10	8-719-158-15	DIODE RD5.6SB		FL201	1-236-071-11	ENCAPSULATED COMPONENT	
D11	8-719-158-15	DIODE RD5.6SB		FL202	1-236-071-11	ENCAPSULATED COMPONENT	
D12	8-719-158-15	DIODE RD5.6SB		FL203	1-236-071-11	ENCAPSULATED COMPONENT	
D16	8-719-988-61	DIODE 1SS355TE-17		FL1001	1-236-071-11	ENCAPSULATED COMPONENT	
D101	8-719-977-81	DIODE DTZ33B			<IC>		
D102	8-719-988-61	DIODE 1SS355TE-17		IC1	8-759-376-77	IC SDA30C263-GEG	
D201	8-719-977-22	DIODE DTZ9.1		IC2	8-759-524-94	IC M24C32-MW6T	
D202	8-719-977-22	DIODE DTZ9.1		IC3	8-759-581-32	IC M27C2001-12C1RE402 (KP-41S5K)	
D203	8-719-977-22	DIODE DTZ9.1		IC3	8-759-581-33	IC M27C2001-12C1RG402 (KP-41S5G)	
D204	8-719-977-22	DIODE DTZ9.1		IC3	8-759-581-34	IC M27C2001-12C1RR402 (KP-41S5R)	
D205	8-719-977-22	DIODE DTZ9.1		IC3	8-759-581-35	IC M27C2001-12C1RW402 (KP-41S5/41S5B/41S5U)	
D206	8-719-977-22	DIODE DTZ9.1		IC4	8-759-394-57	IC PST593C-MMP-4P	
D207	8-719-977-22	DIODE DTZ9.1		IC102	8-759-711-62	IC NJM2240M	
D208	8-719-977-22	DIODE DTZ9.1		IC103	8-752-379-35	IC CXD2044Q-TL	
D209	8-719-977-22	DIODE DTZ9.1		IC201	8-752-081-26	IC CXA2040AQ-T4	
D210	8-719-977-22	DIODE DTZ9.1		IC202	8-759-491-95	IC MSP3410D-PS-B4-T-ND	
D211	8-719-977-22	DIODE DTZ9.1		IC204	8-759-008-67	IC MC14066BF	
D212	8-719-977-22	DIODE DTZ9.1		IC205	8-759-394-57	IC PST593C-MMP-4P	
D213	8-719-977-22	DIODE DTZ9.1		IC206	8-752-058-68	IC CXA1315M	
D214	8-719-977-22	DIODE DTZ9.1		IC301	8-752-081-43	IC CXA2076Q-TL	
D215	8-719-977-22	DIODE DTZ9.1		IC302	8-759-565-20	IC TDA4665T/V5-118	
D216	8-719-158-15	DIODE RD5.6SB		IC303	8-759-430-79	IC TDA8395T/N3	
D217	8-719-158-15	DIODE RD5.6SB		IC1001	8-759-584-20	IC SDA5273-3CP	
D218	8-719-158-15	DIODE RD5.6SB			<CHIP, CONDUCTOR>		
D220	8-719-988-61	DIODE 1SS355TE-17		JR1	1-216-295-00	SHORT	0
D221	8-719-988-61	DIODE 1SS355TE-17		JR2	1-216-296-00	SHORT	0
D222	8-719-977-22	DIODE DTZ9.1		JR3	1-216-296-00	SHORT	0
D223	8-719-977-22	DIODE DTZ9.1		JR4	1-216-295-00	SHORT	0
D224	8-719-977-22	DIODE DTZ9.1					



REF.NO.	PART NO.	DESCRIPTION	REMARK	REF.NO.	PART NO.	DESCRIPTION	REMARK
JR201	1-216-295-00	SHORT	0	Q124	8-729-120-28	TRANSISTOR 2SC1623-L5L6	
JR203	1-216-295-00	SHORT	0	Q125	8-729-026-49	TRANSISTOR 2SA1037AK-T146-R	
JR208	1-216-295-00	SHORT	0	Q130	8-729-026-49	TRANSISTOR 2SA1037AK-T146-R	
JR209	1-216-295-00	SHORT	0	Q201	8-729-120-28	TRANSISTOR 2SC1623-L5L6	
JR211	1-216-295-00	SHORT	0	Q202	8-729-120-28	TRANSISTOR 2SC1623-L5L6	
JR212	1-216-295-00	SHORT	0	Q203	8-729-120-28	TRANSISTOR 2SC1623-L5L6	
JR303	1-216-296-00	SHORT	0	Q204	8-729-120-28	TRANSISTOR 2SC1623-L5L6	
JR304	1-216-296-00	SHORT	0	Q211	1-801-806-11	TRANSISTOR DTC144EKA-T146	
JR305	1-216-296-00	SHORT	0	Q212	8-729-026-49	TRANSISTOR 2SA1037AK-T146-R	
JR360	1-216-295-00	SHORT	0	Q213	8-729-026-49	TRANSISTOR 2SA1037AK-T146-R	
JR362	1-216-295-00	SHORT	0	Q214	1-801-806-11	TRANSISTOR DTC144EKA-T146	
JR1010	1-216-295-00	SHORT	0	Q215	8-729-120-28	TRANSISTOR 2SC1623-L5L6	
	<COIL>			Q216	8-729-120-28	TRANSISTOR 2SC1623-L5L6	
L10	1-410-379-31	INDUCTOR CHIP	6.8μH	Q217	8-729-120-28	TRANSISTOR 2SC1623-L5L6	
L102	1-408-600-31	INDUCTOR	5.6μH	Q300	1-801-806-11	TRANSISTOR DTC144EKA-T146	
L111	1-216-295-00	SHORT	0	Q301	8-729-120-28	TRANSISTOR 2SC1623-L5L6	
L120	1-408-602-31	INDUCTOR	8.2μH	Q302	8-729-120-28	TRANSISTOR 2SC1623-L5L6	
L121	1-408-591-11	INDUCTOR	1μH	Q303	8-729-120-28	TRANSISTOR 2SC1623-L5L6	
L122	1-408-602-31	INDUCTOR	8.2μH	Q304	8-729-120-28	TRANSISTOR 2SC1623-L5L6	
L300	1-412-006-31	INDUCTOR CHIP	10μH	Q305	8-729-120-28	TRANSISTOR 2SC1623-L5L6	
L301	1-410-993-11	INDUCTOR CHIP	1μH	Q306	1-801-806-11	TRANSISTOR DTC144EKA-T146	
	<TRANSISTOR>			Q307	1-801-806-11	TRANSISTOR DTC144EKA-T146	
Q1	8-729-120-28	TRANSISTOR 2SC1623-L5L6		Q308	1-801-806-11	TRANSISTOR DTC144EKA-T146	
Q4	8-729-120-28	TRANSISTOR 2SC1623-L5L6		Q309	1-801-806-11	TRANSISTOR DTC144EKA-T146	
Q15	8-729-026-49	TRANSISTOR 2SA1037AK-T146-R		Q330	8-729-026-49	TRANSISTOR 2SA1037AK-T146-R	
Q17	8-729-026-49	TRANSISTOR 2SA1037AK-T146-R		Q331	8-729-120-28	TRANSISTOR 2SC1623-L5L6	
Q18	8-729-027-38	TRANSISTOR DTA144EKA-T146		Q1001	1-801-806-11	TRANSISTOR DTC144EKA-T146	
Q20	8-729-120-28	TRANSISTOR 2SC1623-L5L6		Q1002	8-729-026-49	TRANSISTOR 2SA1037AK-T146-R	
Q21	8-729-120-28	TRANSISTOR 2SC1623-L5L6			<RESISTOR>		
Q22	8-729-120-28	TRANSISTOR 2SC1623-L5L6		R1	1-216-049-00	RES,CHIP	1K 5% 1/10W
Q23	8-729-026-49	TRANSISTOR 2SA1037AK-T146-R		R2	1-216-025-00	RES,CHIP	100 5% 1/10W
Q24	8-729-026-49	TRANSISTOR 2SA1037AK-T146-R		R3	1-216-025-00	RES,CHIP	100 5% 1/10W
Q25	8-729-026-49	TRANSISTOR 2SA1037AK-T146-R		R4	1-216-013-00	RES,CHIP	33 5% 1/10W
Q101	8-729-120-28	TRANSISTOR 2SC1623-L5L6		R5	1-216-073-00	RES,CHIP	10K 5% 1/10W
Q102	8-729-026-49	TRANSISTOR 2SA1037AK-T146-R		R6	1-216-667-11	METAL CHIP	4.7K 0.50% 1/10W
Q103	8-729-026-49	TRANSISTOR 2SA1037AK-T146-R		R7	1-216-041-00	RES,CHIP	470 5% 1/10W
Q104	8-729-120-28	TRANSISTOR 2SC1623-L5L6		R9	1-216-041-00	RES,CHIP	470 5% 1/10W
Q105	8-729-120-28	TRANSISTOR 2SC1623-L5L6		R18	1-216-025-00	RES,CHIP	100 5% 1/10W
Q106	8-729-026-49	TRANSISTOR 2SA1037AK-T146-R		R19	1-216-025-00	RES,CHIP	100 5% 1/10W
Q107	8-729-026-49	TRANSISTOR 2SA1037AK-T146-R		R20	1-216-025-00	RES,CHIP	100 5% 1/10W
Q108	8-729-026-49	TRANSISTOR 2SA1037AK-T146-R		R21	1-216-025-00	RES,CHIP	100 5% 1/10W
Q109	8-729-026-49	TRANSISTOR 2SA1037AK-T146-R		R24	1-216-065-00	RES,CHIP	4.7K 5% 1/10W
Q110	8-729-120-28	TRANSISTOR 2SC1623-L5L6		R25	1-216-065-00	RES,CHIP	4.7K 5% 1/10W
Q111	8-729-026-49	TRANSISTOR 2SA1037AK-T146-R		R28	1-216-073-00	RES,CHIP	10K 5% 1/10W
Q112	8-729-120-28	TRANSISTOR 2SC1623-L5L6		R29	1-216-065-00	RES,CHIP	4.7K 5% 1/10W
Q113	8-729-026-49	TRANSISTOR 2SA1037AK-T146-R		R30	1-216-065-00	RES,CHIP	4.7K 5% 1/10W
Q114	8-729-026-49	TRANSISTOR 2SA1037AK-T146-R		R31	1-216-065-00	RES,CHIP	4.7K 5% 1/10W
Q115	8-729-120-28	TRANSISTOR 2SC1623-L5L6		R32	1-216-025-00	RES,CHIP	100 5% 1/10W
Q116	8-729-026-49	TRANSISTOR 2SA1037AK-T146-R		R33	1-216-025-00	RES,CHIP	100 5% 1/10W
Q120	8-729-120-28	TRANSISTOR 2SC1623-L5L6		R34	1-216-025-00	RES,CHIP	100 5% 1/10W
Q121	8-729-120-28	TRANSISTOR 2SC1623-L5L6		R35	1-216-025-00	RES,CHIP	100 5% 1/10W
Q122	8-729-120-28	TRANSISTOR 2SC1623-L5L6		R40	1-216-067-00	RES,CHIP	5.6K 5% 1/10W
				R42	1-216-069-00	RES,CHIP	6.8K 5% 1/10W
				R44	1-216-069-00	RES,CHIP	6.8K 5% 1/10W
				R46	1-216-095-00	RES,CHIP	82K 5% 1/10W



REF.NO.	PART NO.	DESCRIPTION	REMARK	REF.NO.	PART NO.	DESCRIPTION	REMARK
R47	1-216-057-00	RES,CHIP	2.2K	5%	1/10W	R126	1-216-025-00 RES,CHIP 100 5% 1/10W
R48	1-217-671-11	RES,CHIP	1	5%	1/10W	R127	1-216-081-00 RES,CHIP 22K 5% 1/10W
R49	1-216-025-00	RES,CHIP	100	5%	1/10W	R128	1-216-035-00 RES,CHIP 270 5% 1/10W
R50	1-216-065-00	RES,CHIP	4.7K	5%	1/10W	R129	1-216-037-00 RES,CHIP 330 5% 1/10W
R51	1-216-059-00	RES,CHIP	2.7K	5%	1/10W	R130	1-216-061-00 RES,CHIP 3.3K 5% 1/10W
R52	1-216-065-00	RES,CHIP	4.7K	5%	1/10W	R131	1-216-073-00 RES,CHIP 10K 5% 1/10W
R53	1-216-059-00	RES,CHIP	2.7K	5%	1/10W	R132	1-216-025-00 RES,CHIP 100 5% 1/10W
R54	1-216-025-00	RES,CHIP	100	5%	1/10W	R133	1-216-041-00 RES,CHIP 470 5% 1/10W
R58	1-216-063-91	RES,CHIP	3.9K	5%	1/10W	R134	1-216-001-00 RES,CHIP 10 5% 1/10W
R59	1-216-025-00	RES,CHIP	100	5%	1/10W	R135	1-216-045-00 RES,CHIP 680 5% 1/10W
R60	1-216-025-00	RES,CHIP	100	5%	1/10W	R136	1-216-033-00 RES,CHIP 220 5% 1/10W
R61	1-216-025-00	RES,CHIP	100	5%	1/10W	R137	1-216-049-00 RES,CHIP 1K 5% 1/10W
R62	1-216-025-00	RES,CHIP	100	5%	1/10W	R138	1-216-041-00 RES,CHIP 470 5% 1/10W
R64	1-216-025-00	RES,CHIP	100	5%	1/10W	R142	1-216-295-00 SHORT 0
R65	1-216-025-00	RES,CHIP	100	5%	1/10W	R143	1-216-295-00 SHORT 0
R66	1-216-057-00	RES,CHIP	2.2K	5%	1/10W	R145	1-216-025-00 RES,CHIP 100 5% 1/10W
R67	1-216-057-00	RES,CHIP	2.2K	5%	1/10W	R146	1-216-025-00 RES,CHIP 100 5% 1/10W
R68	1-216-025-00	RES,CHIP	100	5%	1/10W	R147	1-216-025-00 RES,CHIP 100 5% 1/10W
R70	1-216-025-00	RES,CHIP	100	5%	1/10W	R148	1-216-025-00 RES,CHIP 100 5% 1/10W
R71	1-216-025-00	RES,CHIP	100	5%	1/10W	R149	1-216-025-00 RES,CHIP 100 5% 1/10W
R72	1-216-025-00	RES,CHIP	100	5%	1/10W	R150	1-216-025-00 RES,CHIP 100 5% 1/10W
R73	1-216-025-00	RES,CHIP	100	5%	1/10W	R151	1-216-025-00 RES,CHIP 100 5% 1/10W
R74	1-216-025-00	RES,CHIP	100	5%	1/10W	R153	1-216-025-00 RES,CHIP 100 5% 1/10W
R76	1-216-025-00	RES,CHIP	100	5%	1/10W	R154	1-216-295-00 SHORT 0
R77	1-216-025-00	RES,CHIP	100	5%	1/10W	R156	1-216-089-00 RES,CHIP 47K 5% 1/10W
R78	1-216-025-00	RES,CHIP	100	5%	1/10W	R157	1-216-089-00 RES,CHIP 47K 5% 1/10W
R79	1-216-033-00	RES,CHIP	220	5%	1/10W	R158	1-216-073-00 RES,CHIP 10K 5% 1/10W
R88	1-216-025-00	RES,CHIP	100	5%	1/10W	R159	1-216-049-00 RES,CHIP 1K 5% 1/10W
R91	1-216-025-00	RES,CHIP	100	5%	1/10W	R160	1-216-061-00 RES,CHIP 3.3K 5% 1/10W
R92	1-216-025-00	RES,CHIP	100	5%	1/10W	R161	1-216-033-00 RES,CHIP 220 5% 1/10W
R93	1-216-033-00	RES,CHIP	220	5%	1/10W	R162	1-216-109-00 RES,CHIP 330K 5% 1/10W
R94	1-216-033-00	RES,CHIP	220	5%	1/10W	R163	1-216-033-00 RES,CHIP 220 5% 1/10W
R95	1-216-033-00	RES,CHIP	220	5%	1/10W	R164	1-216-089-91 RES,CHIP 47K 5% 1/10W
R97	1-216-025-00	RES,CHIP	100	5%	1/10W	R165	1-216-089-91 RES,CHIP 47K 5% 1/10W
R101	1-216-061-00	RES,CHIP	3.3K	5%	1/10W	R166	1-216-033-00 RES,CHIP 220 5% 1/10W
R102	1-216-025-00	RES,CHIP	100	5%	1/10W	R167	1-216-043-91 RES,CHIP 560 5% 1/10W
R103	1-216-025-00	RES,CHIP	100	5%	1/10W	R168	1-216-067-00 RES,CHIP 5.6K 5% 1/10W
R104	1-216-073-00	RES,CHIP	10K	5%	1/10W	R169	1-216-049-00 RES,CHIP 1K 5% 1/10W
R105	1-216-113-00	RES,CHIP	470K	5%	1/10W	R170	1-216-025-00 RES,CHIP 100 5% 1/10W
R106	1-216-073-00	RES,CHIP	10K	5%	1/10W	R171	1-216-097-00 RES,CHIP 100K 5% 1/10W
R107	1-216-295-00	SHORT	0			R172	1-216-065-00 RES,CHIP 4.7K 5% 1/10W
R110	1-216-073-00	RES,CHIP	10K	5%	1/10W	R173	1-216-025-00 RES,CHIP 100 5% 1/10W
R111	1-216-029-00	RES,CHIP	150	5%	1/10W	R174	1-216-666-11 METAL CHIP 4.3K 0.50%1/10W
R112	1-216-029-00	RES,CHIP	150	5%	1/10W	R175	1-216-653-11 METAL CHIP 1.2K 0.50%1/10W
R113	1-216-001-00	RES,CHIP	10	5%	1/10W	R176	1-216-295-00 SHORT 0
R114	1-216-029-00	RES,CHIP	150	5%	1/10W	R177	1-216-049-00 RES,CHIP 1K 5% 1/10W
R115	1-216-037-00	RES,CHIP	330	5%	1/10W	R178	1-216-295-00 SHORT 0
R116	1-216-065-00	RES,CHIP	4.7K	5%	1/10W	R179	1-216-657-11 METAL CHIP 1.8K 0.50%1/10W
R117	1-216-057-00	RES,CHIP	2.2K	5%	1/10W	R180	1-216-659-11 METAL CHIP 2.2K 0.50%1/10W
R118	1-216-071-00	RES,CHIP	8.2K	5%	1/10W	R181	1-216-667-11 METAL CHIP 4.7K 0.50%1/10W
R119	1-216-033-00	RES,CHIP	220	5%	1/10W	R182	1-216-635-11 METAL CHIP 220 0.50%1/10W
R120	1-216-069-00	RES,CHIP	6.8K	5%	1/10W	R183	1-216-635-11 METAL CHIP 220 0.50%1/10W
R121	1-216-073-00	RES,CHIP	10K	5%	1/10W	R184	1-216-057-00 RES,CHIP 2.2K 5% 1/10W
R122	1-216-041-00	RES,CHIP	470	5%	1/10W	R185	1-216-043-91 RES,CHIP 560 5% 1/10W
R123	1-216-031-00	RES,CHIP	180	5%	1/10W	R186	1-216-067-00 RES,CHIP 5.6K 5% 1/10W
R124	1-216-049-00	RES,CHIP	1K	5%	1/10W	R187	1-216-049-00 RES,CHIP 1K 5% 1/10W
R125	1-216-081-00	RES,CHIP	22K	5%	1/10W	R188	1-216-057-00 RES,CHIP 2.2K 5% 1/10W



REF.NO.	PART NO.	DESCRIPTION	REMARK	REF.NO.	PART NO.	DESCRIPTION	REMARK
R189	1-216-043-91	RES,CHIP	560 5% 1/10W	R250	1-216-033-00	RES,CHIP	220 5% 1/10W
R190	1-216-067-00	RES,CHIP	5.6K 5% 1/10W	R251	1-216-025-00	RES,CHIP	100 5% 1/10W
R191	1-216-057-00	RES,CHIP	2.2K 5% 1/10W	R252	1-216-025-00	RES,CHIP	100 5% 1/10W
R192	1-216-049-00	RES,CHIP	1K 5% 1/10W	R253	1-216-025-00	RES,CHIP	100 5% 1/10W
R193	1-216-049-00	RES,CHIP	1K 5% 1/10W	R254	1-216-025-00	RES,CHIP	100 5% 1/10W
R194	1-216-049-00	RES,CHIP	1K 5% 1/10W	R255	1-216-025-00	RES,CHIP	100 5% 1/10W
R195	1-216-049-00	RES,CHIP	1K 5% 1/10W	R256	1-216-025-00	RES,CHIP	100 5% 1/10W
R196	1-216-049-00	RES,CHIP	1K 5% 1/10W	R257	1-216-073-00	RES,CHIP	10K 5% 1/10W
R197	1-216-049-00	RES,CHIP	1K 5% 1/10W	R258	1-216-017-00	RES,CHIP	47 5% 1/10W
R198	1-216-033-00	RES,CHIP	220 5% 1/10W	R259	1-216-041-00	RES,CHIP	470 5% 1/10W
R199	1-216-033-00	RES,CHIP	220 5% 1/10W	R264	1-216-089-91	RES,CHIP	47K 5% 1/10W
R200	1-216-049-00	RES,CHIP	1K 5% 1/10W	R265	1-216-065-00	RES,CHIP	4.7K 5% 1/10W
R201	1-216-033-00	RES,CHIP	220 5% 1/10W	R266	1-216-081-00	RES,CHIP	22K 5% 1/10W
R202	1-216-033-00	RES,CHIP	220 5% 1/10W	R267	1-216-065-00	RES,CHIP	4.7K 5% 1/10W
R203	1-216-025-00	RES,CHIP	100 5% 1/10W	R268	1-216-089-91	RES,CHIP	47K 5% 1/10W
R204	1-216-025-00	RES,CHIP	100 5% 1/10W	R269	1-216-089-91	RES,CHIP	47K 5% 1/10W
R205	1-216-689-11	RES,CHIP	39K 5% 1/10W	R270	1-216-022-00	RES,CHIP	75 5% 1/10W
R206	1-216-033-00	RES,CHIP	220 5% 1/10W	R271	1-216-022-00	RES,CHIP	75 5% 1/10W
R207	1-216-089-00	RES,CHIP	47K 5% 1/10W	R272	1-216-022-00	RES,CHIP	75 5% 1/10W
R208	1-216-041-00	RES,CHIP	470 5% 1/10W	R273	1-216-022-00	RES,CHIP	75 5% 1/10W
R209	1-216-049-00	RES,CHIP	1K 5% 1/10W	R274	1-216-089-91	RES,CHIP	47K 5% 1/10W
R210	1-216-017-00	RES,CHIP	47 5% 1/10W	R280	1-216-049-00	RES,CHIP	1K 5% 1/10W
R211	1-216-033-00	RES,CHIP	220 5% 1/10W	R281	1-216-089-00	RES,CHIP	47K 5% 1/10W
R212	1-216-022-00	RES,CHIP	75 5% 1/10W	R282	1-216-093-91	RES,CHIP	68K 5% 1/10W
R213	1-216-022-00	RES,CHIP	75 5% 1/10W	R283	1-216-065-00	RES,CHIP	4.7K 5% 1/10W
R214	1-216-025-00	RES,CHIP	100 5% 1/10W	R284	1-216-089-00	RES,CHIP	47K 5% 1/10W
R216	1-216-025-00	RES,CHIP	100 5% 1/10W	R285	1-216-093-91	RES,CHIP	68K 5% 1/10W
R217	1-216-113-00	RES,CHIP	470K 5% 1/10W	R286	1-216-065-00	RES,CHIP	4.7K 5% 1/10W
R218	1-216-025-00	RES,CHIP	100 5% 1/10W	R291	1-216-057-00	RES,CHIP	2.2K 5% 1/10W
R219	1-216-113-00	RES,CHIP	470K 5% 1/10W	R292	1-216-057-00	RES,CHIP	2.2K 5% 1/10W
R220	1-216-295-00	SHORT	0	R293	1-216-089-00	RES,CHIP	47K 5% 1/10W
R221	1-216-039-00	RES,CHIP	390 5% 1/10W	R294	1-216-097-00	RES,CHIP	100K 5% 1/10W
R222	1-216-089-00	RES,CHIP	47K 5% 1/10W	R295	1-216-049-00	RES,CHIP	1K 5% 1/10W
R223	1-216-295-00	SHORT	0	R296	1-216-049-00	RES,CHIP	1K 5% 1/10W
R224	1-216-039-00	RES,CHIP	390 5% 1/10W	R297	1-216-033-00	RES,CHIP	220 5% 1/10W
R225	1-216-089-00	RES,CHIP	47K 5% 1/10W	R298	1-216-033-00	RES,CHIP	220 5% 1/10W
R226	1-216-033-00	RES,CHIP	220 5% 1/10W	R299	1-216-073-00	RES,CHIP	10K 5% 1/10W
R227	1-216-022-00	RES,CHIP	75 5% 1/10W	R300	1-216-025-00	RES,CHIP	100 5% 1/10W
R228	1-216-022-00	RES,CHIP	75 5% 1/10W	R301	1-216-033-00	RES,CHIP	220 5% 1/10W
R229	1-216-033-00	RES,CHIP	220 5% 1/10W	R302	1-216-295-00	SHORT	0
R230	1-216-022-00	RES,CHIP	75 5% 1/10W	R303	1-216-295-00	SHORT	0
R232	1-216-025-00	RES,CHIP	100 5% 1/10W	R304	1-216-129-00	RES,CHIP	2.2M 5% 1/10W
R233	1-216-025-00	RES,CHIP	100 5% 1/10W	R305	1-216-033-00	RES,CHIP	220 5% 1/10W
R234	1-216-113-00	RES,CHIP	470K 5% 1/10W	R308	1-216-025-00	RES,CHIP	100 5% 1/10W
R235	1-216-025-00	RES,CHIP	100 5% 1/10W	R309	1-216-033-00	RES,CHIP	220 5% 1/10W
R236	1-216-113-00	RES,CHIP	470K 5% 1/10W	R310	1-216-033-00	RES,CHIP	220 5% 1/10W
R237	1-216-295-00	SHORT	0	R315	1-216-295-00	SHORT	0
R238	1-216-089-00	RES,CHIP	47K 5% 1/10W	R316	1-216-033-00	RES,CHIP	220 5% 1/10W
R239	1-216-039-00	RES,CHIP	390 5% 1/10W	R320	1-216-025-00	RES,CHIP	100 5% 1/10W
R240	1-216-295-00	SHORT	0	R321	1-216-025-00	RES,CHIP	100 5% 1/10W
R241	1-216-089-00	RES,CHIP	47K 5% 1/10W	R322	1-216-025-00	RES,CHIP	100 5% 1/10W
R242	1-216-039-00	RES,CHIP	390 5% 1/10W	R323	1-216-033-00	RES,CHIP	220 5% 1/10W
R243	1-216-033-00	RES,CHIP	220 5% 1/10W	R325	1-216-089-91	RES,CHIP	47K 5% 1/10W
R244	1-216-033-00	RES,CHIP	220 5% 1/10W	R326	1-216-025-00	RES,CHIP	100 5% 1/10W
R248	1-216-025-00	RES,CHIP	100 5% 1/10W	R327	1-216-025-00	RES,CHIP	100 5% 1/10W
R249	1-216-001-00	RES,CHIP	10 5% 1/10W	R329	1-216-089-00	RES,CHIP	47K 5% 1/10W
				R330	1-216-025-00	RES,CHIP	100 5% 1/10W

The componants identified by shading and mark Δ are critical for safety.
Replace only with part number specified.



REF.NO.	PART NO.	DESCRIPTION	REMARK	REF.NO.	PART NO.	DESCRIPTION	REMARK
R331	1-216-059-00	RES,CHIP	2.7K 5% 1/10W			<TUNER>	
R332	1-216-049-00	RES,CHIP	1K 5% 1/10W	TU101	1-693-340-11	TUNER/VIF	
R333	1-216-067-00	RES,CHIP	5.6K 5% 1/10W			<CRYSTAL>	
R334	1-216-041-00	RES,CHIP	470 5% 1/10W	X1	1-767-154-21	VIBRATOR, CERAMIC (11.5MHz)	
R335	1-216-675-91	METAL CHIP	10K 0.50%1/10W	X201	1-760-628-11	VIBRATOR, CRYSTAL (18.432MHz)	
R336	1-216-109-00	RES,CHIP	330K 5% 1/10W	X301	1-567-504-11	OSCILLATOR, CRYSTAL (4.43MHz)	
R337	1-216-025-00	RES,CHIP	100 5% 1/10W	X302	1-567-505-11	OSCILLATOR, CRYSTAL (3.58MHz)	
R338	1-216-049-00	RES,CHIP	1K 5% 1/10W	X303	1-767-127-11	VIBRATOR, CERAMIC (500kHz)	
R339	1-216-049-00	RES,CHIP	1K 5% 1/10W	X1001	1-579-965-21	VIBRATOR, CRYSTAL (20.48MHz)	
R340	1-216-025-00	RES,CHIP	100 5% 1/10W				
R341	1-216-025-00	RES,CHIP	100 5% 1/10W				
R342	1-216-049-00	RES,CHIP	1K 5% 1/10W				
R343	1-216-061-00	RES,CHIP	3.3K 5% 1/10W	*****			
R344	1-216-067-00	RES,CHIP	5.6K 5% 1/10W			* A-1316-355-A G BOARD, COMPLETE	
R345	1-216-025-00	RES,CHIP	100 5% 1/10W				
R347	1-216-025-00	RES,CHIP	100 5% 1/10W				
R348	1-216-025-00	RES,CHIP	100 5% 1/10W				
R349	1-216-025-00	RES,CHIP	100 5% 1/10W				
R350	1-216-041-00	RES,CHIP	470 5% 1/10W				
R351	1-216-053-00	RES,CHIP	1.5K 5% 1/10W				
R352	1-216-077-91	RES,CHIP	15K 5% 1/10W				
R353	1-216-033-00	RES,CHIP	220 5% 1/10W			4-382-854-11	SCREW (M3X10), P, SW (+)
R354	1-216-295-00	SHORT	0			<CAPACITOR>	
R355	1-216-093-91	RES,CHIP	68K 5% 1/10W	C6001	1-119-894-51	CERAMIC	2200pF 20% 250V
R356	1-216-133-00	RES,CHIP	3.3M 5% 1/10W	C6002 Δ	1-104-706-51	FILM	0.22 μ F 20% 250V
R357	1-216-049-00	RES,CHIP	1K 5% 1/10W	C6003	1-126-943-11	ELECT	2200 μ F 20% 25V
R358	1-216-105-00	RES,CHIP	220K 5% 1/10W	C6004	1-104-665-11	ELECT	100 μ F 20% 25V
R359	1-216-295-00	SHORT	0	C6006 Δ	1-104-706-51	FILM	0.22 μ F 20% 250V
R360	1-216-129-00	RES,CHIP	2.2M 5% 1/10W	C6007	1-119-894-51	CERAMIC	2200pF 20% 250V
R361	1-216-129-00	RES,CHIP	2.2M 5% 1/10W	C6011	1-107-676-91	ELECT	2.2 μ F 20% 450V
R370	1-216-295-00	SHORT	0	C6012	1-102-112-00	CERAMIC	330pF 10% 50V
R371	1-216-033-00	RES,CHIP	220 5% 1/10W	C6018	1-117-753-11	ELECT(BLOCK)	470 μ F 20% 450V
R373	1-216-049-00	RES,CHIP	1K 5% 1/10W	C6019	1-104-664-11	ELECT	47 μ F 20% 25V
R374	1-216-041-00	RES,CHIP	470 5% 1/10W	C6020	1-104-665-11	ELECT	100 μ F 20% 25V
R375	1-216-049-00	RES,CHIP	1K 5% 1/10W	C6021	1-126-961-11	ELECT	2.2 μ F 20% 50V
R376	1-216-081-00	RES,CHIP	22K 5% 1/10W	C6026	1-104-665-11	ELECT	100 μ F 20% 25V
R377	1-216-049-00	RES,CHIP	1K 5% 1/10W	C6030	1-115-405-11	FILM	0.039 μ F 3% 1KV
R378	1-216-680-00	METAL CHIP	16K 0.50%1/10W	C6031	1-126-964-11	ELECT	10 μ F 20% 50V
R379	1-216-041-00	RES,CHIP	470 5% 1/10W	C6032	1-126-964-11	ELECT	10 μ F 20% 50V
R1001	1-216-025-00	RES,CHIP	100 5% 1/10W	C6033	1-136-479-11	FILM	0.001 μ F 2% 50V
R1002	1-216-025-00	RES,CHIP	100 5% 1/10W	C6034	1-101-810-00	CERAMIC	100pF 5% 500V
R1010	1-216-295-00	SHORT	0	C6035	1-101-810-00	CERAMIC	100pF 5% 500V
R1012	1-216-041-00	RES,CHIP	470 5% 1/10W	C6036	1-126-768-11	ELECT	2200 μ F 20% 16V
R1014	1-216-065-00	RES,CHIP	4.7K 5% 1/10W	C6037	1-126-943-11	ELECT	2200 μ F 20% 25V
R1017	1-216-295-00	SHORT	0	C6038	1-128-548-11	ELECT	4700 μ F 20% 25V
R1020	1-216-097-00	RES,CHIP	100K 5% 1/10W	C6039	1-126-972-11	ELECT	1000 μ F 20% 50V
R1021	1-216-029-00	RES,CHIP	150 5% 1/10W	C6040	1-126-972-11	ELECT	1000 μ F 20% 50V
R1022	1-216-029-00	RES,CHIP	150 5% 1/10W	C6041	1-126-960-11	ELECT	1 μ F 20% 50V
R1023	1-216-029-00	RES,CHIP	150 5% 1/10W	C6042	1-104-665-11	ELECT	100 μ F 20% 25V
R1024	1-216-045-00	RES,CHIP	680 5% 1/10W	C6044	1-107-641-11	ELECT	220 μ F 20% 160V
R1026	1-216-025-00	RES,CHIP	100 5% 1/10W	C6045	1-104-665-11	ELECT	100 μ F 20% 25V
R1027	1-216-025-00	RES,CHIP	100 5% 1/10W	C6046	1-104-665-11	ELECT	100 μ F 20% 25V
R1028	1-216-025-00	RES,CHIP	100 5% 1/10W	C6047	1-102-112-00	CERAMIC	330pF 10% 50V
				C6048	1-126-960-11	ELECT	1 μ F 20% 50V
				C6049	1-136-165-00	FILM	0.1 μ F 5% 50V
				C6050	1-109-954-11	ELECT	0.47 μ F 20% 160V
				C6051	1-126-935-11	ELECT	470 μ F 20% 6.3V
				C6052	1-125-969-91	CERAMIC	680pF 10% 1KV



The components identified by shading and mark Δ are critical for safety. Replace only with part number specified.

REF.NO.	PART NO.	DESCRIPTION	REMARK	REF.NO.	PART NO.	DESCRIPTION	REMARK
C6053	1-125-969-91	CERAMIC	680pF 10% 1KV				
C6055	1-107-641-11	ELECT	220μF 20% 160V				
C6058	1-102-114-00	CERAMIC	470pF 10% 50V				
C6059	1-102-114-00	CERAMIC	470pF 10% 50V				
C6060	1-102-114-00	CERAMIC	470pF 10% 50V				
C6061	1-102-114-00	CERAMIC	470pF 10% 50V				
C6062	1-102-114-00	CERAMIC	470pF 10% 50V				
C6063	1-102-114-00	CERAMIC	470pF 10% 50V				
C6064	Δ 1-161-964-91	CERAMIC	0.0047μF 250V				
C6065	Δ 1-161-964-91	CERAMIC	0.0047μF 250V				
<CONNECTOR>							
CN6001	1-695-915-11	TAB (CONTACT)					
CN6002	1-695-915-11	TAB (CONTACT)					
CN6005	*1-580-843-11	PIN, CONNECTOR (POWER)					
CN6006	*1-580-689-11	PIN, CONNECTOR (PC BOARD) 4P					
CN6007	*1-691-291-11	PIN, CONNECTOR (PC BOARD) 5P					
CN6008	*1-564-509-11	PLUG, CONNECTOR 6P					
CN6009	1-695-915-11	TAB (CONTACT)					
CN6011	*1-573-986-11	PIN, CONNECTOR (PC BOARD) 5P					
CN6012	*1-508-766-00	PIN, CONNECTOR (5mm PITCH) 4P					
CN6013	*1-508-765-00	PIN, CONNECTOR (5mm PITCH) 3P					
<DIODE>							
D6002	8-719-052-91	DIODE D4SBS4-F					
D6003	8-719-510-53	DIODE D4SB60L					
D6004	8-719-057-96	DIODE D10SC6M-4012					
D6005	8-719-982-20	DIODE MTZJ-30B					
D6007	8-719-911-55	DIODE U05G					
D6008	8-719-073-23	DIODE ST02D-200TA					
D6012	8-719-991-33	DIODE 1SS133T-77					
D6013	8-719-110-03	DIODE RD7.5ESB2					
D6014	8-719-991-33	DIODE 1SS133T-77					
D6017	8-719-063-73	DIODE D1NL20U-TR					
D6018	8-719-991-33	DIODE 1SS133T-77					
D6025	8-719-063-73	DIODE D1NL20U-TR					
D6032	8-719-991-33	DIODE 1SS133T-77					
D6033	8-719-991-33	DIODE 1SS133T-77					
D6035	8-719-018-83	DIODE D2S4M					
D6036	8-719-018-83	DIODE D2S4M					
D6037	8-719-031-78	DIODE S2L40F					
D6038	8-719-312-47	DIODE RBA-406B					
D6042	8-719-979-64	DIODE UF4005PKG23					
D6043	8-719-110-53	DIODE RD20ESB2					
D6044	8-719-979-64	DIODE UF4005PKG23					
D6045	8-719-110-53	DIODE RD20ESB2					
D6046	8-719-110-53	DIODE RD20ESB2					
D6047	8-719-110-53	DIODE RD20ESB2					
D6048	Δ 8-719-921-88	DIODE MTZJ-13B					
D6049	8-719-031-78	DIODE S2L40F					
D6050	8-719-991-33	DIODE 1SS133T-77					
D6051	8-719-991-33	DIODE 1SS133T-77					
<FUSE>							
F6001	Δ 1-576-232-11	FUSE (H.B.C.) 5A/250V					
	* 1-533-725-11	HOLDER, FUSE ; F6001					
<FERRITE BEAD>							
FB6009	1-410-397-21	FERRITE				1.1μH	
<IC>							
IC6001	Δ 8-759-468-89	IC TOP209P					
IC6004	8-759-537-24	IC KA7500B					
IC6005	8-749-924-35	PHOTO COUPLER ON3171-R					
IC6006	8-749-924-35	PHOTO COUPLER ON3171-R					
IC6007	8-759-185-47	IC IR2112					
IC6008	8-749-920-61	IC SE-135N					
<COIL>							
L6002	1-412-525-31	INDUCTOR				10μH	
L6003	1-412-525-31	INDUCTOR				10μH	
L6004	1-412-525-31	INDUCTOR				10μH	
L6005	1-412-525-31	INDUCTOR				10μH	
L6006	1-412-525-31	INDUCTOR				10μH	
L6008	1-412-533-21	INDUCTOR				47μH	
L6009	1-412-523-41	INDUCTOR				6.8μH	
L6010	1-412-523-41	INDUCTOR				6.8μH	
L6011	1-412-525-31	INDUCTOR				10μH	
<IC LINK>							
PS6001	Δ 1-533-595-31	LINK, IC (3.15A/90V AC, 60V DC)					
PS6002	Δ 1-533-595-31	LINK, IC (3.15A/90V AC, 60V DC)					
PS6003	Δ 1-533-597-31	LINK, IC (5A/90V AC, 60V DC)					
<TRANSISTOR>							
Q6001	8-729-120-28	TRANSISTOR 2SC1623-L5L6					
Q6002	8-729-120-28	TRANSISTOR 2SC1623-L5L6					
Q6003	8-729-920-72	TRANSISTOR 2SA1037K-T-146-QR					
Q6005	8-729-920-72	TRANSISTOR 2SA1037K-T-146-QR					
Q6009	8-729-140-97	TRANSISTOR 2SB734-34					
Q6010	8-729-120-28	TRANSISTOR 2SC1623-L5L6					
Q6011	8-729-120-28	TRANSISTOR 2SC1623-L5L6					
Q6012	8-729-920-72	TRANSISTOR 2SA1037K-T-146-QR					
Q6013	8-729-820-82	TRANSISTOR 2SA1208-T					
Q6014	8-729-028-10	TRANSISTOR IRFI744G-LF					
Q6015	8-729-028-10	TRANSISTOR IRFI744G-LF					
<RESISTOR>							
R6000	Δ 1-202-885-91	SOLID	1M 20% 1/2W				
R6001	1-216-049-00	RES,CHIP	1K 5% 1/10W				
R6002	1-218-265-11	METAL	8.2M 5% 1W				
R6008	1-216-099-00	RES,CHIP	120K 5% 1/10W				
R6009	1-215-479-00	METAL	270K 1% 1/4W				

The components identified by shading and mark Δ are critical for safety.
 Replace only with part number specified.



REF.NO.	PART NO.	DESCRIPTION	REMARK	REF.NO.	PART NO.	DESCRIPTION	REMARK
R6010	1-215-479-00	METAL	270K	1%	1/4W		
R6013	1-202-968-11	CEMENTED	1.2	5%	10W		
R6014	1-216-089-00	RES,CHIP	47K	5%	1/10W		
R6018	1-216-089-00	RES,CHIP	47K	5%	1/10W		
R6019	1-216-089-00	RES,CHIP	47K	5%	1/10W		
R6022	1-247-791-91	CARBON	22	5%	1/4W		
R6024 Δ	1-205-998-11	CEMENTED	1	5%	10W		
R6026 Δ	1-205-998-11	CEMENTED	1	5%	10W		
R6027	1-216-065-00	RES,CHIP	4.7K	5%	1/10W		
R6032 Δ	1-202-933-61	FUSIBLE	0.1	10%	1/2W	F	
R6034	1-216-113-00	RES,CHIP	470K	5%	1/10W		
R6045	1-216-657-11	METAL CHIP	1.8K	0.50%	1/10W		
R6046	1-216-081-00	RES,CHIP	22K	5%	1/10W		
R6047	1-249-437-11	CARBON	47K	5%	1/4W		
R6048	1-216-065-00	RES,CHIP	4.7K	5%	1/10W		
R6049	1-216-073-00	RES,CHIP	10K	5%	1/10W		
R6050	1-216-049-91	RES,CHIP	1K	5%	1/10W		
R6051	1-216-674-11	METAL CHIP	9.1K	0.50%	1/10W		
R6052	1-216-049-00	RES,CHIP	1K	5%	1/10W		
R6053	1-249-417-11	CARBON	1K	5%	1/4W		
R6054	1-216-049-00	RES,CHIP	1K	5%	1/10W		
R6055	1-216-065-00	RES,CHIP	4.7K	5%	1/10W		
R6056	1-216-073-00	RES,CHIP	10K	5%	1/10W		
R6057	1-216-073-00	RES,CHIP	10K	5%	1/10W		
R6058	1-216-073-00	RES,CHIP	10K	5%	1/10W		
R6059	1-216-065-00	RES,CHIP	4.7K	5%	1/10W		
R6060	1-249-413-11	CARBON	470	5%	1/4W	F	
R6061	1-215-477-00	METAL	220K	1%	1/4W		
R6062	1-249-417-11	CARBON	1K	5%	1/4W	F	
R6063	1-249-397-11	CARBON	22	5%	1/4W	F	
R6064	1-249-397-11	CARBON	22	5%	1/4W	F	
R6065	1-249-441-11	CARBON	100K	5%	1/4W		
R6066	1-216-366-00	METAL OXIDE	0.56	5%	2W	F	
R6067	1-249-425-11	CARBON	4.7K	5%	1/4W	F	
R6068	1-249-425-11	CARBON	4.7K	5%	1/4W	F	
R6069	1-215-477-00	METAL	220K	1%	1/4W		
R6070	1-249-417-11	CARBON	1K	5%	1/4W	F	
R6071	1-215-453-00	METAL	22K	1%	1/4W		
R6072	1-215-476-00	METAL	200K	1%	1/4W		
R6073	1-216-041-00	RES,CHIP	470	5%	1/10W		
R6075	1-216-353-00	METAL OXIDE	2.2	5%	1W	F	
R6079	1-249-377-11	CARBON	0.47	5%	1/4W	F	
R6080	1-249-377-11	CARBON	0.47	5%	1/4W	F	
R6081	1-249-377-11	CARBON	0.47	5%	1/4W	F	
R6082	1-249-377-11	CARBON	0.47	5%	1/4W	F	
R6083	1-249-377-11	CARBON	0.47	5%	1/4W	F	
R6084	1-249-377-11	CARBON	0.47	5%	1/4W	F	
R6085 Δ	1-212-849-61	FUSIBLE	4.7	5%	1/4W	F	
R6086	1-216-073-00	RES,CHIP	10K	5%	1/10W		
<TRANSFORMER>							
T6002 Δ	1-424-682-11	TRANSFORMER, LINE FILTER					
T6004 Δ	1-431-732-21	TRANSFORMER, CONVERTER (SRT)					
T6005 Δ	1-429-807-12	TRANSFORMER, CONVERTER (PIT)					
				* A-1331-734-A CR BOARD, COMPLETE *****			
				<CAPACITOR>			
C702	1-102-113-00	CERAMIC	390pF	10%	50V		
C703	1-104-664-11	ELECT	47 μ F	20%	25V		
C705	1-161-754-00	CERAMIC	0.001 μ F	10%	2KV		
C708	1-101-880-00	CERAMIC	47pF	5%	50V		
C709	1-162-115-00	CERAMIC	330pF	10%	2KV		
C710	1-102-114-00	CERAMIC	470pF	10%	50V		
C712	1-107-662-11	ELECT	22 μ F	20%	250V		
C713	1-104-664-11	ELECT	47 μ F	20%	25V		
				<CONNECTOR>			
CN701	1-695-915-11	TAB (CONTACT)					
CN702	*1-564-511-11	PLUG, CONNECTOR 8P					
CN703	*1-564-510-11	PLUG, CONNECTOR 7P					
CN704	*1-508-784-00	PIN, CONNECTOR (5mm PITCH) 1P					
CN705 Δ	1-251-182-21	SOCKET, PICTURE TUBE					
CN706	*1-564-512-11	PLUG, CONNECTOR 9P					
				<DIODE>			
D701	8-719-991-33	DIODE	1SS133T-77				
D704	8-719-991-33	DIODE	1SS133T-77				
D705	8-719-991-33	DIODE	1SS133T-77				
D706	8-719-991-33	DIODE	1SS133T-77				
D708	8-719-991-33	DIODE	1SS133T-77				
D709	8-719-109-84	DIODE	RD5.1ESB1				
				<COIL>			
L701	1-410-682-31	INDUCTOR			470 μ H		
L702	1-408-619-31	INDUCTOR			220 μ H		
				<TRANSISTOR>			
Q701	8-729-200-17	TRANSISTOR 2SA1091-O					
Q703	8-729-045-56	TRANSISTOR 2SC2611-15					
Q704	8-729-119-78	TRANSISTOR 2SC2785-HFE					
Q705	8-729-119-76	TRANSISTOR 2SA1175-HFE					
Q706	8-729-119-76	TRANSISTOR 2SA1175-HFE					
				<RESISTOR>			
R701	1-219-743-11	CARBON	100	5%	1/2W		
R704	1-260-132-11	CARBON	560K	5%	1/2W		
R706	1-249-425-11	CARBON	4.7K	5%	1/4W		
R707	1-247-807-31	CARBON	100	5%	1/4W		
R708	1-249-411-11	CARBON	330	5%	1/4W		
R709	1-260-099-11	CARBON	1K	5%	1/2W		
R710	1-249-393-11	CARBON	10	5%	1/4W		
R711	1-215-923-00	METAL OXIDE	10K	5%	3W	F	
R714	1-202-818-00	SOLID	1K	20%	1/2W		

KP-41S5/41S5B/41S5G/
41S5K/41S5R/41S5U

RM-862



The components identified by shading and mark Δ are critical for safety. Replace only with part number specified.

REF.NO.	PART NO.	DESCRIPTION	REMARK	REF.NO.	PART NO.	DESCRIPTION	REMARK
R715	1-260-133-11	CARBON	680K 5% 1/2W			<TRANSISTOR>	
R716	1-247-815-91	CARBON	220 5% 1/4W	Q731	8-729-200-17	TRANSISTOR 2SA1091-O	
R717	1-249-435-11	CARBON	33K 5% 1/4W	Q732	8-729-045-56	TRANSISTOR 2SC2611-15	
R718	1-249-437-11	CARBON	47K 5% 1/4W	Q733	8-729-119-78	TRANSISTOR 2SC2785-HFE	
R719	1-219-743-11	CARBON	100 5% 1/2W			<RESISTOR>	
R720	1-249-425-11	CARBON	4.7K 5% 1/4W				
R721	1-202-814-11	SOLID	33K 20% 1/2W	R731	1-219-743-11	CARBON	100 5% 1/2W
R722	1-247-863-91	CARBON	22K 5% 1/4W	R732	1-260-132-11	CARBON	560K 5% 1/2W
R723	1-249-437-11	CARBON	47K 5% 1/4W	R733	1-215-923-00	METAL OXIDE	10K 5% 3W F
		<SPARK GAP>		R735	1-247-807-31	CARBON	100 5% 1/4W
SG701	1-519-422-11	GAP, SPARK		R736	1-249-425-11	CARBON	4.7K 5% 1/4W
SG702	1-519-422-11	GAP, SPARK		R737	1-260-099-11	CARBON	1K 5% 1/2W
SG703	1-519-422-11	GAP, SPARK		R738	1-249-408-11	CARBON	180 5% 1/4W
				R739	1-260-133-11	CARBON	680K 5% 1/2W
				R740	1-202-818-00	SOLID	1K 20% 1/2W
				R741	1-249-393-11	CARBON	10 5% 1/4W
*****				R742	1-247-815-91	CARBON	220 5% 1/4W
		* A-1331-735-ACG BOARD, COMPLETE		R744	1-247-891-00	CARBON	330K 5% 1/4W
		*****		R745	1-247-843-11	CARBON	3.3K 5% 1/4W
				R746	1-202-814-11	SOLID	33K 20% 1/2W
		<CAPACITOR>				<SPARK GAP>	
C733	1-161-754-00	CERAMIC	0.001 μ F 10% 2KV	SG731	1-519-422-11	GAP, SPARK	
C734	1-102-114-00	CERAMIC	470pF 10% 50V	SG732	1-519-422-11	GAP, SPARK	
C735	1-161-830-00	CERAMIC	0.0047 μ F 500V	SG733	1-519-422-11	GAP, SPARK	
C736	1-162-115-00	CERAMIC	330pF 10% 2KV				
C737	1-107-662-11	ELECT	22 μ F 20% 250V	*****			
C738	1-101-880-00	CERAMIC	47pF 5% 50V			* A-1331-736-ACB BOARD, COMPLETE	
C739	1-104-664-11	ELECT	47 μ F 20% 25V			*****	
C740	1-102-114-00	CERAMIC	470pF 10% 50V			<CAPACITOR>	
		<CONNECTOR>		C762	1-126-964-11	ELECT	10 μ F 20% 50V
CN731	1-695-915-11	TAB (CONTACT)		C763	1-161-754-00	CERAMIC	0.001 μ F 10% 2KV
CN732	*1-564-508-11	PLUG, CONNECTOR 5P		C764	1-102-112-00	CERAMIC	330pF 10% 50V
CN733	*1-564-511-11	PLUG, CONNECTOR 8P		C765	1-161-830-00	CERAMIC	0.0047 μ F 500V
CN734	*1-508-784-00	PIN, CONNECTOR (5mm PITCH) 1P		C766	1-162-115-00	CERAMIC	330pF 10% 2KV
CN735	Δ 1-251-182-21	SOCKET, PICTURE TUBE		C767	1-107-662-11	ELECT	22 μ F 20% 250V
CN736	*1-564-512-11	PLUG, CONNECTOR 9P		C768	1-101-880-00	CERAMIC	47pF 5% 50V
CN737	*1-564-512-11	PLUG, CONNECTOR 9P		C769	1-104-664-11	ELECT	47 μ F 20% 25V
		<DIODE>		C770	1-102-114-00	CERAMIC	470pF 10% 50V
D731	8-719-991-33	DIODE 1SS133T-77				<CONNECTOR>	
D732	8-719-991-33	DIODE 1SS133T-77		CN761	1-695-915-11	TAB (CONTACT)	
D733	8-719-991-33	DIODE 1SS133T-77		CN762	*1-564-508-11	PLUG, CONNECTOR 5P	
D735	8-719-991-33	DIODE 1SS133T-77		CN763	*1-508-784-00	PIN, CONNECTOR (5mm PITCH) 1P	
D736	8-719-991-33	DIODE 1SS133T-77		CN764	Δ 1-251-182-21	SOCKET, PICTURE TUBE	
		<COIL>		CN765	*1-564-512-11	PLUG, CONNECTOR 9P	
L731	1-408-623-31	INDUCTOR	470 μ H	CN766	1-564-513-11	PLUG, CONNECTOR 10P	
L732	1-408-619-31	INDUCTOR	220 μ H				



REF.NO.	PART NO.	DESCRIPTION	REMARK	REF.NO.	PART NO.	DESCRIPTION	REMARK
<DIODE>				<CAPACITOR>			
D761	8-719-991-33	DIODE 1SS133T-77		C1501	1-163-005-11	CERAMIC CHIP 470pF	10% 50V
D762	8-719-991-33	DIODE 1SS133T-77		C1503	1-137-399-11	FILM 0.1μF	5% 100V
D763	8-719-991-33	DIODE 1SS133T-77		C1504	1-164-690-91	CERAMIC CHIP 0.0022μF	5% 50V
D765	8-719-991-33	DIODE 1SS133T-77		C1506	1-126-969-11	ELECT 220μF	20% 50V
D766	8-719-991-33	DIODE 1SS133T-77		C1507	1-163-243-11	CERAMIC CHIP 47pF	5% 50V
<COIL>				C1508	1-137-401-11	FILM 0.22μF	10% 100V
L761	1-408-623-31	INDUCTOR	470μH	C1509	1-163-251-11	CERAMIC CHIP 100pF	5% 50V
L762	1-408-619-31	INDUCTOR	220μH	C1510	1-126-972-11	ELECT 1000μF	20% 50V
<TRANSISTOR>				C1511	1-126-972-11	ELECT 1000μF	20% 50V
Q761	8-729-200-17	TRANSISTOR 2SA1091-O		C1512	1-126-960-11	ELECT 1μF	20% 50V
Q762	8-729-045-56	TRANSISTOR 2SC2611-15		C1513	1-164-232-11	CERAMIC CHIP 0.01μF	10% 50V
Q763	8-729-119-78	TRANSISTOR 2SC2785-HFE		C1514	1-164-232-11	CERAMIC CHIP 0.01μF	10% 50V
Q764	8-729-119-76	TRANSISTOR 2SA1175-HFE		C1516	1-164-004-11	CERAMIC CHIP 0.1μF	10% 25V
<RESISTOR>				C1517	1-126-964-11	ELECT 10μF	20% 50V
R761	1-219-743-11	CARBON 100	5% 1/2W	C1518	1-126-933-11	ELECT 100μF	20% 16V
R762	1-260-132-11	CARBON 560K	5% 1/2W	C1519	1-126-933-11	ELECT 100μF	20% 16V
R763	1-215-923-00	METAL OXIDE 10K	5% 3W F	C1520	1-126-964-11	ELECT 10μF	20% 50V
R765	1-247-807-31	CARBON 100	5% 1/4W	C1521	1-164-232-11	CERAMIC CHIP 0.01μF	10% 50V
R766	1-260-099-11	CARBON 1K	5% 1/2W	C1523	1-163-243-11	CERAMIC CHIP 47pF	5% 50V
R767	1-249-425-11	CARBON 4.7K	5% 1/4W	C1524	1-136-177-00	FILM 1μF	5% 50V
R768	1-260-133-11	CARBON 680K	5% 1/2W	C1525	1-104-665-11	ELECT 100μF	20% 25V
R769	1-202-818-00	SOLID 1K	20% 1/2W	C1526	1-104-664-11	ELECT 47μF	20% 25V
R770	1-247-815-91	CARBON 220	5% 1/4W	C1527	1-163-145-00	CERAMIC CHIP 0.0015μF	5% 50V
R771	1-219-743-11	CARBON 100	5% 1/2W	C1528	1-163-145-00	CERAMIC CHIP 0.0015μF	5% 50V
R772	1-249-393-11	CARBON 10	5% 1/4W	C1529	1-164-690-91	CERAMIC CHIP 0.0022μF	5% 50V
R773	1-249-413-11	CARBON 470	5% 1/4W	C1530	1-104-664-11	ELECT 47μF	20% 16V
R774	1-247-895-91	CARBON 470K	5% 1/4W	C1531	1-164-232-11	CERAMIC CHIP 0.01μF	10% 50V
R775	1-249-427-11	CARBON 6.8K	5% 1/4W	C1532	1-126-960-11	ELECT 1μF	20% 50V
R776	1-249-437-11	CARBON 47K	5% 1/4W	C1601	1-163-009-11	CERAMIC CHIP 0.001μF	10% 50V
R777	1-249-427-11	CARBON 6.8K	5% 1/4W	C1602	1-163-009-11	CERAMIC CHIP 0.001μF	10% 50V
R778	1-202-814-11	SOLID 33K	20% 1/2W	C1603	1-130-495-00	FILM 0.1μF	5% 50V
R779	1-247-815-91	CARBON 220	5% 1/4W	C1604	1-130-495-00	FILM 0.1μF	5% 50V
<SPARK GAP>				C1605	1-107-715-11	ELECT 22μF	20% 50V
SG761	1-519-422-11	GAP, SPARK		C1606	1-164-232-11	CERAMIC CHIP 0.01μF	10% 50V
SG762	1-519-422-11	GAP, SPARK		C1607	1-137-370-11	FILM 0.01μF	5% 50V
SG763	1-519-422-11	GAP, SPARK		C1610	1-126-960-11	ELECT 1μF	20% 50V
*****				C1611	1-126-960-11	ELECT 1μF	20% 50V
* A-1346-678-AD BOARD, COMPLETE				C1612	1-126-960-11	ELECT 1μF	20% 50V
				C1613	1-126-967-11	ELECT 47μF	20% 50V
				C1614	1-126-967-11	ELECT 47μF	20% 50V
4-201-023-11		SPACER, INSULATING		C1617	1-130-495-00	FILM 0.1μF	5% 50V
4-202-373-01		SPRING, IC		C1618	1-130-495-00	FILM 0.1μF	5% 50V
4-382-854-11		SCREW (M3X10), P, SW (+)		C1619	1-164-004-11	CERAMIC CHIP 0.1μF	10% 25V
				C1621	1-104-665-11	ELECT 100μF	20% 25V
				C1622	1-164-690-91	CERAMIC CHIP 0.0022μF	5% 50V
				C1624	1-130-495-00	FILM 0.1μF	5% 50V
				C1626	1-130-495-00	FILM 0.1μF	5% 50V
				C1627	1-164-690-91	CERAMIC CHIP 0.0022μF	5% 50V
				C1628	1-126-964-11	ELECT 10μF	20% 50V
				C1630	1-128-550-21	ELECT 2200μF	20% 50V
				C1631	1-128-550-21	ELECT 2200μF	20% 50V
				C1632	1-104-664-11	ELECT 47μF	20% 25V
				C1633	1-104-664-11	ELECT 47μF	20% 25V
				C1634	1-126-961-11	ELECT 2.2μF	20% 50V
				C1635	1-104-666-11	ELECT 220μF	20% 25V

KP-41S5/41S5B/41S5G/
41S5K/41S5R/41S5U

RM-862



REF.NO.	PART NO.	DESCRIPTION	REMARK	REF.NO.	PART NO.	DESCRIPTION	REMARK
C1650	1-163-251-11	CERAMIC CHIP 100pF	5% 50V			<CONNECTOR>	
C1651	1-163-251-11	CERAMIC CHIP 100pF	5% 50V				
C1701	1-126-960-11	ELECT 1μF	20% 50V	CN1501	*1-564-506-11	PLUG, CONNECTOR 3P	
C1702	1-126-960-11	ELECT 1μF	20% 50V	CN1502	1-695-915-11	TAB (CONTACT)	
C1703	1-126-964-11	ELECT 10μF	20% 50V	CN1601	*1-564-508-11	PLUG, CONNECTOR 5P	
				CN1604	*1-564-507-11	PLUG, CONNECTOR 4P	
C1704	1-126-964-11	ELECT 10μF	20% 50V	CN1605	*1-508-766-00	PIN, CONNECTOR (5mm PITCH) 4P	
C1705	1-163-251-11	CERAMIC CHIP 100pF	5% 50V				
C1706	1-163-251-11	CERAMIC CHIP 100pF	5% 50V	CN1606	*1-779-890-11	CONNECTOR, BOARD TO BOARD 10P	
C1707	1-164-232-11	CERAMIC CHIP 0.01μF	10% 50V	CN1701	*1-564-511-11	PLUG, CONNECTOR 8P	
C1708	1-126-935-11	ELECT 470μF	20% 16V	CN1702	*1-564-516-11	PLUG, CONNECTOR 13P	
				CN1703	*1-779-890-11	CONNECTOR, BOARD TO BOARD 10P	
C1709	1-164-232-11	CERAMIC CHIP 0.01μF	10% 50V	CN1705	*1-564-505-11	PLUG, CONNECTOR 2P	
C1710	1-163-243-11	CERAMIC CHIP 47pF	5% 50V				
C1711	1-163-243-11	CERAMIC CHIP 47pF	5% 50V	CN1708	*1-564-510-11	PLUG, CONNECTOR 7P	
C1715	1-164-232-11	CERAMIC CHIP 0.01μF	10% 50V	CN1801	1-695-299-11	CONNECTOR, BOARD TO BOARD 50P	
C1716	1-164-232-11	CERAMIC CHIP 0.01μF	10% 50V	CN1802	*1-764-334-11	PLUG, CONNECTOR 11P	
				CN1803	1-564-513-11	PLUG, CONNECTOR 10P	
C1717	1-164-232-11	CERAMIC CHIP 0.01μF	10% 50V	CN1804	*1-564-508-11	PLUG, CONNECTOR 5P	
C1718	1-126-968-11	ELECT 100μF	20% 50V				
C1719	1-126-968-11	ELECT 100μF	20% 50V	CN1805	*1-779-890-11	CONNECTOR, BOARD TO BOARD 10P	
C1720	1-164-232-11	CERAMIC CHIP 0.01μF	10% 50V	CN1806	*1-779-890-11	CONNECTOR, BOARD TO BOARD 10P	
C1721	1-164-232-11	CERAMIC CHIP 0.01μF	10% 50V	CN1807	*1-564-511-11	PLUG, CONNECTOR 8P	
				CN1808	*1-564-510-11	PLUG, CONNECTOR 7P	
C1723	1-163-235-11	CERAMIC CHIP 22pF	5% 50V				
C1724	1-164-004-11	CERAMIC CHIP 0.1μF	10% 25V			<DIODE>	
C1725	1-164-004-11	CERAMIC CHIP 0.1μF	10% 25V	D1501	8-719-109-89	DIODE RD5.6ESB2	
C1726	1-164-004-11	CERAMIC CHIP 0.1μF	10% 25V	D1502	8-719-908-03	DIODE GP08D	
C1727	1-164-004-11	CERAMIC CHIP 0.1μF	10% 25V	D1503	8-719-908-03	DIODE GP08D	
				D1504	8-719-991-33	DIODE 1SS133T-77	
C1802	1-164-232-11	CERAMIC CHIP 0.01μF	10% 50V	D1505	8-719-988-61	DIODE 1SS355TE-17	
C1803	1-126-935-11	ELECT 470μF	20% 16V				
C1804	1-126-964-11	ELECT 10μF	20% 50V	D1601	8-719-991-33	DIODE 1SS133T-77	
C1805	1-164-232-11	CERAMIC CHIP 0.01μF	10% 50V	D1603	8-719-991-33	DIODE 1SS133T-77	
C1806	1-104-665-11	ELECT 100μF	20% 25V	D1604	8-719-991-33	DIODE 1SS133T-77	
				D1606	8-719-991-33	DIODE 1SS133T-77	
C1807	1-126-964-11	ELECT 10μF	20% 50V	D1611	8-719-921-86	DIODE MTZJ-13	
C1808	1-164-232-11	CERAMIC CHIP 0.01μF	10% 50V				
C1809	1-104-665-11	ELECT 100μF	20% 25V	D1612	8-719-991-33	DIODE 1SS133T-77	
C1810	1-164-232-11	CERAMIC CHIP 0.01μF	10% 50V	D1613	8-719-921-86	DIODE MTZJ-13	
C1811	1-104-665-11	ELECT 100μF	20% 25V	D1614	8-719-991-33	DIODE 1SS133T-77	
				D1615	8-719-991-33	DIODE 1SS133T-77	
C1812	1-126-964-11	ELECT 10μF	20% 50V	D1616	8-719-991-33	DIODE 1SS133T-77	
C1813	1-104-666-11	ELECT 220μF	20% 25V				
C1814	1-164-004-11	CERAMIC CHIP 0.1μF	10% 25V	D1617	8-719-403-00	DIODE MA3240-TX	
C1815	1-104-666-11	ELECT 220μF	20% 25V	D1618	8-719-991-33	DIODE 1SS133T-77	
C1816	1-126-964-11	ELECT 10μF	20% 50V	D1619	8-719-991-33	DIODE 1SS133T-77	
				D1620	8-719-403-00	DIODE MA3240-TX	
C1817	1-126-964-11	ELECT 10μF	20% 50V	D1621	8-719-403-00	DIODE MA3240-TX	
C1818	1-164-232-11	CERAMIC CHIP 0.01μF	10% 50V				
C1819	1-163-133-00	CERAMIC CHIP 470pF	5% 50V	D1622	8-719-403-00	DIODE MA3240-TX	
C1820	1-163-133-00	CERAMIC CHIP 470pF	5% 50V	D1703	8-719-109-89	DIODE RD5.6ESB2	
C1821	1-126-964-11	ELECT 10μF	20% 50V	D1704	8-719-109-89	DIODE RD5.6ESB2	
				D1705	8-719-109-84	DIODE RD5.1ESB1	
C1822	1-164-005-11	CERAMIC CHIP 0.47μF	25V	D1706	8-719-109-84	DIODE RD5.1ESB1	
C1823	1-163-251-11	CERAMIC CHIP 100pF	5% 50V				
C1824	1-164-005-11	CERAMIC CHIP 0.47μF	25V	D1707	8-719-109-84	DIODE RD5.1ESB1	
C1825	1-163-251-11	CERAMIC CHIP 100pF	5% 50V	D1708	8-719-109-84	DIODE RD5.1ESB1	
C1826	1-104-665-11	ELECT 100μF	20% 25V	D1709	8-719-109-81	DIODE RD4.7ESB2	
				D1710	8-719-109-81	DIODE RD4.7ESB2	
C1827	1-104-664-11	ELECT 47μF	20% 25V	D1711	8-719-109-81	DIODE RD4.7ESB2	
C1828	1-104-664-11	ELECT 47μF	20% 25V				
C1829	1-104-664-11	ELECT 47μF	20% 25V	D1712	8-719-109-81	DIODE RD4.7ESB2	
C1830	1-126-964-11	ELECT 10μF	20% 50V	D1801	8-719-923-60	DIODE MTZJ-T-77-9.1A	
				D1802	8-719-923-60	DIODE MTZJ-T-77-9.1A	
				D1803	8-719-923-60	DIODE MTZJ-T-77-9.1A	



REF.NO.	PART NO.	DESCRIPTION	REMARK	REF.NO.	PART NO.	DESCRIPTION	REMARK
D1804	8-719-923-60	DIODE MTZJ-T-77-9.1A		Q1602	8-729-120-28	TRANSISTOR 2SC1623-L5L6	
D1805	8-719-923-60	DIODE MTZJ-T-77-9.1A		Q1603	8-729-027-56	TRANSISTOR DTC143TKA-T146	
D1806	8-719-923-60	DIODE MTZJ-T-77-9.1A		Q1604	8-729-027-56	TRANSISTOR DTC143TKA-T146	
	<IC>			Q1605	8-729-027-56	TRANSISTOR DTC143TKA-T146	
IC1501	8-759-192-71	IC STV9379		Q1607	8-729-120-28	TRANSISTOR 2SC1623-L5L6	
IC1502	8-759-251-31	IC CA0007AM		Q1608	8-729-120-28	TRANSISTOR 2SC1623-L5L6	
IC1503	8-759-998-98	IC LM358D		Q1609	1-801-806-11	TRANSISTOR DTC144EKA-T146	
IC1602	8-759-250-68	IC TDA7264		Q1610	8-729-920-72	TRANSISTOR 2SA1037K-T-146-QR	
IC1603	8-759-502-21	IC TDA2822M		Q1611	8-729-027-56	TRANSISTOR DTC143TKA-T146	
IC1701	8-752-908-27	IC CXP86213-003S		Q1612	8-729-027-56	TRANSISTOR DTC143TKA-T146	
IC1702	8-759-527-76	IC M24C08-MN6T		Q1613	8-729-027-56	TRANSISTOR DTC143TKA-T146	
IC1703	8-759-100-96	IC μPC4558G2		Q1614	8-729-920-72	TRANSISTOR 2SA1037K-T-146-QR	
IC1704	8-759-100-96	IC μPC4558G2		Q1615	8-729-120-28	TRANSISTOR 2SC1623-L5L6	
IC1706	8-759-352-91	IC PST9143NL		Q1616	8-729-120-28	TRANSISTOR 2SC1623-L5L6	
IC1801	8-759-144-82	IC μPC2405HF		Q1617	8-729-920-72	TRANSISTOR 2SA1037K-T-146-QR	
IC1802	8-759-095-63	IC PQ09RF2		Q1701	8-729-120-28	TRANSISTOR 2SC1623-L5L6	
IC1803	8-759-231-58	IC TA7812S		Q1702	8-729-120-28	TRANSISTOR 2SC1623-L5L6	
IC1804	8-759-069-28	IC PQ05RF11		Q1703	8-729-120-28	TRANSISTOR 2SC1623-L5L6	
IC1805	8-759-100-96	IC μPC4558G2		Q1704	8-729-120-28	TRANSISTOR 2SC1623-L5L6	
	<JACK>			Q1705	8-729-120-28	TRANSISTOR 2SC1623-L5L6	
J1601	1-784-653-11	JACK, PHONO 2P		Q1706	8-729-120-28	TRANSISTOR 2SC1623-L5L6	
	<CHIP, CONDUCTOR>			Q1707	1-801-806-11	TRANSISTOR DTC144EKA-T146	
JR1502	1-216-295-91	SHORT	0	Q1708	8-729-027-38	TRANSISTOR DTA144EKA-T146	
JR1503	1-216-295-91	SHORT	0	Q1709	8-729-120-28	TRANSISTOR 2SC1623-L5L6	
JR1504	1-216-295-91	SHORT	0	Q1710	8-729-120-28	TRANSISTOR 2SC1623-L5L6	
JR1505	1-216-295-91	SHORT	0	Q1711	8-729-120-28	TRANSISTOR 2SC1623-L5L6	
JR1506	1-216-295-91	SHORT	0	Q1801	8-729-120-28	TRANSISTOR 2SC1623-L5L6	
JR1508	1-216-295-91	SHORT	0	Q1802	8-729-120-28	TRANSISTOR 2SC1623-L5L6	
JR1510	1-216-295-91	SHORT	0	Q1803	8-729-120-28	TRANSISTOR 2SC1623-L5L6	
JR1511	1-216-295-91	SHORT	0	Q1804	8-729-120-28	TRANSISTOR 2SC1623-L5L6	
JR1512	1-216-295-91	SHORT	0	Q1805	8-729-120-28	TRANSISTOR 2SC1623-L5L6	
JR1513	1-216-295-91	SHORT	0	Q1806	8-729-120-28	TRANSISTOR 2SC1623-L5L6	
JR1514	1-216-295-91	SHORT	0	Q1807	8-729-120-28	TRANSISTOR 2SC1623-L5L6	
JR1701	1-216-295-91	SHORT	0	Q1808	8-729-920-72	TRANSISTOR 2SA1037K-T-146-QR	
	<COIL>			Q1809	8-729-120-28	TRANSISTOR 2SC1623-L5L6	
L1501	1-412-524-11	INDUCTOR	8.2μH		<RESISTOR>		
L1601	1-402-711-11	INDUCTOR	0μH	R1501	1-216-353-00	METAL OXIDE 2.2	5% 1W F
L1602	1-402-711-11	INDUCTOR	0μH	R1502	1-216-671-11	METAL CHIP 6.8K	0.50%1/10W
L1701	1-408-603-31	INDUCTOR	10μH	R1504	1-216-675-91	METAL CHIP 10K	0.50%1/10W
L1702	1-408-598-31	INDUCTOR	3.9μH	R1505	1-249-377-11	CARBON 0.47	5% 1/4W F
L1801	1-408-603-31	INDUCTOR	10μH	R1506	1-215-888-00	METAL OXIDE 220	5% 2W F
	<TRANSISTOR>			R1507	1-216-081-00	RES,CHIP 22K	5% 1/10W
Q1501	8-729-120-28	TRANSISTOR 2SC1623-L5L6		R1508	1-249-383-11	CARBON 1.5	5% 1/4W F
Q1502	8-729-920-72	TRANSISTOR 2SA1037K-T-146-QR		R1509	1-216-671-11	METAL CHIP 6.8K	0.50%1/10W
Q1503	8-729-120-28	TRANSISTOR 2SC1623-L5L6		R1510	1-216-675-91	METAL CHIP 10K	0.50%1/10W
Q1505	8-729-120-28	TRANSISTOR 2SC1623-L5L6		R1511	1-216-057-00	RES,CHIP 2.2K	5% 1/10W
Q1601	8-729-027-56	TRANSISTOR DTC143TKA-T146		R1512	1-216-085-00	RES,CHIP 33K	5% 1/10W
				R1513	1-216-049-00	RES,CHIP 1K	5% 1/10W
				R1514	1-216-073-00	RES,CHIP 10K	5% 1/10W
				R1515	1-216-073-00	RES,CHIP 10K	5% 1/10W
				R1516	1-216-073-00	RES,CHIP 10K	5% 1/10W
				R1517	1-216-081-00	RES,CHIP 22K	5% 1/10W
				R1518	1-216-353-00	METAL OXIDE 2.2	5% 1W F
				R1519	1-216-073-00	RES,CHIP 10K	5% 1/10W
				R1520	1-216-089-00	RES,CHIP 47K	5% 1/10W

KP-41S5/41S5B/41S5G/
41S5K/41S5R/41S5U

RM-862



REF.NO.	PART NO.	DESCRIPTION	REMARK	REF.NO.	PART NO.	DESCRIPTION	REMARK
R1521	1-216-097-00	RES,CHIP	100K 5% 1/10W	R1650	1-216-033-00	RES,CHIP	220 5% 1/10W
R1522	1-216-089-91	RES,CHIP	47K 5% 1/10W	R1651	1-216-073-00	RES,CHIP	10K 5% 1/10W
R1525	1-216-083-00	RES,CHIP	27K 5% 1/10W	R1652	1-216-099-00	RES,CHIP	120K 5% 1/10W
R1526	1-216-083-00	RES,CHIP	27K 5% 1/10W	R1653	1-216-049-91	RES,CHIP	1K 5% 1/10W
R1527	1-216-121-91	RES,CHIP	1M 5% 1/10W	R1654	1-216-049-91	RES,CHIP	1K 5% 1/10W
R1528	1-216-121-91	RES,CHIP	1M 5% 1/10W	R1655	1-216-073-00	RES,CHIP	10K 5% 1/10W
R1529	1-216-025-00	RES,CHIP	100 5% 1/10W	R1656	1-216-295-00	SHORT	0
R1530	1-216-097-00	RES,CHIP	100K 5% 1/10W	R1701	1-216-065-00	RES,CHIP	4.7K 5% 1/10W
R1531	1-216-089-00	RES,CHIP	47K 5% 1/10W	R1702	1-216-065-00	RES,CHIP	4.7K 5% 1/10W
R1532	1-216-025-00	RES,CHIP	100 5% 1/10W	R1703	1-216-065-00	RES,CHIP	4.7K 5% 1/10W
R1533	1-249-377-11	CARBON	0.47 5% 1/4W F	R1704	1-216-065-00	RES,CHIP	4.7K 5% 1/10W
R1534	1-216-089-91	RES,CHIP	47K 5% 1/10W	R1705	1-216-065-00	RES,CHIP	4.7K 5% 1/10W
R1537	1-216-073-00	RES,CHIP	10K 5% 1/10W	R1706	1-216-065-00	RES,CHIP	4.7K 5% 1/10W
R1538	1-216-083-00	RES,CHIP	27K 5% 1/10W	R1707	1-216-025-00	RES,CHIP	100 5% 1/10W
R1539	1-216-073-00	RES,CHIP	10K 5% 1/10W	R1708	1-216-025-00	RES,CHIP	100 5% 1/10W
R1540	1-216-091-00	RES,CHIP	56K 5% 1/10W	R1709	1-216-025-00	RES,CHIP	100 5% 1/10W
R1541	1-216-091-00	RES,CHIP	56K 5% 1/10W	R1710	1-216-049-00	RES,CHIP	1K 5% 1/10W
R1542	1-216-093-91	RES,CHIP	68K 5% 1/10W	R1711	1-216-089-00	RES,CHIP	47K 5% 1/10W
R1543	1-216-093-91	RES,CHIP	68K 5% 1/10W	R1712	1-216-073-00	RES,CHIP	10K 5% 1/10W
R1601	1-216-025-00	RES,CHIP	100 5% 1/10W	R1713	1-216-089-00	RES,CHIP	47K 5% 1/10W
R1602	1-216-041-00	RES,CHIP	470 5% 1/10W	R1714	1-216-073-00	RES,CHIP	10K 5% 1/10W
R1603	1-216-041-00	RES,CHIP	470 5% 1/10W	R1715	1-216-089-00	RES,CHIP	47K 5% 1/10W
R1604	1-216-113-00	RES,CHIP	470K 5% 1/10W	R1716	1-216-033-00	RES,CHIP	220 5% 1/10W
R1605	1-216-113-00	RES,CHIP	470K 5% 1/10W	R1717	1-216-089-00	RES,CHIP	47K 5% 1/10W
R1606	1-249-397-11	CARBON	22 5% 1/4W F	R1718	1-216-057-00	RES,CHIP	2.2K 5% 1/10W
R1607	1-249-397-11	CARBON	22 5% 1/4W F	R1719	1-216-033-00	RES,CHIP	220 5% 1/10W
R1608	1-249-425-11	CARBON	4.7K 5% 1/4W F	R1720	1-216-033-00	RES,CHIP	220 5% 1/10W
R1609	1-216-081-00	RES,CHIP	22K 5% 1/10W	R1721	1-216-033-00	RES,CHIP	220 5% 1/10W
R1610	1-216-081-00	RES,CHIP	22K 5% 1/10W	R1722	1-216-033-00	RES,CHIP	220 5% 1/10W
R1611	1-249-425-11	CARBON	4.7K 5% 1/4W F	R1725	1-216-065-00	RES,CHIP	4.7K 5% 1/10W
R1614	1-216-357-00	METAL OXIDE	4.7 5% 1W F	R1726	1-216-295-00	SHORT	0
R1615	1-216-357-00	METAL OXIDE	4.7 5% 1W F	R1727	1-216-033-00	RES,CHIP	220 5% 1/10W
R1617	1-216-069-00	RES,CHIP	6.8K 5% 1/10W	R1728	1-216-025-00	RES,CHIP	100 5% 1/10W
R1618	1-216-081-00	RES,CHIP	22K 5% 1/10W	R1729	1-216-025-00	RES,CHIP	100 5% 1/10W
R1620	1-216-065-00	RES,CHIP	4.7K 5% 1/10W	R1730	1-216-057-00	RES,CHIP	2.2K 5% 1/10W
R1625	1-216-061-00	RES,CHIP	3.3K 5% 1/10W	R1731	1-216-033-00	RES,CHIP	220 5% 1/10W
R1626	1-216-061-00	RES,CHIP	3.3K 5% 1/10W	R1732	1-216-049-00	RES,CHIP	1K 5% 1/10W
R1629	1-216-049-00	RES,CHIP	1K 5% 1/10W	R1733	1-216-049-00	RES,CHIP	1K 5% 1/10W
R1630	1-216-081-00	RES,CHIP	22K 5% 1/10W	R1734	1-216-049-00	RES,CHIP	1K 5% 1/10W
R1631	1-249-389-11	CARBON	4.7 5% 1/4W F	R1735	1-216-089-00	RES,CHIP	47K 5% 1/10W
R1632	1-216-089-91	RES,CHIP	47K 5% 1/10W	R1736	1-216-033-00	RES,CHIP	220 5% 1/10W
R1633	1-216-089-91	RES,CHIP	47K 5% 1/10W	R1737	1-216-033-00	RES,CHIP	220 5% 1/10W
R1634	1-216-081-00	RES,CHIP	22K 5% 1/10W	R1738	1-216-025-00	RES,CHIP	100 5% 1/10W
R1635	1-216-049-91	RES,CHIP	1K 5% 1/10W	R1739	1-216-073-00	RES,CHIP	10K 5% 1/10W
R1636	1-216-075-00	RES,CHIP	12K 5% 1/10W	R1740	1-216-073-00	RES,CHIP	10K 5% 1/10W
R1637	1-216-049-00	RES,CHIP	1K 5% 1/10W	R1741	1-216-033-00	RES,CHIP	220 5% 1/10W
R1638	1-216-073-00	RES,CHIP	10K 5% 1/10W	R1742	1-216-033-00	RES,CHIP	220 5% 1/10W
R1639	1-216-049-91	RES,CHIP	1K 5% 1/10W	R1743	1-216-025-00	RES,CHIP	100 5% 1/10W
R1640	1-216-025-00	RES,CHIP	100 5% 1/10W	R1744	1-216-033-00	RES,CHIP	220 5% 1/10W
R1641	1-216-065-00	RES,CHIP	4.7K 5% 1/10W	R1745	1-216-073-00	RES,CHIP	10K 5% 1/10W
R1642	1-216-049-00	RES,CHIP	1K 5% 1/10W	R1746	1-216-025-00	RES,CHIP	100 5% 1/10W
R1643	1-216-073-00	RES,CHIP	10K 5% 1/10W	R1747	1-216-025-00	RES,CHIP	100 5% 1/10W
R1644	1-216-075-00	RES,CHIP	12K 5% 1/10W	R1748	1-216-025-00	RES,CHIP	100 5% 1/10W
R1645	1-216-041-00	RES,CHIP	470 5% 1/10W	R1749	1-216-033-00	RES,CHIP	220 5% 1/10W
R1648	1-249-381-11	CARBON	1 5% 1/4W F	R1750	1-216-073-00	RES,CHIP	10K 5% 1/10W
R1649	1-216-089-00	RES,CHIP	47K 5% 1/10W	R1751	1-216-033-00	RES,CHIP	220 5% 1/10W
				R1752	1-216-025-00	RES,CHIP	100 5% 1/10W



The components identified by shading and mark Δ are critical for safety. Replace only with part number specified.

REF.NO.	PART NO.	DESCRIPTION	REMARK	REF.NO.	PART NO.	DESCRIPTION	REMARK
C513	1-126-965-11	ELECT	22 μ F 20% 50V				
C514	Δ 1-162-116-91	CERAMIC	680pF 10% 2KV	C824	1-126-964-11	ELECT	10 μ F 20% 50V
C515	Δ 1-125-831-91	FILM	0.033 μ F 3% 630V	C825	1-104-665-11	ELECT	100 μ F 20% 25V
C516	Δ 1-117-648-11	FILM	15000pF 3% 1.2KV	C826	1-136-165-00	FILM	0.1 μ F 5% 50V
C518	1-130-495-00	FILM	0.1 μ F 5% 50V	C827	1-126-964-11	ELECT	0 μ F 20% 50V
C519	1-106-359-00	MYLAR	0.0047 μ F 10% 100V	C828	1-102-824-00	CERAMIC	470pF 5% 50V
C520	1-162-116-00	CERAMIC	680pF 10% 2KV	C829	1-126-959-11	ELECT	0.47 μ F 20% 50V
C521	1-162-116-00	CERAMIC	680pF 10% 2KV	C830	1-102-824-00	CERAMIC	470pF 5% 50V
C523	1-115-521-11	FILM	0.82 μ F 5% 200V	C831	1-126-960-11	ELECT	1 μ F 20% 50V
C524	1-106-359-00	MYLAR	0.0047 μ F 10% 100V	C832	1-126-960-11	ELECT	1 μ F 20% 50V
C526	1-102-228-00	CERAMIC	470pF 10% 500V	C833	1-126-960-11	ELECT	1 μ F 20% 50V
C527	1-126-970-11	ELECT	330 μ F 20% 50V	C834	1-126-968-11	ELECT	100 μ F 20% 50V
C528	1-107-957-11	ELECT	1 μ F 20% 250V	C835	1-126-967-11	ELECT	47 μ F 20% 50V
C529	1-109-844-11	FILM	0.68 μ F 5% 250V	C836	1-136-169-00	FILM	0.22 μ F 5% 50V
C530	1-107-648-91	ELECT	100 μ F 20% 160V	C837	1-126-963-11	ELECT	4.7 μ F 20% 50V
C531	1-126-971-11	ELECT	470 μ F 20% 50V	C838	1-104-665-11	ELECT	100 μ F 20% 25V
C532	1-126-971-11	ELECT	470 μ F 20% 50V	C839	1-137-374-11	FILM	0.047 μ F 5% 50V
C533	1-107-655-11	ELECT	47 μ F 20% 250V	C840	1-104-665-11	ELECT	100 μ F 20% 25V
C535	1-106-387-00	MYLAR	0.068 μ F 10% 200V	C841	1-137-374-11	FILM	0.047 μ F 5% 50V
C536	1-137-374-11	FILM	0.047 μ F 5% 50V	C842	1-137-374-11	FILM	0.047 μ F 5% 50V
C537	1-126-968-11	ELECT	100 μ F 20% 50V	C844	1-126-933-11	ELECT	100 μ F 20% 16V
C538	1-126-968-11	ELECT	100 μ F 20% 50V	C845	1-126-933-11	ELECT	100 μ F 20% 16V
C539	1-162-114-00	CERAMIC	0.0047 μ F 2KV	C846	1-126-933-11	ELECT	100 μ F 20% 16V
C540	1-137-372-11	FILM	0.022 μ F 5% 50V	C847	1-126-933-11	ELECT	100 μ F 20% 16V
C541	1-137-374-11	FILM	0.047 μ F 5% 50V	C848	1-126-933-11	ELECT	100 μ F 20% 16V
C542	1-126-934-11	ELECT	220 μ F 20% 16V	C849	1-102-973-00	CERAMIC	100pF 5% 50V
C544	1-104-665-11	ELECT	100 μ F 20% 25V	C850	1-102-973-00	CERAMIC	100pF 5% 50V
C545	1-104-665-11	ELECT	100 μ F 20% 25V	C851	1-137-374-11	FILM	0.047 μ F 5% 50V
C548	1-102-244-00	CERAMIC	220pF 10% 500V	C852	1-137-374-11	FILM	0.047 μ F 5% 50V
C550	1-126-935-11	ELECT	470 μ F 20% 16V	C853	1-137-374-11	FILM	0.047 μ F 5% 50V
C551	1-126-935-11	ELECT	470 μ F 20% 16V	C854	1-126-933-11	ELECT	100 μ F 20% 16V
C554	1-130-062-91	FILM	0.0056 μ F 5% 630V	C855	1-102-973-00	CERAMIC	100pF 5% 50V
C555	1-126-960-11	ELECT	1 μ F 20% 50V	C856	1-102-973-00	CERAMIC	100pF 5% 50V
C556	1-130-495-00	MYLAR	0.1 μ F 5% 50V	C857	1-126-933-11	ELECT	100 μ F 20% 16V
C701	1-126-933-11	ELECT	100 μ F 20% 16V	C858	1-104-665-11	ELECT	100 μ F 20% 25V
C801	1-104-665-11	ELECT	100 μ F 20% 25V	C859	1-104-665-11	ELECT	100 μ F 20% 25V
C802	1-104-665-11	ELECT	100 μ F 20% 25V	C860	1-126-933-11	ELECT	100 μ F 20% 16V
C803	1-126-934-11	ELECT	220 μ F 20% 16V	C861	1-137-374-11	FILM	0.047 μ F 5% 50V
C804	1-126-934-11	ELECT	220 μ F 20% 16V	C862	1-137-374-11	FILM	0.047 μ F 5% 50V
C805	1-126-934-11	ELECT	220 μ F 20% 16V	C863	1-137-374-11	FILM	0.047 μ F 5% 50V
C806	1-126-934-11	ELECT	220 μ F 20% 16V	C864	1-126-933-11	ELECT	100 μ F 20% 16V
C807	1-137-374-11	FILM	0.047 μ F 5% 50V	C865	1-137-366-11	FILM	0.0022 μ F 5% 50V
C808	1-137-374-11	FILM	0.047 μ F 5% 50V	C866	1-136-177-00	FILM	1 μ F 5% 50V
C809	1-137-374-11	FILM	0.047 μ F 5% 50V	C867	1-104-664-11	ELECT	47 μ F 20% 25V
C810	1-137-374-11	FILM	0.047 μ F 5% 50V	C868	1-164-096-11	CERAMIC	0.01 μ F 50V
C811	1-102-074-00	CERAMIC	0.001 μ F 10% 50V	C869	1-130-487-00	MYLAR	0.022 μ F 5% 50V
C812	1-136-169-00	FILM	0.22 μ F 5% 50V	C870	1-164-096-11	CERAMIC	0.01 μ F 50V
C813	1-137-374-11	FILM	0.047 μ F 5% 50V	C872	1-126-960-11	ELECT	1 μ F 20% 50V
C815	1-104-665-11	ELECT	100 μ F 20% 25V	C873	1-126-964-11	ELECT	10 μ F 20% 50V
C816	1-130-014-00	FILM	470pF 5% 50V	C876	1-102-973-00	CERAMIC	100pF 5% 50V
C817	1-104-664-11	ELECT	47 μ F 20% 25V	C877	1-102-973-00	CERAMIC	100pF 5% 50V
C818	1-126-933-11	ELECT	100 μ F 20% 16V	C880	1-104-664-11	ELECT	47 μ F 20% 5V
C819	1-104-664-11	ELECT	47 μ F 20% 25V	C881	1-102-973-00	CERAMIC	100pF 5% 50V
C820	1-102-129-00	CERAMIC	0.01 μ F 10% 50V	C882	1-102-973-00	CERAMIC	100pF 5% 50V
C821	1-130-495-00	MYLAR	0.1 μ F 5% 50V	C883	1-102-973-00	CERAMIC	100pF 5% 50V
C822	1-107-648-91	ELECT	100 μ F 20% 160V	C884	1-104-665-11	ELECT	100 μ F 20% 25V
C823	1-104-664-11	ELECT	47 μ F 20% 25V	C885	1-104-664-11	ELECT	47 μ F 20% 25V

The components identified by shading and mark Δ are critical for safety.
Replace only with part number specified.



REF.NO.	PART NO.	DESCRIPTION	REMARK	REF.NO.	PART NO.	DESCRIPTION	REMARK
C886	1-102-973-00	CERAMIC	100pF 5% 50V	D842	8-719-991-33	DIODE 1SS133T-77	
C887	1-102-973-00	CERAMIC	100pF 5% 50V	D845	8-719-991-33	DIODE 1SS133T-77	
C888	1-102-973-00	CERAMIC	100pF 5% 50V	D846	8-719-991-33	DIODE 1SS133T-77	
C889	1-104-665-11	ELECT	100μF 20% 25V			<FERRITE BEAD>	
C897	1-104-665-11	ELECT	100μF 20% 25V	FB501	1-410-397-21	FERRITE BEAD INDUCTOR	1.1μH
		<CONNECTOR>				<IC>	
CN501	* 1-564-513-11	PLUG, CONNECTOR 10P		IC501	8-759-133-90	IC μPC339C	
CN502	* 1-580-689-11	PIN, CONNECTOR (PC BOARD) 4P		IC801	8-759-327-51	IC PA0053B	
CN503	* 1-580-689-11	PIN, CONNECTOR (PC BOARD) 4P		IC802	8-759-327-51	IC PA0053B	
CN504	* 1-580-689-11	PIN, CONNECTOR (PC BOARD) 4P		IC803	8-759-183-37	IC CA0007AD	
CN505	* 1-506-371-00	PIN, CONNECTOR 2P		IC804	8-759-464-79	IC PM0011AS	
CN506	* 1-779-892-11	CONNECTOR, BOARD TO BOARD 10P		IC805	8-759-711-28	IC NJM2058D	
CN507	* 1-564-507-11	PLUG, CONNECTOR 4P		IC806	8-759-464-79	IC PM0011AS	
CN508	1-695-915-11	TAB (CONTACT)		IC808	8-759-464-79	IC PM0011AS	
CN651	* 1-779-892-11	CONNECTOR, BOARD TO BOARD 10P		IC809	8-749-014-37	IC STK392-150	
CN652	* 1-779-892-11	CONNECTOR, BOARD TO BOARD 10P		IC810	8-749-014-37	IC STK392-150	
CN801	* 1-564-507-11	PLUG, CONNECTOR 4P		IC811	8-759-981-96	IC RC4560D	
CN802	* 1-564-507-11	PLUG, CONNECTOR 4P		IC812	8-759-701-56	IC NJM78M05FA	
CN803	* 1-564-507-11	PLUG, CONNECTOR 4P		IC813	8-759-701-65	IC NJM79M05FA	
CN804	* 1-779-892-11	CONNECTOR, BOARD TO BOARD 10P				<COIL>	
CN805	* 1-508-766-00	PIN, CONNECTOR (5mm PITCH) 4P		L502	1-410-478-11	INDUCTOR	47μH
CN806	* 1-508-765-00	PIN, CONNECTOR (5mm PITCH) 3P		L503	1-459-111-00	INDUCTOR	10mH
CN807	* 1-564-509-11	PLUG, CONNECTOR 6P		L505	Δ 1-416-637-11	COIL, HORIZONTAL LINEARITY	
CN808	* 1-573-986-11	PIN, CONNECTOR (PC BOARD) 5P		L506	1-412-552-11	INDUCTOR	2.2mH
CN810	* 1-573-963-11	PIN, CONNECTOR (PC BOARD) 3P		L801	1-406-979-11	INDUCTOR	220μH
		<DIODE>		L802	1-406-979-11	INDUCTOR	220μH
D501	8-719-991-33	DIODE 1SS133T-77		L803	1-406-665-11	INDUCTOR	100μH
D502	8-719-991-33	DIODE 1SS133T-77				<NEON LAMP>	
D503	8-719-991-33	DIODE 1SS133T-77		NL501	1-519-108-99	LAMP, NEON	
D504	8-719-921-63	DIODE MTZJ-7.5B				<IC LINK>	
D507	8-719-302-43	DIODE EL1Z		PS601	Δ 1-533-597-31	LINK, IC (5A/90V AC,60V DC)	
D508	8-719-900-26	DIODE ERD29-08J		PS602	Δ 1-533-597-31	LINK, IC (5A/90V AC,60V DC)	
D509	8-719-945-80	DIODE ERC06-15S		PS603	Δ 1-533-593-31	LINK, IC (2A/90V AC,60V DC)	
D510	8-719-991-33	DIODE 1SS133T-77		PS604	Δ 1-533-593-31	LINK, IC (2A/90V AC,60V DC)	
D511	8-719-302-43	DIODE EL1Z		PS605	Δ 1-533-593-31	LINK, IC (2A/90V AC,60V DC)	
D512	8-719-991-33	DIODE 1SS133T-77		PS606	Δ 1-533-593-31	LINK, IC (2A/90V AC,60V DC)	
D513	8-719-302-43	DIODE EL1Z		PS607	Δ 1-533-593-31	LINK, IC (2A/90V AC,60V DC)	
D514	8-719-908-03	DIODE GP08D		PS608	Δ 1-533-593-31	LINK, IC (2A/90V AC,60V DC)	
D515	8-719-908-03	DIODE GP08D				<TRANSISTOR>	
D517	8-719-018-82	DIODE RGP02-20EL-6394		Q501	8-729-119-80	TRANSISTOR 2SC2688-LK	
D519	8-719-991-33	DIODE 1SS133T-77		Q502	8-729-044-29	TRANSISTOR 2SD2539(LBSONY-1)	
D520	8-719-302-43	DIODE EL1Z		Q503	8-729-119-76	TRANSISTOR 2SA1175-HFE	
D521	8-719-302-43	DIODE EL1Z		Q504	8-729-823-81	TRANSISTOR 2SC4632LS-CB7	
D522	8-719-991-33	DIODE 1SS133T-77		Q505	8-729-038-83	TRANSISTOR 2SK2251-01-F19	
D523	8-719-991-33	DIODE 1SS133T-77		Q506	8-729-119-78	TRANSISTOR 2SC2785-HFE	
D524	8-719-991-33	DIODE 1SS133T-77					
D527	8-719-109-85	DIODE RD5.1ESB2					
D701	8-719-109-63	DIODE RD3.0ESB2					
D702	8-719-991-33	DIODE 1SS133T-77					
D820	8-719-109-68	DIODE RD3.6ESB1					
D829	8-719-109-84	DIODE RD5.1ESB1					
D835	8-719-109-89	DIODE RD5.6ESB2					
D840	8-719-991-33	DIODE 1SS133T-77					

**KP-41S5/41S5B/41S5G/
41S5K/41S5R/41S5U**

RM-862



• The components identified by **E** in this manual have been carefully factory-selected for each set in order to satisfy regulations regarding X-ray radiation. Should replacement be required, replace only with the value originally used.

The components identified by shading and mark **E** are critical for safety. Replace only with part number specified.

REF.NO.	PART NO.	DESCRIPTION	REMARK	REF.NO.	PART NO.	DESCRIPTION	REMARK
Q507	8-729-032-61	TRANSISTOR 2SC5022-02		R543	1-216-349-00	METAL OXIDE 1	5% 1W F
Q701	8-729-119-78	TRANSISTOR 2SC2785-HFE		R544	1-215-864-00	METAL OXIDE 150	5% 1W F
Q702	8-729-119-78	TRANSISTOR 2SC2785-HFE		R545	1-249-377-11	CARBON 0.47	5% 1/4W F
Q801	8-729-119-78	TRANSISTOR 2SC2785-HFE		R546	1-249-377-11	CARBON 0.47	5% 1/4W F
Q802	8-729-119-76	TRANSISTOR 2SA1175-HFE		R547	1-247-807-31	CARBON 100	5% 1/4W
Q803	8-729-119-78	TRANSISTOR 2SC2785-HFE		R548	1-249-413-11	CARBON 470	5% 1/4W
Q804	8-729-119-76	TRANSISTOR 2SA1175-HFE		R549	1-249-431-11	CARBON 15K	5% 1/4W
Q805	8-729-119-78	TRANSISTOR 2SC2785-HFE		R550	1-247-807-31	CARBON 100	5% 1/4W
Q806	8-729-119-76	TRANSISTOR 2SA1175-HFE		R551	1-249-437-11	CARBON 47K	5% 1/4W
Q807	8-729-119-78	TRANSISTOR 2SC2785-HFE		R552	1-247-807-31	CARBON 100	5% 1/4W
Q808	8-729-030-02	TRANSISTOR DTC144ESA		R553	1-247-881-00	CARBON 120K	5% 1/4W
Q809	8-729-119-78	TRANSISTOR 2SC2785-HFE		R554	1-249-405-11	CARBON 100	5% 1/4W F
Q810	8-729-119-78	TRANSISTOR 2SC2785-HFE		R555	1-247-807-31	CARBON 100	5% 1/4W
Q811	8-729-119-78	TRANSISTOR 2SC2785-HFE		R556	1-260-099-11	CARBON 1K	5% 1/2W
Q812	8-729-119-76	TRANSISTOR 2SA1175-HFE		R557	1-216-490-11	METAL OXIDE 39K	5% 3W F
		<RESISTOR>		R558	1-216-490-11	METAL OXIDE 39K	5% 3W F
E R1 E		METAL	1/4W	R559	1-216-490-11	METAL OXIDE 39K	5% 3W F
R501	1-249-421-11	CARBON 2.2K	5% 1/4W	R560	8-719-991-33	DIODE 1SS133T-77	
R502	1-216-465-21	METAL OXIDE 27K	5% 2W F	R562	1-202-838-00	SOLID 100K	10% 1/2W
R503	1-247-843-11	CARBON 3.3K	5% 1/4W	R563	1-215-447-00	METAL 12K	1% 1/4W
R504	1-249-419-11	CARBON 1.5K	5% 1/4W	R565	1-247-807-31	CARBON 100	5% 1/4W
R505	1-247-885-00	CARBON 180K	5% 1/4W	R566	1-249-377-11	CARBON 0.47	5% 1/4W F
R506	1-247-883-00	CARBON 150K	5% 1/4W	R567	1-249-377-11	CARBON 0.47	5% 1/4W F
R507	1-249-422-11	CARBON 2.7K	5% 1/4W	R568	1-247-903-00	CARBON 1M	5% 1/4W
R508	1-260-338-51	CARBON 6.8K	5% 1/2W	R569	1-216-392-11	METAL OXIDE 1.8	5% 3W F
R509	1-249-437-11	CARBON 47K	5% 1/4W	R570	1-215-910-00	METAL OXIDE 68	5% 3W F
R510	1-215-918-00	METAL OXIDE 1.5K	5% 3W F	R571	1-249-422-11	CARBON 2.7K	5% 1/4W
R511	1-215-918-00	METAL OXIDE 1.5K	5% 3W F	R572	1-247-895-91	CARBON 470K	5% 1/4W
R512	1-215-918-00	METAL OXIDE 1.5K	5% 3W F	R573	1-249-438-11	CARBON 56K	5% 1/4W
R513	1-247-843-11	CARBON 3.3K	5% 1/4W	R574	1-249-435-11	CARBON 33K	5% 1/4W
R514	1-215-443-00	METAL 8.2K	1% 1/4W	R576	1-247-807-31	CARBON 100	5% 1/4W
R516	1-215-473-00	METAL 150K	1% 1/4W	R577	1-249-422-11	CARBON 2.7K	5% 1/4W
R517	1-215-449-00	METAL 15K	1% 1/4W	R578	1-215-473-00	METAL 150K	1% 1/4W
R518	1-249-436-11	CARBON 39K	5% 1/4W	R579	1-247-889-00	CARBON 270K	5% 1/4W
R519	1-249-429-11	CARBON 10K	5% 1/4W	R580	1-249-437-11	CARBON 47K	5% 1/4W
R522	1-249-428-11	CARBON 8.2K	5% 1/4W	R581	1-249-437-11	CARBON 47K	5% 1/4W
R523	1-249-437-11	CARBON 47K	5% 1/4W	R583	1-249-428-11	CARBON 8.2K	5% 1/4W
R524	1-249-425-11	CARBON 4.7K	5% 1/4W	R584	1-249-429-11	CARBON 10K	5% 1/4W
R525	1-249-405-11	CARBON 100	5% 1/4W F	R585	1-216-490-11	METAL OXIDE 39K	5% 3W F
R527	1-249-425-11	CARBON 4.7K	5% 1/4W	R586	1-215-892-11	METAL OXIDE 1K	5% 2W F
R528	1-215-910-00	METAL OXIDE 68	5% 3W F	R588	1-247-863-91	CARBON 22K	5% 1/4W
R529	1-215-449-00	METAL 15K	1% 1/4W	R589	1-247-887-00	CARBON 220K	5% 1/4W
R530	1-249-429-11	CARBON 10K	5% 1/4W	R591	1-249-425-11	CARBON 4.7K	5% 1/4W
R531	1-260-326-11	CARBON 680	5% 1/2W	R595	1-215-464-00	METAL 62K	1% 1/4W
R532	1-260-315-71	CARBON 82	5% 1/2W	R596	1-215-473-00	METAL 150K	1% 1/4W
R533	1-214-912-00	METAL 91K	1% 1/2W	R597	1-215-464-00	METAL 62K	1% 1/4W
R534	1-215-479-00	METAL 270K	1% 1/4W	R701	1-215-449-00	METAL 15K	1% 1/4W
R535	1-247-887-00	CARBON 220K	5% 1/4W	R702	1-249-421-11	CARBON 2.2K	5% 1/4W
R536	1-249-377-11	CARBON 0.47	5% 1/4W F	R703	1-249-421-11	CARBON 2.2K	5% 1/4W
R537	1-260-336-11	CARBON 4.7K	5% 1/2W	R704	1-215-457-00	METAL 33K	1% 1/4W
R538	1-249-425-11	CARBON 4.7K	5% 1/4W	R705	1-215-457-00	METAL 33K	1% 1/4W
R539	1-249-377-11	CARBON 0.47	5% 1/4W F	R706	1-215-457-00	METAL 33K	1% 1/4W
R540	1-249-379-11	CARBON 0.68	5% 1/4W F	R801	1-247-807-31	CARBON 100	5% 1/4W
R541	1-247-807-31	CARBON 100	5% 1/4W	R802	1-247-807-31	CARBON 100	5% 1/4W
R542	1-215-864-00	METAL OXIDE 150	5% 1W F	R803	1-249-430-11	CARBON 12K	5% 1/4W
				R804	1-249-425-11	CARBON 4.7K	5% 1/4W



REF.NO.	PART NO.	DESCRIPTION	REMARK	REF.NO.	PART NO.	DESCRIPTION	REMARK
R805	1-247-807-31	CARBON	100 5% 1/4W	R867	1-215-455-00	METAL	27K 1% 1/4W
R806	1-249-429-11	CARBON	10K 5% 1/4W	R868	1-215-443-00	METAL	8.2K 1% 1/4W
R807	1-247-807-31	CARBON	100 5% 1/4W	R869	1-249-425-11	CARBON	4.7K 5% 1/4W
R808	1-249-429-11	CARBON	10K 5% 1/4W	R870	1-249-437-11	CARBON	47K 5% 1/4W
R809	1-249-425-11	CARBON	4.7K 5% 1/4W	R871	1-249-417-11	CARBON	1K 5% 1/4W
R810	1-247-807-31	CARBON	100 5% 1/4W	R872	1-249-425-11	CARBON	4.7K 5% 1/4W
R811	1-247-807-31	CARBON	100 5% 1/4W	R873	1-247-807-31	CARBON	100 5% 1/4W
R813	1-247-863-91	CARBON	22K 5% 1/4W	R874	1-249-435-11	CARBON	33K 5% 1/4W
R814	1-247-807-31	CARBON	100 5% 1/4W	R875	1-249-441-11	CARBON	100K 5% 1/4W
R815	1-247-807-31	CARBON	100 5% 1/4W	R877	1-249-422-11	CARBON	2.7K 5% 1/4W
R816	1-247-807-31	CARBON	100 5% 1/4W	R878	1-215-469-00	METAL	100K 1% 1/4W
R817	1-247-807-31	CARBON	100 5% 1/4W	R879	1-215-445-00	METAL	10K 1% 1/4W
R818	1-249-429-11	CARBON	10K 5% 1/4W	R881	1-249-408-11	CARBON	180 5% 1/4W
R819	1-247-807-31	CARBON	100 5% 1/4W	R882	1-249-429-11	CARBON	10K 5% 1/4W
R820	1-249-437-11	CARBON	47K 5% 1/4W	R883	1-249-429-11	CARBON	10K 5% 1/4W
R821	1-249-431-11	CARBON	15K 5% 1/4W	R884	1-215-445-00	METAL	10K 1% 1/4W
R822	1-249-417-11	CARBON	1K 5% 1/4W	R885	1-249-441-11	CARBON	100K 5% 1/4W
R823	1-249-417-11	CARBON	1K 5% 1/4W	R886	1-249-428-11	CARBON	8.2K 5% 1/4W
R824	1-215-462-00	METAL	51K 1% 1/4W	R887	1-247-807-31	CARBON	100 5% 1/4W
R825	1-249-441-11	CARBON	100K 5% 1/4W	R888	1-247-807-31	CARBON	100 5% 1/4W
R826	1-215-462-00	METAL	51K 1% 1/4W	R889	1-249-439-11	CARBON	68K 5% 1/4W
R827	1-216-474-11	METAL OXIDE	82 5% 3W F	R890	1-249-441-11	CARBON	100K 5% 1/4W
R828	1-249-426-11	CARBON	5.6K 5% 1/4W	R891	1-247-843-11	CARBON	3.3K 5% 1/4W
R829	1-249-426-11	CARBON	5.6K 5% 1/4W	R892	1-249-425-11	CARBON	4.7K 5% 1/4W
R830	1-249-414-11	CARBON	560 5% 1/4W	R893	1-249-421-11	CARBON	2.2K 5% 1/4W
R831	1-249-414-11	CARBON	560 5% 1/4W	R894	1-215-455-00	METAL	27K 1% 1/4W
R832	1-249-441-11	CARBON	100K 5% 1/4W	R895	1-249-421-11	CARBON	2.2K 5% 1/4W
R833	1-216-474-11	METAL OXIDE	82 5% 3W F	R896	1-249-441-11	CARBON	100K 5% 1/4W
R834	1-249-441-11	CARBON	100K 5% 1/4W	R897	1-247-807-31	CARBON	100 5% 1/4W
R835	1-249-441-11	CARBON	100K 5% 1/4W	R898	1-247-815-91	CARBON	220 5% 1/4W
R836	1-247-807-31	CARBON	100 5% 1/4W	R900	1-216-474-11	METAL OXIDE	82 5% 3W F
R837	1-249-441-11	CARBON	100K 5% 1/4W	R901	1-215-449-00	METAL	15K 1% 1/4W
R838	1-249-421-11	CARBON	2.2K 5% 1/4W	R902	1-215-449-00	METAL	15K 1% 1/4W
R839	1-247-807-31	CARBON	100 5% 1/4W	R903	1-215-421-00	METAL	1K 1% 1/4W
R841	1-247-815-91	CARBON	220 5% 1/4W	R904	1-214-800-11	METAL	2.2 1% 1/2W
R842	1-247-807-31	CARBON	100 5% 1/4W	R905	1-214-800-11	METAL	2.2 1% 1/2W
R843	1-247-807-31	CARBON	100 5% 1/4W	R906	1-214-800-11	METAL	2.2 1% 1/2W
R844	1-247-807-31	CARBON	100 5% 1/4W	R908	1-215-445-00	METAL	10K 1% 1/4W
R845	1-249-441-11	CARBON	100K 5% 1/4W	R909	1-215-421-00	METAL	1K 1% 1/4W
R846	1-247-807-31	CARBON	100 5% 1/4W	R910	1-215-421-00	METAL	1K 1% 1/4W
R847	1-215-481-00	METAL	330K 1% 1/4W	R911	1-215-461-00	METAL	47K 1% 1/4W
R848	1-215-449-00	METAL	15K 1% 1/4W	R912	1-215-445-00	METAL	10K 1% 1/4W
R850	1-215-481-00	METAL	330K 1% 1/4W	R913	1-215-455-00	METAL	27K 1% 1/4W
R851	1-247-807-31	CARBON	100 5% 1/4W	R914	1-215-455-00	METAL	27K 1% 1/4W
R852	1-247-807-31	CARBON	100 5% 1/4W	R915	1-215-455-00	METAL	27K 1% 1/4W
R853	1-247-887-00	CARBON	220K 5% 1/4W	R916	1-215-455-00	METAL	27K 1% 1/4W
R854	1-249-429-11	CARBON	10K 5% 1/4W	R917	1-215-455-00	METAL	27K 1% 1/4W
R856	1-247-807-31	CARBON	100 5% 1/4W	R918	1-215-455-00	METAL	27K 1% 1/4W
R857	1-247-807-31	CARBON	100 5% 1/4W	R919	1-249-435-11	CARBON	33K 5% 1/4W
R858	1-215-455-00	METAL	27K 1% 1/4W	R920	1-214-800-11	METAL	2.2 1% 1/2W
R859	1-215-455-00	METAL	27K 1% 1/4W	R921	1-249-429-11	CARBON	10K 5% 1/4W
R860	1-215-455-00	METAL	27K 1% 1/4W	R922	1-215-445-00	METAL	10K 1% 1/4W
R861	1-215-455-00	METAL	27K 1% 1/4W	R923	1-249-425-11	CARBON	4.7K 5% 1/4W
R862	1-215-455-00	METAL	27K 1% 1/4W	R924	1-215-445-00	METAL	10K 1% 1/4W
R863	1-215-455-00	METAL	27K 1% 1/4W	R925	1-249-425-11	CARBON	4.7K 5% 1/4W
R865	1-249-424-11	CARBON	3.9K 5% 1/4W	R926	1-249-408-11	CARBON	180 5% 1/4W
R866	1-249-437-11	CARBON	47K 5% 1/4W	R927	1-249-429-11	CARBON	10K 5% 1/4W

**KP-41S5/41S5B/41S5G/
41S5K/41S5R/41S5U**

RM-862



The components identified by shading and mark Δ are critical for safety. Replace only with part number specified.

REF.NO.	PART NO.	DESCRIPTION	REMARK	REF.NO.	PART NO.	DESCRIPTION	REMARK
R928	1-249-429-11	CARBON	10K 5% 1/4W	R987	1-249-408-11	CARBON	180 5% 1/4W
R929	1-214-800-11	METAL	2.2 1% 1/2W	R988	1-249-429-11	CARBON	10K 5% 1/4W
R930	1-214-800-11	METAL	2.2 1% 1/2W	R989	1-249-425-11	CARBON	4.7K 5% 1/4W
R931	1-215-445-00	METAL	10K 1% 1/4W	R990	1-249-431-11	CARBON	15K 5% 1/4W
R933	1-215-445-00	METAL	10K 1% 1/4W	R991	1-249-429-11	CARBON	10K 5% 1/4W
R934	1-249-422-11	CARBON	2.7K 5% 1/4W	R993	1-249-425-11	CARBON	4.7K 5% 1/4W
R935	1-249-429-11	CARBON	10K 5% 1/4W	R994	1-216-474-11	METAL OXIDE	82 5% 3W F
R936	1-249-429-11	CARBON	10K 5% 1/4W	R997	1-215-445-00	METAL	10K 1% 1/4W
R937	1-249-436-11	CARBON	39K 5% 1/4W	R998	1-249-425-11	CARBON	4.7K 5% 1/4W
R938	1-215-421-00	METAL	1K 1% 1/4W	R999	1-249-425-11	CARBON	4.7K 5% 1/4W
R939	1-259-878-11	CARBON	1.5M 5% 1/4W	R1901	1-249-439-11	CARBON	68K 5% 1/4W
R940	1-249-441-11	CARBON	100K 5% 1/4W	R1904	1-249-425-11	CARBON	4.7K 5% 1/4W
R941	1-249-441-11	CARBON	100K 5% 1/4W			<SPARK GAP>	
R942	1-249-421-11	CARBON	2.2K 5% 1/4W	SG501	1-519-422-11	GAP, SPARK	
R943	1-249-441-11	CARBON	100K 5% 1/4W			<TRANSFORMER>	
R944	1-215-421-00	METAL	1K 1% 1/4W	T501	1-437-195-11	TRANSFORMER, HORIZONTAL DRIVE	
R945	1-249-439-11	CARBON	68K 5% 1/4W	T502	Δ 1-431-211-11	TRANSFORMER, FERRITE (PMT)	
R946	1-215-421-00	METAL	1K 1% 1/4W	T504	Δ 1-453-248-21	FBT ASSY (NX-4007//X4T4)	
R947	1-249-441-11	CARBON	100K 5% 1/4W	*****			
R948	1-247-815-91	CARBON	220 5% 1/4W	* A-1372-413-A H1 BOARD, COMPLETE			
R949	1-247-807-31	CARBON	100 5% 1/4W	*****			
R950	1-247-807-31	CARBON	100 5% 1/4W	4-203-258-01 HOLDER, LED			
R951	1-247-807-31	CARBON	100 5% 1/4W	<CAPACITOR>			
R952	1-247-807-31	CARBON	100 5% 1/4W	C3003	1-126-157-11	ELECT	10 μ F 20% 16V
R953	1-249-435-11	CARBON	33K 5% 1/4W	<CONNECTOR>			
R954	1-215-433-00	METAL	3.3K 1% 1/4W	CN3001	*1-564-519-11	PLUG, CONNECTOR	4P
R955	1-215-433-00	METAL	3.3K 1% 1/4W	CN3002	*1-564-525-11	PLUG, CONNECTOR	10P
R956	1-249-429-11	CARBON	10K 5% 1/4W	CN3003	*1-580-690-11	PIN, CONNECTOR (PC BOARD)	4P
R957	1-214-800-11	METAL	2.2 1% 1/2W	CN3004	*1-691-292-11	PIN, CONNECTOR (PC BOARD)	3P
R958	1-214-800-11	METAL	2.2 1% 1/2W	<DIODE>			
R959	1-215-433-00	METAL	3.3K 1% 1/4W	D3002	8-719-992-06	DIODE SLA-580LT3F (STANDBY)	
R961	1-249-425-11	CARBON	4.7K 5% 1/4W	<IC>			
R962	1-214-800-11	METAL	2.2 1% 1/2W	IC3002	8-742-014-11	HYB IC SBX1981-51	
R963	1-214-800-11	METAL	2.2 1% 1/2W	<TRANSISTOR>			
R964	1-215-433-00	METAL	3.3K 1% 1/4W	Q3002	8-729-120-28	TRANSISTOR 2SC1623-L5L6	
R965	1-215-433-00	METAL	3.3K 1% 1/4W	<RESISTOR>			
R966	1-247-815-91	CARBON	220 5% 1/4W	R3001	1-216-683-11	METAL CHIP	22K 0.50%1/10W
R967	1-215-455-00	METAL	27K 1% 1/4W				
R968	1-215-455-00	METAL	27K 1% 1/4W				
R969	1-215-455-00	METAL	27K 1% 1/4W				
R970	1-215-455-00	METAL	27K 1% 1/4W				
R971	1-215-455-00	METAL	27K 1% 1/4W				
R972	1-215-455-00	METAL	27K 1% 1/4W				
R973	1-214-800-11	METAL	2.2 1% 1/2W				
R974	1-215-455-00	METAL	27K 1% 1/4W				
R975	1-214-800-11	METAL	2.2 1% 1/2W				
R976	1-215-433-00	METAL	3.3K 1% 1/4W				
R978	1-215-443-00	METAL	8.2K 1% 1/4W				
R979	1-249-425-11	CARBON	4.7K 5% 1/4W				
R980	1-247-815-91	CARBON	220 5% 1/4W				
R981	1-247-815-91	CARBON	220 5% 1/4W				
R982	1-215-469-00	METAL	100K 1% 1/4W				
R983	1-247-815-91	CARBON	220 5% 1/4W				
R984	1-215-445-00	METAL	10K 1% 1/4W				
R985	1-249-429-11	CARBON	10K 5% 1/4W				
R986	1-215-449-00	METAL	15K 1% 1/4W				

The components identified by shading and mark Δ are critical for safety.
Replace only with part number specified.

H1 **UE** **H2**

REF.NO.	PART NO.	DESCRIPTION	REMARK	REF.NO.	PART NO.	DESCRIPTION	REMARK
R3002	1-216-675-91	METAL CHIP 10K	0.50% 1/10W	R2706	1-216-024-00	RES,CHIP 91	5% 1/10W
R3006	1-216-667-11	METAL CHIP 4.7K	0.50% 1/10W	R2707	1-216-023-00	RES,CHIP 82	5% 1/10W
R3007	1-216-661-11	METAL CHIP 2.7K	0.50% 1/10W	R2709	1-216-113-00	RES,CHIP 470K	5% 1/10W
R3009	1-216-041-00	RES,CHIP 470	5% 1/10W	R2710	1-216-089-00	RES,CHIP 47K	5% 1/10W
R3010	1-216-045-00	RES,CHIP 680	5% 1/10W	R2711	1-216-113-00	RES,CHIP 470K	5% 1/10W
		<SWITCH>		R2712	1-216-089-00	RES,CHIP 47K	5% 1/10W
S3001	1-571-532-21	SWITCH, TACTIL (PROG+)		R2715	1-216-025-91	RES,CHIP 100	5% 1/10W
S3002	1-571-532-21	SWITCH, TACTIL (PROG-)		R2716	1-216-295-91	SHORT 0	
S3003	1-571-532-21	SWITCH, TACTIL (VOL+)		R2717	1-216-025-91	RES,CHIP 100	5% 1/10W
S3004	1-571-532-21	SWITCH, TACTIL (VOL-)		R2718	1-216-295-91	SHORT 0	
S3005	1-571-532-21	SWITCH, TACTIL (INPUT SELECT)		*****			
S3006 Δ	1-571-433-31	SWITCH, PUSH (MAIN POWER)		* A-1375-171-A H2 BOARD, COMPLETE *****			
*****				* A-1375-171-A H2 BOARD, COMPLETE *****			
		<CAPACITOR>		<CAPACITOR>			
C2701	1-163-133-00	CERAMIC CHIP 470pF	5% 50V	C3203	1-126-157-11	ELECT 10 μ F	20% 16V
C2702	1-164-232-11	CERAMIC CHIP 0.01 μ F	10% 50V	C3204	1-163-037-11	CERAMIC CHIP 0.022 μ F	10% 50V
C2703	1-163-133-00	CERAMIC CHIP 470pF	5% 50V	C3205	1-163-037-11	CERAMIC CHIP 0.022 μ F	10% 50V
C2704	1-164-232-11	CERAMIC CHIP 0.01 μ F	10% 50V	<CONNECTOR>			
C2705	1-126-934-11	ELECT 220 μ F	20% 16V	CN3201	*1-564-519-11	PLUG, CONNECTOR 4P	
C2706	1-126-964-11	ELECT 10 μ F	20% 50V	CN3202	*1-564-526-31	PLUG, CONNECTOR 11P	
C2707	1-126-964-11	ELECT 10 μ F	20% 50V	CN3204	*1-564-520-11	PLUG, CONNECTOR 5P	
C2708	1-104-664-11	ELECT 47 μ F	20% 16V	<JACK>			
C2709	1-126-964-11	ELECT 10 μ F	20% 50V	J3201	1-784-658-11	TERMINAL BLOCK, S	
C2710	1-104-664-11	ELECT 47 μ F	20% 16V	J3202	1-507-806-00	JACK 1P	
<CONNECTOR>				<COIL>			
CN2701	*1-564-522-11	PLUG, CONNECTOR 7P		L3201	1-408-615-31	INDUCTOR	100 μ H
CN2702	*1-564-523-11	PLUG, CONNECTOR 8P		L3202	1-408-615-31	INDUCTOR	100 μ H
CN2703	1-695-549-11	SOCKET, PIN 21P		<RESISTOR>			
<DIODE>				R3202	1-216-025-00	RES,CHIP 100	5% 1/10W
D2701	8-719-977-22	DIODE DTZ9.1		R3203	1-216-025-00	RES,CHIP 100	5% 1/10W
D2702	8-719-977-22	DIODE DTZ9.1		R3207	1-216-654-11	METAL CHIP 1.3K	0.50% 1/10W
D2703	8-719-977-22	DIODE DTZ9.1		R3209	1-216-033-00	RES,CHIP 220	5% 1/10W
D2704	8-719-977-22	DIODE DTZ9.1		R3210	1-216-033-00	RES,CHIP 220	5% 1/10W
D2705	8-719-977-22	DIODE DTZ9.1		R3211	1-216-033-00	RES,CHIP 220	5% 1/10W
D2706	8-719-977-22	DIODE DTZ9.1		R3212	1-216-033-00	RES,CHIP 220	5% 1/10W
D2707	8-719-977-22	DIODE DTZ9.1		<SWITCH>			
D2708	8-719-977-22	DIODE DTZ9.1		S3205	1-571-532-21	SWITCH, TACTIL (AUTO CONVERGENCE)	
<RESISTOR>				S3206	1-571-532-21	SWITCH, TACTIL (AUTO PRESET)	
R2702	1-216-022-00	RES,CHIP 75	5% 1/10W	*****			
R2703	1-216-033-00	RES,CHIP 220	5% 1/10W	*****			
R2704	1-216-039-00	RES,CHIP 390	5% 1/10W	*****			
R2705	1-216-039-00	RES,CHIP 390	5% 1/10W	*****			

KP-41S5/41S5B/41S5G/
41S5K/41S5R/41S5U

RM-862



REF.NO.	PART NO.	DESCRIPTION	REMARK	REF.NO.	PART NO.	DESCRIPTION	REMARK
		* A-1390-784-A ZR BOARD, COMPLETE *****				<DIODE>	
		<CONNECTOR>		D1431	8-719-110-88	DIODE RD39ESB2	
		CN1401 *1-564-510-11 PLUG, CONNECTOR 7P		D1432	8-719-110-88	DIODE RD39ESB2	
		CN1403 *1-564-506-11 PLUG, CONNECTOR 3P		D1433	8-719-991-33	DIODE 1SS133T-77	
		CN1404 *1-564-507-11 PLUG, CONNECTOR 4P				<CONNECTOR>	
		CN1405 *1-580-689-11 PIN, CONNECTOR (PC BOARD) 4P		DY1431	1-451-454-11	DEFLECTION YOKE	
		<CONNECTOR>				<COIL>	
		DY1401 1-451-454-11 DEFLECTION YOKE		L1431	1-410-478-11	INDUCTOR	47μH
		<RESISTOR>				<TRANSISTOR>	
R1401	1-249-414-11	CARBON	560 5% 1/4W	Q1431	8-729-017-06	TRANSISTOR 2SC4793	
R1402	1-249-414-11	CARBON	560 5% 1/4W	Q1432	8-729-017-05	TRANSISTOR 2SA1837	
R1403	1-216-476-11	METAL OXIDE	180 5% 3W F	Q1433	8-729-119-76	TRANSISTOR 2SA1175-HFE	
R1415	1-216-475-11	METAL OXIDE	120 5% 3W F	Q1434	8-729-119-78	TRANSISTOR 2SC2785-HFE	
R1418	1-216-475-11	METAL OXIDE	120 5% 3W F	Q1435	8-729-119-78	TRANSISTOR 2SC2785-HFE	
*****				Q1436	8-729-119-78	TRANSISTOR 2SC2785-HFE	
		* A-1390-785-A ZG BOARD, COMPLETE *****				<RESISTOR>	
		4-382-854-11 SCREW (M3X10), P, SW (+)		R1431	1-249-414-11	CARBON	560 5% 1/4W
		<CAPACITOR>		R1432	1-249-414-11	CARBON	560 5% 1/4W
C1433	1-104-999-11	MYLAR	0.1μF 10% 200V	R1433	1-249-377-11	CARBON	0.47 5% 1/4W F
C1434	1-107-362-11	FILM	0.0047μF 10% 200V	R1435	1-216-475-11	METAL OXIDE	120 5% 3W F
C1435	1-107-667-11	ELECT	2.2μF 20% 160V	R1436	1-216-475-11	METAL OXIDE	120 5% 3W F
C1436	1-130-471-00	FILM	0.001μF 5% 50V	R1437	1-249-414-11	CARBON	560 5% 1/4W
C1437	1-130-471-00	FILM	0.001μF 5% 50V	R1438	1-215-451-00	METAL	18K 1% 1/4W
C1438	1-107-362-11	FILM	0.0047μF 10% 200V	R1439	1-215-451-00	METAL	18K 1% 1/4W
C1439	1-161-830-00	CERAMIC	0.0047μF 99% 500V	R1440	1-249-414-11	CARBON	560 5% 1/4W F
C1440	1-104-664-11	ELECT	47μF 20% 25V	R1441	1-247-815-91	CARBON	220 5% 1/4W
C1441	1-104-999-11	MYLAR	0.1μF 10% 200V	R1442	1-247-815-91	CARBON	220 5% 1/4W
C1443	1-126-935-11	ELECT	470μF 20% 16V	R1443	1-249-377-11	CARBON	0.47 5% 1/4W F
C1444	1-107-639-11	ELECT	47μF 20% 160V	R1444	1-247-815-91	CARBON	220 5% 1/4W
C1445	1-126-933-11	ELECT	100μF 20% 16V	R1445	1-249-403-11	CARBON	68 5% 1/4W
C1446	1-126-933-11	ELECT	100μF 20% 16V	R1448	1-249-417-11	CARBON	1K 5% 1/4W
C1450	1-130-471-00	FILM	0.001μF 5% 50V	R1449	1-249-403-11	CARBON	68 5% 1/4W
		<CONNECTOR>		R1450	1-249-417-11	CARBON	1K 5% 1/4W
CN1431	*1-564-508-11	PLUG, CONNECTOR 5P		R1451	1-247-815-91	CARBON	220 5% 1/4W
CN1432	*1-564-510-11	PLUG, CONNECTOR 7P		R1452	1-249-417-11	CARBON	1K 5% 1/4W
CN1433	*1-564-507-11	PLUG, CONNECTOR 4P		R1453	1-249-401-11	CARBON	47 5% 1/4W
CN1434	*1-580-689-11	PIN, CONNECTOR (PC BOARD) 4P		R1454	1-260-311-11	CARBON	39 5% 1/2W
CN1436	1-695-915-11	TAB (CONTACT)		R1455	1-249-384-11	CARBON	1.8 5% 1/4W F
CN1461	*1-564-506-11	PLUG, CONNECTOR 3P		R1456	1-216-476-11	METAL OXIDE	180 5% 3W F
CN1462	*1-564-507-11	PLUG, CONNECTOR 4P		R1457	1-249-417-11	CARBON	1K 5% 1/4W F
CN1464	*1-564-507-11	PLUG, CONNECTOR 4P		R1458	1-249-384-11	CARBON	1.8 5% 1/4W F
				R1459	1-249-400-11	CARBON	39 5% 1/4W F
				R1461	1-249-414-11	CARBON	560 5% 1/4W
				R1462	1-249-414-11	CARBON	560 5% 1/4W
				R1465	1-216-475-11	METAL OXIDE	120 5% 3W F
				R1468	1-216-475-11	METAL OXIDE	120 5% 3W F

The components identified by shading and mark Δ are critical for safety.
 Replace only with part number specified.

REF.NO.	PART NO.	DESCRIPTION	REMARK
---------	----------	-------------	--------

MISCELLANEOUS

	Δ 1-223-925-11	RESISTOR ASSY (HIGH-VOLTAGE)	
	Δ 1-451-455-11	DEFLECTION YOKE (R, G)	
	Δ 1-451-455-21	DEFLECTION YOKE (B)	
	Δ 1-452-790-11	NECK ASSY (NA-295)	
	1-452-909-31	MAGNET ASSY, 4 POLE	

	Δ 1-453-248-21	FBT ASSY(NX-4007//X4T4)	
	1-505-426-11	SPEAKER (10.6CM)	
	1-528-864-11	BATTERY, SOLAR	
	1-543-653-11	CORE ASSY, BEAD (DIVISION TYPE)	
	Δ 1-765-286-11	CORD, POWER (EXCEPT KP-41S5U)	

	Δ 1-776-860-11	CORD, POWER (KP-41S5U)	
	Δ 8-598-955-12	BLOCK ASSY, HIGH-VOLTAGE	
	Δ A-1501-259-A	MECHANICAL ASSY (R), SLANT	
	Δ A-1501-260-A	MECHANICAL ASSY (G), SLANT	
	Δ A-1501-261-A	MECHANICAL ASSY (B), SLANT	

ACCESSORIES AND PACKING MATERIALS

	3-867-512-11	MANUAL, INSTRUCTION (ENGLISH, GERMAN, FRENCH, ITALIAN, DUTCH, TURKISH) (KP-41S5)	
	3-867-512-21	MANUAL, INSTRUCTION (SPANISH, PORTUGUESE, SWEDISH, FINNISH, NORWEGIAN, DANISH) (KP-41S5)	
	3-867-512-31	MANUAL, INSTRUCTION (ENGLISH) (KP-41S5U)	
	3-867-512-41	MANUAL, INSTRUCTION (ENGLISH, CZECK, POLISH, MAGYAR, BULGARIAN, RUSSIAN) (KP-41S5K/41S5R)	
	3-867-512-51	MANUAL, INSTRUCTION (FRENCH) (KP-41S5B)	
	3-867-512-61	MANUAL, INSTRUCTION (ENGLISH, GREEK) (KP-41S5G)	
	3-867-513-11	INSTRUCTIONS (TV SYSTEM) (KP-41S5B)	
	* 4-029-168-01	BAG, PROTECTION	
	* 4-030-895-01	JOINT	
	* 4-041-423-11	SHEET, PROTECTION	
	* 4-061-032-01	CUSHION (UPPER) (ASSY)	
	* 4-061-033-01	CUSHION (LOWER) (ASSY)	
	* 4-062-158-01	TRAY	
	* 4-062-159-01	INDIVIDUAL CARTON	

REMOTE COMMANDER

	1-473-692-11	COMMANDER, STANDARD (RM-862)	
--	--------------	------------------------------	--

