

SONY®

PROFESSIONAL DISC RECORDER

PDW-F1600

PDW-HD1500

The supplied CD-ROM includes operation manuals for the PDW-F1600/HD1500 Professional Disc Recorder (English, Japanese, French, German, Italian, Spanish and Chinese versions) in PDF format.

For more details, see *"Using the CD-ROM Manual"* on page 16.

XDCAM HD
Professional Disc System

MPEG HD422

Professional Disc
DL 

 **CINEALTA**

OPERATION MANUAL

English

1st Edition (Revised 3)

Important Safety Instructions

- Read these instructions.
- Keep these instructions.
- Heed all warnings.
- Follow all instructions.
- Do not use this apparatus near water.
- Clean only with dry cloth.
- Do not block any ventilation openings.
- Install in accordance with the manufacturer's instructions.
- Do not install near any heat sources such as radiators, heat registers, stoves, or other apparatus (including amplifiers) that produce heat.
- Do not defeat the safety purpose of the polarized or grounding-type plug. A polarized plug has two blades with one wider than the other. A grounding-type plug has two blades and a third grounding prong. The wide blade or the third prong are provided for your safety. If the provided plug does not fit into your outlet, consult an electrician for replacement of the obsolete outlet.
- Protect the power cord from being walked on or pinched particularly at plugs, convenience receptacles, and the point where they exit from the apparatus.
- Only use attachments/accessories specified by the manufacturer.
- Use only with the cart, stand, tripod, bracket, or table specified by the manufacturer, or sold with the apparatus. When a cart is used, use caution when moving the cart/apparatus combination to avoid injury from tip-over.



- Unplug this apparatus during lightning storms or when unused for long periods of time.
- Refer all servicing to qualified service personnel. Servicing is required when the apparatus has been damaged in any way, such as power-supply cord or plug is damaged, liquid has been spilled or objects have fallen into the apparatus, the apparatus has been exposed to rain or moisture, does not operate normally, or has been dropped.

WARNING

To reduce the risk of fire or electric shock, do not expose this apparatus to rain or moisture.

To avoid electrical shock, do not open the cabinet. Refer servicing to qualified personnel only.

THIS APPARATUS MUST BE EARTHED.

CAUTION

The apparatus shall not be exposed to dripping or splashing. No objects filled with liquids, such as vases, shall be placed on the apparatus.

The unit is not disconnected from the AC power source (mains) as long as it is connected to the wall outlet, even if the unit itself has been turned off.

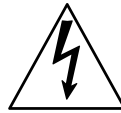
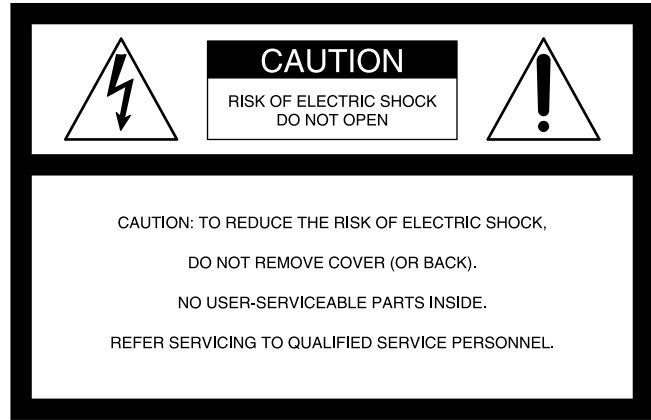

This symbol is intended to alert the user to the presence of uninsulated "dangerous voltage" within the product's enclosure that may be of sufficient magnitude to constitute a risk of electric shock to persons.



This symbol is intended to alert the user to the presence of important operating and maintenance (servicing) instructions in the literature accompanying the appliance.

WARNING: THIS WARNING IS APPLICABLE FOR USA ONLY.

If used in USA, use the UL LISTED power cord specified below.

DO NOT USE ANY OTHER POWER CORD.

Plug Cap	Parallel blade with ground pin (NEMA 5-15P Configuration)
Cord Length	Type SJT, three 16 or 18 AWG wires Minimum 1.5 m (4 ft. 11 in.), Less than 2.5 m (8 ft. 3 in.)
Rating	Minimum 10 A, 125 V

Using this unit at a voltage other than 120 V may require the use of a different line cord or attachment plug, or both. To reduce the risk of fire or electric shock, refer servicing to qualified service personnel.

WARNING: THIS WARNING IS APPLICABLE FOR OTHER COUNTRIES.

1. Use the approved Power Cord (3-core mains lead)/Appliance Connector/Plug with earthing-contacts that conforms to the safety regulations of each country if applicable.
2. Use the Power Cord (3-core mains lead)/Appliance Connector/Plug conforming to the proper ratings (Voltage, Ampere).

If you have questions on the use of the above Power Cord/ Appliance Connector/Plug, please consult a qualified service personnel.

CLASS 1 LASER PRODUCT
LASER KLASSE 1 PRODUKT
LUOKAN 1 LASERLAITE
KLASS 1 LASERAPPARAT

This Professional Disc Recorder is classified as a CLASS 1 LASER PRODUCT.

Laser diode properties

Wave length: 400 to 410 nm
Emission duration: Continuous
Laser output power: 135 mW (max. of pulse peak), 65 mW (max. of CW)
Standard: IEC60825-1 (2001)

Egenskaber for laserdiode

Bølgelængde: 400 til 410 nm
Strålingsvarighed: Kontinuerlig
Afgivet lasereffekt: 135 mW (maks stråletoppunkt), 65 mW (maks ved kontinuerlig stråling)
Standard: IEC60825-1 (2001)

Tekniska data för laserdiod

Våglängd: 400 till 410 nm
Emissionslängd: Kontinuerlig
Laserut effekt: 135 mW (max. för pulstopp), 65 mW (max. för kontinuerlig våg)
Standard: IEC60825-1 (2001)

Egenskaper for laserdiode

Bølgelængde: 400 til 410 nm
Strålingsvarighet: Uavbrutt
Utgangseffekt for laser: 135 mW (maks av pulshøyde), 65 mW (maks av CW)
Standard: IEC60825-1 (2001)



This label is located on the top panel of the drive unit.

Denna etikett finns på ovsidan av driftenheten.

Denne mærkat sidder på drevenhedens øverste panel.

Tämä kyltti sijaitsee ajurilaitteen yläpinnalla.

Dette merket er plassert på oversiden av driverenheten.

CAUTION

The use of optical instruments with this product will increase eye hazard.

CAUTION

Use of controls or adjustments or performance of procedures other than those specified herein may result in hazardous radiation exposure.

WARNING

Excessive sound pressure from earphones and headphones can cause hearing loss.
In order to use this product safely, avoid prolonged listening at excessive sound pressure levels.

VAROITUS!

LAITTEEN KÄYTTÄMINEN MUULLA KUIN TÄSSÄ KÄYTTÖOHJEESSA MAINITULLA TAVALLA SAATTAA ALTISTAA KÄYTTÄJÄN TURVALLISUUSLUOKAN 1 YLITTÄVÄLLE NÄKYMÄTTÖMÄLLE LASERSÄTEILYLLE.

WARNING

OM APPARATEN ANVÄNDS PÅ ANNAT SÄTT ÄN I DENNA BRUKSANVISNING SPECIFICERATS, KAN ANVÄNDAREN UTSÄTTAS FÖR OSYNLIG LASERSTRÅLNING, SOM ÖVERSKRIDER GRÄNSEN FÖR LASERKLASS 1.

When installing, the installation space must be secured in consideration of the ventilation and service operation.

- Do not block the ventilation slots at the left side, right side and bottom of front side panels, and vents of the fans.
- Leave more than 25 cm of space in the rear of the unit.
- Leave more than 2 cm of space in the left side, right side and top of the unit.

For the customers in the USA

This equipment has been tested and found to comply with the limits for a Class A digital device, pursuant to Part 15 of the FCC Rules. These limits are designed to provide reasonable protection against harmful interference when the equipment is operated in a commercial environment. This equipment generates, uses, and can radiate radio frequency energy and, if not installed and used in accordance with the instruction manual, may cause harmful interference to radio communications. Operation of this equipment in a residential area is likely to cause harmful interference in which case the user will be required to correct the interference at his own expense.

You are cautioned that any changes or modifications not expressly approved in this manual could void your authority to operate this equipment.

All interface cables used to connect peripherals must be shielded in order to comply with the limits for a digital device pursuant to Subpart B of Part 15 of FCC Rules.

This device complies with Part 15 of the FCC Rules. Operation is subject to the following two conditions: (1) this device may not cause harmful interference, and (2) this device must accept any interference received, including interference that may cause undesired operation.

For customers in Canada

This Class A digital apparatus complies with Canadian ICES-003.

For the customers in Europe

This product with the CE marking complies with both the EMC Directive and the Low Voltage Directive issued by the Commission of the European Community.

Compliance with these directives implies conformity to the following European standards:

- EN60065: Product Safety
- EN55103-1: Electromagnetic Interference (Emission)
- EN55103-2: Electromagnetic Susceptibility (Immunity)

This product is intended for use in the following Electromagnetic Environment(s):

E1 (residential), E2 (commercial and light industrial), E3 (urban outdoors) and E4 (controlled EMC environment, ex. TV studio).

For the customers in Europe

The manufacturer of this product is Sony Corporation, 1-7-1 Konan, Minato-ku, Tokyo, Japan.

The Authorized Representative for EMC and product safety is Sony Deutschland GmbH, Hedelfinger Strasse 61, 70327 Stuttgart, Germany. For any service or guarantee matters please refer to the addresses given in separate service or guarantee documents.

For kundene i Norge

Dette utstyret kan kobles til et IT-strømfordelingssystem.

Laite on liitettävä suojamaadoituskoskettimilla varustettuun pistorasiaan

Apparatet må tilkoples jordet stikkontakt

Apparaten skall anslutas till jordat uttag

For the Customers in Taiwan only



廢電池請回收

AVERTISSEMENT

Afin de réduire les risques d'incendie ou d'électrocution, ne pas exposer cet appareil à la pluie ou à l'humidité. Afin d'écartier tout risque d'électrocution, garder le coffret fermé. Ne confier l'entretien de l'appareil qu'à un personnel qualifié.

CET APPAREIL DOIT ÊTRE RELIÉ À LA TERRE.

ATTENTION

Eviter d'exposer l'appareil à un égouttement ou à des éclaboussures. Ne placer aucun objet rempli de liquide, comme un vase, sur l'appareil.

Cet appareil n'est pas déconnecté de la source d'alimentation secteur tant qu'il est raccordé à la prise murale, même si l'appareil lui-même a été mis hors tension.

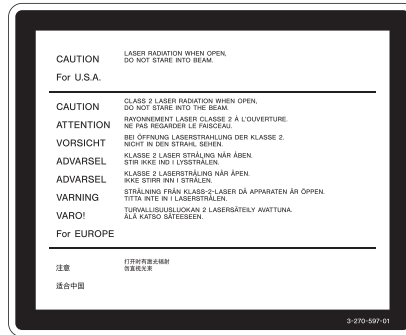

Cette étiquette est placée sur le panneau supérieur de l'unité de commande.

AVERTISSEMENT

Une pression acoustique excessive en provenance des écouteurs ou du casque peut provoquer une baisse de l'acuité auditive.

Pour utiliser ce produit en toute sécurité, évitez l'écoute prolongée à des pressions sonores excessives.

Pour les clients au Canada

Cet appareil numérique de la classe A est conforme à la norme NMB-003 du Canada.

Pour les clients européens

Ce produit portant la marque CE est conforme à la fois à la Directive sur la compatibilité électromagnétique (EMC) et à la Directive sur les basses tensions émises par la Commission de la Communauté Européenne.

La conformité à ces directives implique la conformité aux normes européennes suivantes :

- EN60065 : Sécurité des produits
- EN55103-1 : Interférences électromagnétiques (émission)
- EN55103-2 : Sensibilité électromagnétique (immunité)

Ce produit est prévu pour être utilisé dans les environnements électromagnétiques suivants :

E1 (résidentiel), E2 (commercial et industrie légère), E3 (urbain extérieur) et E4 (environnement EMC contrôlé ex. studio de télévision).

AVERTISSEMENT

1. Utilisez un cordon d'alimentation (câble secteur à 3 fils)/ fiche femelle/fiche mâle avec des contacts de mise à la terre conformes à la réglementation de sécurité locale applicable.
2. Utilisez un cordon d'alimentation (câble secteur à 3 fils)/ fiche femelle/fiche mâle avec des caractéristiques nominales (tension, ampérage) appropriées.

Pour toute question sur l'utilisation du cordon d'alimentation/ fiche femelle/fiche mâle ci-dessus, consultez un technicien du service après-vente qualifié.

Pour les clients en Europe

Le fabricant de ce produit est Sony Corporation, 1-7-1 Konan, Minato-ku, Tokyo, Japon.

Le représentant autorisé pour EMC et la sécurité des produits est Sony Deutschland GmbH, Hedelfinger Strasse 61, 70327 Stuttgart, Allemagne. Pour toute question concernant le service ou la garantie, veuillez consulter les adresses indiquées dans les documents de service ou de garantie séparés.

WARNUNG

Um die Gefahr von Bränden oder elektrischen Schlägen zu verringern, darf dieses Gerät nicht Regen oder Feuchtigkeit ausgesetzt werden.

Um einen elektrischen Schlag zu vermeiden, darf das Gehäuse nicht geöffnet werden. Überlassen Sie Wartungsarbeiten stets nur qualifiziertem Fachpersonal.

DIESES GERÄT MUSS GEERDET WERDEN.

ACHTUNG

Das Gerät ist nicht tropf- und spritzwassergeschützt. Es dürfen keine mit Flüssigkeiten gefüllten Gegenstände, z. B. Vasen, darauf abgestellt werden.

Solange das Netzkabel an eine Netzsteckdose angeschlossen ist, bleibt das Gerät auch im ausgeschalteten Zustand mit dem Stromnetz verbunden.

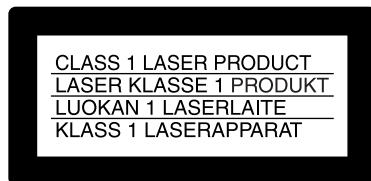

Dieser Professional Disc Recorder ist als CLASS 1 LASER PRODUCT eingestuft.

Daten der Laserdiode

Wellenlänge: 400 bis 410 nm

Emissionsdauer: Ununterbrochen

Laser-Ausgangsleistung: 135 mW (max. Impulsspitze),

65 mW (max. Dauerstrich)

Standard: IEC60825-1 (2001)



Dieser Aufkleber befindet sich oben auf der Antriebseinheit.

WARNUNG

Zu hoher Schalldruck von Ohrhörern und Kopfhörern kann Gehörschäden verursachen.

Um dieses Produkt sicher zu verwenden, vermeiden Sie längeres Hören bei sehr hohen Schalldruckpegeln.

Für Kunden in Europa

Dieses Produkt besitzt die CE-Kennzeichnung und erfüllt die EMV-Richtlinie sowie die Niederspannungsrichtlinie der EG-Kommission.

Angewandte Normen:

- EN60065: Sicherheitsbestimmungen
- EN55103-1: Elektromagnetische Verträglichkeit (Störaussendung)
- EN55103-2: Elektromagnetische Verträglichkeit (Störfestigkeit)

Für die folgenden elektromagnetischen Umgebungen:

E1 (Wohnbereich), E2 (kommerzieller und in beschränktem Maße industrieller Bereich), E3 (Stadtbereich im Freien) und E4 (kontrollierter EMV-Bereich, z.B. Fernsehstudio)

WARNUNG

1. Verwenden Sie ein geprüftes Netzkabel (3-adriges Stromkabel)/einen geprüften Geräteanschluss/einen geprüften Stecker mit Schutzkontakten entsprechend den Sicherheitsvorschriften, die im betreffenden Land gelten.
2. Verwenden Sie ein Netzkabel (3-adriges Stromkabel)/einen Geräteanschluss/einen Stecker mit den geeigneten Anschlusswerten (Volt, Ampere).

Wenn Sie Fragen zur Verwendung von Netzkabel/ Geräteanschluss/Stecker haben, wenden Sie sich bitte an qualifiziertes Kundendienstpersonal.

Für Kunden in Europa

Der Hersteller dieses Produkts ist Sony Corporation, 1-7-1 Konan, Minato-ku, Tokyo, Japan.

Der autorisierte Repräsentant für EMV und Produktsicherheit ist Sony Deutschland GmbH, Hedelfinger Strasse 61, 70327 Stuttgart, Deutschland. Bei jeglichen Angelegenheiten in Bezug auf Kundendienst oder Garantie wenden Sie sich bitte an die in den separaten Kundendienst- oder Garantiedokumenten aufgeführten Anschriften.

Table of Contents

Chapter 1 Overview

Marks for Model-Specific Functions	11
Features	11
Features of this unit	11
System Configurations	15
Using the CD-ROM Manual	16
Preparations	16
Reading the CD-ROM manual	16

Chapter 2 Names and Functions of Parts

Front Panel	17
Display window	23
Rear Panel	28

Chapter 3 Preparations

Preparing Power Sources	32
Supplying power	32
Attaching a battery pack	32
Initial Setup	33
Front Panel Tilt Mechanism	35
Connections and Settings	36
Connections for using PDZ-1 Proxy Browsing Software	36
Connections for cut editing	37
Using the editing functions of the recorder (controlling through REMOTE(9P) connector)	41
Connections for pool coverage	41
Synchronization Reference Signals	42
Setting System Frequency	43
Setting Timecode	43
Superimposed Text Information	45
Basic Operations of the Function Menu	48
Function menu operations	48
Function menu settings	48

Handling Discs.....	52
Discs used for recording and playback.....	52
Notes on handling.....	52
Write-protecting discs.....	53
Loading and unloading a disc.....	53
Formatting a disc.....	53

Chapter 4 Recording and Playback

Recording.....	54
Mixed recording of clips in different formats on the same disc.....	54
Preparations for recording.....	54
Carrying out recording.....	55
Continuing recording while exchanging discs (disc exchange cache function).....	56
Recording with the HDSDI remote control function.....	57
Recording with the Clip Continuous Rec function.....	57
Handling of discs when recording does not end normally (salvage functions).....	58
Linear Editing.....	59
Overview.....	59
Connections.....	60
Preparations for editing.....	60
Editing operations.....	61
Playback.....	62
Playback operation.....	63
Playback operations using thumbnails.....	65

Chapter 5 Operations in GUI Screens

Overview.....	66
Switching between GUI screens.....	66
Information and controls in thumbnail screens.....	67
Displaying menus.....	70
GUI screen operations.....	73
Thumbnail Operations.....	74
Selecting thumbnails.....	74
Searching with thumbnails.....	75
Playing the scene you have found.....	77
Selecting clips by type (Filter Clips function).....	77
Selecting the information displayed on thumbnails.....	79

Changing clip index pictures	79
Checking clip properties	80
Setting clip flags	82
Locking (write-protecting) clips	83
Deleting clips	83
Scene Selection (Clip List Editing)	85
What is scene selection?	85
Creating and editing clip lists	86
Managing clip lists	90
Disc Operations	92
Checking disc properties	92
Using planning metadata	92
Checking user-defined essence marks	93
Formatting discs	94
Displaying disc and clip properties in a web browser	94
Transferring clips (Direct FTP function)	97
Preparations for clip transfers	97
Uploading clips	98
Downloading clips	101
Copying clips directly between XDCAM devices	102
Shortcut List	103

Chapter 6 File Operations

Overview	104
Directory structure	104
File operation restrictions	105
Assigning user-defined clip titles	107
Assigning user-defined clip and clip list names	109
File Operations in File Access Mode (for Windows)	110
Making FAM connections	111
Operating on files	111
Exiting file operations	111
File Operations in File Access Mode (for Macintosh)	112
Making FAM connections	112
Operating on files	113
Exiting file operations	113
FTP File Operations	114
Making FTP connections	114
Command list	115
Recording Continuous Timecode with FAM and FTP Connections	120

Chapter 7 Menus

Menu System Configuration	121
Setup Menu	121
Items in the basic menu	122
Basic menu operations	126
Items in the extended menu	129
Extended menu operations.....	142
Maintenance Menu	144
Items in the maintenance menu	144
Maintenance menu operations	148

Chapter 8 Planning Metadata

Overview	151
Manipulating planning metadata	151
To set clip names by using planning metadata	151
Setting essence mark names by using planning metadata	152

Appendix

Important Notes on Operation	154
Condensation	154
About the LCD panel.....	154
Periodic Maintenance	155
Digital hours meter	155
Troubleshooting	157
Alarms.....	157
Error messages.....	167
To eject discs with the unit powered off.....	167
Specifications	167
Using PDZ-1 Proxy Browsing Software	170
Using UMID Data	171
Ancillary Data	173
Ancillary data in HDSDI signals	173
Ancillary data in MXF files	173
General MXF metadata.....	173
Correspondence between Setting Items of the HKDV-900 and Setup Menu of This Unit	174
List of Supported USB Keyboards	175

Trademarks and Licenses	178
MPEG-4 visual patent portfolio license	178
MPEG-2 video patent portfolio license	178
About IJG (Independent JPEG Group)	178
Character display software “iType”	178
About net-snmpd	178
About libupnp.....	181
Glossary	182
Index	184

Marks for Model-Specific Functions

In this manual, functions that are supported only by the PDW-F1600 or only by the PDW-HD1500 are indicated by the following marks.

F1600: PDW-F1600

HD1500: PDW-HD1500

Features

The PDW-F1600 or PDW-HD1500 is a professional disc recorder supporting full HD (1920 × 1080 and 1280 × 720) playback and recording with Professional Disc ¹⁾ media. When you use this unit in combination with a nonlinear editing system, the FAM ²⁾ function enables data file transfers between the unit and computers over the i.LINK ³⁾ interface, allowing the unit to be used like an external hard drive. The unit can be used as a player for video editing and program output, and as a recorder for nonlinear editing.

For these applications, it can be connected to Sony nonlinear editors, monitors, and video equipment with HDSDI interfaces via its standard HDSDI I/O connectors. It has a compact, lightweight body for easy portability outdoors, and can be powered from any of three power sources: AC, DC, or battery ⁴⁾ power.

1) Professional Disc is a trademark of Sony Corporation.

2) FAM: File access mode

3) This unit does not support DV stream output.

4) BKP-L551 Battery Adaptor is required.

Features of this unit

The principal features of this unit are as follows.

MPEG HD422 ¹⁾ codec

High-quality video and audio recording and playback

The MPEG HD422 codec provides video compression compliant with the MPEG-2 422P@HL standard. It enables HD 4:2:2 (50 Mbps) digital component file recording in the 1080i (1,080 effective scanning lines, interlaced) or 720P (720 effective scanning lines, progressive) format currently in use by many broadcast facilities.

Uncompressed PCM recording of 24-bit 48 kHz audio enables 8-channel audio recording at high sound quality.

1) MPEG HD422 is a trademark of Sony Corporation.

Long recording times

PDW-F1600 or PDW-HD1500 supports dual-layer Professional Discs (50 GB). When dual-layer Professional Discs are used, this unit can record about 95 minutes.

Recording and playback functions

Support for multiple SD¹⁾ and HD codecs

In addition to the MPEG HD422 codec, this unit supports the MPEG HD codec.²⁾ It can record HD 4:2:0 digital component files at both 1080i (35/25/18 Mbps³⁾) and 720P (35/25 Mbps), allowing HD operation across a wide range of recording times and application objectives. The unit is also capable of SD (IMX 30/40/50 Mbps or DVCAM codec) recording and playback.

- 1) **[HD1500]** When the PDBK-S1500 or PDBK-F1500 option is installed.
 2) MPEG HD is a registered trademark of Sony Corporation.
 3) Playback only supported for 18 Mbps.

Support for multiple frame frequencies

This unit can record and play multiple frame frequencies at both 1080 (59.94i, 50i, 29.97P, 25P, and 23.98P) and 720 (59.94P and 50P) (for MPEG HD422). It can also perform pulldown playback of discs recorded at 23.98P.¹⁾

- 1) **[HD1500]** When the PDBK-S1500 option is installed.

Support for mixed format recording mode

As long as the frame frequency group is the same, clips in different recording formats can be recorded or written to the same disc.¹⁾

The system frequencies supported by this unit are divided into frame frequency groups, as shown in the following table.

- 1) The recording format is regarded as different whenever the system frequency, video resolution, video codec/bit rate, or number of audio channels or number of bits does not match.

Frame frequency group	System frequency
59.94Hz	59.94P
	59.94i
	29.97P
50Hz	50P
	50i
	25P
23.98Hz	23.98P

You can record clips with different recording formats, for example HD422 and HD420SP clips, by putting this unit into mixed format recording mode.

Note

Continuous playback may not be possible at the transition point between two clips with different recording formats.

[F1600] Linear editing

Using this unit as the recorder, you can perform insert and assemble editing of recorded clips.

SD upconvert function

The unit can output HD signals while playing discs recorded as SD, allowing SD material to be utilized in an HD environment.¹⁾

- 1) **[HD1500]** When the PDBK-S1500 or PDBK-F1500 option is installed.

HD downconvert function

The unit is provided with a downconvert function. HD disc playback signals can be downconverted to SD signals and then output as S-SDI or composite signals. This allows you to use SD nonlinear editors and monitors for editing and program output.

1080/720 cross-conversion

This unit supports cross-conversion output. It can output 720 while playing discs recorded as 1080, and output 1080 while playing discs recorded as 720.

HDS-SDI remote recording

HDS-SDI connections can be made to camcorders with remote HDS-SDI support (PDW-700 XDCAM HD422 camcorder, HDW-730/730S/750/790/F900R HDCAM¹⁾ camcorders) to enable recording synchronized to REC and STOP operations on the camcorder.

- 1) HDCAM is a trademark of Sony Corporation.

Clip Continuous Rec function

Normally, a clip is generated as an independent file every time recording starts and stops. The Clip Continuous Rec function allows you to continue recording to the same clip until the function is stopped or turned off, regardless of how many times recording starts and stops. This is convenient if you want to avoid generating a large number of short clips, or if you want to record without worrying about the limit on the number of clips (maximum 300).

Note

This function is available only when you are operating equipment connected to the REMOTE(9P) or SD/HDS-SDI INPUT connector. It is not available on the front panel.

Recording of proxy AV data

Proxy AV data is a low-resolution (1.5 Mbps video, 64 kbps per audio channel), MPEG-4 based version of a full resolution data stream. Whenever this unit records full resolution MPEG HD422 data, it simultaneously generates and records low-resolution proxy AV data. Because of its small size, proxy AV data can be transferred quickly over computer networks, easily edited in the field with laptop

computers,¹⁾ and readily used in a wide variety of applications, such as content management on small-scale servers.

1) The supplied PDZ-1 Proxy Browsing Software can be used to create simple EDLs (Edit Decision Lists).

High-speed searches with the jog and shuttle dials

The jog and shuttle dials can be used to find scenes inside clips, in the same way as the jog and shuttle dials on conventional VTRs.

In jog and variable modes, you can search in field units at from -2 to +2 times normal speed. Shuttle mode supports high-speed searches up to a maximum of ± 20 times normal speed. (F.FWD and F.REV are possible up to 35 times normal speed.)

Convenient disc-based playback and searching

Like previous products in the XDCAM series, this unit supports a number of convenient search functions, including scene selection, thumbnail searches, essence marks searches, and expand searches.

Scene selection: This function allows you to select clips from the disc and insert them into playlists. Clips can be inserted and played back in any order.

Thumbnail searches: The unit creates thumbnails from the first frame of each generated clip, and displays them in thumbnail lists on the color LCD or an external monitor. You can cue up clips very easily by simply by selecting them from thumbnail lists.

Essence mark searches: Essence marks can be recorded at any scene during or after recording. Lists of these marks can be displayed on the color LCD or an external monitor, allowing you to quickly find scenes that were marked for later reference.

Expand searches: This function allows you to look inside the clip selected in a thumbnail screen, or inside the segment from a selected essence mark to the next essence mark. The selection range is divided into 12 equal blocks, and the first frames of those blocks are displayed as thumbnails. By checking the thumbnails, you can easily find the scene you want.

Filter Clips function

You can select clips of a certain type from among all of the clips on a disc. For example, you can do the following.

- Select clips in a certain video format from a disc that contains clips in different video formats.
- Select only clips with NG (bad) clip flags, and delete all of those clips in one operation.
- Select only clips that were recorded according to planning metadata, and use the Direct FTP function to transfer those clips to an external device.

Usability features

AC, DC, and battery¹⁾ power support

The unit can be used even where AC power is not available, for example outdoors or in cars or helicopters.

1) BKP-L551 Battery Adaptor is required.

Color LCD display

The unit is equipped with a 16:9, 4.3-inch color LCD which allows you to check the contents of the disc and use the menu system without connecting an external monitor.

Built-in speakers

The unit features built-in speakers, allowing you to check recorded audio. You can check your clips and editing results on the color LCD and speakers even when no monitors or separate speakers are available.

Tiltable front panel

The front panel is tiltable for easy rack-mount and desktop operation. You can adjust the panel to the angle that makes the buttons easiest to use.

Cache recording for seamless disc exchanges

About 30 seconds (this duration may differ depending on the state of a disc) of video and audio data can be recorded to the unit's internal memory cache during a disc exchange, and then written back to the newly loaded disc. This allows seamless recording across extended recording sessions, including recording of video feeds, with no important scenes lost while discs are being exchanged.

Cart system support

With its compact body, this unit can replace the SD PDW-1500 unit. You can mount this unit in the PDJ-C1080 and PDJ-A640 XDCAM cart systems.

IT friendly

Computer access to files (file access mode)

Video and audio clip data are recorded as files. The FAM function enables quick random access by computers to the video, audio, and metadata files stored on Professional Discs, with the ability to display thumbnail lists on the computer screen and perform file-based reads and writes.

Equipped with network connector

The unit features a Gigabit Ethernet connector as standard equipment. Via this connector, you can connect the unit to computers and networks to enable listing of the video, audio, and metadata files recorded on the Professional Disc, and rapid file transfers. Support for FTP commands makes it easy to carry out network file transfers from remote locations.

The unit has two optical pickups for high-speed transfers.

Direct FTP function

You can use this unit as a local FTP host to send and receive MXF files to and from other XDCAM devices,

without using a computer. This function is available through simple operations on the GUI screen.

Supports SNMP for maintenance and service

This unit supports Sony's SNMP-based remote maintenance and monitoring software. This software allows you to monitor the status of the hardware via a TCP/IP network in real time, and to record the results in a status log.

User data recording mode

User data (files other than XDCAM AV files) can be recorded on Professional Discs as PC data via the i.LINK or FTP interface. This allows Professional Discs to be used as data recording media, with a data storage capacity of 46.4 GB (when dual-layer PFD50DLA discs are used).

Supports a variety of interfaces

This unit supports the following interfaces.

- HDSDI video, 8-channel audio input and output
- SDDSI video, 8-channel audio input and output (the SD/HDSDI INPUT connector doubles as an SDDSI input connector)
- SD composite output
- AES/EBU digital audio 4-channel input and output
- Analog audio 2-channel input and output
- Remote
 - RS-422A (D-sub 9-pin × 1)
 - Video remote (D-sub 9-pin × 1)TBC control is available from the front panel.
- i.LINK TS (HDV) input and output (when PDBK-201 option board is installed)

System Configurations

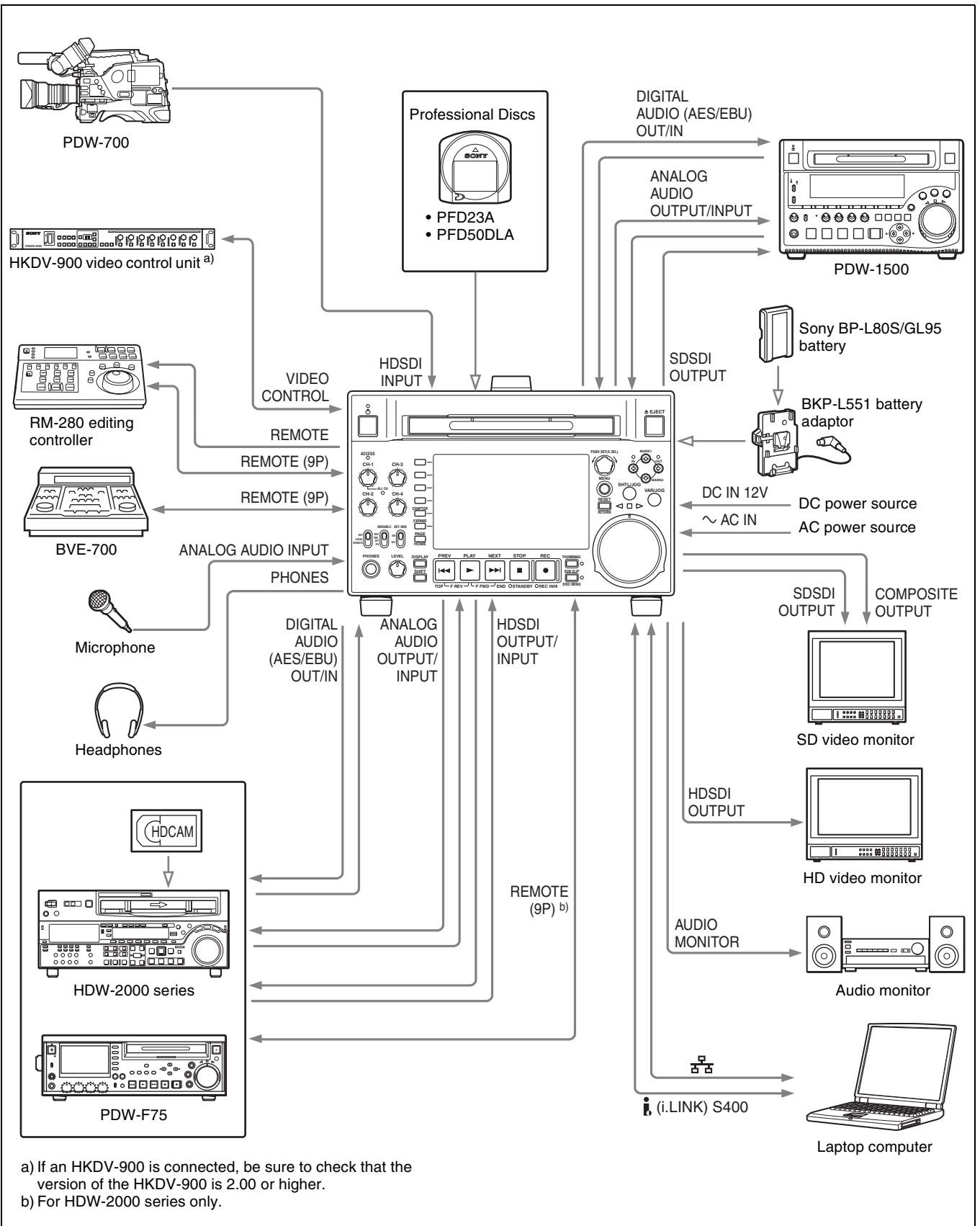

a) If an HKDV-900 is connected, be sure to check that the version of the HKDV-900 is 2.00 or higher.
 b) For HDW-2000 series only.

Using the CD-ROM Manual

The supplied CD-ROM includes versions of the Operation Manual for the PDW-HD1500 in English, Japanese, French, German, Italian, Spanish and Chinese in PDF format.

Preparations

The following program must be installed on your computer in order to read the operation manuals contained on the CD-ROM.

- Adobe Reader Version 6.0 or higher

Memo

If Adobe Reader is not installed, you can download it from the following URL:
<http://www.adobe.com/>

Adobe and Adobe Reader are trademarks of Adobe Systems Incorporated in the United States and/or other countries.

Reading the CD-ROM manual

To read the operation manual contained on the CD-ROM, do the following.

- 1** Insert the CD-ROM in your CD-ROM drive.

A cover page appears automatically in your browser. If it does not appear automatically in the browser, double-click on the index.htm file on the CD-ROM.
- 2** Select and click on the operation manual that you want to read.

This opens the PDF file of the operation manual.

Memo

The files may not be displayed properly, depending on the version of Adobe Reader. In such a case, install the latest version you can download from the URL mentioned in “Preparations” above.

Note

If you have lost or damaged the CD-ROM, you can purchase a new one to replace it. Contact your Sony service representative.

Names and Functions of Parts

Chapter

2

Front Panel

The names and symbols of buttons and knobs on the front panel are color coded according to function.

White: Function when the button or knob is operated independently.

Orange: Function when the button is operated with the SHIFT button held down.

Blue: Function related to thumbnail operations.

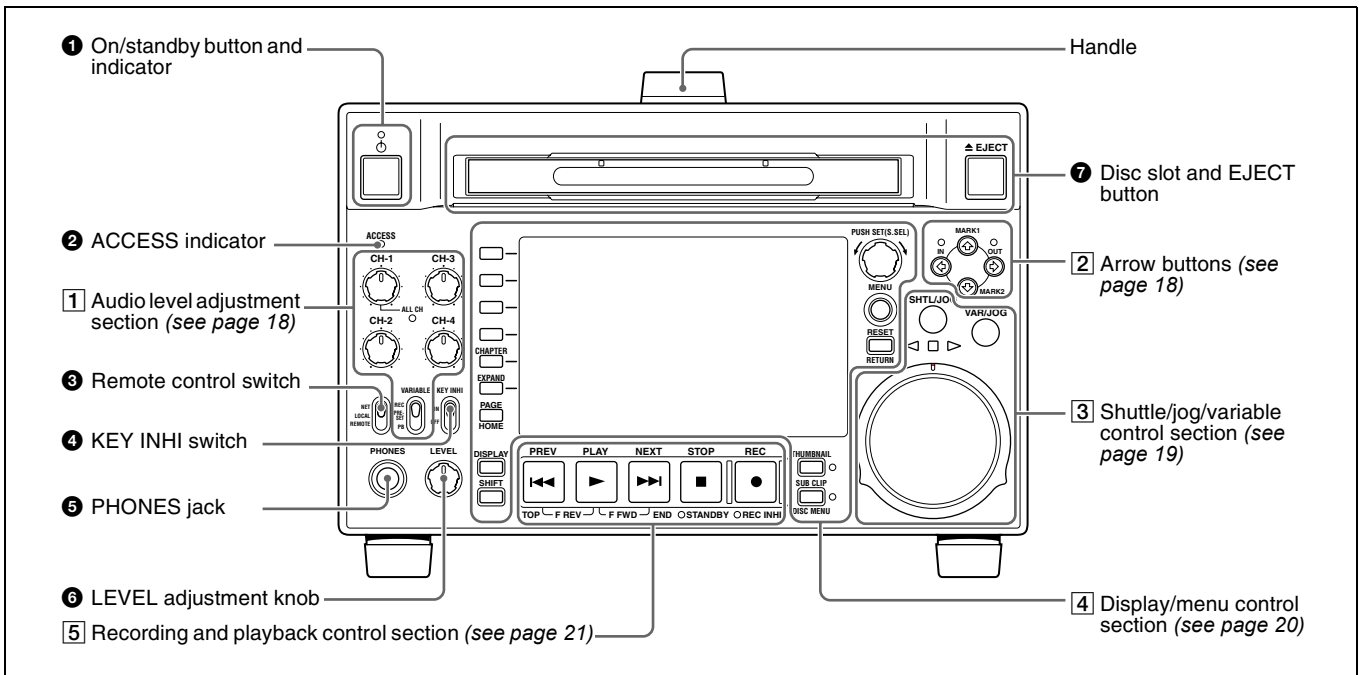

1 On/standby (⏻) button and indicator

When the POWER switch on the rear panel is in the **I** position, and when DC power is connected to the DC IN 12V connector on the rear panel, this switches the unit between the operating state (the indicator is lit green) and the standby state (the indicator is lit red).

When the indicator is lit red, pressing the button switches this unit to the operating state, and the indicator lights continuously green.

When the indicator is lit green, pressing the button switches the unit to the standby state, and the indicator

lights continuously red. If a disc is loaded in the unit, the indicator flashes before changing to continuously lit red. When using this unit, normally leave the rear panel POWER switch in the **I** (on) position, and use this button to switch the unit between the operating state and standby state.

2 ACCESS indicator

This lights when the disc is accessed and when a file is opened by a FAM or FTP connection (see page 104). If the on/standby button is pressed while this indicator is lit,

access to the disc is completed before the unit switches to the standby state.

Note

While the ACCESS indicator is lit, do not turn off the POWER switch on the rear panel or disconnect the power cord. This could lead to a loss of data from the disc.

3 Remote control switch

Different positions of the switch allow different operations as follows.

NET: Enables access to the network. The indicator lights when an external network device is being accessed. In this state, operation from the front panel is not possible.

LOCAL: Enables operation from the front panel.

REMOTE: Enables remote control of this unit from the following devices:

- Devices connected to the REMOTE(9P) connector on the rear panel
- Devices connected to the SD/HDSDI INPUT connector with SDI remote control functions
- Devices connected to the i.LINK S400 connector

Use setup menu item 214 REMOTE INTERFACE to select which of the connectors is used for remote control (see page 131).

See “Setup Menu” on page 121 for more information about how to make extended menu settings.

4 KEY INHI switch

This turns key operation inhibit mode on or off.

Use setup menu item 118 KEY INHIBIT SWITCH EFFECTIVE AREA to specify the keys to inhibit.

5 PHONES jack

The jack is a standard stereo jack. Connect stereo headphones to monitor the audio during recording, playback, and editing. (Non-audio signals are muted.) The monitored channel is selected with MONITR L and MONITR R on page P2 AUDIO of the function menu (see page 49).

6 LEVEL (volume) adjustment knob

Adjust the volume of headphones or speakers with the knob. You can also cause this to simultaneously adjust the output volume from the AUDIO MONITOR R, L connectors on the rear panel. To do this, set setup menu item 114 AUDIO MONITOR OUTPUT LEVEL to “var”.

7 Disc slot and EJECT button

Insert a disc in the disc slot. To remove the disc, press the EJECT button.

1 Audio level adjustment section

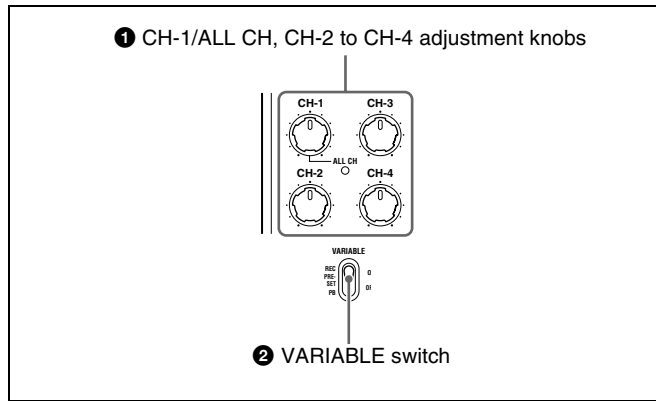

1 CH-1/ALL CH, CH-2 to CH-4 (audio level) adjustment knobs

Depending on the setting of the VARIABLE switch, these adjust the input audio or playback audio levels of channels 1 to 4.

You can adjust levels of channels 5 to 8 using the function menu. See page 50 for details.

By the setting of setup menu item 131 AUDIO VOLUME, you can enable the CH-1/ALL CH adjustment knob to simultaneously adjust all eight channels. When this simultaneous adjustment is enabled, the ALL CH indicator lights.

2 VARIABLE (audio level adjustment selector) switch

This selects whether input audio levels or playback audio levels are adjusted by the CH-1/ALL CH and CH-2 to CH-4 adjustment knobs for channels 1 to 4, or by the function menu setting for channels 5 to 8.

REC: Adjust the input audio levels. The playback audio levels are fixed at their preset values.

PRESET: The audio levels are fixed at their preset values.

PB: Adjust the playback audio levels. The input audio levels are fixed at their preset values.

2 Arrow buttons

The four arrow buttons are also used as the MARK 1 button, MARK 2 button, IN button, and OUT button. The correspondence with these buttons is as follows.

▲ **button:** MARK 1 button

▼ **button:** MARK 2 button

◀ **button:** IN button

▶ **button:** OUT button

You can use these buttons for thumbnail selection, menu setting operations, setting In/Out points, and so on.

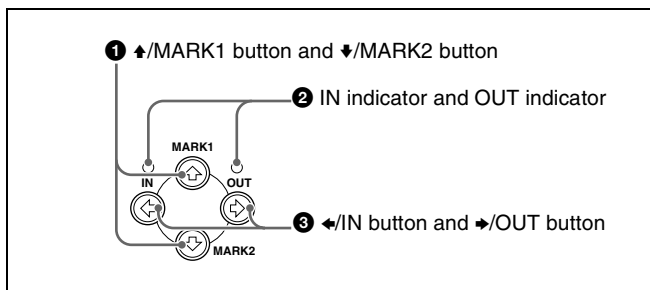

1 ▲/MARK1 button and ▼/MARK2 button

When the THUMBNAIL indicator (*see page 21*) is lit, you can use these for thumbnail selection.

During recording or playback, a shot mark 1 or shot mark 2 is recorded as an essence mark when you press the PUSH SET (S.SEL) knob with the ▲/MARK1 or ▼/MARK2 button held down. If you connect a Windows USB keyboard to the MAINTENANCE connector, you can record shot marks from Shot Mark0 up to Shot Mark9 by pressing the 0 to 9 keys on the numeric keypad.

Use the PDZ-1 Proxy Browsing Software on the supplied XDCAM Application Software CD-ROM to delete and modify essence marks.

Essence marks can also be deleted and modified from the Thumbnail Menu of the chapter thumbnail screen (*see page 69*).

2 IN indicator and OUT indicator

IN indicator: When an In point is set, this lights. If an attempt is made to set the In point after a recorded Out point, this flashes.

OUT indicator: When an Out point is set, this lights. If an attempt is made to set the Out point before a recorded In point, this flashes.

3 ◀/IN button and ▶/OUT button

When the THUMBNAIL indicator (*see page 21*) is lit, you can use these for thumbnail selection.

An In or Out point is set when you press the PUSH SET(S.SEL) knob with the ◀/IN or ▶/OUT button held down. The In or Out point setting is deleted when you press the RESET/RETURN button with the ◀/IN or ▶/OUT button held down.

3 Shuttle/jog/variable control section

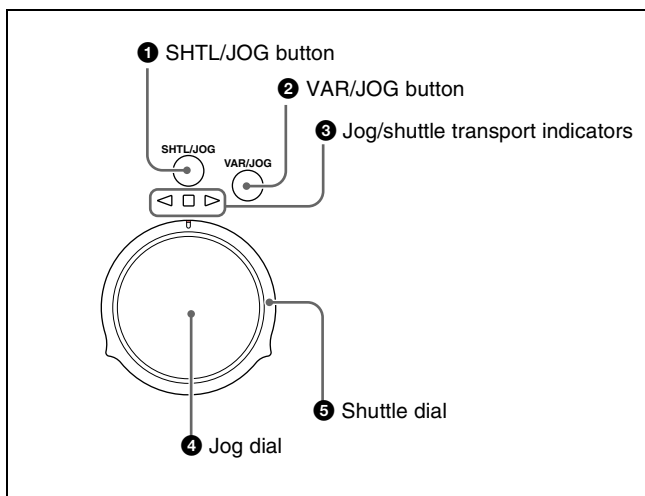

For details of playback operations with these buttons and dials, see “Playback operation” on page 63.

1 SHTL/JOG button

Press this button, turning it on, to perform shuttle playback with the shuttle dial or jog playback with the jog dial. When pressed during recording, stops recording and selects shuttle/jog mode. If you do not want to stop recording when this button is pressed, set setup menu item 145 MODE KEY ENABLE DURING RECORDING to “stop”.

2 VAR/JOG button

Press this button, turning it on, to perform variable playback with the shuttle dial or jog playback with the jog dial.

When pressed during recording, stops recording and selects variable/jog mode. If you do not want to stop recording when this button is pressed, set setup menu item 145 MODE KEY ENABLE DURING RECORDING to “stop”.

3 Jog/shuttle transport indicators

These show the playback direction in jog, shuttle, or variable speed mode.

◀ (green): Lights during playback in the reverse direction.

▶ (green): Lights during playback in the forward direction.

■ (red): Lights during still image display.

4 Jog dial

Turn this for playback in jog mode. Turn clockwise for forward direction playback, and counterclockwise for reverse direction playback. In jog mode, the playback speed varies from -1 to +1 times normal speed, according to the rotation rate of the jog dial. There are no detents. Normally, you press the SHTL/JOG or VAR/JOG button before turning the jog dial, but it is also possible to make a setting to enable jog mode directly by turning the dial (set

setup menu item 101 SELECTION FOR SEARCH DIAL ENABLE to “dial”).

5 Shuttle dial

Turn this for playback in shuttle mode or variable speed mode. Turn clockwise for forward direction playback, and counterclockwise for reverse direction playback.

- In shuttle mode, the playback speed varies in the range ± 20 times normal speed, according to the angular position of the shuttle dial.
- In variable speed mode, you can finely adjust the playback speed from -2 to $+2$ times normal speed, according to the angular position of the shuttle dial.

The shuttle dial has a detent at the center position, for still image playback.

Normally, you press the SHTL/JOG button before turning the shuttle dial, but it is also possible to make a setting to enable shuttle mode directly by turning the dial (set setup menu item 101 SELECTION FOR SEARCH DIAL ENABLE to “dial”).

Note

When setup menu item 101 SELECTION FOR SEARCH DIAL ENABLE is set to “dial”, after using the shuttle dial, return it to the center position. If the shuttle dial is not in the center position, it is possible occasionally for vibration from other operations to activate the dial, and start playback in shuttle mode.

4 Display/menu control section

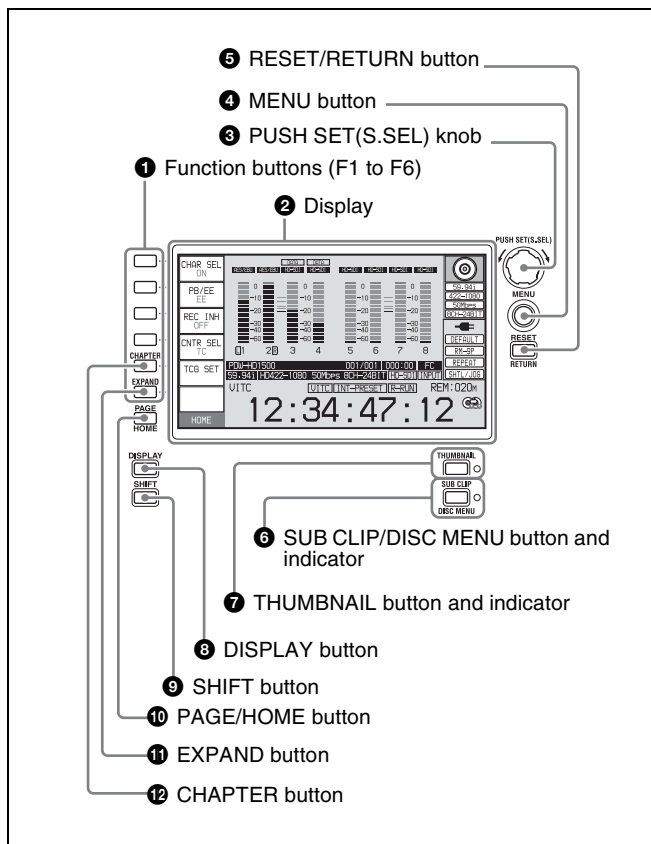

1 Function buttons (F1 to F6)

These buttons are enabled when the function menu (see page 48) is visible. Each press of a button changes the setting of the corresponding item in the menu.

For convenience, this manual refers to these buttons as buttons F1 to F6, in order from the top.

2 Display

Displays menus, audio level meters, and data such as time data or clip information. The DISPLAY button lets you switch to the video monitor display.

For details, see “Display window” on page 23.

3 PUSH SET(S.SEL) knob

Use for menu and GUI screen operations. Turn the knob to select items, and press it to confirm the selection. This button is also used to set numerical and timecode values. You can also change the playback speed by pressing the PLAY button and turning this knob during playback (see page 65).

See “GUI screen operations” (page 73) for more information about how to use the thumbnail screens.

4 MENU button

Displays the setup menu or the GUI screen menu. The setup menu appears when no GUI screen is visible. The same information is also superimposed on the display on a monitor connected to the unit. Press once more to return to the original display.

See “GUI screen operations” (page 73) for more information about how to use the thumbnail screens.

5 RESET/RETURN button

Functions as the RESET button or the RETURN button.
RESET button: Reset counters or the setting values of the timecode generator. This button is also used to abort or cancel setup menu, scene selection, and thumbnail search operations.

RETURN button: In setup menu and GUI screens, returns to the previous procedure.

6 SUB CLIP/DISC MENU button and indicator

When pressed alone, functions as the SUB CLIP button. When pressed together with the SHIFT button, functions as the DISC MENU button.

SUB CLIP button: Press the button, lighting the indicator, to carry out playback in clip list order (see page 85). Jog and shuttle operations are supported during clip list playback. To return to playback in recording order, press the button again, turning the indicator off.

Note

If no clip list is registered, this button does not light when pressed. The operation is invalid.

DISC MENU button: When pressed together with the SHIFT button, displays the Disc Menu (*see page 92*). Press the button again, turning the indicator off, to hide the Disc Menu.

See “GUI screen operations” (page 73) for more information about how to use the thumbnail screens.

7 THUMBNAIL button and indicator

To carry out a thumbnail search or create a clip list in the GUI screen, press this button turning the indicator on. Thumbnail images representing each clip or sub-clip appear. Press once more, turning the indicator off, to return to a whole-screen display.

To display the thumbnails of essence mark frames (frames with an essence mark attached), hold down the SHIFT button, and press this button. The essence mark selection menu appears. Select the desired type of essence mark, and the corresponding essence mark frames appear in thumbnails. Press once more, turning the indicator off, to return to a whole-screen display.

See “GUI screen operations” (page 73) for more information about how to use the thumbnail screens.

8 DISPLAY button

Each press of this button switches between the basic operation display and video monitor display (*see page 23*). This button is disabled unless either the basic operation display or the video monitor display is displayed.

9 SHIFT button

Switches between functions for any button with two functions.

10 PAGE/HOME button

When pressed alone functions as the PAGE switching button. When pressed together with the SHIFT button, functions as the HOME button.

PAGE button: Displays the function menu, if it is not already visible. (The most recently displayed page of the function menu appears.)

HOME button: When pressed with the function menu visible, returns to the HOME page of the function menu.

11 EXPAND button

When pressed during thumbnail display, divides the selected clip into 12 blocks and displays a list of thumbnails of the first frame in each block (expand function). The division is repeated with each press (up to 3 times, for a total of 1,728 blocks).

When this button is pressed together with the SHIFT button, the unit returns to the previous division level. Press the RESET/RETURN button to return to the thumbnail screen.

This button also becomes a function button (F6) when the function menu is visible.

See page 75 for more information about the expand function.

12 CHAPTER button

When pressed during thumbnail display, displays a list of thumbnails of the frames where essence marks are recorded (chapter function). When this is pressed again, returns to normal thumbnail display. The chapter function can be useful when essence mark thumbnails provide more information about the content of the clip than the index pictures of the first frames. This can also be used to cue up long clips.

This button also becomes a function button (F5) when the function menu is visible.

See page 75 for more information about the chapter function.

5 Recording and playback control section

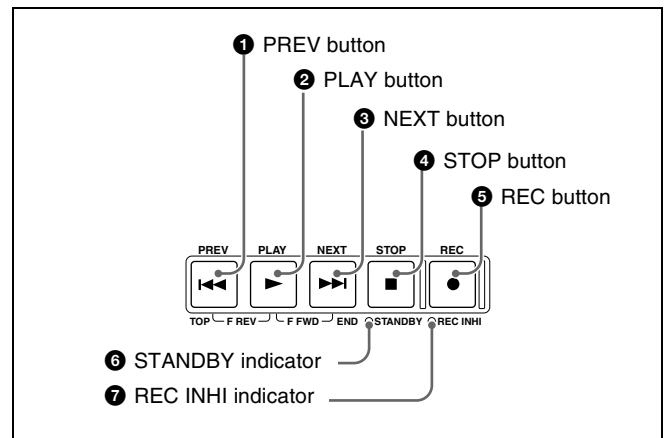

1 PREV (previous) button

Press this button, turning it on, to show the first frame of the current clip. While the first frame of a clip is shown, pressing this button jumps to the beginning of the previous clip.¹⁾ This button is also used together with other buttons for the following operations.

Reverse direction high-speed search: Hold down the PLAY button, and press this button. A high-speed search in the reverse direction is carried out.

Displaying the first frame of the first clip: Hold down the SHIFT button, and press this button.

1) When setup menu item 153 FIND MODE is set to “clip & rec start mark”, this button jumps to the frame where the previous Rec Start essence mark is set and displays the video of that frame.

2 PLAY button

To start playback, press this button, turning it on. When pressed during recording, stops recording and enters stop mode. If you do not want to stop recording when this button is pressed, set setup menu item 145 MODE KEY ENABLE DURING RECORDING to “stop”.

3 NEXT button

Press this button, turning it on, to jump to the next clip, and show the first frame.¹⁾ This button is also used together with other buttons for the following operations.

Forward direction high-speed search: Hold down the PLAY button, and press this button. A high-speed search in the forward direction is carried out.

Displaying the last frame of the last clip: Hold down the SHIFT button, and press this button.

1) When setup menu item 153 FIND MODE is set to “clip & rec start mark”, this button jumps to the frame where the next Rec Start essence mark is set and displays the video of that frame.

4 STOP button

To stop recording or playback, press this button, turning it on. The frame at the stop point appears.

The unit enters standby off mode when you press this button with the SHIFT button held down. It returns from standby off mode to the original state when you press this button again with the SHIFT button held down. (The lit or unlit status of the STOP button does not change.)

Note

This button flashes when setup menu item 105 REFERENCE SYSTEM ALARM is set to “on” and the correct reference video input signal (as specified by OUT REF on page P6 REF of the function menu) is not being input.

This unit can automatically enter standby off mode whenever a specified time elapses in disc stop mode. For details, see the description of setup menu item 501 STILL TIMER (page 132).

5 REC (record) button

To start recording, hold down this button, and press the PLAY button. The recording takes place on an unrecorded part of the disc.

To stop recording, press the STOP button.

To monitor in E-E mode

You can press this button from stop mode to monitor input signals in E-E mode. The button lights when pressed. Press the STOP button to return to the original video.

You can also press this button during playback and searches. E-E mode playback continues for as long as the button is held down.

6 STANDBY indicator

Lights when the unit is in standby mode (STOP button and, STANDBY indicator lit).

After a certain time passes in a disc stop mode, the unit automatically enters standby off mode and the indicator goes off.

You can specify the time until the unit enters standby off mode. For details, see the description of setup menu item 501 STILL TIMER (page 132).

7 REC INHI (recording inhibit) indicator

This lights in the following cases.

- When a disc with recording inhibited is loaded.
- When REC INH on the HOME page of the function menu is set to “ON”.
- The format of the recorded part of the disc does not match the system frequency settings of the unit.

Display window

Basic operation display

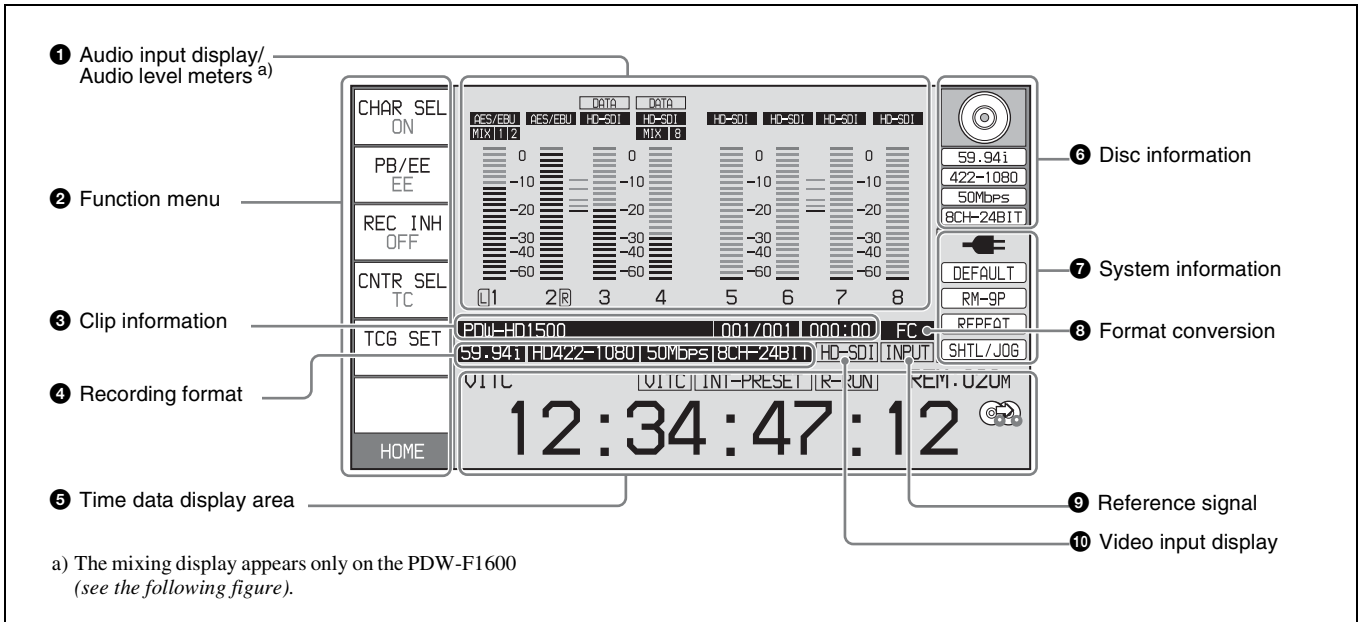

1 Audio input display/Audio level meters
Displays information about audio. There are two display modes for the audio level meter: FULL mode and FINE

mode, which can be switched over using AU METER on page P4 AUDIO of the function menu.

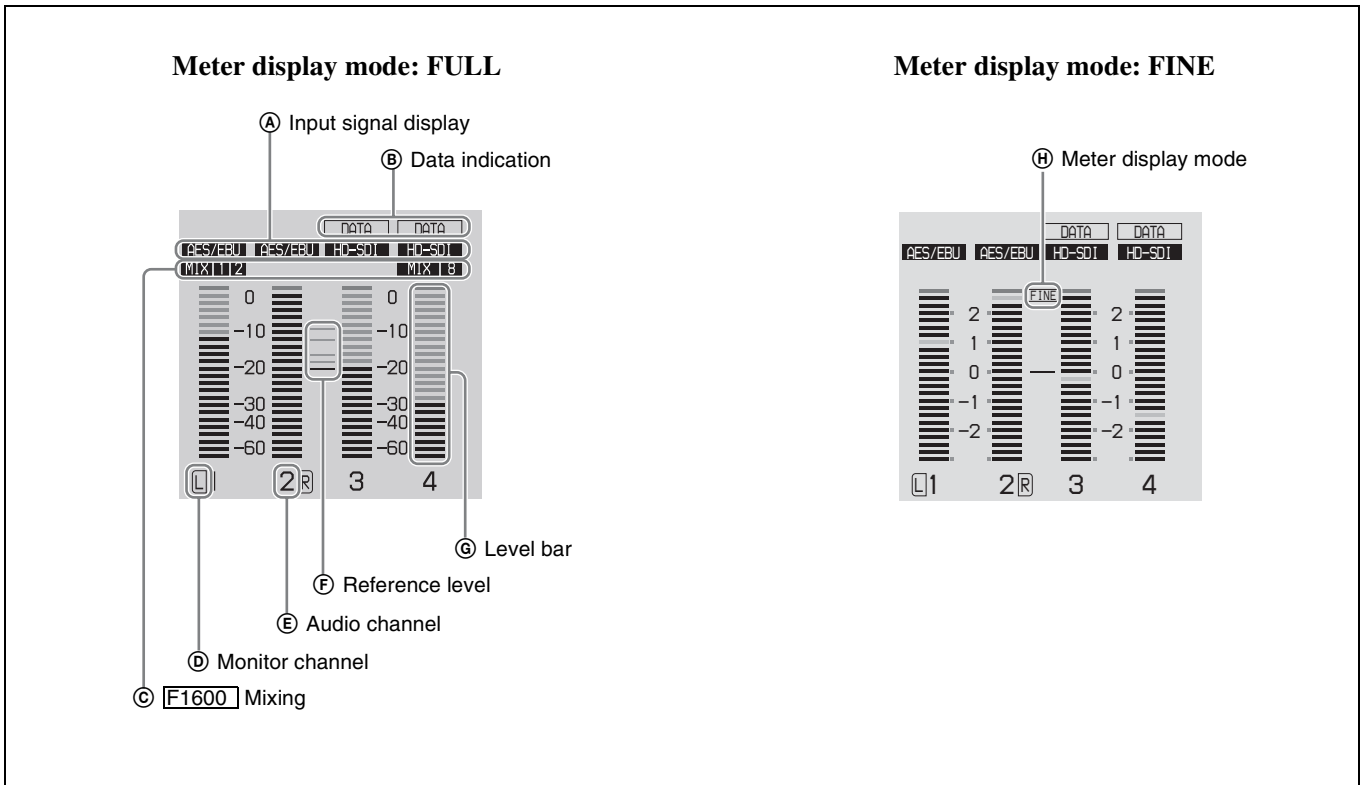

A Input signal display: Displays the audio input signal.

Display	Input signal	
ANA-1	Analog audio signal	Channel 1, 3
ANA-2		Channel 2, 4
MIC-1	Input signal from the microphone connected to ANALOG AUDIO INPUT connector	Channel 1, 3
MIC-2		Channel 2, 4
AES/EBU	AES/EBU format digital audio signal (flashes when there is no input signal)	
HD-SDI	HDS DI audio signal (flashes when there is no input signal)	
SD-SDI	SDSDI audio signal (flashes when there is no input signal)	
SG	Test signal from the internal signal generator	
No indication	Undefined audio signal, or no audio input	

- B Data indication:** Appears when the input signals are non-audio signals.
- C F1600 Mixing:** Displays the input channels used for audio mixing. (These channels are selected with setup menu item 819 AUDIO INPUT ARRANGE.)
- D Monitor channel:** Displays the audio monitoring channels set with MONITR L and MONITR R on page P2 AUDIO of the function menu (see page 49).
- E Audio channel:** Displays the audio channels. Also indicates preset or variable mode by its color
White: Preset mode
Green: Variable mode
- F Reference level:** Displays the reference level for recording as set in the maintenance menu.
- G Level bars:** Display the audio recording or playback levels of channels 1 to 8. The OVER indicators light when the audio level exceeds 0 dB.
- H Meter display mode:** Displays the audio level meter display mode selected with AU METER on page P4 AUDIO of the function menu (see page 50).

2 Function menu

Use the PAGE/HOME button to display this menu, and to switch between the pages (HOME, P1 to P7, (P8)¹⁾, (HOME2)¹⁾) of the menu. Each page has three to six setting items. Press the corresponding button to change a setting.

1) If a menu item is assigned using maintenance menu item M38: F-KEY CONFIG

For details, see page 48 “Basic Operations of the Function Menu” in Chapter 3.

3 Clip information

Displays clip information.

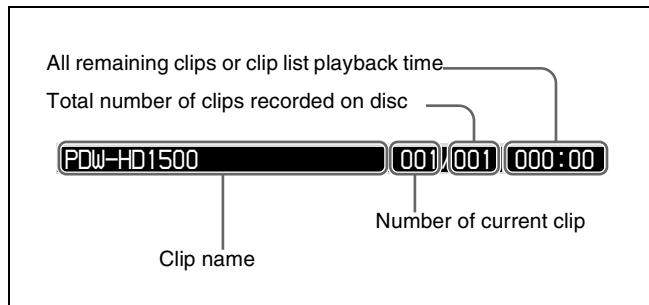

4 Recording format

Displays the system frequency and the video and audio formats.

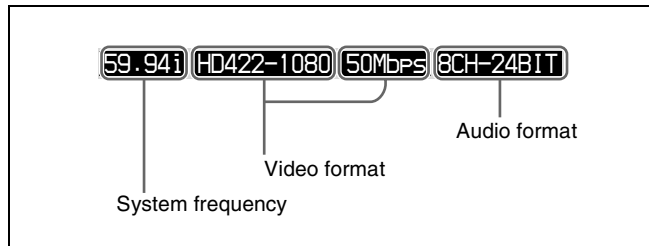

5 Time data display area

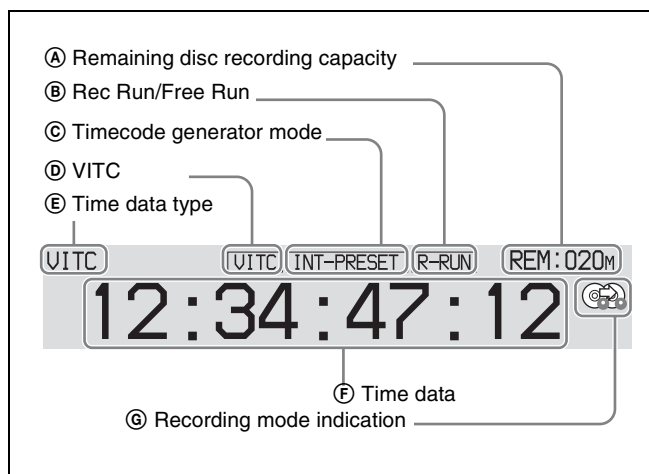

- A Remaining disc recording capacity:** Displays the amount of recording capacity remaining on the disc.
- B Rec Run/Free Run:** Displays the timecode run mode. The run mode is set with RUN MODE on page P5 TC of the function menu (see page 51).
- C Timecode generator mode:** Displays the timecode source and generation method (preset or regenerate). These are set with PRST/RGN and TCG on page P5 TC of the function menu (see page 51).
- D VITC:** Lights in the following cases.
- When VITC is read in playback mode. (This has no relations to the display in the time data display area.)
 - When VITC recording is possible.
- E Time data type:** Displays the type of time data displayed in the time data display area. The type of time data is selected with CNTR SEL on the HOME page of the function menu (see page 48).

Display	Type of time data
TC	Timecode
COUNTER	Elapsed recording/playback time
UB	User bits
VITC	VITC
VIUB	VIUB
TCG	Timecode generator value
UBG	User bits generator value

Ⓕ **Time data:** Normally displays timecode or VITC, according to the selection made with TCR on page P5 TC of the function menu.

Ⓖ **Recording mode indication:** This appears when setup menu item 150 REC MODE is set to “disc exchange cache” or “clip continuous rec” (see page 130).

See page 56 for more information about the disc exchange cache function.

See page 57 for more information about the Clip Continuous Rec function.

6 Disc information

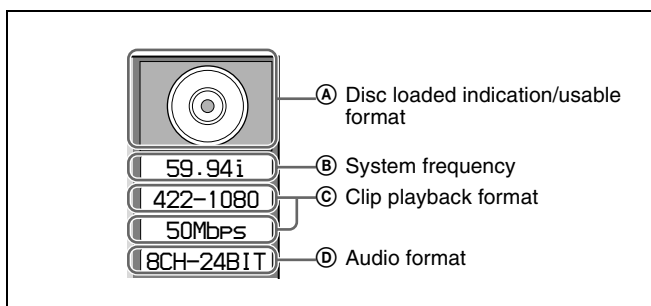

Ⓐ **Disc loaded indication/usable format:** When a disc is loaded in this unit, a disc loaded indication appears. When no disc is loaded, the usable formats are displayed.

The background color of the disc loaded mark indicates one of the following disc states.

Blue: Disc capable of recording and playback.

Yellow: Disc capable of playback only.

Red: Disc incapable of recording and playback.

Note

Even if the background is blue, recording is not possible in the following cases.

- When a disc with recording inhibited is loaded.
- When REC INH on the HOME page of the function menu is set to “ON”.

The usable formats displayed when no disc is loaded in this unit are as follows.

Display	Usable format
	HD422: HD422
	HD420: HD420HQ/HD420SP/HD420LP ^{a)}

a) HD420LP supports playback only.

When the PDBK-S1500 option is installed

Display	Usable format
	HD422: HD422
	HD420: HD420HQ/HD420SP/HD420LP ^{a)}
	IMX: MPEG IMX 50Mbps/40Mbps/30Mbps
	DVCAM: DVCAM

a) HD420LP supports playback only.

Ⓑ **System frequency:** Displays the system frequency of the clips recorded on the disc.

Ⓒ **Video format:** Displays the video format and bitrate of the clips recorded on the disc.

Ⓓ **Audio format:** Displays the audio format of the clips recorded on the disc.

7 System information

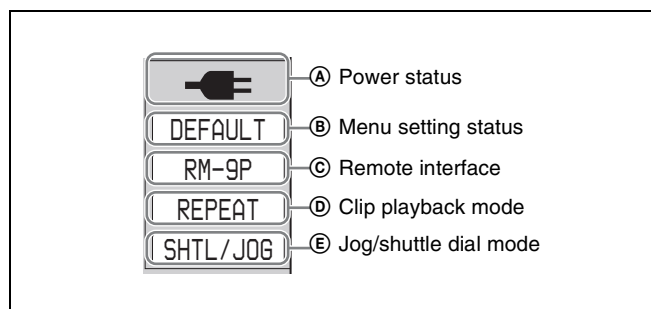

Ⓐ **Power status:** Displays the status of the power supply to the unit.

Display	Power status
	AC power
	Battery
	Battery almost exhausted: Flashes at 1 Hz Battery exhausted: Flashes at 4 Hz
	AC power (power-saving mode)
	Battery (power-saving mode)
	Battery (power-saving mode/low)

Ⓑ **Menu setting status:** Displays the current setting status of setup menu.

Display	Description
BANK1	The current menu settings are the same as the settings in menu bank 1.
BANK2	The current menu settings are the same as the settings in menu bank 2.
BANK3	The current menu settings are the same as the settings in menu bank 3.
DEFAULT	The current menu settings are the same as the factory defaults.
No display	The current menu settings are different from all of the above.

- Ⓒ **Remote interface:** When the remote control switch is set to REMOTE, displays the name of the interface selected with setup menu item 214 REMOTE INTERFACE.
- Ⓓ **Clip playback mode:** The clip playback mode appears as follows, according to the settings of setup menu items 142 REPEAT MODE and 154 SINGLE CLIP PLAY MODE.

Display	Setup menu setting		Description
	Item 142	Item 154	
REPEAT	play	off	Repeat playback mode: Perform repeat playback of all clips on the disc.
SINGLE	off	on	Single clip playback mode: Play the currently selected clip once.
SNGL RPT	play	on	Single clip repeat playback mode: Play the currently selected clip repeatedly.
No display	off	off	Continuous playback mode: Perform continuous playback of all clips on the disc, playing each clip once.

- Ⓔ **Jog/shuttle dial mode:** Appears when the unit is in shuttle, jog, or variable mode.

8 Format conversion

This displays the status of 1080/720 format conversion.

□ : Format conversion is not being performed.

■FC■ : Format conversion is being performed.

See page 63 for more information about 1080/720 cross convert function.

9 Reference signal

This displays the type of reference signal to which this unit is synchronizing.

When there is no display, the unit is synchronizing to the internal reference signal.

INPUT: Input video

HD REF: HD-format reference signal

SD REF: SD-format reference signal

Note

The HD REF or SD REF display flashes when the video input signal is not synchronized to the reference signal, and when the signals are synchronized but their phases do not match.

10 Video input display

This displays the currently selected video input signal.

HDSDI: HDSDI video input

SDSDI: SDSDI video input

i.LINK: i.LINK TS (HDV) input ¹⁾

SG: Test video signal from the internal signal generator

1) When the PDBK-201 option board is installed

Note

The display blinks when there is no video input signal, and when the video input signal does not match the system frequency of this unit.

The video signal input is selected with V INPUT on page P1 VIDEO of the function menu (see page 49).

Video monitor display

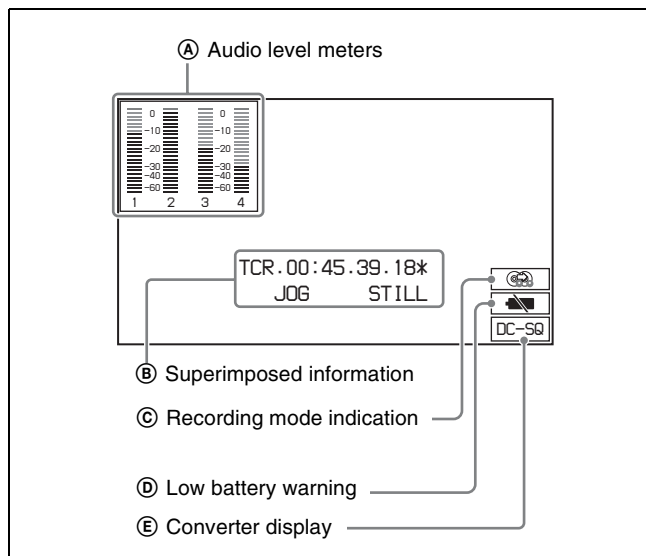

When you press the DISPLAY button, the display window changes to the video monitor display.

A Audio level meters: LEVEL MT on page P2 AUDIO of the function menu decides whether the meter is to be displayed and on which side, left or right, it is displayed in the display window.

B Superimposed information: Appears when CHAR SEL on the HOME page of the function menu is set to "ON" or "LCD".

- Ⓒ **Recording mode indication:** This appears when setup menu item 150 REC MODE is set to “disc exchange cache” or “clip continuous rec” (see page 130).

See page 56 for more information about the disc exchange cache function.

See page 57 for more information about the Clip Continuous Rec function.

- Ⓓ **Low battery warning:** Appears and flashes during operation with a battery pack when the battery power is almost exhausted.

- Ⓔ **Converter display:** Displays the current down- or up-converter mode, depending on the state of the unit. The current down-converter (DC) mode appears when HD video is being input and when an HD disc is being played. The current up-converter (UC) mode appears when SD video is being input and when an SD disc is being played.¹⁾

The current modes are those selected with setup menu items 930 DOWN CONVERTER MODE (DC) and 950 UP CONVERTER MODE¹⁾.

1)When the PDBK-S1500 option is installed.

DC-EC: Down-converter edge-crop mode

DC-LB: Down-converter letter box mode

DC-SQ: Down-converter squeeze mode

UC-EC: Up-converter edge-crop mode

UC-LB: Up-converter letter box mode

UC-SQ: Up-converter squeeze mode

Rear Panel

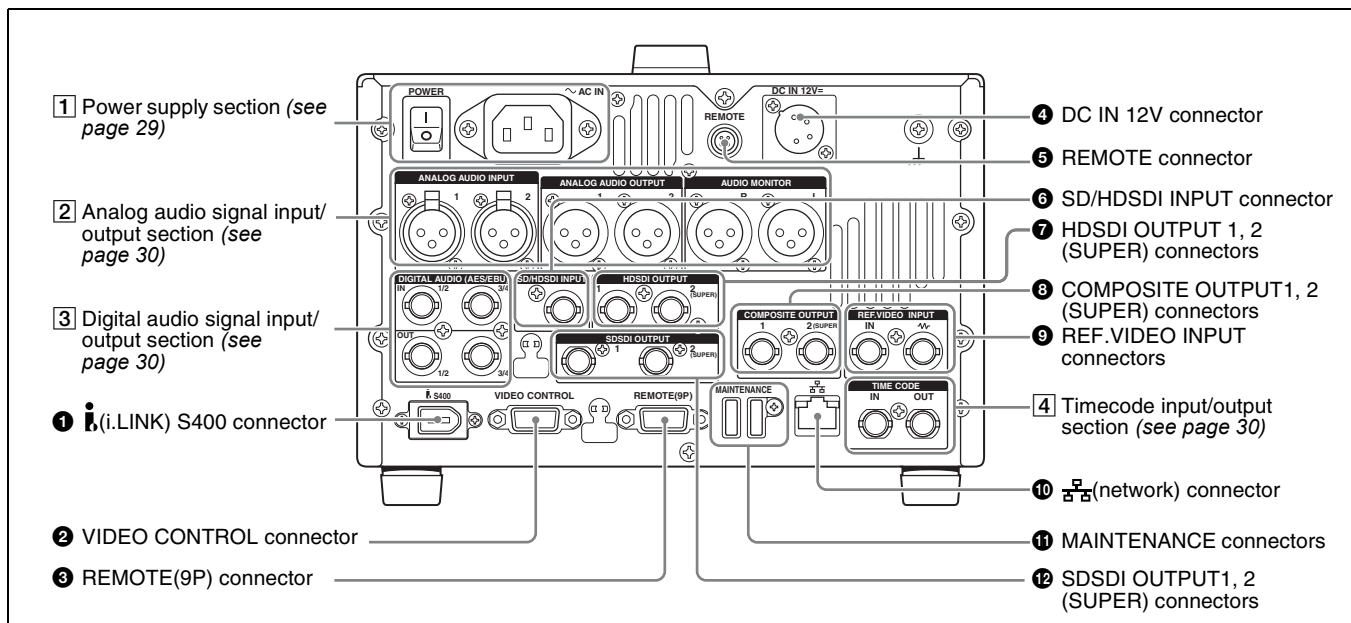

1 i.LINK S400 connector (6-pin, IEEE1394 compliant)

Connect a computer or other device, using an i.LINK cable.

When the PDBK-201 option board is installed, i.LINK TS (HDV) signals can be input and output via this connector.

Notes

- When this unit is connected to a device with a 6-pin i.LINK connector by an i.LINK cable, before unplugging the i.LINK cable, first power off the device and disconnect the power plug from the outlet. If the i.LINK cable is unplugged with the device power plug still connected, a current from an excessive voltage (8 to 40 V) output from the i.LINK connector of the device flows into this unit. This may cause a failure of the unit.
- When connecting this unit to a device with a 6-pin i.LINK connector, connect to the 6-pin i.LINK connector of the other device first.

2 VIDEO CONTROL connector (D-sub-9-pin)

Connect an HKDV-900 video control unit.

See page 174 for correspondence between setting items of HKDV-900 and setup menu of this unit.

3 REMOTE(9P) (remote control 9-pin) connector (D-sub 9-pin)

To control this unit from a controller or VTR supporting the RS-422A Sony 9-pin VTR protocol, connect the device to this connector.

4 DC IN 12V connector (XLR 4-pin, male)

Connect to a DC power source of 12 V.

When using the BKP-L551 Battery Adaptor to mount a battery pack, connect the power cable of the BKP-L551.

For details, see “Supplying power” on page 32.

5 REMOTE connector (4-pin)

Supplies power to the RM-280 Editing Controller.

6 SD/HDSDI INPUT (SDSDI/HDSDI signal input) connector (BNC type)

This inputs an SDSDI or HDSDI format video/audio signal.

7 HDSDI OUTPUT 1, 2 (SUPER) (HDSDI signal output 1, 2 (superimpose)) connectors (BNC type)

These output HDSDI format video/audio signals. When editing with two PDW-HD1500 units, connect a cable between these connectors on the player unit and the SD/HDSDI INPUT connector on the recorder unit. You can superimpose timecodes, menu settings, error messages, or other information on the output of the HDSDI OUTPUT 2 (SUPER) connector with the setting for CHAR SEL on the HOME page of the function menu or with the setting for setup menu item 028 HD CHARACTER. You can always disable to superimpose the data independent of the setting for CHAR SEL with the setting for setup menu item 028.

See “Basic Operations of the Function Menu” (page 48) for more information about the CHAR SEL settings.

See page 124 for more information about the setup menu item 028 HD CHARACTER.

To treat the input and output signals of these connectors as non-audio signals, set the maintenance menu item M37: AUDIO CONFIG >M372: NON-AUDIO INPUT (recording) (see page 144) and setup menu item 823 NON-AUDIO FLAG PB (playback).

8 COMPOSITE OUTPUT 1, 2 (SUPER) (analog composite video output 1, 2 (superimpose)) connectors (BNC type)

Output analog composite video signals. You can superimpose timecodes, menu settings, or error messages on the output of the 2 (SUPER) connector when CHAR SEL on the HOME page of the function menu is set to ON.

See “Basic Operations of the Function Menu” on page 48 for more information about the CHAR SEL setting.

9 REF.VIDEO INPUT (reference video signal input) connectors (BNC type)

The two connectors form a loop-through connection; when a reference video signal is input to the left connector, the same signal is input from the right connector () to a connected device. When no connection is made to the right connector, the left connector is automatically terminated with an impedance of 75 ohms.

10 (network) connector (RJ-45 type)

This is a 10BASE-T/100BASE-TX/1000BASE-T connector for network connection.

CAUTION

For safety, do not connect the connector for peripheral device wiring that might have excessive voltage to this port. Follow the instructions for this port.

ATTENTION

Par mesure de sécurité, ne raccordez pas le connecteur pour le câblage de périphériques pouvant avoir une tension excessive à ce port. Suivez les instructions pour ce port.

ACHTUNG

Aus Sicherheitsgründen nicht mit einem Peripheriegerät-Anschluss verbinden, der zu starke Spannung für diese Buchse haben könnte. Folgen Sie den Anweisungen für diese Buchse.

11 MAINTENANCE connectors

These are the USB connectors for maintenance. Connect a Windows USB keyboard or mouse (see page 81), or a USB flash drive to access planning metadata stored on the drive (see page 92).

12 SDSDI OUTPUT 1, 2 (SUPER) (SDI signal outputs 1, 2 (superimpose)) connectors (BNC type)

These output SDSDI format video/audio signals.

When the unit is shipped from the factory, audio signal output is eight channels with no switching, and RP188 timecode output is set to on. You can change these settings with setup menu item 828 SDI AUDIO OUTPUT SELECT and setup menu item 920 SD-SDI H-ANC CONTROL.

The output from the 2 (SUPER) connector can have timecode, menu settings, alarm messages, and other text information superimposed. To turn superimposition off, set CHAR SEL on the HOME page of the function menu to “OFF”.

See “Items in the extended menu” (page 129) for more information.

See “Basic Operations of the Function Menu” (page 48) for more information.

1 Power supply section

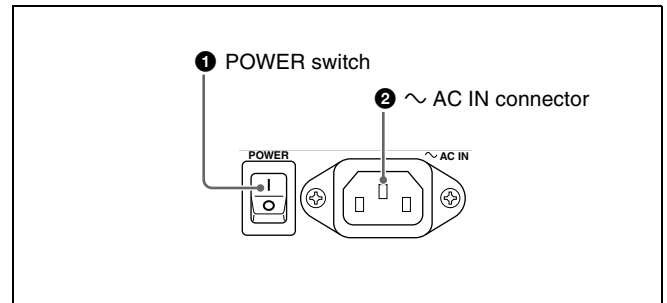

1 POWER (main power) switch

Press the **I** side to power on the unit. Press the **O** side to power off.

When using the unit, normally leave the POWER switch in the **I** (on) position, and use the on/standby button on the front panel to switch the unit between the operating state and standby state.

Note

Before turning the main power off, always check to be sure that the unit is in the standby state, and then press the main power switch to the **O** side.

2 ~AC IN connector

Connect to an AC power supply with the power cord (not supplied).

2 Analog audio signal input/output section

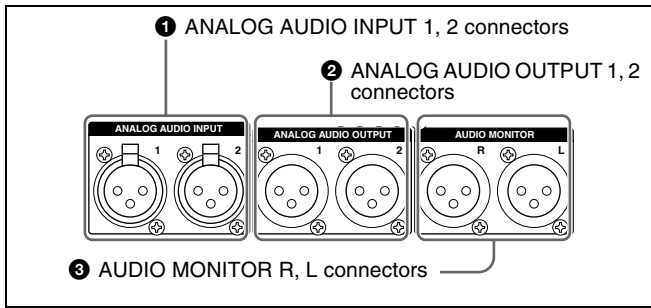

1 ANALOG AUDIO INPUT 1, 2 connectors (XLR 3-pin, female)

These input analog audio signals.

With A1 INPUT or A2 INPUT on page P2 AUDIO, and A3 INPUT or A4 INPUT on page P3 AUDIO of the function menu (see page 50), you can select whether the signal input to connector 1 is assigned to audio channel 1 or 3, and whether the signal input to connector 2 is assigned to audio channel 2 or 4.

You can set the reference input level with the maintenance menu item M37: AUDIO CONFIG (see page 144). (Factory default setting: +4 dB)

Microphone settings

If you have connected a microphone to this unit, you can set input level, AGC, and limiter values for the microphone with setup menu items 834, 839, 840, and 841 (see page 140).

Note

An unpleasant sound may be output if you have connected a microphone to the ANALOG AUDIO INPUT 1 or 2 connector and power the microphone on with the input level too high. Check the input level setting before connecting a microphone.

2 ANALOG AUDIO OUTPUT 1, 2 connectors (XLR 3-pin, male)

These output analog audio signals.

When the unit is shipped from the factory, the 1 connector is set to audio channel 1, and the 2 connector is set to audio channel 2. You can change these settings with setup menu item 824 ANALOG LINE OUTPUT SELECT (see page 139).

You can set the output level with the maintenance menu item M37: AUDIO CONFIG (see page 144). (Factory default setting: +4 dB)

Non-audio signals are muted.

3 AUDIO MONITOR R, L connectors (XLR 3-pin, male)

This outputs an audio signal for monitoring.

The monitored channel is selected with MONITR L and MONITR R on page P2 AUDIO of the function menu.

See “Basic Operations of the Function Menu” (page 48) for more information.

3 Digital audio signal input/output section

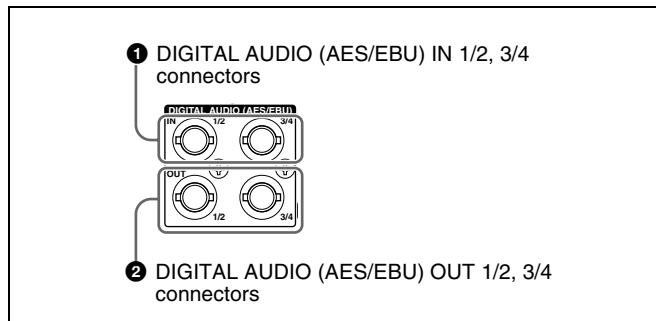

1 DIGITAL AUDIO (AES/EBU) IN (digital audio input) 1/2, 3/4 connectors (BNC type)

These input AES/EBU format digital audio signals. The left connector (1/2) corresponds to audio channels 1 and 2, and the right connector (3/4) corresponds to audio channels 3 and 4.

2 DIGITAL AUDIO (AES/EBU) OUT (digital audio output) 1/2, 3/4 connectors (BNC type)

These output AES/EBU format digital audio signals.

When the unit is shipped from the factory, the 1/2 connector is set to audio channel 1/2, and the 3/4 connector is set to audio channel 3/4. You can change these settings with setup menu item 827 AES/EBU AUDIO OUTPUT SELECT (see page 139).

To treat the input and output signals of these connectors as non-audio signals, set the maintenance menu item M37: AUDIO CONFIG > M372: NON-AUDIO INPUT (recording) (see page 144) and setup menu item 823 NON-AUDIO FLAG PB (playback).

4 Timecode input/output section

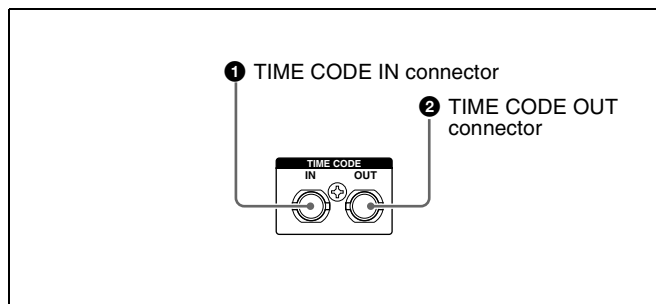

1 TIME CODE IN connector (BNC type)

This inputs an SMPTE timecode generated by an external device.

2 TIME CODE OUT connector (BNC type)

This outputs the following timecode, depending on the operating state of this unit.

During playback: Playback timecode

During recording: The timecode from the internal timecode generator or the timecode input to the TIME CODE IN connector
When setup menu item 611 TC OUTPUT PHASE IN EE MODE is set to “muting”, no timecode is output.



Preparing Power Sources

This unit can be powered by AC power, DC power, or a battery pack.

For safety, use only the Sony battery packs listed below.
Lithium-ion battery pack: BP-L80S, BP-GL95

Note

If you load or remove a battery pack incorrectly, it may fall and cause bodily injury. Follow the procedures described below to load or remove them.

Supplying power

AC power supply

Connect the AC IN connector to an AC power source using the specified AC power cord. To supply AC power to the unit, set the on/standby button on the front panel to ON and the POWER switch on the rear panel to **I** (ON).

DC power supply

Connect the DC IN 12V connector to a DC power source. To supply DC power to the unit, set the on/standby button on the front panel to ON and the POWER switch on the rear panel to OFF. If the POWER switch on the rear panel is set to **I** (ON), AC power is supplied.

Battery power supply

Battery packs that can be used with this unit are as follows. To use battery pack, a BKP-L551 Battery Adaptor and a BC-L100 Battery Charger are also required.

- BP-L80S
- BP-GL95

Continuous recording time at room temperature

BP-GL95 lithium-ion battery pack: 80 minutes (95 minutes when used in power save mode)

For details on charging battery packs, refer to the operation manual for the battery charger.

Notes about battery usage

- Before using the batteries, be sure to charge them fully with the special battery charger. Refer to the operating instructions for your battery charger for more information about how to charge the batteries.
- Batteries may not be completely charged if you charge them immediately after use when they are still warm. You should wait until the batteries cool before charging them.

Attaching a battery pack

Attaching and removing of the BP-GL95 Battery Pack is described below.

The BP-L80S can also be attached and removed in the same way.

For details on attaching the BKP-L551, refer to the installation manual for the BKP-L551.

- 1 Attach the BKP-L551 to the side panel.

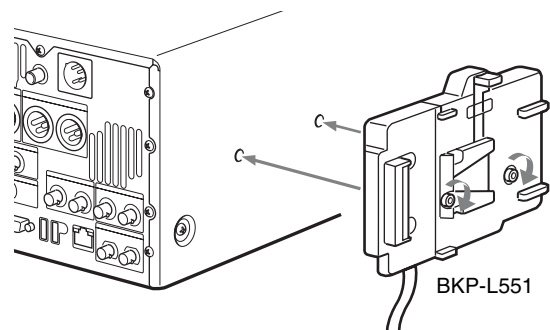

- 2 Align the grooves on the BP-GL95 with the projections on the BKP-L551.

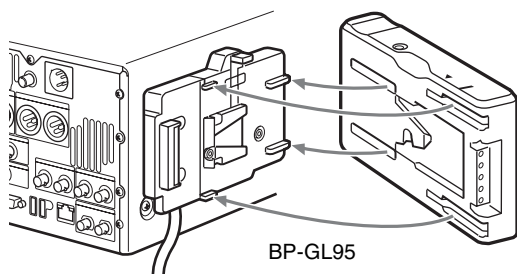

- 3** Slide the BP-GL95 as shown below so that the connectors on the BP-GL95 and the BKP-L551 are connected.

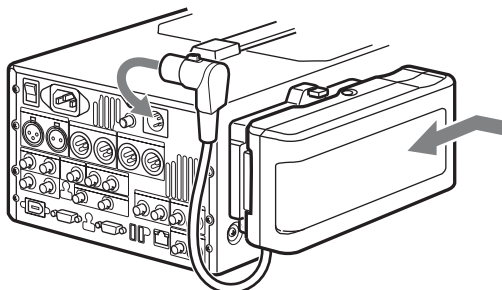

- 4** Connect the DC cable of the BKP-L551 to the DC IN 12V connector.

Removing the battery pack

With the lever pushed in, slide the BP-GL95 out as shown below.

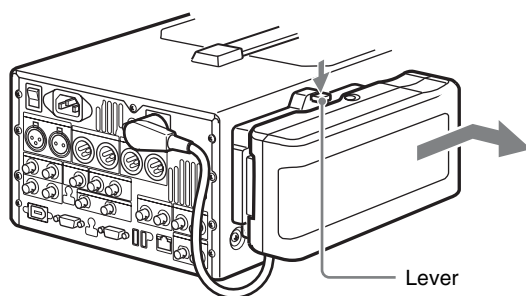

Checking the remaining battery power

You can use the LEDs on the side panel of the battery to check the remaining power of the battery.

Initial Setup

This unit is shipped with the area of use, system frequency, recording format, and current date and time still unset. Therefore, you need to make initial setup settings before using the unit. (You cannot use the unit without setting it up.)

Once the unit has been set up, the settings are retained even when the unit is powered off.

Use the following procedures.

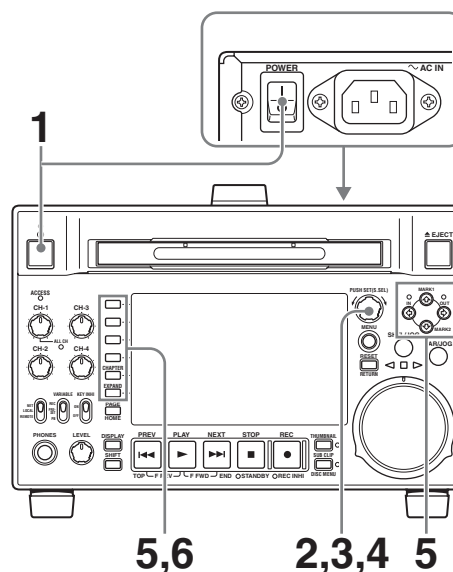

- 1** Power the unit on.

The INITIAL SETUP screen appears on the display.

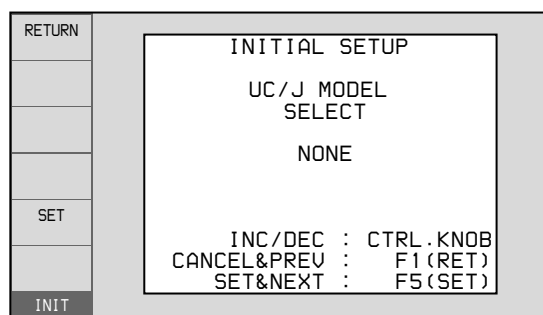

- 2** Turn the PUSH SET(S.SEL) knob to select the area of use.

Display UC (for regions outside Japan) or J (for Japan), and then press the SET function button (F5). The system frequency screen appears.

- 3** Turn the PUSH SET(S.SEL) knob to select the system frequency.

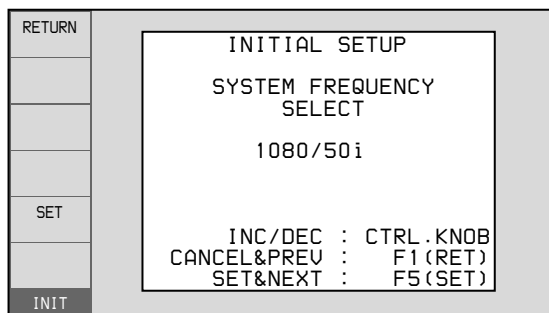

Display the system frequency that you want to use, and then press the SET function button (F5).
The DATE/TIME PRESET screen appears.

- 4** In the DATE/TIME PRESET screen, set the current date and time by setting the following items.

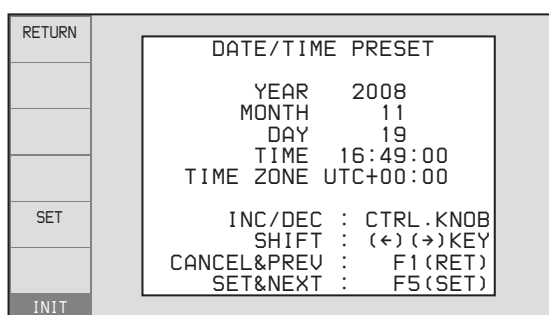

YEAR: Year
MONTH: Month
DAY: Day
TIME: Time
TIME ZONE: Time zone (as a difference in hours with respect to Coordinated Universal Time (UTC))

In the setting screen, you can change the value of the flashing digit.

Press the ◀/IN or ▶/OUT button to make the previous digit or next digit start flashing.

Press the ▲/MARK1 or ▼/MARK2 button (or turn the PUSH SET(S.SEL) knob) to increment or decrement the value of the flashing digit.

When you have finished making settings, press the SET function button (F5).

The date, time, and time zone settings are saved, and the message “NOW SAVING...” appears.

- 5** If you want to save the settings made up to this point, press the SET function button (F5) again.

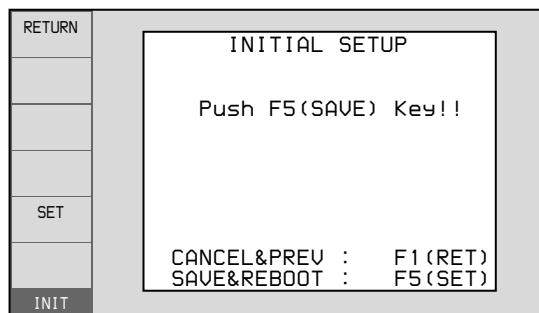

The message “NOW SAVING...” appears again, and the setting screen disappears. Then the unit powers itself off and on again.

To return to the original screen without saving settings

Press the RETURN function button (F1).

Note

The time zone is reset to the factory default when you execute the maintenance menu item M49: RESET ALL SETUP. You will need to set it again. The date and time are not reset.

Front Panel Tilt Mechanism

The front panel of this unit has a tilt mechanism that allows you to pull the front panel out and adjust it to a convenient angle.

To pull the front panel out

Grasp the holds (small protrusions) on both sides of the front panel and pull out as indicated by the arrow.

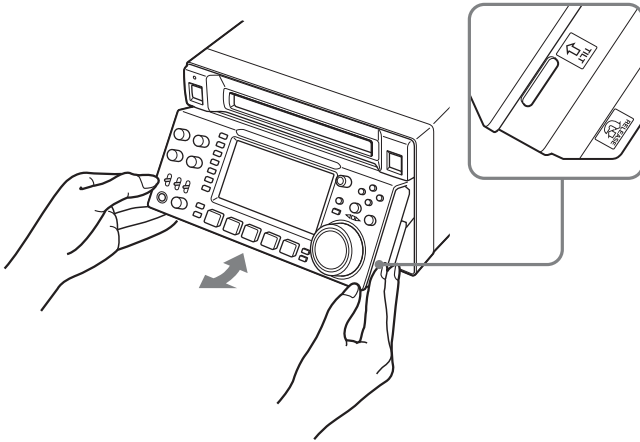

You can fix the angle of the front panel in position 1 (15 degrees) or position 2 (40 degrees).

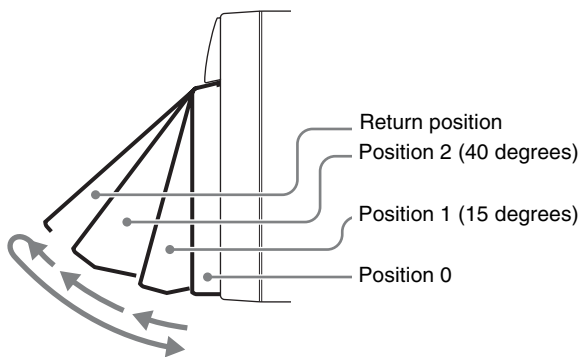

Note

The angle cannot be fixed if you pull the front panel past position 2 all the way out to the return position. To fix the front panel, return it to position 0 and then pull it out to position 1 or position 2.

To return the front panel to its original position

Unlock the front panel by pulling it out to the return position. You can then return it to position 0.

To change the angle of the front panel

To change the angle to position 2 from position 1, pull the front panel out to position 2.

To change the angle to position 1 from position 2, first unlock the front panel by pulling it all the way out to the return position. Then return it to position 0, and pull out again to position 1.

Connections and Settings

Note

Production of some of the peripherals and related devices described in this chapter has been discontinued. For advice about choosing devices, please contact your Sony dealer or a Sony sales representative.

Connections for using PDZ-1 Proxy Browsing Software

You can use the PDZ-1 Proxy Browsing Software on the supplied XDCAM Application Software CD-ROM to carry out simple editing with proxy AV data.

For an overview of PDZ-1 and how to install the software, see “Using PDZ-1 Proxy Browsing Software” on page 170. For information about how to use the software, refer to the Help provided in the software.

Using the (network) connector (FTP connection)

The following shows an example of an FTP (File Transfer Protocol) connection.

Note

To use PDZ-1 requires the PDW-F1600 or PDW-HD1500 IP address and other network-related settings to be made beforehand.

For details of the network-related settings, see “To change network settings” (page 149).

Connecting this unit directly to a laptop computer

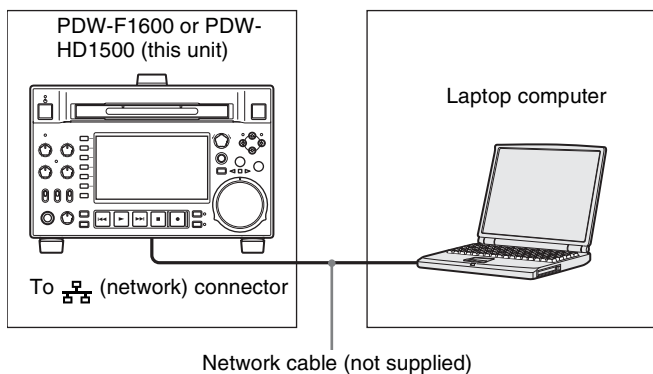

Settings on this unit

Remote control switch: NET (see page 18)

Setup menu item 257 NETWORK ENABLE: net

Connecting three PDW-F1600 or PDW-HD1500 units to a laptop computer via a LAN

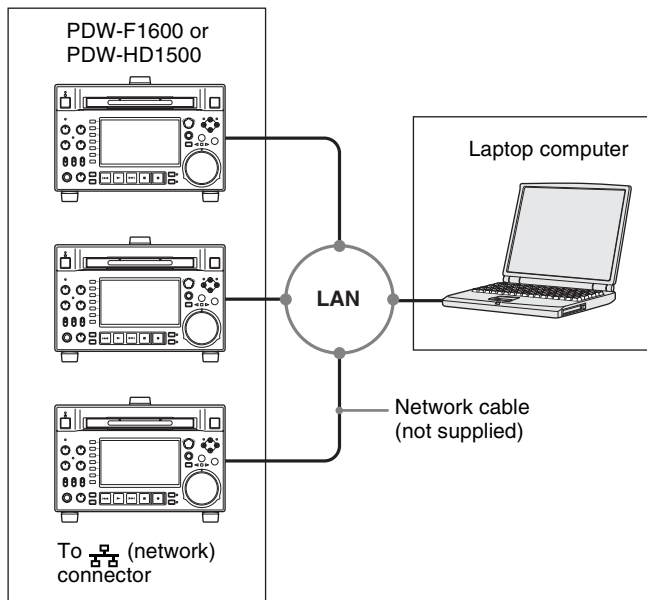

Settings on all PDW-HD1500

Remote control switch: NET (see page 18)

Setup menu item 257 NETWORK ENABLE: net

Using the (i.LINK) S400 connector (FAM connection)

The following shows an example of a FAM (file access mode) connection.

Note

The PDZ-1 Proxy Browsing Software must be installed in advance.

The required FAM driver is also installed when you install the PDZ-1 software.

See “Using PDZ-1 Proxy Browsing Software” (page 170) for more information about installing the PDZ-1 software.

Some limitations apply to FAM connections. For details, see “File Operations in File Access Mode (for Windows)” (page 110).

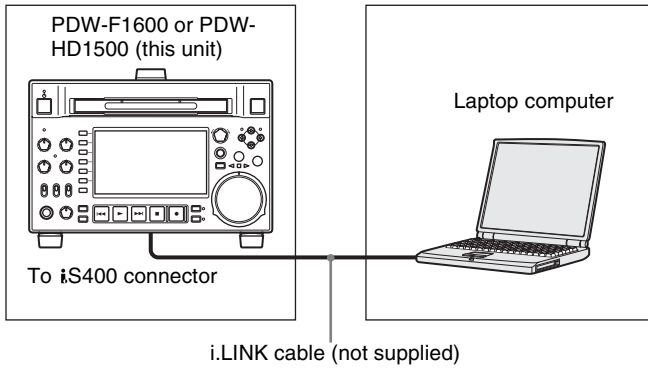

Use of a shielded cable is recommended.

Connections for cut editing

The following figure shows a cut editing system comprising this unit as a player.

When making the connections, also refer to the manuals provided with the equipment to be connected.

See page 39 for more information about editing control unit settings.

When using an editing control unit

Using BVE-700/700A

The following figure shows a cut editing system comprising this unit as a player, an HDW-M2000/M2000P unit as a recorder, and a BVE-700/700A as an editing control unit.

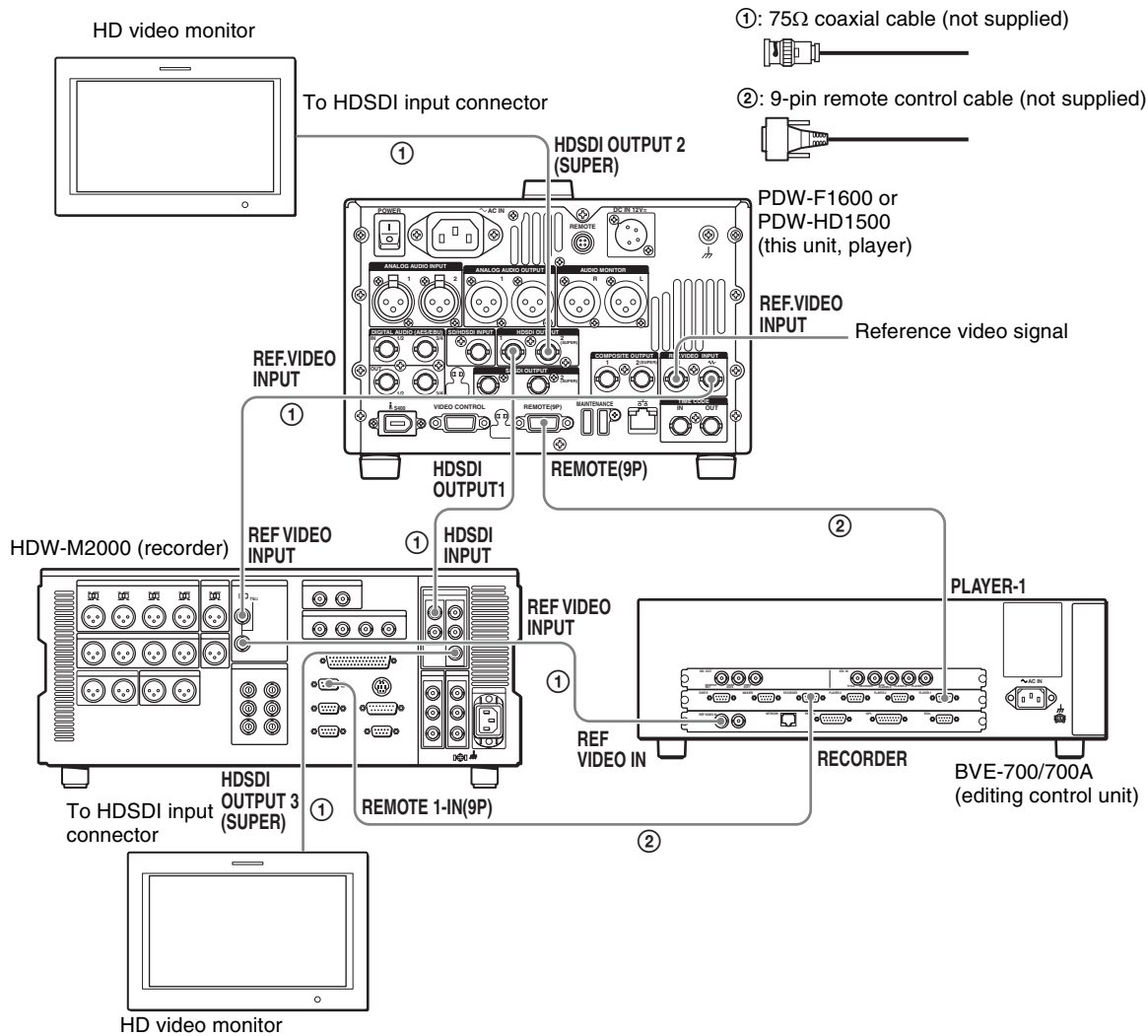

HDW-M2000 (recorder) settings	BVE-700/700A (editing control unit) setting	Settings on this unit
REMOTE 1 (9P) button: Lit	SYNCHRONIZE menu:OFF	Remote control switch: REMOTE (see page 18)
REF.VIDEO INPUT connector 75 Ω termination switch: OFF		Setup menu item 214 REMOTE INTERFACE: 9PIN
Audio selection function switching button INPUT button: HDSOI		
Function menu HOME >F1 (VID. IN): SDI		
Function menu page 1 >F1 (TCG): INT		
Function menu page 1 >F2 (PR/RGN): PRESET		
Function menu page 1 >F3 (RUN): FREE		

Editing Control Unit Settings

When connecting an editing control unit (BVE-700/700A/2000) to use with this unit, set VTR constants as follows.

F1600

System frequency	VTR CONSTANT															
	1	2	3	4	5	6	7	8	9	10	11	12	13	14	15	16
59.94i/ 59.94P/ 29.97P	A0	97	00	96	07 ^{a)}	07 ^{a)}	03	80	0A	07	FE	00	80	5A	FF	5A
50i/50P/25P	A1	97	00	7D	07 ^{a)}	07 ^{a)}	03	80	0A	07	FE	00	80	4C	FF	4B
23.98P	A2	97	00	78	07 ^{a)}	07 ^{a)}	03	80	0A	07	FE	00	80	48	FF	48

a) This is 15 when maintenance menu item M393: AUDIO DSP is set to "AGC/limiter".

HD1500

System frequency	VTR CONSTANT															
	1	2	3	4	5	6	7	8	9	10	11	12	13	14	15	16
59.94i/ 59.94P/ 29.97P	A0	96	00	96	15	15	03	80	0A	07	FE	00	80	5A	FF	5A
50i/50P/25P	A1	96	00	7D	15	15	03	80	0A	07	FE	00	80	4C	FF	4B
23.98P ^{a)}	A2	96	00	78	15	15	03	80	0A	07	FE	00	80	48	FF	48

a) When the PDBK-F1500 option is installed.

Using RM-280

The following figure shows a cut editing system comprising a PDW-HD1500 as a player, a PDW-F1600 unit as a recorder, and an RM-280 as an editing controller.

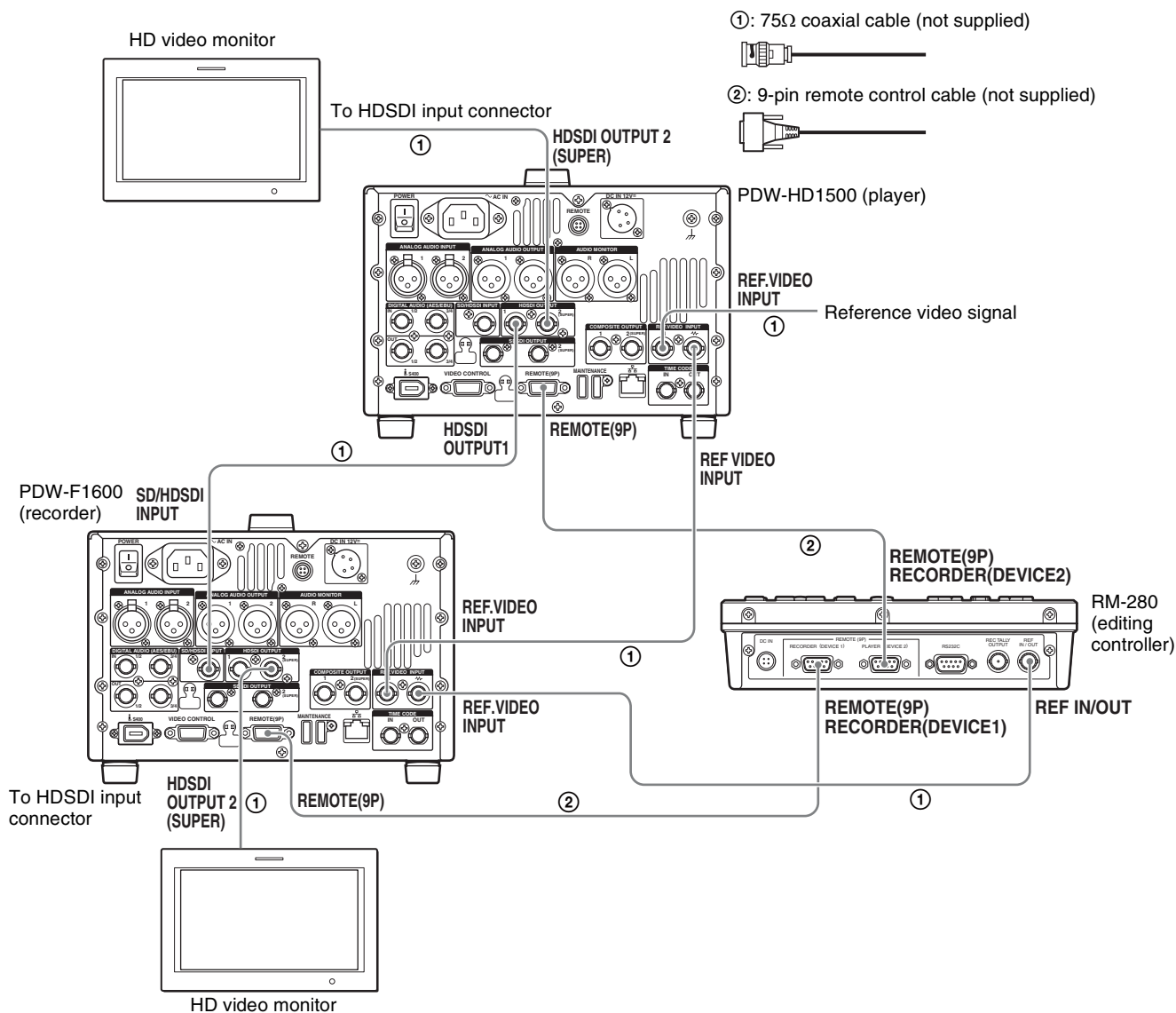

PDW-F1600 (recorder) settings	RM-280 (editing controller) settings	PDW-HD1500 (player) settings
Remote control switch: REMOTE	EDITOR/REMOTE CONTROL selector switch: EDITOR	Remote control switch: REMOTE (see page 18)
Setup menu item 214 REMOTE INTERFACE: 9PIN	Setup menu 01 PREROLL: 5s	Setup menu item 214 REMOTE INTERFACE: 9PIN
Function menu page P1 VIDEO >V INPUT: HD SDI	Setup menu 05 SYNC SEL: ON	
Function menu pages P2 and P3 AUDIO >A1 to A8 INPUT: SDI	Setup menu 06 SYNC VTR: RECORDER	
Function menu page P5 TC >TCG: INT	Setup menu 09 EDIT DLY: -7	
Function menu page P5 TC >PRST/ RGN: PRESET	Setup menu 10 R ST DLY:AUTO	
Function menu page P5 TC >RUN MODE: FREE RUN	Setup menu 11 P ST DLY:AUTO	

Using the editing functions of the recorder (controlling through REMOTE(9P) connector)

The following figure shows a cut editing system comprising this unit as a player, and an HDW-M2000/M2000P unit as a recorder. In this example, video and audio signals are connected by HDSDI, and control signals are transferred via the REMOTE(9P) connector.

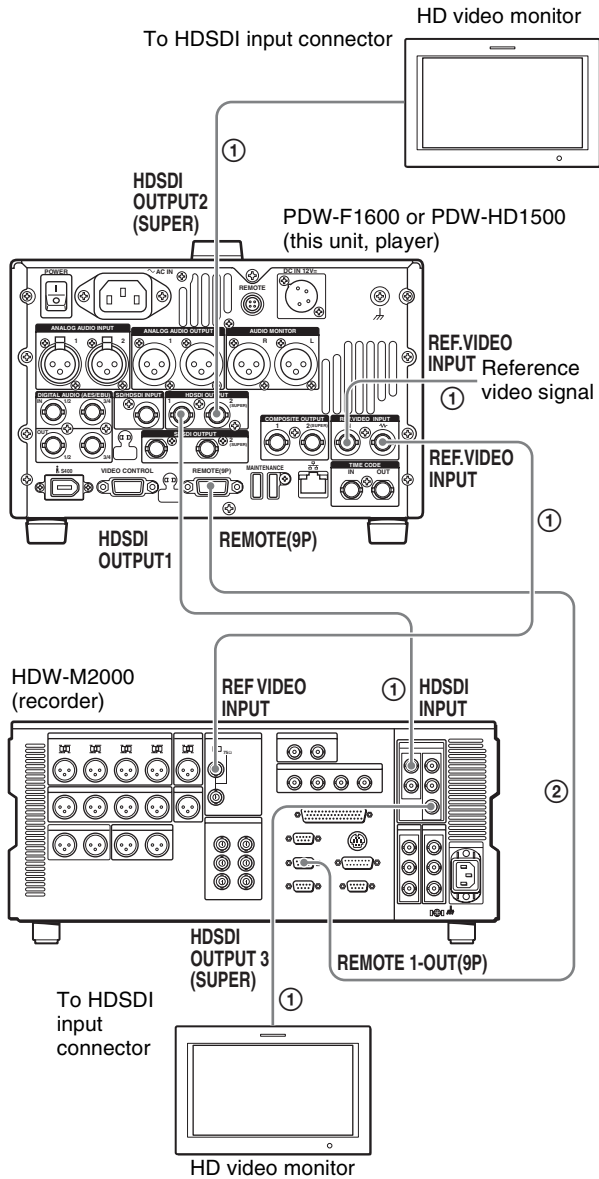

①: 75Ω coaxial cable (not supplied)



②: 9-pin remote control cable (not supplied)



HDW-M2000 (recorder) setting	Settings on this unit
REMOTE 1 (9P) button: Unlit	Remote control switch: REMOTE (see page 18)
	Setup menu item 214 REMOTE INTERFACE: 9PIN

For details of HDW-M2000/M2000P settings, refer to the HDW-M2000/M2000P Operation Manual.

Connections for pool coverage

The following figure shows an example of connections for pool coverage, with the PDW-700 Professional Disc Camcorder connected.

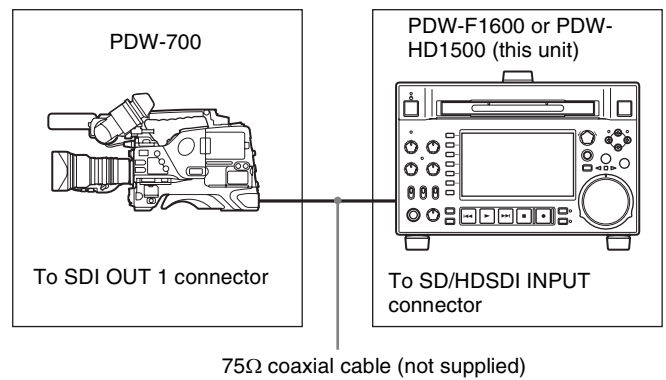

PDW-700 (camcorder) setting	Settings on this unit
HDSDI REMOTE I/F on page CAM CONFIG 1 of the MAINTENANCE menu: other than OFF	Remote control switch: REMOTE (see page 18)
	Setup menu item 214 REMOTE INTERFACE: SDI

Synchronization Reference Signals

The synchronization reference signal generator of this unit synchronizes to a reference signal input to the REF. VIDEO INPUT connector or to a video input signal. External synchronization is as follows, depending on the

setting of OUT REF on page P6 REF of the function menu, and on the type of the selected input signal. Video output signals are always synchronized to the internal synchronization signal.

Input to SD/HDSI INPUT connector ^{a)}	Input to REF. VIDEO INPUT connector	Setting of OUT REF on page P6 REF ^{b)}	
		REF	INPUT
Yes	Yes	Synchronize to the signal input to the REF. VIDEO INPUT connector	Synchronize to the signal input to the SD/HDSI INPUT connector
Yes	No	Synchronize to the signal input to the SD/HDSI INPUT connector	
No	Yes	Synchronize to the signal input to the REF. VIDEO INPUT connector	
No	No	No external synchronization is made	

- a) Same as when V INPUT on page P1 VIDEO of the function menu is set to "SG".
- b) FAM and FTP connections always synchronize to the internal synchronization reference signal, regardless of the setting of OUT REF.

Synchronization reference signals when you are recording, playing, or editing 720P signals

When you are recording, playing, or editing 720P signals, set OUT REF on page P6 REF of the function menu item to "REF", and synchronize the internal reference signal generator of this unit to a reference signal input to the REF. VIDEO INPUT connector. The following reference signals may be used.

720/59.94P system: 1080/59.94i tri-level sync signal, 525 black burst signal

720/50P system: 1080/50i tri-level sync signal, 625 black burst signal

When you connect this unit directly to the video I/O connectors of the PDW-F1600/HD1500/F800/700, you can record and dub 720P signals even if you set OUT REF on page P6 REF of the function menu item to "INPUT".

Setting System Frequency

This unit can record and play back video at the system frequencies of 59.94i, 50i, 29.97P, 25P, and 23.98P¹⁾ (1080) or 59.94P and 50P (720).

1) **[HD1500]** When the PDBK-F1500 option is installed.

Selecting the system frequency

- 1 Set setup menu item 013 SYSTEM FREQUENCY SELECT MENU to “on” and press the PUSH SET(S.SEL) knob.

The system frequency selection screen appears.

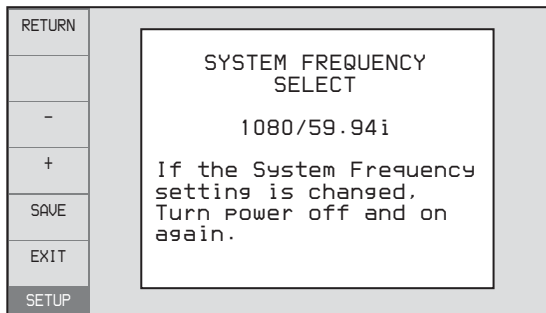

- 2 Turn the PUSH SET(S.SEL) knob to select the system frequency to be used.

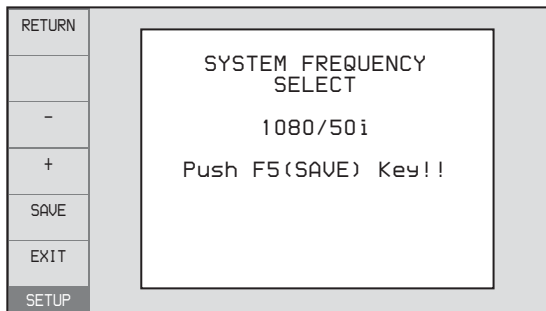

- 3 Press the PUSH SET(S.SEL) knob or the SAVE function button (F5).

The message “Turn off/on POWER!!” appears.

- 4 After pressing the on/standby button to power off the unit, power it on again.

Setting Timecode

There are the following four ways of recording timecode:

Internal Preset mode: This records the output of the internal timecode generator, set beforehand to an initial value. The following run modes can be selected.

- Free Run: Timecode advances continually.
- Rec Run: Timecode advances only during recording.

Internal Regen mode: This records the output of the internal timecode generator, initialized to timecode following continuously upon the timecode of the last frame of the last clip on the disc.

External Regen mode: This records the output of the internal timecode generator, synchronized to an external timecode generator. As the external input, the timecode input to any of the following connectors can be selected.

- TIME CODE IN connector: LTC
- SD/HDSDI INPUT connector: VITC and LTC
- **[i.LINK]** S400 connector: TC

External Preset mode: This directly records the input of an external timecode generator. As the external input, the timecode input to any of the TIME CODE IN connector can be selected.

To record timecode after setting an initial value (Internal Preset)

Proceed as follows with the function menu. For setting the timecode, set TCG on page P5 TC of the function menu to INT and PRST/RGN to PRESET.

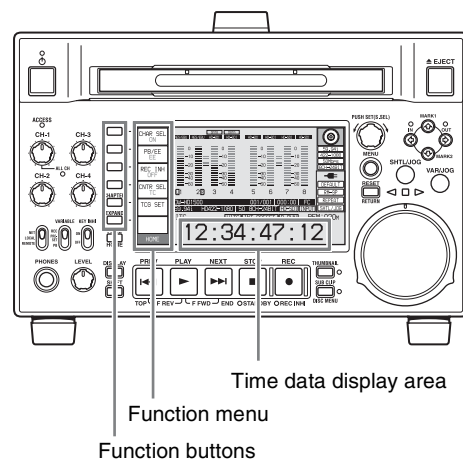

Setting an initial timecode value

- 1 Press the CNTR SEL function button on the HOME page of the function menu, and select TC.

- 2 Press the TCG SET function button (F5).

The first digit of the time data display starts flashing.

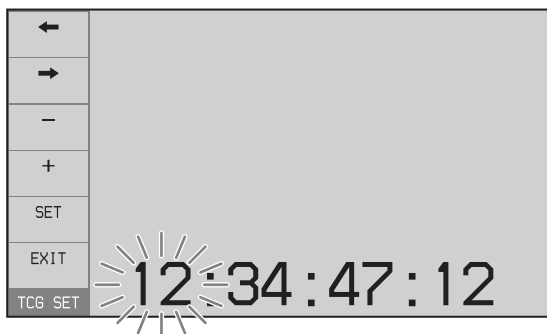

- 3 Press the ← or → function button (F1 or F2) to select a digit to be set.

The selected digit starts flashing.

- 4 Use the PUSH SET(S.SEL) knob or – or + function button (F3 or F4) to set the value for the selected digit.

To set the next-most significant digit (10s place)

Turn the PUSH SET(S.SEL) knob while holding down the SHIFT button.

Repeat steps 3 and 4 to set all digits that should be set.

To set to 00:00:00:00

Press the RESET/RETURN button.

- 5 Press the SET function button (F5).

If RUN MODE on page P5 TC is set to FREE RUN, the timecode starts running.

To cancel a setting

Press the EXIT function button (F6). Any new settings to that point are canceled, and the setting operation is terminated.

Setting the timecode to the current time

- 1 Set RUN MODE on page P5 TC to FREE RUN and DF/NDF to DF (in 59.94i/59.94P/29.97P mode only).
- 2 Perform steps 1 to 4 of “Setting an initial timecode value” to set the timecode to a time slightly ahead of the current time.
- 3 Press the SET function button (F5) at the instant when the current time matches the displayed timecode.

Setting user bits

You can record up to 8 hexadecimal digits of information (date, time, event number, etc.) on the timecode track.

Select UB by pressing the CNTR SEL function button (F4) in step 1 of “Setting an initial timecode value” and carry out steps 2 to 5. Settings are made in hexadecimal (0-9, A-F).

You can record ID codes in user bits.

To record timecode that follows sequentially upon the last recorded timecode (Internal Regen)

You can record timecode so that it is continuous from one clip to the next on the disc.

Set TCG on page P5 TC of the function menu to INT, and PRST/RGN to TC or VITC. When this setting is in force, the unit reads the timecode of the last frame of the last recorded clip on the disc before starting to record, and internally generates timecode that follows upon the recorded timecode.

The frame count mode (for system frequency 59.94i/59.94P/29.97P only) is set to the same mode as the last recorded timecode on the disc (drop-frame or non-drop-frame).

To record with the internal timecode generator synchronized to external timecode (External Regen)

Use this method to synchronize the timecode generators of a number of recorders, to record the playback timecode of external VTRs, or to record while maintaining synchronization between the source video and timecode. Use either of the following procedures according to the type of external timecode.

Synchronizing with timecode input to the TIME CODE IN connector

- 1 Connect the timecode output of an external device to the TIME CODE IN connector, and input a reference video signal to the REF. VIDEO INPUT connector.
- 2 Make the following settings on page P5 TC of the function menu.
 - Set TCG to “EXT”.
 - Set PRST/RGN to “TC”.

Synchronizing with embedded LTC input to the SD/HDSDI INPUT connector

- 1 Input an HDSDI signal containing embedded LTC to the SD/HDSDI INPUT connector, and a reference video signal to the REF. VIDEO INPUT connector.
- 2 Make the following settings on page P5 TC of the function menu.
 - Set TCG to “SDI”.

- Set PRST/RGN to “TC”.

Executing either of these procedures starts the internal timecode generator running in synchronization with the external timecode generator.

Once the internal timecode generator is synchronized with the external timecode generator, the internal timecode generator continues to run even if the external timecode generator connection is removed.

The timecode advance mode is set automatically to Free Run. The frame count mode (for system frequency 59.94i/59.94P/29.97P only) is set to the same mode as the external timecode signal (drop-frame or non-drop-frame).

To check the synchronization to the external signal

Press the STOP button to stop this unit, then press the REC button.

Check that the timecode value shown in the time data display coincides with the external timecode value.

To record external timecode directly (External Preset)

When you use this method, the internal timecode generator advances without being affected by the external timecode.

To directly record timecode input to the TIME CODE IN connector

Input the timecode output of an external device to the TIME CODE IN connector, and make the following settings on page P5 TC of the function menu.

- Set TCG to “EXT”.
- Set PRST/RGN to “PRESET”.

Superimposed Text Information

The video signal output from the COMPOSITE OUTPUT 2 (SUPER) connector, SDDS I OUTPUT 2 (SUPER) connector, or the HDS DI OUTPUT 2 (SUPER) connector contains superimposed text information, including timecode, menu settings, and alarm messages.

Adjusting the text display

You can adjust the position, size and type of the superimposed text using setup menu items 002, 003, 005, 009, 011, and 012.

For details, see “Items in the basic menu” (page 122).

Information displayed

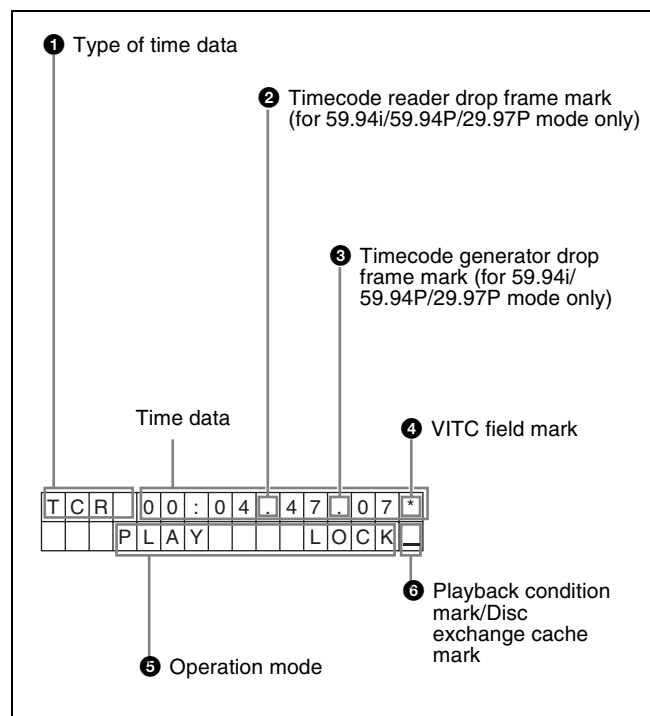

Note

The display shown above corresponds to the factory default settings of the unit. You can change the type of information to be displayed in the lower line of the display by changing the setting of setup menu item 005 DISPLAY INFORMATION SELECT.

For details, see “Items in the basic menu” (page 122).

1 Type of time data

Display	Meaning
CNT	Counter data
TCR	TC reader timecode
UBR	TC reader user bits data
TCR.	VITC reader timecode
UBR.	VITC reader user bits data
TCG	TC generator timecode
UBG	TC generator user bits data
IN	In point time data
OUT	Out point time data
DUR	Duration between In point and Out point

Note

If the time data or user bits data cannot be read correctly, they will be displayed with an asterisk. For example, “T*R”, “U*R”, “T*R.” or “U*R.”.

2 Timecode reader drop-frame mark (for 59.94i/59.94P/29.97P mode only)

“.”: Indicates drop-frame mode.

“:”: Indicates non-drop-frame mode.

3 Timecode generator drop-frame mark (for 59.94i/59.94P/29.97P mode only)

“.”: Indicates drop-frame mode (factory default setting).

“:”: Indicates non-drop-frame mode.

4 VITC field mark

“ ” (blank): Fields 1 and 3 (for 59.94i/59.94P/29.97P/23.98P mode) or fields 1, 3, 5 and 7 (for 50i/50P/25P mode)

“*”: Fields 2 and 4 (for 59.94i/59.94P/29.97P/23.98P mode) or fields 2, 4, 6 and 8 (for 50i/50P/25P mode)

5 Operation mode

The field is divided into two blocks as shown below.

- Block A displays the operation mode.
- Block B displays the servo lock status or playback speed.

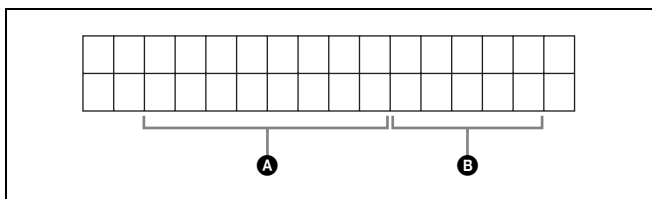

Display		Operation mode
Block A	Block B	
DISC OUT		Disc is not loaded.
LOADING		Disc is being loaded.
UNLOADING		Disc is being unloaded.
STANDBY OFF		Standby off mode

Display		Operation mode
Block A	Block B	
C.STANDBY OFF		Standby off mode ^{a)}
STOP		Stop mode
C.STOP		Stop mode ^{a)}
NEXT xxx		Cuing up to the first frame of the next clip.
PREV xxx		Cuing up to the first frame of the current clip.
F.FWD		Fast forward search
F.REV		Fast reverse search
PLAY		Playback mode (servo unlocked)
PLAY	LOCK	Playback mode (servo locked)
REC		Record mode (servo unlocked)
C.REC		Record mode (servo unlocked) ^{a)}
REC	LOCK	Record mode (servo locked)
C.REC	LOCK	Record mode (servo locked) ^{a)}
JOG	STILL	A still picture in jog mode
JOG	FWD	Jog mode in forward direction
JOG	REV	Jog mode in reverse direction
SHUTTLE	STILL	A still picture in shuttle mode
SHUTTLE	(Speed)	Shuttle mode
VAR	STILL	A still picture in variable mode
VAR	(Speed)	Variable speed mode
TOP 0001/xxxx		Cuing up to the first frame of the first clip.
END xxxx/xxxx		Cuing up to the last frame of the last clip.
PREROLL		Cuing up during thumbnail search

a) Display when the unit is in Clip Continuous Rec mode.

6 Playback condition mark/Disc exchange cache mark

One of three channel condition marks is displayed when the ACCESS indicator is lit during any mode except recording. The indication “C” appears here when the disc exchange cache function is operating.

Display	Name	Description
—	Green condition	There is no problem with the playback condition. This unit and the disc can be used just as they are. This corresponds to the “green” channel condition indicator of a VTR.
=	Yellow condition	The playback condition has deteriorated to some degree. There are no read errors, but you should take the action described in the next section. This corresponds to the “yellow” channel condition indicator of a VTR.

Display	Name	Description
≡	Red condition	The playback condition has deteriorated. There are no read errors, ^{a)} but you should take the action described in the next section. This corresponds to the "red" channel condition indicator of a VTR.
C	Disc exchange cache	This appears during cache recording. <i>For details, see page 56.</i>

a) Read errors will occur if the playback condition continues to deteriorate. If a read error occurs, a "Disc Error!" alarm appears in the time data display, the picture freezes, and audio is muted.

To display playback condition marks, set setup menu item 012 CONDITION DISPLAY ON VIDEO MONITOR to "ena", and set setup menu item 005 DISPLAY INFORMATION SELECT to "T&sta".

For details about operation, see "Basic menu operations" (page 126).

Playback condition displays

You can be alerted in advance to deteriorating playback conditions and to error correction rates which are approaching their limits.

Deteriorating playback may be due to the following causes.

- Scratches and dust on the disc surface
This includes fingerprints, dust from the air, tar from cigarette smoke, and so on.
Scratches and soiling which occur before recording are not a problem because they are registered in advance as defects, and recording avoids them. However, scratches and soiling which occur after recording can lead to deteriorating playback conditions.
- Aging of disc recording layers
Over several decades, the recording layers of optical discs can age and cause deteriorating playback conditions.
You can use this function to check archival discs and other discs which have been stored for extended periods, so that you can take action before the deterioration progresses further.
- Deteriorating laser diodes performance
The performance of the laser diodes used in optical heads can worsen with age, leading to deteriorating playback conditions.

For details, see "Digital hours meter" (page 155) about this setting.

Refer to the Maintenance Manual for an approximate guide to when it is time to replace optical heads.

To prevent playback conditions from deteriorating

Pay attention to the following points when handling discs.

- Do not open disc cartridges and touch discs directly with your hands.
- Do not store for long periods in locations which are dusty or exposed to air circulated by fans.
- Do not store for long periods under high temperatures or in locations exposed to direct sunlight.

If playback conditions have deteriorated

If a yellow or red playback condition mark appears, check the following points.

Whether the disc displays the same playback condition on other XDCAM devices: If so, the surface of the disc may be dirty or scratched, or the performance of the recording layers on the disc may have worsened due to age. Do not use discs with these symptoms.

Whether every disc inserted into an XDCAM device displays the same playback conditions: If so, the performance of the laser diodes may have deteriorated. Check the total optical output time.

Basic Operations of the Function Menu

The function menu provides access to frequently used settings, such as input video signal selection and timecode settings.

Menu settings are stored in nonvolatile memory and are preserved even after the unit is powered off.

Function menu operations

The function menu appears on the color LCD of this unit. The following figure shows the buttons (numbered 1 to 6 beginning at the top) used in function menu operations.

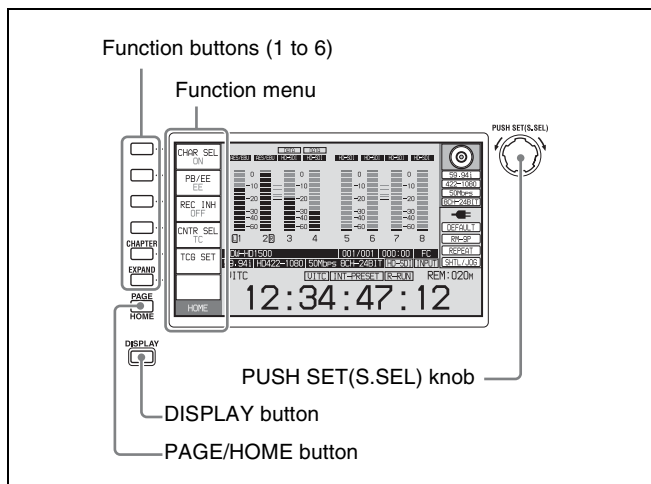

To display the function menu

The function menu is made up of the HOME page and pages P1 to P7, (P8)¹⁾, (HOME2)¹⁾.

If the function menu is not already visible, press the PAGE/HOME button to display it. (The most recently accessed function menu page appears.)

1) If a menu item is assigned using maintenance menu item M38: F-KEY CONFIG

To display a different page

Each press of the PAGE/HOME button displays the next function menu page in the order: HOME → P1 → P2 → P3 → P4 → P5 → P6 → P7 → (P8)¹⁾ → (HOME2)¹⁾ → HOME...

1) If a menu item is assigned using maintenance menu item M38: F-KEY CONFIG

- Turning the PUSH SET(S.SEL) knob while holding down the PAGE/HOME button changes the page forward or backward.
- Pressing F1 to F6 buttons while holding down the PAGE/HOME button switches the page directly to pages P1 to P6. Pressing the F1 button again while the page P1 is displayed switches the page to P7. Pressing the F2

button again while the page P2 is displayed switches the page to P8.

To clear the function menu from the screen

Press the DISPLAY button to switch to the video monitor display.

To change the setting of a function menu item

Use the function buttons.

To select the value of the setting item

Press the button to the left of each setting item to change the value of the item. Keep pressing the button until the value you want appears.

To set the value of the setting item

- Press the button to the left of each setting item so that the setting value flashes to enable adjustment of the value and then turn the PUSH SET(S.SEL) knob to increase or decrease the value.
- Turning the PUSH SET(S.SEL) knob while holding down the SHIFT button increases the increment of adjustment.
- Pressing the button to the left of each setting item while the setting value is flashing causes the value to stop flashing and completes the adjustment.

Function menu settings

The following tables list the setting items on each page and describe their setting values. Underlined values are the factory defaults.

HOME page

Item	Setting
F1: CHAR SEL	Turns the display of character information on the color LCD and on an external monitor on and off. ON : Character information on OFF : Character information off LCD : Character information on for the color LCD only
F2: PB/EE	Selects the type of video and audio signals to output during fast forward, fast reverse, stop, and standby. PB : Playback signal EE : E-E signal
F3: REC INH	Specifies whether to inhibit recording to the disc. OFF : Do not inhibit recording. ON : Inhibit recording to the disc.

Item	Setting
F4: CNTR SEL	Selects the type of time data to display in the time data display area. TC: Timecode COUNTER: Elapsed recording or playback time UB: User bits
F5: TCG SET	<ul style="list-style-type: none"> When CNTR SEL is set to "TC", displays a screen where you can set the initial value of the timecode generated by the internal timecode generator ^{a)} (see page 43). When CNTR SEL is set to "UB", displays a screen where you can set timecode user bits ^{a)} (see page 44).
F6:	(Unassigned function button)

a) This is displayed only when TCG on page P5 TC of the function menu is set to "INT", and PRST/RGN is set to "PRESET".

P1 VIDEO page

Item	Setting
F1: V INPUT	Selects the video input signal. HDSDI: HDSDI signal SDDSI: SDDSI signal i.LINK: i.LINK signal (when the PDBK-201 option board is installed) SG: Test signal from internal signal generator (Normally this item is not displayed. It appears when you hold the button down for 3 seconds.)
F2: VID. PROC	Selects the method used to control the internal video signal processor and make related settings. LOCAL: Use the function menu to change settings. MENU: Use the setup menu to change settings.
F3: VIDEO	Sets the output level for HD/SD video signals (range $-\infty$ to +3 dB). PRESET: Set the video signal output level to a preset value, regardless of manual setting. Manual setting: While the setting value is flashing, turn the PUSH SET(S.SEL) knob to adjust the video signal output level.
F4: CHROMA	Sets the output level for HD/SD chroma signals (range $-\infty$ to +3 dB). PRESET: Set the chroma signal output level to a preset value, regardless of manual setting. Manual setting: While the setting value is flashing, turn the PUSH SET(S.SEL) knob to adjust the chroma SETUP signal output level.

Item	Setting
F5: HUE/CHRM PHS	Sets the hue (chroma phase). PRESET: Set the hue (chroma phase) to a preset value, regardless of manual setting. Manual setting: While the setting value is flashing, turn the PUSH SET(S.SEL) knob to adjust the hue (chroma phase) over the range $\pm 30^\circ$.
F6: SETUP/BLACK	Sets the HD/SD output black setup level or black level. PRESET: Set the level to the preset value, regardless of the manual setting. Manual setting: While the setting value is flashing, turn the PUSH SET(S.SEL) knob to set the black setup level (in 59.94i/59.94P/29.97P/23.98P mode) over the range ± 30 IRE or the black level (in 50i/50P/25P mode) over the range ± 210 mV.

P2 AUDIO page

Item	Setting
F1: A1 INPUT	Selects the audio input signal to assign to audio channel 1. SDI: Audio signal embedded into SDI signal ANALOG1: Analog 1 audio signal AES/EBU1: Signal input to the DIGITAL AUDIO(AES/EBU) IN 1/2 connectors SG: Test signal from internal signal generator (Normally this item is not displayed. It appears when you hold the button down for 3 seconds. The test signal is assigned to audio channels 1 to 8 simultaneously.) Press one of the function buttons corresponding to A1 INPUT to A8 INPUT again to stop output of the test signal. i.LINK: i.LINK signal (when the PDBK-201 option board is installed)
F2: A2 INPUT	Selects the audio input signal to assign to audio channel 2. SDI: Audio signal embedded into SDI signal ANALOG2: Analog 2 audio signal AES/EBU2: Signal input to the DIGITAL AUDIO(AES/EBU) IN 1/2 connectors
F3: MONITR L	Selects the channel to monitor as the left monitor channel. CH1, CH2, CH3, CH4, CH5, CH6, CH7, CH8 CH1/2, CH3/4, CH5/6, CH7/8 (MIX)
F4: MONITR R	Selects the channel to monitor as the right monitor channel. CH1, CH2, CH3, CH4, CH5, CH6, CH7, CH8 CH1/2, CH3/4, CH5/6, CH7/8 (MIX)

Item	Setting
F5: SPEAKER	Enables or disables output from this unit's speaker. OFF: Do not output ON: Output
F6: LEVEL MT	Specifies the position at which to superimpose audio level meters in the video monitor screen (in full-screen display mode). OFF: Do not superimpose. LEFT: Superimpose the audio level meters of 2 channels on the left side. RIGHT: Superimpose the audio level meters of 2 channels on the right side. LEFT(4): Superimpose the audio level meters of 4 channels on the left side. RIGHT(4): Superimpose the audio level meters of 4 channels on the right side. LEFT(8): Superimpose the audio level meters of 8 channels on the left side. RIGHT(8): Superimpose the audio level meters of 8 channels on the right side.

P3 AUDIO page

Item	Setting
F1: A3 INPUT	Selects the audio input signal to assign to audio channel 3. SDI: Audio signal embedded into SDI signal ANALOG1: Analog 1 audio signal AES/EBU3: Signal input to the DIGITAL AUDIO(AES/EBU) IN 3/4 connectors
F2: A4 INPUT	Selects the audio input signal to assign to audio channel 4. SDI: Audio signal embedded into SDI signal ANALOG2: Analog 2 audio signal AES/EBU4: Signal input to the DIGITAL AUDIO(AES/EBU) IN 3/4 connectors
F3: A5 INPUT	Selects the audio input signal to assign to audio channel 5. SDI: Audio signal embedded into SDI signal ANALOG1: Analog 1 audio signal AES/EBU1: Signal input to the DIGITAL AUDIO(AES/EBU) IN 1/2 connectors
F4: A6 INPUT	Selects the audio input signal to assign to audio channel 6. SDI: Audio signal embedded into SDI signal ANALOG2: Analog 2 audio signal AES/EBU2: Signal input to the DIGITAL AUDIO(AES/EBU) IN 1/2 connectors
F5: A7 INPUT	Selects the audio input signal to assign to audio channel 7. SDI: Audio signal embedded into SDI signal ANALOG1: Analog 1 audio signal AES/EBU3: Signal input to the DIGITAL AUDIO(AES/EBU) IN 3/4 connectors

Item	Setting
F6: A8 INPUT	Selects the audio input signal to assign to audio channel 8. SDI: Audio signal embedded into SDI signal ANALOG2: Analog 2 audio signal AES/EBU4: Signal input to the DIGITAL AUDIO(AES/EBU) IN 3/4 connectors

P4 AUDIO page

Item	Setting
F1: A5 VOL	Sets the volume of audio channel 5. ^{a)} The volume can be adjusted within the range from -200 to +200 (-∞ to +12 dB) by turning the PUSH SET(S.SEL) knob.
F2: A6 VOL	Sets the volume of audio channel 6. ^{a)} The volume can be adjusted within the range from -200 to +200 (-∞ to +12 dB) by turning the PUSH SET(S.SEL) knob.
F3: A7 VOL	Sets the volume of audio channel 7. ^{a)} The volume can be adjusted within the range from -200 to +200 (-∞ to +12 dB) by turning the PUSH SET(S.SEL) knob.
F4: A8 VOL	Sets the volume of audio channel 8. ^{a)} The volume can be adjusted within the range from -200 to +200 (-∞ to +12 dB) by turning the PUSH SET(S.SEL) knob.
[F1600] F5: MIX/SWAP	Specifies whether to perform audio mixing according to the settings of setup menu item 819 AUDIO INPUT ARRANGE. OFF: Do not perform audio mixing. ON: Perform audio mixing.
[HD1500] F5:	(Unassigned function button)
F6: AU METER	Selects the display mode of the audio level meters. FULL: Display the range from -60 dB to 0 dB. FINE: Display a magnified section with 0.25 dB step marks.

a) To enable this setting, the following settings are also required, in the same way as for volume operations for channels 1 to 4.

- Set the VARIABLE switch of the front panel to "REC" or "PB".
- Set setup menu item 131 AUDIO VOLUME to "EACH".

P5 TC page

Item	Setting
F1: TCG	<p>Selects the timecode signal to which the internal timecode generator synchronizes.</p> <p>INT: Follow the initial value set from the control panel or remotely from the device connected to the REMOTE(9P) connector, or synchronize to timecode played back from the disc.</p> <p>EXT: Synchronize to external timecode input to the TIME CODE IN connector.</p> <p>SDI: Synchronize to timecode embedded into HDSDI signal input to SD/HDSDI INPUT connector.</p> <p>Note If you select “EXT” or “SDI” while i.LINK TS signals are being input, synchronizes to the timecode data in the TS signals.</p>
F2: PRST/RGN	<p>Selects the following for the internal timecode generator.</p> <p>PRESET: Presets an initial value for the timecode generated by the internal timecode generator, as specified from the control panel or remotely from the device connected to the REMOTE(9P) connector. This is valid when “INT” is selected with the F1: TCG item on this page. The operation is the same as “TC” when anything else is selected.</p> <p>TC: Generate timecode synchronized to timecode read by the internal timecode reader.</p> <p>VITC: Generate timecode synchronized to VITC read by the internal timecode reader.</p>
F3: RUN MODE	<p>Selects the timecode run mode.</p> <p>FREE RUN: Timecode advances as long as the unit is powered on, regardless of the unit’s operating state.</p> <p>REC RUN: Timecode advances only during recording. When you select this item, also set F1: TCG on this page to “INT” and set F2: PRST/RGN to “PRESET”.</p>
F4: DF/NDF	<p>Selects the drop-frame mode for the internal timecode generator and the counter in 59.94i/59.94P/29.97P mode.</p> <p>DF: Drop-frame mode</p> <p>NDF: Non-drop-frame mode</p>
F5: PDPSET	<p>When the system frequency is set to 1080/59.94i, 1080/29.97P, or 720/59.94P, presets the timecode of the A frame of the pulldown sequence.</p> <p>24F TC: Reference timecode for A frame</p> <p>30F TC: Timecode after pulldown conversion from 24-frame timecode</p>
F6: TCR	<p>Selects the type of timecode to display in the time data display area.</p> <p>TC: Display TC.</p> <p>VITC: Display VITC.</p>

P6 REF page

Item	Setting
F1: OUT REF	<p>Selects the reference signal for the output signals of this unit.</p> <p>REF: Use the signal input to the REF.VIDEO INPUT connector as the output reference signal.</p> <p>INPUT: Use the input video signal as the output reference signal.</p>
F2:	(Unassigned function button)
F3:	(Unassigned function button)
F4:	(Unassigned function button)
F5: SYNC	<p>Sets the sync phase of HD output signals. While the setting value is flashing, turn the PUSH SET(S.SEL) knob to adjust the sync phase of output signals with respect to the input reference signal, over the range $\pm 15 \mu\text{s}$. (The display shows -128 to $+127$.)</p>
F6: FINE	<p>Makes fine adjustment to the sync phase of HD output signals. While the setting value is flashing, turn the PUSH SET(S.SEL) knob to adjust the sync phase of output signals with respect to the input reference signal, over the range $\pm 200 \text{ ns}$. (The display shows 0 to 1023.)</p>

P7 OTHER page

Item	Setting														
F1: CONV IMP	<p>Selects whether to display convert status on the display during convert operations.</p> <p>OFF: Do not display.</p> <p>ON: Display.</p>														
F2: ERR LOG	Displays an error log screen.														
F3: CLIP FLG	<p>Sets a clip flag for the clip being recorded or played back using the function button.</p> <p>If a clip flag is already set for the clip, “Marked” is displayed in the function menu item corresponding to one of the F1 to F3 buttons depending on the type of flag that has been set.</p> <p><i>A clip flag can also be set or deleted using the GUI screen. See page 82 for details.</i></p> <table border="1"> <thead> <tr> <th>Sub-Item</th> <th></th> </tr> </thead> <tbody> <tr> <td>F1: OK</td> <td>Set an OK flag.</td> </tr> <tr> <td>F2: NG</td> <td>Set an NG flag.</td> </tr> <tr> <td>F3: KEEP</td> <td>Set a KEEP flag.</td> </tr> <tr> <td>F4:</td> <td>–</td> </tr> <tr> <td>F5: DELETE</td> <td>Delete the clip flag.</td> </tr> <tr> <td>F6: EXIT</td> <td>Exit the clip flag sub-menu.</td> </tr> </tbody> </table>	Sub-Item		F1: OK	Set an OK flag.	F2: NG	Set an NG flag.	F3: KEEP	Set a KEEP flag.	F4:	–	F5: DELETE	Delete the clip flag.	F6: EXIT	Exit the clip flag sub-menu.
Sub-Item															
F1: OK	Set an OK flag.														
F2: NG	Set an NG flag.														
F3: KEEP	Set a KEEP flag.														
F4:	–														
F5: DELETE	Delete the clip flag.														
F6: EXIT	Exit the clip flag sub-menu.														

Item	Setting
F4: PC RMT	<p>Enables or disables a FAM connection. The connection can be cut off while it is maintained or remade while it is disabled.</p> <p>ENABLE: Enable a connection. DISABLE: Disable a connection.</p> <p>Notes</p> <ul style="list-style-type: none"> • PC REMOTE under maintenance menu item M33: FILE I/F CONFIG must be set to "F-KEY SELECT" in order to use this function (see page 144). • "DISABLE" is always selected when the unit is powered off and then on again, regardless of the previous setting.
F5:	(Unassigned function button)
F6:	(Unassigned function button)

Handling Discs

Discs used for recording and playback

This unit can record and play back the following Professional Disc ¹⁾ formats.

- PFD23A (capacity 23.3 GB)
- PFD50DLA (capacity 50.0 GB)

1) Professional Disc is a trademark of Sony Corporation.

Notes

- It is not possible to use the following discs for recording or playback:
 - Blu-ray Disc
 - Professional Disc for Data
- PFD50DLA discs can be used only by XDCAM devices with the DL mark (see the following illustration). They cannot be used by XDCAM devices without this mark.



Notes on handling

Handling

The Professional Disc is housed in a cartridge, and is designed to allow handling free of risk from dust or fingerprints. However, if the cartridge is subjected to a severe shock, for example by dropping it, this can result in damage or scratching of the disc. If the disc is scratched, it may be impossible to record video/audio, or to play back the content recorded on the disc. The discs should be handled and stored carefully.

- Do not touch the surface of the disc itself within the cartridge.
- Deliberately opening the shutter may cause damage.
- Do not disassemble the cartridge.
- The supplied adhesive labels are recommended for indexing discs. Apply the label in the correct position.

Storage

- Do not store discs where they may be subjected to direct sunlight, or in other places where the temperature or humidity is high.
- Do not leave cartridges where dust may get inside.
- Store cartridges in their cases.

Care of the discs

- Remove dust and dirt on the outside of a cartridge using a soft dry cloth.

- If condensation forms, allow ample time to dry before use.

MODE KEY ENABLE DURING RECORDING to “stop”.

Write-protecting discs

To protect the content recorded on the disc from accidental erasure, move the Write Inhibit tab on the lower surface of the disc in the direction of the arrow, as shown in the following figure.

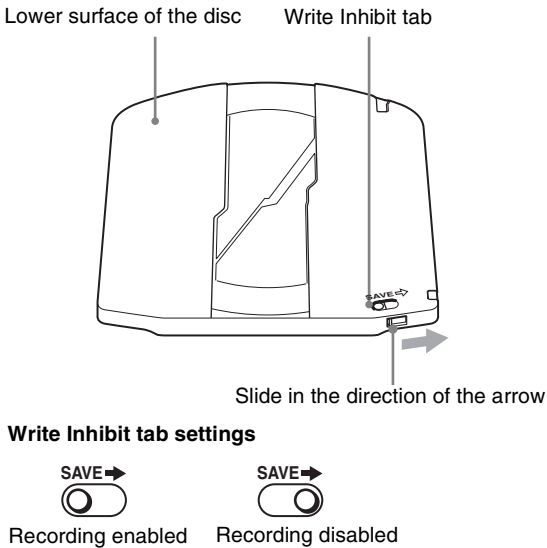

You can also write protect individual clips. For details, see “Locking (write-protecting) clips” (page 83).

Loading and unloading a disc

When the on/standby button and indicator are lit green, you can load and unload a disc as shown in the following figure.

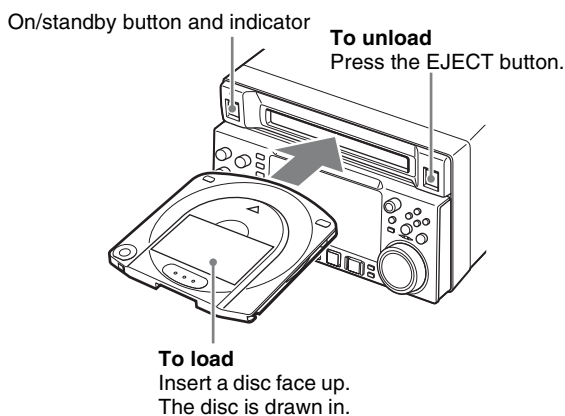

When the EJECT button is pressed during recording, recording stops and the disc is ejected. If you do not want to eject the disc and stop recording when the EJECT button is pressed during recording, set setup menu item 145

Formatting a disc

Unused discs are formatted automatically when they are loaded into this unit.

To format a recorded disc, use the GUI screen.

For details, see “Formatting discs” (page 94).

Recording

This section describes video and audio recording on the unit.

See page 48 “Basic Operations of the Function Menu” in Chapter 3 for more information.

See page 121 “Menus” in Chapter 7 for more information about setup menu operations.

Mixed recording of clips in different formats on the same disc

As long as the frame frequency group is the same, clips in different recording formats can be recorded or written to the same disc.¹⁾

In this manual, this is referred to as “mixed format recording mode”.

1) The recording format is regarded as different whenever the system frequency, video resolution, video codec/bit rate, or number of audio channels or number of bits does not match.

Notes

- Regardless of frame frequency group matching, it is not possible to mix clips with different video resolutions (number of system lines) in the same clip list.
- When the unit is in a mode that calls for playback across clips that were recorded in different recording formats, video and audio playback may stop at the point where the format changes from one format into another, and then start again.
- If a transition point between two clips with different recording formats exists in the preroll segment, that segment cannot be edited.

Frame frequency groups

The system frequencies supported by this unit are divided into frame frequency groups, as shown in the following table.

Frame frequency group	System frequency
59.94 Hz	59.94P
	59.94i
	29.97P
50 Hz	50P
	50i
	25P
23.98 Hz	23.98P

You can record clips with different recording formats, for example HD422 and HD420SP clips, by putting this unit into mixed format recording mode.

To enable mixed format recording mode

Set maintenance menu item M390: MIXED REC to “ENABLE” (see page 145).

If you want to disable mixing of clips with different recording formats, leave this item set to “DSABL”. However, regardless of the mixed format recording mode setting, it is always possible to mix clips in the following format groups.

- HD420 HQ, SP, and LP
- 1080/59.94i and 1080/29.97P
- 1080/50i and 1080/25P

Preparations for recording

Make the following settings and adjustments before starting to record.

Video input signal selection: Select with V INPUT on page P1 VIDEO of the function menu.

Audio input signal selection: Select with A1 INPUT and A2 INPUT on page P2 AUDIO, from A3 INPUT to A8 INPUT on page P3 AUDIO of the function menu.

Timecode and user bits settings: See “Setting Timecode” (page 43).

Selection of time data to display: Select with CNTR SEL on HOME page of the function menu.

Selection of audio channels to monitor: Select with MONITR R and MONITR L on page P2 AUDIO of the function menu.

Volume adjustment of the monitor audio: Adjust with the LEVEL knob.

Remote/local setting: Set the remote control switch. If you set it to REMOTE, also set setup menu item 214 REMOTE INTERFACE (“RM-” and the connector used appear on the system information of the display) (see page 131).

SD up convert function

You can input SD signals to the SD/HDSDI INPUT connector and record them as HD signals.

User data recording

You can record user data (files other than XDCAM AV files) on Professional Discs as PC data via the i.LINK or FTP interface.

This allows Professional Discs to be used as data recording media, with a data storage capacity of 46.4 GB (when dual-layer PFD50DLA discs are used).

Carrying out recording

One recording segment (from the start to the end of recording) is called a “clip”.

See “Clips” (page 85) for more information about clips.

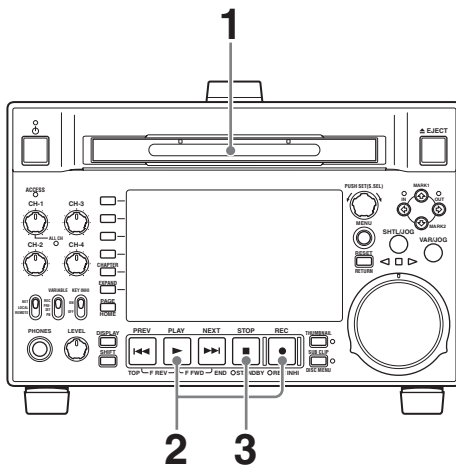

1 Insert a disc.

2 Hold down the REC button, and press the PLAY button.

Recording starts.

3 To stop recording, press the STOP button.

If the disc becomes full

Recording stops and the message “ALARM DISC END.” appears on the monitor.

Notes

- The shortest clip that can be recorded is 2 seconds long. Even if recording start and stop operations are performed within 2 seconds, a 2-second clip is recorded.
- The maximum number of clips that can be recorded is 300. If the loaded disc already contains 300 clips, recording operation is not possible. (The message “MAX # Clips” appears in the time data display area.)
- This unit can record video input signals that are not synchronized to a reference signal. However, in that case, video breakup and audio noise may occur in E-E playback.
- During recording, do not turn off the POWER switch on the rear panel or disconnect the power cord. This could cause the clip being recorded to be lost.

For details, see “Handling of discs when recording does not end normally (salvage functions)” (page 58).

To adjust the audio recording levels

When carrying out audio recording at a reference level

Set the VARIABLE switch to PRESET.

The audio signals will be recorded at a preset reference level.

You can change the reference level and the input levels with maintenance menu item M37: AUDIO CONFIG.

See page 148 for more information about how to make maintenance menu settings.

Manually adjusting the audio recording levels

Set the VARIABLE switch to REC and adjust the CH-1/ ALL CH and CH-2 to CH-4 knobs so that the audio level indications on the audio level meters do not exceed 0 dB for a maximum volume. Carry out the adjustment in E-E mode.

See setup menu item 108 AUTO EE SELECT (page 129) for more information about the signal output settings in E-E mode.

To set shot marks

A Shot Mark1 essence mark or Shot Mark2 essence mark is set if you hold down the \blacktriangle /MARK1 or \blacktriangledown /MARK2 button and press the PUSH SET(S.SEL) knob during recording. If you connect a Windows USB keyboard to the

MAINTENANCE connector, you can record shot marks from Shot Mark0 up to Shot Mark9 by pressing the 0 to 9 keys on the numeric keypad.

If the unit is set up to display superimposed text information (see page 45), “SHOTMARK*” (*: 0 to 9) appears every time you set an essence mark.

When Shot Mark0 to Shot Mark 9 is set, you can search for the shot marks by displaying thumbnails of the frames at those positions (see page 76).

You can also use shot mark positions as edit points during scene selection operations (see page 85).

You can also set shot marks during playback. See page 64 for the procedure.

To set a clip flag

You can set one of the three types of flag (OK, NG or KEEP) for the clip while it is being recorded by viewing its video image and using the function menu (see page 51).

You can also set a clip flag during playback. See page 64 for details.

You can also set a clip flag on the GUI screen. See page 82 for details.

Continuing recording while exchanging discs (disc exchange cache function)

About 30 seconds (this duration may differ depending on the state of a disc) of video and audio data can be recorded to the unit’s internal memory cache during a disc exchange, and then written back to the newly loaded disc.

- 1 Check that setup menu item 150 REC MODE is set to “disc exchange cache”.

If the disc exchange cache indication is lit in the time data display area (see page 24) of the basic operation display, setup menu item 150 REC MODE is set to “disc exchange cache”.

- 2 If none of the indications of step 1 appear, set setup menu item 150 REC MODE to “disc exchange cache” (see page 130).

The setting of 150 REC MODE can be changed even during recording.

However, if you change the setting from “clip continuous rec”, the setting change is enabled after the end of Clip Continuous Rec mode recording.

- 3 Exchange the disc.

When recording on the current disc ends, the disc is ejected. Until the next disc is inserted, the unit records to its internal cache memory. Then, after the new disc is inserted, it copies the data from the cache to the disc and resumes normal recording.

Disc exchange cache indications and their meanings

Indication	Meaning
Right side of icon flashes once per second	Recording to the cache
Left side of icon flashes twice per second	Remaining memory capacity: Low
Whole icon flashes four times per second	Remaining memory capacity: None (disc full)

“C” indications in superimposed text information and their meanings

Indication	Meaning
“C” flashes once per second	Recording to the cache
“C” flashes twice per second	Remaining memory capacity: Low
An alarm message appears instead of “C”.	Remaining memory capacity: None (disc full)

To stop disc exchange cache recording

Do any of the following during cache recording.

- Press the STOP button.
- Set setup menu item 150 REC MODE to “normal”.

Notes

- If the disc becomes full while setup menu item 150 REC MODE is set to “disc exchange cache”, the disc is ejected and the unit continues to record to its internal memory (for about 30 seconds depending on the state of a disc).
- Recording and playback operations by all buttons and dials other than the STOP button are disabled during cache recording.
- If the amount of cache data exceeds the capacity of the unit’s internal memory during a disc exchange, an alarm message appears and the data in cache memory is overwritten. The internal memory always contains the latest cache data, so the clip data will be continuous after the next disc is inserted and recording to the disc resumes.

Recording with the HDSDI remote control function

This section explains the settings required for recording in HDSDI remote control mode, and how the unit operates in this mode.

Note

The unit (camcorder) that controls this unit must also support HDSDI remote output.

Settings

Set setup menu item 214 REMOTE INTERFACE to “SDI”, and set the remote control switch on the front panel to “REMOTE”.

This unit enters HDSDI remote control mode, in which it is controlled by command packets received via the SD/HDSDI INPUT connector.

Note

The following limitations apply in HDSDI remote control mode.

- Commands received via the REMOTE(9P) connector are ignored.
- Recording and playback operations on the front panel are disabled, except for the EJECT button.

Monitor display in HDSDI remote control mode

“RM-SDI” appears in the remote interface display area (see page 26) of the monitor. This display lights if command packets are embedded into HDSDI signals, and flashes if they are not. However, the “RM-SDI” continues to flash until the time the controlling camcorder is powered on and the time that the REC button is pressed on the camcorder.

Recording operation

When a recordable disc is inserted, recording (or stop) is executed according to the REC (or STOP) command embedded into the HDSDI signals.

Recording stops automatically when the end of the disc is reached.

When HDSDI signals are interrupted during recording

Recording stops if HDSDI signals are interrupted during recording, for example because the HDSDI cable is disconnected or the controlling camcorder is powered off. When HDSDI signal input is restored, the unit resumes operation according to the embedded REC or STOP command.

Exchanging discs

Even during recording, it is possible to eject discs by pressing the EJECT button on the front panel. After a disc is exchanged, the unit resumes operation according to the embedded REC or STOP command.

Note

This unit begins recording operation about one second after the camcorder.

Recording with the Clip Continuous Rec function

Normally, a clip is generated as an independent file every time recording starts and stops. The Clip Continuous Rec function allows you to continue recording to the same clip until the function is stopped or turned off, regardless of how many times recording starts and stops. This is convenient if you want to avoid generating a large number of short clips, or if you want to record without worrying about the limit on the number of clips (maximum 300). A Rec Start essence mark is recorded whenever recording starts, which makes it easy to find the recording start points (see page 77).

Note

A new clip may be created the next time you start recording if it is impossible to continue recording to the same clip because of signal noise or some other reason.

To enable the function

Set setup menu item 150 REC MODE to “clip continuous rec”.

For details about operation, see “Basic menu operations” (page 126).

To record

Send a “REC” command from a controlling device connected to either of the following connectors.

- REMOTE(9P) connector
- SD/HDSDI INPUT connector (Put the unit into HDSDI remote control mode.)

To stop recording

Send a “REC PAUSE” command.

To stop the function

Do one of the following to stop the Clip Continuous Rec function. (A new clip will be generated the next time you start recording.)

- Perform a clip operation (lock, delete, or rename a clip)
- Make a network or FAM connection
- Eject the disc

- Change the recording format (change the setting of setup menu item 031 RECORDING FORMAT)
- Power the unit off

To turn the function off

Set setup menu item 150 REC MODE to “normal”.

Handling of discs when recording does not end normally (salvage functions)

Recording processing does not end normally if, for example, the POWER switch on the rear panel is turned off during recording, or if the power cord is disconnected during recording. Because the file system is not updated, video and audio data recorded in real time is not recognized as files and clip contents recorded up to that point are lost.

However, this unit has salvage functions which can hold losses to the minimum by reconstructing clips on such discs. There is a quick salvage function which executes automatically and a full salvage function which you can execute as required.

Quick salvage: Clips are reconstructed on the basis of backup data stored in nonvolatile memory and markers recorded on the disc. Processing time is about 5 seconds.

Quick salvage executes automatically if the unit is powered on with a disc still loaded after recording was interrupted by power off.

Full salvage: Clips are reconstructed on the basis of markers recorded on the disc. Nonvolatile memory cannot be used, so processing takes longer than for a quick salvage (about 30 seconds, although it depends on the state of the disc).

You are prompted to execute a full salvage whenever you insert a disc that was removed manually from a powered off device after interruption of recording by power off.

Note that no recorded clip contents are lost when the on/standby button on the front panel is set to standby during recording, because the unit does not enter standby mode until after the end of recording processing.

Notes

- Even after recording finishes, do not set the POWER switch on the rear panel to off until the ACCESS indicator has gone out.
- These functions salvage as much recorded material as possible after an unforeseen accident, but 100% restoration cannot be guaranteed.
- When recording on the PDW-F1600 or PDW-HD1500 does not end successfully, you can use another XDCAM

system to perform a full salvage of the disc. As the other system, use the PDW-F800 or PDW-700.

- The following alarm message (*see page 158*) may appear when you insert a disc:
“DISC CANNOT BE RECORDED. FORMAT DISC OR CONTACT SERVICE TO RUN CLIP SALVAGE PROGRAM. (XXXX)”

This message means that recording on that disc did not end normally. The “XXXX” in the message is a code for XDCAM devices that can salvage the disc. Refer to the following table and use one of the indicated devices to salvage the disc.

Code (XXXX)	Model
0002	PDW-1500/530/510/R1 PDW-F70/F350/F330
0200	PDW-F70/F350/F330 (Version 1.9 or higher) PDW-F75/F355/F335
0300 ^{a)}	PDW-HD1500/HR1/700
0301 ^{a)}	PDW-HD1500/700 (Version 1.5 or higher) PDW-F1600/F800

^{a)}Does not appear on this unit.

- Even when these functions are used, it is not possible to recover data from immediately before the interruption of recording. The amount of data lost is as follows.

Quick salvage: From 2 to 4 seconds of data before the interruption of recording.

Full salvage: From 4 to 6 seconds of data before the interruption of recording.

(More data may be lost when the unit is subject to vibrations, and when you switch frequently between recording and paused.)

- You are prompted to execute a full salvage every time you insert a disc that has not been salvaged, or power the unit on with such as disc loaded.
- No recording is possible on discs containing clips that have not been salvaged, although it is possible to play back the normally recorded sections. Recording becomes possible if you perform a quick format, but this erases all of the original recorded content.

To restore clips with a full salvage

- 1 Insert the disc on which recording did not end normally.

The message “Salvage ?” appears on the display.

To cancel the clip salvage

Press the RESET/RETURN button.

Notes

- The message “EJECT?” appears when “REC INHI” is displayed. If the disc is write protected, eject the

disc, set the Write Inhibit tab to enable recording, and then insert the disc again. If REC INH on HOME page of the function menu is set to “ON”, set it to “OFF” (see page 48).

- This operation cannot be cancelled once it begins.

2 Press the PUSH SET(S.SEL) knob.

Processing begins and the message “Executing.” appears.

When processing finishes, a message appears to display the results.

If the message reads “Incomplete!”, the clips that failed were lost.

F1600

Linear Editing

Overview

You can perform the following types of editing on recorded clips.

Type of editing	Editing target
Insert editing	Video tracks in a single clip.
	Audio tracks in a single clip. (Split editing is also possible. But the Out point must be shared with the video tracks.)
	Timecode in a single clip.
Assemble editing	Final clip.

Notes

- A disc which contains clip lists cannot be used as a disc for editing. However, it can be used as a playback disc.
- A disc which contains clips in different recording formats cannot be used as a disc for editing. However, it can be used as a playback disc if you create a clip list that contains only clips in one of the recording formats.
- Locked clips cannot be edited.
- Editing across multiple clips is not possible.
- It is not possible to carry out assemble editing other than on the final clip.
- If there is no space on the disc, in assemble editing it will not be possible to extend the clip.
- Pread editing is not supported.
- After linear editing, discs in the MPEG HD422 format cannot be read by the versions 1.2 or earlier of the PDW-HD1500/700. To play such discs on the PDW-HD1500/700, upgrade the software to version 1.5 or higher.
- Even after linear editing, the underlying VANC data is not rewritten. (VANC data cannot be edited.) However, essence mark data is rewritten (can be edited).
- Linear editing is not possible when the unit is in one of the following modes. To perform linear editing, exit the mode.
 - Single clip playback mode
 - Clip Continuous Rec mode
 - Disc Exchange Cache mode
- Normally, linear editing on this unit can target only clips that have been created on XDCAM devices. It may not be possible to edit clips that been created by other software applications and uploaded to this unit as files.

Editable clip recording formats

This unit supports editing of the following recording formats.

- MPEG HD422 1080 59.94i/29.97P/50i/25P/23.98P
- MPEG HD422 720 59.94P/50P

- MPEG IMX 59.94i/50i
- DVCAM 59.94i/50i

Note

Editing of the MPEG HD420 format is not supported.

Editable video and audio signals

This unit supports editing of the following signals on video and audio tracks.

- Video
 - HD-SDI (for HD recording)
 - SD-SDI (for SD recording)
- Audio
 - SDI
 - Analog
 - AES/EBU

Notes

- Video and audio signals input to the **i** (i.LINK) S400 connector cannot be edited.
- Editing cannot be done with a File Access Mode (FAM) connection.
- Recording of upconverted SD is not supported.

Discs that can be used

Use the following Professional Discs.

Model number	Capacity	Data transfer rate (writing)
PFD23A	23.3 GB	2.4 times normal
PFD50DLA	50.0 GB	

Note

A PFD23 Professional Disc with a 2 times normal data transfer rate cannot be used for linear editing.

Connections

Make connections in the same way as for a cut editing system (see page 37).

When making the connections, also refer to the operation manuals provided with the equipment to be connected.

Preparations for editing

Recording format settings

Before performing clip editing, you need to set the recording format of the PDW-F1600 units to match the

recording format of the editing target clip. The following table shows the required settings.

Item	Setting
Recording format	Check the recording format of the clip with the display window (see page 24) and select the same format with setup menu item 031 RECORDING FORMAT.
Audio/Non-audio (data)	To perform insert editing of non-audio (data), set maintenance menu item M37: AUDIO CONFIG >M372: NON-AUDIO INPUT to “data”. Notes <ul style="list-style-type: none"> • When you insert non-audio into a clip, the channels containing the non-audio are treated as non-audio across their entire length. • Use channel pairs (CH1/2, CH3/4, CH5/6, CH7/8) for non-audio insert editing. Non-audio editing is not executed unless a channel pair is specified.

See page 126 for more information about setup menu operations.

See page 148 for more information about maintenance menu operations.

Settings required for editing

The following table shows the settings required for editing.

Item	Setting
Audio digital signal processor	With the maintenance menu item M39: OTHER CONFIG >M393: AUDIO DSP, select “linear edit”.
Video input signal	Select the video input signal with V INPUT on page P1 VIDEO of the function menu.
Audio input signal	Select the audio input signal with A1 INPUT and A2 INPUT on page P2 AUDIO, and A3 INPUT to A8 INPUT on page P3 AUDIO of the function menu.
Input audio level	Adjust the input audio level with the CH-1/ALL CH and CH-2 to CH-4 knobs.
Edit point transition type	With setup menu item 317 AUDIO EDIT MODE, select “cut edit” or “cross fade”.
Audio mix	<i>See the next section “To set up mixing of audio input signals”.</i>
Time code	<ul style="list-style-type: none"> • With TCG on page P5 TC of the function menu, select “INT”. • With PRST/RGN on page P5 TC of the function menu, select “PRESET”. • With RUN MODE on page P5 TC of the function menu, select “FREE RUN”.

See page 148 for more information about maintenance menu operations.

See page 48 for more information about function menu operations.

See page 126 for more information about setup menu operations.

To set up mixing of audio input signals

By making setup menu settings, you can perform the following kinds of audio mixing.

- Mixing of audio input signals.
- Changing the channels of audio input signals and recording to disc.
- Mixing of audio input signals and audio that has been recorded to disc (sound on sound).

- 1 Display setup menu item 819 AUDIO INPUT ARRANGE.

See page 126 for more information about setup menu operations.

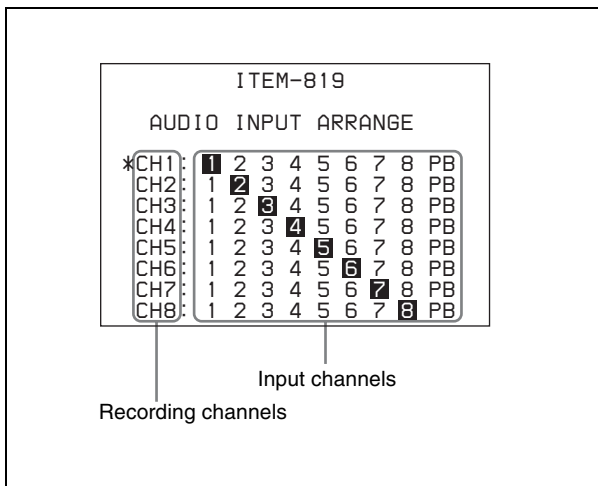

To return to the setup menu

Press the PUSH SET(S.SEL) knob without turning it.

- 2 Turn the PUSH SET(S.SEL) knob to move the “*” to the recording channel that you want to set up, and then press the PUSH SET(S.SEL) knob.

The screen changes to the input channel selection screen.

To return to the recording channel selection screen

Press the PUSH SET(S.SEL) knob without turning it.

- 3 Turn the PUSH SET(S.SEL) knob to move “→” to the input channel that you want to turn on, and then press the PUSH SET(S.SEL) knob.

In this state, you can turn the selected input channel on or off.

To toggle the input channel on (highlighted) or off

Do one of the following.

- Turn the PUSH SET(S.SEL) knob.
- Press the – or + function button (F3 or F4).

To confirm the setting and return to the input channel selection screen

Press the PUSH SET(S.SEL) knob.

To exchange input channels

For example, turn input channel 2 on for recording channel 1, and turn input channel 1 on for recording channel 2.

To mix multiple audio input signals

For each of the recording channels, turn any two input channels on.

To make sound-on-sound settings

In addition to the input channels, also turn “PB” on.

- 4 Repeat steps 2 and 3 until you have set up mixing for all of the required channels.

- 5 Press the SAVE function button (F5).

The settings are saved, and the unit exits the audio setup mode.

- 6 Set MIX/SWAP on page P4 AUDIO of the function menu to “ON”.

The setting of setup menu item 819 AUDIO INPUT ARRANGE is enabled.

Editing operations

Notes

- When the In and Out points are not set in the same clip, insert editing is performed only for the clip containing the In point.

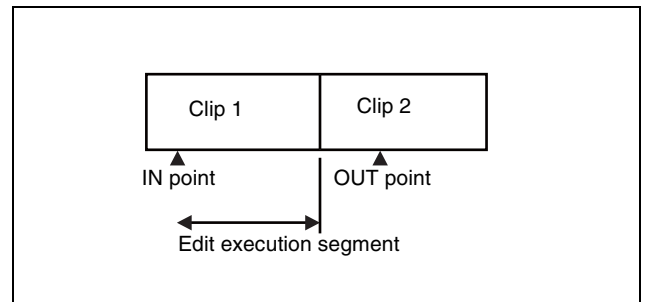

- If the OUT point is set within the final clip, in assemble editing the length of the clip does not change.

Carrying out clip editing

To carry out clip editing, use an RM-280 or similar editing controller.

For details of how to set edit points and carry out editing, refer to the operation manual for the editing controller.

Note

If an assemble edit command is received while maintenance menu item M393: AUDIO DSP is set to “AGC/limiter”, the unit creates a new clip and performs normal recording.

Essence marks recorded by clip editing

“CUT” is recorded as an essence mark at the IN and OUT points of video insert editing, and at the IN point of assemble editing. By selecting “CUT” in the essence mark selection screen, you can search the result of editing.

For details of searching using essence marks, see page 76.

Playback

This section describes playback of video and audio on the unit.

Before starting playback, make the following settings and adjustments.

Selection of time data to display: Select with CNTR SEL on HOME page of the function menu.

Selection of audio channels to monitor: Select with MONITR L and MONITR R on page P2 AUDIO of the function menu.

Volume adjustment of the monitor audio: Adjust with the LEVEL knob.

Remote/local setting: Set the remote control switch. If you set it to REMOTE, also set setup menu item 214 REMOTE INTERFACE (“RM-” and the connector used appear on the display) (*see page 131*).

Clip playback modes

You can set the clip playback mode to either of the following.

Continuous playback mode: The playback target is all of the clips on the disc (factory default setting)

Single clip playback mode: The playback target is the currently selected clip only

To select single clip playback mode

Set setup menu item 154 SINGLE CLIP PLAY MODE to “on”.

Playback in single clip playback mode

Playback stops when it reaches the start or end of the clip. The next and preceding clips are not played, even if they exist on the disc. The available playback types include normal playback, high-speed playback in the forward or reverse directions, and jog, shuttle, and variable playback. When this unit is set to repeat playback mode, the selected clip only is played repeatedly.

To move to another clip, press the PREV, NEXT, SHIFT + PREV, or SHIFT + NEXT button, or perform a thumbnail search.

Pulldown playback

When this unit’s system frequency is set to 1080/59.94i, 1080/29.97P, or 720/59.94P, clips recorded as 1080/23.98P are converted by 2-3 pulldown before playback (pulldown playback).

Timecode in pulldown playback

During pulldown playback, timecode is also converted to 30 frames to match the output video signals.

The upper row of the time data display area displays the original 24-frame timecode, and the lower row displays the 30-frame timecode.

TC	U/TC
00:59:59:23	
PDT	00:59:59:29

You can superimpose the 30-frame timecode after pull-down on an external monitor. To do so, set setup menu item 005 DISPLAY INFORMATION SELECT to “time data only”.

TCR	00:59:59:23
PDT	00:59:59:29

Disc playback start position

Although this unit uses optical discs, it is designed to offer the most convenient features of tape playback by VTRs. One of these is the playback start position, which works in the same way as tape, as described below.

After playback stop

The unit stops at the position where the STOP button was pressed. Press the PLAY button to resume playback at the stop position.

After recording

The unit stops at the position where recording ended. To play back a clip, press the PREV button to move to the start frame of any clip or press the PREV button with the PLAY button held down to move to any position.

After disc insertion

The unit stops at the position of the disc when it was most recently ejected. Press the PLAY button to resume playback at the most recent position. The playback position is saved to the disc when the disc is ejected, which allows playback to start at that position whenever it is loaded into any XDCAM player.

Note

This function is not available when the Write Inhibit tab of the disc is set to the recording disabled position, and when REC INH on HOME page of the function menu is set to “ON”.

The REC INHI indicator may light when neither of the above is true if the format of recorded sections on the disc is not the same as the recording settings of this unit. In this case, the playback position can be saved to the disc.

1080/720 cross convert function

You can output 720 while playing discs recorded as 1080, and output 1080 while playing discs recorded as 720. When the system frequency of the loaded disc (59.94i/59.94P/29.97P, 50i/50P/25P, or 23.98P) matches the system frequency of the unit, but the system line settings (1080 or 720) do not match, then an “FC” mark appears and disc playback is cross converted automatically. E-E output is not cross converted.

SD up convert function

By installing the PDBK-S1500 option, you can output HD while playing discs recorded as SD.

HD down convert function

You can always output SD while playing discs recorded as HD.

To specify the frame to use as the thumbnail image

You can display a list of thumbnails of all clips on a disc, and use it to check the recorded content (*see page 74*). When the unit is shipped from the factory, it is set up to display the first frame of each clip as the thumbnail. As required, you can select another frame to display as the thumbnail.

For example, if there are several seconds of color bars recorded at the start of the clip, selecting a frame several seconds after the end of the recording of color bars can make it easier to identify the clip.

The GUI screen allows you to select thumbnail frames while viewing the video.

For details, see “Changing clip index pictures” (page 79).

You can also use setup menu item 143 INDEX PICTURE POSITION to specify a different default frame. You can specify the initial frame in any of the first few seconds after the initial frame. The setting range is 0 seconds to 10 seconds.

Playback operation

This section describes the following types of playback:

Normal playback: Playback at normal speed

Playback in jog mode: Variable-speed playback, with the speed determined by the speed of turning the jog dial

Playback in shuttle mode: Variable-speed playback, with the speed determined by the angular position of the shuttle dial

Playback in variable-speed mode: Variable-speed playback, with the speed finely determined by the angular position of the shuttle dial

Normal playback

First insert a disc.

For details of how to insert a disc, see “Loading and unloading a disc” (page 53).

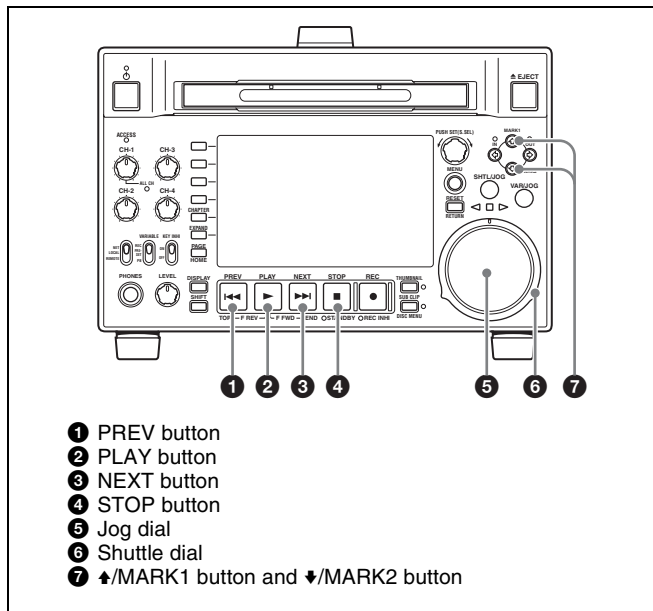

To start playback

Press the PLAY button.
 Playback starts.

When two or more clips are recorded on the disc, they are played back continuously.

Note

No audio is output when non-audio signals are played back.

To jump to the next or previous clip, then start playback

Use the PREV button, NEXT button, jog dial, or shuttle dial.

To stop playback

Press the STOP button.

If you play back to the end of the last clip, playback automatically stops.

If, in this state, you press the PLAY button, the message “Disc End!” appears on the display.

To carry out playback again, move back to the desired clip using the PREV button, jog dial or shuttle dial.

To set shot marks

While playing back a disc, you can set essence marks such as Shot Mark1 and Shot Mark2 in desired frames.

To set a Shot Mark1 or Shot Mark2, hold down the ▲/MARK1 or ▼/MARK2 button and press the PUSH SET(S.SEL) knob. If you connect a Windows USB keyboard to the MAINTENANCE connector, you can record shot marks from Shot Mark0 up to Shot Mark9 by pressing the 0 to 9 keys on the numeric keypad.

Use the PDZ-1 Proxy Browsing Software on the supplied XDCAM Application Software CD-ROM to delete and modify essence marks.

See page 170 for an overview of the PDZ-1 software and information about how to install it.

You can also delete and modify essence marks from the Thumbnail Menu of the chapter thumbnail screen (see page 75).

To set a clip flag

You can set one of the three types of flag (OK, NG or KEEP) for the clip while it is being played back by viewing its video image and using the function menu (see page 51).

Playback in jog mode

In jog mode, you can control the speed of playback by the speed of turning the jog dial. The playback speed range is -1 to $+1$ times normal speed.

To carry out playback in jog mode, proceed as follows.

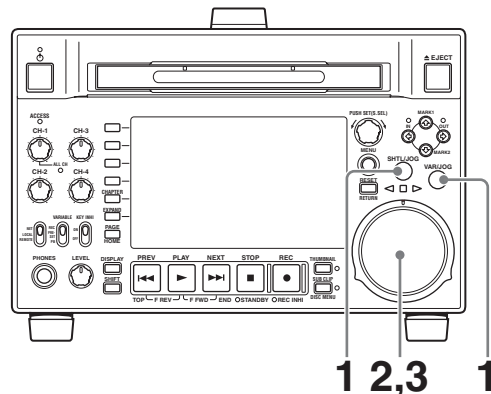

1 Press the SHTL/JOG button or VAR/JOG button, turning it on.

2 Turn the jog dial in the desired direction, at the speed corresponding to the desired playback speed.

Playback in jog mode starts.

3 To stop playback in jog mode, stop turning the jog dial.

When setup menu item 101 SELECTION FOR SEARCH DIAL ENABLE is set to “dial” (factory default setting), you can start jog playback by simply rotating the jog dial, even when the SHTL/JOG and VAR/JOG buttons are not lit.

Playback in shuttle mode

In shuttle mode, you can control the speed of playback by the angular position of the shuttle dial. The range of playback speed is ± 20 times normal speed.

To carry out playback in shuttle mode, proceed as follows.

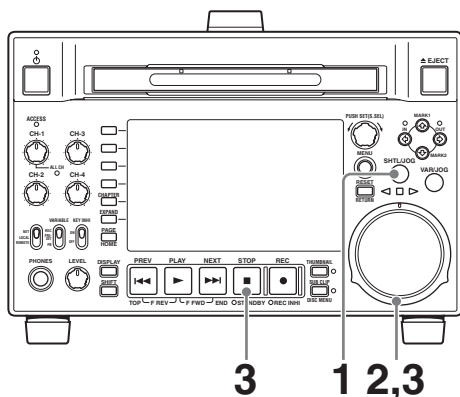

- 1 Press the SHTL/JOG button, turning it on.
- 2 Turn the shuttle dial to the desired angle corresponding to the desired playback speed.
Playback in shuttle mode starts.
- 3 To stop playback in shuttle mode, return the shuttle dial to the center position, or press the STOP button.

When setup menu item 101 SELECTION FOR SEARCH DIAL ENABLE is set to “dial” (factory default setting), you can start shuttle playback by simply rotating the shuttle dial, even when the SHTL/JOG button is not lit.

To alternate between normal-speed playback and shuttle mode playback

Set the shuttle dial to the position corresponding to the desired shuttle playback speed, then switch between normal-speed playback and shuttle playback by pressing the PLAY and SHTL/JOG buttons alternately.

Playback in variable-speed mode

In variable-speed mode, you can control the speed of playback in the range of -2 to $+2$ times normal speed. (You can use setup menu item 119 VARIABLE SPEED LIMIT IN KEY to specify the speed range of variable playback.) To carry out playback in variable-speed mode, proceed as follows.

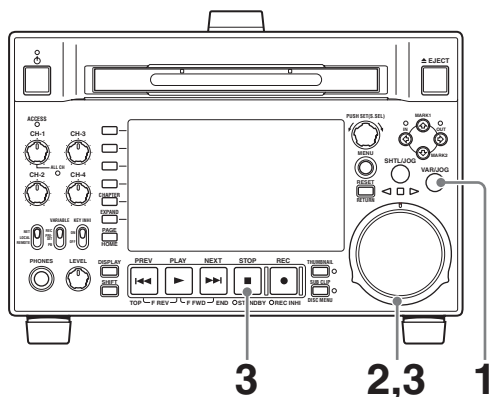

- 1 Press the VAR/JOG button, turning it on.
- 2 Turn the shuttle dial to the desired angle corresponding to the desired playback speed.
Playback in variable-speed mode starts.
- 3 To stop playback in variable-speed mode, return the shuttle dial to the center position, or press the STOP button.

To alternate between normal-speed playback and variable-speed mode playback

Set the shuttle dial to the position corresponding to the desired variable playback speed, then switch between normal-speed playback and variable-speed mode playback by pressing the PLAY and VAR/JOG buttons alternately.

To perform manual frame sync playback

During playback, you can adjust the playback output phase in units of one frame. To do so, hold down the PLAY button and turn the PUSH SET(S.SEL) knob in either direction.

To speed up the phase: Turn clockwise.

To delay the phase: Turn counterclockwise.

Playback operations using thumbnails

Playback operations that you can perform with thumbnails include searching for clips, displaying clip information, playing clip lists created with the scene selection function, and locking and deleting clip. This allows you to check the actual video as you work.

See “Thumbnail Operations” (page 74) for more information about thumbnail operations, and “Scene Selection (Clip List Editing)” (page 85) for more information about the scene selection function.

Overview

You can perform scene searches, play the searched scenes, and select scenes (edit clip list) in Graphical User Interface (GUI) screens. The GUI screens are your gateways to discs and the data saved on discs.

(The GUI screens can display European languages, Japanese, Korean, Simplified Chinese, and Traditional Chinese for clip names and titles.)

Switching between GUI screens

The most important GUI screens are:

Clip thumbnail screen: displays thumbnails of clips on the disc. “Clip” is displayed as the title at the upper left of the screen (*see page 67*).

Clip list thumbnail screen: displays thumbnails of sub clips in a clip list. “Clip List” is displayed as the title at the upper left of the screen (*see page 67*).

There are also two playback screens:

Clip playback screen: playback screen for normal video

Clip list playback screen: playback screen for clip list video

You will use the THUMBNAIL button **1** and the SUB CLIP/DISC MENU button **2** to switch between these four screens. Each press of these buttons switches between the screens as shown in the following figure. The THUMBNAIL and SUB CLIP/DISC MENU indicators light as follows, according to the type of screen that is currently displayed.

Note

To switch between these four screens, a disc with recorded clips must be loaded in the unit.

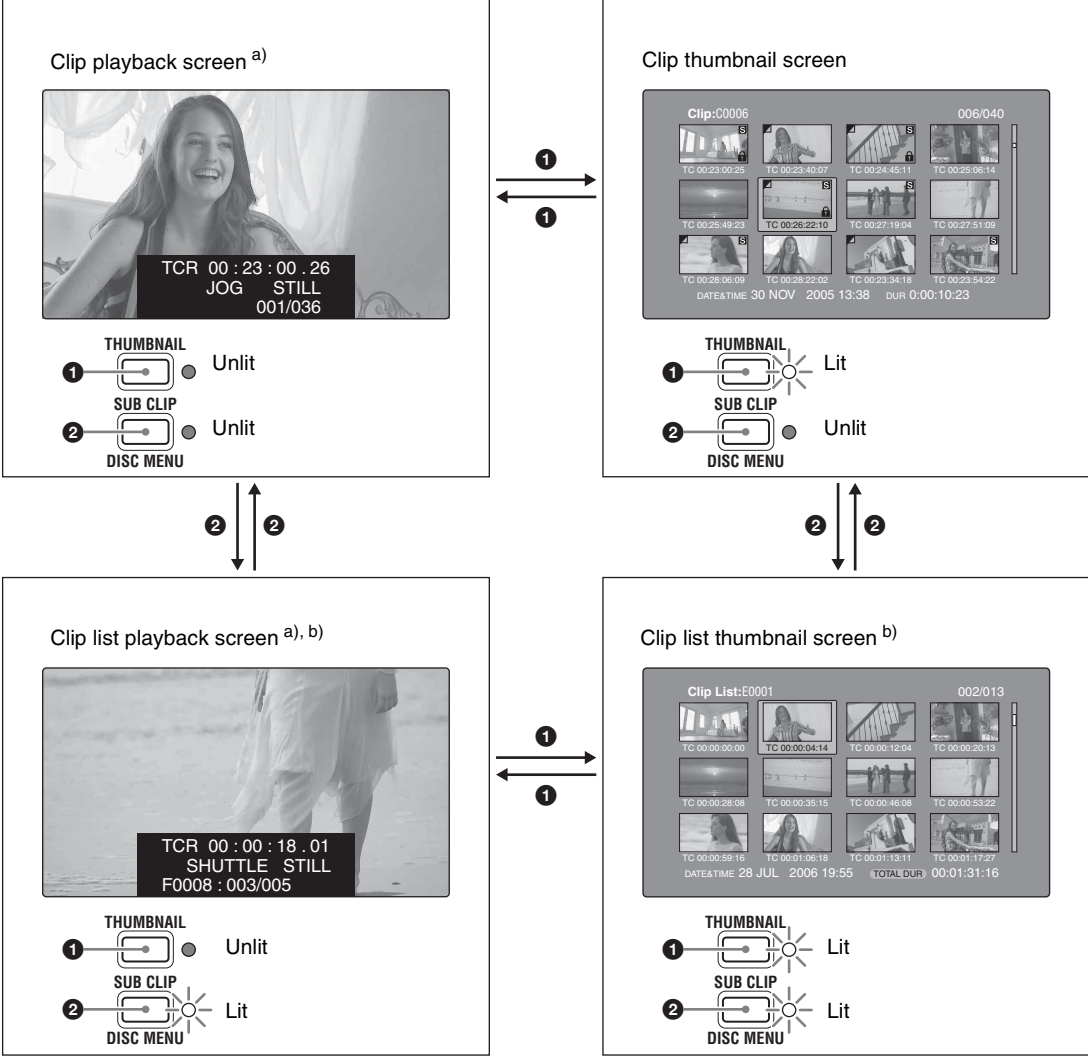

a) Playback screens appear when you switch to video monitor display. Use the DISPLAY button to switch from the basic monitor display to video monitor display (see page 21).
 b) The clip list playback screen appears when a clip list is loaded into the unit's memory (see page 90).

- The other thumbnail screens are:
- Expand thumbnail screen
 - Chapter thumbnail screen
 - Essence mark thumbnail screen

Information and controls in thumbnail screens

About the display of clip and clip list names

You can specify that titles should appear instead of names in the clip name areas of thumbnail screens. You can also change the display language.

To specify that titles, if they exist, should be displayed with higher priority than names, select one of the following under Settings >Display Title in the Disc Menu.
On: Title1 "title1": Display in the order title1, title2, clip or clip list name.
On: Title2 {title2}: Display in the order title2, title1, clip or clip list name.

To change the display language according to the area of use (see page 33), select the desired language under Settings >Select Font in the Disc Menu.

Area of use setting	Select Font setting	Displayable languages
J (for Japan)	—	English/Japanese

Area of use setting	Select Font setting	Displayable languages
UC (for regions outside Japan)	European Alphabet	English/European languages
	Korean	English/Korean
	Simplified Chinese	English/Simplified Chinese
	Traditional Chinese	English/Traditional Chinese

Clip thumbnail screen

This screen displays thumbnails of clips on the disc in the order that they were recorded. You can use this screen to work with clips – deleting or locking them, selecting their index pictures, adding them to clip lists, and so on.

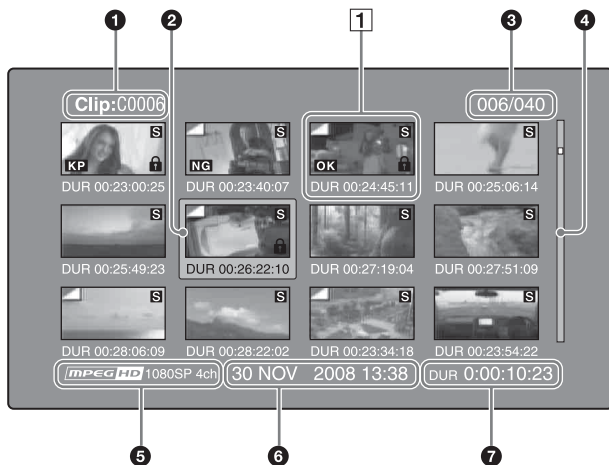

1 Clip name

Displays the name or a title of the selected clip (*see page 67*).

2 Selection frame

Indicates that the thumbnail is selected. To select another thumbnail, move the frame (*see page 73*). Multiple selection frames appear when multiple thumbnails are selected (*see page 73*).

3 Clip number/total number of clips

Displays the total number of clips on the disc, and the number of the selected clip.

4 Scrollbar

When not all of the thumbnails can be displayed in the thumbnail display area, the position of the slider shows the relative position of the currently displayed clips, and the length of the slider shows the relative length of currently displayed clips within all of the clips.

When you have a large number of thumbnails, you can save time by using the Skip Scroll function to jump directly to the thumbnail you want (*see page 74*).

5 Recording format

The recording format of the selected clip is displayed as a combination of the following information.

- Video format logo
- Number of system lines
- Recording quality
- Number of audio channels

6 Clip date and time

Displays the date and time when the selected clip was shot and recorded.

7 Duration

Displays the duration (recording time) of the selected clip. When multiple clips are selected, displays the total recording time of the selected clips.

1 Thumbnail display items

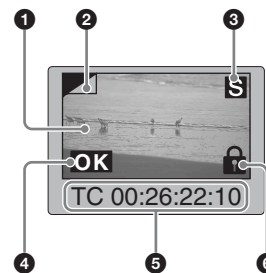

1 Index picture

Displays an image to stand for the content of the clip. The index picture is normally the first frame of the clip.

2 Index picture changed mark

This mark, like the folded-over corner of a page that you want to remember, appears when the index picture has been changed to any frame other than the first frame of a clip (*see page 79*).

Note

When you cue up a clip, the unit always cues up the first frame, even when the index picture has been changed to a different frame.

3 S mark

This mark appears when shot marks or other essence marks have been set in the clip (*see page 55*).

The chapter thumbnail screen can be displayed for clips that show this mark (*see page 69*).

4 Clip flag icon

Displays the corresponding icon when a clip flag (OK/NG/KP (KEEP)) is set in the clip.

5 Clip and frame information

Displays the clip or frame information selected with the Clip Information item in the Thumbnail Menu (*see*

page 79). The factory default selection is the timecode of the first frame or the timecode of the thumbnail frame.

6 Lock icon

This icon appears when the clip is locked (protected) (see page 83). Clips cannot be deleted and their clip information cannot be changed when this mark is displayed.

Clip list thumbnail screen

This screen displays thumbnails of the clips in the current clip list. You can use this screen to create and edit clips lists.

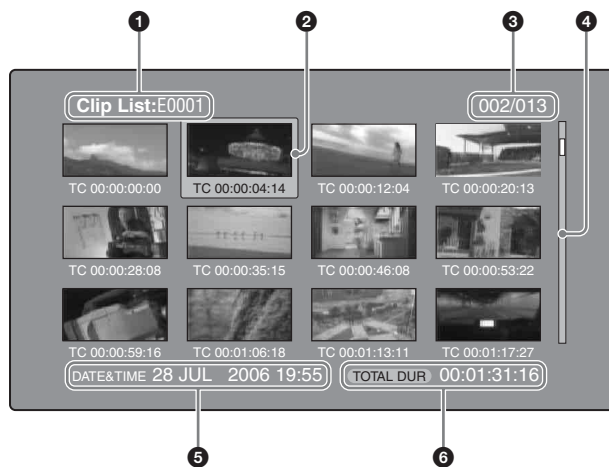

1 Clip list name

Displays the name or a title of the clip list (see page 67).

2 Selection frame

See the description in “Clip thumbnail screen” (page 68).

3 Sub clip number/number of sub clips

Displays the total number of sub clips in the clip list, and the number of the selected sub clip.

4 Scrollbar

See the description in “Clip thumbnail screen” (page 68).

5 Clip list date and time

Displays the date and time when the clip list was created, or the date and time of its most recent modification. An asterisk (*) appears after the date and time of creation when the current clip list has not been saved to the disc.

Note

“New File” appears when no clip list has been loaded into the unit’s memory, and when a clip list has been cleared from the unit’s memory.

6 Total duration

Displays the total duration of all sub clips in the clip list.

Expand thumbnail screen

This screen displays thumbnails of equally sized divisions of the selected clip.

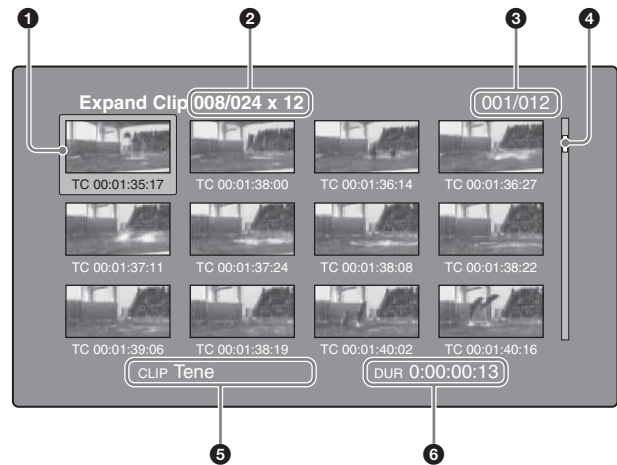

1 Selection frame

See the description in “Clip thumbnail screen” (page 68).

2 Clip number/total clips × number of divisions

Displays the number of the selected clip, the total number of clips on the disc, and the number of times that the selected clip has been divided to display the expansion thumbnails.

3 Thumbnail number/total thumbnails

Displays the total number of expanded thumbnails and the number of the selected thumbnail.

4 Scrollbar

See the description in “Clip thumbnail screen” (page 68).

5 Clip name

Displays the name or a title of the expanded clip (see page 67).

6 Duration

Displays the time from the selected thumbnail to the next one.

Chapter thumbnail screen

Chapters are the sections between the shot marks, Rec Start marks, and other essence marks that have been recorded in clips. This screen allows you to display thumbnails of the chapters in the selected clip.

Note

Shot marks can be set by the user during recording and playback. They can be deleted and moved. Essence marks other than shot marks are set automatically. They cannot be deleted or moved.

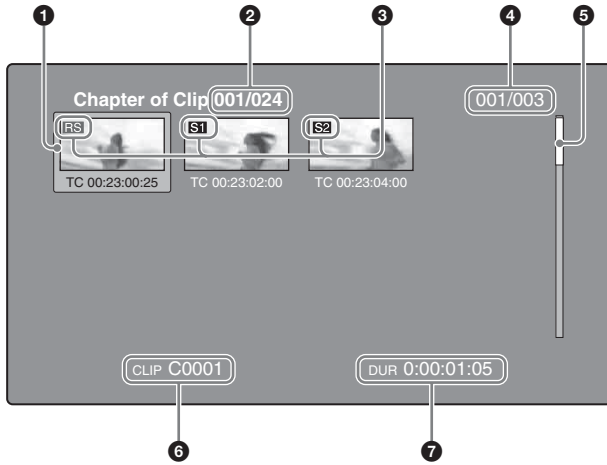

1 Selection frame

See the description in "Clip thumbnail screen" (page 68).

2 Clip number/total clips

Displays the total number of clips on the disc and the number of the clip that contains the displayed chapters. If the essence mark name is a user-defined name, it is displayed between quotation marks, for example as [Chapter: "Touch Down"] (see page 93).

3 S1/S2/RS marks

The "S1", "S2", and "RS" marks on the thumbnails indicate frames where Shot Mark1, Shot Mark2, and Rec Start essence marks are set.

4 Chapter number/total chapters

Displays the total number of chapters and the number of the selected chapter.

Note

The total number of chapters is the total number of chapters in the specified clip only.

5 Scrollbar

See the description in "Clip thumbnail screen" (page 68).

6 Clip name

Displays the name or a title of the clip whose chapter is displayed (see page 67).

7 Duration

Displays the time from the first frame of the selected chapter to the first frame of the next chapter.

Essence mark thumbnail screen

This screen displays thumbnails of the specified essence mark, found by searching all clips on the disc.

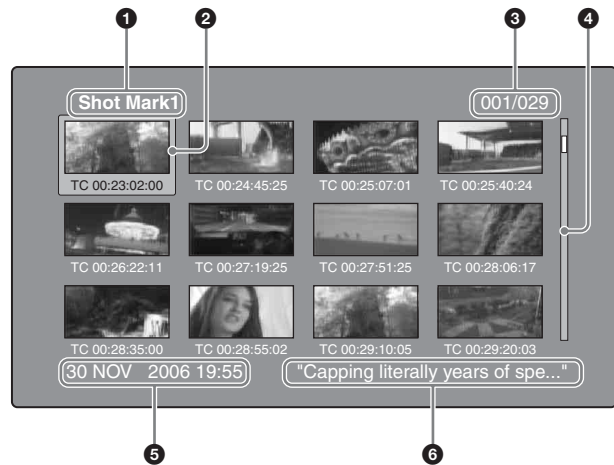

1 Essence mark name

Displays the name of the essence mark (Shot Mark1 here). If the shot mark name has been defined by the user, it is enclosed in quotation marks (" ") in the display (see page 93).

2 Selection frame

See the description in "Clip thumbnail screen" (page 68).

3 Essence mark number/total essence marks

Displays the total number of essence marks and the number of the selected essence mark.

Note

The total number of essence marks is the total number of essence marks that have been set in all clips on the disc.

4 Scrollbar

See the description in "Clip thumbnail screen" (page 68).

5 Clip date and time

Displays the date and time when the clip that contains the selected thumbnail was recorded or last modified.

6 Clip name

Displays the name or a title of the clip that contains the selected frame (see page 67).

Displaying menus

Thumbnail Menu

The Thumbnail Menu displays menu items that are valid for the currently displayed thumbnail screen.

To display the Thumbnail Menu

To display the Thumbnail Menu, press the MENU button with a thumbnail screen displayed. To return to the original screen, press the MENU button again, or press the RESET/RETURN button.

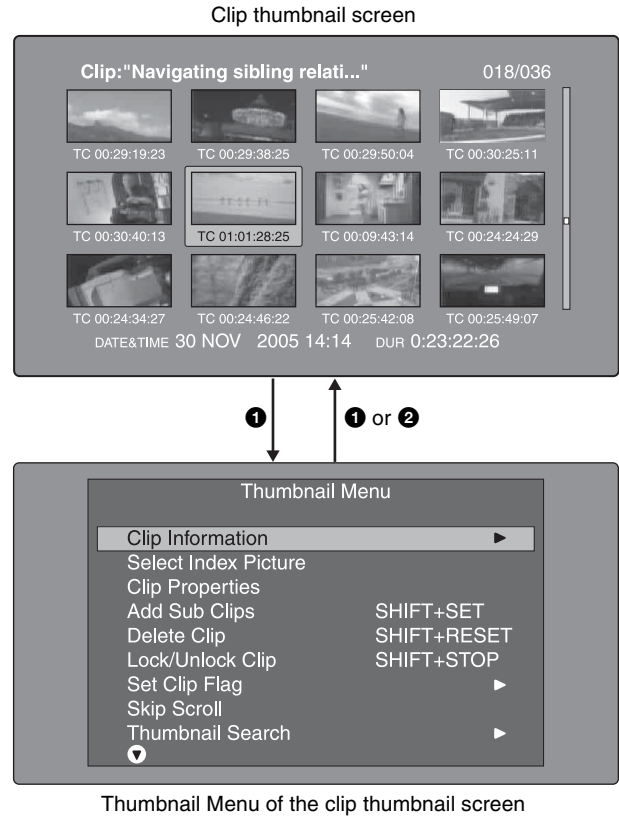
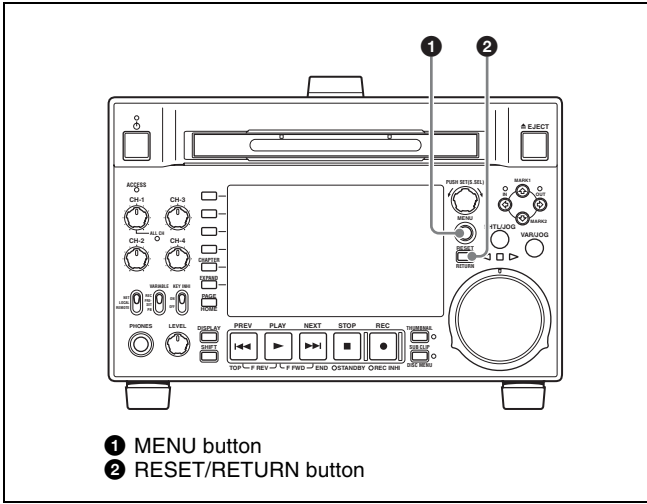

Shortcut operations

Shortcut button names are displayed next to the menu items of commands that have shortcuts (see page 103).

Note

Shortcuts displayed within parentheses should be used with all menus closed.

Thumbnail Menu submenus

- The Thumbnail Search Menu contains the basic commands for thumbnail searches.
- The Thumbnail View Menu contains the basic commands for moving to other menus.

Disc Menu

The Disc Menu allows you to do the following.

Item	Operation/Setting
Load Clip List	Load clip list into this unit's memory.
Save Clip List	Save a clip list on the disc under its current name, overwriting the old contents.
Save Clip List as...	Save a clip list on the disc under a new name.
Delete Clip List	Delete a clip list from the disc.
Clear Clip List	Clear the current clip list from the unit's memory.
Load Planning Metadata/Select Drive	Select a media disc or drive and load planning metadata into this unit's memory.
Planning Metadata Properties	Display the properties of the currently loaded planning metadata.
Clear Planning Metadata	Clear the currently loaded planning metadata from the unit's memory.

Item	Operation/Setting	
Lock or Delete All Clips	Sub-Item	
	Lock All Clips	Lock all clips.
	Unlock All Clips	Unlock all clips.
	Delete All Clips	Delete all clips.
Disc Properties	Display the properties of the currently loaded disc. Or edit the user disc ID, title 1, and title 2.	
Format Disc	Format (initialize) the currently loaded disc.	
Download Clip via Direct FTP	Used to send clip to and from remote devices and remote computers.	
Settings	Sub-Item	
	SET Key on Thumbnail	Selects the behavior of the unit when the PUSH SET(S.SEL) knob is pressed with one thumbnail selected. Cue up & Still: Cue up the selected thumbnail. Cue up & Play: Cue up and play the selected thumbnail.
	Sort Clip List by...	Selects a method to sort the clip list. Name (A-Z): Sort in ascending alphabetic order. Date (Newest First): Sort by date and time of creation, newest clip list first.
	Sort Planning Metadata by...	Selects a method to sort the planning metadata. Name (A-Z): Sort in ascending alphabetic order. Date (Newest First): Sort by date and time of creation, newest planning metadata first.
	Display Title	Selects whether to display clip and clip list titles. On: Title1 "title1": Display the title in the following order of priority: Title1, Title2, Clip name or Clip list name. On: Title2 {title2}: Display the title in the following order of priority: Title2, Title1, Clip name or Clip list name. Off: Do not display the title. Always display the clip name or clip list name.
	Planning Clip Name in Clip Info. Area	Selects whether to display in the video monitor screen the title contained in a planning metadata file that is loaded into this unit. Off: Do not display title. ASCII Clip Name: Display title in ASCII format. Clip Name: Display title in UTF-8 format.
	Disable "Format Disc"	Selects whether to disable the Format Disc command. Disable: Disable the command. Enable: Enable the command.
	Select Font	Selects the language (font) used to display clip names, clip list names, and title2 clip titles.
	Select USB Keyboard Language	Selects a language of the USB keyboard used on the software keyboard.
Select Mouse Pointer Speed	Selects the speed of the USB mouse pointer used on the software keyboard from the following values. 5 Fast/4/3 Middle/2/1 Slow	

To display the Disc Menu

To display the Disc Menu, press the SUB CLIP/DISC MENU button with the SHIFT button held down in one of the following screens.

- Clip thumbnail screen
- Clip list thumbnail screen
- Clip playback screen
- Clip list playback screen

To return to the original screen, press the RESET/RETURN button.

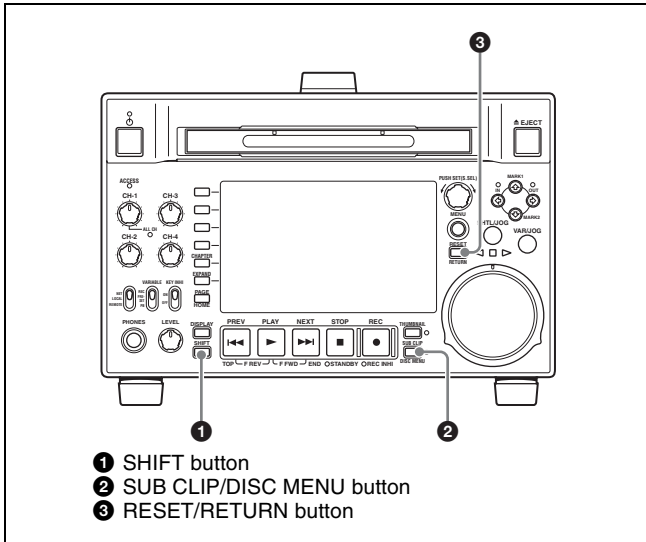

Clip list thumbnail screen



1+2
3

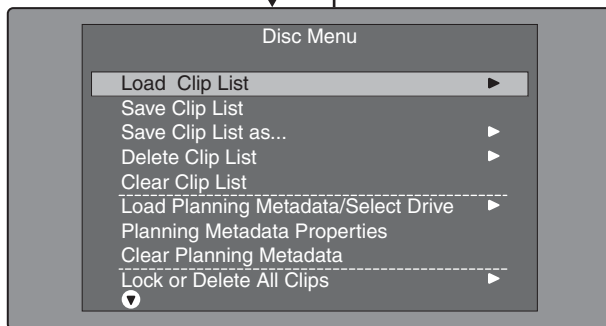

GUI screen operations

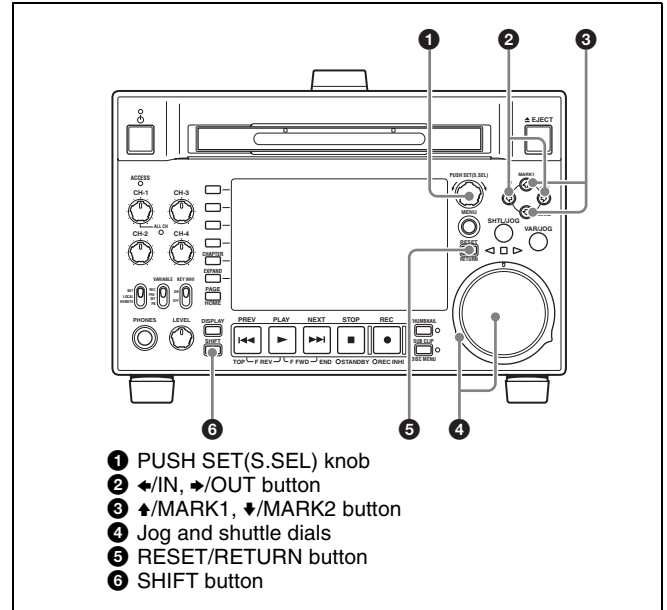

To select items

Do one of the following to select thumbnails, menu items, timecode digits, and other items.

- Turn the PUSH SET(S.SEL) knob.
- Turn the jog or shuttle dial.
- Press the </MARK1, >/MARK2, </IN or >/OUT button.
- Press the PREV or NEXT button.
- With the SHIFT button held down, press the PREV or NEXT button (to move to the first or last item).
- With the SHIFT button held down, press the </MARK1 or >/MARK2 button (to move to the previous or next page).

To select multiple thumbnails

Do one of the following

- Turn the PUSH SET(S.SEL) knob with the SHIFT button held down.
- With the SHIFT button held down, press the </IN or >/OUT button.

To return to the previous screen

Press the RESET/RETURN button.

To move from a menu level to the next lower or higher menu level

For a menu item displayed together with < or >, you can move to the next lower or higher menu level by pressing the </IN or >/OUT button.

To scroll hidden parts of the string into view

When a ◀ or ▶ mark is displayed for an item, you can press the ◀/IN or ▶/OUT button to scroll the display by one character for each press.

The ▲/MARK1 and ▼/MARK2 buttons scroll the beginning and end of the string into view.

To increment and decrement numbers

Do one of the following.

- Press the ▲/MARK1 or ▼/MARK2 button.
- Turn the PUSH SET(S.SEL) knob.
- Turn the jog dial.

To confirm selections

Press the PUSH SET(S.SEL) knob.

Thumbnail Operations

You can use thumbnail screens to display clip information and to find, protect, and delete clips. The thumbnails provide visual confirmation of these and other operations.

Selecting thumbnails

The thumbnail selection frame (*see page 68*) indicates the currently selected thumbnail.

To move the thumbnail selection frame

Turn the PUSH SET(S.SEL) knob.

To skip quickly through thumbnails (Skip Scroll function)

When you have a large number of thumbnails, like in expand thumbnail screen, you can use the Skip Scroll function to skip through them quickly.

See page 73 for more information about operations in thumbnail screens.

- 1 In the screens like clip thumbnail screen or expand thumbnail screen, display the Thumbnail Menu.
- 2 Select Skip Scroll, and then press the PUSH SET(S.SEL) knob.

A small popup window appears on the scrollbar to indicate the position of the currently selected thumbnail within the set of all thumbnails.



- 3 Turn the PUSH SET(S.SEL) knob.

The current position moves by an amount equal to $\frac{1}{10}$ of the total number of thumbnails.

When you reach a point that is close to the thumbnail you want, turn the jog dial to move the selection frame in units of 1 thumbnail.

4 Press the PUSH SET(S.SEL) knob at the new position.

The thumbnail at the position indicated in the small popup window appears in a thumbnail screen like the following ¹⁾.

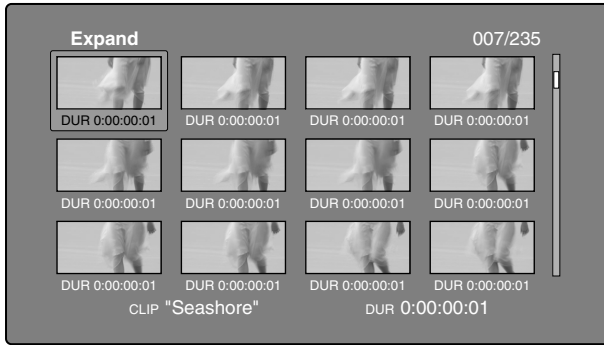

1)Expand thumbnail screen

To select multiple thumbnails

Move the selection frame to the first thumbnail that you want to select. Then, with the SHIFT button held down, turn the PUSH SET(S.SEL) knob.

To cancel the multiple selection, move the selection frame without the SHIFT button held down.



Searching with thumbnails

By using the thumbnails that appear in the various thumbnail screens, you can easily cue up and play clips and sub clips.

Using thumbnails to find clips

The clip thumbnail screen displays thumbnails of all clips recorded on the disc. You can use this screen to cue up the selected clip and to carry out playback (*see page 77*).

See “Selecting thumbnails” (page 74) for more information.

Using the expand function to find scenes

The expand function allows you to divide a selected clip into equally sized blocks, and to display thumbnails of the

first frame in each block. This is a quick and efficient way to review the selected clip and search for target scenes. You can specify 12, 144, or 1728 divisions.



Note

The maximum number of blocks may be other than 1728 when the recorded duration of the clip is short. In this case, the frame interval of expanded thumbnails is fixed at 1 frame. This allows you to view expanded thumbnails at equal intervals.

See page 73 for more information about thumbnail screen operations.

- 1 In the clip thumbnail screen, select the thumbnail of the clip that contains the scene you want to find.
- 2 Press the EXPAND button.

The selected clip is divided into 12 blocks, and a list appears in the expand thumbnail screen (*see page 69*) with the first frame of each block displayed as a thumbnail.

- 3 Select the thumbnail that you want to expand further.
- 4 Repeat steps 2 and 3 up to 2 times, as required.

Note

Thumbnails cannot be further expanded when they already have the minimum duration (1 frame).

To return to the previous expansion level

Press the EXPAND button with the SHIFT button held down.

To display the expand thumbnail screen of the previous or next clip

With the expand thumbnail screen still active, press the PREV button or the NEXT button.

Using the chapter function to find scenes

Chapters are the sections between the shot marks, Rec Start marks, and other essence marks.

Rec Start essence marks are set automatically at the start of recording, but shot marks can be set at any scene during recording or playback.

The chapter function allows you to display thumbnails of the chapters in a clip.

See “To set shot marks” (page 55) for more information.

See page 73 for more information about thumbnail screen operations.

- 1 In the clip thumbnail screen, select the thumbnail of a clip with chapters set.

The “S” mark appears on the thumbnails of clips with chapters set.

- 2 Press the CHAPTER button.

The chapter thumbnail screen (see page 69) appears, with thumbnails of the frames where chapters are set.

The “S1”, “S2”, and “RS” marks on the thumbnails indicate frames where Shot Mark1, Shot Mark2, and Rec Start essence marks are set.

To delete the shot mark at a chapter position

You can delete the shot mark (Shot Mark0 to 9) at the chapter position in the chapter thumbnail screen. (Rec Start cannot be deleted.)

- 1 In the chapter thumbnail screen, select the thumbnail for the frame whose shot mark you want to delete.
- 2 Display the Thumbnail Menu.
- 3 Select Delete Essence Mark.

A message appears asking if you are sure that you want to delete the shot mark.

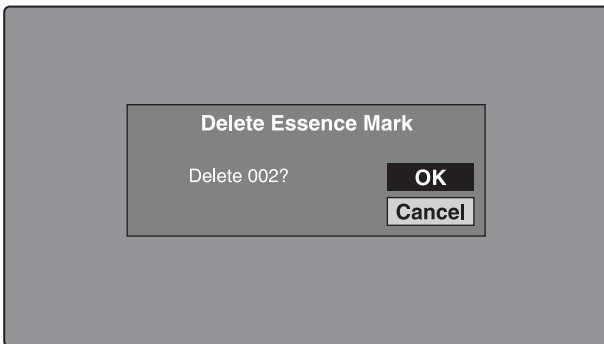

- 4 Select OK to delete the mark, or Cancel to cancel the deletion, and then press the PUSH SET(S.SEL) knob.

To adjust the position of shot marks at chapter positions

You can use the chapter thumbnail screen to adjust the position of shot marks (Shot Mark0 to 9) at chapter positions. (The positions of Rec Start essence marks cannot be adjusted.)

- 1 In the chapter thumbnail screen, select the thumbnail of the shot mark whose position you want to adjust.

- 2 Display the Thumbnail Menu.

- 3 Select Move Essence Mark.

The Move Essence Mark screen is displayed.

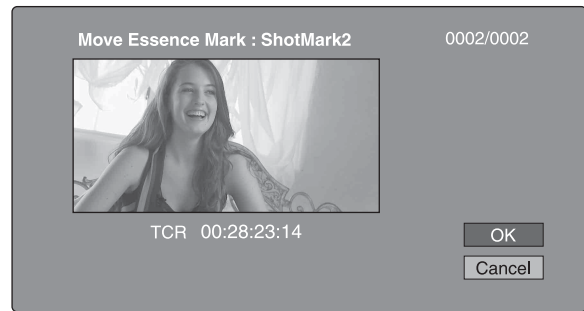

You can perform playback and searches in this screen.

- 4 Use the PLAY button or jog dial to display the frame you want.

- 5 Select OK, and then press the PUSH SET(S.SEL) knob.

To display the chapter thumbnail screen of the previous or next clip with chapters

With the chapter thumbnail screen still active, press the PREV button or the NEXT button.

The unit searches in the reverse or forward direction for the next clip with chapters, beginning with the previous or next clip.

Using essence marks to find scenes

See page 73 for more information about thumbnail screen operations.

- 1 In the clip playback screen or the clip thumbnail screen, press the THUMBNAIL button with the SHIFT button held down.

The Select Essence Mark screen appears.

The names of essence marks that are not recorded on the disc are displayed in gray.

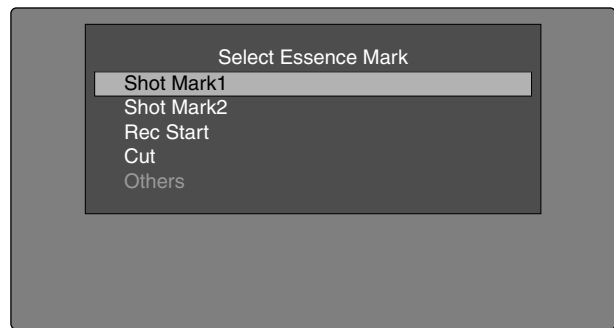

If planning metadata with user-defined essence mark has been loaded

You can select user-defined essence marks (*see page 93*).

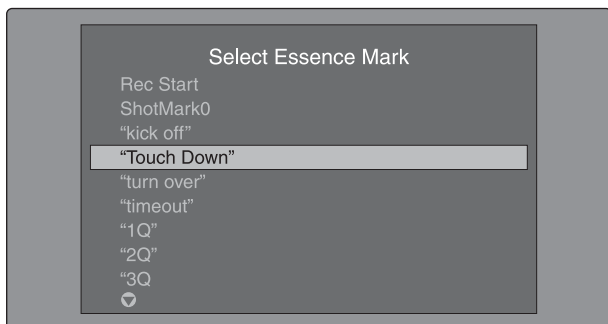

- 2 Select the essence mark that you want, and then press the PUSH SET(S.SEL) knob.

The essence mark thumbnail screen displays a list of frames where the selected essence mark is set.

To switch directly to the Rec Start essence mark thumbnail screen

Before starting, set setup menu item 153 FIND MODE to “clip & rec start mark”.

By pressing the DISPLAY button in the clip thumbnail screen, you can switch directly to the Rec Start essence mark thumbnail screen. As long as the setting of setup menu item 153 does not change, the DISPLAY button switches between the clip thumbnail screen and the Rec Start essence mark thumbnail screen.

This setting allows you to use the DISPLAY button as a shortcut to Rec Start essence mark thumbnail screen, which is convenient for checking start points in clip recorded with the Clip Continuous Rec function. Also, when the Rec Start essence mark thumbnail screen is displayed, each press of the THUMBNAIL button switches between that screen and the clip playback screen (Resume function). In the clip playback screen, the PREV and NEXT buttons jump to the previous or next recording start points.

Note

The DISPLAY button does not switch to the Rec Start essence mark thumbnail screen from the expand thumbnail screen or the chapter thumbnail screen.

Playing the scene you have found

After finding a clip with one of the methods explained in the previous section, “Searching with thumbnails” (*see page 75*), you can cue up and play the clip that you have found.

To search for a thumbnail position and cue it up

See page 73 for more information about GUI screen operations.

- 1 Select the thumbnail that you want to cue up.

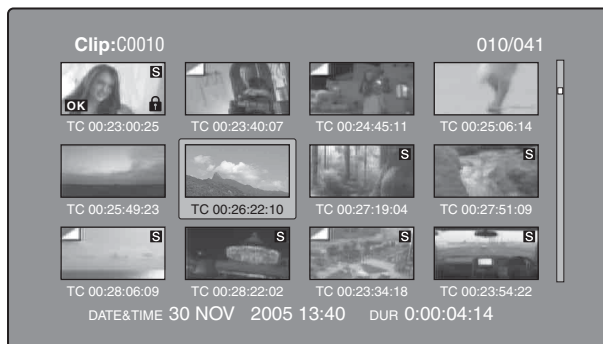

- 2 Press the PUSH SET(S.SEL) knob.

To play clips with the PUSH SET(S.SEL) knob

In the Disc Menu, set Settings >SET Key on Thumbnail to “Cue up & Play”. Playback begins from the selected frame when you press the PUSH SET(S.SEL) knob, in the same way as when you press the PLAY button.

To search for a thumbnail position and play from there

See page 73 for more information about GUI screen operations.

- 1 Select the thumbnail that you want to play.
- 2 Press the PUSH SET(S.SEL) button.



Selecting clips by type (Filter Clips function)

You can select clips of a certain type from among all of the clips on a disc (Filter Clips function). For example, you can do the following.

- Select clips in a certain video format from a disc that contains clips in different video formats.
- Select clips that have been set “NG” as a clip flag, and delete all of those clips in one operation.
- Select only clips that have been recorded on the basis of a specified planning metadata entry, and transfer those clips to an external device using the Direct FTP function.

To filter clips

See page 73 for more information about thumbnail screen operations.

- 1 Display the clip thumbnail screen.
- 2 If you want to select clips by video format, select the thumbnails of clips in that format.
- 3 Display the Thumbnail menu.
- 4 Select “Filter Clips”, and then press the PUSH SET(S.SEL) knob.

The Filter Clips screen appears.

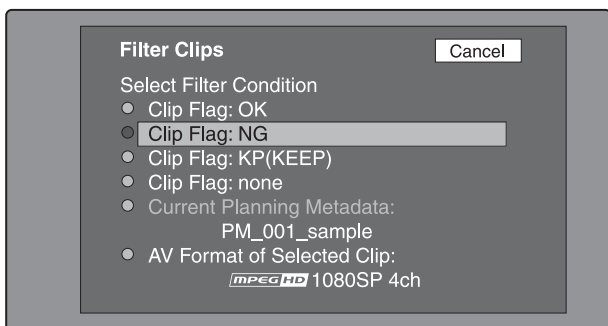

- 5 Select the clip filtering condition.

Item name	Filtering condition
Clip Flag: OK	Clip flag set in the clip (OK/NG/KP(KEEP)/none)
Clip Flag: NG	
Clip Flag: KP(KEEP)	
Clip Flag: none	
Current Planning Metadata	Clips that have been recorded according to the instructions in the currently loaded planning metadata
AV Format of Selected Clip	Video format of the selected clips

- 6 Press the PUSH SET(S.SEL) knob.

A filter thumbnail screen appears, showing only clips that meet the specified condition. The filtering condition appears at the lower left of the screen.



- 7 If you want to filter the clips again with a different filtering condition (to narrow down the filtering results), repeat steps 2 to 6. (The command name selected in step 4 changes to Filter Clips(Narrowing).)

To play selected clips continuously

Register all of the filtered clips in an automatically generated clip list, and play the clip list.

- 1 Display the Thumbnail Menu in the filter thumbnail screen.
- 2 Select “Copy to Clip List”, and then press the PUSH SET(S.SEL) knob.

A clip list thumbnail screen appears, showing filtered clips that have been registered in the clip list.

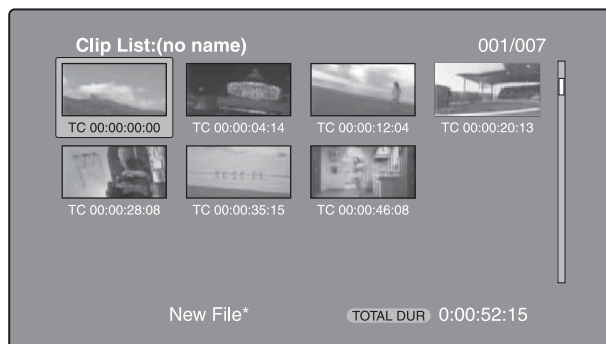

- 3 Press the PLAY button.

The screen changes to the clip playback screen, and playback starts.

Operations on filtering results

You can use the Thumbnail Menu in the filter thumbnail screen to perform the following operations.

Item name	Function
Clip Information	Select the information to be displayed at the bottom of the thumbnails.
Lock or Delete All Filtered Clips >Lock All Filtered Clips	Lock all of the filtered clips.

Item name	Function
Lock or Delete All Filtered Clips >Unlock All Filtered Clips	Unlock all of the filtered clips.
Lock or Delete All Filtered Clips >Delete All Filtered Clips	Delete all of the filtered clips.
Filter Clips(Narrowing)	Narrow down the filtering results.
Copy to Clip List	Copy all of the filtered clips to a new clip list.
Upload Clips via Direct FTP	Transfer all of the filtered clips to an external device via a network.

To display clip filtering conditions as Title2 titles

For clip lists created with the Copy to Clip List command, you can display the clip filtering conditions as Title2 titles. When Settings >Display Title in the Disc Menu is set to "On: Title2 {title2}", the clip filtering conditions are displayed automatically in screens such as the Load Clip List screen.

Selecting the information displayed on thumbnails

You can select the information to be displayed at the bottom of the thumbnails in thumbnail screens.

See page 73 for more information about thumbnail screen operations.

- 1 Display the Thumbnail Menu in the clip thumbnail screen.
- 2 Select Clip Information.

A window appears in which you can select the information to display.

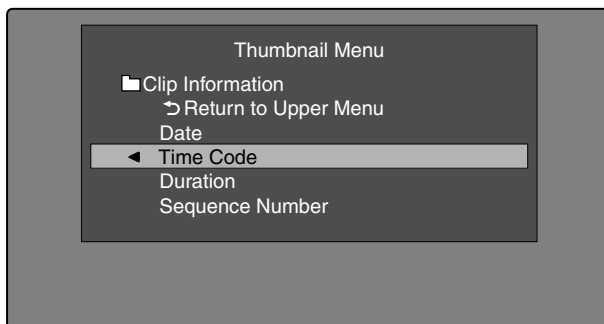

- 3 Select the items that you want to display.

Date: Date and time of creation, or date and time of the more recent modification

Time Code: Timecode of first frame

Duration: Playback time

Sequence Number: Thumbnail sequence number
Return to Upper Menu: Returns to the Thumbnail Menu

The selected information will appear at the bottom of the thumbnails when you display a thumbnail screen.

Changing clip index pictures

The clip thumbnail screen displays thumbnails as index pictures for clips. Normally the index picture is the first frame in a clip, but you can set any frame in the clip as the index picture.

Note

You can only change index pictures from the clip thumbnail screen. The thumbnails shown in the clip list thumbnail screen, the expand thumbnail screen, and the chapter thumbnail screen cannot be changed.

To select a clip index picture while viewing the video

See page 73 for more information about thumbnail screen operations.

- 1 In the clip thumbnail screen, select the thumbnail of the clip whose index picture you want to change.
- 2 Display the Thumbnail Menu.
- 3 Select Select Index Picture.
Select Index screen appears.



You can play and search with this screen.

- 4 Select a frame with the PLAY button or the jog dial.
- 5 Select OK, and then press the PUSH SET(S.SEL) knob.

To select index pictures by using the expand and chapter functions

After using the expand function (*see page 75*) or chapter function (*see page 75*) to find a frame, you can set that frame as the index picture of the clip.

The following example explains how to do so from the expand thumbnail screen.

See page 73 for more information about thumbnail screen operations.

- 1 In the expand thumbnail screen, select the thumbnail to set as the index picture.
- 2 Display the Thumbnail Menu.
- 3 Select Set Index Picture.

A message appears asking you to confirm that you want to set the current frame as the index picture.

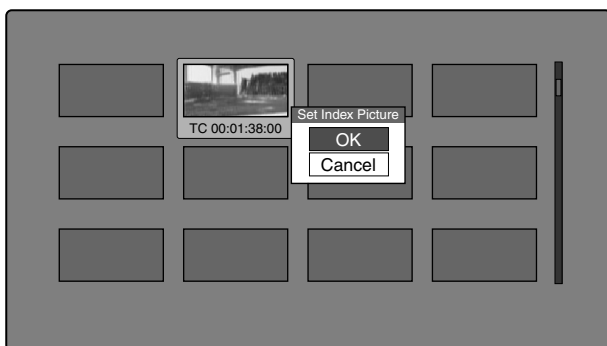

- 4 Select OK, and then press the PUSH SET(S.SEL) knob.

After pressing the RESET/RETURN button to return to the clip thumbnail screen, check to make sure that the newly selected frame is displayed as the index picture.

Checking clip properties

You can check clip properties such as the title, timecode, duration, date and time of creation, and date and time of the more recent modification.

See page 73 for more information about thumbnail screen operations.

- 1 Display the Thumbnail Menu in the clip thumbnail screen.
- 2 Select Clip Properties.

The Clip Properties screen appears.

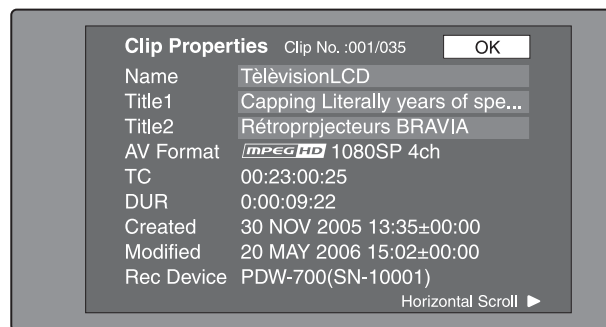

Clip No.: Clip number/total number of clips

Name: Clip name ¹⁾

Title1: Title1

Title2: Title 2 ¹⁾

AV Format: Recording format

TC: Timecode of first frame

DUR: Recording time

Created: Date and time of creation

Modified: Date and time of most recent modification

Rec Device: Name of device that created clip (product number)

¹⁾When the unit's area of use (UC/J MODEL SELECT) (*see page 33*) is set to "UC", titles can be displayed in European languages.

To scroll hidden parts of the string into view

When a ◀ or ▶ mark is displayed for an item, you can press the ◀/IN or ▶/OUT button to scroll the display by one character for each press.

The ▲/MARK1 and ▼/MARK2 buttons scroll the beginning and end of the string into view.

To display the properties of the previous or the next clip

Press the PREV button or the NEXT button.

To return to the clip thumbnail screen

Press the PUSH SET(S.SEL) knob.

To edit clip information

You can edit the name, ¹⁾ title1, and title 2 of a clip by using a software keyboard.

¹⁾ The "NAMING FORM" sub-item on setup menu item 036 must be set to "free" (*see page 125*).

Notes

- The only characters that can be entered are the alphanumeric characters and characters in the fonts supported by this version of the unit's firmware. Japanese kanji cannot be entered.
- Names and titles must be within the specified character length limits.
- Some symbols cannot be used in clip names. The keys for those symbols are disabled when you are editing a clip name.

See page 73 for more information about GUI screen operations.

- 1 In the Clip Properties screen, turn the PUSH SET(S.SEL) knob to select the item you want to edit (Name, Title1¹, or Title2).

1)Only ASCII characters can be used for Title1.

- 2 Press PUSH SET(S.SEL) knob.

An input screen appears for the selected item. (If the area of use setting is “UC” (for regions outside Japan), a keyboard appears that corresponds to the font selected with Disc Menu item Settings >Select Font.) A Japanese keyboard appears if the area of use setting is “J” (for Japan.)

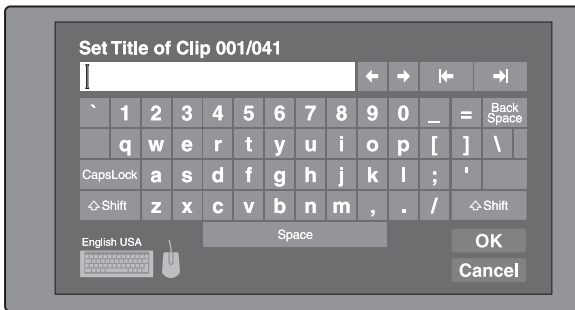

- 3 Edit the string in the edit box.

To enter characters

Use the ▲/MARK1, ▼/MARK2, ◀/IN or ▶/OUT buttons or turn the PUSH SET(S.SEL) knob to select a key, and then press the PUSH SET(S.SEL) knob.

Functions of special keys

Key	Function
◀, ▶	Move the cursor one character forward or back.
⏪, ⏩	Move the cursor to Home or End position.
Back Space	Deletes the character in front of the cursor.
CapsLock	Turns the Shift key on permanently (until pressed again), and enables input of capital letters and symbols.
⇧ Shift	Enables input of capital letters and symbols. Turns off after entry of one character.
Enter	Confirms the edit and enables the OK and Cancel buttons.

- 4 Select OK, and then press the PUSH SET(S.SEL) knob.

You return to the Clip Properties screen, and the results of the editing are reflected in the clip information.

To enter text using a USB keyboard or USB mouse

You can connect a Windows USB keyboard or a Windows USB mouse¹⁾ to the MAINTENANCE connector (see page 29), and use them together with the software keyboard to enter text.

Connect a Japanese keyboard if you have set the area of use to “J” (for Japan).²⁾

Connect a keyboard that corresponds to the font selected with Disc Menu item Settings >Select Font if you have set the area of use to “UC” (for regions outside Japan).

- 1) Some USB keyboards or USB mice may not be recognized. In this case, the message “Unknown USB” appears.
- 2) Only ASCII characters can be entered from a Japanese keyboard.

To change the display language (font) for clip names, clip list names, and title2 clip titles: Select one of the following languages (fonts) with the Disc menu item Settings >Select Font.

- European Alphabet: The keyboard language can be selected with the Disc Menu item Settings >USB Keyboard Language (see following section).
- Korean: The Korean keyboard is selected automatically. You can enter Hangeul characters if you have connected a Korean USB keyboard.
- Simplified Chinese: The keyboard layout is identical to that of the English [United States] keyboard. Only ASCII characters can be entered.
- Traditional Chinese: The keyboard layout is identical to that of the English [United States] keyboard. Only ASCII characters can be entered.

To change the keyboard language: Select the desired language from the following values using Settings >Select USB Keyboard Language in the Disc Menu.

- English [United Kingdom]
- English [United States]
- French [France]
- German [Germany]
- Italian [Italy]
- Polish (Programmers) [Poland]
- Russian [Russia]
- Spanish [Spain]

See “List of Supported USB Keyboards” (page 175) for the characters that can be input in each language.

Note

The keyboard language cannot be changed in the following cases.

- When the area of use is set to “J” (for Japan).
- When the area of use is set to “UC” (for regions outside Japan), and the Disc Menu item Settings >Select Font is set to “Korean”, “Simplified Chinese”, or “Traditional Chinese”.

The keyboard icon on the software keyboard is highlighted when a USB keyboard has been recognized and enabled for use with this unit, and the mouse icon is highlighted and a mouse pointer appears when a USB mouse has been enabled.

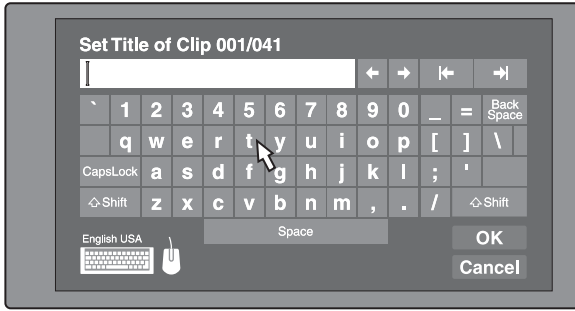

Notes

- Use the proper keyboard for the area of use. Some characters may not be entered correctly if you use a keyboard designed for use in another area.
- It is not possible to enter Japanese, even on a Japanese keyboard.

USB keyboard special functions keys

In addition to the special function keys of the software keyboard, you can use the following special function keys on a USB keyboard.

Key	Function
↑, ↓	When the cursor is in an edit box: Move the cursor to the start or end. When “OK” or “Cancel” has the focus: Moves the focus between “OK” and “Cancel”.
Delete	Deletes the character after the cursor.
Shift + ←, Shift + →	Selects the string before or after the cursor.
Ctrl + C, X, V, A, Z	Ctrl + C: Copies the selected string. Ctrl + X: Cuts the selected string. Ctrl + V: Pastes a copied or cut string. Ctrl + A: Selects the entire string. Ctrl + Z: Undoes the immediately preceding operation.
Enter	When the cursor is in an edit box: Moves the focus to OK. When OK or Cancel has the focus: Exits the software keyboard.
Esc	When the cursor is in an edit box, moves the focus to Cancel.
Tab	Moves the focus between OK and Cancel.

USB mouse functions

You can use the mouse to move the cursor on the software keyboard. You can also left click on a key to enter the character for that key.

To change the speed of the mouse pointer: Select the desired speed using Settings >Select Mouse Pointer Speed in the Disc Menu. Select the speed that works best with the connected mouse.

To exit the software keyboard from a USB keyboard

- 1 With the cursor in an edit box, press the Enter key to move the focus to OK.
- 2 Do one of the following.
 - To confirm the edit and then exit the software keyboard:** While OK is selected, press the Enter key.
 - To discard the edit and then exit the software keyboard:** On the USB keyboard, press the ↓ key or the Tab key to move to Cancel, and then press the Enter key.
 - To continue editing:** Press any key except the Enter key, the Esc key, and the Tab key.

Setting clip flags

You can set three types of clip flags (OK/NG/KP (KEEP)) during recording or playback. Setting these flags in each clip that you record makes it easy for editors and other colleagues to find and select the clips that they need.

See page 73 for more information about thumbnail screen operations.

- 1 In the clip thumbnail screen, select the thumbnail of the clip where you want to set a flag.
- 2 Display the Thumbnail Menu.
- 3 Select Set Clip Flag.

The clip flag setting screen appears.

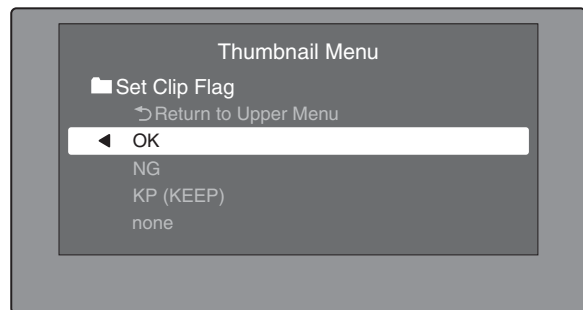

- 4 Select the clip flag that you want to set (OK/NG/KP (KEEP)).

A clip flag icon (*see page 68*) appears for clips that have clip flags set.

To clear clip flags

Carry out steps **1** to **3**, selecting a clip that has a flag set, and then select “none” in step **4**.

You can also use CLIP FLG on page P7 OTHER of the function menu to set and clear clip flags (see page 51).

Locking (write-protecting) clips

In a clip thumbnail screen, you can lock the selected clips so that they cannot be deleted or altered.

Locking prevents the following operations on clips.

- Deletion
- Changing the index picture
- Adding and deleting shot marks
- Setting and clearing clip flags

Notes

- Locked clips are deleted along with other clips when a disc is formatted.
- Clips cannot be locked or unlocked when the write inhibit tab of the disc is set to the recording disabled position, or when REC INH in the HOME page of the function menu is set to ON.

To lock clips

See page 73 for more information about thumbnail screen operations.

- 1** In the clip thumbnail screen, select the thumbnails of the clips that you want to lock.
- 2** Display the Thumbnail Menu.
- 3** Select Lock/Unlock Clip.
- 4** Press the PUSH SET(S.SEL) knob.

A lock icon (see page 69) appears on the thumbnail of the locked clips.

In step **1**, you can also perform a shortcut operation by pressing the STOP button with the SHIFT button held down.

To lock all clips

- 1** Display the Disc Menu.
- 2** Select Lock or Delete All Clips, and then select Lock All Clips.
A message appears asking you to confirm locking all clips.

- 3** Select OK to lock all clips or Cancel to cancel it, and then press the PUSH SET(S.SEL) knob.

To unlock a specific clip

See page 73 for more information about thumbnail screen operations.

- 1** In the clip thumbnail screen, select the thumbnail of the clip that you want to unlock.
- 2** Display the Thumbnail Menu.
- 3** Select Lock/Unlock Clip.

A message appears asking you to confirm the unlocking.

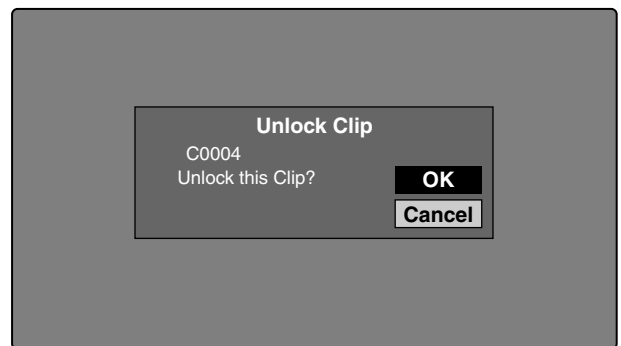

- 4** Select OK, and then press the PUSH SET(S.SEL) knob.

In step **1**, you can also perform a shortcut operation by pressing the STOP button with the SHIFT button held down.

To unlock all clips

- 1** Display the Disc Menu.
- 2** Select Lock or Delete All Clips, and then select Unlock All Clips.

A message appears asking you to confirm that you want to unlock all clips.

- 3** Select OK to execute the unlock, or Cancel to cancel it, and then press the PUSH SET(S.SEL) knob.

Deleting clips

You can delete clips while checking their contents.

Notes

- Clips cannot be deleted when the write inhibit tab of the disc is set to the recording disabled position, or when

REC INH in HOME page of the function menu is set to ON.

- Locked clips cannot be deleted.
- If a deletion target clips is referenced by clip lists on the disc, all of those clip lists are deleted as well.
- If a deletion target clip is referenced in the current clip list, only those referencing sub clips are deleted at the same time as the deletion target clip.

See page 73 for more information about thumbnail screen operations.

- 1 In the clip thumbnail screen, select the thumbnail of the clip that you want to delete.
- 2 Display the Thumbnail Menu.
- 3 Select Delete Clip.

A window appears asking you to confirm the deletion. The window displays thumbnails of four frames from the target clip (the first frame, two intermediate frames, and the last frame), along with the name, title 1, date of creation, and duration of the clip.

One of the following messages also appears, depending on whether the clip is referenced in a clip list.

- **When the clip is not referenced in a clip list:** “Delete Clip”
- **When the clip is referenced in a clip list:** “Delete Clip & Clip List” (All clip lists that reference the target clip are deleted along with the clip.)

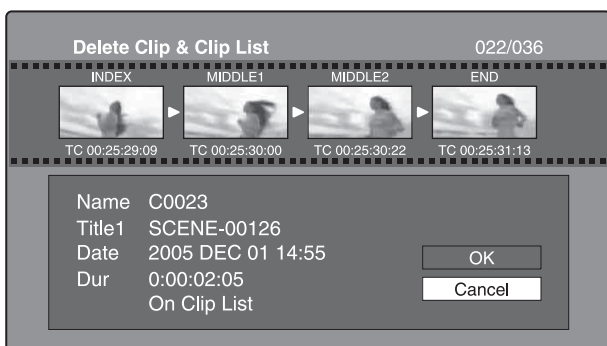

- 4 Select OK, and then press the PUSH SET(S.SEL) knob.

The selected clip is deleted, and you return to the clip thumbnail screen.

In step 1, you can also perform a shortcut operation by pressing the RESET/RETURN button with the SHIFT button held down.

To delete all clips

- 1 Display the Disc Menu.

- 2 Select Lock or Delete All Clips, and then select Delete All Clips.

A message appears asking you to confirm that you want to delete all clips.

- 3 Select OK to execute the deletion, or Cancel to cancel it, and then press the PUSH SET(S.SEL) knob.

Note

Locked clips cannot be deleted.

Scene Selection (Clip List Editing)

What is scene selection?

Scene selection is a function which allows you to select material (clips) from the material recorded on a disc and perform cut editing. You can do this by operating on this unit only.

- Scene selection is a convenient way to perform cut editing in the field and in other offline situations.
- In scene selection you create a clip list (editing data). Since the material itself is not affected, you can repeat this any number of times.
- You can play back the edit list created by scene selection on this unit.
- In scene selection you can add whole clips or add parts of a clip. You can add scenes using chapters, change the playback sequence, and amend or delete In and Out points. All of these operations can be carried out easily on this unit.
- Clip lists (editing data) created with the scene selection function can be used on XPRI and other full-feature nonlinear editing systems.

Clips

Material recorded with this unit is managed in units called clips. A clip contains the material from a recording start point to a recording end point.

Clips have numbers beginning with C, for example C0001.

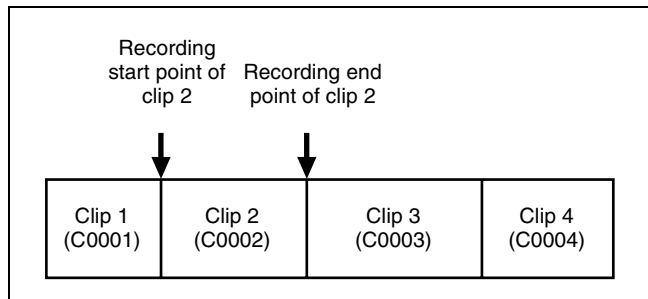

You can also assign titles to your clips and use the titles to manage them, instead of the clip numbers. For more information, “Assigning user-defined clip titles” (page 107).

Clip lists

You can use the scene selection function to select clips from the clips saved on a disc and create a cut edit list called a “clip list”.

Clip lists have numbers beginning with E, for example E0001. Up to 99 clip lists can be saved on a disc.

Sub clips (clips in clip lists)

Clips (or parts of clips) that have been added to a clip list are called “sub clips”. Sub clips are virtual editing data that specify ranges in the original clips. You can use them without modifying the original data.

The following figure illustrates the relation between clips and sub clips.

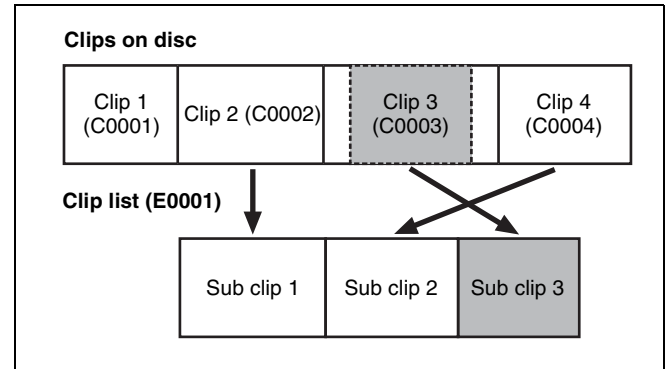

In the above example, the whole of clip 2 has been added as sub clip 1, and the whole of clip 4 has been added as sub clip 2.

Sub clip 3 is part of clip 3. Therefore, when clip list E0001 is played back, clip 4 is played after clip 2, and then the part of clip 3 shown in gray color is played.

Clip list editing (current clip list)

To edit a clip list, you need to load the clip list from the disc into the unit’s internal memory.

The clip list which is currently loaded into the unit memory is called the “current clip list”.

The current clip list is always the target of sub clip creation and editing. Clip list playback also uses the current clip list.

After creating and editing a clip list, you need to save it to disc.

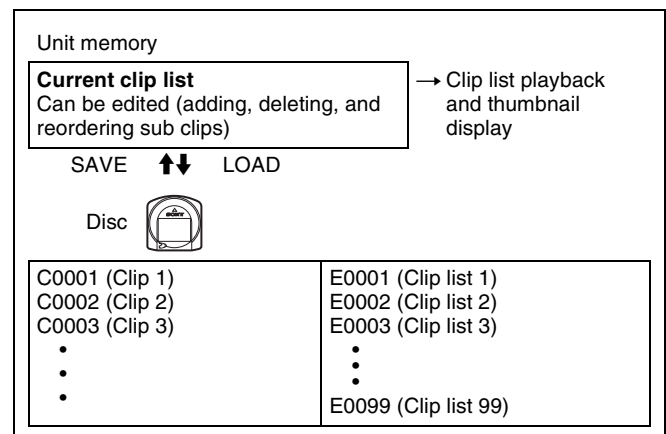

Clip list playback

Clips and clip lists are saved together on a disc.

To play a clip list, insert a disc into the unit, load the clip list that you want to play, and press the PLAY button. Clips are played according to the data in the clip list.

Creating and editing clip lists

The following table lists the steps in the creation and editing of clip lists with the scene selection function. To create a clip list, you always need to carry out the steps inside the heavy lines. Other steps can be carried out as required.

1	<p>Add sub clips: Use the Add Sub Clips command to add the clips you want to use to a clip list. You can add up to 300 sub clips to one clip list. This operation can be carried out in the following thumbnail screens.</p> <ul style="list-style-type: none"> • Clip thumbnail screen • Expand thumbnail screen • Chapter thumbnail screen • Clip list thumbnail screen
2	<p>Change the sub clip order: Use the Move Sub Clips command to change the order of sub clips in a clip list.</p> <p>Delete sub clips: Use the Delete Sub Clips command to delete specified sub clips from a clip list.</p> <p>Trim sub clips: Use the Trim Sub Clip command to adjust the In and Out points of a sub clip. This function can also be used to adjust the overall duration of the clip list.</p> <p>Set the start timecode: Use the Set Start Time Code command to set the timecode at the start of a clip list.</p>
3	<p>Play the clip list: Use the PLAY button and other playback controls to play the current clip list and check its contents.</p>
4	<p>Save the clip list: Use the Save Clip List or Save Clip List as... command to save the newly created clip list to the disc.</p>

To reedit clip lists on the disc

Use the Load Clip List command to load the clip lists you want to edit, and perform the steps **2** to **4** in the previous section.

You can also delete clip lists on the disc.

For details, see “Managing clip lists” (page 90).

Note

Clip lists can be created and edited even when the write inhibit tab of the disc is set to recording disabled, and when REC INH on the HOME page of the function menu is set to ON. However, if you need to save the clip list, set write inhibit tab and REC INH to enable recording before you create or edit the clip list.

To add sub clips

You can add sub clips to clip lists from with the clip thumbnail screen or the clip list thumbnail screen. However, you must use the clip list thumbnail screen to edit clip lists.

Adding sub clips from the clip thumbnail screen

The following procedure explains operations in the clip thumbnail screen. You can proceed in the same way in the expand thumbnail screen and the chapter thumbnail screen. Expanded blocks are added as sub clips in the expand thumbnail screen, and chapters are added as sub clips in the chapter thumbnail screen.

See page 73 for more information about thumbnail screen operations.

- 1** In the clip thumbnail screen, select the clip that you want to add as a sub clip (multiple selections possible).
- 2** Display the Thumbnail Menu.
- 3** Select Add Sub Clips, and then press the PUSH SET(S.SEL) knob.

The Add Sub Clip screen appears.

The clip(s) selected in step **1** appear in the upper part of this screen, and the clip list appears in the lower Scene Selection window. The I cursor in the Scene Selection window indicates the location where the currently selected sub clip(s) will be inserted.



To display the total duration after addition of the selected clip

Press the SHIFT button.

- 4** In the Scene Selection window, move the I cursor to the location where you want to insert the clip. (The existing thumbnails arrange themselves to the left and right of the I cursor.)
- 5** Press the PUSH SET(S.SEL) knob.

The selected clip is inserted as a sub clip and a “+” mark appears on the thumbnail in the Scene Selection window.

To check the addition results

Move the cursor.

- 6 Press the RESET/RETURN button.
This returns you to the Clip thumbnail screen.
- 7 Repeat steps 1 to 6 as required to add more clips.
- 8 Save the clip list (see page 90).

In step 1, you can hold down the SHIFT button when you press the PUSH SET(S.SEL) knob. This is a shortcut that displays the Add Sub Clip screen immediately. You can also save the clip list immediately in step 5 by executing the Save Clip List command in the Disc Menu.

Adding sub clips from the clip list thumbnail screen

See page 73 for more information about thumbnail screen operations.

- 1 Display the Thumbnail Menu.
- 2 Select Add Sub Clips, and then press the PUSH SET(S.SEL) knob.

The Clip List (Add) screen appears.

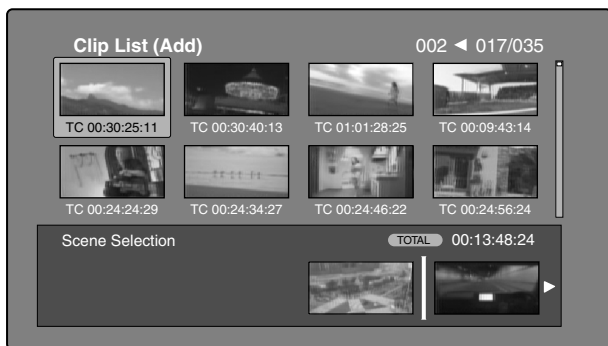

- 3 Select the sub clips that you want to add from the upper part of the screen (the part where 8 thumbnails are displayed, multiple selections possible).

To select from expanded thumbnails

Press the EXPAND button to display the expand thumbnail screen.

To select from chapter thumbnails

Press the CHAPTER button to display the chapter thumbnail screen.

- 4 Press the PUSH SET(S.SEL) knob.

The thumbnail selection is confirmed, and an I cursor appears at the bottom of the Clip List (Add) screen (in the Scene Selection window). The I cursor indicates

the location where the currently selected sub clips will be inserted.

To display the total duration after addition of the selected clips

Press the SHIFT button.

- 5 In the Scene Selection window, move the I cursor to the location where you want to insert the clip. (The existing thumbnails arrange themselves to the left and right of the I cursor.)
- 6 Press the PUSH SET(S.SEL) knob.
The sub clips are added at the I cursor position, and you return to the clip list thumbnail screen. You can check the results of the addition in that screen.
- 7 Repeat steps 1 to 6 as required to add more clips.
- 8 Save the clip list (see page 90).

In step 1, you can also perform a shortcut operation by pressing the PUSH SET(S.SEL) knob with the SHIFT button held down.

To add clips from the clip playback screen (quick insertion)

This method allows you to decide the range to use and add that range as a sub clip while viewing the video in the clip playback screen. It does not use GUI screens. You can do this during recording, playback (including pauses), and searches.

- 1 Find the point that you want to make the start point of the sub clip, and then press the PUSH SET(S.SEL) knob with the ◀/IN button held down.
An In point is set and the IN indicator lights.
- 2 Find the point that you want to make the end point of the sub clip, and then press the PUSH SET(S.SEL) knob with the ▶/OUT button held down.
An Out point is set and the OUT indicator lights. (This determines the range of the sub clip to be added.)

To check the timecode of the In point or Out point

Press the ◀/IN button or the ▶/OUT button.

To cue up the In point or Out point

Press the PREV button or the NEXT button with the ◀/IN button or ▶/OUT button held down.

To check the duration (time from In point to Out point)

Press the ◀/IN and ▶/OUT buttons at the same time.

To delete the In point or Out point

Press the RESET/RETURN button with the ◀/IN or ▶/OUT button held down.

- 3 With the SHIFT button held down, press the PUSH SET(S.SEL) knob.

A sub clip with the range specified in steps 1 and 2 is added to the end of the clip list.

When you specify a range that spans several clips

Sub clips are generated for each of the clips in the range.

To check the newly added sub clips

You can check the newly added sub clips by displaying the clip list thumbnail screen.

- 4 Repeat steps 1 to 3 as required to add more sub clips.
- 5 Save the clip list (*see page 90*).

To reorder sub clips**Note**

When this unit is in single clip playback mode (*see page 76*), only the selected sub clip can be played.

See page 73 for more information about thumbnail screen operations.

- 1 In the clip list thumbnail screen, select the thumbnails of the sub clips that you want to move (multiple selections possible).
- 2 Display the Thumbnail Menu.
- 3 Select Move Sub Clips, and then press the PUSH SET(S.SEL) knob.

The Clip List (Move) screen appears.

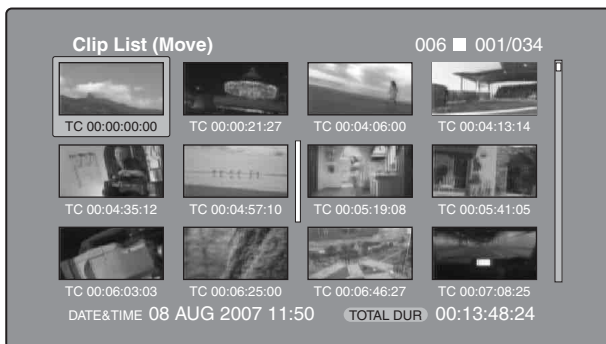

- 4 Move the I cursor to the point where you want to move the selected thumbnails.

- 5 Press the PUSH SET(S.SEL) knob.

The sub clips are moved to the I cursor position.

- 6 Repeat steps 1 to 5 as required.

- 7 Save the clip list (*see page 90*).

To adjust the In and Out points of sub clips (trim)

Proceed as follows to define the range of a scene by changing the positions of the In and Out points.

See page 73 for more information about thumbnail screen operations.

- 1 In the clip list thumbnail screen, select a thumbnail.
- 2 Display the Thumbnail Menu.
- 3 Select Trim Sub Clip, and then press the PUSH SET(S.SEL) knob.

The Clip List (Trim) screen appears.

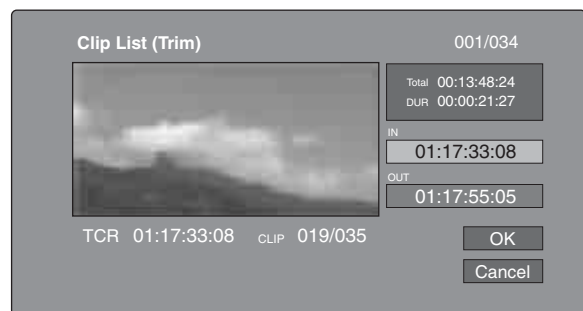

Like the clip playback screen, this screen allows you to play and search all clips on the disc.

To display a list of In and Out point operations that you can perform

Press the MENU button.

- 4 When you find the point that you want to make the start point, select "IN" and then press the PUSH SET(S.SEL) knob.

The timecode of the new In point appears in the timecode display, and the Total (total duration) and DUR (clip duration) displays are updated.

- 5 When you find the point that you want to make the end point, select "OUT" and then press the PUSH SET(S.SEL) knob.

The timecode of the new Out point appears in the timecode display, and the Total (total duration) and DUR (clip duration) displays are updated.

To cue up the In point or Out point

Display the Thumbnail Menu, select Cue up Inpoint or Cue up Outpoint, and then press the PUSH SET(S.SEL) knob.

To cancel the In point or Out point setting

Display the Thumbnail Menu, select Reset Inpoint or Reset Outpoint, and then press the PUSH SET(S.SEL) knob.

The In point or Out point setting returns to the previous value.

- 6** Select OK, and then press the PUSH SET(S.SEL) knob.
- 7** Repeat steps **1** to **6** as required.
- 8** Save the clip list (*see page 90*).

To delete sub clips

See page 73 for more information about thumbnail screen operations.

- 1** Select the clips to delete in the clip list thumbnail screen (multiple selections possible).
- 2** Display the Thumbnail Menu.
- 3** Select Delete Sub Clips, and then press the PUSH SET(S.SEL) knob.
A message appears asking you to confirm the deletion.
- 4** Select OK, and then press the PUSH SET(S.SEL) knob.
- 5** Repeat steps **1** to **4** as required.
- 6** Save the clip list (*see page 90*).

To play the clip list**Note**

When this unit is in single clip playback mode (*see page 62*), only the selected sub clip can be played.

See page 73 for more information about GUI screen operations.

To play using GUI screens

- 1** In the clip list thumbnail screen, select the thumbnail of the sub clip where you want to start play.

To start play from the start of the clip list

Select the thumbnail of the first sub clip.

- 2** Press the PUSH SET(S.SEL) knob.

To play using the clip list playback screen

- 1** Display the clip list playback screen.
- 2** Press the PREV button or the NEXT button to display the sub clip that you want to play.

To start play from the first sub clip

Press the SHIFT + PREV buttons to move to the start of the clip list.

- 3** Press the PUSH SET(S.SEL) knob.

To change the starting timecode of clip lists

The timecode of clip lists is continuous timecode, unrelated to the timecode of the original clips. By default the timecode (LTC) of the start of the clip list is 00:00:00:00, but it can be set to any value.

See page 73 for more information about thumbnail screen operations.

- 1** In the clip list thumbnail screen, display the Thumbnail Menu.
- 2** Select Set Start Time Code, and then press the PUSH SET(S.SEL) knob.

The Set Start Time Code screen appears.

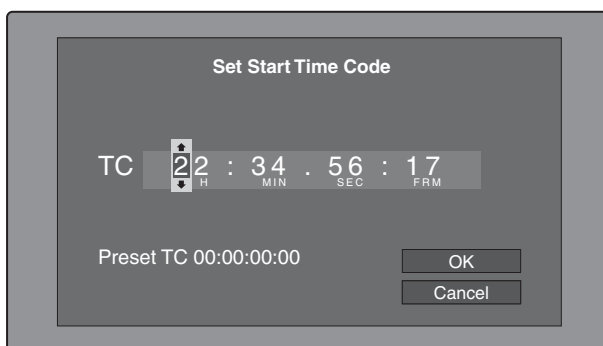

- 3** Press the ◀/IN or ▶/OUT button to select the digit that you want to change.
- 4** Turn the PUSH SET(S.SEL) knob or the jog dial to change the value of the digit.
- 5** Repeat steps **3** and **4** as required.

To reset the timecode to 00:00:00:00

Select Reset to Zero in the Thumbnail Menu, and then press the PUSH SET(S.SEL) knob.

To preset the frequently used timecode

Select Save Preset TC in the Thumbnail Menu, and then press the PUSH SET(S.SEL) knob.

The timecode set in steps 4 and 5 is saved as a preset value.

To recall the preset timecode

Select Recall Preset TC in the Thumbnail Menu, and then press the PUSH SET(S.SEL) knob.

- 6 Press the PUSH SET(S.SEL) knob.

OK is selected.

- 7 Press the PUSH SET(S.SEL) knob again.

- 8 Save the clip list (*see page 90*).

To save clip lists**To save under a specified name**

See page 73 for more information about thumbnail screen operations.

- 1 In the clip list thumbnail screen, display the Disc Menu.
- 2 Select Save Clip List as..., and then press the PUSH SET(S.SEL) knob.

A list of clip lists appears.

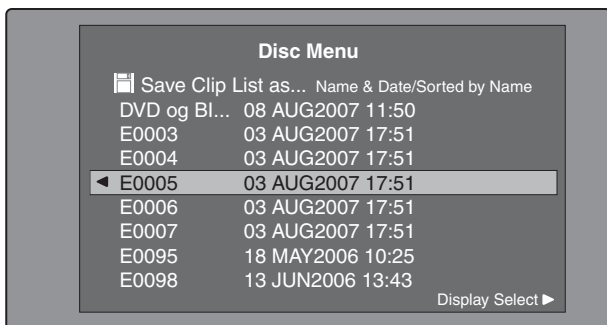
**To switch the information displayed for clip lists**

Press the ►/OUT button.

With each press, the display changes in the order: “Name & Date” > “Name & Title” > “Name & Sort Date” >...

To sort clip lists

Select one of the following orders by selecting Settings > Sort Clip List by... in the Disc Menu.

Name(A-Z): Sort in ascending order by clip list name.

Date(Newest First): Sort by date and time of clip list creation, newest first.

- 3 Select the desired clip list name, and then press the PUSH SET(S.SEL) knob.

To save under the same name

The following procedure saves the current clip list under its current name (the name that appears in the clip list thumbnail screen).

See page 73 for more information about thumbnail screen operations.

- 1 In the clip list thumbnail screen, display the Disc Menu (*see page 72*).
- 2 Select Save Clip List, and then press the PUSH SET(S.SEL) knob.

The clip list is saved. However, Save Clip List as... is executed when the name displayed in the clip list thumbnail screen is “no name”.

Note

If you press the EJECT button or the on/standby button before saving a new or edited clip list, a message appears asking if you want to discard your changes and continue. Follow the instructions in the message to continue or cancel the operation.

Managing clip lists**To load clip lists**

The following procedure loads a clip list stored on the disc into the unit’s internal memory as the current clip list.

See page 73 for more information about thumbnail screen operations.

- 1 In the clip list thumbnail screen, display the Disc Menu.
- 2 Select Load Clip List, and then press the PUSH SET(S.SEL) knob.

A list of clip lists stored on the disc appears.

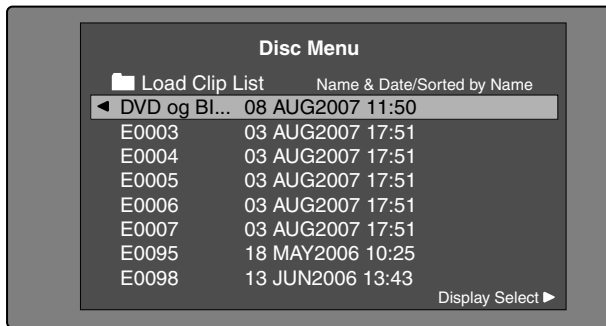

- 3 Select the desired clip list, and then press the PUSH SET(S.SEL) knob.

The name of the clip list selected here appears in the clip list thumbnail screen. When you execute the Save Clip List command in the Disc Menu, the clip list will be saved under that name.

To create a new clip list

Select New File and then press the PUSH SET(S.SEL) knob.

To clear clip lists

The following procedure clears the current clip list from the unit's internal memory.

See page 73 for more information about thumbnail screen operations.

- 1 In the clip list thumbnail screen, display the Disc Menu.
- 2 Select Clear Clip List, and then press the PUSH SET(S.SEL) knob.

A message appears asking you to confirm that you want to clear the clip list.
- 3 Select OK, and then press the PUSH SET(S.SEL) knob.

The current clip list returns to the unnamed state "(no name)".

To delete clip lists

The following procedure deletes a clip list from the disc.

See page 73 for more information about thumbnail screen operations.

- 1 In the clip list thumbnail screen, display the Disc Menu.
- 2 Select Delete Clip List, and then press the PUSH SET(S.SEL) knob.

A list of clip lists appears.

- 3 Select the clip list that you want to delete, and then press the PUSH SET(S.SEL) knob.

A message appears asking you to confirm the deletion.

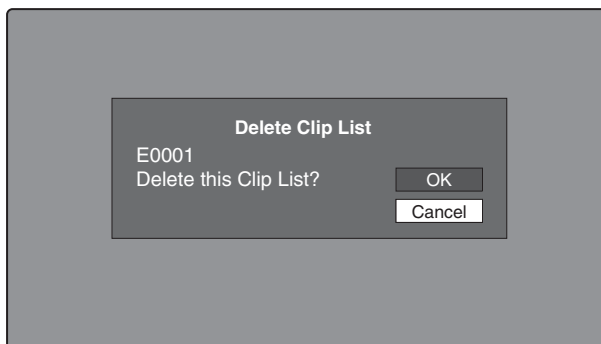

- 4 Select OK, and then press the PUSH SET(S.SEL) knob.

To sort clip lists

See page 73 for more information about thumbnail screen operations.

- 1 In the clip list thumbnail screen, display the Disc Menu.
- 2 Select Settings, and then press the PUSH SET(S.SEL) knob.
- 3 Select Sort Clip List by..., and then press the PUSH SET(S.SEL) knob.
- 4 Select one of the following sort methods, and then press the PUSH SET(S.SEL) knob.

Name(A-Z): Sort in ascending order by clip list name.
Date(Newest First): Sort by date and time of clip list creation, newest first.

Clip lists will be displayed in the specified order the next time that you carry out an operation such as loading a clip list.

Disc Operations

Checking disc properties

See page 73 for more information about GUI screen operations.

- 1 Display the Disc Menu.
- 2 Select Disc Properties, and then press the PUSH SET(S.SEL) knob.

The Disc Properties screen appears.

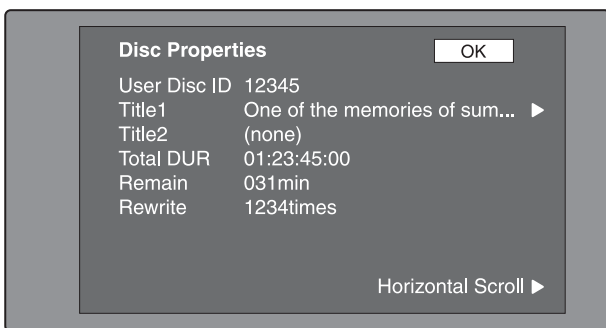

User Disc ID: User disc ID ¹⁾, 2)

Title1: Title1 ¹⁾

Title2: Title2 ¹⁾, 2)

Total DUR: Total recording time

Remain: Remaining recording time

Rewrite: Number of times rewritten

1)This can be specified with the PDZ-1 Proxy Browsing Software on the supplied XDCAM Application Software CD-ROM.

2)When the unit's area of use (UC/J MODEL SELECT) (see page 33) is set to "UC", titles can be displayed in European languages.

To scroll hidden parts of the string into view

When a ◀ or ▶ mark is displayed for an item, you can press the ◀/IN or ▶/OUT button to scroll the display by one character for each press.

The ▲/MARK1 and ▼/MARK2 buttons scroll the beginning and end of the string into view.

To return to the previous screen

Press the PUSH SET(S.SEL) knob.

To edit disc information

You can edit the user disc ID, title1 ¹⁾, and title2 by using a software keyboard.

1) Only ASCII characters can be used for the title1.

See "To edit clip information" (page 80) for more information about operations.

Using planning metadata

Planning metadata is a file that contains metadata about the clips to be shot and recorded.

To use planning metadata, you will need to save a file in advance in the specified location of a media, and insert the media into this unit.

See "To set clip names by using planning metadata" (page 151) for details.

To load planning metadata files

See page 73 for more information about GUI screen operations.

- 1 Display the Disc Menu.
- 2 Select Load Planning Metadata/Select Drive, and then press the PUSH SET(S.SEL) knob.

A media selection screen appears.

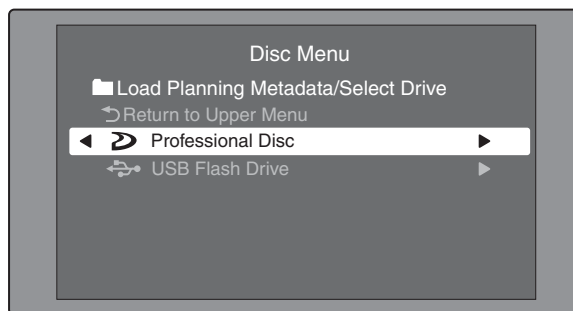

- 3 Select the media where your planning metadata file is stored, and then press the PUSH SET(S.SEL) knob.

A list of the planning metadata files stored on the media appears.

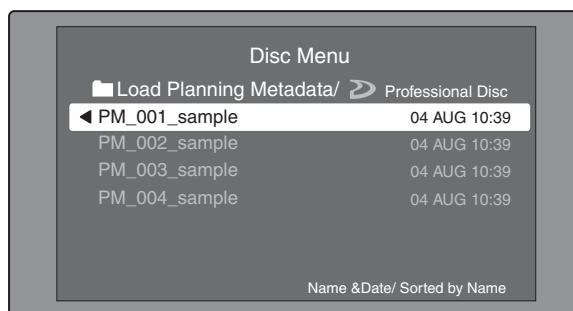

- 4 Select the desired planning metadata file, and then press the PUSH SET(S.SEL) knob.

The selected planning metadata file is loaded into the unit's memory, and the Planning Metadata Properties screen appears.

- 5 Check the information that appears, and press the PUSH SET(S.SEL) knob.

To sort planning metadata

You can sort planning metadata by operating in the same way as in “*To sort clip lists*” (page 91). However, in step 3, select Sort Planning Metadata by....

The planning metadata will be displayed in the specified order the next time you load planning metadata.

To check planning metadata properties

You can check the properties of the planning metadata that is loaded into this unit’s memory, including the date and time of creation and the clip titles.

See page 73 for more information about GUI screen operations.

- 1 Display the Disc Menu.
- 2 Select Planning Metadata Properties, and then press the PUSH SET(S.SEL) knob.

The Planning Metadata Properties screen appears.

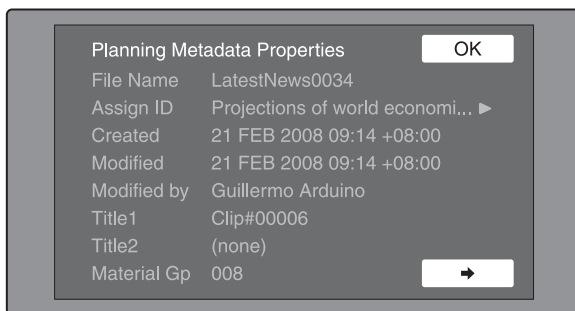

File Name: Planning metadata file name

Assign ID: Assign ID

Created: Date and time of creation

Modified: Date and time of most recent modification

Modified by: Name of person who modified the file

Title1: Title 1 ¹⁾

Title2: Title 2

Material Gp: Material group name

1)This can be set as the clip name (*see page 151*).

To scroll hidden parts of the string into view

When a ◀ or ▶ mark is displayed for an item, you can press the ◀/IN or ▶/OUT button to scroll the display by one character for each press.

The ▲/MARK1 and ▼/MARK2 buttons scroll the beginning and end of the string into view.

To return to the previous screen

Press the PUSH SET(S.SEL) knob.

To clear planning metadata

See page 73 for more information about GUI screen operations.

- 1 Display the Disc Menu.
- 2 Select Clear Planning Metadata, and then press the PUSH SET(S.SEL) knob.

A message appears asking if you are sure that you want to clear the planning metadata.

- 3 Select OK, and then press the PUSH SET(S.SEL) knob.

The planning metadata is cleared from this unit’s memory.

To switch the title display in the display window

When planning metadata is loaded into this unit, you can select the format of the title to display in the display window.

See page 73 for more information about GUI information.

- 1 Display the Disc Menu.
- 2 Select Settings, and then press the PUSH SET(S.SEL) knob.
- 3 Select Planning Clip Name in Clip Info. Area and then press the PUSH SET(S.SEL) knob.

See page 24 for more information about the clip information area.

- 4 Select one of the following, and then press the PUSH SET(S.SEL) knob.

Off: Do not display a title.

ASCII Clip Name: Display the ASCII format title (*see page 151*)

Clip Name: Display the UTF-8 format title (*see page 151*)

Checking user-defined essence marks

You can display the names of user-defined Shot Mark0 to Shot Mark9 essence marks in planning metadata (UTF-8 format, maximum 32 bytes).

- 1 Display the Planning Metadata Properties screen (*see page 93*) for the planning metadata loaded into this unit.

The **➔** button is enabled when the planning metadata contains user-defined essence marks (*see page 152*).

- 2 Press **➔**, and then turn the PUSH SET(S.SEL) knob.

The User Defined Essence Marks screen appears.

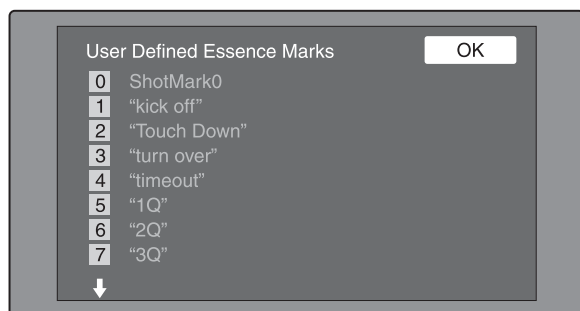

Formatting discs

See page 73 for more information about GUI screen operations.

- 1 Display the Disc Menu.
- 2 Select Format Disc, and then press the PUSH SET(S.SEL) knob.

A message appears asking you to confirm the format.

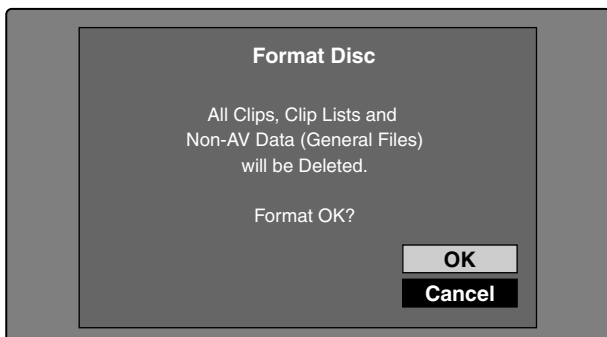

- 3 Select OK, and then press the PUSH SET(S.SEL) knob.

To cancel the format

Select Cancel, and then press the PUSH SET(S.SEL) knob.

To continue by formatting another disc

Exchange the disc, select OK, and then press the PUSH SET(S.SEL) knob.

To exit the formatting screen

Press the PUSH SET(S.SEL) knob with Exit selected.

To disable the Format Disc command

To prevent inadvertent disc formatting, resulting in the loss of recorded data, you can disable the Format Disc command.

See page 73 for more information about GUI information.

- 1 Display the Disc Menu.
- 2 Select Settings, and then press the PUSH SET(S.SEL) knob.
- 3 Select Disable “Format Disc”, and then press the PUSH SET(S.SEL) knob.
- 4 Select Disable, and then press the PUSH SET(S.SEL) knob.

Displaying disc and clip properties in a web browser

By connecting this unit and a computer over a network, you can display disc properties and clip properties in a web browser installed on the computer (Web Thumbnail function).

The Clip Properties page also allows you to download high-resolution clip data, proxy AV data, and metadata from this unit and to save that data on your computer.

To display the unit’s XDCAM web pages

- 1 Connect this unit and a computer to a network (*see page 149*).
- 2 Start the browser on the computer, and enter “http://” + IP_address_of_this_unit + “/” in the address bar of the browser, and then press the Enter key.

For example, if the IP address of this unit is “192.168.001.010”, enter “http://192.168.1.10/”.

If the connection succeeds, you will be prompted to enter a user name and a password.

- 3 Enter your user name and password, and then press the Enter key.

The user name and password are set to the following when the unit is shipped from the factory.

- User name: admin
- Password: Model name (“pdw-f1600” or “pdw-hd1500”)

After the user name and password are verified, an XDCAM web page appears.

To display disc and clip properties

1 Insert a disc into this unit, and put this unit into the following state.

- Recording, playback, search and other disc operations: Stopped
- THUMBNAIL button: Off
- Disc access by Lock or Delecte All Clips, Format Disc, and so on in the Disc Menu: Stopped
- FAM or FTP connection for file operations: Disconnected, or logged out

2 Display the XDCAM web pages in the browser of your computer (*see the previous section*).

To display disc properties

Click “Disc Properties” in the Disc menu. The disc properties of this unit appear in the Disc Properties page.

See “Checking disc properties” (page 92) for more information about the various properties.

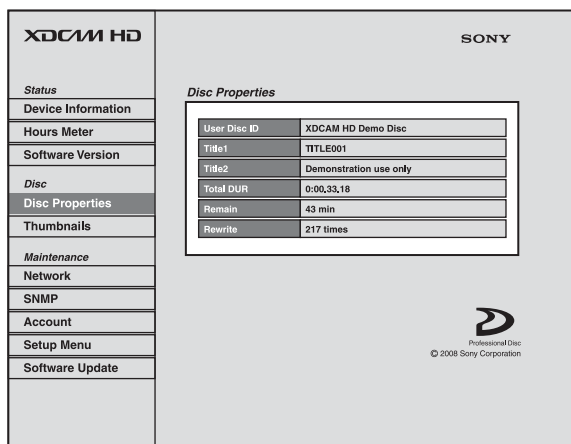

To display clip thumbnails

Click “Thumbnails” in the Disc menu. A page of thumbnails of clips on the disc appears. Each thumbnail page displays up to 12 thumbnails.

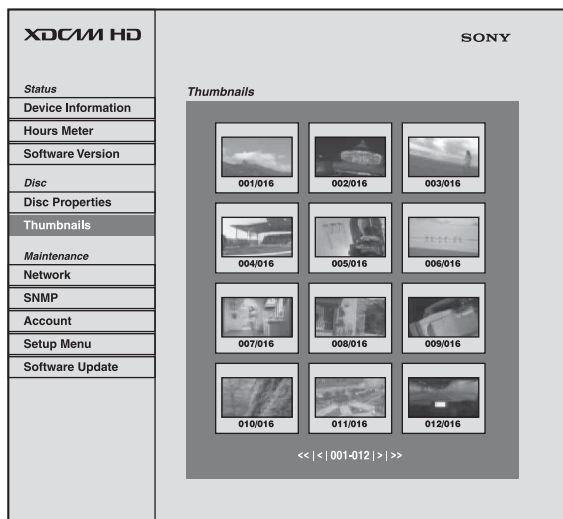

When multiple pages exist, you can switch pages by clicking << (back five pages), < (back one page), > (forward one page), or >> (forward five pages).

To display clip properties

In the Thumbnails page, select a clip by clicking its thumbnail.

The properties of that clip appear in the Clip Properties page.

See “Checking clip properties” (page 80) for more information about the various properties.

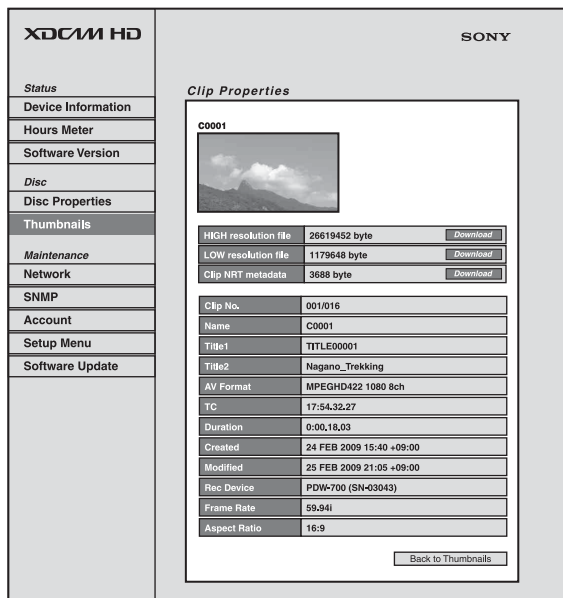

To download high-resolution clip data (HIGH resolution file), proxy AV data (LOW resolution file), or metadata (Clip NRT metadata), click the Download button to the right of the item that you want. Then click “Save” in the dialog that appears and specify the save destination.

The specified data is downloaded to the specified location in your computer.

Notes

- The characters that can be used in the names of clip-related data files are single-byte letters, numbers, and symbols. However, the following symbols cannot be used.
" # * / : < > ? \ |
- If you click “Cancel” in the download dialog, or if the download is cancelled in some other way with the browser still connected to the unit by FTP, click “Back to Thumbnails” to return to the thumbnails screen, or exit the web browser.

Transferring clips (Direct FTP function)

You can transfer clips (MXF files) between this unit and external devices over a network. This unit has an Direct FTP function, which allows you to connect to any XDCAM device or computer with an FTP server function and transfer files with a few simple operations in the GUI screen.

The following table lists the types of file transfers that this unit can execute.

Transfer direction	Transfer target	Function
Upload	One or more clips	put
	Multiple clips with clip list	
	Part of one clip	partial put

Transfer direction	Transfer target	Function
Download	One clip	get

Note

File transfers with this function are limited to clips (high-resolution data) and clip list files. To transfer files of other types (proxy AV data, files in the General and User Data directories, and so on), operate after establishing a FAM or FTP connection (see page 104).

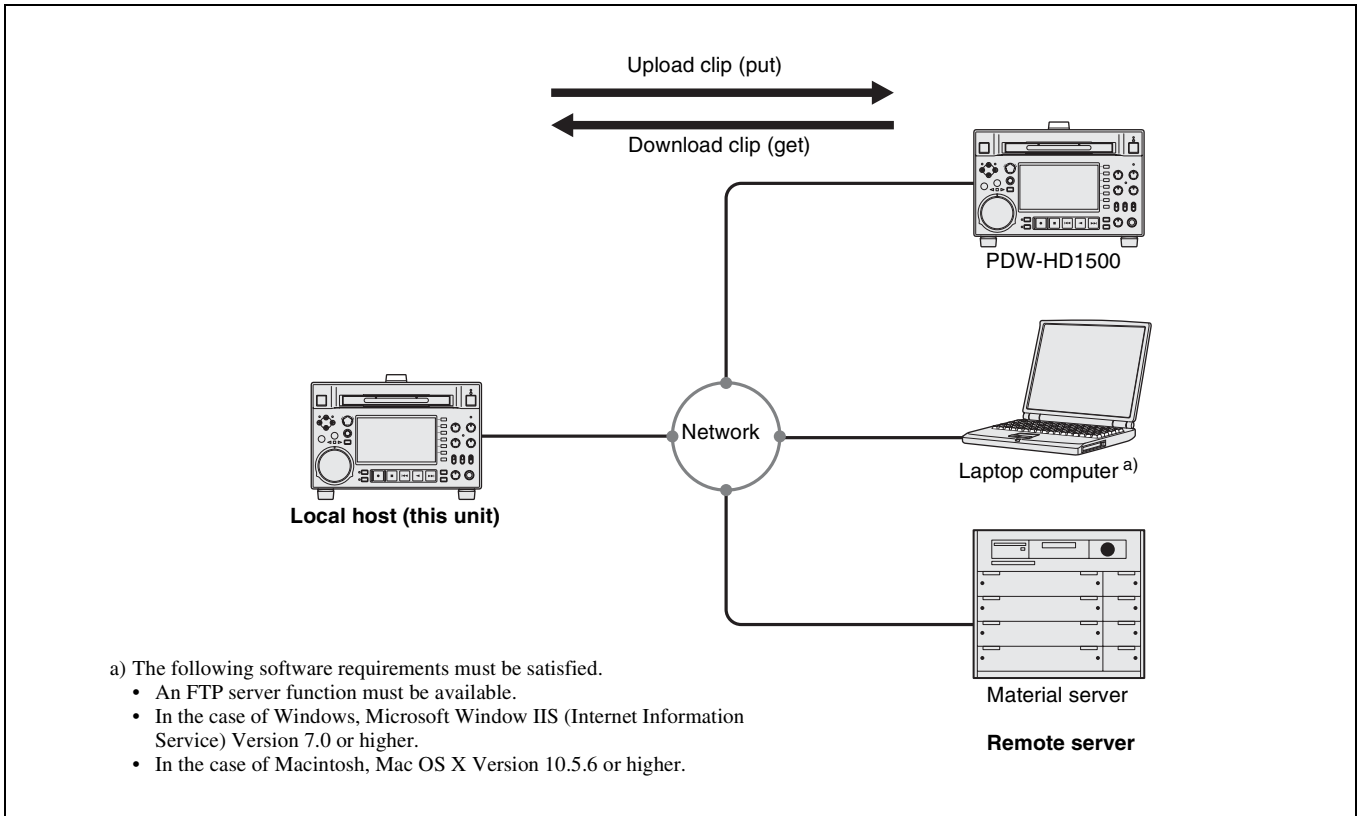

Preparations for clip transfers

Check the following points.

- This unit must be connected over a network to the transfer target device (XDCAM device or computer).
- The settings under maintenance menu item M5: NETWORK must be set to values that allow network connections.
- The remote control switch must be set to NET.

- For XDCAM devices that support UPnP (universal plug and play), the UPnP function must be enabled (the setting may vary).

To enable the UPnP function

The UPnP (universal plug and play) function allows devices to be easily connected to networks. The following XDCAM devices support UPnP.

- PDW-F1600
- PDW-HD1500
- PDW-F800

- PDW-700
- PDW-740

To enable the UPnP function on this unit, set maintenance menu item M59: UPnP to ENABLE.

For the settings on other XDCAM devices, refer to the operation manuals supplied with the devices.

Uploading clips

To upload entire clips

Proceed as follows to upload selected clips or all clips and clip lists on the disc.

See page 73 for more information about thumbnail screen operations.

- 1 In the clip thumbnail screen, select the clip to upload (multiple selections possible).

To upload all clips and clip lists on the disc, start from step 2.

- 2 Display the Thumbnail Menu.

- 3 Select Upload Clips via Direct FTP, and then press the PUSH SET(S.SEL) knob.

The Select Transfer Type screen of the Upload Clips via Direct FTP command appears.

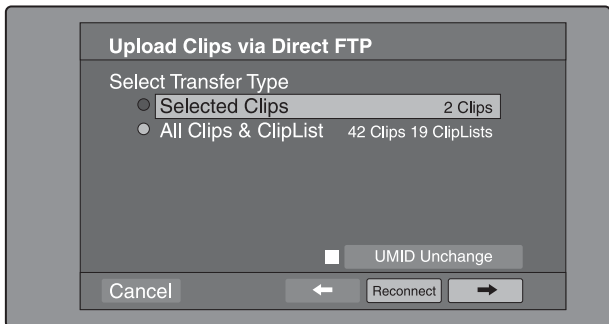

- 4 Select the type of clip transfer.

Selected Clips: Clips selected in step 1.

All Clips & ClipList: All clips and clip lists on the disc.

To transfer while preserving the UMID of the transfer source clips

Check the “UMID Unchanged” option.

Note

If the remote host is a computer, clips are transferred with the UMID unchanged regardless of this setting.

To reconnect to a remote host

The Reconnect button is enabled if the most recent operation successfully established a connection to a remote host.

You can select “Reconnect” and press the PUSH SET(S.SEL) knob to reconnect to that host. The host is selected automatically and the screen changes directly to the Connecting Status screen (see step 9 in the procedure).

Note

The Reconnect button is not enabled if the most recent operation failed to connect to a remote host.

- 5 Select →, and then press the PUSH SET(S.SEL) knob.

The Select Remote Host screen appears.

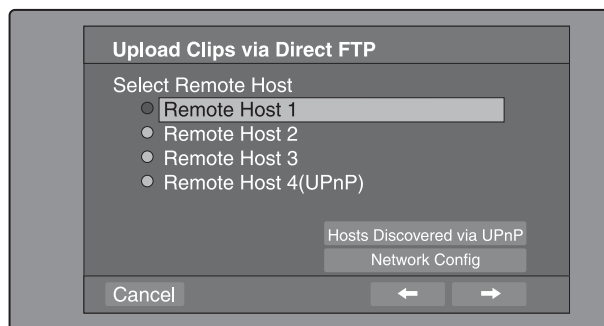

- 6 Select the remote host (the target device to which you want to transfer the clips).

You can register up to four remote hosts.

Remote Host 1 to 3: Register these in the settings screen.

Remote Host 4(UPnP): A remote host that supports UPnP (universal plug and play) is detected and registered automatically (see “To enable the UPnP function” (page 97)).

To check remote hosts discovered by the UPnP function

Select “Hosts Discovered via UPnP”, and then press the PUSH SET(S.SEL) knob. (If the UPnP function of this unit is disabled, a confirmation screen appears prompting you to enable it. Select “OK” and then press the PUSH SET(S.SEL) knob.)

The Select Host Discovered via UPnP screen appears. (Some time may be required before the search for remote hosts finishes.)

Select the name of a remote host from the list, and press the PUSH SET(S.SEL) knob. A network settings

screen appears (*see step 7*). If you establish a connection with the selected remote host, the network settings are saved in Remote Host 4. From the next time that you select “Remote Host 4(UPnP)”, the remote host that you select here will be connected.

To check the network settings of this unit

Select “Network Config”, and then press the PUSH SET(S.SEL) knob. The following network settings appear.

Item	Setting
Host Name	Host name
IP Address	IP address ^{a)}
Subnet Mask	Subnet mask
DHCP	Setting that specifies whether to acquire the IP address automatically from a DHCP server Enabled: Acquire automatically Disabled: Do not acquire automatically
Address Status	Method used to set IP address Manual Set: Manually DHCP: DHCP function AutoIP: Auto IP addressing function Undefined: Nothing specified
Default Gateway	Default gateway

a) An IP address determined by a DHCP server appears instantly in this field.

Select OK and press the PUSH SET(S.SEL) knob to return to the previous screen.

7 Select →, and then press the PUSH SET(S.SEL) knob.

A network settings screen for the remote host appears.

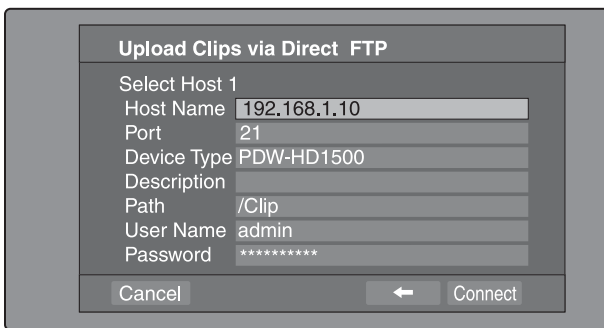

Item	Setting
Host Name	Host name or IP address. (If this is a host name, a DNS server must be available on the connected network. Specification of an IP address is recommended.)
Port	Port used by the FTP server (normally “21”).

Item	Setting
Device Type	The type of the remote host <ul style="list-style-type: none"> If the remote host is an XDCAM device, select the model name or “Other XDCAM model” (if the model name is not in the list) from the list of model names. ^{a)} If the remote host is a computer, select “Others(PC Server)” from the list of model names.
Description	Comment about the remote host. (UTF-8 encoding, up to 128 characters. This setting has no effect on the connection.) The setting that you make here appears as the remote host name in the Select Remote Host screen (<i>see step 5 of the procedure</i>).
Path	If the remote host is a computer, path to the transfer destination directory. (This is not needed if the remote host is an XDCAM device.)
User Name	User name for FTP login. (If the remote host is an XDCAM device, the default is “admin”.)
Password	Password for FTP login. (If the remote host is an XDCAM device, the default is the model name, such as “pdw-hd1500”.)

a) If an XDCAM device is selected as the Device Type, then the User Name and Password are set automatically to the default, and you do not need to make the Port and Path settings. Simply selecting the Host Name (or as appropriate the Description) is enough to fulfill the requirements for connection.

If the User Name or Password of the device that you want to connect to changes, set them here.

8 Set the various items.

To select an item

Turn the PUSH SET(S.SEL) knob to move the cursor, and then push the PUSH SET(S.SEL) knob. A software keyboard appears so that you can enter a setting.

9 Select “Connect”, and then press the PUSH SET(S.SEL) knob.

The settings are saved and the Connecting Status screen appears.

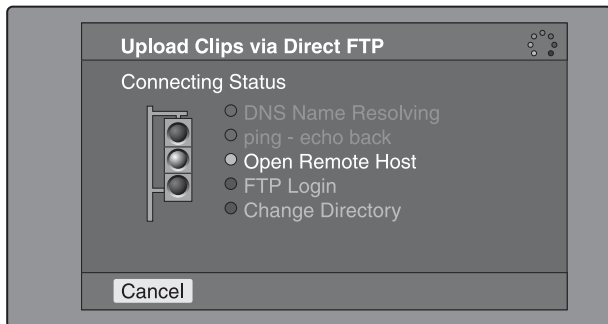

The following table lists the various stages that appear in the connection status screen and describes the corresponding processing.

Item	Description
DNS Name Resolving	When host was specified by a host name instead of an IP address, the unit is querying a DNS server for the host's IP address.
ping - echo back	The unit has issued a ping (communications established) command and is waiting for a response.
Open Remote Host	The unit is connecting to the remote host over the specified port.
FTP Login	The unit is logging in to the remote host with specified user name and password.
Change Directory	When a path was specified, the unit is changing to the specified directory.

The status indicated beside each item lights in yellow during processing for that item, and lights in green when the processing finishes.

If an error occurs

The status indicator changes to red. Correct the condition that caused the error and repeat the operation.

If you cannot connect

Check the following points.

- Make sure that this unit and the remote host are correctly connected to the network.
- If the remote host is an XDCAM device, make sure that it is not displaying a GUI screen.
- If the remote host is an XDCAM device, make sure that a disc is inserted.

When the connection is complete (the indicators of all items have turned green), the Upload Clips via Direct FTP screen appears.

To check the connection on the remote host side

If the remote host is an XDCAM device, check that the “NETWORK!” has appeared in the display or other status display location.

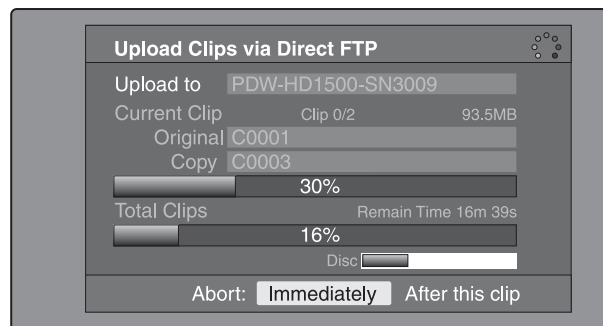

The progress bars show the progress of the transfer. If multiple clips are being transferred, a count of the clips that have been successfully transferred appears. If the remote host is an XDCAM device, the disc usage also appears. (It does not appear if the remote host is a computer).

If a file of the same name already exists at the transfer destination

The file name is changed so that it does not conflict with the file at the destination.

The name of the file on the transfer source (this unit) appears in the “Original” field, and the name of the file on the transfer destination appears in the “Copy” field.¹⁾

1) If the clip name is a standard name, it is changed to the unused clip name with the smallest number. (Example: If names C0001 to C0020 are in use, the name C0021.)

If the clip name is a user-defined name, a serial number is appended to the clip name. (Example: If the name is EveningNews, EveningNews(1).)

To cancel the processing

Do one of the following.

- Select “Abort: Immediately”, and then press the PUSH SET(S.SEL) knob.
- If you are transferring multiple clips, select “Abort: After this clip”, and then press the SET/S.SEL button or the MENU knob. (The transfer of subsequent clips will be cancelled after transfer of the current clip finishes.)
- Set the remote control switch of the unit to “LOCAL”.

Note

When several files are to be transferred, the entire transfer task is cancelled when the first transfer failure occurs. Subsequent clips are not transferred.

When the transfer of all files has finished, the Uploading Result Report screen appears. Press the PUSH SET(S.SEL) knob. This returns you to the clip thumbnail screen.

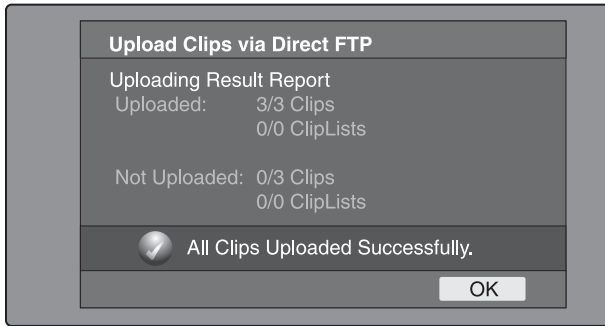

To upload part of a clip

You can select part of a clip in the expand thumbnail screen or the chapter thumbnail screen and upload that part.

Expand thumbnail screen: The clip is divided arbitrarily into parts of equal length, regardless of content. Use this method if you do not need to specify the transfer range precisely.

Chapter thumbnail screen: Use this method if you want to transfer a specific range. (By setting essence marks at the start point and end point of the transfer range, you can specify the range with a precision of one frame.)

- 1 In the clip thumbnail screen, select a clip and press the EXPAND or CHAPTER button.

The expand thumbnail screen or the chapter thumbnail screen appears.

- 2 Select the transfer range.

To select multiple thumbnails

While holding the SHIFT key down, turn the PUSH SET(S.SEL) knob, or press the ◀/IN or ▶/OUT button.

The duration of the transfer range appears in the lower right of the screen.

Note

When the selected range (duration) in the expand thumbnail screen is less than two seconds, it is expanded automatically to two seconds.

- 3 Execute step 2 to 9 of the previous section “To upload entire clips”.

Downloading clips

Proceed as follows to download clips from a remote host (such as other XDCAM device devices or a material server).

See page 73 for information about thumbnail screen operations.

- 1 Display the Disc Menu.
- 2 Select Download Clip via Direct FTP, and then press the PUSH SET(S.SEL) knob.

The Select Remote Host screen of the Download Clip via Direct FTP command appears.

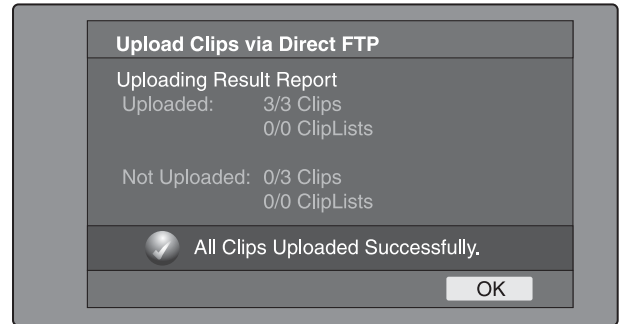

- 3 Execute steps 6 to 9 of “To upload entire clips” (page 98).

If the connection succeeds, the Select Clip to Download screen appears.

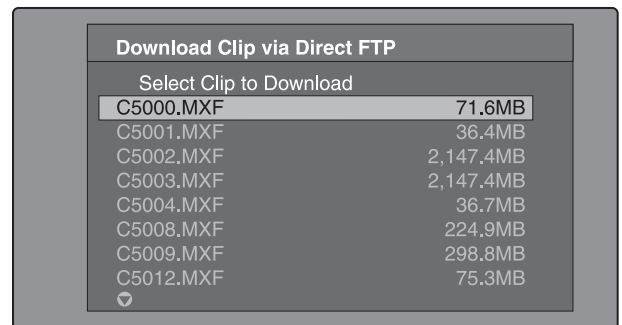

Notes

- If the remote host is a computer, only the MXF files in the specified directory appear.
- File names containing other than ASCII characters (kanji and so on) are not displayed.

- 4 Select a clip to download, and then press the PUSH SET(S.SEL) knob.

The download starts.

When the download finishes, the Downloading Result Report screen appears.

Select “OK”, and then press the PUSH SET(S.SEL) knob. This returns you to the clip thumbnail screen.

Copying clips directly between XDCAM devices

In the field or another environment where the devices are not connected to a network, you can copy (upload) clips between XDCAM devices by connecting them directly. The example in the following procedure shows how to copy a clip from this unit to a PDW-HD1500. Insert discs into both units and proceed as follows.

- 1 Connect this unit and the PDW-HD1500 by a network cable. The cable can be either a cross cable or a straight cable.

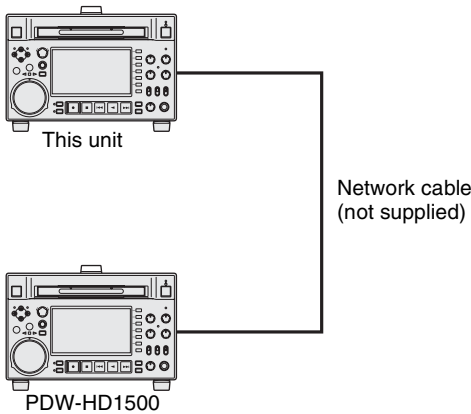

- 2 Set up the two units as follows.

Item	Setting
Item M50: DHCP in the Maintenance menu	ENABLE
Item M59: UPnP in the Maintenance menu	ENABLE

- 3 Power both units off and on again, and wait for about three minutes.
- 4 Check that the IP addresses of the two units have been set as follows by the Auto-IP function.

Item	Setting
Item M51: IP ADDRESS PRESET in the Maintenance menu	169.254.XXX.XXX (X: any number)

- 5 In the clip list thumbnail screen of this unit, select the clip to copy (upload).
- 6 Display the Thumbnail Menu.
- 7 Select Upload Clips via Direct FTP, and then press the PUSH SET(S.SEL) knob.

With **→** selected, the Select Transfer Type screen of the Upload Clips via Direct FTP command appears.

- 8 Press the PUSH SET(S.SEL) knob.

The Select Remote Host screen appears.

- 9 Select “Hosts Discovered via UPnP”, and then press the PUSH SET(S.SEL) knob.

The detected connection destination device (the PDW-HD1500) appears in the Select Host Discovered via UPnP screen.

- 10 Press the PUSH SET(S.SEL) knob.

Detailed information about the connection destination device (the PDW-HD1500) appears.

- 11 With “Connect” selected, press the PUSH SET(S.SEL) knob.

Transfer of the clip begins as soon as the connection is established.

During transfer of the clip, “NETWORK!” appears in the display of the connection destination device (the PDW-HD1500).

When transfer of the clip completes, an Uploading Result Report appears on the screen.

Press the PUSH SET(S.SEL) knob to return to the clip thumbnail screen.

- 12 Check the copied clip in the clip thumbnail screen of the connection destination device (the PDW-HD1500).

Shortcut List

You can access many functions from the buttons, without displaying a menu (shortcut operations).

Shortcuts are available for the following functions. The plus sign (+) indicates that one button is held down while another is pressed, for example “SHIFT + RESET/RETURN”.

Note

The same shortcut may access different functions, depending on the screen that is active when it is executed.

Function	Operation
Clip List Thumbnail (display the clip list thumbnail screen)	SUB CLIP
Expand Thumbnail (display expand thumbnail screen)	EXPAND
Chapter Thumbnail (display chapter thumbnail screen)	CHAPTER
Essence Mark Thumbnail (display essence mark thumbnail screen)	SHIFT + THUMBNAIL
Add Sub Clip (add sub clip)	SHIFT + PUSH SET(S.SEL) knob
Delete Clip (delete clip)	SHIFT + RESET/RETURN
Lock/Unlock Clip (lock or unlock clip)	SHIFT + STOP
Set Inpoint (set In point)	◀/IN + PUSH SET(S.SEL) knob
Set Outpoint (set Out point)	▶/OUT + PUSH SET(S.SEL) knob
Cue up Inpoint (cue up In point)	◀/IN + PREV or ◀/IN + NEXT
Cue up Outpoint (cue up Out point)	▶/OUT + PREV or ▶/OUT + NEXT
Reset Inpoint (reset In point)	◀/IN + RESET/RETURN
Reset Outpoint (reset Out point)	▶/OUT + RESET/RETURN
Cue up (cue up)	PUSH SET(S.SEL) knob ^{a)}
Cue up & Play (cue up and play)	PLAY ^{b)}
Page Down (switch to next page)	SHIFT + ▼/MARK2
Page Up (switch to previous page)	SHIFT + ▲/MARK1
Go To End (go to the last item)	SHIFT + NEXT
Go To Top (go to the first item)	SHIFT + PREV
Select Multi Clip (select multiple clips)	SHIFT + ▶/OUT or SHIFT + ◀/IN
Exit (exit the current thumbnail screen)	THUMBNAIL

a) If Settings >SET Key on Thumbnail in the Disc Menu is set to “Cue up & Play”, then playback starts as soon as cueup is ready.

b) If Settings >SET Key on Thumbnail in the Disc Menu is set to “Cue up & Play”, then pressing the PUSH SET(S.SEL) knob has the same effect.

Overview

A remote computer can be connected to this unit and used to operate on recorded data which has been saved in data files, such as video and audio data files.

There are two ways to connect a remote computer.

- FAM connection
Connect the **i** (i.LINK) S400 connector on this unit to the i.LINK (IEEE1394) connector on the remote computer, using an i.LINK cable (*see page 36*).
- FTP connection
Connect the network connectors on this unit and the remote computer, using a network cable (*see page 36*).

Directory structure

The following figure shows the directory structure of discs visible to a remote computer.

Note

This structure is not the same as the actual structure recorded on the disc.

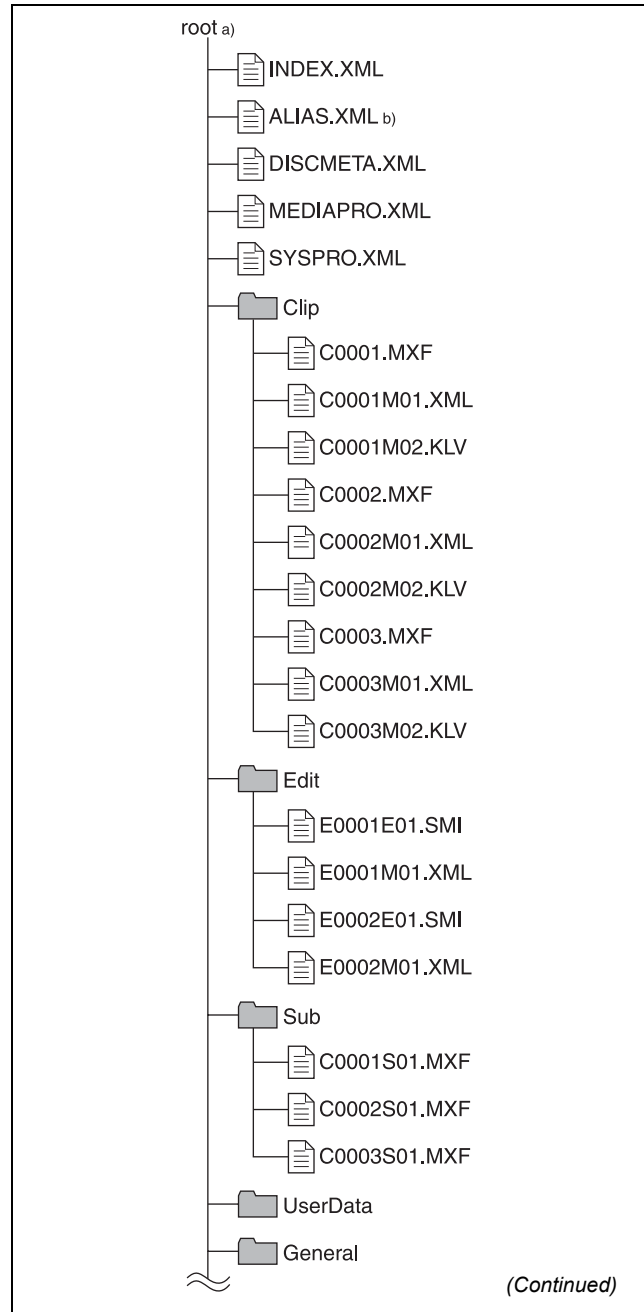

a) Root directory

b) Only when sub item NAMING FORM of setup menu item 036 is set to "free"

(Continued)

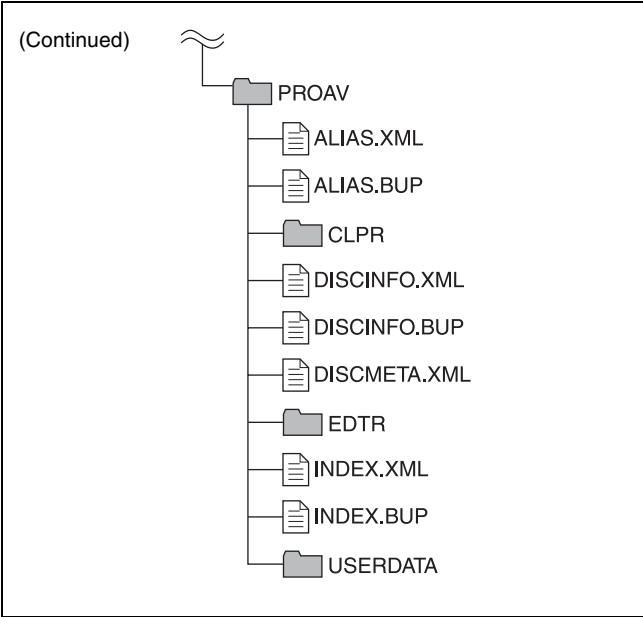

File operation restrictions

This section explains which operations are possible on files stored in each directory.

When required, the following operation tables distinguish reading and writing from partial reading and writing.

Read: Read data sequentially from the start to the end of the file.

Partial read: Read only a part of the data in the file.

Write: Write data sequentially from the start to the end of the file.

Partial write: Write data to a part of the file only.

Note

Operations other than Read and Partial read are possible only when the Write Inhibit tab of the disc is set to recording enabled.

Root directory

File name	Content	Operations				
		Read/Partial read	Write/Partial write	Rename	Create	Delete
INDEX.XML	Contains data for management of the material on the disc.	Yes	No	No	No	No
ALIAS.XML ^{a)}	Contains conversion tables for assigning user-defined names to clips and clip lists.	Yes	No	No	No	No
DISCMETA.XML	Contains metadata to indicate the disc properties.	Yes	Yes ^{b)}	No	No	No
MEDIAPRO.XML	Contains a list of material on the disc, basic properties, related information, and information about access methods.	Yes	No	No	No	No
SYSPRO.XML	Contains information about device system settings and menu settings.	Yes	No	No	No	No
Other files	Files other than the above	–	No	–	No	–

a) Only when sub item NAMING FORM of setup menu item 036 is set to "free"

b) Only files which can be written by XDCAM

Notes

- Directories cannot be created in the root directory.

- The directories in the root directory (Clip, Edit, Sub, UserData, General, and PROAV) cannot be deleted or renamed.

Clip directory

File name	Content	Operations				
		Read/Partial read	Write/Partial write	Rename	Create	Delete
C*.MXF ^{a)}	Clip file created by recording (MXF file) *: 0001 to 9999	Yes	Yes ^{b), c)}	Yes ^{d)}	Yes ^{b)}	Yes ^{e)}
C*M01.XML ^{a)}	Metadata file generated automatically when C*.MXF file is created. *: 0001 to 9999	Yes	Yes ^{f)}	No ^{g)}	No ^{h)}	No ⁱ⁾
C*M02.KLV ^{a)}	User metadata file. This type of file is generated automatically during recording via an FTP or FAM connection when the unit recognizes that an MXF file contains metadata that was generated by a non-XDCAM device. *: 0001 to 9999	Yes	Yes ^{f)}	No ^{g)}	Yes ^{f)}	Yes ⁱ⁾
Other files	Files other than the above	–	No	–	No	–

- a) The unit can handle files with user-defined names in the “C*” part.
- b) Only files which are 2 seconds or longer in length, in a format matching the format (system frequency) and recording format (MPEG HD and number of audio channels) of the recorded sections of the disc, and which can be overwritten by XDCAM. (Partial writing is not possible.)
- c) Overwriting is not possible.
- d) Only when sub item NAMING FORM of setup menu item 036 is set to “free”.
- e) Any clip may be selected and deleted.
- f) Only files which can be written by XDCAM

- g) When the “C*” part of a C*.MXF file name is changed, a C*M01.XML file and a C*M02.KLV file with the same name in the “C*” part is also changed automatically.
- h) When a C*.MXF file is created, a C*M01.XML file with the same name in the “C*” part is created automatically.
- i) When a C*.MXF file is deleted, a C*M01.XML file and a C*M02.KLV file with the same name in the “C*” part is also deleted automatically.

Note

Directories cannot be created in the Clip directory.

Edit directory

File name	Content	Operations				
		Read/Partial read	Write/Partial write	Rename	Create	Delete
E*E01.SMI ^{a)}	Clip list file *: 0001 to 0099	Yes	Yes ^{b)}	Yes ^{c)}	Yes ^{d)}	Yes
E*M01.XML ^{a)}	Metadata file generated automatically when E*E01.SMI file is created. *: 0001 to 0099	Yes	Yes ^{b)}	No ^{e)}	No ^{f)}	No ^{g)}
Other files	Files other than the above	–	No	–	No	–

- a) The “E*” part can be changed to a user-defined name.
- b) Only files which can be written by XDCAM. Partial writing is not possible.
- c) Only when sub item NAMING FORM of setup menu item 036 is set to “free”.
- d) Only files which can be written by XDCAM
- e) When the “E*” part of an “E*01.SMI” file name is changed, an E*M01.XML file with the same name in the “E*” part is also changed automatically.
- f) When an E*E01.SMI file is created, an E*M01.XML file with the same name in the “E*” part is also generated automatically.
- g) When an E*E01.SMI file is deleted, an E*M01.XML file with the same name in the “E*” part is also deleted automatically.

Note

Directories cannot be created in the Edit directory.

Sub directory

File name	Content	Operations				
		Read/Partial read	Write/Partial write	Rename	Create	Delete
C*S01.MXF ^{a)}	Proxy AV data (MXF) file generated automatically when a C*.MXF file is created. *: 0001 to 9999	Yes	No	No ^{b)}	No ^{c)}	No ^{d)}
Other files	Files other than the above	–	No	–	No	–

- a) The “C*” part can be changed to a user-defined name.
- b) When the “C*” part of a C*.MXF file name is changed, a C*S01.MXF file with the same name in the “C*” part is generated automatically.
- c) When a C*.MXF file is created, a C*S01.XML file with the same name in the “C*” part is generated automatically.
- d) When a C*.MXF file is deleted, the C*S01.XML file with the same name in the “C*” part is also deleted automatically.

Note

Directories cannot be created in the Sub directory.

UserData directory

File name	Content	Operations				
		Read/Partial read	Write/Partial write	Rename	Create	Delete
Any file		Yes	Yes	Yes ^{a)}	Yes	Yes

- a) UTF-8 file names can be up to 63 bytes in length. (Depending on the character type, file names (including extension) may be limited to 21 characters.)

The following directory operations are possible in the UserData directory.

- Directory creation (up to 62 levels, including the UserData directory)
- Deletion and renaming of directories

General directory

File name	Content	Operations				
		Read/Partial read	Write/Partial write	Rename	Create	Delete
Any file		Yes	Yes	Yes ^{a)}	Yes	Yes

- a) UTF-8 file names can be up to 63 bytes in length. (Depending on the character type, file names (including extension) may be limited to 21 characters.)

The following directory operations are possible in the General directory.

- Directory creation (up to 63 levels, including the General directory)
- Deletion and renaming of directories

Notes

- The maximum number of files that can be created on a disc is 5,000 for single-layer discs and 6,000 for dual-layer discs (both including directories).
- File names and directory names can use letters, numbers, and symbols from the Unicode 2.0 (UTF-8) character set.
However, the following control characters and symbols ¹⁾ cannot be used.
 - Control characters: U+0000 to U+001F, U+007F

- Symbols: ", *, /, :, <, >, ?, \, |

- 1) The following character codes cannot be used by FAM connections.
U+010000, U+020000, U+030000, U+040000, U+050000, U+060000, U+070000, U+080000, U+090000, U+0A0000, U+0B0000, U+0C0000, U+0D0000, U+0E0000, U+0F0000, U+100000

PROAV directory

This directory contains individual files recorded on the disc.

To display the PROAV directory, set maintenance menu item M33: FILE I/F CONFIG > PROAV DISPLAY to “ENABLE”.

Assigning user-defined clip titles

By default, clips on each disc are assigned names in the range C0001.MXF to C9999.MXF. For this reason, two discs can contain clips with the same names. The

automatic title generation function allows you to assign titles to all of the clips on several discs, which facilitates clip management. For example, if the titles TITLE00001 to TITLE00020 are assigned to clips C0001.MXF to C0020.MXF on disc 1, then the titles TITLE00021 to TITLE00037 are assigned to clips C0001.MXF to C0017.MXF on disc 2.

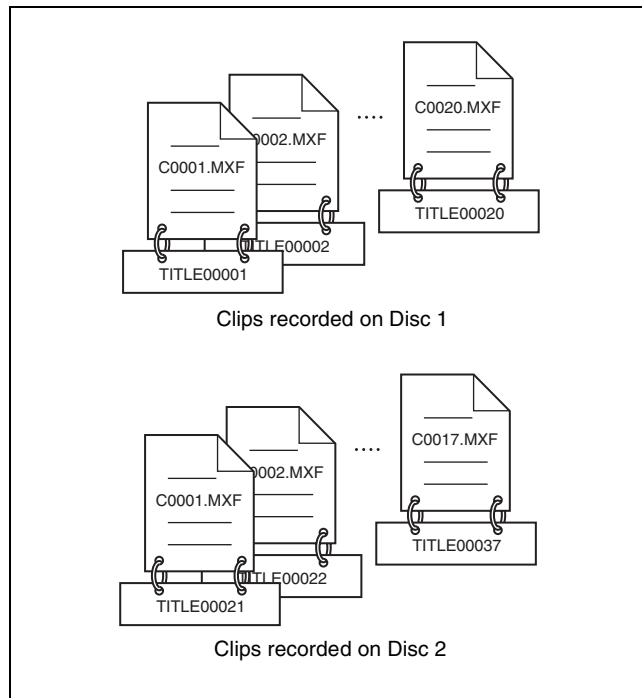

Proceed as follows to specify a title and assign it to recorded clips.

- 1 Press the MENU button.
- 2 Turn the PUSH SET(S.SEL) knob to select setup menu item 035, and press the knob.
- 3 Turn the PUSH SET(S.SEL) knob to select “on”, and press the knob.

The clip title naming screen appears.

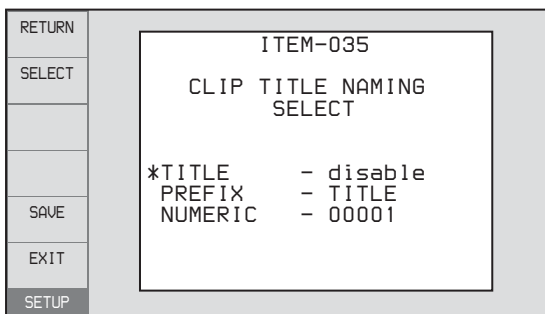

- 4 Turn the PUSH SET(S.SEL) knob to move the asterisk (*) on the left of the menu items to “TITLE”, and press the knob.

The asterisk indicates the selected item.

- 5 Turn the PUSH SET(S.SEL) knob to select “enable”, and press the knob.

The automatic title generation function is enabled.

- 6 Turn the PUSH SET(S.SEL) knob to move the asterisk (*) on the left of the menu items to the item you want to select, and press the knob.

PREFIX: A string of up to 10 characters. The allowable characters are alphanumeric characters, symbols (! # \$ % & ' () + , - . ; = @ [] ^ _ { } ~), and the space character.

NUMERIC: A five-digit number (00001 to 99999) to serve as the initial value of the serial number.

- 7 Turn the PUSH SET(S.SEL) knob to select the character position to set, and press the knob.

- 8 Turn the PUSH SET(S.SEL) knob to select the character to set.

- 9 Repeat steps 7 and 8 as required.

When you are setting the “NUMERIC” item, you can press the RESET/RETURN button to return the initial value of the serial number to 00001 (factory default setting).

- 10 Carry out steps 7 to 9 to set the other item.

- 11 Press the SAVE function (F5) button.

The title is saved.

To check the titles of recorded clips

Press the THUMBNAIL button to display the thumbnail screen, and select the clip whose title you want to check. The title of the selected clip appears at the upper left of the screen.

See “Thumbnail Operations” (page 74) for more information about the thumbnail screen.

Notes

- The value of the serial number is incremented by 1 every time a title is generated. When the value reaches 99999, the next number restarts from 00001.
- Duplicate clip titles can be generated if you reset the serial number after recording several clips or the same is true depending on the value setting. Care should be taken when setting the serial number.
- The “PREFIX” setting is saved in memory banks, but the “NUMERIC” setting is not saved (see page 125).

Assigning user-defined clip and clip list names

The following standard format names are assigned automatically to clips and clip lists that are created or recorded by XDCAM devices.

Clips: C0001.MXF to C9999.MXF

Clip lists: E0001E01.SMI to E0099E01.SMI

This unit can handle clips and clip lists with user-defined names as well as names in the standard format.

Limitations

- Letters, numbers and symbols from the Unicode 2.0 character set can be used. However, the following control characters and symbols cannot be used.
 - Control characters: U+0000 to U+001F, U+007F
 - Symbols: ", *, /, :, <, >, ?, \, |
- Depending on the character type, the length of user-defined names (the "C*" or "E*E01" part) may be limited to 14 characters. (The limit for ASCII characters is 56 characters.)
- All file name extensions are converted automatically to uppercase.
- Titles are used as user-defined clip names on this unit. Therefore, the available characters are limited to those supported by the title function.
- Files generated along with clips and clip lists use the same names (the "C*" or "E*" part of the following file names).
 - Clips: Metadata files (C*M01.XML), user metadata files (C*M02.KLV), proxy AV data files (C*S01.MXF)
 - Clip lists: Metadata files (E*M01.XML)
- The following names cannot be assigned.
 - Clips: C0000.MXF
 - Clip lists: E0000E01.SMI, E0100E01.SMI to E9999E01.SMI, E0000.SMI, E0100.SMI to E9999.SMI
- The following names should be avoided.
 - Clips: C5000.MXF to C9999.MXF
 - Clip lists: E0001.SMI to E0099.SMI

To assign clip names on this unit

The title assigned to clip becomes its clip name (file name).

Notes

- When the first letter of the title setting with setup menu item 035 CLIP TITLE NAMING SELECT is a space or period (.), the clip name is the title string minus the first letter.
- An FTP client that supports UTF-8 is required to use Unicode characters other than ASCII characters.

Command prompt FTP commands do not support UTF-8.

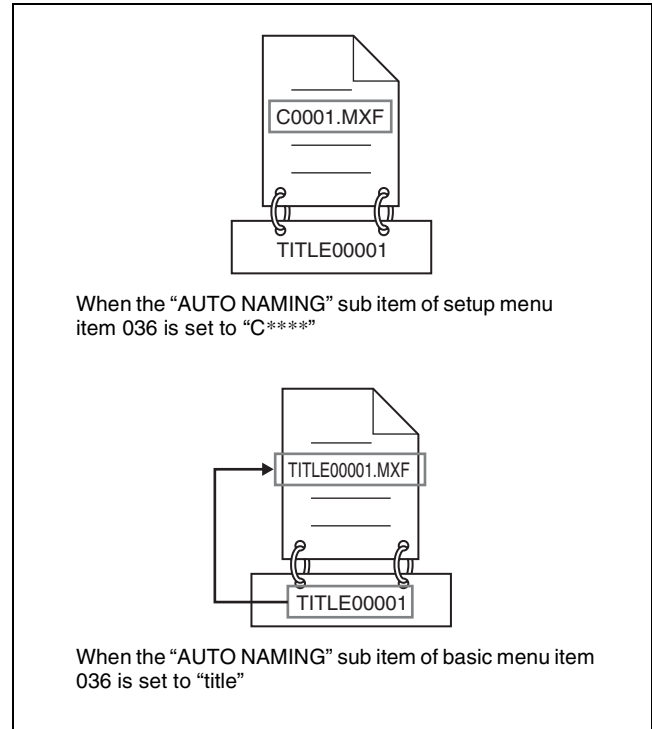

- Before you start, set the "TITLE" sub item of setup menu item 035 CLIP TITLE NAMING SELECT to "enable", and set a title (*see the previous section*).
- Press the MENU button.
- Turn the PUSH SET(S.SEL) knob to select setup menu item 036.
- Turn the PUSH SET(S.SEL) knob to move the "*" to the left of the item names to "NAMING FORM".

The "*" indicates the selected item.

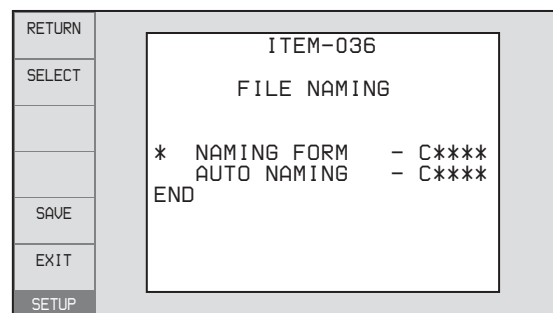

- Turn the PUSH SET(S.SEL) knob to select "free", and press the knob.

You are now able to use clips and clip lists with user-defined names.

- 6 Turn the PUSH SET(S.SEL) knob to move the “*” to the left of “AUTO NAMING”, and press the knob.
- 7 Turn the PUSH SET(S.SEL) knob to select “title”, and press the knob.
- 8 Press the SAVE function (F5) button.

The same name will now be given to newly recorded clips.

To use clips and clip lists with user-defined names over FAM and FTP connections

Carry out steps 2 to 5 of “To assign clip names on this unit”, and then press the SAVE function (F5) button. It is now possible to write, transfer, and rename clips and clip lists with user-defined names over file access mode (FAM) connections (page 110) and FTP connections (page 114).

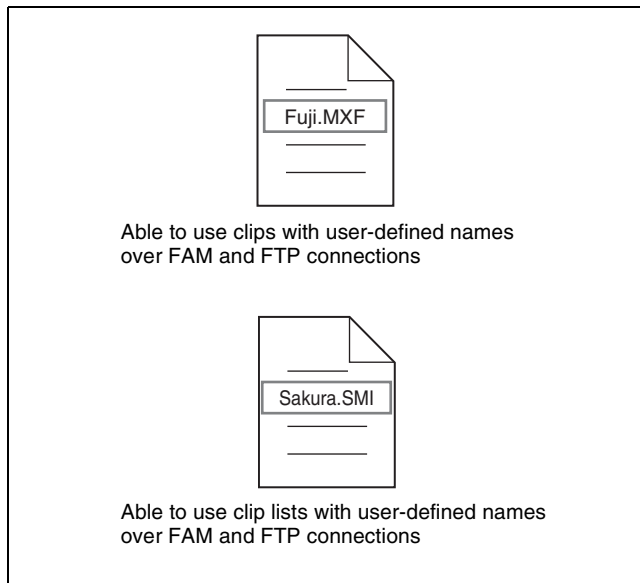

To check clip names

Press the THUMBNAIL button to display the thumbnail screen, and select the clip whose name you want to check. The name of the selected clip appears at the upper left of the screen.

See “Thumbnail Operations” (page 74) for more information about the thumbnail screen.

Note

The item at the upper left of the screen is displayed according to the following order of priority.
Title >User-defined clip name >Standard format clip name
Therefore, the display of this item changes as following, depending on whether there is a title.

- When a title has been set as a clip name on this unit, for clips recorded on this unit, the title is displayed.
- The user-defined name or standard format name is displayed for clips without a title.

File Operations in File Access Mode (for Windows)

File access mode operating environment

Operating system requirements for file operations by file access mode (called FAM below) are as follows.

- Computer operating system: Microsoft Windows XP Professional SP2 or later, or Microsoft Windows Vista Ultimate/Business (32-bit)

Note

64-bit editions of Windows Vista are not supported.

Preparations

Install the FAM driver on the remote computer (see the next section).

To install the FAM driver

Insert the supplied CD-ROM (XDCAM Application Software) into the CD-ROM drive of your computer, navigate to the FAM Driver directory, and run the installer in the directory for your operating system, then follow the installation instructions.

For details, refer to the ReadMe file contained on the CD-ROM disc.

Note

Use Version 2.10 or higher of the FAM driver. The FAM driver on the supplied CD-ROM is Version 2.10 or higher. If a FAM driver is already installed on your computer, check the version.

To check the version

On Windows XP

Select “ProDisc” from “Add or Remove Programs” in the control panel, and then click “Click here for support information”.

On Windows Vista



(1) Open “Programs” > “Programs and Functions” in the control panel, and then right click the header (where “Name” and “Supplier” are displayed) and select “Other...”.

(2) In the Advanced Settings dialog, check “Version” and click “OK”. The version column appears. Check the version of “ProDisc”.

Making FAM connections

- 1 If there is a disc loaded in this unit, put the unit into the following state.
 - Recording, playback, search and other disc operations (see page 54): Stopped
 - THUMBNAIL button (see page 21): Off
 - Disc access by Lock or Delecte All Clips, Format Disc, and so on in the Disc Menu (see page 72): Stopped
 - Unsaved current clip list: Save or clear
- 2 If this unit is connected to a remote computer by FTP, log out from the FTP session (see page 115).
- 3 Connect the  (i.LINK) S400 connector on this unit to the i.LINK (IEEE1394) connector on the remote computer, using an i.LINK cable (see connections illustration on page 36).

Windows recognizes this unit as a removable disc, and displays one of the following icons on the remote computer's task bar:

- Windows XP: 
- Windows Vista: 

The remote computer is now able to perform file operations when a disc is inserted into this unit.

Note

You will not be able to log in if you put the unit into the state described in step 1 after connecting the cable. To log in, disconnect the cable, put the unit into the state described in step 1, and connect it again.

When you make your first FAM connection

The Found New Hardware Wizard dialog appears when you connect this unit to your computer. Select "Install the software automatically (Recommended)", and then click the Next button. Click the Finish button when the software installation finishes.

Operation limitations during FAM connections

- Front panel operations are disabled, except for operations with the EJECT button.
- This unit cannot be controlled from devices connected to the REMOTE(9P) connector (D-sub 9-pin) and  (i.LINK) S400 connector.
- Signal input to this unit and signal output from this unit are stopped.

Operating on files

- 1 Start Explorer.

Check that a drive letter has been assigned to this unit. (The drive letter will differ depending on the number of other peripherals connected to the remote computer.)

- 2 Use Explorer to perform file operations on the disc loaded in this unit.

You can operate in the same way that you operate on local drives and files on network computers.

Notes

- If you power this unit off during an FAM connection, the data transferred thus far is discarded.
- All file operations are not possible for some types of files.

For details, see "File operation restrictions" (page 105).



To eject discs from a remote computer

Right click the icon representing this unit in Explorer, and select "Eject" from the menu which appears.

Exiting file operations

Note

Do not disconnect the cable before performing steps 1 to 3.

- 1 Do one of the following on the  or  icon displayed in the remote computer's taskbar.
 - Double click.
 - Right click, and select the "Safely Remove Hardware".

The "Safely Remove Hardware" dialog appears.

- 2 Select "Sony XDCAM PDW-***** IEEE 1394 SBP2 Device" (*****: "F1600" or "HD1500") and click "Stop".

The "Stop a Hardware device" dialog appears.

- 3 Select "Sony XDCAM PDW-***** IEEE 1394 SBP2 Device" (*****: "F1600" or "HD1500") and click "OK".
 - **Windows XP:** "Sony XDCAM PDW-***** IEEE 1394 SBP2 Device" (*****: "F1600" or "HD1500") is deleted from the "Hardware devices" list.
 - **Windows Vista:** A message appears to inform you that you can now safely remove the device from your computer.

This unit can now resume normal operations. (The limitations described in “Operation limitations during FAM connections” no longer apply.)

- 4 Disconnect the i.LINK cable as required.

To reconnect

To reconnect after exiting file operations, do one of the following, depending on whether an i.LINK cable is connected.

i.LINK cable is not connected: Connect this unit and a remote computer with an i.LINK cable.

i.LINK cable is connected: Disconnect the i.LINK cable from either this unit or the remote computer, wait for at least 10 seconds, and then reconnect the disconnected cable.

The unit is powered off and an i.LINK cable is connected: Power the unit on.

You can enable and disable FAM connection from the function menu. For details, see page 52.

File Operations in File Access Mode (for Macintosh)

File access mode operating environment

Operating system requirements for file operations by file access mode are as follows.

- Computer operating system: Mac OS X v10.4.11 or higher

Preparations

Do the following on the remote computer and this unit.

- Install the FAM driver on the remote computer (*see the next item*).

To install the FAM driver

Insert the supplied CD-ROM (XDCAM Application Software) into the CD-ROM drive of your computer, and execute the dmg file in FAM Driver >Mac >FAM Driver, then follow the installation instructions.

For details, refer to the ReadMe file contained on the CD-ROM disc.

To check the FAM driver version

Connect this unit to your computer with an i.LINK cable, and then, with a disc loaded, start the system profiler utility of the application. The version appears to the right of “prodisk_fs” when you select “Advanced Functions” under “Software”.

Making FAM connections

- 1 If there is a disc loaded in this unit, put the unit into the following state.

- Recording, playback, search and other disc operations (*see page 54*): Stopped
- THUMBNAIL button (*see page 21*): Off
- Disc access by clip deletion, disc formatting, etc.: Stopped
- MENU button (*see page 20*): Off
- Unsaved current clip list: Save or clear

- 2 Connect the **i** (i.LINK) S400 connector on this unit to the i.LINK (IEEE1394) connector on the remote computer, using an i.LINK cable (*see page 36*).

When a disc is inserted into this unit, the remote computer recognizes this unit as a removable disc. The following icon appears in the Finder on the remote

computer, indicating that the computer is now able to perform file operations.



Untitled

Operation limitations during FAM connections

- With the exception of the EJECT button, recording buttons and playback control buttons are disabled.
- Do not use the EJECT button to eject discs. Always eject discs from the computer.
- Do not disconnect the i.LINK cable during a FAM connection. Doing so may result in unstable operation. Always eject any loaded disc before disconnecting the i.LINK cable.

Operating on files

Proceed as follows.

1 Start the Finder.

Check to be sure that a drive has been assigned to this unit.

2 Operate from the Finder on the files on the disc in this unit.

You can operate in the same way that you operate on local drives and files on network computers.

Notes

- If you power this unit off during a FAM connection, the data transferred thus far is discarded.
- All file operations are not possible for some types of files.

For details, see “File operation restrictions” (page 105).

To eject discs from a remote computer

Click the eject button to the right of the icon for this unit in the Finder, or drag the icon for this unit from the Finder to the Trash.

Exiting file operations

Proceed as follows.

Note

Do not disconnect the cable before performing steps 1 and 2.

1 Eject the disc by clicking the eject button to the right of the icon for this unit in the Finder, or by dragging the icon for this unit from the Finder to the Trash.

2 Disconnect the i.LINK cable as required.

To make a reconnection

To reconnect after exiting file operations, do one of the following, depending on whether an i.LINK cable is connected.

i.LINK cable is not connected: Connect this unit and a remote computer with an i.LINK cable.

i.LINK cable is connected: The unit is mounted automatically, so you do not need to do anything.

The unit is powered off and an i.LINK cable is connected: Power the unit on.

You can enable and disable FAM connection from the function menu. For details, see page 52.

FTP File Operations

File operations between this unit and a remote computer can be carried out by the File Transfer Protocol (called FTP below).

Preparations

- 1 Connect the network connectors of this unit and a remote computer with a network cable (*see connections illustration on page 36*). Or connect this unit to the network to which the remote computer is connected (*see connections illustration on page 36*).
- 2 Set the IP address and other network setting items for this unit.¹⁾

For details, see “To change network settings” (page 149).

If network settings have already been made

Check the IP address of this unit.

For details, see “To check the assigned IP address” (page 149).

1) This unit is able to acquire an IP address automatically from a DHCP server. It also supports an Auto-IP function to assign an IP address automatically when access from this unit to the DHCP server times out. You can check DHCP settings and the assigned IP address on page M5:NETWORK of the maintenance menu.

Note

If this unit is directly connected to a computer running Windows Vista with a network cable, change the setting as follows:

(1) Open “Network and Sharing Center” > “Manage network connections” > “Local Area Connection” in the control panel. (2) In the “Local Area Connection Properties”, uncheck the “Internet Protocol Version 6 (TCP/IPv6)”, and then click the OK button.

- 3 Set the remote control switch to “NET” (*see page 18*).

Making FTP connections

FTP connections between this unit and a remote computer can be made with either of the following.

- The command prompt
- FTP client software

This section explains how to use the command prompt. For more information about using FTP client software, refer to the documentation of the FTP client software on your system.

Note

An FTP client that supports UTF-8 is required to use Unicode characters other than ASCII characters. Command prompt FTP commands do not support UTF-8.

To log in

If this unit is connected to a remote computer with a FAM connection, first exit file operations on the FAM connection (*see page 111*).

- 1 Load a disc into this unit and put the unit into the following state.
 - Recording, playback, search and other disc operations (*see page 54*): Stopped
 - THUMBNAIL button (*see page 21*): Off
 - Disc access by Lock or Delete All Clips, Format Disc, and so on in the Disc Menu (*see page 72*): Stopped

Note

Login is not possible unless a disc is loaded and the unit is in the state described above.

- 2 Start the command prompt.
- 3 Enter “ftp <SP> <IP address>”, and press the Enter key. (<SP> refers to a space.)

For example, if the IP address of this unit is set to “192.168.001.010”, enter “ftp 192.168.1.10”.

Refer to the Windows help for more information about the FTP command.

If the connection succeeds, you are prompted to enter a user name.
- 4 Enter the user name “admin” and press the Enter key.

When the user name is verified, you are prompted to enter a password.
- 5 Enter the password and press the Enter key.

The password is set to the model name (“pdw-f1600” or “pdw-hd1500”) when the unit is shipped from the factory.

The login is complete when the password is verified.

See page 115 for the FTP protocol commands supported by this unit.

If the connection times out

This unit terminates FTP connections if no command is received within 90 seconds of the last command. If this occurs, log out (*see the next section*) and repeat steps 2 to 4.

Note

If you power this unit off during an FTP connection, the data transferred thus far is discarded.

To log out

To log out after finishing file operations, enter “QUIT” at the command prompt and press the Enter key.

Command list

The FTP protocol commands supported by this unit include standard commands (*see the next section*) and extended commands (*see page 118*).

Notes

- To execute FTP commands, you must install application software such as PDZ-1 on your computer.
- The commands supported by application software vary.
- An FTP client that supports UTF-8 is required to use Unicode characters other than ASCII characters. Command prompt FTP commands do not support UTF-8.

Standard commands

In the command syntax, <SP> means a space, entered by pressing the space bar, and <CRLF> means a new line, entered by pressing the Enter key.

USER

Send this command to begin the login process.

Command syntax: USER <SP> <user name> <CRLF>

Input example: USER admin

PASS

After sending the USER command, send this command to complete the login process.

Command syntax: PASS <SP> <password> <CRLF>

Input example: PASS pdw-hd1500

QUIT

Terminates the FTP connection. If a file is being transferred, terminates after completion of the transfer.

Command syntax: QUIT <CRLF>

PORT

Specifies the IP address and port to which this unit should connect for the next file transfer (for data transfer from this unit).

Command syntax: PORT <SP> <h1,h2,h3,h4,p1,p2>
<CRLF>

- h1 (most significant byte) to h4 (least significant byte): IP address
- p1 (most significant byte), p2 (least significant byte): Port address

Input example: PORT 10,0,0,1,242,48
(IP address: 10.0.0.1, Port number: 62000)

PASV

This command requests this unit to “listen” on a data port (which is not its default data port). (It puts this unit into passive mode, waiting for the remote computer to make a data connection.)

Command syntax: PASV <CRLF>

TYPE

Specifies the type of data to be transferred.

Command syntax: TYPE <SP> <type-code (options delimited by <SP>)> <CRLF>

<type-code> can be any of the following. However, for XDCAM, data is always transferred as “I”, regardless of the type-code specification.

- A: ASCII
 - N: Non-print
 - T: Telnet format
 - C: ASA Carriage Control
- E: EBCDIC
 - N: Non-print
 - T: Telnet format
 - C: ASA Carriage Control
- I: IMAGE (Binary) (default)
- L: LOCAL BYTE
 - SIZE: byte size

Input example: TYPE I

STRU

Specifies the data structure.

Command syntax: STRU <SP> <structure-code>
<CRLF>

<structure-code> can be any of the following. However, for XDCAM, the structure is always “F”, regardless of the structure-code specification.

- F: File structure (default)
- R: Record structure
- P: Page structure

Input example: STRU F

MODE

Specifies the transfer mode.

Command syntax: MODE <SP> <mode-code> <CRLF>

<mode-code> can be any of the following. However, for XDCAM, the mode is always “S”, regardless of the mode-code specification.

- S: Stream mode (default)
- B: Block mode
- C: Compressed mode

Input example: MODE S

LIST

Sends a list of files from this unit to the remote computer.

Command syntax: LIST <SP> <options> <SP> <path-name> <CRLF>

<options> can be any of the following.

- -a: Also display file names that begin with “.”
- -F: Append “/” to directory names.

The following data is transferred, depending on whether <path-name> specifies a directory or file.

- Directory specified: A list of the files in the specified directory
- File specified: Information about the specified file
- No specification: A list of the files in the current directory

The wildcard characters “*” (any string) and “?” (any character) may be used in <path-name>.

Input example 1: LIST-a Clip

Input example 2: LIST Clip/* .MXF

NLST

Sends a list of file names from this unit to the remote computer, with no other information.

Command syntax: NLST <SP> <options or path-name> <CRLF>

The following options may be specified when no path-name is specified.

- -a: Also display file names that begin with “.”
- -l: Display information other than file name (gives the same result as the LIST command).
- -F: Append “/” to directory names.

The following data is transferred, depending on whether <path-name> specifies a directory or file.

- Directory specified: A list of the file names only in the specified directory
- No specification: A list of the file names only in the current directory.

The wildcard characters “*” (any string) and “?” (any character) may be used in <path-name>.

Input example 1: NLST-I

Input example 2: NLST Clip/* .MXF

RETR

Begins transfer of a copy of a file in the specified path on this unit to the current directory on the remote computer.

Command syntax: RETR <SP> <path-name> <CRLF>

Input example: RETR Clip/C0001.MXF

STOR

Begins transfer of a copy of a file in the specified path on the remote computer to the current directory on this unit. Depending on the type of file transferred, the following files are created.

- C*.MXF file ¹⁾
 - C*M01.XML file (metadata)
 - C*M02.KLV file (user metadata)
 - C*S01.MXF file (proxy AV data)
- E*E01.SMI file ²⁾
 - E*M01.XML file (metadata)

1) *: 0001 to 9999

2) *: 0001 to 0099

Notes

- For C*.MXF files, the UMID of the copy source file is not saved. However, it is saved if an immediately preceding SITE UMMD extended command has been issued.
- For C*.MXF files, some data, such as file header metadata, may be missing.
- Depending on the transfer destination directory and the file type, transfer may not be possible.

For details, see “File operation restrictions” (page 105).

Command syntax: STOR <SP> <path-name> <CRLF>

Input example: STOR Edit/E0001E01.SMI

RNFR

RNTO

Rename a file.

Specify the file to be renamed with the RNFR command, and specify the new name with the RNTO command. (Always follow a RNFR command with a RNTO command.)

For details, see “File operation restrictions” (page 105).

Command syntax: RNFR <SP> <path-name (before change)> <CRLF>

RNTO <SP> <path-name (after change)> <CRLF>

Input example: RNFR General/info.txt
RNTO General/clip_info.txt

DELE

Deletes the specified file on this unit.

Note

Depending on the directory and file type, deletion may not be possible.

For details, see “File operation restrictions” (page 105).

Command syntax: DELE <SP> <path-name> <CRLF>

Input example: DELE Clip/C0099.MXF

STAT

Sends information about properties of the specified file, or about data transfer status, from this unit to the remote computer.

The following property information is sent, depending on the file type.

- MXF file
 - File name
 - File type
 - CODEC type
 - Frame rate
 - Number of audio channels
 - Duration
 - UMID
- non-MXF file
 - File name

Command syntax: STAT <SP> <path-name> <CRLF>

The following data is transferred, depending on whether a file is specified with <path-name>.

- File specified: The properties of the specified file
- No specification: The size of the data transferred thus far (unit: bytes)

Input example: STAT Clip/C0001.MXF

ABOR

Requests this unit to abort a file transfer currently in progress.

Command syntax: ABOR <CRLF>

SYST

Displays the system name of this unit.

Command syntax: SYST <CRLF>

HELP

Displays a list of the commands supported by this unit, or an explanation of the specified command.

Command syntax: HELP <SP> <command-name>
<CRLF>

The following data is transferred, depending on whether a command name is specified with <command-name>.

- Command name specified: Explanation of the specified command.
- No specification: Command list

Input example: HELP RETR

NOOP

Does nothing except return a response. (Used to check whether this unit is running.)

Command syntax: NOOP <CRLF>

PWD

Displays the current directory (“/” if the directory is the root directory).

Command syntax: PWD <CRLF>

CWD

Changes the current directory (moves from the current directory to another directory).

Command syntax: CWD <SP> <path-name> <CRLF>

Moves to a directory as follows, depending on whether a directory is specified with <path-name>.

- Directory specified: To the specified directory
- No specification: To the root directory

Input example: CWD General

CDUP

Moves one level up in the directory structure (makes the parent of the current directory be the current directory).

Command syntax: CDUP <CRLF>

MKD

Creates a new directory.

Note

Directories can be created only in the General directory.

For details, see “File operation restrictions” (page 105).

Command syntax: MKD <SP> <path-name> <CRLF>

RMD

Deletes a directory.

Note

Directories can be deleted only in the General directory.

For details, see “File operation restrictions” (page 105).

Command syntax: RMD <SP> <path-name> <CRLF>

MDTM

Acquires the date and time of the most recent modification of the file in the format “YYYYMMDDhhmmss” (YYYY: year, MM: month, DD: day, hh: hour, mm: minute, ss: second).

Note

The date and time cannot be acquired in the following cases.

- When the path name includes a wildcard (“*”, replaced by any string of characters, or “?”, replaced by any single character).
- When the size of the path name is greater than 1023 bytes.

Command syntax: MDTM <SP> <path-name> <CRLF>

Input example: MDTM PROAV/DISCMETA.XML

Extended commands

In the Command syntax, <SP> means a space, entered by pressing the space bar, and <CRLF> means a new line, entered by pressing the Enter key.

SITE REPF

Sends an MXF file from the specified path on this unit to the remote computer. This command allows you to specify a segment in the body of the MXF file (composed of video and audio data), for transfer of the required segment only.

Notes

- A segment greater than the file size cannot be specified.
- This command cannot be used when the path names contains a space. Use the SITE REPFL command instead.

Command syntax: SITE REPF <SP> <path-name> <SP>
<start-frame> <SP> <transfer-size> <CRLF>

<start-frame> specifies an offset from the start of the file. Data is transferred from the video frame at the offset (the first frame is 0).

<transfer-size> specifies the number of video frames to transfer (specify 0 to transfer to the end of the file).

Input example: SITE REPF Clip/C0001.MXF 5 150

(Transfer C0001.MXF. Body data is transferred only from frame 6 to frame 150.)

SITE REPFL

Sends an MXF file from the specified path on this unit to the remote computer. This command allows you to specify a segment in the body of the MXF file (composed of video and audio data), for transfer of the required segment only.

Note

A segment greater than the file size cannot be specified.

Command syntax: SITE REPFL <SP> “<path-name>”
<SP> <start-frame> <SP> <transfer-size> <CRLF>

<path-name> specifies the path name of the file to transfer. Enclose the path name in double quotation marks.

<start-frame> specifies an offset from the start of the file. Data is transferred from the video frame at the offset (the first frame is 0).

<transfer-size> specifies the number of video frames to transfer (specify 0 to transfer to the end of the file).

Input example: SITE REPFL “Clip/sakura 0001.MXF” 5 150
(Transfer sakura 0001.MXF. Body data is transferred only from frame 6 to frame 150.)

SITE FSTS

Acquires the system status of this unit. One of the following status codes is sent.

- 0: Initial state, or no disc is loaded.
- 1: File system mount is OK.
- 3: File system mount is not OK.

Command syntax: SITE FSTS <CRLF>

SITE MEID

Acquires the media ID of the disc loaded in this unit.

Command syntax: SITE MEID <CRLF>

SITE FUNC

Acquires the function and version of the extended commands.

Information is sent in the following format.

Command syntax: <main function> <SP> <branch
function> <SP> <branch function version>

For XDCAM, sent in a format like “200 MXF DISK 1” (“200” is a response code).

Command syntax: SITE FUNC <CRLF>

SITE UMMD

When a C*.MXF file is sent with the STOR command, the copy source UMID is saved if this command is invoked immediately before the STOR command.

Command syntax: SITE UMMD <CRLF>

SITE DF

Acquires the amount of free disc space.

Command syntax: SITE DF <CRLF>

SITE CHMOD

Locks and unlocks clips. Also sets permissions for directories and files in the General directory.

Command syntax: SITE CHMOD <SP> <flag> <SP>
<path-name> <CRLF>

Specify one of the following values in <flag>, according to the specification in <path-name>.

- When a clip is specified in <path-name>
 - 444: Lock.
 - 666: Unlock.
- When a directory in the General directory is specified in <path-name>
 - 555: Forbid writing to the directory.
 - 777: Allow writing to the directory.
- When a file in the General directory is specified in <path-name>
 - 444: Forbid writing to and execution of the file.
 - 555: Forbid writing to the file, but allow execution.
 - 666: Allow writing to the file, but forbid execution.
 - 777: Allow writing to and execution of the file.

Input example: SITE CHMOD 444 Clip/C0001.MXF
(Lock clip C0001.MXF)

SITE TCPR

Presets the starting timecode of a clip copied with the STOR command. Specify the timecode in the format “ffssmmhh” (ff: frames, ss: seconds, mm: minutes, hh: hours).

Notes

- This command remains in effect until a STOR command is executed, or (if no STOR command is executed) until the FTP connection is terminated.
- If a SITE UMMD command is executed after this command, the SITE UMMD command takes priority and this command is discarded.
- If this command is executed several times in sequence, the last command takes priority.

Command syntax: SITE TCPR <SP> <timecode >
<CRLF>

Input example: SITE TCPR 00050001

(The starting timecode is preset to 01:00:05:00.)

Recording Continuous Timecode with FAM and FTP Connections

When you are connected to the unit by FAM or FTP, you can create new clips with timecode that is continuous with the timecode of the last frame of the last clip on the disc. To record continuous timecode, set TCG on page P5 TC of the function menu to “INT”, and set PRST/RGN to “TC”. Then proceed as follows.

Note

Continuous timecode cannot be recorded if PRST/RGN on page P5 TC of the function menu is set to “VITC”.

See “*Extended menu operations*” (page 142) for more information.

FAM connection

Write clip files to the unit from the computer or other device that is connected to this unit.

FTP connection

Use the “STOR” command to transfer clip files from the computer that is connected to this unit. If you issue the “SITE UMMD” command immediately before the “STOR” command, the original timecode of the transferred file is recorded, regardless of the setting of TCG on page P5 TC of the function menu.

Menu System Configuration

The settings for this unit use the following menus.

Setup menu

The setup menu system of this unit comprises the basic setup menu and extended setup menu.

Maintenance menu

This provides audio control, and network and setup menu settings, and also shows version information.

For details, see “Maintenance Menu” (page 144).

Function menu

For details, see “Basic Operations of the Function Menu” (page 48).

Disc Menu

For details, see “Disc Operations” (page 92).

Setup Menu

The setup menu system of this unit comprises the basic setup menu and extended setup menu.

Basic menu

This menu is used to make settings relating, for example, to the following.

- the digital hours meter
- the preroll time
- the text information superimposed on the video output to the monitor
- the menu banks for retaining menu settings

Extended menu

This menu is used to make a wide range of settings relating to the functions of this unit, for example, the control panel functions, video and audio control, and digital data processing.

Configuration of the basic menu

The basic menu comprises the following groups of items.

Item group	Function	Refer to
Items H01 to H17	Display of the total number of hours the unit has been powered on, and other information collected by the digital hours meter	<i>page 155</i>
Items 001 to 099	Settings relating to the preroll time, superimposed text information, switching between 59.94i/59.94P/29.97P and 50i/50P/25P/23.98P modes, etc.	<i>page 122</i>
Items B01 to B20	Settings relating to the menu banks for saving menu settings	<i>page 125</i>

Configuration of the extended menu

The extended menu comprises the following groups of items.

Item group	Function	Refer to
Items 100 to 199	Settings relating to control panels	page 129
Items 200 to 299	Settings relating to the remote control interface	page 130
Items 300 to 399	Settings relating to editing operations	page 131
Items 400 to 499	Settings relating to preroll	page 132
Items 500 to 599	Settings relating to disc protection	page 132

Item group	Function	Refer to
Items 600 to 650	Settings relating to the timecode generator	page 133
Items 651 to 699	Settings relating to the metadata and UMID	page 134
Items 700 to 799	Settings relating to video control	page 136
Items 800 to 899	Settings relating to audio control	page 138
Items 900 to 999	Settings relating to digital processing	page 140

Items in the basic menu

The basic menu items (excluding the items related to the digital hours meter) are listed in the following table.

- Item names are the names which appear on the video monitor screen of this unit and an external monitor, when the input signals to the monitor are the video signals output from the COMPOSITE OUTPUT 2 (SUPER) connector, the SDCSDI OUTPUT 2 (SUPER) connector, or the HDSDI OUTPUT 2 (SUPER) connector.
- An abbreviated name appears in the time data display area when you press the NEXT button.
- The values in the Settings column are the values which appear in the time data display area. (The values may appear in a different format on an external monitor. In this case, the external monitor values are shown in parentheses.) Underlined values are the factory defaults.

Item number	Item name	Settings
001	PREROLL TIME	0 s (0 sec)... <u>5 s (5 sec)</u>... 30 s (30 sec): Set the preroll time to between 0 and 30 seconds in steps of 1 second. A preroll time of at least 5 seconds is recommended when using this unit for editing.
002	CHARACTER H-POSITION	Adjust the horizontal screen position (as a hexadecimal value) of the text information output from the COMPOSITE OUTPUT 2 (SUPER) connector, the SDCSDI OUTPUT 2 (SUPER) connector, or the HDSDI OUTPUT 2 (SUPER) connector for superimposed display on the monitor. The hexadecimal value 00 is for the far left of the screen. Increasing the value moves the position of the characters to the right. 00 ... <u>0C</u> ... 28 (When the number of system lines is 1080 and the system frequency is 59.94i, 29.97P, 50i, 25P, or 23.98P.) 00 ... <u>0B</u> ... 28 (When the number of system lines is 720 and the system frequency is 59.94P or 50P.) Set this item by adjusting to the required position while viewing the monitor.
003	CHARACTER V-POSITION	Adjust the vertical screen position (as a hexadecimal value) of the text information output from the COMPOSITE OUTPUT 2 (SUPER) connector, the SDCSDI OUTPUT 2 (SUPER) connector, or the HDSDI OUTPUT 2 (SUPER) connector for superimposed display on the monitor. The hexadecimal value 00 is for the top of the screen. Increasing the value lowers the position of the characters. 00 ... <u>2A</u> ... 32 (When the number of system lines is 1080 and the system frequency is 59.94i, 29.97P, 50i, 25P, or 23.98P.) 00 ... <u>29</u> ... 32 (When the number of system lines is 720 and the system frequency is 59.94P or 50P.) Set this item by adjusting to the required position while viewing the monitor.

Item number	Item name	Settings
005	DISPLAY INFORMATION SELECT	Determine the kind of text information to be output from the COMPOSITE OUTPUT 2 (SUPER) connector, the SDDSI OUTPUT 2 (SUPER) connector, or the HSDSI OUTPUT 2 (SUPER) connector. T&sta (time data & status) : Time data and the units status. T&UB (time data & UB) : Time data and user bits data. (When UB (user bits data) is selected with CNTR SEL on the HOME page of the function menu, the user bits data and time data arranged in that order are displayed.) T&CNT (time data & CNT) : Time data and counter count. (When COUNTER is selected with CNTR SEL on the HOME page of the function menu, the counter count and time data arranged in that order are displayed.) T&T (time data & timecode) : Time data and timecode (TC or VITC) T&clp (time data & clip no) : Time data and clip number time (time data only) : Time data only
006	LOCAL FUNCTION ENABLE	Determine which recording and playback control buttons on the front panel are enabled when this unit is controlled from external equipment. dis (all disable) : All buttons and switches are disabled. st&ej (stop & eject) : Only the STOP button and EJECT button are enabled. ena (all enable) : All buttons and switches are enabled.
007	DISC TIMER DISPLAY	Determine whether to display the counter in 12-hour mode or 24-hour mode. ±-12H (+/-12H) : 12-hour mode 24H : 24-hour mode
009	CHARACTER TYPE	Determine the type of characters such as timecode output from the COMPOSITE OUTPUT 2 (SUPER) connector, the SDDSI OUTPUT 2 (SUPER) connector, or the HSDSI OUTPUT 2 (SUPER) connector for superimposed display on the monitor. white : White letters on a black background black : Black letters on a white background W/out : White letters with black outline B/out : Black letters with white outline Set this item by selecting the required type while viewing the monitor.
011	CHARACTER V-SIZE	Determine the vertical size of characters such as timecode output from the COMPOSITE OUTPUT 2 (SUPER) connector, the SDDSI OUTPUT 2 (SUPER) connector, or the HSDSI OUTPUT 2 (SUPER) connector for superimposed display on the monitor. ×1 :Standard size ×2 :2 times standard size Set this item by selecting the required size while viewing the monitor.
012	CONDITION DISPLAY ON VIDEO MONITOR	Select whether to display disc condition marks in external monitor output (output from the COMPOSITE OUTPUT 2 (SUPER) connector, the SDDSI OUTPUT 2 (SUPER) connector, or the HSDSI OUTPUT 2 (SUPER) connector). dis (disable) : Do not display. ena (enable) : Display.



Item number	Item name	Settings
013	SYSTEM FREQUENCY SELECT MENU	<p>Specify whether to enable switching the system frequencies (59.94i, 59.94P, 29.97P, 50i, 50P, 25P, 23.98P).</p> <p>off: Do not enable switching the system frequencies. on: Enable switching the system frequencies.</p> <p><i>For details about switching the system frequencies, see page 43.</i></p> <p>Note Settings for both basic and extended menu items are saved separately for different system frequencies.</p> <ul style="list-style-type: none">• 1080 59.94i/29.97P• 1080 50i/25P• 1080 23.98P• 720 59.94P• 720 50P <p>Therefore, when you switch system frequencies, all menu items are reset to the current settings for the new mode. (They are different from the setting for the previous mode.)</p>
016	ALARM DISPLAY	<p>Select whether to display alarm messages.</p> <p>off: Do not display alarm messages. (However, certain important alarms are displayed.)</p> <p>limit (on (limited)): Display only a minimum number of alarm messages.</p> <p>on: Display all alarm messages.</p> <p><i>For details about alarm message display conditions, see “Alarms” (page 157).</i></p>
017	SUB STATUS DISPLAY SELECT	<p>Determine the kind of sub status information to be output from the COMPOSITE OUTPUT 2 (SUPER) connector, the SDDSI OUTPUT 2 (SUPER) connector, or the HSDSI OUTPUT 2 (SUPER) connector.</p> <p>off: Do not output sub status information.</p> <p>rmain (disc remain): Available disc space (unit: minute)</p> <p>clip (clip no): Order of playback of the selected clip/total number of clips</p> <p>pbr (playback remain): The remaining playback time of the selected clip from the current playback position (hours:minutes:seconds:frames).</p> <p>edit (edit preset): Edit preset state ^{a)}</p> <p>ed&tc (edit preset & tc mode): Edit preset state and settings of timecode ^{a)}</p> <p>Note When menu item 005 is set to “off”, sub status information is not displayed when this item is set to anything other than “off”.</p>
024	MENU CHARACTER TYPE	<p>Determine the type of characters in menu text output from the COMPOSITE OUTPUT 2 (SUPER) connector, the SDDSI OUTPUT 2 (SUPER) connector, or the HSDSI OUTPUT 2 (SUPER) connector for superimposed display on the monitor.</p> <p>white: White letters on a black background. black: Black letters on a white background. W/out: White letters with black outline. B/out: Black letters with white outline.</p> <p>Set this item by selecting the required type while viewing the monitor.</p>
028	HD CHARACTER	<p>Specify whether to superimpose text information on the video signal output from the HSDSI OUTPUT 2 (SUPER) connector.</p> <p>off: Do not superimpose. f-key: Follow the function menu setting.</p>
029	STORED OWNERSHIP	<p>Specify whether to enable changing UMID ownership information settings (COUNTRY, ORGANIZATION and USER).</p> <p>off: Do not enable. on: Enable.</p> <p><i>See “Using UMID Data” (page 171) for more information about UMID.</i></p>

Item number	Item name	Settings	
031	RECORDING FORMAT	Set the recording format. HD422: HD422 420HQ: HD420HQ 420SP: HD420SP IMX50(IMX50Mbps): MPEG IMX 50 Mbps ^{b)} IMX40(IMX40Mbps): MPEG IMX 40 Mbps ^{b)} IMX30(IMX30Mbps): MPEG IMX 30 Mbps ^{b)} DVCAM: DVCAM ^{b)}	
033	BATTERY END VOLTAGE	Sets the voltage to shut down the unit in the battery operation. The battery near end indicator flashes at +0.7 V of the set voltage. 10.5V to 13.5V: 10.5 V to 13.5 V in 0.5 V unit.	
034	MENU STATUS DISPLAY ON VIDEO MONITOR ^{a)}	Specify whether to display the setup menu status at the left edge of the status display line when setup menu item 005 "DISPLAY INFORMATION SELECT" is set to "T&sta". dis (disable): Do not display. ena (enable): Display. (The display is visible only when no disc is loaded, and during insertion and ejection of a disc.)	
035	CLIP TITLE NAMING SELECT	Specify whether to allow user definition of the titles assigned to clips. off: Do not allow assignment. on: Allow assignment.	
	Sub-item		
	1	TITLE	Specify whether to assign titles to recorded clips. disable: Do not assign titles to clips. enable: Assign titles to clips.
	2	PREFIX	Set the prefix of the title (up to 10 characters). The allowable characters are alphanumeric characters, symbols (! # \$ % & ' () + , - . ; = @ [] ^ _ { } ~), and the space character. TITLE
	3	NUMERIC	Set the initial value of the numeric part of the title (00001 to 99999, five-digit number). 00001
036	FILE NAMING	Specify whether to allow use of clip and clip list files with user-defined names. <i>See "Alarms relating to audio and video signals" (page 165) for details about how to make the settings.</i>	
	Sub-item		
	1	NAMING FORM	Specify the clip and clip list naming format. (Specify whether to allow use of files with user-defined names.) C****: Standard format (Do not allow use of files with user-defined names) free: Free format (Allow use of files with user-defined names)
	2	AUTO NAMING	When "free" is selected under the sub-item "NAMING FORM", specify the format of the names of clips recorded on this unit. Specify the standard name format, or the same name as the title listed below, or the name specified in planning metadata. C****: Use the standard format for clip names. title: Use the title set in setup menu item 035 "CLIP TITLE NAMING SELECT" for clip names. plan: Use the name specified in planning metadata.
B01	RECALL SETUP BANK-1	Set to "on" to recall menu settings from menu bank 1.	
B02	RECALL SETUP BANK-2	Set to "on" to recall menu settings from menu bank 2.	
B03	RECALL SETUP BANK-3	Set to "on" to recall menu settings from menu bank 3.	
B11	SAVE SETUP BANK-1	Set to "on" to save current menu settings to menu bank 1.	
B12	SAVE SETUP BANK-2	Set to "on" to save current menu settings to menu bank 2.	
B13	SAVE SETUP BANK-3	Set to "on" to save current menu settings to menu bank 3.	

Item number	Item name	Settings
B20	RESET SETUP MENU	Set to "on" to return the settings of the current menu to the factory default settings. Set to "bank-4" to set the current menu to the settings saved in menu bank 4. off: on: Return the current menu to the factory default settings. bank-4: Set the current menu to the settings saved in menu bank 4.

- a) PDW-F1600 only
b) **[HDI500]** When the PDBK-S1500 or PDBK-F1500 option is installed.

Basic menu operations

The setup menus are displayed in the time data display area of the basic operation display or on the video monitor display. If you have connected an external monitor, they are also superimposed over the picture shown on that monitor.

To display the setup menu

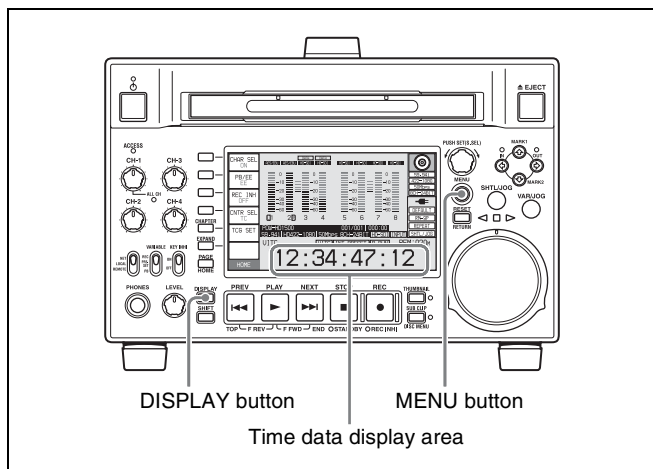

Press the MENU button.

A setup menu appears on the video monitor display, and a cursor "*" indicates the currently selected menu item.

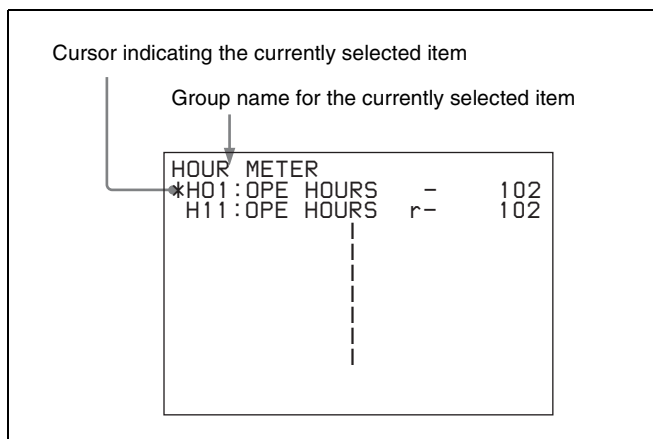

To display menus on the external monitor

Connect the monitor to the COMPOSITE OUTPUT 2 (SUPER) connector, SDDS I OUTPUT 2 (SUPER)

connector, or HDS DI OUTPUT 2 (SUPER) connector on this unit, and press the MENU button.

To display menus in the time data display area

Press the MENU button to display a setup menu on the video monitor display, and press the DISPLAY button. The video monitor display is switched the basic operation display, and the number and setting of the currently selected menu item appear in the time data display area.

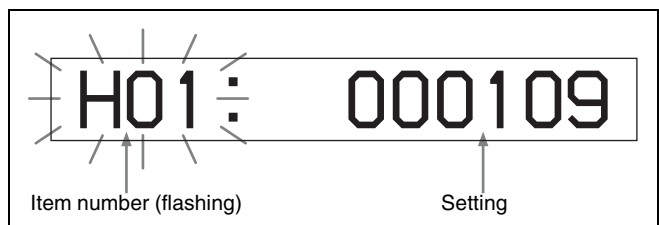

To display the full item name

Hold down the NEXT button.

Buttons used to change settings

Use the following buttons to change setup menu settings.

Menu control buttons	Functions
MENU button	<ul style="list-style-type: none"> Displays and hides the setup and user interface menus. Returns to the menu from a setting screen.
PUSH SET(S.SEL) knob	<ul style="list-style-type: none"> When turned clockwise or counterclockwise, moves the "*" mark up or down in the list of menu items to select the item to change. When turned clockwise or counterclockwise, changes a menu item setting. When pressed, answers "Yes" to a question.
Function buttons F1 to F6 (The function to be displayed varies depending on the situations.)	<p>RETURN: Goes up one level.</p> <p>SELECT: Selects an item.</p> <p>UP: Skips back 100 or 50 items in the list of menu items.</p> <p>DOWN: Skips forward 100 or 50 items in the list of menu items.</p> <p>SAVE: Saves a new setting to memory.</p> <p>EXIT: Exits the current menu.</p> <p>-: Changes a setting.</p> <p>+: Changes a setting.</p>
RESET/RETURN button	<ul style="list-style-type: none"> Returns the current setting to the factory default. Answers "No" to a question.

To change the settings of menu items

Proceed as follows to change the settings of menu items.

- 1 Use the PUSH SET(S.SEL) knob to select the required item.

Example: Screen display when item 005 DISPLAY INFORMATION SELECT is selected

KEY	PARAMETER	Current setting
001	P-ROLL TIME	5 s
002	CHARA H-POS	0A
003	CHARA V-POS	2E
*005	DISPLAY SEL	T&CNT
006	LOCAL ENA	st&ej
007	DISC TIMER	+12H
009	CHARA TYPE	white
011	CHARA SIZE	x1
012	COND DISPLY	dis
013	SYSTEM FREQ	off
016	ALARM	on

- 2 Press the PUSH SET(S.SEL) knob or the SELECT function button (F2).

This displays the setting screen 2 for the menu item selected in step 1.

Example: Setting screen display when item 005 DISPLAY INFORMATION SELECT is selected

ITEM-005
DISPLAY INFORMATION SELECT
time data & CNT
Current setting

- 3 Use the PUSH SET(S.SEL) knob or the +/- function button (F3 or F4) to change the setting.

Turning the PUSH SET(S.SEL) knob while holding down the SHIFT button increases the increment of adjustment.

- 4 To change other settings, press the PUSH SET(S.SEL) knob or the SELECT function button (F2) to return to the previous screen, then repeat steps 1 to 3.

- 5 When you have completed the settings, press the SAVE function button (F5).

The message “NOW SAVING...” appears on the video monitor display, and “Saving...” appears in the time data display area, while the new settings are saved in memory. When the saving operation is completed, the

video monitor display and the time data display area return to their normal indications.

Notes

- If you power off the unit before a save operation is completed, settings may be lost. Wait until the save is completed before powering off the unit.
- If, instead of pressing the SAVE function button (F5), you press the MENU button, the new settings are not saved. The message “ABORT !” appears on the video monitor display and “Abort !” in the time data display area for about 0.5 seconds, and the system exits the menus. To change more than one setting, be sure to press the SAVE function button (F5) after making the settings.

To return menu settings to their factory default settings

After changing menu settings, use the following procedure to return the settings to their factory default settings (setting initialization).

To return a particular setting to its factory default setting

In the screen that selects the setting of that item, press the RESET/RETURN button.

For example, proceed as follows to return the 005 DISPLAY INFORMATION SELECT item to its default setting. This assumes that the setting has been changed from the factory default “time data & status” in step 3 of the procedure in “To change the settings of menu items” (page 127).

- 1 Press the RESET/RETURN button.

“time data & status” (factory default setting) is selected.

- 2 Press the SAVE function button (F5).

The setting returned to its factory default is saved in memory as the current setting.

To return all settings to their factory default settings

- 1 Press the MENU button to display the setup menu.

- 2 Press the RESET/RETURN button.

A message appears, to confirm whether you wish to return all settings to their factory default settings.

Message on the video monitor display	Initialize all items to factory preset values?
Message in the time data display area	Init setup?

3 Press the SAVE function button (F5).

The message “NOW SAVING...” appears on the video monitor display, and “Saving...” appears in the time data display area, while the settings of all items are returned to their factory default settings. These factory default settings are saved in memory. If you power off the unit while settings are being saved, settings may not be correctly returned to their factory default settings. Wait until the saving is completed before powering off the unit.

To abandon the resetting operation

Instead of pressing the SAVE function button (F5), press the RESET/RETURN button. The display returns to the top level of the setup menu, leaving the settings unchanged.

To customize the display of setup menu items

You can select the menu items displayed in the setup menu.

1 Set maintenance menu item M41: CUSTOMIZE to “ENABLE”.

See page 148 for information about how to use the maintenance menu.

2 Hold down the MENU button for about three seconds.

The SETUP CUSTOMIZE screen appears.

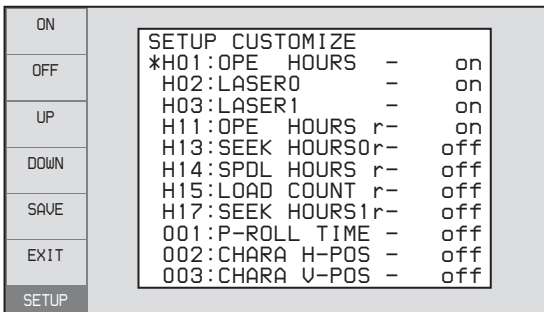

3 Turn the PUSH SET(S.SEL) knob so that the “*” mark appears next to the item you want to hide or display in the setup menu.

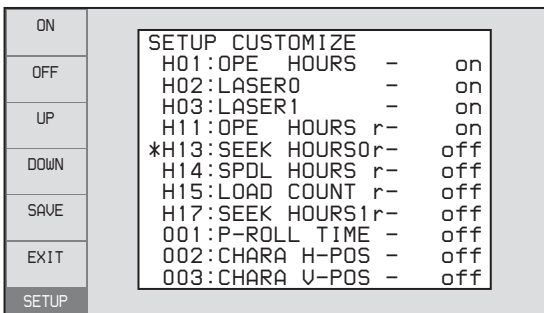

You can press the UP function button (F3) or the DOWN function button (F4) to move the “*” mark by 100 menu items.

4 Press the PUSH SET(S.SEL) knob.

A setting screen for the currently selected item appears.

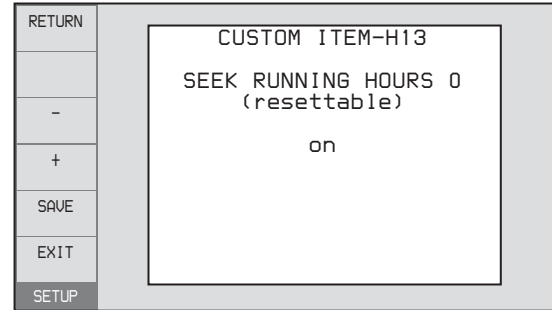

5 Turn the PUSH SET(S.SEL) knob to select “on” or “off”.

on: Display the item in the setup menu.
off: Do not display the item in the setup menu.

6 Press the PUSH SET(S.SEL) knob.

To continue selecting items
Repeat steps **3** to **6**.

To set items more quickly

In step **3**, turn the PUSH SET(S.SEL) knob to move the “*” mark, and then press the ON function button (F1) or OFF function button (F2) to set items continuously.

7 Press the SAVE function button (F5).

Customization indication in the setup menu

When you open the setup menu after customizing the displayed menu item, a “[C]” mark appears at the upper right of the screen to indicate that the menu has been customized.

Items in the extended menu

The following tables show the items in the extended menu.

- Item names are the names which appear on an external monitor to which the output of the COMPOSITE OUTPUT 2 (SUPER) connector, the SDSDI OUTPUT 2 (SUPER) connector, or the HDSDI OUTPUT 2 (SUPER) connector is input.
- An abbreviated name appears in the time data display area when you press the NEXT button.

- The values in the Settings columns are the values which appear in the time data display area. (The values may appear in a different format on an external monitor. In this case, the external monitor values are shown in parentheses.) Underlined values are the factory defaults.

Menu items in the 100s, relating to the control panels

Item number	Item name	Settings
101	SELECTION FOR SEARCH DIAL ENABLE	Select how the unit enters the shuttle, jog, or variable speed mode. dial (dial direct) : Press the SHTL/JOG or VAR/JOG button or, except during recording/editing, turn the jog dial or shuttle dial. key (via search key) : Press the SHTL/JOG or VAR/JOG button.
105	REFERENCE SYSTEM ALARM	Select whether to display a warning when the reference video signal is not being supplied, or when it differs from this unit's system frequency. off : No warning. on : Flash the STOP button as a warning.
107	REC INHIBIT LAMP FLASHING	Select whether to flash the REC INHI indicator when recording is prevented (see "REC INHI (recording inhibit) indicator" (page 22)). off : Light the REC INHI indicator. on : Flash the REC INHI indicator.
108	AUTO EE SELECT	When a disc is inserted and PB/EE on the HOME page of the function menu is set to "EE", select the operation modes in which input video and audio signals are automatically handled in E-E mode. S/F/R (stop/f.fwd/f.rev) : In stop/fast-forward/fast-reverse modes stop : In stop mode
109	FORCED EE WHEN DISC UNLOAD	During disc loading/unloading and when no disc is inserted, select whether to control the output signal PB/EE setting. on : Do not control (the signal is always an E-E signal). off : Control.
114	AUDIO MONITOR OUTPUT LEVEL	Select whether to control the level of the audio signal output from the AUDIO MONITOR R, L connectors with the LEVEL knob for the PHONES jack. var (variable) : Control. fixed : Do not control.
118	KEY INHIBIT SWITCH EFFECTIVE AREA	Select which buttons can be operated when the KEY INHI switch is set to "ON". The following sub-items control different sets of buttons independently.
	Sub-item	
	1	FUNCTION-KEY
2	CONTROL PANEL	Select operable buttons on the front panel are enabled. dis (disable) : Disabled. ena (enable) : Enabled.
119	VARIABLE SPEED LIMIT IN KEY	Select the playback speed range when carrying out playback in variable speed mode from the front panel of this unit. off (off (-2 to +2)) : -2 to +2 times normal speed. on (on (0 to +1)) : 0 to +1 times normal speed.
121	FRAME PB MODE	Select the variable playback field/frame mode. auto : Field playback frame : Frame playback. Compared to field playback, frame playback gives more detail during playback of still pictures.
130	DISPLAY DIMMER CONTROL	Set the brightness of the indication on the LCD. 10%, 25%, 50%, <u>75%</u>, 100%

Menu items in the 100s, relating to the control panels

Item number	Item name	Settings
131	AUDIO VOLUME	Select whether each of the CH-1/ALL CH, CH-2 to CH-4 adjustment knobs on the control panel is effective to control the audio recording level and playback level on each channel or the CH-1/ALL CH adjustment knob alone functions as a master control to control the audio level on all channels together. each: Each of the CH-1/ALL CH, CH-2 to CH-4 adjustment knobs is effective to control each channel. all: The CH-1/ALL CH adjustment knob alone functions as a master control. When "all" is selected, the ALL CH indicator under the CH-1/ALL CH adjustment knob lights up.
140	AREA MARKER	Select whether to display the display area of SD output on the color LCD. off: Do not display. on: Display.
142	REPEAT MODE	Put the unit into repeat playback mode, or exit from repeat playback mode. off: Exits from repeat playback mode. play: Puts the unit into repeat playback mode.
143	INDEX PICTURE POSITION	Select the frame of the clip to use as the thumbnail image (index picture) when recording. 0sec to 10sec: Can be set in the range from 0 seconds (first frame of the clip) to 10 seconds, in units of 1 second.
145	MODE KEY ENABLE DURING RECORDING	Select whether the STOP button is the only button that stops recording. ena (all enable): Recording stops when the EJECT button ^{a)} , PLAY button, STOP button, SHTL/JOG button, and VAR/JOG button ^{b)} are pressed. stop: Recording stops only when the STOP button is pressed.
150	REC MODE	Select the recording mode. normal: Normal recording mode D.EXC (disc exchange cache): Disc Exchange Cache mode C.REC (clip continuous rec): Clip Continuous Rec mode
151	GUI OPERATION	Select whether to disable the display of the Thumbnail Menu and Disc Menu when this unit is in any mode other than stop mode. ena(enable): Do not disable. stop(via stop): Enable the display of menus in the stop mode. dis(disable): Disable.
153	FIND MODE	Specify the frame to be cued up when the PREV or NEXT button is pressed. clip: The first frame of the clip R.ST (clip & rec start mark): The frame where a Rec Start essence mark is set (if no essence mark is set, the first frame of the clip)
154	SINGLE CLIP PLAY MODE	Put the unit into single clip playback mode, or exit from single clip playback mode. off: Exits from single clip playback mode. (Puts the unit into continuous playback mode.) on: Puts the unit into single clip playback mode.



a) The disc is ejected after recording stops.

b) The unit enters stop mode when the PLAY button is pressed. It enters freeze picture mode (jog, shuttle, or variable mode) when the SHTL/JOG button or VAR/JOG button is pressed.

Menu items in the 200s, relating to the remote control interface

Item number	Item name	Settings
201	PARA RUN	Select whether to use synchronized operation for two or more VTRs. dis (disable): No synchronized operation ena (enable): Use synchronized operation Note To use synchronized operation for two or more VTRs, set item 201 to ena on all of the VTRs.

Menu items in the 200s, relating to the remote control interface

Item number	Item name	Settings
212	VIDEO REMOTE CONTROL SELECT ^{a)}	Select whether to control the up converter or down converter when controlling the image enhancer from the HKDV-900 or another unit connected to the VIDEO CONTROL connector. down: Control the down-converter. up: Control the up-converter. u&d: Control both the up- and down-converter. Note It is also possible to adjust setup menu item 718 SETUP LEVEL/BLACK LEVEL from the HKDV-900. Hold down the D2 button on the HKDV-900 and rotate the SETUP dial.
214	REMOTE INTERFACE	When the remote control switch is set to REMOTE, select the device from which to remote-control this unit. 9PIN: Device connected to the REMOTE(9P) connector. SDI: Device connected to the SD/HDSDI INPUT connector. i.LINK: Device connected to the  (i.LINK) S400 connector. ^{b)}
215	i.LINK MODE ^{b)}	Select the connection method for the  (i.LINK) S400 connector. FAM (FAM (PC REMOTE)): FAM connection TS: TS connection
257	NETWORK ENABLE	Select the remote control switch positions which enable network connections. net (network): Only when the switch is set to "NET". n&9P (network & remote(9PIN)): When the switch is set to "NET", and when the switch is set to "REMOTE" and setup menu item 214 is set to "9PIN". ^{c)}

a) **[HD1500]** When the PDBK-S1500 or PDBK-F1500 option is installed.

b) When the PDBK-201 option board is installed

c) FTP connections can be made only when the device connected to the REMOTE(9P) connector (D-sub 9 pin) is in stop mode. During FTP

connections, the device connected to the REMOTE(9P) connector cannot be used to control this unit.

Menu items in the 300s, relating to editing operations

Item number	Item name	Settings
301	VAR SPEED RANGE FOR SYNCHRONIZATION	Select the playback speed range when carrying out playback in variable speed mode from a remote control unit connected to the REMOTE(9P) connector. -2~+2: -2 to +2 times normal speed. wide: -2.20 to +2.20 times normal speed.
311	[F1600] ANALOG AUDIO EDIT PRESET REPLACE FOR CH1	Select methods for setting the edit presets of the digital audio channels CH1 to CH4 of this unit. Make these settings when using an editor (PVE-500, BVE-600, etc.) or remote control unit without a function to control digital audio edit presets.
312	[F1600] ANALOG AUDIO EDIT PRESET REPLACE FOR CH2	The edit presets of the digital audio channels of this unit are turned on and off according to the specified analog audio presets of the editor or remote control unit.
313	[F1600] ANALOG AUDIO EDIT PRESET REPLACE FOR CH3	nodef (no definition): No definition ch 1 (analog ch1): Follow the edit preset of analog channel 1. ch 2 (analog ch2): Follow the edit preset of analog channel 2.
314	[F1600] ANALOG AUDIO EDIT PRESET REPLACE FOR CH4	ch1+2 (analog ch1+ch2): Follow the edit preset of analog channel 1 or 2. (The default settings for each item are as follows) 311: ch 1 (analog ch1) 312: ch 2 (analog ch2) 313: nodef (no definition) 314: nodef (no definition)

Menu items in the 300s, relating to editing operations

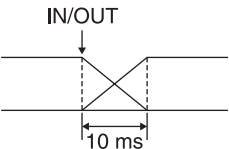
Item number	Item name	Settings
317	F1600 AUDIO EDIT MODE	Select the type of audio transition used for linear editing. cut edit: Cut editing (audio discontinuity at transition point, and possible noise during playback). cross fade: Cross-fade 
320	DIGITAL AUDIO PB PROCESS ON EDIT POINT	Specify the handling of audio at edit points and at the second and subsequent recording start points in Clip Continuous Rec recording. cut: Carry out a cut (possibly resulting in audio discontinuities at the edit point). fade: Fade out and fade in.
329	F1600 ANALOG AUDIO EDIT PRESET REPLACE FOR CH5	Select methods for setting the edit presets of the digital audio channels CH5 to CH8 of this unit. Make these settings when using an editor (PVE-500, BVE-600, etc.) or remote control unit without a function to control digital audio edit presets.
330	F1600 ANALOG AUDIO EDIT PRESET REPLACE FOR CH6	The edit presets of the digital audio channels of this unit are turned on and off according to the specified analog audio presets of the editor or remote control unit.
331	F1600 ANALOG AUDIO EDIT PRESET REPLACE FOR CH7	nodef (no definition): No definition ch 1 (analog ch1): Follow the edit preset of analog channel 1. ch 2 (analog ch2): Follow the edit preset of analog channel 2.
332	F1600 ANALOG AUDIO EDIT PRESET REPLACE FOR CH8	ch1+2 (analog ch1+ch2): Follow the edit preset of analog channel 1 or 2.
344	ASSEMBLE AUTO EDIT POSTROLL RECORDING	Set whether to record 2 seconds of postroll when an additional clip is recorded by sending the AUTO EDIT command (9-pin protocol 20-42) from a nonlinear editing system connected to the REMOTE(9P) connector on the rear panel. Note When using a linear editing system, postroll will not be recorded regardless of this setting. off: Do not record postroll. on: Records approximately 2 seconds of postroll.

Menu items in the 400s, relating to preroll

Item number	Item name	Settings
401	FUNCTION MODE AFTER CUE-UP	Select the state that the unit goes into after a cueing-up operation. stop: Stops (the stop mode). still: Still playback (in jog and shuttle mode).

Menu items in the 500s, relating to disc protection

Item number	Item name	Settings
501	STILL TIMER	To protect the disc against shock and vibrations, and to lengthen the life of the laser diodes, the unit automatically enters standby off mode whenever a specified time elapses in a disc stop mode (stop mode or the still picture mode of search mode). This allows you to set the time after which the unit exits a disc stop mode and enters standby off mode. 0.5 s (0.5 sec)... 8 m (8 min)... 30 m (30 min): Can be set in the range from 0.5 seconds to 30 minutes. off: Do not put into standby off mode.

Menu items in the 600s, relating to the timecode, metadata, and UMID

Item number	Item name	Settings
601	VITC POSITION SEL-1 ^{b)}	<p>In 59.94i/59.94P/29.97P mode</p> <p>Select the line into which to insert VITC signals (SD output) 12H ... 16H ... 20H: Any line from line 12 through line 20.</p> <p>Notes</p> <ul style="list-style-type: none"> You can insert VITC signals in two places. To insert in two places, set both item 601 and item 602. In 59.94i/59.94P/29.97P/23.98P mode (J), output of wide picture information is given priority if OUTPUT in setup menu item 731 is set to "auto" and the VITC insertion line is set to line 16. In 59.94i/59.94P/29.97P/23.98P mode (UC), output of wide picture information is given priority if OUTPUT in setup menu item 731 is set to "auto" and the VITC insertion line is set to line 20.
		<p>In 50i/50P/25P mode</p> <p>Select the line into which to insert VITC signals (SD output) 9H ... 19H ... 22H: Any line from line 9 through line 22.</p> <p>Note</p> <p>You can insert VITC signals in two places. To insert in two places, set both item 601 and item 602.</p>
602	VITC POSITION SEL-2 ^{b)}	<p>In 59.94i/59.94P/29.97P mode</p> <p>Select the line into which to insert VITC signals (SD output) 12H ... 18H ... 20H: Any line from line 12 through line 20.</p> <p>Notes</p> <ul style="list-style-type: none"> You can insert VITC signals in two places. To insert in two places, set both item 601 and item 602. In 59.94i/59.94P/29.97P mode (J), output of wide picture information is given priority if OUTPUT in setup menu item 731 is set to "auto" and the VITC insertion line is set to line 16. In 59.94i/59.94P/29.97P mode (UC), output of wide picture information is given priority if OUTPUT in setup menu item 731 is set to "auto" and the VITC insertion line is set to line 20.
		<p>In 50i/50P/25P mode</p> <p>Select the line into which to insert VITC signals (SD output) 9H ... 21H ... 22H: Any line from line 9 through line 22.</p> <p>Note</p> <p>You can insert VITC signals in two places. To insert in two places, set both item 601 and item 602.</p>
605	TCG REGEN MODE	<p>Select the signal to be regenerated when the timecode generator is in the regeneration mode.</p> <p>TC&UB: Both the timecode and user bits are regenerated. TC: Only the timecode is regenerated. UB: Only the user bits are regenerated.</p>
607	U-BIT BINARY GROUP FLAG	<p>Select the user bits to be used in the timecode generated by the timecode generator.</p> <p>000 (000:not specified): Character set not specified. 001 (001:iso character): 8-bit characters compliant with ISO 646 and ISO 2022. 010 (010:unassigned-1): Undefined. 011 (011:unassigned-2): Undefined. 100 (100:unassigned-3): Undefined. 101 (101:page / line): SMPTE-262M page/line multiplex system. 110 (110:unassigned-4): Undefined. 111 (111:unassigned-5): Undefined.</p>

Menu items in the 600s, relating to the timecode, metadata, and UMID

Item number	Item name	Settings
610	F1600 REGEN CONTROL MODE	Select whether or not the time code is automatically regenerated. auto(assem & insert)edit: In automatic editing carried out in either assemble mode or insert mode with this unit as the recorder, regardless of the settings of F1 (TCG) and F2 (PRST/RGN) in function menu page 5, the time code generator regenerates according to the time code on the disc. auto assemble edit: In automatic editing carried out in assemble mode with this unit as the recorder, regardless of the settings of F1 (TCG) and F2 (PRST/RGN) in function menu page 5, the time code generator regenerates according to the time code on the disc. manual: Regardless of whether this unit is the recorder or player, the time code generator operates in accordance with the settings of F1 (TCG) and F2 (PRST/RGN) in function menu page 5. assemble & insert: Whether local or remote and regardless of the settings of F1 (TCG) and F2 (PRST/RGN) in function menu page 5, the time code generator regenerates according to the time code played back from the disc.
611	TC OUTPUT PHASE IN EE MODE	Select the timecode output mode for output from the TIME CODE OUT connector in E-E mode. thru (through): Output the timecode input to the TIME CODE IN connector as it is. v-in (video input phase): Output the timecode with the same phase as the input video signal phase. v-out (video output phase): Output the timecode with the same phase as the output video signal phase.
612	TC OUTPUT MUTING IN SEARCH MODE	Select whether to suppress the output from the TIME CODE OUT connector in jog/shuttle mode. on: Suppress. off: Do not suppress.
618	UPCONV EMBEDDED VITC ^{a)}	Select the source of the VITC embedded into output HDSDI when up converting during playback of SD discs. VITC: Select the VITC of the SD disc. LTC: Select the LTC of the SD disc.
619	VITC ^{a)}	Select whether to record the VITC generated by the internal timecode generator during IMX recording. off: Do not record the internally generated VITC. on: Record the internally generated VITC. Note Even if this item is set to “off”, VITC is recorded if the input video signal contains VITC and the VITC line is set to “thru” in menu item 723.
651	UMID SDI OUTPUT	Select whether to output UMID in the VANC of the SDI output. off: Do not output. on: Output. <i>See “Using UMID Data” (page 171) for more information about UMID.</i>
652	UMID SD VANC LINE ^{b)}	Select the line in which UMID is output when menu item 651 is set to “on”. 12 H (12 line), 13 H (13 line), 15 H (15 line), 16 H (16 line), 17 H (17 line), 18 H (18 line), 19 H (19 line) (59.94i/59.94P/29.97P mode) 9 H (9 line), 10 H (10 line), 12 H (12 line), 13 H (13 line), 14 H (14 line), 15 H (15 line), 16 H (16 line), 17 H (17 line), 18 H (18 line) (50i/50P/25P mode) <i>See “Using UMID Data” (page 171) for more information about UMID.</i>



Menu items in the 600s, relating to the timecode, metadata, and UMID

Item number	Item name	Settings
653	UMID HD VANC LINE	Specify the HDSDI signal VANC line into which the UMID should be inserted. 9H to 17H to 20H (59.94i, 50i, 29.97P, 25P, 23.98P mode) 9H to 17H to 25H (59.94P, 50P mode) Note The output VANC line during playback follows the setting for recording. See “Using UMID Data” (page 171) for more information about UMID.
657	ESSENCE MARK SDI OUTPUT	Select whether to output essence marks in the SDI output VANC. off: Do not output. on: Output.
660	ESSENCE MARK SD VANC LINE ^{b)}	When menu item 657 is set to “on”, select the line to which to output essence marks. 12 H (12 line), 13 H (13 line), 15 H (15 line), 16 H (16 line), 17 H (17 line), 18 H (18 line), 19 H (19 line) (59.94i/59.94P/29.97P mode) 9 H (9 line), 10 H (10 line), 12 H (12 line), 13 H (13 line), 14 H (14 line), 15 H (15 line), 16 H (16 line), 17 H (17 line), 18 H (18 line) (50i/50P/25P mode)
665	ESSENCE MARK HD VANC LINE	When item 657 is set to “on”, select the line to which to output essence marks. 9H to 17H to 20H (59.94i, 50i, 29.97P, 25P, 23.98P mode) 9H to 17H to 25H (59.94P, 50P mode) Note The output VANC line during playback follows the setting for recording.
666	METADATA ITEM OUT	Specify whether to include the information from recorded VANC packets in data items in the DATA ITEM section of MXF files. off: Do not include VANC packet information in data items. on: Include VANC packet information in data items.
668	USER META DATA OUTPUT IN MXF	Select whether to output user metadata to MXF files. off: Do not output. on: Output.

a) **HD1500** When the PDBK-S1500 or PDBK-F1500 option is installed.

b) Not displayed when the unit is in 23.98P mode.



Menu items in the 700s, relating to video control

Item number	Item name	Settings	
703	BLANK LINE SELECT	Switch blanking of the video output signal on or off for individual lines in the vertical blanking interval.	
	Sub-Item	The Y/C signal and odd/even fields are blanked simultaneously.	
	ALL LINE	--: Specify the blanking for each line separately. blnk (blank) : Regardless of the setting of other sub-items, blank all lines which can be specified in this menu item. thru (throu) : Regardless of the setting of other sub-items, switch off blanking for all lines which can be specified in this menu item.	
	In 59.94i/ 59.94P/29.97P mode (UC)	LINE 12 ... LINE 19	Specify blanking for lines 12 to 19. blnk (blank) : Carry out blanking. thru (throu) : Switch off blanking.
		LINE 20	Specify blanking for line 20. blnk (blank) : Carry out blanking. half : Carry out half-blanking. thru (throu) : Switch off blanking.
	In 59.94i/ 59.94P/29.97P mode (J)	LINE 12 ... LINE 20	Specify blanking for lines 12 to 20. blnk (blank) : Carry out blanking. thru (throu) : Switch off blanking.
		LINE 21	Specify blanking for line 21. blnk (blank) : Carry out blanking. half : Carry out half-blanking. thru (throu) : Switch off blanking.
	In 50i/50P/25P mode	LINE 9 ... LINE 22	Specify blanking for lines 9 to 22. blnk (blank) : Carry out blanking. thru (throu) : Switch off blanking.
LINE 23		Specify blanking for line 23. half : Carry out half-blanking. thru (throu) : Switch off blanking.	
705	EDGE SUBCARRIER REDUCER MODE	Select whether to enable the edge subcarrier reducer (ESR). on : Enable. off : Do not enable. When playing back a composite signal, set this to "on".	
707	FORCED VERTICAL INTERPOLATION OFF	The "Y-add" function is normally switched on automatically during jog or variable speed playback. This item selects whether to force the "Y-add" function off. auto : Automatically switch the "Y-add" function on. off (forced YADD off) : Force the "Y-add" function off. The "Y-add" function is off while a disc image is displayed in stop mode (menu item 108 AUTO EE SELECT is "off"). The "Y-add" function is a circuit operation to interpolate the video signal vertically during jog or variable speed playback for the purpose of reducing the vertical movement of the playback picture.	
710	INTERNAL VIDEO SIGNAL GENERATOR	Select the test signal to be output from the internal test signal generator. When V INPUT on the P1 VIDEO page of the function menu is set to "SG", the internal test signal generator operates to output the selected test signal. This signal can also be recorded. CB75 (75% Color Bars) : 75% color bar signal CB100 (100% Color Bars) : 100% color bar signal MLTBS (Multi Burst) : Multi-burst signal 10STEP (10 steps) : 10-step signal PLSBR (Pulse and Bar) : Pulse and bar signal RAMP (Ramp) : Ramp signal BLACK (Black) : Black signal ARIB CB (ARIB Color Bars) : ARIB color bar signal, modify width, 100% Note ARIB CB cannot be specified when SD recording is selected. If ARIB CB is selected, the selection is changed to CB75 (75% Color Bars).	

Menu items in the 700s, relating to video control

Item number	Item name	Settings	
713	VIDEO SETUP REFERENCE ^{b)}	Set the video setup amount to be added to the composite output signal (in 59.94i/59.94P/29.97P mode only).	
	Sub-item		
	OUTPUT LEVEL	In 59.94i/59.94P/29.97P mode (UC) 0.0% , 7.5% In 59.94i/59.94P/29.97P mode (J) 0.0% , 7.5%	
715	VIDEO GAIN CONTROL	Adjust the video output level. -2048 to 0 to 848	
716	CHROMA GAIN CONTROL	Adjust the chroma output level. -2048 to 0 to 848	
717	CHROMA PHASE CONTROL	Adjust the chroma phase. -128 to 0 to 127	
718	SETUP LEVEL (59.94i/59.94P/29.97P/23.98P mode)/BLACK LEVEL (50i/50P/25P mode) ^{b)}	Adjust the setup level (black level). -272 to 0 to 272	
719	SYSTEM PHASE SYNC	Adjust the output signal sync phase. -128 to 0 to 127	
720	SYSTEM PHASE SC	Adjust the output signal subcarrier phase. 0 to 511	
723	INPUT VIDEO BLANK ^{a)}	Switch blanking on or off for lines in the vertical blanking interval of input video signals. Lines can be specified individually. Y/C signals and odd/even fields are blanked simultaneously. Blanking in recorded signals is carried out according to these settings.	
	Sub-Item		
	1	ALL LINE	-- : Specify the blanking for each line separately. blank (blank) : Regardless of the settings of other sub-items, blank all lines which can be specified in this menu item. thru (throu) : Regardless of the settings of other sub-items, switch blanking off for all lines which can be specified in this menu item.
	2...10 ... LINE 20	In 59.94i/59.94P/29.97P mode	Specify blanking for lines 12 to 20. blank (blank) : Switch blanking on. thru (throu) : Switch blanking off.
2...15 ... LINE 22	In 50i/50P/25P mode	Specify blanking for lines 9, 322 to 22, and 335. blank (blank) : Switch blanking on. thru (throu) : Switch blanking off.	
726	H BLANKING WIDTH	Select the horizontal blanking width of the output analog video signal. narrow (narrow) : Digital blanking (narrow) wide : Analog blanking (wide) When "wide" is selected, the horizontal blanking width complies with SMPTE170M, and normally the blanking is widened and the image becomes narrower. It is recommended to select "narrow" at the editing stage, then later, for broadcast transmission to select "wide", to output a signal conforming to the standard. Note, however, that "narrow" has to be always selected for SDI signals.	
728	OUTPUT SCH PHASE	Set the subcarrier H phase. -512 (-512 (DEC))... 0 (0 (DEC))... 511 (511 (DEC))	

Menu items in the 700s, relating to video control

Item number	Item name	Settings
731	WIDE MODE	Specify whether to record and play back with the addition of wide picture information.
	Sub-Item	
	1 INPUT ^{a)}	Select whether to save wide picture information to the disc when recording. auto: Automatically save wide picture information when it is detected in the selected input video signal. on: Always save wide picture information. off: Never save wide picture information.
2	OUTPUT	Select whether to add wide picture information to the signal output when down-converter output is set to squeeze mode. thru (through): Do not add. auto: Add. Notes <ul style="list-style-type: none"> To add wide picture information to the output signal, another setting is required in addition to this item. In setup menu item 703, set line 16 (59.94i/59.94P/29.97P/23.98P mode (J)), line 20 (59.94i/59.94P/29.97P/23.98P mode (UC)), or line 23(50i/50P/25P mode) to “thru”. In 59.94i/59.94P/29.97P/23.98P mode (J), output of wide picture information is given priority if the VITC insertion line is set to line 16 in setup menu item 601 or 602. In 59.94i/59.94P/29.97P/23.98P mode (UC), output of wide picture information is given priority if the VITC insertion line is set to line 20 in setup menu item 601 or 602.
740	MASTER LEVEL (HD)	Adjust the high-definition video signal output from the HDSDI OUTPUT 1, 2 (SUPER) connectors. This adjusts the Y, PB, and PR levels simultaneously. -2048 to 0 to 846
741	Y LEVEL (HD)	Adjust the Y level of the high-definition video signal output from the HDSDI OUTPUT 1, 2 (SUPER) connectors. -2048 to 0 to 846
742	PB LEVEL (HD)	Adjust the PB level of the high-definition video signal output from the HDSDI OUTPUT 1, 2 (SUPER) connectors. -2048 to 0 to 846
743	PR LEVEL (HD)	Adjust the PR level of the high-definition video signal output from the HDSDI OUTPUT 1, 2 (SUPER) connectors. -2048 to 0 to 846
745	SETUP LEVEL (HD)	Adjust the setup level of the high-definition video signal output from the HDSDI OUTPUT 1, 2 (SUPER) connectors. -272 to 0 to 272
746	SYNC PHASE (HD)	Control the H sync phase of the high-definition video signal output from the HDSDI OUTPUT 1, 2 (SUPER) connectors. -128 to 0 to 127
747	FINE (HD)	Fine control the H sync phase of the high-definition video signal output from the HDSDI OUTPUT 1, 2 (SUPER) connectors. 0 to 1023

a) **[HD1500]** When the PDBK-S1500 or PDBK-F1500 option is installed.

b) Not displayed when the unit is in 23.98P mode.

Menu items in the 800s, relating to audio control

Item number	Item name	Settings
802	DIGITAL AUDIO MUTING IN SHUTTLE MODE	Set the audio muting conditions during shuttle playback. off: Not muted. on: Muted.

Menu items in the 800s, relating to audio control

Item number	Item name	Settings	
807	AUDIO OUTPUT PHASE	Set the output timing of digital audio playback signals (HDSDI, SDI, AES/EBU only), with 80H as a reference position. Output timing is earlier for values smaller than 80H and later for values greater than 80H. (80H, 128 samples = approx. 2.7 ms, 80H, 1 sample = approx. 20 μs) 0 (0 (HEX))... 80 (80 (HEX))... FF (FF (HEX)) : Values can be set in this range.	
808	INTERNAL AUDIO SIGNAL GENERATOR	Select the operation of the internal audio test signal generator. silnc (silence) : Silent signal. 1kHz (1kHz sine) : 1 kHz, -20 dB FS sine wave signal. When you set the A1 INPUT item on page P2 AUDIO of the function menu to "SG", the internal signal generator operates and outputs simultaneous test signals to channels 1 to 8 (see page 49).	
815	AUDIO SAMPLING RATE CONVERTER	Select the mode of operation of the sampling rate converter for AES/EBU input to channels 1 to 4. off : Do not operate. on : Operate.	
819	[F1600] AUDIO INPUT ARRANGE	Set up mixing of audio signals. <i>For details, see "To set up mixing of audio input signals" (page 61).</i>	
823	NON-AUDIO FLAG PB	Control non-audio flags in digital audio output.	
	Sub-item		
	1	CH1/CH2	During playback (except E-E mode), set non-audio flags in digital audio output to the following states. on : Set to on (data is non-audio.) auto : Set as follows. <ul style="list-style-type: none"> When data is read from disc and confirmed: Follow the data. When data from disc is not confirmed: Maintain current state.
	2	CH3/CH4	
	3	CH5/CH6	
4	CH7/CH8		
824	ANALOG LINE OUTPUT SELECT	Select the analog audio signals (tracks 1 to 8) to be assigned to audio output channels 1 and 2. tr1/2 : Tracks 1 and 2 assigned to audio output channels 1 and 2. tr3/4 : Tracks 3 and 4 assigned to audio output channels 1 and 2. tr5/6 : Tracks 5 and 6 assigned to audio output channels 1 and 2. tr7/8 : Tracks 7 and 8 assigned to audio output channels 1 and 2.	
827	AES/EBU AUDIO OUTPUT SELECT	Select the audio signals to assign to AES/EBU audio output channels.	
	Sub-item		
	1	CH1/CH2	tr1/2 : Tracks 1 and 2 assigned to audio output channels 1 and 2. tr3/4 : Tracks 3 and 4 assigned to audio output channels 1 and 2. tr5/6 : Tracks 5 and 6 assigned to audio output channels 1 and 2. tr7/8 : Tracks 7 and 8 assigned to audio output channels 1 and 2.
	2	CH3/CH4	tr1/2 : Tracks 1 and 2 assigned to audio output channels 3 and 4. tr3/4 : Tracks 3 and 4 assigned to audio output channels 3 and 4. tr5/6 : Tracks 5 and 6 assigned to audio output channels 3 and 4. tr7/8 : Tracks 7 and 8 assigned to audio output channels 3 and 4.
828	SDI AUDIO OUTPUT SELECT	Select the audio signals to assign to SDI audio output channels.	
	Sub-item		
	1	CH1/CH2	tr1/2 : Tracks 1 and 2 assigned to audio output channels 1 and 2. tr3/4 : Tracks 3 and 4 assigned to audio output channels 1 and 2. tr5/6 : Tracks 5 and 6 assigned to audio output channels 1 and 2. tr7/8 : Tracks 7 and 8 assigned to audio output channels 1 and 2.
	2	CH3/CH4	tr1/2 : Tracks 1 and 2 assigned to audio output channels 3 and 4. tr3/4 : Tracks 3 and 4 assigned to audio output channels 3 and 4. tr5/6 : Tracks 5 and 6 assigned to audio output channels 3 and 4. tr7/8 : Tracks 7 and 8 assigned to audio output channels 3 and 4.
831	TS OUT AUDIO MODE ^{a)}	Select the number of output channels for i.LINK TS (HDV) signals. 4ch : 4 channels 2ch : 2 channels	

Menu items in the 800s, relating to audio control

Item number	Item name	Settings
834	AUDIO INPUT LEVEL	Select the analog audio input source.
	Sub-item	
	1 CH1	line: Line input mic: Microphone input
	2 CH2	line: Line input mic: Microphone input
839	AUDIO AGC/LIMITER MODE	For automatic input level adjustments performed on the analog audio signals recorded on channels 1 and 2, select whether to perform the adjustments in stereo mode or independently for channels 1 and 2. mono: Perform automatic adjustments independently for channels 1 and 2. stereo: Perform automatic adjustments in stereo mode.
840	AUDIO AGC SELECT	Set the AGC saturation level. off: AGC does not operate. -6dB, -9dB, -12dB, -15dB, -17dB: AGC operates when the VARIABLE switch is set to PRESET. Note This setting is valid only for channels where “mic” is selected with setup menu item 834 AUDIO INPUT LEVEL. Regardless of this setting, AGC is “off” for channels where “line” is selected.
841	AUDIO LIMITER SELECT	Select the limiter saturation level, for limiting large input signals, for use in manual adjustment of audio input levels. off: The limiter does not operate. -6dB, -9dB, -12dB, -15dB, -17dB: The limiter operates when the VARIABLE switch is set to PRESET. Note This setting is valid only for channels where “mic” is selected with setup menu item 834 AUDIO INPUT LEVEL. Regardless of this setting, the limiter is “off” for channels where “line” is selected.

a) When the PDBK-201 option board is installed

Menu items in the 900s, relating to digital process

Item number	Item name	Settings
920	SD-SDI H-ANC CONTROL	Select whether to add information to the SDI output.
	Sub-item	
	1 AUDIO 5CH-8CH	off: Do not add digital audio data channels 5 to 8. on: Add digital audio data channels 5 to 8.
	2 RP188 ATC	off: Do not add RP188 timecode data. on: Add RP188 timecode data.
923	AUTO SQUEEZE ^{a)}	Select whether to use auto squeeze mode. off: Do not use. on: Use.
930	DOWN CONVERTER MODE (DC)	Select the down-converter mode. crop: Select the edge-crop mode. l-box: Select the letter box mode. squez: Select the squeeze mode.
931	DOWN CONVERTER LETTER BOX MODE (DC)	Select the aspect ratio of the down-converter output when menu item 930 is set to “l-box”. 16:9: Set the aspect ratio of the HD-SD converter output to 16:9. 14:9: Set the aspect ratio of the HD-SD converter output to 14:9. 13:9: Set the aspect ratio of the HD-SD converter output to 13:9.
932	H CROP POSITION (DC)	Adjust the H-crop (the horizontal position when cropping in the edge crop mode) of the down converter output when menu item 930 is set to “crop”. -120 to 0 to 120
934	CROSS COLOR (DC)	Adjust the down-converter cross color. 0 to 8 to 15

Menu items in the 900s, relating to digital process

Item number	Item name	Settings
935	DETAIL GAIN (DC)	Adjust the down-converter image enhancer, the sharpness of edge enhancement. 0 to 7FH
936	LIMITER (DC)	Adjust the down-converter image enhancer, the maximum detail level added to emphasize the original signal. 0 to 20H to 3FH
937	CRISP (DC)	Adjust the down-converter image enhancer, the threshold amplitude at which low amplitude signals are not emphasized. 0 to FH
938	LEVEL DEPEND THRESHOLD (DC)	Adjust the down-converter image enhancer. Set the luminance range for edge enhancement. 0 to 8 to FH
939	H DETAIL FREQUENCY (DC)	Adjust the down-converter image enhancer. Set the central frequency for edge enhancement. 2.6MHz, 3.4MHz, 3.9MHz, 4.6MHz
940	H/V RATIO (DC)	Adjust the down-converter image enhancer. Set the horizontal/vertical ratio for edge enhancement. 0 to 3 to 7
942	V FILTER SELECT (DC)	Set the vertical interpolation filter coefficient for down-converter output (in 1080 mode only). 1 to 3
943	CROSS COLOR CRISP (DC)	Set the cross color crisp level for down-converter output. 0 to 4 to FH
950	UP CONVERTER MODE ^{a)}	Select the up-converter mode. EDGE CROP: Select the edge-crop mode. LETTER BOX: Select the letter box mode. SQUEEZE: Select the squeeze mode.
951	H CROP POSITION (UC) ^{a)}	Adjust the H-crop (the horizontal position when cropping in the edge crop mode) of the up converter output when menu item 950 is set to "crop". -120 to 0 to 120
952	LETTER BOX POSITION (UC) ^{a)}	When menu item 950 is set to "l-box", adjust the vertical location of the position where the picture is cut out for up converter output in letter box mode. -120 to 0 to 120
953	UP CONVERTER PROCESS (UC) ^{a)}	Select the source picture to use in converting SD to HD. FIELD: Use field pictures. ADAPTIVE: Frame or field is selected automatically.
954	DETAIL GAIN (UC) ^{a)}	Adjust the up-converter image enhancer, the sharpness of edge enhancement. 0 to 40H to 7FH
955	LIMITER (UC) ^{a)}	Adjust the up-converter image enhancer, the maximum detail level added to emphasize the original signal. 0 to 20H to 3FH
956	CRISP THRESHOLD (UC) ^{a)}	Adjust the up-converter image enhancer, the threshold amplitude at which low amplitude signals are not emphasized. 0 to 8 to FH
957	LEVEL DEPEND THRESHOLD (UC) ^{a)}	Adjust the up-converter image enhancer. Set the luminance range for edge enhancement. 0 to 8 to FH
958	H DETAIL FREQUENCY (UC) ^{a)}	Adjust the up converter image enhancer. Set the center frequency and frequency properties for edge enhancement. 3.2MHz: 3.2 MHz ±1.1 MHz 4.5MHz: 4.5 MHz ±1.4 MHz 5.0MHz: 5.0 MHz ±0.7 MHz 4.0MHz: 4.0 MHz ±2.0 MHz

Menu items in the 900s, relating to digital process

Item number	Item name	Settings	
959	H/V RATIO (UC) ^{a)}	Adjust the up-converter image enhancer. Set the horizontal/vertical ratio for edge enhancement. 0 to 3 to 7	
965	IMAGE ENHANCER (INPUT UP CONVERTER)	Set up the operation of the up converter image enhancer for SD input, separately from the settings for playback (menu items 950 to 959).	
	Sub-Item		
	1	ENH SETTING ^{a)}	pb: While SD signals are input, make the behavior of the image enhancer of the up-converter follow the settings for playback (menu items 950 to 959) (Settings for sub-items 2 to 11 under menu item 965 become invalid). input: While SD signals are input, make the behavior of the image enhancer of the up-converter follow the settings for sub-items 2 to 11 under menu item 965 (separate settings during input of SD signals from those during playback).
	2	CONVERT	Select the up-converter mode. CROP: Select the edge-crop mode. L-BOX: Select the letter box mode. SQUEZ: Select the squeeze mode.
	3	H CROP P	When sub-item UP CONVERTER MODE of menu item 965 is set to "crop", adjust the H-crop (horizontal crop) position for up converter output in edge crop mode. -120 to 0 to 120
	4	L BOX P	When sub-item UP CONVERTER MODE of menu item 965 is set to "l-box", adjust the vertical location of the position where the picture is cut out for up converter output in letter box mode. -120 to 0 to 120
	5	CNV PROC	Select the source picture to use in converting SD to HD. FIELD: Use field pictures. ADAPT: Frame or field is selected automatically.
	6	DETAIL	Adjust the up-converter image enhancer. Set the sharpness of edge enhancement. 0 to 40H to 7FH
	7	LIMITER	Adjust the up-converter image enhancer. Set the maximum detail level added to emphasize the original signal. 0 to 20H to 3FH
	8	CRISP	Adjust the up-converter image enhancer. Set the threshold amplitude at which low amplitude signals are not emphasized. 0 to 8 to FH
	9	DEPEND	Adjust the up-converter image enhancer. Set the luminance range for edge enhancement. 0 to 8 to FH
10	H DETL F	Adjust the up converter image enhancer. Set the center frequency and frequency properties for edge enhancement. 3.2MHz: 3.2 MHz ±1.1 MHz 4.5MHz: 4.5 MHz ±1.4 MHz 5.0MHz: 5.0 MHz ±0.7 MHz 4.0MHz: 4.0 MHz ±2.0 MHz	
11	HV RATIO	Adjust the up-converter image enhancer. Set the horizontal/vertical ratio for edge enhancement. 0 to 3 to 7	

a) **[HDI1500]** When the PDBK-S1500 or PDBK-F1500 option is installed.

However, since with the factory default settings the extended menu is not displayed, it is first necessary to enable display of the extended menu.

Extended menu operations

The extended menu can be used with the same procedures as in the basic menu.

To enable display of the extended menu

Proceed as follows to use the maintenance menu.

- 1 Holding down the PAGE/HOME button and the SHIFT button, press the MENU button.

The maintenance menu appears on the video monitor display.

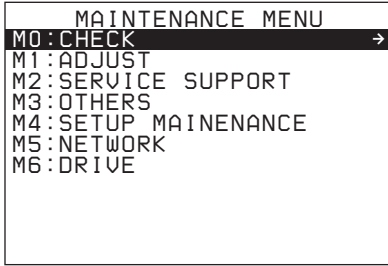

When you next display the menu and change the item display, the extended menu will appear after the basic menu.

- 2 Turn the PUSH SET(S.SEL) knob to select “M4 SETUP MAINTENANCE”, then press the PUSH SET(S.SEL) knob or the SELECT function button (F2).

The sub-items of M4: SETUP MAINTENANCE appears.

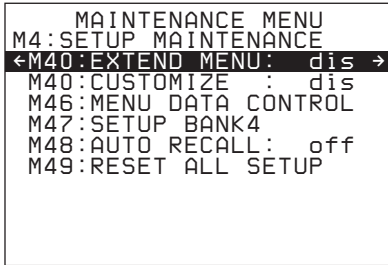

- 3 Turn the PUSH SET(S.SEL) knob to select “M40 EXTENDED MENU”, then press the PUSH SET(S.SEL) knob or the SELECT function button (F2).

The setting screen for M40: EXTENDED MENU appears.

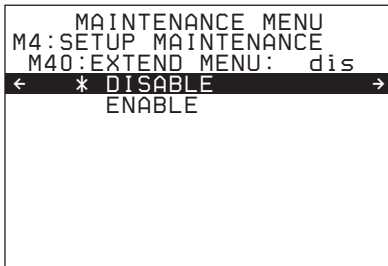

- 4 Turn the PUSH SET(S.SEL) knob to select “ENABLE”, and press the SAVE function button (F5).

The message “NOW SAVING...” appears on the video monitor display, and “Saving...” appears in the time data display area, while the new settings are saved in memory. When the saving operation is completed, the video monitor display and the time data display area return to their normal indications.

Maintenance Menu

Items in the maintenance menu

The following tables show the items in the maintenance menu.

- Item names are the names which appear on the video monitor of this unit and an external monitor to which the output of the COMPOSITE OUTPUT 2 (SUPER) connector, the SDSDI OUTPUT 2 (SUPER) connector, or the HDSDI OUTPUT 2 (SUPER) connector is input. An abbreviated name appears in the time data display area when you press the NEXT button.

- The values in the Settings columns are the values which appear in the time data display area. (The values may appear in a different format on an external monitor. In this case, the external monitor values are shown in parentheses.) Underlined values are the factory defaults.

This manual does not explain the menu items in M0: CHECK, M1: ADJUST, M2: SERVICE SUPPORT, and M6: DRIVE. Refer to the Maintenance Manual for an explanation of these items.

M3: OTHERS: Other setting items

Item	Setting
M30: SOFTWARE VERSION	Display of the software version of this unit
M31: SERIAL NUMBER	Display of the serial number of this unit
M33: FILE I/F CONFIG	PROAV DISPLAY Selects whether or not to display PROAV directory. DISABLE: Do not display PROAV directory. ENABLE: Display PROAV directory.
	PC REMOTE Disables or enables a FAM connection. ENABLE: Enable a FAM connection. F-KEY SELECT: Enable or disable a FAM connection using the function menu.
M36: HOURS METER RESET	Display and reset of the hours meter and the thread counter
M37: AUDIO CONFIG	M370: HEAD ROOM Select the audio reference level (headroom). <u>-20dB</u> , -18dB, -16dB, -12dB, EBUL Note EBUL can be selected only when the system frequency is 50i/50P/25P.
	M371: DATA LEN Select the audio channel configuration for IMX recording. 16bit x 8ch: 16-bit, 8-channel configuration 24bit x 4ch: 24-bit, 4-channel configuration
	M372: NON-AUDIO INPUT Select whether to handle digital audio signals as non-audio signals during recording. Audio (audio): Handle as linear PCM audio signals. data: Handle as non-audio signals.
	Sub-Item
	1 Tr1/Tr2
	2 Tr3/Tr4
	3 Tr5/Tr6
	4 Tr7/Tr8
	M373: INPUT LEVEL Set the upper limit for the signal level input to audio channels 1/3 or 2/4. <u>+4dB</u> , <u>0dB</u> , -3dB, -6dB, EBUL
	Sub-Item
1 CH1/CH3 Note EBUL can be selected only when the system frequency is 50i/50P/25P.	
2 CH2/CH4	
M377: OUTPUT LEVEL Set the reference level for audio output signals. <u>+4dB</u> , <u>0dB</u> , -3dB, -6dB, EBUL Note EBUL can be selected only when the system frequency is 50i/50P/25P.	

M3: OTHERS: Other setting items

Item	Setting	
M38: F-KEY CONFIG	<i>For details, refer to the Maintenance Manual.</i>	
	M380: HOME2	Assign a function menu item to page HOME2 of the function menu as a user setting.
	M381: PAGE8 ASSIGN	Assign a setup menu item to page P8 of the function menu as a user setting.
	M382: PAGE8 NAME	Specify the name of a setup menu item assigned with M381: PAGE8 ASSIGN.
	M38F: NV-RAM CONTROL	Save the settings of M380 to M382.
M39: OTHER CONFIG	M390: MIXED REC	Select whether to enable mixed format recording mode. DISABLE: Do not enable. ENABLE: Enable.
	M391: VITC REC	Select whether to record the VITC in the input HDSDI signals in the LTC user bits area. DIS: Do not record. ENA: Record.
	M392: PB POS	When you switch between the clip playback screen and the clip list playback screen, specifies the clip or sub clip playback start position. KEEP: Play from the position where playback stopped. FORCED TOP: Play from the first frame of the first clip or sub clip.
	<div style="border: 1px solid black; padding: 2px; width: fit-content;">F1600</div> M393: AUDIO DSP	Select the function for which the audio digital signal processor shall be used. linear edit: Use for linear editing (microphone input is disabled). AGC/limiter: Use for microphone input (linear editing is disabled). Note It is not possible to use the audio digital signal processor for multiple functions at the same time.



M3: OTHERS: Other setting items

Item		Setting
M3B: VANC RX PARAMETER	M3B0: VANC RX PACKET	<p>For setting HDSDI VANC data input parameters</p> <p>Notes</p> <ul style="list-style-type: none"> • In 59.94i, 50i, 29.97P or 25P mode, selecting the line also selects the corresponding line in the second field (for example, if line 9 is selected, line 527 is also selected for VANC packet reception). • Menu item M3B0 enables recording of one VANC packet when the selected line contains any packets whose DID/SDID matches the value set with this menu item. • Up to four packets are recorded per each line regardless of the DID and SDID for the VANC set with menu item M3B1 or M3B2. Menu items M3B1 and MSB2 enable recording of up to four VANC packets in the selected line, respectively, regardless of the DID/SDID value. • It is not possible to set the same line with menu items M3B0, M3B1, and M3B2. If the same line is specified, priority is given in the order of M3B0, M3B1, and M3B2 (for example, if the same line is specified with M3B0 and M3B1, the setting with M3B1 is ignored). • When VANC data is output to HDSDI playback signals, the number of the output VANC line is the same as that of the input VANC line. • When a UMID or essence mark line is selected with M3B1 or M3B2, UMID or essence mark output takes priority. To disable UMID or essence mark output, set setup menu item 651 or 657 to "off".
Sub-item		
1	LINE	<p>Selects the lines for the VANC to be received.</p> <p>OFF, 9LINE to 20LINE (59.94i/50i/29.97P/25P/23.98P mode) OFF, 9LINE to 25LINE (59.94P/50P mode)</p>
2	DID	<p>Specification of the DID of the VANC to receive</p> <p>00h-FFh</p>
3	SDID	<p>Specification of the SDID of the VANC to receive</p> <p>00h-FFh</p>
M3B1: LINE1 SEL		<p>Selects the lines to be received for the HDSDI VANC data.</p> <p>OFF, 9LINE to 20LINE (59.94i/50i/29.97P/25P/23.98P mode) OFF, 9LINE to 25LINE (59.94P/50P mode)</p>
M3B2: LINE2 SEL		<p>Selects the lines to be received for the HDSDI VANC data.</p> <p>OFF, 9LINE to 20LINE (59.94i/50i/29.97P/25P/23.98P mode) OFF, 9LINE to 25LINE (59.94P/50P mode)</p>
M3C: POWER SAVE CONTROL		<p>Specification of whether to enable the power saving function</p> <p>OFF, ON</p>
M3D: DATE/TIME PRESET		<p>Specification of the date and time</p>
M3E: USB MEMORY UTIL		<p>For installation of software upgrade</p> <p><i>For details, refer to the Maintenance Manual.</i></p>
M3F: FACTORY SETUP		<p><i>For details, refer to the Maintenance Manual.</i></p>

M4: SETUP MAINTENANCE: items relating to the setup menu

Item	Setting
M40: EXTENDED MENU	<p>Select whether to display the extended menu.</p> <p>DISABLE: Do not display. ENABLE: Display.</p>
M41: CUSTOMIZE	<p>Select whether to enable the customization function of the setup menu.</p> <p>DISABLE: Do not display. ENABLE: Display.</p>

M4: SETUP MAINTENANCE: items relating to the setup menu

Item		Setting
M46: MENU DATA CONTROL	M461: MENU STATUS DISPLAY	Displays the status of the menu bank where the current menu settings are stored.
	M462: SAVE MENU DATA	Select whether to temporarily back up (save) setup menu settings before operations such as software upgrades. SAVE function button (F5): Back up (save) the settings. MENU button: Return to next highest menu level without backing up.
	M463: LOAD MENU DATA	Select whether to restore (load) setting that were backed up (saved) with the "SAVE MENU DATA" item. SAVE function button (F5): Restore (load) the settings. MENU button: Return to the next highest menu level without restoring.
M47: SETUP BANK4		Select the bank to be stored in menu bank 4, or reset menu bank 4. CURRENT TO BANK4: Store the current menu settings in menu bank 4. BANK1 TO BANK4: Store the menu bank 1 settings in menu bank 4. BANK2 TO BANK4: Store the menu bank 2 settings in menu bank 4. BANK3 TO BANK4: Store the menu bank 3 settings in menu bank 4. RESET BANK4: Reset menu bank 4.
M48: AUTO RECALL		Select whether to recall settings automatically from a menu bank when the system is powered on, and if so which menu bank to recall from. off: Do not recall settings from a menu bank. from BANK1: Recall settings from menu bank 1. from BANK2: Recall settings from menu bank 2. from BANK3: Recall settings from menu bank 3. from BANK4: Recall settings from menu bank 4.
M49: RESET ALL SETUP		Reset the current menu settings to the factory settings. SAVE function button (F5): Reset. MENU button: Return to the next highest menu level without resetting. Notes <ul style="list-style-type: none"> The system frequency setting is also cleared. If you execute this item, reset the system frequency (see page 33). Date and time settings are not cleared, but the time zone setting is cleared. After executing this item, reset the time zone (see page 33).

M5: NETWORK: items relating to network settings

Item		Setting
M50: DHCP		Set whether to assign an IP address automatically with the DHCP server. DISABLE: Do not assign automatically. ENABLE: Assign automatically.
M51: IP ADDRESS PRESET		Set the IP address of this unit. 192.168.001.010 Notes <ul style="list-style-type: none"> IP address cannot be set when DHCP is set to "ENABLE". To check the automatically acquired IP address of this unit, close the maintenance menu and then open it again.
M52: SUBNET MASK PRESET		Set the subnet mask. 255.255.255.000 Notes <ul style="list-style-type: none"> Subnet mask cannot be set when DHCP is set to "ENABLE". To check the automatically acquired subnet mask, close the maintenance menu and then open it again.

M5: NETWORK: items relating to network settings

Item	Setting
M53: DEFAULT GATEWAY PRESET	Set the address of the default gateway. 000.000.000.000 Notes <ul style="list-style-type: none"> The address of the default gateway cannot be set when DHCP is set to "ENABLE". To check the automatically acquired address of the default gateway, close the maintenance menu and then open it again.
M54: LINK SPEED	Set the communications speed. AUTO, 10Mbps, 100Mbps, 1000Mbps
M55: DUPLEX	Set the communications method. AUTO, Full Duplex, Half Duplex <i>For how to set the communication method, see "To change network settings" (page 149).</i>
M56: JUMBO FRAME ^{a)}	Set the size of jumbo frames. 9014, 4088, OFF(1514) Note This value does not include the 4 bytes of the FCS (Frame Check Sequence).
M57: DNS1	Set the address of DNS server 1. 000.000.000.000 Notes <ul style="list-style-type: none"> The address of DNS server 1 cannot be set when DHCP is set to "ENABLE". To check the automatically acquired address of DNS server 1, close the maintenance menu and then open it again.
M58: DNS2	Set the address of DNS server 2. 000.000.000.000 Notes <ul style="list-style-type: none"> The address of DNS server 2 cannot be set when DHCP is set to "ENABLE". To check the automatically acquired address of DNS server 2, close the maintenance menu and then open it again.
M59: UPnP	Select whether to enable the UPnP (universal plug and play) function. DISABLE: Disable the UPnP function. ENABLE: Enable the UPnP function.
M5F: RESET NET CONFIG	Reset network settings to the factory defaults. SAVE function button (F5): Reset. MENU button: Return to the next highest menu level without executing the reset.

a) A jumbo frame is a frame larger than the maximum 1514 bytes (not including FCS) of the standard Ethernet frame. Jumbo frames make it possible to deliver larger payloads per packet. Since fewer packets need to be routed, packet processing overhead is lower and network throughput is potentially improved. (Note that this item is enabled only when LINK SPEED is set to "1000Mbps". For it to work, all other devices that handle packets on the network must also support jumbo frames.)

The maintenance menu appears on the video monitor display and the currently-set menu item is displayed in reverse video.

Meanings of indications on the menu screen

On-screen indication	Meaning
Right-pointing arrow (→) at the right of a menu item	Pressing the PUSH SET(S.SEL) knob or the →/OUT button switches to the next lower menu level or to a setting selection screen.
Left-pointing arrow (←) at the left of a menu item	Pressing the PUSH SET(S.SEL) knob or the ←/IN button switches to the previous (higher) menu level.

Maintenance menu operations

This section describes the indications in the maintenance menu and how to change the settings.

To display the maintenance menu

Holding down the PAGE/HOME button and the SHIFT button, press the MENU button.

On-screen indication	Meaning
Character string at the right of a menu item	Current setting of the menu item When shown with a colon (:): the current setting is the same as the factory default setting. When shown with a raised dot (.): the current setting is different from the factory default setting.
An * (asterisk) in a complete list of settings	Factory default setting

To change a menu item setting

Carry out the following operations to change the setting.

For information about how to change network settings see next section “To change network settings”.

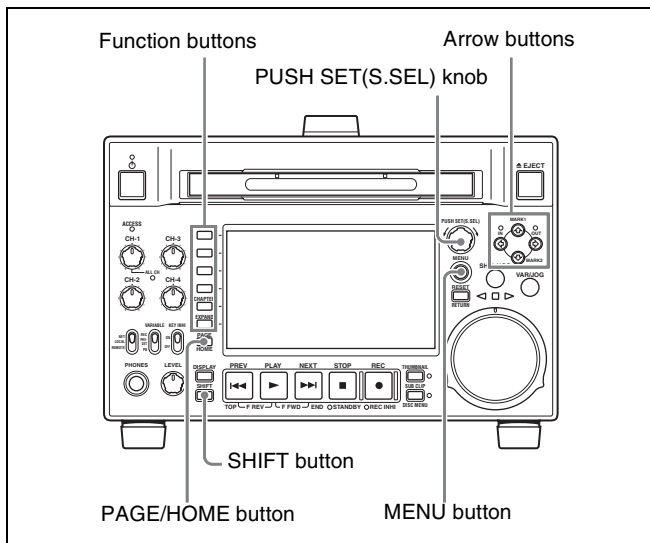

- Use the PUSH SET(S.SEL) knob or the ▲/MARK1 and ▼/MARK2 buttons to select the required item, then press the PUSH SET(S.SEL) knob or the SELECT function button (F2).
The sub-items of the selected item appears.
- Select a sub-item with the same operation as step 1, and use the PUSH SET(S.SEL) knob or the ▲/MARK1 and ▼/MARK2 buttons to change the setting.
- Press the PUSH SET(S.SEL) knob or the SELECT function button (F2) to confirm the setting change.
- Press the SAVE function button (F5).

The message “NOW SAVING...” appears on the video monitor display, and “Saving...” appears in the time data display area, while the new settings are saved in memory. When the saving operation is completed, the video monitor display and the time data display area return to their normal indications.

To cancel changing a setting

Before pressing the SAVE function button (F5), press the MENU button.

The menu disappears from the video monitor display, without saving the new setting.

To change network settings

To change network settings, carry out the procedure described in the previous section, “To display the maintenance menu”, to display the NETWORK menu item, then carry out the following operations.

For details of the settings, consult your network administrator.

When the IP address is assigned automatically

Note

Check that the network cable is connected to this unit before carrying out the operation.

Follow the procedure as shown in previous section “To change a menu item setting” to set maintenance menu item M5: NETWORK >M50: DHCP to “ENABLE”.

To check the assigned IP address

Select maintenance menu item M5: NETWORK >M51: IP ADDRESS PRESET.

Note

If the IP address cannot be assigned, this is shown as “000.000.000.000.” In this case, consult the network administrator.

To set the IP address

First set DHCP to “DISABLE” (*see the previous section, “When the IP address is assigned automatically”*).

- Select maintenance menu item M5: NETWORK >M51: IP ADDRESS PRESET.
- Press the PUSH SET(S.SEL) knob.
The IP address appears, and the digit that can be changed flashes.
- Set the IP address.

To select a different digit to be changed

Use the ◀/IN and ▶/OUT buttons.

To change the value of a digit

Turn the PUSH SET(S.SEL) knob. Turning clockwise increases the value, and turning counterclockwise decreases the value. The ▲/MARK1 and ▼/MARK2 buttons can be used.

To return to the factory default setting

Press the RESET/RETURN button.

- 4 When all digits are set, press the SAVE function button (F5).
This returns to the NETWORK menu.
- 5 Repeat steps 1 to 4 as required, to set the subnet mask and default gateway.
- 6 In the NETWORK menu, press the SAVE function button (F5).
- 7 When the “NOW SAVING...” message vanishes, power the unit off and then on again with the on/standby button.

To set the communications speed and protocol

Set the communications speed (LINK SPEED) and communications method (DUPLEX) to match the network environment.

To set the communications speed and communications protocol, proceed as explained in the previous section “To display the maintenance menu” to display the NETWORK menu and then proceed as follows.

Contact your network administrator if you have any questions about the proper settings for these items.

To set the communications speed

- 1 Select maintenance menu item M5: NETWORK >M54: LINK SPEED.
- 2 Press the PUSH SET(S.SEL) knob.
The communications speeds (AUTO, 10Mbps, 100Mbps, and 1000Mbps) appear, and the arrow flashes.
- 3 Press the PUSH SET(S.SEL) knob or use the ↓/MARK1 or ↑/MARK2 button to select a communications speed.

To return to the factory default setting

Press the RESET/RETURN button.

- 4 Press the SAVE function button (F5).
This returns to the NETWORK menu.

To set the communications protocol

- 1 Select maintenance menu item M5: NETWORK >M55: DUPLEX.

- 2 Press the PUSH SET(S.SEL) knob.

The communications protocols (AUTO, Full Duplex, Half Duplex) appear, and the arrow flashes.

- 3 Press the PUSH SET(S.SEL) knob or use the ↑/MARK1 or ↓/MARK2 button to select a communications protocol.

To return to the factory default setting

Press the RESET/RETURN button.

- 4 Press the SAVE function button (F5).
This returns to the NETWORK menu.

Overview

Planning metadata is a file that contains metadata about the clips to be shot and recorded.

To use planning metadata, you will need to save a file in advance in one of the locations shown below, and insert the media into this unit. (Up to 99 planning metadata files can be saved on one Professional Disc or USB Flash drive.)

Professional Disc: General/Sony/Planning directory ¹⁾

USB Flash drive: General/Sony/Planning directory

1) Created automatically when a disc is formatted.

Manipulating planning metadata

This unit allows you to perform the following operations on planning metadata using the GUI screen.

- To load planning metadata files
- To sort planning metadata
- To check planning metadata properties
- To clear planning metadata
- To switch the title display in the video monitor screen

See “Using planning metadata” (page 92) for details.

To set clip names by using planning metadata

The following two types of clip name strings can be written in a planning metadata file.

- The ASCII format name that appears in the video monitor screen ¹⁾
- The UTF-8 format name that is actually registered as the clip name ²⁾

1) It is also possible to display the UTF-8 format name, or no name (see page 93).

2) When no UTF-8 format name string is specified, the ASCII format name string is registered as the actual clip name.

By loading a file from one of the following locations into the unit’s memory before starting to record, you can register the names in the file as clip names.

There are two ways to load files.

- Automatically load a file that has been written to the following directory on a Professional Disc via an FTP or FAM connection.
- Use a GUI screen to load a file that has been written to the following directories on a Professional Disc or a USB flash drive (see page 92).

File creation rules

File location	File name
Professional Disc: General/Sony/Planning directory ^{a)}	<ul style="list-style-type: none">• Format that can be used in the General directory (see page 107)• Extension: XML
USB memory: General/Sony/Planning directory	<ul style="list-style-type: none">• ASCII characters (up to 63 characters including the extension)• Extension: XML

a) General/Sony/Planning directory is created automatically when a disc is formatted. Automatically when a disc is formatted.

Note

Do not save more than 100 planning metadata files in the above save locations. The unit may fail to load the files correctly if more than 100 are saved.

Clip name string format

In a text editor, modify the two fields in the <Title> tag that contain the clip name strings (the shaded fields in the example below).

Enter a name in the first field in ASCII format (up to 13 characters), and enter another name in the second field in UTF-8 format (up to 52 characters).

Clip name string example

```
<?xmlsp version="1.0" sp encoding="UTF-8"?>←  
<PlanningMetadatasp xmlns="http://
```

```

xmlns.sony.net/pro/metadata/
planningmetadata" _sp_assignId="
P0001" _sp_creationDate="
2008-01-20T17:00:00+09:00" _sp_lastUpdate="
2008-03-28T10:30:00+09:00" _sp_load="
false" _sp_version="1.00">↵
  <Properties _sp_propertyId="
assignment" _sp_update="2008-01-20T09:00:
00+09:00" _sp_modifiedBy="Chris">↵
    <Title _sp_usAscii="Typhoon" _sp_xml:lang="
en">Typhoon_Strikes_Tokyo </Title>↵
  </Properties>↵
</PlanningMetadata>↵

```

In the above example, `_sp` indicates a space and `↵` indicates a carriage return.

Notes

- When creating a file, write each line as a single statement, inserting carriage returns only at the indicated carriage return locations, and inserting no unspecified spaces.
- If the UTF-8 format string is longer than 52 characters, the ASCII format string is used as the clip name string.

Setting clip names

- 1 Load a planning metadata file containing clip names into the unit’s memory (see page 92).
- 2 Carry out steps 2 to 5 of to set the “To assign clip names on this unit” (page 109).
- 3 Turn the PUSH SET(S.SEL) knob to display “PLAN”, and then press the PUSH SET(S.SEL) knob.

Each time that you start recording, the unit automatically creates clip names using the names specified in the planning metadata file. An underscore (_) and a three-digit serial number (001 to 999) is appended to each clip name.

Examples of automatically generated clip names

Clip names displayed in the video monitor screen:
 Typhoon_001, Typhoon_002, ...
 The actually recorded clip names:
 Typhoon_Strikes_Tokyo_001,
 Typhoon_Strikes_Tokyo_002, ... ¹⁾

1) When display of the ASCII format clip name has been selected (see page 93).

Notes

- The serial numbers return to 001 on the next recording operation if you reach number 999.

- Serial numbers are not reset when you power the unit off or exchange discs (newly generated numbers are continuous on the old ones).
- If the ASCII format clip name string is longer than 14 characters, it is displayed in the viewfinder as the first 8 characters + ■ (abbreviated) + the last 4 characters, for a total of 13 characters.

Setting essence mark names by using planning metadata

You can use planning metadata to specify user-defined names for the Shot Mark0 to Shot Mark 9 essence marks that correspond to the 0 to 9 keys on a USB keyboard. When planning metadata that contains user-defined essence mark name strings is loaded into this unit’s memory, the unit displays those names for the essence marks that correspond to the keys and that are recorded when the keys are pressed.

See page 55 for more information about recording essence marks, and see page 151 for more information about how to load files.

Essence mark name string format

Use a text editor to enter essence mark names in the sections indicated by shading in “Essence mark name string example”. Names can be either in ASCII format (up to 32 characters) or UTF-8 format (up to 16 characters).

Note

If a name string contains even one non-ASCII character, the maximum length of that string is 16 characters.

Essence mark name string example

```

<?xml _sp_version="1.0" _sp_encoding="UTF-8"?>↵
<PlanningMetadata xmlns="http://xmlns.sony.net/pro/
metadata/planningmetadata" _sp_assignId="H00123" _sp_
creationDate="2009-04-15T08:00:00Z" _sp_lastUpdate="
2009-04-15T15:00:00Z" _sp_version="1.00">↵
  <Properties propertyId="assignment" _sp_class="
original" _sp_update="2009-04-15T15:00:00Z" _sp_
modifiedBy="Chris">↵
    <Title usAscii="Football Game" _sp_xml:lang="
en">Football Game 15/04/2009</Title>↵
    <Meta name="_ShotMark1" _sp_content="
Goal" />↵
    <Meta name="_ShotMark2" _sp_content="
Shoot" />↵
    <Meta name="_ShotMark3" _sp_content="
Corner Kick" />↵
    <Meta name="_ShotMark4" _sp_content="
Free Kick" />↵
    <Meta name="_ShotMark5" _sp_content="
Goal Kick" />↵
  </Properties>↵
</PlanningMetadata>↵

```



```

<Meta name="_ShotMark6" sp content=
"Foul " />↵
<Meta name="_ShotMark7" sp content=
"PK " />3
<Meta name="_ShotMark8" sp content=
"1st Half " />↵
<Meta name="_ShotMark9" sp content=
"2nd Half " />↵
<Meta name="_ShotMark0" sp content=
"Kick Off " />↵
</Properties>↵
</PlanningMetadata>↵

```

In the above example, `sp` indicates a space and `↵` indicates a carriage return.

You can check user-defined essence mark name strings in the User Defined Essence Marks screen (*see page 93*).

Note

When you create a definition file, enter each statement as a single line with a CRLF only after the last character in the statement line, and do not enter spaces except where specified, except within essence mark name strings.

Appendix

Important Notes on Operation

Use and storage

Do not subject the unit to severe shocks

The internal mechanism may be damaged or the body warped.

Do not cover the unit while operating

Doing so will cause temperatures to rise inside the unit, possibly resulting in failure.

After use

Turn off the on/standby button.

If you plan not to use the unit for a long time, turn off the POWER switch on the rear panel as well.

Shipping

- Remove the disc before transporting the unit.
- If sending the unit by truck, ship, air or other transportation service, pack it in the shipping carton of the unit.

Care of the unit

If the body of the unit is dirty, clean it with a soft, dry cloth. In extreme cases, use a cloth steeped in a little neutral detergent, then wipe dry. Do not use organic solvents such as alcohol or thinners, as these may cause discoloration or other damage to the finish of the unit.

In the event of operating problems

If you should experience problems with the unit, contact a Sony service representative.

Use and storage locations

Store in a level, ventilated place. Avoid using or storing the unit in the following places.

- In excessive heat or cold (operating temperature range: 5°C to 40°C (41°F to 104°F))
Remember that in summer or in warm climates the

temperature inside a car with the windows closed can easily exceed 50°C (122°F).

- In damp or dusty locations
- Locations where the unit may be exposed to rain
- Locations subject to violent vibration
- Near strong magnetic fields
- Close to radio or TV transmitters producing strong electromagnetic fields.
- In direct sunlight or close to heaters for extended periods

To prevent electromagnetic interference from portable communications devices

The use of portable telephones and other communications devices near this unit can result in malfunctions and interference with audio and video signals.

It is recommended that the portable communications devices near this unit be powered off.

Condensation

If you move the unit from a very cold place to a warm place, or use it in a damp location, condensation may form on the optical pickup. Then, if the unit is operated in this state, recording and playback may not be performed properly.

Do the following to prevent this from happening.

- When you move or operate the unit in an environment where condensation may form, be sure to insert a disc in advance.
- Whenever you turn on the on/standby button, check that the HUMID indicator does not appear on the color LCD. If it appears, wait until it disappears before inserting a disc.

About the LCD panel

LCD panels are manufactured with extremely high precision technology that yields effective pixel rates of 99.99% or higher. However, very rarely, one or more pixels may be permanently dark or permanently lit in white, red, blue, or green.

This phenomenon is not a malfunction. Such pixels have no effect on the recorded data, and the unit may be used with confidence even if they are present.

Periodic Maintenance

Digital hours meter

The digital hours meter can provide eight items of information about the operational history of the unit. The information can be displayed in the time data display area and also, by text superimposition, on the monitor connected to the unit. Use the information as a guide in scheduling periodic maintenance.

For periodic maintenance, consult a Sony service representative.

Display modes of the digital hours meter

H01: OPERATION HOURS mode

Displays the total number of hours the unit has been powered on in units of 1 hour.

H02: LASER PARAMETER 0 mode (not resettable)

Of the two optical heads, this shows a counter of the cumulative light output time by one optical head in units of hours.¹⁾

This can be used as a guide in determining when to replace the optical head.

1) The counter advances at different rates during recording and playback. It is also affected by the ambient temperature.

H03: LASER PARAMETER 1 mode (not resettable)

Same as H02.

Of the two optical heads, this shows a counter of the cumulative light output time by the other optical head in units of hours.¹⁾

1) The counter advances at different rates during recording and playback. It is also affected by the ambient temperature.

H11: OPERATION HOURS mode (resettable)

Same as H01 except that the count is resettable.

This can be used as a guide in determining when to replace parts.

H13: SEEK RUNNING HOURS 0 mode (resettable)

Of the two optical heads, this shows the cumulative seek operation time for one optical head in units of hours. The count is resettable.

This can be used as a guide in determining when to replace the seek motor.

H14: SPINDLE RUNNING HOURS mode (resettable)

This shows the cumulative spindle rotation time, in units of hours. The count is resettable.

This can be used as a guide in determining when to replace the spindle motor.

H15: LOADING COUNTER mode (resettable)

Display the total number of times disc has been loaded in the unit. The count is resettable.

H17: SEEK RUNNING HOURS 1 mode (resettable)

Same as H13.

Of the two optical heads, this shows the cumulative seek operation time for the other optical head in units of hours. The count is resettable.

To display the digital hours meter

Press the MENU button to display the setup menu, then turn the PUSH SET(S.SEL) knob to display the required item in the time data display area and on the monitor connected to the unit.

To exit from the digital hours meter

Press the RETURN function button (F1) to return to the setup menu.

Press the EXIT function button (F5) to return to the screen that was displayed before you entered the setup menu.



Troubleshooting

Alarms

An alarm (warning message) appears in the time data display area when an operation is attempted which is inappropriate for the settings on this unit or the state of the disc. Both the alarm message and the action to take to resolve the problem appear in the monitor video section and on the screen of the external video monitor connected to the unit.

REMOTE!

Example alarm in time data display area

ALARM

REMOTE MODE IS SELECTED.

SET REMOTE/LOCAL/NETWORK
SWITCH TO LOCAL.

Example alarm in monitor video section

When an alarm is displayed, remove the alarm cause by following the action to take. If the alarm display does not disappear, contact a Sony service representative. Please note that there are some alarms which do not appear depending on the setting of setup menu item 016 ALARM DISPLAY (see page 124).

See page 126 for more information about setup menu operations.

When the unit is powered on

Alarm message in time data display area	Alarm message in video monitor screen	Description/action
ADJ. Mode!	THE UNIT IS IN ADJUSTMENT MODE. CHECK THE SWITCHES OF S2701 ON THE HPR-23 BOARD AND S1 ON THE VPR-99 BOARD.	This appears when the unit is in adjustment mode. Contact a Sony service representative.
MENU Ver.UP	THE SETUP MENU SOFTWARE HAS BEEN UPGRADED. SET THE SETUP MENU ITEMS TO THE DESIRED SETTINGS.	Reset the settings in the setup menu (see page 127).
ILL. SETUP!	INVALID SETTINGS SELECTED IN SETUP MENU. SET ITEMS IN THE SETUP MENU TO THE APPROPRIATE VALUES. CONTACT SERVICE IF THIS ALARM APPEARS AGAIN AFTER ABOVE PROCEDURE.	Reset the settings in the setup menu (see page 127). If the same message appears after you reset the settings, contact a Sony service representative.
Exchg batt!	BATTERY NEEDS REPLACING. PLEASE CONTACT SERVICE.	The NVRAM battery is exhausted. Contact a Sony service representative.
Update Err!	RUN SOFTWARE UPDATE PROGRAM.	The software version is not properly updated. Update the software version again. If the same message appears after you update the software version, contact a Sony service representative.

When a disc is inserted

Alarm message in time data display area	Alarm message in video monitor screen	Description/action
Unknown FS!	UNKNOWN FILE SYSTEM. PLEASE FORMAT DISC OR EJECT.	Format the disc, or eject it (see page 94).
No FS!	NO FILE SYSTEM.PLEASE EJECT DISC.	Eject the disc.
ILL. Disc!	IRREGULAR DISC IS USED. USE PROFESSIONAL DISC.	Use a Professional Disc.
	IRREGULAR DISC IS USED. PLEASE EJECT DISC.	
Salvage NG!	CLIP SALVAGE WAS NOT COMPLETED.	See "Handling of discs when recording does not end normally (salvage functions)" (page 58).
Salvage XXXX	DISC CANNOT BE RECORDED. FORMAT DISC OR CONTACT SERVICE TO RUN CLIP SALVAGE PROGRAM. (XXXX)	
Over DUR!	EXCESSIVE DURATION IS IN DISC. RECORDING AND PLAYBACK IS NOT POSSIBLE.	Data in excess of the rated capacity is recorded on the disc.
No Support!	FORMAT NOT SUPPORTED. RECORDING AND PLAYBACK IS NOT POSSIBLE.	A disc in an unsupported recording format is loaded. Use a disc in a format supported by this unit.
ILL. Index!	INDEX FILE ERROR. PLEASE FORMAT DISC OR EJECT.	Format the disc, or eject it (see page 94).
Formatting!	AUTO FORMATTING IS EXECUTING.	Wait until the format has been completed and try again.
FORMAT NG!	AUTO FORMATTING WAS NOT COMPLETED.	Eject the disc and insert it again, or insert another disc.
DI read err	CANNOT READ DISC INFORMATION. PLEASE EJECT DISC.	
Read err		
DRV ADJ err	CANNOT PERFORM AUTO DRIVE ADJUSTMENT.	

During front panel operations

Alarm message in time data display area	Alarm message in video monitor screen	Description/action
KEY INHI.! ^{a)}	KEY INHIBIT MODE IS SELECTED. SET KEY INHIBIT SWITCH TO OFF.	This appears when the KEY INHI switch is "on". Set the KEY INHI switch to "off".
REMOTE! ^{a)}	REMOTE MODE IS SELECTED. SET REMOTE/LOCAL/NETWORK SWITCH TO LOCAL.	Set the remote control switch to "LOCAL".
No Disc! ^{a)}	NO DISC.	Insert a disc and try again.

Alarm message in time data display area	Alarm message in video monitor screen	Description/action
REC INHI.!	AUTO FORMATTING WAS NOT COMPLETED. THE DISC WRITE PROTECT TAB IS SET TO SAVE. PLEASE EJECT DISC.	Set the disc's Write Inhibit tab to enable recording (see page 53).
	THE DISC WRITE PROTECT TAB IS SET TO SAVE.	
	AUTO FORMATTING WAS NOT COMPLETED. REC INHIBIT MODE IS SELECTED. CHECK FUNCTION MENU. PLEASE EJECT DISC.	This appears when REC INH on the HOME page of the function menu is set to "ON". Set REC INH to "OFF" (see page 48).
	REC INHIBIT.	This appears if you press the REC button when a disc error has occurred. Correct the disc error and try again.
No Clip! ^{b)}	NO CLIP.	This appears when a playback, search or delete operation is attempted on a disc with no clips recorded on it. Insert a disc with clips recorded on it.
Disc Top! ^{a)}	DISC TOP.	This appears if you press the PREV button or conduct a high-speed reverse search when the unit is stopped at the start of the disc. Use forward search or playback instead.
Disc End! ^{a)}	DISC END.	This appears if you press the NEXT button or conduct a forward high-speed search when the unit is stopped at the end of the disc. Use reverse search or playback instead.
Clip Top!	CLIP TOP.	This appears in single clip playback mode if you execute a reverse search when the unit is stopped at the first frame of a clip. To move to another clip, press the PREV, NEXT, SHIFT + PREV, or SHIFT + NEXT button, or perform a thumbnail search.
Clip End!	CLIP END.	This appears in single clip playback mode if you execute a forward search when the unit is stopped at the last frame of a clip. To move to another clip, press the PREV, NEXT, SHIFT + PREV, or SHIFT + NEXT button, or perform a thumbnail search.
MAX # Clips	DISC CANNOT BE RECORDED TO. FOR MORE RECORDING, DELETE SOME CLIPS.	Delete unneeded clips, or insert a disc with enough free space.
MAX # Files	DISC CANNOT BE RECORDED TO. FOR MORE RECORDING SPACE, DELETE CLIPS OR NON-AV DATA. (GENERAL FILES)	Delete clips or GENERAL files.
Disc Full!	DISC FULL. FOR MORE RECORDING, DELETE SOME CLIPS.	Delete unneeded clips, or insert a disc with enough free space.
MAX# SB CLP ^{b)}	NO MORE SUB CLIPS CAN BE ADDED TO CLIP LIST.	This appears when an attempt is made to add sub clips when 300 sub clips have already been registered. Limit the creation of sub clips to 300 or fewer.
CL OVER DUR ^{b)}	DURATION OF ONE CLIP LIST MUST BE LESS THAN 24 HOURS.	This appears when you try to add a sub clip when the total duration of sub clips in a clip list has already reached 24 hours. Create clip lists so that the total duration is within 24 hours.

Alarm message in time data display area	Alarm message in video monitor screen	Description/action
Run Salvage	EXECUTE SALVAGE PROGRAM.	This appears when recording, E-E display, essence mark recording, or sub clip addition for quick scene selection is attempted on a disc that needs to be salvaged. Try again after salvaging the clips on the disc (see page 58).
CNT mode! ^{a)}	COUNTER MODE IS SELECTED. SET COUNTER SELECT MENU TO TC OR UB.	This appears when CNTR SEL on the HOME page of the function menu is set to "COUNTER", and you try to preset timecode or user bits. To use timecode or user bits, set CNTR SEL to "TC" or "UB" (see page 48).
TC EXT! ^{b)}	TC EXTERNAL IS SELECTED. SET TC INTERNAL MODE IN FUNCTION MENU.	This appears when TCG on page P5 TC of the function menu is set to "EXT", and you try to preset timecode or user bits by setting PRST/RGN to "PRESET". Set TCG to "INT" (see page 51).
REGEN mode! ^{a)}	TCG REGEN MODE IS SELECTED. SET TC PRESET MODE IN FUNCTION MENU.	This appears when PRST/RGN on page P5 TC of the function menu is set to "TC" or "VITC", and you try to preset timecode or user bits. Set PRST/RGN to "PRESET" (see page 51).
REC RUN! ^{a)}	TCG RUN MODE IS SET TO REC RUN. SET TC FREE RUN MODE IN FUNCTION MENU.	This appears when RUN MODE on page P5 TC of the function menu is set to "REC RUN", and you try to preset timecode or user bits. Set RUN MODE to "FREE RUN" (see page 51).
REC mode! ^{b)}	THUMBNAIL(S) CANNOT BE DISPLAYED DURING RECORDING. CANNOT EXECUTE IN REC MODE. DRIVE MAINTENANCE MENU CANNOT BE EXECUTED WHILE IN REC MODE. INPUT SELECTION CANNOT BE CHANGED DURING RECORDING. AUDIO REC MODE CANNOT BE CHANGED DURING RECORDING.	Stop recording and try again.
REC-PAUSE!	TC/UB CANNOT BE PRESET IN REC-PAUSE MODE.	Stop recording and try again.
Disc Exchg!	EXIT DISC EXCHANGE CACHE MODE.	This appears when you perform one of the following operations. <ul style="list-style-type: none"> • Attempt to preset timecode or user bits. • Attempt to make a FAM connection. • Press the button such as PLAY button while the disc is being ejected during disc exchange.
No SEL List ^{b)}	CLIP LIST IS NOT SELECTED.	This appears when you press the SUB CLIP/DISC MENU button while the clip list on the disc is not loaded into the current clip list. Load the clip list (see page 86) and try again.
SB CLP mode ^{b)}	TO ADD AN ESSENCE MARK, EXIT FROM SUB CLIP MODE FIRST.	This appears when an attempt is made to manipulate the essence mark while the SUB CLIP/DISC MENU indicator is lit or to set a clip flag while the clip list is being played back (SUB CLIP indicator is lit). Perform the operation after pressing the SUB CLIP/DISC MENU button to turn it off.
SUB CLIP NG ^{b)}	SUB CLIP IS INVALID. SET APPROPRIATE IN/OUT POINTS.	Set the In and Out points again.
No List! ^{b)}	NO CLIP LIST.	This appears when you try to delete a clip list when there is no clip list saved on the disc. Load the disc that contains the clip list you want to delete.

Alarm message in time data display area	Alarm message in video monitor screen	Description/action
Loading List!	LOADING CLIP LIST.	This appears if the SUB CLIP/DISC MENU button is pressed while a clip list is loading. Wait for the clip list to finish loading and try again.
STOP ONCE! ^{b)}	STOP ONCE, THEN EXECUTE.	This appears when the SUB CLIP/DISC MENU button is pressed while the clip list is being played back or when an attempt is made to open the GUI screen with setup menu item 151 GUI OPERATION set to "stop". Perform the operation after stopping playback.
No EM space	ESSENCE MARK NOT RECORDED. NO SPACE AVAILABLE TO RECORD ESSENCE MARK.	Use the PDZ-1 Proxy Browsing Software to delete unneeded essence marks. Or, delete unneeded shot marks in the chapter thumbnail screen.
EM Full!	NO MORE ESSENCE MARKS CAN BE RECORDED.	
Disc Damage	DISC CANNOT BE RECORDED TO. USE ANOTHER DISC FOR RECORDING.	Use another disc.
NON-AV Full	DISC CANNOT BE RECORDED TO. FOR MORE RECORDING SPACE, DELETE NON-AV DATA. (GENERAL FILES)	Delete unneeded GENERAL files.
Index File!	UNSUPPORT INDEX FILE. DISC CANNOT BE RECORDED TO.	Use another disc.
File System	CURRENT VERSION OF THE SOFTWARE SETS THE DISC WRITE PROTECTED.	This appears when you insert a disc that can be played back but not recorded. Exchange the disc for one with a file system supported by this unit. Or format the disc (see page 94).
	FILE SYSTEM ON THE DISC INHIBITS WRITING.	
Loading! ^{a)}	LOADING.	This appears if you press a button while a disc is loading. Wait until the disc has finished loading and try again.
Unloading! ^{a)}	UNLOADING.	This appears if you press a button while a disc is unloading. Wait until the disc has finished unloading and try again.
Clip lock!	CLIP IS LOCKED. UNLOCK CLIP IN THUMBNAIL MENU.	This appears when an operation is attempted on a locked clip, or when an edit preset command is received for such a clip. Use the Thumbnail Menu to unlock the clip (see page 83) and try again.
File Access	CANNOT CHANGE SETTINGS DURING FILE ACCESS.	This appears when an attempt is made to change the setting of PC RMT (ENABLE/DISABLE) on page P7 OTHER of the function menu while accessing a file or processing the command with PC REMOTE.
Inhibit!	PC REMOTE IS DISABLED. CHECK MAINTENANCE MENU M33.	This appears when an attempt is made to change the setting of PC RMT (ENABLE/DISABLE) on page P7 OTHER of the function menu while maintenance menu item M33: FILE I/F CONFIG >PC REMOTE is set to "ENABLE".
	PC REMOTE IS DISABLED. CHECK SETUP MENU 215.	This appears when an attempt is made to change the setting of PC RMT (ENABLE/DISABLE) on page P7 OTHER of the function menu while setup menu item 215 i.LINK mode is set to the value other than "FAM".
GUI Inhibit	GUI OPERATION IS INHIBITED. CHECK SETUP MENU.	This appears when the THUMBNAIL button or the DISC MENU (SHIFT+SUB CLIP) button is pressed while setup menu item 151 GUI OPERATION is set to "dis".

Alarm message in time data display area	Alarm message in video monitor screen	Description/action
Mixed REC!	THIS DISC CANNOT BE RECORDED. TWO OR MORE AUDIO OR VIDEO FORMATS ARE RECORDED ON THE DISC.	This appears if a disc containing clips recorded in different recording formats is inserted while mixed format recording mode is disabled. Enable mixed format recording mode, or insert another disc.
Mixed REC! ^{b)}	DISC CANNOT BE EDITED. MIXED AUDIO/VIDEO MODE ON DISC.	This appears when an edit preset command is received, but the inserted disc contains clips with mixed recording formats. Exchange the inserted disc for a disc that does not contain clips with mixed recording formats.
Resolution	THIS CLIP CANNOT BE ADDED. THE CLIP'S RESOLUTION DOES NOT MATCH THE CLIP LIST'S RESOLUTION.	Clips can be registered in clip lists only if their resolution (number of system lines) matches the resolution of clips in the clip list.
i.LINK! ^{b)}	CANNOT EDIT AV MATERIAL WHEN INPUT SIGNAL IS VIA i.LINK.	This appears when an edit preset command is received, but "i.LINK" is selected as the input signal. Under V INPUT on the P1 VIDEO page of the function menu, select a signal other than "i.LINK".
SD Input! ^{b)}	CANNOT EDIT AV MATERIAL WHEN INPUT SIGNAL IS VIA SD-SDI.	This appears when an edit preset command is received, but the recording format is set to HD422 and "SDSDI" is selected as the video input signal. Under V INPUT on the P1 VIDEO page of the function menu, select "HDSDI".
NON-AUDIO! ^{b)}	AUDIO INSERT EDITING WITH INDEPENDENT CHANNELS IS NOT POSSIBLE. CHANGE 'NON-AUDIO INPUT' IN MAINTENANCE MENU FROM 'DATA' TO 'AUDIO'.	This appears when digital audio signals are set to "data" and an edit preset command is received for individual channels in the audio input channel pairs (CH1/2, CH3/4, CH5/6, CH7/8). To perform insert editing of non-audio signals, always operate on channel pairs. If you want to perform insert editing of the audio of individual channels from channel pairs, set maintenance menu item M37: AUDIO CONFIG >M372: NON-AUDIO INPUT to "audio".
List Exists	DISC CANNOT BE EDITED. DELETE ALL CLIP LIST BEFORE BEGINNING DESTRUCTIVE EDITING.	This appears when an edit preset command is received but the inserted disc contains a clip list. Exchange the disc for one that does not contain a clip list, or delete all clip lists from the disc.
N/A Clip! ^{b)}	CANNOT EDIT AV MATERIAL. CHECK REC FORMAT IN CLIP.	This appears when an edit preset command is received for an HD420 clip or another clip that cannot be edited. Check the recording format of the edit target clip (see page 59).
Mode Err! ^{b)}	CANNOT EDIT AV MATERIAL. CHANGE 'SNGL CLIP PB' TO 'OFF' AND 'REC MODE' TO 'NORMAL' IN SETUP MENU.	This appears when an edit preset command is received but the unit is in Single Clip Playback mode, Disc Exchange Cache mode, or Clip Continuous Rec mode. Set setup menu item 154 SINGLE CLIP PLAY MODE to "off", or set setup menu item 150 REC MODE to "normal".
N/A Disc! ^{b)}	DISC CANNOT BE EDITED. USE PFD23A OR PFD50DLA.	This appears when an edit preset command is received, but linear editing is not possible for the inserted disc. Insert a disc that can be edited by linear editing (see page 60).

a) Displayed only when setup menu item 016 ALARM DISPLAY is set to "on".

b) Displayed only when setup menu item 016 ALARM DISPLAY is set to "on" or "limit".

During recording and editing operations

Alarm message in time data display area	Alarm message in video monitor screen	Description/action
Input Sig! ^{a)}	VIDEO INPUT SIGNAL DOES NOT MATCH SYSTEM SETUP.	This appears when the signal that does not correspond to the system frequency or the number of lines set in this unit is being input, or when HDSDI or i.LINK TS is selected as a video input signal while setting the SD signal recording. Input a signal that matches the system frequency, or change this unit's system frequency setting (see page 43).
ILL. REC! ^{a)}	ENCODING DOES NOT SYNCHRONIZE WITH REF VIDEO.	Check the signals being input to this unit.
ILL. REF! ^{a)}	INPUT VIDEO SIGNAL DOES NOT SYNCHRONIZE WITH REF VIDEO SIGNAL. USE COMMON REFERENCE SIGNAL OR CONNECT RECORDER REF OUT TO PLAYER REF IN.	Input a reference signal synchronized with this unit's system frequency.
MEM. Full! ^{a)}	MEMORY FULL !!	Check the disc being recorded by this unit.
Verify ERR!	DISC ERROR DETECTED.	This appears when an error is found in the signal recorded on the disc while performing the recording verification function. Change the disc.
Recording	NOW RECORDING ...	Wait for recording to finish.
Cache Full!	CACHE FULL. DATA IS BEING OVERWRITTEN.	This appears when the memory becomes full while performing the disc exchange cache function. Change the disc immediately.
Clip End!	EDITING ACROSS MULTIPLE CLIPS IS NOT POSSIBLE.	This appears when an edit across multiple clips is attempted. It is not possible to edit across multiple clips.
Disc Full!	DISC FULL. FOR MORE RECORDING, DELETE SOME CLIPS.	This appears when the free capacity of the disc is exhausted during assemble editing. Delete unneeded clips, or exchange the disc for one with enough free capacity.
REC Format! ^{a)}	REC MODE SELECTION DIFFERENT FROM AUDIO/VIDEO ON DISC. MATCH REC MODE SELECTION WITH CLIP.	This appears when editing of mixed recording formats is enabled and an attempt is made to edit an underlying clip in a different recording format. Reset the recording format to match the format of the editing target clip (see page 60).
Preroll! ^{a)}	PREROLL TIME SETTING IS SHORT.	This appears when editing is impossible because the preroll time is too short. Set setup menu item 001 PREROLL TIME to 5 seconds or longer.
Last Clip! ^{a)}	ASSEMBLE EDITING IS NOT POSSIBLE BESIDES LAST CLIP.	This appears when an attempt is made to perform an assemble edit on a clip that is not the last clip on the disc. Assemble editing is possible only on the last clip.

a) Displayed only when setup menu item 016 ALARM DISPLAY is set to "on" or "limit".

During playback

Alarm message in time data display section	Alarm message in monitor video section	Description/action
ILL. PLAY! ^{a)}	ILLEGAL PLAYBACK.	Check the disc being played by this unit.
MEM. Empty! ^{a)}	MEMORY EMPTY !!	Check the disc being played by this unit.
Disc Error!	DISC ERROR DETECTED.	Use another disc.

a) Displayed only when setup menu item 016 ALARM DISPLAY is set to “on” or “limit”.

During thumbnail search, scene selection, and clip list operations

Alarm message in GUI screen	Description/action
Cannot Expand Clip any Further.	The clip cannot be expanded into more blocks. This appears when the EXPAND button is pressed when the number of block is maximum, or when the duration of an expanded thumbnail is 1 frame.
Selected Essence Mark does not Exist.	The selected essence mark does not exist. This appears in the essence mark selection screen when the specified essence mark does not exist on the disc.
Sub Clip is Invalid. Set Appropriate IN/OUT Points.	The temporal relationship between the specified In and Out points in sub clip trimming is not correct. Reset so that the value of the Out point timecode is larger than the value of the In point timecode.
Duration of One Clip List must be Less than 24 Hours.	The total duration of the current clip list is greater than 24 hours. This appears when the total duration of the current clip list exceeds the upper limit of 24 hours as the result of adding or trimming sub clips.
No More Sub Clips can be Added to the Clip List.	The upper limit of sub clips in the current clip list has been reached. This appears when the upper limit of 300 clips in a clip list has been reached as the result of adding or trimming sub clips.
Sub Clip does not Exist.	There are no sub clips in the current clip list. This appears when an attempt is made to move, trim or delete sub clips or preset timecode.
Clip List does not Exist.	There are no clip lists on the disc. This appears when an attempt is made to execute a Delete Clip List operation when there are no clip lists on the disc.
Move is Invalid.	The sub clip cannot be moved. This appear when an attempt is made to execute a Move Sub Clips operation when there are no sub clip in the current clip list, or when there is only one sub clip.
Chapter does not Exist.	The specified chapter has not been recorded. This appears when an attempt is made to display a chapter when a chapter has not been recorded for that clip.
Some Essence Mark cannot be Deleted.	The essence mark cannot be deleted. This appears when an attempt is made to delete an essence mark that cannot be deleted with a Delete Essence Mark operation. Rec Start and Cut essence marks cannot be deleted.
Some Essence Mark cannot be Moved.	The essence mark cannot be moved. This appears when an attempt is made to move an essence mark that cannot be moved with a Move Essence Mark operation. Rec Start and Cut essence marks cannot be moved.
Clip is Locked.	The clip is locked. This appears when an attempt is made to delete a clip, set the clip thumbnail, or delete a shot mark when the clip is locked.
All Clips are Locked.	All clips are locked. This appears when an attempt is made to execute a Lock All Clips operation when all clips are already locked.
All Clips are Unlocked.	All clips are unlocked. This appears when an attempt is made to execute an Unlock All Clips operation when all clips are already unlocked.
Command Disabled.	This appears when an attempt is made to perform Format Disc operation while Disable “Format Disc” is set to “Disable”.
A File with the Name you Specified Already Exists. Specify a Different Name.	This appears when an attempt is made to set an existing clip name while changing the clip name using Set Clip Name.
Set NAMING FORM to “free”	This appears when an attempt is made to change the clip name using Set Clip Name even though NAMING FORM is not set to “free” (see page 109).
“No Flash Drive”	This appears when an attempt is made to select “USB Flash Drive” in the media selection screen under Load Planning Metadata/Select Drive even though the USB memory is not connected.

Alarm message in GUI screen	Description/action
Not Loaded.	This appears when a command related to planning metadata is executed with no planning metadata loaded. Load planning metadata and try again.
Syntax Error!	This appears when loading of planning metadata fails because of a syntax error. Correct the syntax error and try loading the metadata again.
Irregular Disc is Used. Use Professional Disc.	This appears when the unit is unable to record or play the inserted disc. This unit can record and play Professional Discs. Insert a Professional Disc.
The Disc Write Protect TAB is set to Save.	This appears when an attempt is made to format a write-protected disc. Try formatting the disc after moving the write protect tab away from the Save position.
The REC Inhibit Mode is Selected. Check Function Menu.	This appears when an attempt was made to format when function menu item HOME >F3: REC INH is set to "ON". Set F3: REC INH to "OFF" and try formatting again.
Auto Formatting was not Completed.	This appears when auto formatting fails.
Video Resolution Differ from it on Clip List.	This appears when an attempt is made to add a clip to a clip list containing clips with a different video resolution (number of system lines). It is not possible to add clips to clip lists containing clips with a different video resolution.
No Clip Meets the Condition.	This appears when no clip is found to meet clip filtering conditions.

Alarms relating to audio and video signals

Alarm message in time data display area	Alarm message in video monitor screen	Action
No INPUT! ^{a)}	INPUT VIDEO IS NOT DETECTED. CHECK THE VIDEO INPUT MODE AND SUPPLY A VIDEO SIGNAL TO VIDEO INPUT.	<ul style="list-style-type: none"> Check the setting of V INPUT on Page P1 VIDEO of the function menu (<i>see page 49</i>). Input an HDSDI signal.
EMPHASIS! ^{a)}	INPUT AUDIO EMPHASIS IS NOT SUPPORTED. CHECK THE EMPHASIS OF THE AUDIO INPUT SIGNAL.	Check the emphasis of the audio input signal.
REF NON-STD	A NON-STANDARD REF SIGNAL IS BEING USED FOR REF VIDEO. USE A STANDARD SIGNAL.	Input a standard signal.

a) Displayed only when setup menu item 016 ALARM DISPLAY is set to "on".

Alarms relating to sensors and drives

Alarm message in time data display area	Alarm message in video monitor screen	Description/action
FAN Stopped	FAN MOTOR STOPPED.	Contact a Sony service representative.
DR-FAN Stop	DRIVE FAN MOTOR STOPPED.	Note The unit will not stop operating, but if you continue to use it in this state temperatures inside the unit or the drive will rise, possibly resulting in failure or fire.
N-FAN Stop	FAN MOTOR ON NET-4 BOARD STOPPED.	
High TEMP!	HIGH TEMPERATURE.	
	HIGH TEMPERATURE IN DRIVE. HIGH TEMPERATURE ON NET-4 BOARD.	
HUMID!	MOISTURE HAS BEEN DETECTED.	Stop recording or playback, power the unit off and on again, and wait until the HUMID display disappears.
BATT EMPTY!	BATTERY EMPTY!	Change the battery.

Alarm message in time data display area	Alarm message in video monitor screen	Description/action
Unknown USB	UNKNOWN USB DEVICE.	The USB connector of this unit is for maintenance purposes and connection of USB devices. Connect a compatible USB device.

Alarms related to system frequency and recording format

The following alarms are displayed only when setup menu item 016 ALARM DISPLAY is set to “on” or “limit”.

Alarm message in time data display area	Alarm message in video monitor screen	Action
1080/59.94i 1080/29.97P 1080/50i 1080/25P 1080/23.98P 720/59.94P 720/50P 525/59.94i 625/50i	RECORDING AND PLAYBACK IS NOT POSSIBLE. SYSTEM SETTINGS DIFFERENT FROM DISC.	This appears when the system frequency of the unit differs from that of the loaded disc. Insert a disc with the same system frequency as the unit, or change the unit's system frequency.
1080/59.94i 1080/50i 1080/29.97P 1080/25P 1080/23.98P 720/59.94P 720/50P	DISC CANNOT BE RECORDED. VIDEO RESOLUTION DIFFER FROM IT ON DISC.	This appears when mixed format recording mode is disabled and the current system lines setting of this unit does not match the resolution of the inserted disc. Insert a disc with a resolution that matches the current system lines setting of this unit, or change the system lines setting of this unit, or enable mixed format recording mode.
HD422 1080 HD422 720 HD420 1080 HD420 720 IMX50 Clip IMX40 Clip IMX30 Clip	DISC CANNOT BE RECORDED. VIDEO REC MODE SELECTION DIFFERENT FROM VIDEO ON DISC.	This appears when mixed format recording mode is disabled, and the video recording format of this unit does not match the video recording format of the inserted disc. Insert a disc with a video recording format that matches the video recording format of this unit, or change the video recording format of this unit.
8CH×16 Clip 4CH×24 Clip 2CH×16 Clip	DISC CANNOT BE RECORDED. AUDIO REC MODE SELECTION DIFFERENT FROM AUDIO ON DISC.	This appears when mixed format recording mode is disabled, and the audio recording format of this unit does not match the audio recording format of the inserted disc. Insert a disc with a audio recording format that matches the audio recording format of this unit, or change the audio recording format of this unit.

Error messages

Error codes appear in the time data display when an error (usually a hardware problem) occurs. In addition, both error messages and error codes appear in the monitor video section and on the video monitor connected to the unit. When an error message appears, follow the instructions in the error message to resolve the problem.

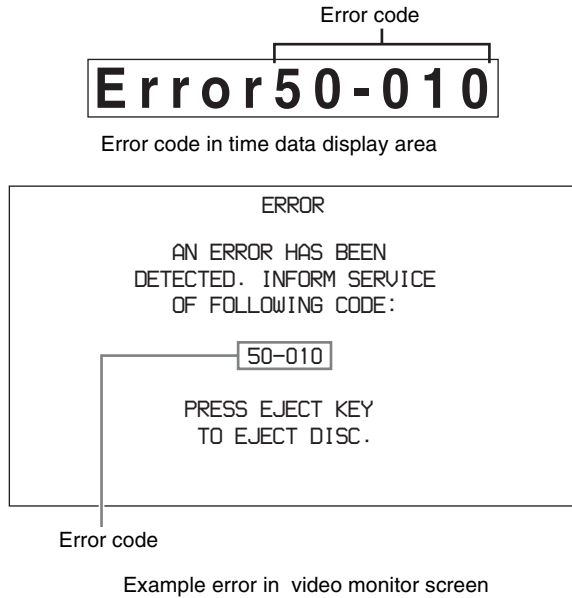

To eject discs with the unit powered off

As an emergency measure, disc cartridges can be removed with the unit powered off. This operation should always be done by a trained service technician.

Specifications

General

External dimensions (w/h/d, excluding projections)
210×132×396 mm (8 3/8×5 1/4×15 5/8 inches)

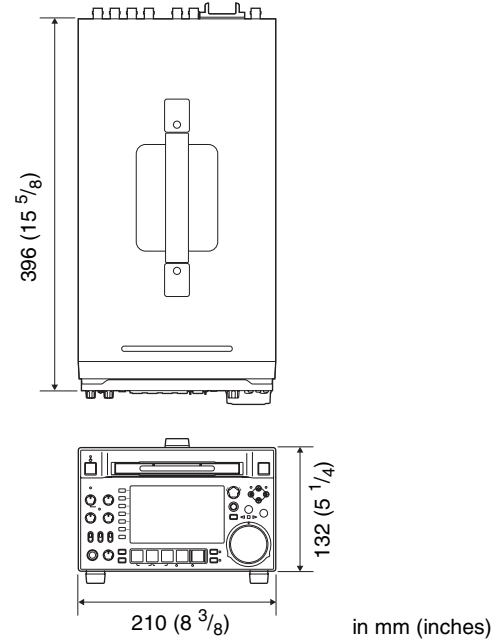

Mass	6.5 kg (14 lb. 5 oz.)
Power requirements	100 V to 240 V AC, 50/60 Hz 12 V DC
Power consumption	AC operation: 80 W DC operation: 65 W (Power saving mode: 55 W)
Peak inrush current	(1) Power ON, current probe method: 45 A (240 V), 18 A (100 V) (2) Hot switching inrush current, measured in accordance with European standard EN55103-1: 11 A (230 V)
Operating temperature	5°C to 40°C (41°F to 104°F)
Storage temperature	-20°C to +60°C (-4°F to +140°F)
Operating relative humidity	25 to 90%

System

Recording/playback format

Video	MPEG HD 422: 50 Mbps
Proxy video	MPEG-4

Audio 24 bits, 48 kHz, 8 channels
Proxy audio A-law 8 bits, 8 kHz, 8 channels

Recording/playback times

PFD23A discs Approx. 43 minutes
PFD50DLA discs
Approx. 95 minutes

Note

The recording and playback times listed above are approximate. Maximum recording times may vary depending on recording conditions.

Search speed

Jog mode -1 to +1 times normal speed
Variable-speed mode
-2 to +2 times normal speed
Shuttle mode -20 to +20 times normal speed
Fast forward mode
+35 times normal speed
Fast reverse mode
-35 times normal speed

Video performance

Sampling frequency
Y: 74.25 MHz, R-Y/B-Y: 37.125 MHz
Quantization 8 bits/sample
Compression MPEG-2 422P@HL

Composite output

Frequency response
0.5 to 5.75 MHz+0.5/-2.0 dB
S/N (Y) 53 dB or more
Y/C delay ±20 ns or less
K-factor (K2T) 1.0% or less

Processor adjustment range

Video level $-\infty$ to +3 dB
Chroma level $-\infty$ to +3 dB
Set up/black level
±30 IRE/±210 mV
Chroma phase ±30°
System phase SYNC: ±15 μs
SC: 0 to +400 ns

Audio performance

Sampling frequency
48 kHz
Quantization 24 bits
Headroom -20/-18/-16/-12 dB (selectable)
Frequency response
20 Hz to 20 kHz +0.5/-1.0 dB (0 dB at
1 kHz)
Dynamic range 90 dB or more
Distortion 0.05% or less (at 1 kHz)

Input connectors

Digital video inputs

SD/HDSDI INPUT

BNC type (×1), complying with SMPTE-259M (SD)/SMPTE-292M (HD)

i.LINK S400

6-pin type (×1), complying with IEEE 1394

Analog video inputs

REF.VIDEO INPUT

BNC type (×2, loop-through), HD Tri-level sync (0.6 Vp-p/75 Ω/sync negative), SD black burst, or SD composite sync (0.286 Vp-p/75 Ω/sync negative)

Analog audio inputs

ANALOG AUDIO INPUT 1, 2

XLR 3-pin, female (×2), +4 dBu, high impedance, balanced

Digital audio inputs

DIGITAL AUDIO (AES/EBU) IN 1/2, 3/4

BNC type (×2), 1/2ch, 3/4ch complying with AES-3id-1995

Timecode input

TIME CODE IN

BNC type (×1), SMPTE timecode, 0.5 to 18 Vp-p, 10 kΩ, unbalanced

Output connectors

Digital video outputs

HDSDI OUTPUT 1, 2(SUPER)

BNC type (×2), complying with SMPTE-292M

SDSDI OUTPUT 1, 2(SUPER)

BNC type (×2), complying with SMPTE-259M

Analog video outputs

COMPOSITE OUTPUT 1, 2(SUPER)

BNC type (×2), 1.0 Vp-p, 75 Ω, sync negative, complying with SMPTE-170M

Analog audio outputs

ANALOG AUDIO OUTPUT 1, 2

XLR 3-pin, male (×2), +4 dBu, 600 Ω, low impedance, balanced

AUDIO MONITOR

XLR 3-pin, male (×2), +4 dBu, 600 Ω, low impedance, balanced

PHONES

Stereo phone jack (×1), $-\infty$ to -13 dBu, 8 Ω, unbalanced

Digital audio outputs

DIGITAL AUDIO (AES/EBU) OUTPUT 1/2, 3/4
BNC type (×2), 1/2 ch, 3/4 ch complying
with AES-3id-1995

Timecode output

TIME CODE OUT
BNC type (×1), SMPTE timecode,
1.0 Vp-p, 75 Ω, unbalanced

Remote control connectors

REMOTE(9P) D-sub 9-pin, female (×1), complying
with RS-422A

VIDEO CONTROL

D-sub 9-pin, female (×1), complying
with EIA RS-423

REMOTE 4-pin, female (×1)
DC 12 V, 7.5 W

 Network RJ-45 type (×1)
100BASE-T: complying with
IEEE802.3ab
100BASE-TX: complying with
IEEE802.3u
10BASE-T: complying with IEEE802.3

Other

MAINTENANCE connectors
(High Speed USB (USB 2.0) Type-A)

Accessories supplied

Operation manuals

English version (1)
Japanese version (1)
CD-ROM manual (1)

Installation manual (1)

XDCAM Application Software CD-ROM (1)

Connector caps

Accessories not supplied

AC power cord

- For the customers in the U.S.A and Canada
Part number 1-551-812-41 (125 V, 10 A, about 2.4 m)
- For the customers in the United Kingdom
Part number 1-777-823-12 (250 V, 10 A, about 2.0 m)
- For the customers in European countries other than the
United Kingdom
Part number 1-551-631-61 (250 V, 10 A, about 2.0 m)

RCC-G5 9-pin Remote Control Cable

RM-280 Remote Edit Controller

PFD23A Professional Disc

PFD50DLA Dual-layer Professional Disc

BP-L80S Battery Pack

BP-GL95 Battery Pack

BKP-L551 Battery Adaptor

MPEG TS Board

PDBK-201

HD1500

SD Record And Playback Key

PDBK-S1500

24P Record And Playback Key

PDBK-F1500

Design and specifications are subject to change without notice.

Notes

- Always make a test recording, and verify that it was recorded successfully. SONY WILL NOT BE LIABLE FOR DAMAGES OF ANY KIND INCLUDING, BUT NOT LIMITED TO, COMPENSATION OR REIMBURSEMENT ON ACCOUNT OF FAILURE OF THIS UNIT OR ITS RECORDING MEDIA, EXTERNAL STORAGE SYSTEMS OR ANY OTHER MEDIA OR STORAGE SYSTEMS TO RECORD CONTENT OF ANY TYPE.
- Always verify that the unit is operating properly before use. SONY WILL NOT BE LIABLE FOR DAMAGES OF ANY KIND INCLUDING, BUT NOT LIMITED TO, COMPENSATION OR REIMBURSEMENT ON ACCOUNT OF THE LOSS OF PRESENT OR PROSPECTIVE PROFITS DUE TO FAILURE OF THIS UNIT, EITHER DURING THE WARRANTY PERIOD OR AFTER EXPIRATION OF THE WARRANTY, OR FOR ANY OTHER REASON WHATSOEVER.

Using PDZ-1 Proxy Browsing Software

When a computer with the PDZ-1 Proxy Browsing Software installed is connected to this unit, you can transfer the proxy AV data and metadata files recorded on a disc to the computer. On the computer side, PDZ-1 enables you to browse the proxy AV data, add or modify metadata (titles, comments, essence marks, etc.), or create a clip list.

The modified metadata and the created clip list can then be written back to the disc loaded in this unit.

For more information about PDZ-1 functions and operations, refer to the PDZ-1 help.

System requirements

The following are required to use PDZ-1.

- Computer: PC with Intel Pentium M processor, at least 1 GHz (installed memory: at least 512 MB)
- Operating system: Microsoft Windows XP Professional SP2 or higher, Windows Vista Ultimate/Business (32 bit)
- Web browser: Internet Explorer 6.0 SP1 or higher
- DirectX: DirectX 8.1b or higher

To install PDZ-1

Insert the supplied XDCAM Application Software CD-ROM into the CD-ROM drive of your computer, and then run the installer in the PDZ-1 directory of the CD-ROM.

For details, refer to the ReadMe file contained on the CDROM disc.

Notes

- Make sure that the hard disk drive on which the work folder to store the material transferred from this unit has adequate free space.
- To transfer files between the computer and this unit requires this unit's IP address and other network-related settings to be made.

For details of the network-related settings, see "To change network settings" (page 149).

Using UMID Data

Metadata is additional information recorded on discs along with audio-visual data. It is used to bring greater efficiency to the flow of operations from material acquisition through editing, and to make it easier to find and reuse material. As one of application of metadata, the UMID has been internationally standardized.

What is a UMID?

A UMID (Unique Material Identifier) is a unique identifier for audio-visual material defined by the SMPTE-330M-2003 standard.

A UMID may be either as a 32-byte Basic UMID or an Extended UMID, which includes an additional 32 bytes of Source Pack to make a total 64 bytes.

For details, refer to SMPTE-330M.

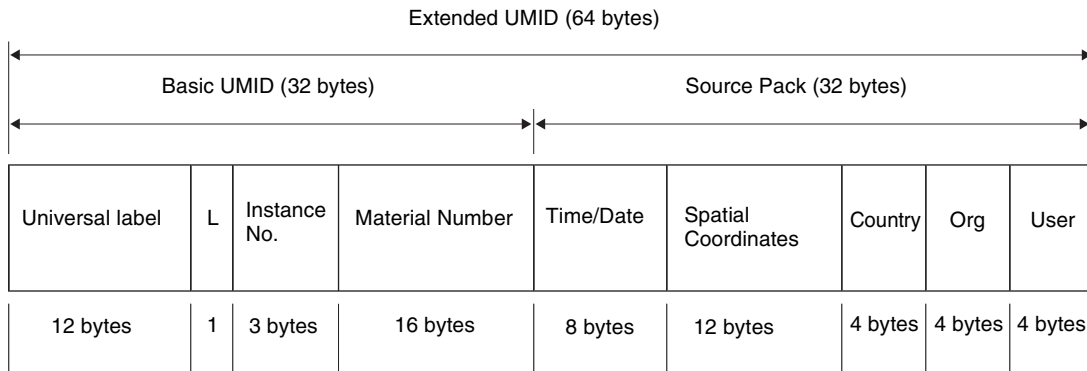

A globally unique ID is automatically recorded for every clip.

The Extended UMID is metadata that provides additional information such as location, time/date, company ID and so on.

The UMID is applied as follows.

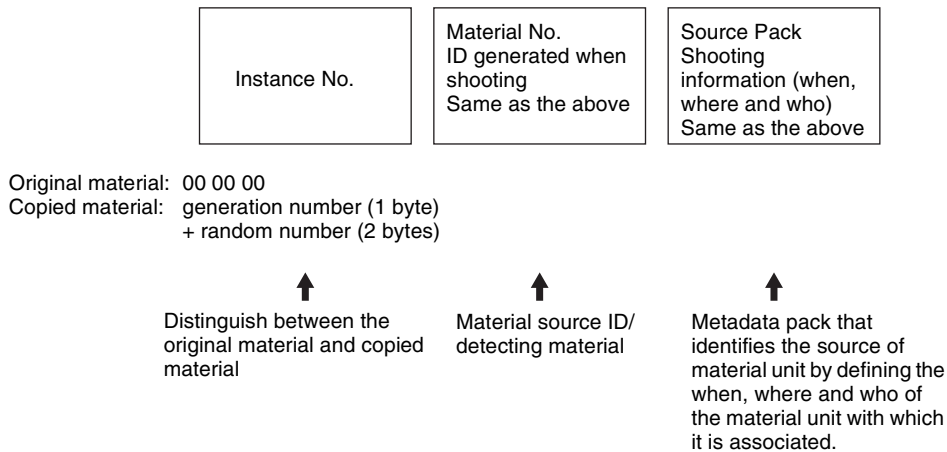

Using the Extended UMID

You have to enter a country code, organization code and user code. Set the country code referring to the table in ISO 3166, and set the organization code and user code according to the guidelines of your organization.

For details, see “Setting UMID ownership information” (page 172).

Functions of UMID data

UMID data enables the following:

- Addition of a globally unique ID to every clip of audio-visual material. The unique ID is used to detect the material source and to link it with the original source material.
- Distinguishing between original material and copied material. 00 is added to the Instance Number for original material.

- Recording with UTC time. UTC (coordinated universal time) is used when recording the UMID. Use of a universal time system enables uniform management of source material recorded all over the world.
- Calculation of date differences. Source material is recorded using modified Julian dates (MJD), which enables easy calculation of date differences between different source material items.

Setting UMID ownership information

Proceed as follows.

- 1 Set setup menu item 029 STORE OWNER to “on” (see page 124).

See page 126 for more information about setup menu operations.

The STORED OWNERSHIP (UMID ownership information setting) screen appears.

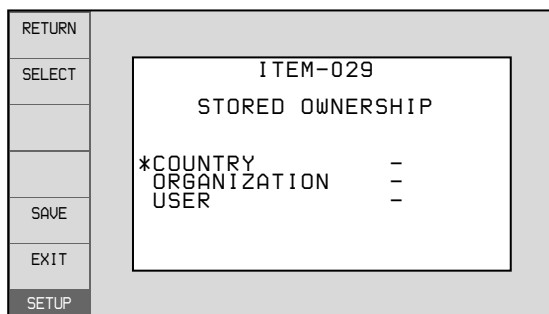

COUNTRY: Sets the country code.

ORGANIZATION: Sets the organization code.

USER: Sets the user code

See the next item “About the UMID ownership information” for more information about these codes.

- 2 Use the PUSH SET(S.SEL) knob to select the item to set and the character input location, then press the knob.

- 3 Use the PUSH SET(S.SEL) knob, – or + function button (F3 or F4) to select characters to input at the selected location.

To delete all input data

Press the RESET/RETURN button.

- 4 Press SAVE function button (F5).

The message “NOW SAVING...” appears, and the ownership information is saved.

About the UMID ownership information

COUNTRY (country code)

Set the country code by entering an abbreviated alphanumeric string (4-byte alphanumeric string) according to the values defined in ISO 3166-1.

There are about 240 country codes.

Find your own country code on the following web page.

Refer to ISO 3166-1:

http://www.iso.org/iso/country-codes/iso_3166_code_lists.htm

When the country code is less than 4 bytes, the active part of the code occupies the first part of the 4 bytes and the remainder must be filled with the space character (20h).

Example: Japan

For Japan, the country code is JP, which is 2 bytes, or JPN, which is 3 bytes.

Thus, enter the following:

JP _ _

or

JPN _

where _ represents a space.

ORGANIZATION (organization code)

Enter a 4-byte alphanumeric string for the organization code.

Notes

- There are no problems in recording or playing back audio-video signals, even if the ORGANIZATION is not set.
- Organization codes must be acquired by applying to the SMPTE registration office. When no organization code has been acquired, it is forbidden to enter an arbitrary string. As a rule, the code “00” must be entered. Freelance operators who do not belong to an organization should enter “~”.

USER (user code)

Enter a 4-byte alphanumeric string to identify the user. The user code is registered with each organization locally. It is usually not centrally registered.

When the user code is less than 4 bytes, enter the user code at the beginning of the 4 bytes and fill the remainder of the string with the space character (20h).

This user code is determined by the organization. The methods used depend on the organization.

Note

User code cannot be entered when no organization code has been entered.

Ancillary Data

This unit can play and record ancillary data multiplexed into HDSDI signals. It can also input and output ancillary data in MXF files when transferring files via FAM or FTP connections. Transferable auxiliary data includes text data (captions and metadata) and control signals.

Ancillary data in HDSDI signals

This unit can record and play back closed captions conforming to the EIA-708-B ¹⁾ standard and text data conforming to the ARIB TRB23 ²⁾ which comprise the VANC (Vertical ancillary data) packets.

1) EIA: Electronic Industries Alliance

2) ARIB: Association of Radio Industries and Businesses

To record ancillary data

In maintenance menu item M3B: VANC RX PARAMETER, set the lines where ancillary data is inserted, the DID (Data Identifier word), and the SDID (Secondary Data Identifier word) (*see page 146*).

To record EIA-608-B standard closed caption signals in SDSDI signals after conversion to the EIA-708-B standard

Set the following items.

- Sub items of maintenance menu item M3B: VANC RX PARAMETER
 - DID (data identification word): 61h
 - SDID (secondary data identification word): 01h
- V INPUT on function menu page P1 VIDEO: SDSDI
- Setup menu item 031 RECORDING FORMAT: HD422, 420HQ, or 420SP

VANC packets

- The Japanese ARIB TR-B23 standard limits the number of packets that can be multiplexed into HDSDI to 4 packets per line.
- The number of VANC packets that can be recorded that is set using maintenance menu item M3B is limited to 9 packets per frame for 50P or 59.94P mode and 18 packets per frame for other modes.
- When VANC packets are not continuous from word 0, and there is unused area on the line, then information about the packet position is not recorded. Packets are output flush left.
- During input, if a parity error is detected in a VANC packet, the packet is discarded and recorded flush left.

Ancillary data in MXF files

VANC ancillary data recorded from a HDSDI signal can be inserted to an MXF file as an ANC Frame Element (conforming to the SMPTE436M-2006) and can be output. This data can also be input and recorded on the disc.

To insert ancillary data into MXF files to output

In setup menu item 666 METADATA ITEM OUT, select “on” (*see page 135*).

HANC/VANC packets

Detection of HANC/VANC packets

HANC/VANC packets are recorded on the disc only when the DATA ITEM of the head frame is identified as ANC Frame Elements conforming to the SMPTE436M-2006 when an MXF file is input.

General MXF metadata

This unit examines the data contained in the header metadata area ¹⁾ when an MXF file is input. If the data is identified as the data created by the device other than XDCAM at this time, one file (KLVE file) is created.

1) The header metadata area contains the metadata information about the entire file. *See SMPTE377M for details.*

For details, see “Directory structure” (page 104) and “Clip directory” (page 106).

Correspondence between Setting Items of the HKDV-900 and Setup Menu of This Unit

Setting item of HKDV-900	Menu item of this unit's setup menu
HD Master	740: MASTER LEVEL (HD) ^{a)}
HD Y	741: Y LEVEL (HD) ^{a)}
HD Pb	742: Pb LEVEL (HD) ^{a)}
HD Pr	743: Pr LEVEL (HD) ^{a)}
HD Setup	745: SETUP LEVEL (HD) ^{a)}
HD Sync Phase	746: SYNC PHASE (HD/UC) ^{a)}
HD Fine	747: FINE (HD/UC) ^{a)}
D1 Master	No menu item corresponds to this setting item.
D1 Y	No menu item corresponds to this setting item.
D1 B-Y	No menu item corresponds to this setting item.
D1 R-Y	No menu item corresponds to this setting item.
D2 VIDEO	715: VIDEO GAIN CONTROL (HD/DC/SD/UC) ^{a)}
D2 CHROMA	716: CHROMA GAIN CONTROL (HD/DC/SD/UC) ^{a)}
D2 HUE	717: CHROMA PHASE CONTROL (HD/DC/SD/UC) ^{a)}
SETUP	718: SETUP LEVEL/BLACK LEVEL (HD/DC/SD/UC) ^{a)}
SD Sync Phase	719: SYSTEM PHASE SYNC (DC/SD)
SD Fine	720: SYSTEM PHASE SC (DC/SD)
CROSS COLOR	934: CROSS COLOR (DC)
H CROP POSITION	932: H CROP POSITION (DC)/ 951: H CROP POSITION (UC) ^{b)}
DETAIL GAIN	935: DETAIL GAIN (DC)/ 954: DETAIL GAIN (UC) ^{b)}
LIMITTER	936: LIMITER (DC)/955: LIMITER (UC) ^{b)}
CRISP	937: CRISP (DC)/ 956: CRISP THRESHOLD (UC) ^{b)}
DEPEND	938: LEVEL DEPEND THRESHOLD (DC)/ 957: LEVEL DEPEND THRESHOLD (UC) ^{b)}

Setting item of HKDV-900	Menu item of this unit's setup menu
FREQUENCY	939: H DETAIL FREQUENCY (DC)/ 958: H DETAIL FREQUENCY (UC) ^{b)}
H/V RATIO	940: H/V RATIO (DC)/ 959: H/V RATIO (UC) ^{b)}
GAMMA	No menu item corresponds to this setting item.
CROP	930: DOWN CONVERTER MODE/ 950: UP CONVERTER MODE ^{b)}
LETTER BOX	930: DOWN CONVERTER MODE/ 950: UP CONVERTER MODE ^{b)}
SQUEEZE	930: DOWN CONVERTER MODE/ 950: UP CONVERTER MODE ^{b)}

- a) The setting becomes effective for the output only when VID. PROC on page P1 VIDEO of the function menu is set to "MENU".
- b) Whether to set the down-converter or up-converter is determined using setup menu item 212 VIDEO REMOTE CONTROL SELECT. If both converters are selected ("u & d" of menu item 212), the relevant menu item allows both converters to be set, but only the value for the down-converter is used as the return value from this unit and the unity value.

Meaning of abbreviations within parentheses in the table

HD: HDSDI output during playback of HD format video

DC: Down-conversion output to SD (D1 SDI/COMPOSITE) during playback of HD format video

SD: SD (D1 SDI/COMPOSITE) output during playback of SD format video

UC: Up-conversion output to HDSDI during playback of SD format video

List of Supported USB Keyboards

When the area of use is set to “UC” and the font setting is “European Alphabet”¹⁾

On this unit, you can enter any of the characters and symbols supported by the keyboards listed below.

Select the corresponding language by selecting Settings > Select USB Keyboard Language in the Disc Menu (see page 81).

1) When the font setting is “Simplified Chinese” or “Traditional Chinese”, a keyboard with the same layout as the English [United States] keyboard is selected automatically.

English [United Kingdom]

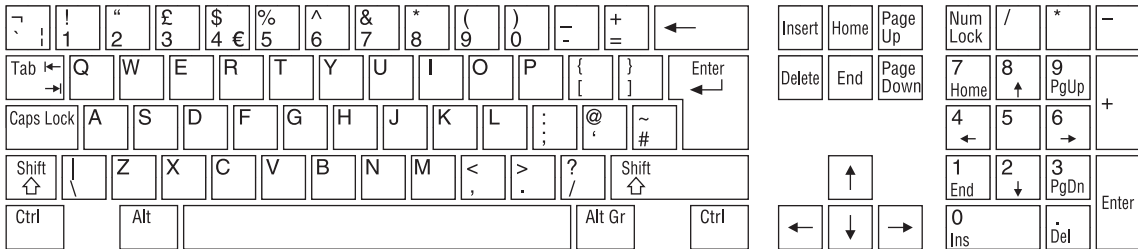

English [United States]

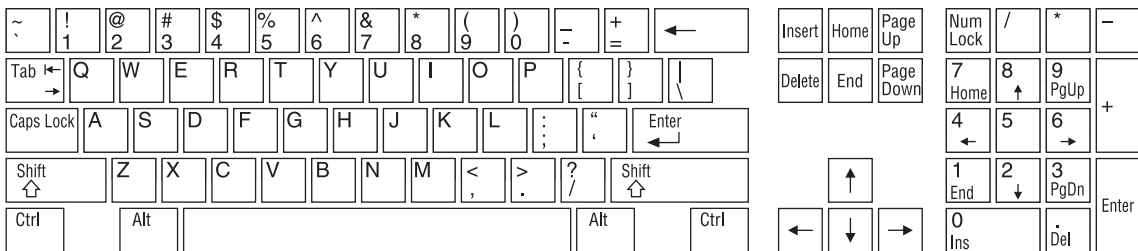

French [France]

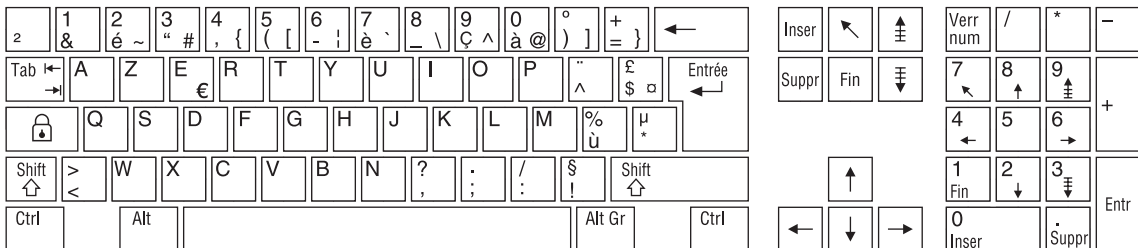

German [Germany]

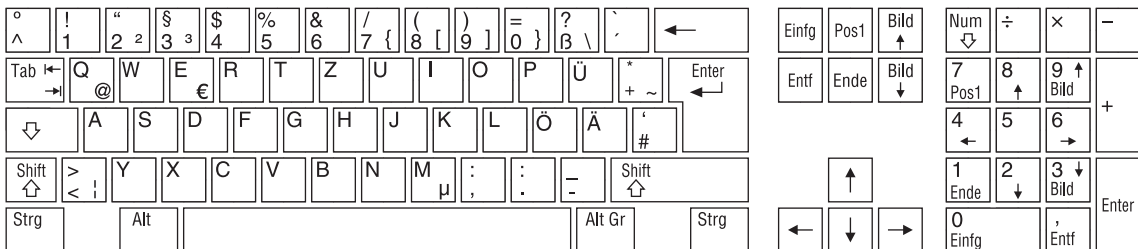

Italian [Italy]

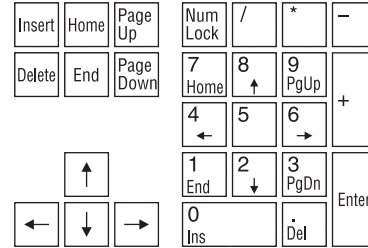
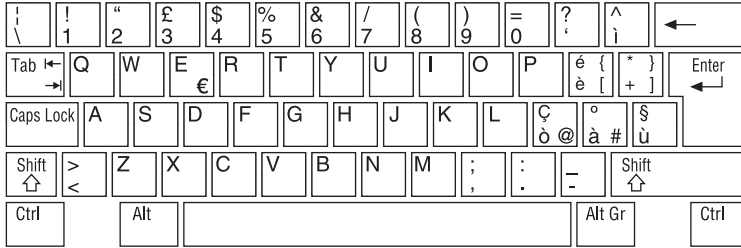

Polish (Programmers) [Poland]

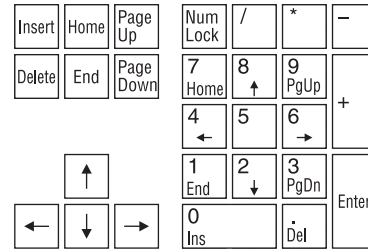
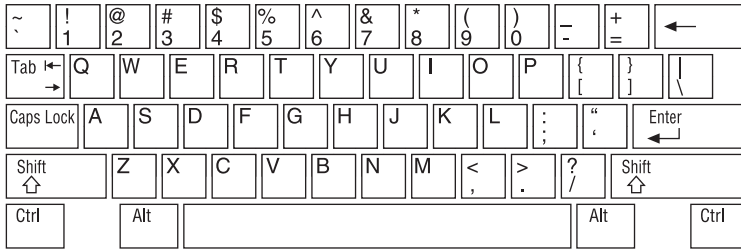

Russian [Russia]

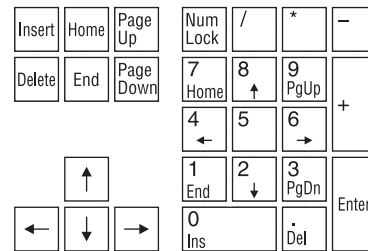

Spanish [Spain]

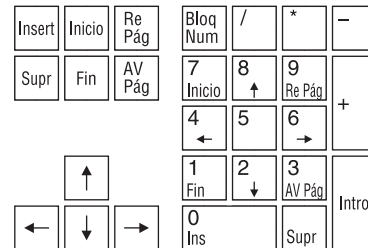
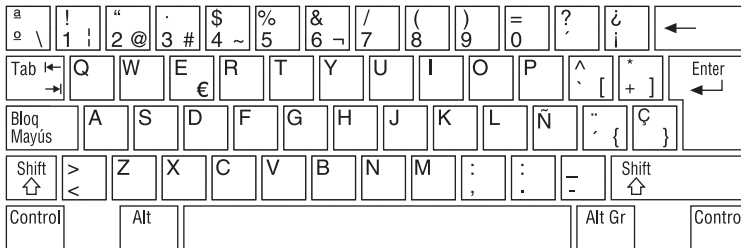

When the area of use is set to “UC” and the font setting is “Korean”

The keyboard is fixed as the Korean keyboard, and you can enter Hangul characters.

Note

The keyboard language cannot be changed.

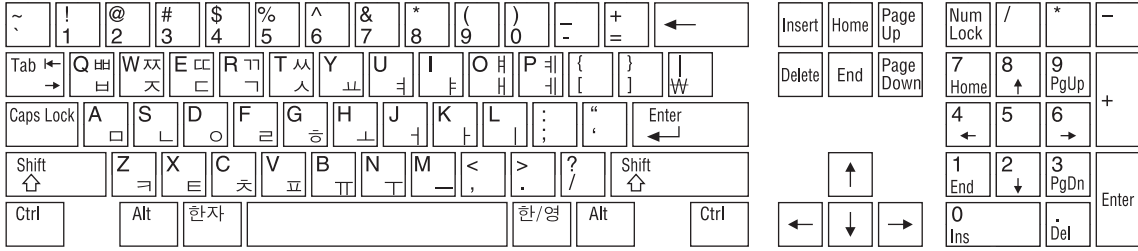

When the area of use is set to “J”

The keyboard is fixed as the Japanese keyboard.

Notes

- The keyboard language cannot be changed.
- It is not possible to enter Japanese hiragana, katakana, and kanji.



Trademarks and Licenses

MPEG-4 visual patent portfolio license

THIS PRODUCT IS LICENSED UNDER THE MPEG-4 VISUAL PATENT PORTFOLIO LICENSE FOR THE PERSONAL AND NON-COMMERCIAL USE OF A CONSUMER FOR

(i) ENCODING VIDEO IN COMPLIANCE WITH THE MPEG-4 VISUAL STANDARD (“MPEG-4 VIDEO”) AND/OR

(ii) DECODING MPEG-4 VIDEO THAT WAS ENCODED BY A CONSUMER ENGAGED IN A PERSONAL AND NON-COMMERCIAL ACTIVITY AND/OR WAS OBTAINED FROM A VIDEO PROVIDER LICENSED BY MPEG LA TO PROVIDE MPEG-4 VIDEO.

NO LICENSE IS GRANTED OR SHALL BE IMPLIED FOR ANY OTHER USE. ADDITIONAL INFORMATION INCLUDING THAT RELATING TO PROMOTIONAL, INTERNAL AND COMMERCIAL USES AND LICENSING MAY BE OBTAINED FROM MPEG LA, LLC. SEE [HTTP://WWW.MPEGLA.COM](http://WWW.MPEGLA.COM)

MPEG LA is offering licenses for (i) manufacturing/sales of any storage media storing MPEG-4 Visual video information (ii) distribution/broadcasting of MPEG-4 Visual video information in any manner (such as online video distribution service, internet broadcasting, TV broadcasting). Other usage of this product may be required to obtain license from MPEGLA. Please contact MPEG LA for any further information. MPEG LA, L.L.C., 250 STEELE STREET, SUITE 300, DENVER, COLORADO 80206, <http://www.mpegla.com>

MPEG-2 video patent portfolio license

ANY USE OF THIS PRODUCT OTHER THAN CONSUMER PERSONAL USE IN ANY MANNER THAT COMPLIES WITH THE MPEG-2 STANDARD FOR ENCODING VIDEO INFORMATION FOR PACKAGED MEDIA IS EXPRESSLY PROHIBITED WITHOUT A LICENSE UNDER APPLICABLE PATENTS IN THE MPEG-2 PATENT PORTFOLIO, WHICH LICENSE IS AVAILABLE FROM MPEG LA, L.L.C., 250 STEELE STREET, SUITE 300, DENVER, COLORADO 80206.

“PACKAGED MEDIA” means any storage media storing MPEG-2 video information such as DVD movie which are sold/distributed to general consumers. Disc replicators or sellers of the PACKAGED MEDIA need to obtain licenses for their own business from MPEG LA. Please contact MPEG LA for any further information. MPEG LA, L.L.C., 250 STEELE STREET, SUITE 300, DENVER, COLORADO 80206 <http://www.mpegla.com>

About IJG (Independent JPEG Group)

This software is based in part on the work of the Independent JPEG Group.

Character display software “iType”

This product includes technology from Monotype Imaging Inc., including iType[®] and certain fonts.

About net-snmpd

---- Part 1: CMU/UCD copyright notice: (BSD like) ----

Copyright 1989, 1991, 1992 by Carnegie Mellon University

Derivative Work - 1996, 1998-2000

Copyright 1996, 1998-2000 The Regents of the University of California

All Rights Reserved

Permission to use, copy, modify and distribute this software and its documentation for any purpose and without fee is hereby granted, provided that the above copyright notice appears in all copies and that both that copyright notice and this permission notice appear in supporting documentation, and that the name of CMU and The Regents of the University of California not be used in advertising or publicity pertaining to distribution of the software without specific written permission.

CMU AND THE REGENTS OF THE UNIVERSITY OF CALIFORNIA DISCLAIM ALL WARRANTIES WITH REGARD TO THIS SOFTWARE, INCLUDING ALL IMPLIED WARRANTIES OF MERCHANTABILITY AND FITNESS. IN NO EVENT SHALL CMU OR THE REGENTS OF THE UNIVERSITY OF CALIFORNIA BE LIABLE FOR ANY SPECIAL, INDIRECT OR CONSEQUENTIAL DAMAGES OR ANY DAMAGES WHATSOEVER RESULTING FROM THE LOSS OF USE, DATA OR PROFITS, WHETHER IN AN ACTION OF CONTRACT, NEGLIGENCE OR OTHER TORTIOUS ACTION, ARISING OUT OF OR IN CONNECTION WITH THE USE OR PERFORMANCE OF THIS SOFTWARE.

---- Part 2: Networks Associates Technology, Inc copyright notice (BSD) ----

Copyright (c) 2001-2003, Networks Associates Technology, Inc
All rights reserved.

Redistribution and use in source and binary forms, with or without modification, are permitted provided that the following conditions are met:

- Redistributions of source code must retain the above copyright notice, this list of conditions and the following disclaimer.
- Redistributions in binary form must reproduce the above copyright notice, this list of conditions and the following disclaimer in the documentation and/or other materials provided with the distribution.
- Neither the name of the Networks Associates Technology, Inc nor the names of its contributors may be used to endorse or promote products derived from this software without specific prior written permission.

THIS SOFTWARE IS PROVIDED BY THE COPYRIGHT HOLDERS AND CONTRIBUTORS ``AS IS" AND ANY EXPRESS OR IMPLIED WARRANTIES, INCLUDING, BUT NOT LIMITED TO, THE IMPLIED WARRANTIES OF MERCHANTABILITY AND FITNESS FOR A PARTICULAR PURPOSE ARE DISCLAIMED. IN NO EVENT SHALL THE COPYRIGHT HOLDERS OR CONTRIBUTORS BE LIABLE FOR ANY DIRECT, INDIRECT, INCIDENTAL, SPECIAL, EXEMPLARY, OR CONSEQUENTIAL DAMAGES (INCLUDING, BUT NOT LIMITED TO, PROCUREMENT OF SUBSTITUTE GOODS OR SERVICES; LOSS OF USE, DATA, OR PROFITS; OR BUSINESS INTERRUPTION) HOWEVER CAUSED AND ON ANY THEORY OF LIABILITY, WHETHER IN CONTRACT, STRICT LIABILITY, OR TORT (INCLUDING NEGLIGENCE OR OTHERWISE) ARISING IN ANY WAY OUT OF THE USE OF THIS SOFTWARE, EVEN IF ADVISED OF THE POSSIBILITY OF SUCH DAMAGE.

---- Part 3: Cambridge Broadband Ltd. copyright notice (BSD) ----

Portions of this code are copyright (c) 2001-2003, Cambridge Broadband Ltd.
All rights reserved.

Redistribution and use in source and binary forms, with or without modification, are permitted provided that the following conditions are met:

- Redistributions of source code must retain the above copyright notice, this list of conditions and the following disclaimer.

- Redistributions in binary form must reproduce the above copyright notice, this list of conditions and the following disclaimer in the documentation and/or other materials provided with the distribution.
- The name of Cambridge Broadband Ltd. may not be used to endorse or promote products derived from this software without specific prior written permission.

THIS SOFTWARE IS PROVIDED BY THE COPYRIGHT HOLDER ``AS IS" AND ANY EXPRESS OR IMPLIED WARRANTIES, INCLUDING, BUT NOT LIMITED TO, THE IMPLIED WARRANTIES OF MERCHANTABILITY AND FITNESS FOR A PARTICULAR PURPOSE ARE DISCLAIMED. IN NO EVENT SHALL THE COPYRIGHT HOLDER BE LIABLE FOR ANY DIRECT, INDIRECT, INCIDENTAL, SPECIAL, EXEMPLARY, OR CONSEQUENTIAL DAMAGES (INCLUDING, BUT NOT LIMITED TO, PROCUREMENT OF SUBSTITUTE GOODS OR SERVICES; LOSS OF USE, DATA, OR PROFITS; OR BUSINESS INTERRUPTION) HOWEVER CAUSED AND ON ANY THEORY OF LIABILITY, WHETHER IN CONTRACT, STRICT LIABILITY, OR TORT (INCLUDING NEGLIGENCE OR OTHERWISE) ARISING IN ANY WAY OUT OF THE USE OF THIS SOFTWARE, EVEN IF ADVISED OF THE POSSIBILITY OF SUCH DAMAGE.

---- Part 4: Sun Microsystems, Inc. copyright notice (BSD) ----

Copyright ©2003 Sun Microsystems, Inc., 4150 Network Circle, Santa Clara, California 95054, U.S.A. All rights reserved.

Use is subject to license terms below.

This distribution may include materials developed by third parties.

Sun, Sun Microsystems, the Sun logo and Solaris are trademarks or registered trademarks of Sun Microsystems, Inc. in the U.S. and other countries.

Redistribution and use in source and binary forms, with or without modification, are permitted provided that the following conditions are met:

- Redistributions of source code must retain the above copyright notice, this list of conditions and the following disclaimer.
- Redistributions in binary form must reproduce the above copyright notice, this list of conditions and the following disclaimer in the documentation and/or other materials provided with the distribution.

- Neither the name of the Sun Microsystems, Inc. nor the names of its contributors may be used to endorse or promote products derived from this software without specific prior written permission.

THIS SOFTWARE IS PROVIDED BY THE COPYRIGHT HOLDERS AND CONTRIBUTORS ``AS IS'' AND ANY EXPRESS OR IMPLIED WARRANTIES, INCLUDING, BUT NOT LIMITED TO, THE IMPLIED WARRANTIES OF MERCHANTABILITY AND FITNESS FOR A PARTICULAR PURPOSE ARE DISCLAIMED. IN NO EVENT SHALL THE COPYRIGHT HOLDERS OR CONTRIBUTORS BE LIABLE FOR ANY DIRECT, INDIRECT, INCIDENTAL, SPECIAL, EXEMPLARY, OR CONSEQUENTIAL DAMAGES (INCLUDING, BUT NOT LIMITED TO, PROCUREMENT OF SUBSTITUTE GOODS OR SERVICES; LOSS OF USE, DATA, OR PROFITS; OR BUSINESS INTERRUPTION) HOWEVER CAUSED AND ON ANY THEORY OF LIABILITY, WHETHER IN CONTRACT, STRICT LIABILITY, OR TORT (INCLUDING NEGLIGENCE OR OTHERWISE) ARISING IN ANY WAY OUT OF THE USE OF THIS SOFTWARE, EVEN IF ADVISED OF THE POSSIBILITY OF SUCH DAMAGE.

---- Part 5: Sparta, Inc copyright notice (BSD) ----

Copyright (c) 2003-2006, Sparta, Inc
All rights reserved.

Redistribution and use in source and binary forms, with or without modification, are permitted provided that the following conditions are met:

- Redistributions of source code must retain the above copyright notice, this list of conditions and the following disclaimer.
- Redistributions in binary form must reproduce the above copyright notice, this list of conditions and the following disclaimer in the documentation and/or other materials provided with the distribution.
- Neither the name of Sparta, Inc nor the names of its contributors may be used to endorse or promote products derived from this software without specific prior written permission.

THIS SOFTWARE IS PROVIDED BY THE COPYRIGHT HOLDERS AND CONTRIBUTORS ``AS IS'' AND ANY EXPRESS OR IMPLIED WARRANTIES, INCLUDING, BUT NOT LIMITED TO, THE IMPLIED WARRANTIES OF MERCHANTABILITY AND FITNESS FOR A PARTICULAR PURPOSE ARE DISCLAIMED. IN NO EVENT SHALL THE COPYRIGHT HOLDERS OR CONTRIBUTORS BE LIABLE FOR ANY DIRECT, INDIRECT, INCIDENTAL, SPECIAL, EXEMPLARY,

OR CONSEQUENTIAL DAMAGES (INCLUDING, BUT NOT LIMITED TO, PROCUREMENT OF SUBSTITUTE GOODS OR SERVICES; LOSS OF USE, DATA, OR PROFITS; OR BUSINESS INTERRUPTION) HOWEVER CAUSED AND ON ANY THEORY OF LIABILITY, WHETHER IN CONTRACT, STRICT LIABILITY, OR TORT (INCLUDING NEGLIGENCE OR OTHERWISE) ARISING IN ANY WAY OUT OF THE USE OF THIS SOFTWARE, EVEN IF ADVISED OF THE POSSIBILITY OF SUCH DAMAGE.

---- Part 6: Cisco/BUPTNIC copyright notice (BSD) ----

Copyright (c) 2004, Cisco, Inc and Information Network Center of Beijing University of Posts and Telecommunications.
All rights reserved.

Redistribution and use in source and binary forms, with or without modification, are permitted provided that the following conditions are met:

- Redistributions of source code must retain the above copyright notice, this list of conditions and the following disclaimer.
- Redistributions in binary form must reproduce the above copyright notice, this list of conditions and the following disclaimer in the documentation and/or other materials provided with the distribution.
- Neither the name of Cisco, Inc, Beijing University of Posts and Telecommunications, nor the names of their contributors may be used to endorse or promote products derived from this software without specific prior written permission.

THIS SOFTWARE IS PROVIDED BY THE COPYRIGHT HOLDERS AND CONTRIBUTORS ``AS IS'' AND ANY EXPRESS OR IMPLIED WARRANTIES, INCLUDING, BUT NOT LIMITED TO, THE IMPLIED WARRANTIES OF MERCHANTABILITY AND FITNESS FOR A PARTICULAR PURPOSE ARE DISCLAIMED. IN NO EVENT SHALL THE COPYRIGHT HOLDERS OR CONTRIBUTORS BE LIABLE FOR ANY DIRECT, INDIRECT, INCIDENTAL, SPECIAL, EXEMPLARY, OR CONSEQUENTIAL DAMAGES (INCLUDING, BUT NOT LIMITED TO, PROCUREMENT OF SUBSTITUTE GOODS OR SERVICES; LOSS OF USE, DATA, OR PROFITS; OR BUSINESS INTERRUPTION) HOWEVER CAUSED AND ON ANY THEORY OF LIABILITY, WHETHER IN CONTRACT, STRICT LIABILITY, OR TORT (INCLUDING NEGLIGENCE OR OTHERWISE) ARISING IN ANY WAY OUT OF THE USE OF THIS SOFTWARE, EVEN IF ADVISED OF THE POSSIBILITY OF SUCH DAMAGE.

---- Part 7: Fabasoft R&D Software GmbH & Co KG
copyright notice (BSD) ----

Copyright (c) Fabasoft R&D Software GmbH & Co KG,
2003
oss@fabasoft.com

Author: Bernhard Penz <bernhard.penz@fabasoft.com>

Redistribution and use in source and binary forms, with or
without modification, are permitted provided that the
following conditions are met:

- Redistributions of source code must retain the above
copyright notice, this list of conditions and the following
disclaimer.
- Redistributions in binary form must reproduce the above
copyright notice, this list of conditions and the following
disclaimer in the documentation and/or other materials
provided with the distribution.
- The name of Fabasoft R&D Software GmbH & Co KG
or any of its subsidiaries, brand or product names may
not be used to endorse or promote products derived from
this software without specific prior written permission.

THIS SOFTWARE IS PROVIDED BY THE
COPYRIGHT HOLDER ``AS IS" AND ANY EXPRESS
OR IMPLIED WARRANTIES, INCLUDING, BUT NOT
LIMITED TO, THE IMPLIED WARRANTIES OF
MERCHANTABILITY AND FITNESS FOR A
PARTICULAR PURPOSE ARE DISCLAIMED. IN NO
EVENT SHALL THE COPYRIGHT HOLDER BE
LIABLE FOR ANY DIRECT, INDIRECT,
INCIDENTAL, SPECIAL, EXEMPLARY, OR
CONSEQUENTIAL DAMAGES (INCLUDING, BUT
NOT LIMITED TO, PROCUREMENT OF
SUBSTITUTE GOODS OR SERVICES; LOSS OF USE,
DATA, OR PROFITS; OR BUSINESS
INTERRUPTION) HOWEVER CAUSED AND ON
ANY THEORY OF LIABILITY, WHETHER IN
CONTRACT, STRICT LIABILITY, OR TORT
(INCLUDING NEGLIGENCE OR OTHERWISE)
ARISING IN ANY WAY OUT OF THE USE OF THIS
SOFTWARE, EVEN IF ADVISED OF THE
POSSIBILITY OF SUCH DAMAGE.

About libupnp

Copyright (c) 2000-2003 Intel Corporation
All rights reserved.

Redistribution and use in source and binary forms, with or
without modification, are permitted provided that the
following conditions are met:

- Redistributions of source code must retain the above
copyright notice, this list of conditions and the following
disclaimer.

- Redistributions in binary form must reproduce the above
copyright notice, this list of conditions and the following
disclaimer in the documentation and/or other materials
provided with the distribution.
- Neither name of Intel Corporation nor the names of its
contributors may be used to endorse or promote products
derived from this software without specific prior written
permission.

THIS SOFTWARE IS PROVIDED BY THE
COPYRIGHT HOLDERS AND CONTRIBUTORS ``AS
IS" AND ANY EXPRESS OR IMPLIED
WARRANTIES, INCLUDING, BUT NOT LIMITED
TO, THE IMPLIED WARRANTIES OF
MERCHANTABILITY AND FITNESS FOR A
PARTICULAR PURPOSE ARE DISCLAIMED. IN NO
EVENT SHALL INTEL OR CONTRIBUTORS BE
LIABLE FOR ANY DIRECT, INDIRECT,
INCIDENTAL, SPECIAL, EXEMPLARY, OR
CONSEQUENTIAL DAMAGES (INCLUDING, BUT
NOT LIMITED TO, PROCUREMENT OF
SUBSTITUTE GOODS OR SERVICES; LOSS OF USE,
DATA, OR PROFITS; OR BUSINESS
INTERRUPTION) HOWEVER CAUSED AND ON
ANY THEORY OF LIABILITY, WHETHER IN
CONTRACT, STRICT LIABILITY, OR TORT
(INCLUDING NEGLIGENCE OR OTHERWISE)
ARISING IN ANY WAY OUT OF THE USE OF THIS
SOFTWARE, EVEN IF ADVISED OF THE
POSSIBILITY OF SUCH DAMAGE.

Glossary

AES/EBU

A standard established jointly by the AES (Audio Engineering Society) and EBU (European Broadcasting Union) for serial transmission of digital audio. Two channels of audio can be transmitted via a single connector.

Clip

A recording unit. Clips are created every time recording starts and stops.

Clip list

A list of locations in the material recorded on the disc, arranged in any order. Clip lists can be created with the scene selection function of this unit, and with the PDZ-1 Proxy Browsing Software.

Composite video signal

A video signal in which luminance and chrominance are combined along with timing reference “sync” information to make composite video.

Drop-frame mode

SMPTE timecode runs at 30 frames/second, while the NTSC color television system runs at about 29.97 frames/second. Drop-frame mode adjusts the running of timecode to eliminate the discrepancy between timecode value and actual time by dropping two frames from the timecode value at the beginning of each minute except every tenth minute.

E-E mode

Electric-to-Electric mode. When you operate a VDR in E-E mode, input video and/or audio signals pass through electric circuits only and then come out from the output connectors, without passing through electromagnetic conversion circuits such as recording heads.

Essence mark

A type of metadata that may be set for a specified frame.

For more efficient searches, XDCAM equipment records essence marks as part of Non-RealTime metadata, and uses them to display thumbnails.

HD tri-level sync

An HDTV analog reference signal that applies to 59.94/50Hz systems. A sync signal defined in SMPTE-274M with positive, negative, and zero values.

HDS DI signal

Abbreviation of HD Serial Digital Interface. A signal in the HDTV serial interface defined by SMPTE-292M.

Metadata

Information about the properties of video and audio content. XDCAM records metadata such as UMIDs and essence marks, and the PDZ-1 Proxy Browsing Software can be used to record information such as titles and comments.

MXF

Material eXchange Format. A file exchange format developed by the Pro-MPEG Forum. Equipment from different manufacturers can exchange files in this format.

Non-audio

General term for audio signals other than linear PCM, such as Dolby E¹⁾ and Dolby Digital (AC-3).¹⁾ XDCAM can record non-audio as an input signal.

¹⁾ Dolby is a trademark of Dolby Laboratories.

Non-drop-frame mode

A mode of advancing timecode which ignores the difference in frame values between real time and the timecode. Using this mode produces a difference of approximately 86 seconds per day between real time and timecode, which causes problems when editing programs in units of seconds using the number of frames as a reference.

Proxy AV data

Low-resolution data with a video bandwidth of 1.5 Mbps and an audio bandwidth of 64 kbps per channel. This unit records proxy AV data

automatically whenever high-resolution MPEG HD data is recorded.

Reference video signal

A video signal that contains a sync signal or sync and burst signals, used as a reference for synchronization of video equipment.

SDSDI signal

SD Serial Digital Interface. An interface standardized as SMPTE-259M which enables the transmission of an uncompressed digital component stream.

S/N

Signal-to-Noise ratio. The relation of the strength of the desired signal to the accompanying electronic interference, the noise. If S/N is high, sounds are reproduced with less noise and pictures are reproduced clearly without snow.

Sub clip

One of the sections which make up a clip list. A sub clip may be part of a clip or an entire clip.

Thumbnail image

A reduced still picture of video for display on a GUI screen. XDCAM creates thumbnail images from proxy video, and displays them as index pictures on GUI screens.

Timecode

A digitally encoded signal which is recorded with video data to identify each frame of the video by hour, minute, second and frame number. SMPTE timecode is applied to NTSC system, and EBU timecode to PAL and SECAM systems.

UMID

Unique Material Identifier. A standard (SMPTE-330M) for video and audio metadata. The Basic section of a UMID contains a globally unique number and a material number for the identification of recorded material. An optional section called the “Source Pack” contains information such as the time and location of recording. A UMID with the Basic section only is called a Basic UMID. A UMID with the

Source Pack is called an Extended UMID.

User bits

A total of 32 bits are provided in the timecode which the user can use to record such information as date, reel number, or scene number on video tape or disc. Also called user's bits.

VBID (Video Blanking ID)

This is a video ID signal, defined in the EIAJ CPR-1204 standard, which is inserted into VBS video output to enable the aspect ratio to be detected. The ID signal is inserted into line 20, VBI 283.

Index

A

- AC IN connector 29
- ACCESS indicator 17
- Accessories
 - not supplied 169
 - supplied 169
- Add Sub Clip screen 86, 87
- Alarms 157
- Analog
 - audio signal input/output section 30
- ANALOG AUDIO
 - INPUT 1, 2 connectors 30
 - OUTPUT 1, 2 connectors 30
- Ancillary data 173
- Appendix 154
- Area of use setting 33
- Arrow buttons 18
- Audio
 - input display 23
- Audio level
 - adjustment section 18
 - meters 23
- AUDIO MONITOR R, L connectors 30

B

- Basic menu 121
 - changing settings 127
 - items 122
 - operations 126
 - returning to factory default settings 127
- Battery
 - attaching a battery pack 32
 - checking the remaining power 33
 - removing 33

C

- CH-1/ALL CH, CH-2 to CH-4
 - adjustment knobs 18
- Chapter
 - function 75
 - thumbnail screen 69
- CHAPTER button 21
- Clip 85
 - changing index picture 79
 - continuous playback mode 62
 - deleting 83
 - duration 68
 - finding 75

- information 24
- locking 83
- playback screen 66
- properties 80
- selecting by type 77
- single clip playback mode 62
- thumbnail screen 66, 68
- transferring 97
- unlocking 83
- user-defined name 109

Clip Continuous Rec function 57

Clip List

- (Move) screen 88
 - (Trim) screen 88
 - user-defined name 109
- ### Clip list 85
- changing start timecode 89
 - clearing 91
 - creating and editing 86
 - current clip list 85
 - deleting 91
 - loading 90
 - managing 90
 - playback screen 66
 - previewing 85
 - saving 90
 - sorting 91
 - thumbnail screen 66, 69

Clip Properties screen 80

Command list 115

Communications speed 150

COMPOSITE OUTPUT 1, 2 (SUPER)

- connectors 29
- ### Connections 36
- cut editing system 37
 - editing control unit settings 39
 - FAM connection 36
 - for pool coverage 41
 - for using PDZ-1 36
 - FTP connection 36
 - using the editing function of recorder 41

Current clip list 85

D

- Date/time setting 34
- DC IN 12V connector 28
- Delete Clip 84
- Delete Clip & Clip List 84
- DIGITAL AUDIO (AES/EBU)
 - IN 1/2, 3/4 connectors 30
 - OUT 1/2, 3/4 connectors 30
- Digital audio signal input/output section 30
- Digital hours meter 155
 - display modes 155
 - displaying 156

- exiting 156
- Direct FTP function 97
- DISC MENU
 - button 21, 66
 - indicator 20, 66
- Disc Menu 71
- Discs 92
 - ejecting with the unit powered off 167
 - formatting 53, 94
 - handling 52
 - information 25
 - loaded indication 25
 - loading/unloading 53
 - properties 92
 - reconstructing 58
 - salvage functions 58
 - slot 18
 - usable discs 52
 - write-protecting 53
- DISPLAY
 - button 21
- Display 20, 23
 - basic operation display 23
 - video monitor display 26
 - window 23
- Display/menu control section 20

E

- Editing
 - control unit 37
 - controller 39
- EJECT button 18
- Ejecting a disc manually 167
- Error messages 167
- Essence mark
 - search 76
 - setting 55, 64
 - thumbnail screen 70
- Expand
 - function 13, 75
 - thumbnail screen 69
- EXPAND button 21
- Extended menu 121
 - display 142
 - items 129
 - operations 142
- External synchronization 42

F

- Features 11
- File access mode (FAM) connections 36
- File operations 104
 - clip directory 106
 - directory structure 104

- edit directory 106
- general directory 107
- root directory 105
- sub directory 107
- File Operations in File Access Mode (for Macintosh) 112
 - exiting file operations 113
 - making FAM connections 112
 - operating on files 113
 - reconnecting 113
- File Operations in File Access Mode (for Windows) 110
 - exiting file operations 111
 - making connections 111
 - operating on files 111
 - preparations 110
 - reconnecting 112
 - recording continuous timecode 120
- Filter Clips function 77
- Formatting discs 94
- Frame frequency groups 54
- Front panel 17, 35
 - changing the angle 35
 - pulling out 35
 - returning to original position 35
- FTP file operations 114
 - command list 115
 - logging in 114
 - logging out 115
 - making connections 114
 - preparations 114
 - recording continuous timecode 120
- Function buttons (F1 to F6) 20
- Function menu 24, 48
 - HOME page 48
 - P1 VIDEO page 49
 - P2 AUDIO page 49
 - P3 AUDIO page 50
 - P4 AUDIO page 50
 - P5 TC page 51
 - P6 REF page 51
 - P7 OTHER page 51

G

- Gigabit Ethernet 13
- Glossary 182
- GUI screen 66
 - operations 73

H

- Handle 17
- HDSDI OUTPUT 1, 2 (SUPER) connectors 28
 - remote control function 57

- HOME button 21

I

- i.LINK S400 connector 28
- IN
 - button 19
 - indicator 19
- Index picture
 - changing 79
- Initial Setup 33

J

- Jog
 - dial 19
 - mode 64
- Jog/shuttle transport indicators 19

K

- KEY INHI switch 18

L

- LEVEL adjustment knob 18
- Linear editing 59
- Loading/unloading disc 53

M

- Maintenance
 - periodic 155
- MAINTENANCE connector 29
- Maintenance menu 144
 - communication speed 150
 - items 144
 - network settings 149
 - operations 148
- MARK1/MARK2 buttons 19
- Menu
 - bank setting 125
 - changing settings 127
 - configuration 121
 - disc menu 71
 - function menu 48
 - maintenance menu 144
 - returning to default settings 127
 - setup menu 121

- MENU button 20
- Metadata 171
- Microphone settings 30
- Mixed format recording mode 54
- Move Shot Mark screen 76

N

- Names and functions of parts 17
- Network
 - assigning IP address automatically

- 149
 - connector 29
 - setting IP address 149
 - settings 149
- NEXT button 22
- Normal speed playback 63

O

- On/standby button and indicator 17
- OUT
 - button 19
 - indicator 19

P

- PAGE button 21
- PDZ-1
 - connections 36
 - installation 170
 - system requirements 170
- PHONES jack 18
- Planning Metadata 92
- PLAY button 22
- Playback 62
 - clip list 85
 - jog mode 64
 - normal speed 63
 - settings 62
 - shot mark settings 64
 - shuttle mode 64
 - start position 63
 - variable-speed mode 65
- Playback condition
 - display 47
 - mark 46
- Power supply section 29
- POWER switch 29
- Preparation
 - Initial Setup 33
- PREV button 21
- Professional Disc 52
- Proxy AV data 12
- Proxy Browsing Software 170
- Pulldown playback 62
- PUSH SET(S.SEL) knob 20

R

- Rear Panel 28
- REC button 22
- REC INHI indicator 22
- Recording 54
 - format 24
 - HDSDI remote control function 57
 - level adjustment 55
 - salvage 58
 - settings 54

- shot mark settings 55
- time 32, 80, 92
- Recording and playback control
 - section 21
- REF.VIDEO INPUT connectors 29
- Reference signal 26
- REMOTE connector 28
- Remote control switch 18
- REMOTE(9P) connector 28
- Repeat playback 130
- RESET/RETURN button 20
- Returning to factory default settings 127

S

- Salvage function 58
- Scene
 - finding 75, 76
- Scene Selection 85
- Scrollbar 68
- SD/HDSDI INPUT connector 28
- SDSDI OUTPUT 1, 2 (SUPER) connectors 29
- Select Essence Mark screen 76
- Select Index screen 79
- Set Start Time Code screen 89
- Setup menu
 - basic menu 122
 - extended menu 129
- SHIFT button 21
- Shortcut 103
- SHTL/JOG button 19
- Shuttle
 - dial 20
 - mode 64
- Shuttle/jog/variable control section 19
- Skip Scroll 74
- Specifications 167
- STANDBY indicator 22
- STOP button 22
- SUB CLIP
 - button 20, 66
 - indicator 20, 66
- Sub clip 85
 - adding 86
 - deleting 89
 - reordering 88
 - trimming 88
- Superimposed text information 45
- Supplying power 32
 - AC power supply 32
 - Battery power supply 32
 - DC power supply 32
- Synchronization reference signals 42
- System frequency setting 34
- System information 25

T

- Text information 45
- THUMBNAIL
 - button 66
 - indicator 21, 66
- Thumbnail
 - display items 68
 - operations 74
 - selecting 74
 - selecting information displayed 79
 - selecting multiple thumbnails 75
- Thumbnail Menu 70
- Thumbnail search 75
 - using chapter function 75
 - using essence marks 76
 - using expand function 75
 - using thumbnails 75
- Tilt mechanism 35
- TIME CODE
 - IN connector 30
 - OUT connector 30
- Time data display area 24
- Timecode 43
 - after setting initial value 43
 - input/output section 30
 - recording external timecode directly 45
 - recording sequentially upon the last recorded timecode 44
 - recording with the internal timecode generator synchronized 44
 - setting to current time 44
- Title 107
- Troubleshooting 157

U

- UMID Data 171
- USB connector 29
- User bits
 - setting 44

V

- VAR/JOG button 19
- VARIABLE switch 18
- Variable-speed mode 65
- VIDEO CONTROL connector 28
- Video input display 26

W

- Web Thumbnail function 94
- Write-protecting discs 53

The material contained in this manual consists of information that is the property of Sony Corporation and is intended solely for use by the purchasers of the equipment described in this manual.

Sony Corporation expressly prohibits the duplication of any portion of this manual or the use thereof for any purpose other than the operation or maintenance of the equipment described in this manual without the express written permission of Sony Corporation.

PDW-F1600
PDW-HD1500
(SYL)
3-282-295-06 (1)

Sony Corporation

<http://www.sony.net/>
Printed on recycled paper.

Printed in Japan
2009.05 13
© 2008