

## Interchangeable Lens Digital Camera

# α65

Instruction Manual

A-mount

Preparing the camera

Shooting and viewing  
images

Shooting images to suit  
your subject

Using the shooting  
functions

Using the playback  
functions

Functions list

Viewing images on a  
computer

Others

Index

# α

## Owner's Record

The model and serial numbers are located on the bottom.

Record the serial number in the space provided below.

Refer to these numbers whenever you call upon your Sony dealer regarding this product.

Model No. SLT-A65/A65V

Serial No. \_\_\_\_\_

## WARNING

**To reduce fire or shock hazard, do not expose the unit to rain or moisture.**

# IMPORTANT SAFETY INSTRUCTIONS SAVE THESE INSTRUCTIONS. DANGER - TO REDUCE THE RISK OF FIRE OR ELECTRIC SHOCK, CAREFULLY FOLLOW THESE INSTRUCTIONS.

If the shape of the plug does not fit the power outlet, use an attachment plug adaptor of the proper configuration for the power outlet.

## Caution

### Battery pack

If the battery pack is mishandled, the battery pack can burst, cause a fire or even chemical burns. Observe the following cautions.

- Do not disassemble.
- Do not crush and do not expose the battery pack to any shock or force such as hammering, dropping or stepping on it.
- Do not short circuit and do not allow metal objects to come into contact with the battery terminals.
- Do not expose to high temperature above 60°C (140°F) such as in direct sunlight or in a car parked in the sun.
- Do not incinerate or dispose of in fire.
- Do not handle damaged or leaking lithium ion batteries.
- Be sure to charge the battery pack using a genuine Sony battery charger or a device that can charge the battery pack.

- Keep the battery pack out of the reach of small children.
- Keep the battery pack dry.
- Replace only with the same or equivalent type recommended by Sony.
- Dispose of used battery packs promptly as described in the instructions.

### Battery charger

Even if the CHARGE lamp is not lit, the battery charger is not disconnected from the AC power source (mains) as long as it is connected to the wall outlet (wall socket). If some trouble occurs while using the battery charger, immediately shut off the power by disconnecting the plug from the wall outlet (wall socket).

The power cord (mains lead), if supplied, is designed specifically for use with this camera only, and should not be used with other electrical equipment.

## For Customers in the U.S.A. and Canada

### RECYCLING LITHIUM-ION BATTERIES

Lithium-Ion batteries are recyclable.

You can help preserve our environment by returning your used rechargeable batteries to the collection and recycling location nearest you.



For more information regarding recycling of rechargeable batteries, call toll free 1-800-822-8837, or visit <http://www.rbrclion.org/>

**Caution:** Do not handle damaged or leaking Lithium-Ion batteries.

### Battery Pack and lens

This device complies with Part 15 of the FCC Rules, Operation is subject to the following two conditions:

(1) This device may not cause harmful interference, and (2) this device must

accept any interference received, including interference that may cause undesired operation.

This Class B digital apparatus complies with Canadian ICES-003.

## For Customers in the U.S.A.

UL is an internationally recognized safety organization.

The UL Mark on the product means it has been UL Listed.

If you have any questions about this product, you may call:

Sony Customer Information Center  
1-800-222-SONY (7669)

The number below is for the FCC related matters only.

### Regulatory Information

Declaration of Conformity  
Trade Name: SONY  
Model No.: SLT-A65V  
Responsible Party: Sony Electronics Inc.  
Address: 16530 Via Esprillo,  
San Diego, CA 92127 U.S.A.  
Telephone No.: 858-942-2230

This device complies with Part 15 of the FCC Rules. Operation is subject to the following two conditions: (1) This device may not cause harmful interference, and (2) this device must accept any interference received, including interference that may cause undesired operation.

### CAUTION

You are cautioned that any changes or modifications not expressly approved in this manual could void your authority to operate this equipment.

## Note:

This equipment has been tested and found to comply with the limits for a Class B digital device, pursuant to Part 15 of the FCC Rules.

These limits are designed to provide reasonable protection against harmful interference in a residential installation. This equipment generates, uses, and can radiate radio frequency energy and, if not installed and used in accordance with the instructions, may cause harmful interference to radio communications. However, there is no guarantee that interference will not occur in a particular installation. If this equipment does cause harmful interference to radio or television reception, which can be determined by turning the equipment off and on, the user is encouraged to try to correct the interference by one or more of the following measures:

- Reorient or relocate the receiving antenna.
- Increase the separation between the equipment and receiver.
- Connect the equipment into an outlet on a circuit different from that to which the receiver is connected.
- Consult the dealer or an experienced radio/TV technician for help.

The supplied interface cable must be used with the equipment in order to comply with the limits for a digital device pursuant to Subpart B of Part 15 of FCC Rules.

## For Customers in Canada

This device complies with RSS-310 of Industry Canada. Operation is subject to the condition that this device does not cause harmful interference.

## For Customers in Europe



Hereby, Sony Corporation, declares that this SLT-A65V Interchangeable Lens Digital Camera is in compliance with the essential requirements and other relevant provisions of the Directive 1999/5/EC. For details, please access the following URL: <http://www.compliance.sony.de/>

### Notice for the customers in the countries applying EU Directives

The manufacturer of this product is Sony Corporation, 1-7-1 Konan Minato-ku Tokyo, 108-0075 Japan. The Authorized Representative for EMC and product safety is Sony Deutschland GmbH, Hedelfinger Strasse 61, 70327 Stuttgart, Germany. For any service or guarantee matters please refer to the addresses given in separate service or guarantee documents.

This product has been tested and found compliant with the limits set out in the R&TTE Directive for using connection cables shorter than 3 meters (9.8 feet).

### Attention

The electromagnetic fields at the specific frequencies may influence the picture and sound of this unit.

### Notice

If static electricity or electromagnetism causes data transfer to discontinue midway (fail), restart the application or disconnect and connect the communication cable (USB, etc.) again.

### **Disposal of Old Electrical & Electronic Equipment (Applicable in the European Union and other European countries with separate collection systems)**



This symbol on the product or on its packaging indicates that this product shall not be treated as household waste. Instead it shall be handed over to the applicable collection point for the recycling of electrical and electronic equipment. By ensuring this product is disposed of correctly, you will help prevent potential negative consequences for the environment and human health, which could otherwise be caused by inappropriate waste handling of this product. The recycling of materials will help to conserve natural resources. For more detailed information about recycling of this product, please contact your local Civic Office, your household waste disposal service or the shop where you purchased the product.

### **Disposal of waste batteries (applicable in the European Union and other European countries with separate collection systems)**



This symbol on the battery or on the packaging indicates that the battery provided with this product shall not be treated as household waste.

On certain batteries this symbol might be used in combination with a chemical symbol. The chemical symbols for mercury (Hg) or lead (Pb) are added if the battery contains more than 0.0005% mercury or 0.004% lead.

By ensuring these batteries are disposed of correctly, you will help prevent potentially negative consequences for the environment and human health which could otherwise be caused by inappropriate waste handling of the battery. The recycling of the materials will help to conserve natural resources.



In case of products that for safety, performance or data integrity reasons require a permanent connection with an incorporated battery, this battery should be replaced by qualified service staff only. To ensure that the battery will be treated properly, hand over the product at end-of-life to the applicable collection point for the recycling of electrical and electronic equipment.

For all other batteries, please view the section on how to remove the battery from the product safely. Hand the battery over to the applicable collection point for the recycling of waste batteries.

For more detailed information about recycling of this product or battery, please contact your local Civic Office, your household waste disposal service or the shop where you purchased the product.

## Notice for customers in the United Kingdom

A moulded plug complying with BS 1363 is fitted to this equipment for your safety and convenience.





Should the fuse in the plug supplied need to be replaced, a fuse of the same rating as the supplied one and approved by ASTA or BSI to BS 1362, (i.e., marked with an  or  mark) must be used.

If the plug supplied with this equipment has a detachable fuse cover, be sure to attach the fuse cover after you change the fuse.

Never use the plug without the fuse cover.

If you should lose the fuse cover, please contact your nearest Sony service station.

# Table of Contents

Notes on using your camera .....	9
<hr/> <b>Preparing the camera</b>	
Checking the supplied items .....	12
Identifying parts .....	13
Charging the battery pack .....	19
Inserting the battery pack/memory card (sold separately) .....	21
Attaching a lens .....	24
Turning the camera on and setting the clock .....	27
Before shooting .....	29
Adjusting the viewfinder to the visual acuity (diopter adjustment).....	29
Holding the camera properly .....	29
<hr/> <b>Shooting and viewing images</b>	
Shooting still images .....	30
Recording movies .....	32
Playing back images .....	33
Deleting images (Delete) .....	34
<hr/> <b>Shooting images to suit your subject</b>	
Adjusting the angle of the LCD monitor .....	35
Shooting with the various shooting modes .....	36
<b>AUTO</b> <sup>+</sup> .....	37
<b>SCN</b> Scene Selection .....	38
 Sweep Panorama/ <b>3D</b> 3D Sweep Panorama .....	39
 Continuous Advance Priority AE .....	40
<hr/> <b>Using the shooting functions</b>	
Using the flash .....	41
Adjusting the brightness of the image .....	43
 /  Selecting the drive mode .....	45
Switching the recording information display (DISP) .....	46
Setting image size .....	47
Image Size .....	47
Panorama: Size .....	47

---

## Using the playback functions

Enlarging images .....	49
Switching to the display of the image list .....	50
Viewing images on a TV screen .....	51

---

## Functions list

Functions that can be operated with the buttons/switch .....	52
Selecting a function with the Fn (Function) button .....	53
Functions that can be selected with the Fn (Function) button .....	54
The functions selected with the MENU button .....	56
Using the guide function of the camera .....	63
In-Camera Guide .....	63
Shooting Tip .....	63

---

## Viewing images on a computer

Using with your computer .....	65
Using the software .....	67
Selecting the method for creating a disc of movies .....	71

---

## Others

List of icons on the screen .....	73
Functions available for each shooting mode .....	76
Flash modes available .....	77
Learning more about the camera ( $\alpha$ Handbook) .....	78
Checking the number of recordable images/recording time .....	79
Specifications .....	83

---

<b>Index .....</b>	<b>91</b>
--------------------	-----------



# Notes on using your camera

## Shooting procedure

- This camera has 2 modes for monitoring subjects: the LCD monitor mode using the LCD monitor, and the viewfinder mode using the viewfinder.
- The recorded image may be different from the image you monitored before recording.

## Notes on the functions available with the camera

- To check whether it is a 1080 60i-compatible device or 1080 50i-compatible device, check for the following marks on the bottom of the camera.  
1080 60i-compatible device:60i  
1080 50i-compatible device:50i
- This camera is compatible with 1080 60p or 50p-format movies. Unlike standard recording modes up to now, which record in an interlacing method, this camera records using a progressive method. This increases the resolution, and provides a smoother, more realistic image.
- You may feel uncomfortable symptoms such as eyestrain, nausea, or a tired feeling while watching 3D-images recorded with the camera on 3D-compatible monitors. When you watch 3D-images, we recommend that you take a break at regular time intervals. Since the need for or frequency of break times varies among individuals, please set your own standards. If you feel sick, stop watching 3D-images, and consult a doctor as needed. Also, refer to the operating instructions of the connected device or the software used with the camera. A child's vision is always vulnerable (especially for children under 6 years of age). Before allowing them to watch 3D-images, please consult with an expert, such as a pediatric or ophthalmic doctor. Be sure to make sure your children follow the precautions above.

## No compensation for contents of the recording

The contents of the recording cannot be compensated for if recording or playback is not possible due to a malfunction of your camera or a memory card, etc.

## Back up recommendation

To avoid the potential risk of data loss, always copy (back up) data to other medium.

## Notes on the LCD monitor, electronic viewfinder, lens, and image sensor

- The LCD monitor and electronic viewfinder are manufactured using extremely high-precision technology so over 99.99% of the pixels are operational for effective use. However, there may be some tiny black points and/or bright points (white, red, blue or green in color) that constantly appear on the LCD monitor and electronic viewfinder. These points are normal in the manufacturing process and do not affect the images in any way.
- Do not hold the camera by taking hold of the LCD monitor.
- Do not expose the camera to sunlight or shoot sunward for a long time. The internal mechanism may be damaged. If sunlight is focused on a nearby object, it may cause a fire.
- There is a magnet on the back and around the rotating shaft of the hinge part of the LCD monitor. Do not bring anything that is easily affected by a magnet, such as floppy disk, credit cards near the LCD monitor.
- Images may trail across on the screen in a cold location. This is not a malfunction. When turning on the camera in a cold location, the screen may become temporarily dark. When the camera warms up, the screen will function normally.

## Notes on long-time recording

- When you continue to shoot for a long time, the temperature of the camera rises. If the temperature reaches above a certain level, the [H] mark is indicated on the screen and the camera is turned off automatically. If the power is turned off, leave the camera for 10 minutes or longer to allow the temperature inside the camera to decrease to a safe level.
- Under high ambient temperatures, the temperature of the camera rises quickly.
- When the temperature of the camera rises, the image quality may deteriorate. It is recommended that you wait until the temperature of the camera drops before continuing to shoot.
- The surface of the camera may get warm. This is not a malfunction.

## Notes on importing AVCHD View movies\* to a computer

When importing AVCHD View movies to a computer, for Windows computers, use the "PMB" software on the CD-ROM (supplied).

\* "AVCHD View movies" are movies that were recorded in the [AVCHD 60i/60p]/[AVCHD 50i/50p] mode of [File Format].

## Notes when playing movies on other devices

- This camera uses MPEG-4 AVC/H.264 High Profile for AVCHD format recording. Movies recorded in AVCHD format with this camera cannot be played with the following devices.
  - Other devices compatible with AVCHD format that does not support High Profile
  - Devices incompatible with the AVCHD format
 This camera also uses MPEG-4 AVC/H.264 Main Profile for MP4 format recording. For this reason, movies recorded in MP4 format with this camera cannot be played on devices other than those that support MPEG-4 AVC/H.264.
- Discs recorded with HD image quality (high definition) can be played back only

on AVCHD format-compatible devices. DVD-based players or recorders cannot play back HD image quality discs, as they are incompatible with the AVCHD format. Also, DVD-based players or recorders may fail to eject HD image quality discs.

- 1080 60p/50p movies can be played back on compatible devices only.

## On GPS-compatible devices (SLT-A65V only)

- To determine whether your camera supports GPS function, check the model name of your camera.  
GPS-compatible: SLT-A65V  
GPS-incompatible: SLT-A65
- Use GPS in accordance with regulations of countries and regions where you use it.
- If you do not record the location information, set [GPS On/Off] to [Off] (page 61).
- In an airplane, make sure to turn off the camera following cabin announcements.

## Warning on copyright

Television programs, films, videotapes, and other materials may be copyrighted. Unauthorized recording of such materials may be contrary to the provisions of the copyright laws.

## The pictures used in this manual

The photographs used as examples of pictures in this manual are reproduced images, and are not actual images shot using this camera.

## On the data specifications described in this manual

The data on performance and specifications is defined under the following conditions, except as described in this manual: at an ordinary ambient temperature of 25°C (77°F), and using a battery pack that is charged for about 1 hour after the CHARGE lamp goes out.

## Model name

This manual covers several models supplied with different lenses. The model name varies depending on the supplied lens. The available model varies depending on the countries/regions.

Model name	Lens
SLT-A65/A65V	–
SLT-A65K/ A65VK	DT18-55mm
SLT-A65Y/ A65VY	DT18-55mm and DT55-200mm
SLT-A65M/ A65VM	DT18-135mm

## Notes on shooting with the viewfinder

This camera is equipped with an XGA Organic Electro-Luminescence viewfinder with high resolution and high contrast. This viewfinder achieves a wide viewing angle and a long eye relief, approaching that of the DSLR-A900 equipped with a 35 mm full size sensor. This camera is designed to provide an easily viewable viewfinder by appropriately balancing various elements.

- The image may be slightly distorted near the corners of the viewfinder. This is not a malfunction. When you want to check every detail of the entire composition, you can also use the LCD monitor.
- If you pan the camera while looking into the viewfinder or move your eyes around, the image in the viewfinder may be distorted or the color of the image may change. This is a characteristic of the lens or display device and is not a malfunction. When you shoot an image, we recommend that you look at the center area of the viewfinder.

# Checking the supplied items

First check the model name of your camera (page 11). The accessories supplied differ depending on the model.

The number in parentheses indicates the number of pieces.

## Common accessories

- Camera (1)
- BC-VM10A Battery charger (1)

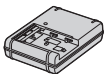

- Power cord (mains lead) (1)\* (not supplied in the U.S.A. and Canada)



\* Multiple power cords may be supplied with your camera. Use the appropriate one that matches your country/region.

- Rechargeable battery pack NP-FM500H (1)



- USB cable (1)



- Shoulder strap (1)

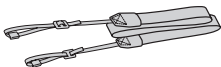

- Body cap (1) (Attached on the camera)



- Eyecup (1) (Attached on the camera)
- CD-ROM (1)
  - Application Software for  $\alpha$  camera
  - $\alpha$  Handbook
- Instruction Manual (This manual) (1)

## SLT-A65K/A65VK

- DT18-55mm zoom lens (1)/Front lens cap (1)/Packaging lid (1)

## SLT-A65Y/A65VY

- DT18-55mm zoom lens (1)/Front lens cap (1)/Packaging lid (1)
- DT55-200mm zoom lens (1)/Front lens cap (1)/Rear lens cap (1)/Lens hood (1)

## SLT-A65M/A65VM

- DT18-135mm zoom lens (1)/Front lens cap (1)/Rear lens cap (1)/Lens hood (1)

# Identifying parts

See the pages in parentheses for details of operation.



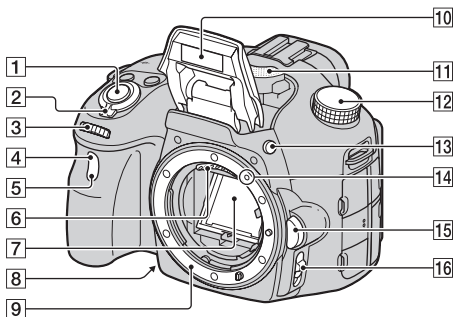



## Front side

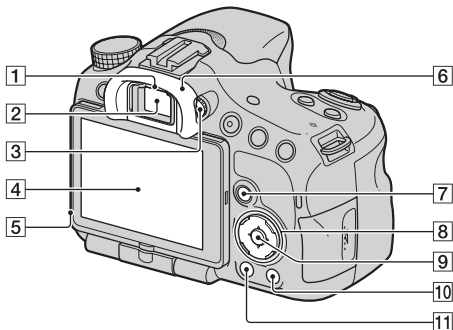

- 1 Shutter button (30)
  - 2 Power switch (27)
  - 3 Control dial
  - 4 Remote sensor (45)
  - 5 Self-timer lamp (45)
  - 6 Lens contacts\*
  - 7 Mirror\*
  - 8 Preview button (52)
  - 9 Mount
  - 10 Built-in flash\* (41)
  - 11 Microphone\*\*
  - 12 Mode dial (36)
  - 13 ⚡ (Flash pop-up) button (41, 52)
  - 14 Mounting index (24)
  - 15 Lens release button (25)
  - 16 Focus mode switch (52)
- \* **Do not directly touch these parts.**
- \*\* **Do not cover this part during movie recording. Doing so may cause noise or lower the volume.**





## Rear side

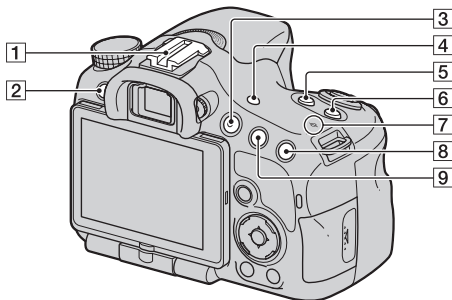

- 1** Eyepiece sensors
- 2** Viewfinder\*
- When you look into the viewfinder, the viewfinder mode is activated, and when you take your face away from the viewfinder, the screen mode returns to the LCD monitor mode.
- 3** Diopter-adjustment dial (29)
- 4** LCD monitor (73)
- 5** Light sensor
- 6** Eyecup
- 7** For shooting: Fn (Function) button (53, 54)  
For viewing: , (Image rotation) button (52)
- 8** Control button  
▲/▼/◀/▶/DISP (Display) (52)/  
WB (White balance) (52)/  
 /  (Drive) (45, 52)/  
(Picture Effect) (52)
- 9** Control button (Enter)/AF button (52)/Object Tracking button (52)
- 10** ? (In-Camera Guide) button (63)  
For viewing:  (Delete) button (34)
- 11**  (Playback) button (33)
- \* Do not directly touch this part.**

## Top side



- 1 Auto-lock Accessory shoe
- 2 MENU button (56)
- 3 MOVIE button (32, 52)
- 4 FINDER/LCD button (52)
- 5  (Exposure) button (43)
- 6 ISO button (52)
- 7  Image sensor position mark
- 8 For shooting:  (Smart teleconverter) button (52)/  
Focus Magnifier button (52)  
For viewing:  (Zoom in) button (49)
- 9 For shooting: AEL (AE lock) button (52)/AV (Aperture value) button (52)  
For viewing:  (Zoom out)

button (49)/ (Image index) button (50)

## Sides/Bottom

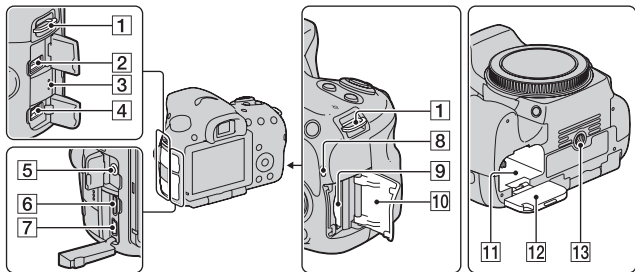
**1** Hooks for shoulder strap

- Attach both ends of the strap onto the camera.

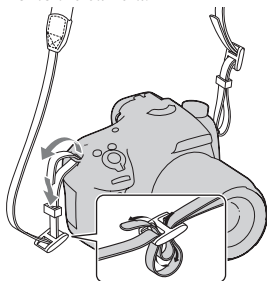
**2** REMOTE terminal

- When connecting the RM-L1AM Remote Commander (sold separately) to the camera, insert the plug of the Remote Commander into the REMOTE terminal, aligning the guide of the plug with the guide of the REMOTE terminal. Make sure that the cord of the Remote Commander faces forward.

**3** Speaker**4** DC IN terminal

- When connecting the AC-PW10AM AC Adaptor (sold separately) to the camera, turn the camera off, then plug the connector of the AC Adaptor to the DC IN terminal on the camera.

**5** Microphone jack

- When an external microphone is connected, the internal microphone is turned off automatically. When the external microphone is a plug-in-power type, the power of the microphone is supplied by the camera.

**6** HDMI terminal (51)**7**  (USB) terminal**8** Access lamp (22)**9** Memory card insertion slot (21)**10** Memory card cover (21)



- 
- 11 Battery insertion slot (21)
  - 12 Battery cover (21)
  - 13 Tripod receptacle
    - Use a tripod with a screw length of less than 5.5 mm (7/32 inch). You will be unable to firmly secure the camera to tripods with a screw length of 5.5 mm (7/32 inch) or longer, and attempting to do so may damage the camera.

## Lens

DT 18-55mm F3.5-5.6 SAM  
(Supplied with the SLT-A65K/A65VK/  
A65Y/A65VY)

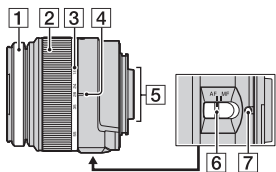

DT 55-200mm F4-5.6 SAM  
(Supplied with the SLT-A65Y/A65VY)

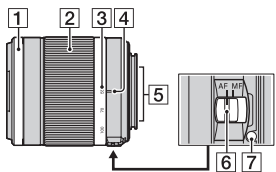

DT 18-135mm F3.5-5.6 SAM  
(Supplied with the SLT-A65M/A65VM)

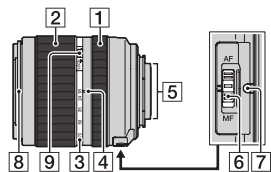

- 1 Focusing ring
- 2 Zoom ring
- 3 Focal-length scale
- 4 Focal-length index

- 5 Lens contacts
- 6 Focusing mode switch
- 7 Mounting index
- 8 Lens hood index
- 9 Zoom lock switch

- The DT 18-55mm F3.5-5.6 SAM/DT 55-200mm F4-5.6 SAM/DT 18-135mm F3.5-5.6 SAM are designed for Sony A-mount cameras (models equipped with an APS-C sized image sensor). You cannot use these lenses on 35mm-format cameras.
- For the lenses other than DT 18-55mm F3.5-5.6 SAM/DT 55-200mm F4-5.6 SAM/DT 18-135mm F3.5-5.6 SAM, refer to the operating instructions supplied with the lens.

# Charging the battery pack

When using the camera for the first time, be sure to charge the NP-FM500H “InfoLITHIUM” battery pack (supplied).

The “InfoLITHIUM” battery pack can be charged even when it has not been fully depleted.

It can also be used when it has not been fully charged.

The battery pack is discharged little by little without using it. To miss the opportunity to shoot, check the remaining battery level before use. If the battery level is low, charge it again.

---

## 1 Insert the battery pack onto the battery charger.

Push the battery pack until it clicks.

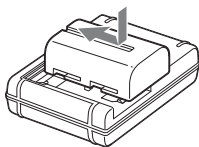

## 2 Connect the battery charger to the wall outlet (wall socket).

Light on: Charging

Light off: Charge completed

Charging time	About 175 minutes
---------------	-------------------

- When charging a fully depleted battery pack at a temperature of 25°C (77°F).
- The CHARGE lamp turns off when charging is completed.

For the U.S.A and Canada

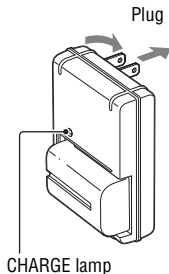

For countries/regions other than the U.S.A. and Canada

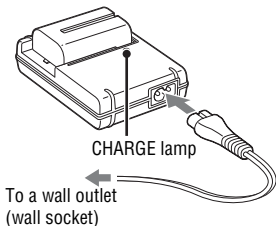

### Notes

- The charging time differs depending on the remaining capacity of the battery pack or charging conditions.
- We recommend charging the battery pack in an ambient temperature of between 10°C to 30°C (50°F to 86°F). You may not be able to efficiently charge the battery pack outside of this temperature range.
- Connect the battery charger to the nearest wall outlet (wall socket).

# Inserting the battery pack/memory card (sold separately)

- 1 While sliding the battery cover open lever, open the cover.

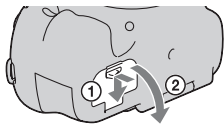

- 2 Firmly insert the battery pack all the way while pressing the lock lever with the tip of the battery.

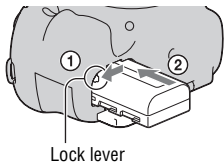

- 3 Close the cover.



- 4 While sliding the memory card cover, open the cover.

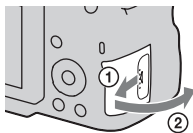

## 5 Insert a memory card.

- With the notched corner facing as illustrated, insert the memory card until it clicks into place.

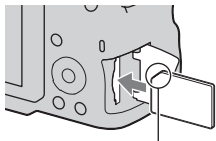

Ensure the notched corner faces correctly.

## 6 Close the cover.

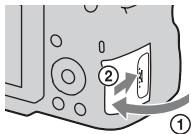

### To remove the battery pack

Turn off the camera and slide the lock lever in the direction of the arrow. Be careful not to drop the battery pack.

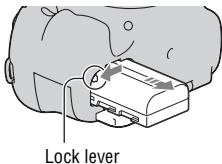

### To remove the memory card

Check that the access lamp is not lit, then open the cover, and push the memory card once.

### To check the remaining battery level

The supplied battery pack is a lithium-ion battery pack that has functions for exchanging information related to operating conditions with your camera. The remaining battery time in percent figures is displayed according to the operating conditions of your camera.

Battery level						<b>“Battery exhausted.”</b>
	High  Low					You cannot shoot any more pictures.

## Available memory cards

The following memory cards are compatible with this camera. However, all memory cards are not guaranteed to work with this camera.

Types of memory card	Still images	Movies	In this manual
Memory Stick PRO Duo	✓	✓ (Mark2)	Memory Stick PRO Duo
Memory Stick PRO-HG Duo	✓	✓	
SD memory card	✓	✓ (Class 4 or faster)	SD card
SDHC memory card	✓	✓ (Class 4 or faster)	
SDXC memory card	✓	✓ (Class 4 or faster)	

- MultiMediaCard cannot be used.

### Note

- Images recorded on an SDXC memory card cannot be imported to or played on computers or AV devices that are not compatible with exFAT. Make sure that the device is compatible with exFAT before connecting it to the camera. If you connect your camera to an incompatible device, you may be prompted to format the card. Never format the card in response to this prompt, as doing so will erase all data on the card. (exFAT is the file system used on SDXC memory cards.)

# Attaching a lens

## 1 Remove the body cap from the camera and the packaging lid from the rear of the lens.

- When changing the lens, quickly change the lens away from dusty locations so as to keep dust or debris from getting inside the camera.
- When shooting, remove the front lens cap from the front of the lens.

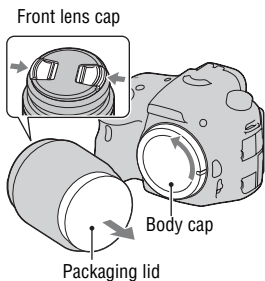

## 2 Mount the lens by aligning the orange index marks (mounting indexes) on the lens and camera.

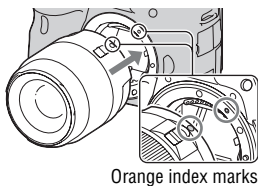

## 3 Turn the lens clockwise until it clicks into the locked position.

- Be sure to put the lens on straight.

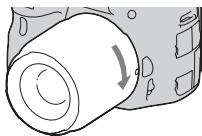

### Notes

- When attaching a lens, do not press the lens release button.
- Do not use force when attaching a lens.
- E-mount lenses are not compatible with this camera.
- When you use a lens for which a tripod socket is provided, attach the lens onto the tripod using the tripod socket provided to help balance the weight of the lens.
- When carrying the camera with a lens attached, hold both the camera and the lens firmly.



- Do not hold the part of the lens that is extended for the zoom or focus adjustment.

## To remove the lens

- 1 Press the lens release button all the way in and turn the lens counterclockwise until it stops.**

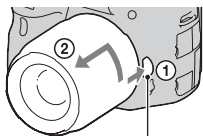

Lens release button

- 2 Attach the caps to the front and rear of the lens and the body cap to the camera.**

- Before you attach them, remove dust from them.
- A rear lens cap is not supplied with the DT 18-55mm F3.5-5.6 SAM Lens Kit. When you store the lens without attaching it to the camera, purchase the Rear Lens Cap ALC-R55.

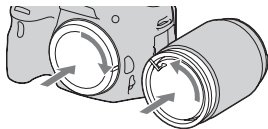

## To attach a lens hood

It is recommended that you use a lens hood to reduce flare and ensure maximum image quality.

Fit the hood into the mount on the end of the lens barrel and rotate the hood clockwise until it clicks.

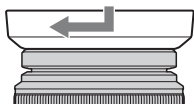

### Notes

- A lens hood is not included with the DT 18-55mm F3.5-5.6 SAM. You can use the ALC-SH108 (sold separately).
- The lens hood may block the light of the flash. Remove the lens hood when using the flash.

- When storing, turn over the lens hood and place it onto the lens backwards.

### **Note on changing the lens**

When changing the lens, if dust or debris gets inside the camera and adheres to the surface of the image sensor (the part that acts as the film), it may appear as dark spots on the image, depending on the shooting environment.

The camera is equipped with an anti-dust function to prevent dust from landing on the image sensor. However, quickly change the lens away from dusty locations when attaching/removing a lens.

# Turning the camera on and setting the clock

When you turn the camera on for the first time, the date/time setup screen appears.

## 1 Set the power switch to ON to turn the camera on.

The screen used for setting date and time appears.

- To turn the camera off, set it to OFF.

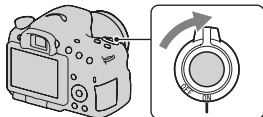

## 2 Verify that [Enter] is selected on the LCD monitor, then press the center of the control button.

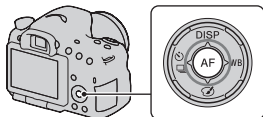

## 3 Select your area with ◀/▶ on the control button, then press the center of the control button.

## 4 Select each item with ◀/▶ and set the numeric value with ▲/▼.

[Daylight Svg.]: Turns on or off the daylight saving time setting.

[Date Format.]: Selects the format to display date.

- Midnight is indicated as 12:00 AM, and noon as 12:00 PM.

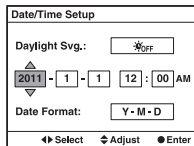
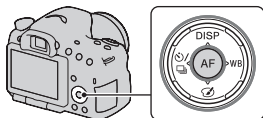

---

**5 Repeat step 4 to set other items, then press the center of the control button.**

---

**6 Verify that [Enter] is selected, then press the center of the control button.**

---

#### **To cancel the date/time setting operation**

Press the MENU button.

#### **To set up the date/time again**

When you turn the camera on for the first time, the date/time setup screen appears automatically. The next time, set up the date and time from the menu.

**MENU button →  1 → [Date/Time Setup]**

#### **To set up the area again**

You can set the area where you are using the camera. This allows you to set the local area when you use the camera abroad.

**MENU button →  1 → [Area Setting]**

#### **Maintaining the date and time setting**

This camera has an internal rechargeable battery for maintaining the date and time and other settings regardless of whether the power is on or off, or the battery is installed or not.

# Before shooting

## Adjusting the viewfinder to the visual acuity (diopter adjustment)

Adjust the diopter-adjustment dial to your eyesight until the display appears clearly in the viewfinder.

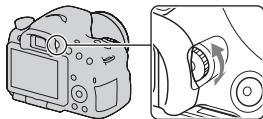

### Note

- The dioptic adjustment attachment (sold separately) cannot be used with this camera.

## Holding the camera properly

Stabilize your upper body and take a position that keeps the camera from moving.

In LCD monitor mode



In viewfinder mode



In viewfinder mode  
(vertical position)



### Point ①

One hand holds the grip of the camera, and the other hand supports the lens.

### Point ②

Take a secure stance with your feet shoulder-width apart.

### Point ③

Lightly tuck your elbows against your body.

When shooting in a kneeling position, steady your upper body by placing your elbow on your knee.

# Shooting still images

The “AUTO” mode allows you to easily shoot any subject under any conditions because the camera makes appropriate judgments on the situation to adjust the settings.

Select  when shooting in a location where the use of a flash is restricted.

- 1 Set the mode dial to **AUTO** or  (Flash Off).**

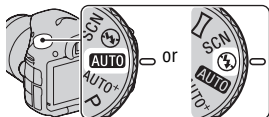

- 2 Hold the camera, monitoring your shot with the LCD monitor or viewfinder.**

- 3 Overlay the AF area on the desired subject.**

- If the  (Camera shake warning) indicator flashes, carefully shoot the subject, holding the camera steady, or by using a tripod.

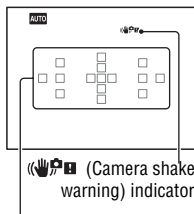

- 4 When using a zoom lens, turn the zoom ring, then decide on your shot.**

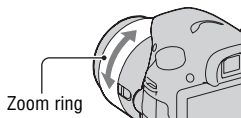

## 5 Press the shutter button halfway down to focus.

When the focus is confirmed, ● or (Focus indicator) lights up.

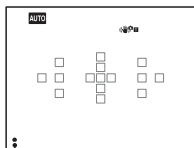
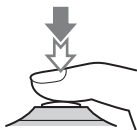

Focus indicator

## 6 Press the shutter button fully down to shoot.

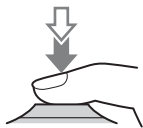

# Recording movies

---

## 1 Press the MOVIE button to start recording.

- Movie recording can be started from any exposure mode.
- The shutter speed and aperture are adjusted automatically. If you want to set them to particular values, set the mode dial to  (Movie) (page 36).
- The camera continues to adjust the focus when it is in autofocus mode.

MOVIE button



## 2 Press the MOVIE button again to stop recording.

---

### Notes

- The sound of the camera and the lens in operation may be recorded while recording a movie. You can disable sound recording by setting [Audio Recording] to [Off] (page 57).
- The continuous recording time of a movie may be shorter, depending on the ambient temperature or the status of the camera. See “Notes on continuous movie recording.”
- When the  mark is indicated, the temperature of the camera is too high. Turn the camera off and wait until the temperature of the camera drops.



# Playing back images

**1** Press the  button.

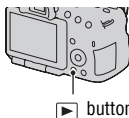

**2** MENU button →  1 → [View Mode] → Select the desired mode

- To play back still images, select [Folder View(Still)], and to play back movies, select [Folder View(MP4)] or [AVCHD View] according to the file format.

**3** Select an image with /▶ on the control button.

- To play back movies, press the center of the control button.

During movie playback	Control button/control dial operation
To pause/resume	●
To fast-forward	▶
To fast-rewind	◀
To slow-forward	Rotate the control dial to the right during pause
To slow-reverse	Rotate the control dial to the left during pause <ul style="list-style-type: none"><li>• The movie is played back frame-by-frame.</li></ul>
To adjust sound volume	▼ → ▲/▼
To display the information	▲

## Note

- Movies recorded with other devices may not be played back on this camera.

# Deleting images (Delete)

Once you have deleted an image, you cannot restore it. Check whether to delete the image or not beforehand.

## Note

- Protected images cannot be deleted.

## Deleting the image that is currently displayed

---

- 1** Display the image you want to delete and press the  button.

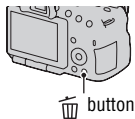

- 2** Select [Delete] with **▲** on the control button, then press the center of the control button.
-

# Adjusting the angle of the LCD monitor

## Adjust the LCD monitor to an easily viewable angle.

- The LCD monitor tilts 180 degrees.
- The LCD monitor can be rotated leftward 270 degrees from the position in which the LCD monitor is facing forward.
- When the LCD monitor is not used, it is recommended that you close it with the screen side facing to the camera.

### Note

- When the LCD monitor is open, the eye sensor may not be able to function in situations involving low-position shooting. If you look into the viewfinder and the monitor is not switched automatically, press the FINDER/LCD button.

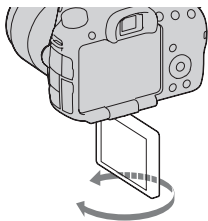
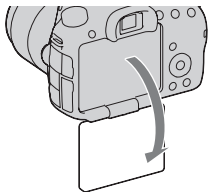



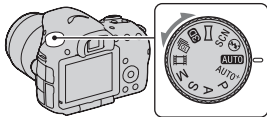

# Shooting with the various shooting modes

Set the mode dial to the desired mode.



The following shooting modes are provided with the camera:

<b>AUTO (AUTO)/</b>  (Flash Off)	The “AUTO” mode allows you to easily shoot any subject under any conditions because the camera makes appropriate judgments on the situation to adjust the settings. Select “Flash Off” when you want to shoot without the flash.
<b>AUTO<sup>+</sup> (Auto+)</b>	The camera recognizes and evaluates the shooting condition, and appropriate settings are set automatically. The camera saves 1 appropriate image by combining or separating images, as necessary.
<b>SCN (Scene Selection)</b>	Selecting an appropriate mode for the subject or the shooting conditions allows you to shoot the image with a suitable setting for the subject.
 (Sweep Panorama)	Allows you to shoot panoramic images.
<b>3D</b> (3D Sweep Panorama)	Allows you to shoot 3D panoramic images for playback on a 3D compatible TV.
 (Cont. Priority AE)	The camera continues to shoot while the shutter button is pressed fully down. The camera records the images continuously at a maximum of about 10 images per second.
 (Movie)	Allows you to shoot movies with the exposure adjusted manually (both the shutter speed and the aperture value).
<b>P (Program Auto)</b>	Allows you to shoot with the exposure adjusted automatically (both the shutter speed and the aperture value). The other settings can be adjusted manually.
<b>A (Aperture Priority)</b>	Allows you to shoot after adjusting the aperture value manually using the control dial.
<b>S (Shutter Priority)</b>	Allows you to shoot after adjusting the shutter speed manually using the control dial.

**M (Manual Exposure)**

Allows you to shoot after adjusting the exposure manually (both the shutter speed and the aperture value) using the control dial.

**AUTO<sup>+</sup>****1 Set the mode dial to AUTO<sup>+</sup> (Auto+).****2 Point the camera towards the subject.**

When the camera recognizes and adjusts for shooting conditions, the following information is indicated: recognized scene mode mark, appropriate shooting function, the number of images to be shot.

Recognized scene mode mark

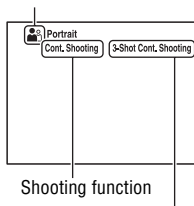

Number of images to be shot

**3 Adjust the focus and shoot the subject.****Scene recognized by the camera**

(Night Scene)	(Hand-held Twilight)	(Landscape)
(Backlight Portrait)	(Portrait)	(Tripod Night Scene)
(Backlight)	(Macro)	(Night Portrait)
(Spotlight)	(Low Brightness)	(Baby)

**Shooting function**

Cont. Shooting (45)	Slow Sync. (41)	Auto HDR (54)
Daylight Sync.	Slow Shutter	Hand-held Twilight (38)

## SCN Scene Selection









**1** Set the mode dial to SCN (Scene Selection).

**2** Press the center of the control button.

**3** Select the desired mode with ▲/▼, then press the center of the control button.

- To change the scene, press the Fn button, then select another scene.

**4** Adjust the focus and shoot the subject.

 (Portrait)	Blurs away backgrounds and sharpens the subject. Expresses skin tones softly.
 (Sports Action)	Shoots a moving subject at a fast shutter speed so that the subject looks as if it is standing still. The camera shoots images continuously while the shutter button is pressed.
 (Macro)	Shoots close subjects such as flowers, foods.
 (Landscape)	Shoots the entire range of scenery in sharp focus with vivid colors.
 (Sunset)	Shoots the red of the sunrise or sunset beautifully.
 (Night Scene)	Shoots night scenes at a distance without losing the dark atmosphere of the surroundings.
 (Hand-held Twilight)	Shoots night scenes with less noise and blur without using a tripod. A burst of shots are taken, and image processing is applied to reduce subject blur, camera shake, and noise.
 (Night Portrait)	Shoots portraits in night scenes.

## Sweep Panorama/ 3D Sweep Panorama

**1** Set the mode dial to  (Sweep Panorama)/ (3D Sweep Panorama).

**2** Press the center of the control button.

**3** Point the camera at the edge of the subject, then press the shutter button halfway down to adjust the focus.

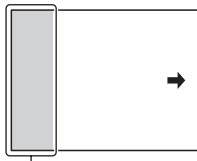

This part will not be taken

**4** Press the shutter button fully down.

**5** Pan or tilt the camera to the end, following the guidance on the screen.

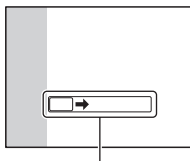

Guidance bar

---

** Continuous Advance Priority AE**

---

**1** Set the mode dial to  (Cont. Priority AE).

---

**2** Adjust the focus and shoot the subjects.

- The camera continues to shoot while the shutter button is pressed fully down.
  - The camera records the images continuously at a maximum of about 10 images per second.
-



# Using the flash

In a dark location, using the flash allows you to shoot the subject brightly, and it also helps to prevent camera shake. When shooting into the sun, you can use the flash to shoot a bright image of the backlit subject.

---

## 1 Fn button → ⚡ (Flash Mode) → Select the desired setting

- For further information on the flash modes available for each shooting mode, see page 77.

---

## 2 Press the ⚡ button.

The flash pops up.

- In AUTO, AUTO+ or Scene Selection mode, the flash automatically pops up if the amount of light is insufficient or the subject is backlit. The built-in flash does not pop up even if you press the ⚡ button.

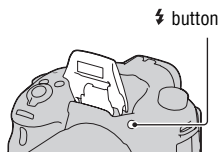

---

## 3 After the flash has finished charging, shoot the subject.





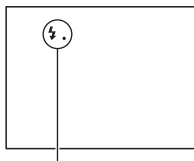

**⚡● Flashing:** The flash is being charged. When the indicator flashes, you cannot release the shutter.

**⚡● Lit:** The flash has been charged and is ready to fire.

- When you press the shutter button halfway down under dark lighting in autofocus mode, the flash may be fired to help focus on a subject (AF Illuminator).



**⚡●** (Flash charging) indicator

 <b>(Flash Off)</b>	Does not fire even the built-in flash pops up. <ul style="list-style-type: none"><li>• You cannot select this item when the mode dial is set to P, A, S, or M. However, the flash will not be fired if it is not pulled up.</li></ul>
 <b>(Autoflash)</b>	Fires if it is dark or against light.
 <b>(Fill-flash)</b>	Fires every time you trigger the shutter.
 <b>(Slow Sync.)</b>	Fires every time you trigger the shutter. Slow sync shooting allows you to shoot a clear image of both the subject and the background by slowing the shutter speed.
 <b>(Rear Sync.)</b>	Fires right before the exposure is completed every time you trigger the shutter.
 <b>(Wireless)</b>	Fires an external flash (sold separately) that is off the camera and away from it (Wireless flash shooting).

# Adjusting the brightness of the image

Except for exposure mode M, the exposure is automatically selected (Automatic exposure).

Based on the exposure acquired by the automatic exposure, you can perform exposure compensation. You can make the entire image brighter by shifting to the + side. The entire image becomes darker when you shift it to the - side (Exposure compensation).

## 1 Press the button.

 button



## 2 Adjust the exposure with the control dial.

Toward + (over): Brightens an image.

Toward - (under): Darkens an image.

- In viewfinder mode, confirm the exposure using the EV scale.

LCD monitor

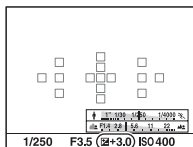

Compensated exposure

Viewfinder

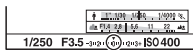

Standard exposure

## 3 Adjust the focus and shoot the subject.

### Shooting techniques

- Adjust the compensation level by checking the recorded image.
- Using bracket shooting, you can shoot multiple images with the exposure shifted to the plus or minus sides (page 45).

**Note**





- This item cannot be set when the exposure mode is set to AUTO, AUTO+, or Scene Selection.

## / **Selecting the drive mode**

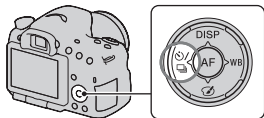
You can use an appropriate drive mode to suit your purposes, such as single-shot advanced, continuous advanced, or bracket.

 /  **on the control button** →  
**Select the desired mode**



 <b>(Single Shooting)</b>	This mode is for normal shooting.
 <b>(Cont. Shooting)</b>	The camera records the images continuously.
 <b>(Self-timer)</b>	The 10-second self-timer is convenient when the photographer appears in a photo and the 2-second self-timer is convenient to reduce the camera shake.
<b>BRK C (Bracket: Cont.)</b>	You can shoot 3 images, each with different degrees of exposure.
<b>BRK S (Single Bracket)</b>	You can shoot 3 images, shot by shot, each with different degrees of exposure.
<b>BRK WB (WB bracket)</b>	Based on the selected white balance, and the color temperature/color filter, 3 images are recorded with the white balance shifted.
 <b>(Remote Cdr.)</b>	You can shoot using the SHUTTER and 2SEC (the shutter is released after 2 seconds) buttons on the RMT-DSLR1 Wireless Remote Commander (sold separately).

# Switching the recording information display (DISP)

Each time you press DISP on the control button, the recording information display changes as follows.

You can select the available displays in the viewfinder or on the LCD monitor separately.

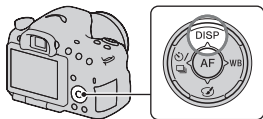

## Graphic Display

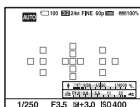

## Display All Info.

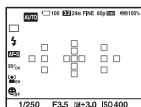

## No Disp. Info.

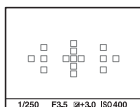

## Level

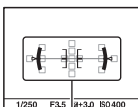

Digital level gauge

## Graphic Display

The Graphic Display shows the shutter speed and aperture value as graphs, and clearly illustrates how the exposure works. The pointers on the shutter speed indicator and aperture indicator indicate the current value.

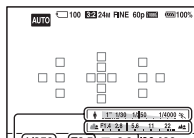

Aperture value  
Shutter speed

# Setting image size

## Image Size

**MENU button** →  **1** → **[Image Size]** → **Select the desired size**

**[Aspect Ratio]: [3:2]**

Image size		Usage guidelines
<b>L:24M</b>	6000 × 4000 pixels	For shooting at the highest image quality
<b>M:12M</b>	4240 × 2832 pixels	For prints up to A3+ size
<b>S:6.0M</b>	3008 × 2000 pixels	For prints up to A5 size

**[Aspect Ratio]: [16:9]**

Image size		Usage guidelines
<b>L:20M</b>	6000 × 3376 pixels	For viewing on a high-definition TV
<b>M:10M</b>	4240 × 2400 pixels	
<b>S:5.1M</b>	3008 × 1688 pixels	

### Note

- When you select a RAW image with [Quality], the image size of the RAW image corresponds to L. This size is not displayed on the screen.

## Panorama: Size

You can set the image size of panoramic images. The image size varies depending on the setting of the shooting direction (page 56).

**MENU button** →  **1** → **[Panorama: Size]** or **[3D Pan.: Image Size]** → **Select the desired size**

**[Panorama: Size]**

<b>Standard</b>	[Panorama: Direction] is set to [Up] [Down]: 3872 × 2160 [Panorama: Direction] is set to [Right] [Left]: 8192 × 1856
<b>Wide</b>	[Panorama: Direction] is set to [Up] [Down]: 5536 × 2160 [Panorama: Direction] is set to [Right] [Left]: 12416 × 1856

**[3D Pan.: Image Size]**

<b>16:9</b>	1920 × 1080
<b>Standard</b>	4912 × 1080
<b>Wide</b>	7152 × 1080



# Enlarging images

A still image can be enlarged for closer examination. This is convenient to check the focus condition of a recorded image.

---

**1 Display the image you want to enlarge, then press the  $\oplus$  button.**

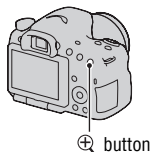

**2 Zoom the image in or out with the  $\oplus$  button or  $\ominus$  button.**

- Rotating the control dial switches the image at the same display magnification. When you shoot multiple images with the same composition, you can compare their focus conditions.
- 

**3 Select the portion you want to enlarge with  $\blacktriangle$ / $\blacktriangledown$ / $\blacktriangleleft$ / $\blacktriangleright$  on the control button.**

---

## To cancel the enlarged playback

Press the center of the control button so that the image returns to the normal size.

# Switching to the display of the image list

You can display multiple images on the screen simultaneously.

## Press the button.

The image index screen is displayed.

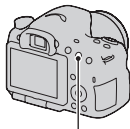

 button

## To return to the single-image screen

Press the center of the control button when you select the desired image.

## To display the desired folder

Select the left bar on the image index screen with the control button, then select the desired folder with ▲/▼. Pressing the center of the control button when the left bar is selected switches the view mode.



# Viewing images on a TV screen

To view images recorded on the camera on a TV set, an HDMI cable (sold separately) and an HD TV equipped with an HDMI connector are required.

## 1 Turn off both your camera and the TV, and connect the camera to the TV.

① To the HDMI connector

HDMI cable  
(sold separately)

② To the  
HDMI terminal

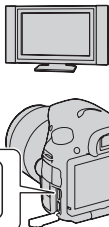



## 2 Turn on the TV and switch the input.

- See also the operating instructions supplied with the TV.

## 3 Turn on the camera, and press the button.

Images shot with the camera appear on the TV screen.





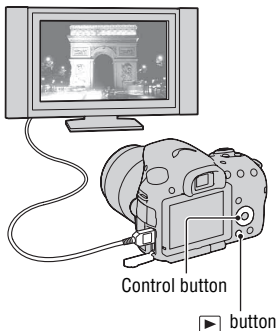



Select the desired image with   on the control button.

- The LCD monitor on the camera does not turned on.



# Functions that can be operated with the buttons/switch

You can set up or operate various functions with these buttons/switch. For the location of the buttons/switch, see “Identifying parts” (page 13).

 <b>button</b>	Pops the flash up.
 <b>button</b>	Compensates the exposure.
<b>ISO button</b>	Adjusts the ISO sensitivity.
<b>FINDER/LCD button</b>	Switches the display between the LCD monitor and the viewfinder.
<b>MENU button</b>	Displays the menu screen for setting up the menu item.
<b>MOVIE button</b>	Records movies.
<b>AEL button/AV button/ button/ button</b>	Fixes the exposure of the entire screen./Sets up the aperture value./Displays multiple images on the screen simultaneously./Scales down an image that has been scaled up when viewing images.
 <b>button/Focus Magnifier button/ button</b>	Zooms in to the center of an image./Allows you to check the focus by enlarging the image before shooting./Scales an image up when viewing images.
<b>Fn button/ <b>button</b></b>	Displays the setup screen of the function that is set using the Fn button./Rotates images.
<b>Control button</b>	Sets up the following functions: Display, White Balance, Drive mode, Picture Effect, and Autofocus.
 <b>button</b>	Plays back images.
<b>? button/ <b>button</b></b>	Displays a shooting tip or In-Camera Guide./Deletes images.
<b>Focus mode switch</b>	Switches the autofocus and manual focus.
<b>Preview button</b>	Checks blurring of the background.

# Selecting a function with the Fn (Function) button

This button is used for setting up or executing functions used frequently in shooting.

## 1 Press the Fn button.

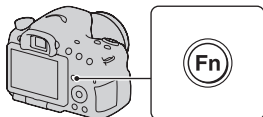

## 2 Select the desired item with ▲/▼/◀/▶ on the control button, then press the center ● to execute.

The setup screen appears.

## 3 Following the operation guide, select and execute the desired function.

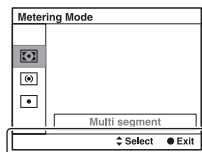

Operation guide

### To set up the camera directly from the recording information screen

Turn the control dial without pressing the center ● in step 2. You can set up the camera directly from the recording information screen.

# Functions that can be selected with the Fn (Function) button

The functions that can be selected with the Fn button are as follows:

<b>Scene Selection</b>	Selects an appropriate mode from among the Scene Selection preset settings to suit shooting conditions. (Portrait/Sports Action/Macro/Landscape/Sunset/Night Scene/Hand-held Twilight/Night Portrait)
<b>Movie</b>	Selects the exposure mode to suit your subject or your effect. (P/A/S/M)
<b>Drive Mode</b>	Sets the drive mode such as continuous shooting. (Single Shooting/Cont. Shooting/Self-timer/Bracket: Cont./Single Bracket/WB bracket/Remote Cdr.)
<b>Flash Mode</b>	Sets the flash mode. (Flash Off/Autoflash/Fill-flash/Slow Sync./Rear Sync./Wireless)
<b>Autofocus Mode</b>	Selects the method for focusing according to movement of the subject. (Single-shot AF/Automatic AF/Continuous AF)
<b>AF area</b>	Selects the area of focus. (Wide/Zone/Spot/Local)
<b>Object Tracking</b>	Keeps the focus on a subject while tracking it. (On/Off)
<b>Face Detection</b>	Automatically captures people's face(s) with the optimal focus and exposure. (On/On (Regist. Faces)/Off)
<b>Smile Shutter</b>	Shoots when a smile is detected. (On/Off)
<b>ISO</b>	Sets the sensitivity to light. The larger the number, the faster the shutter speed. (Multi Frame Noise Reduct./ISO AUTO to 16000)
<b>Metering Mode</b>	Selects the method for measuring brightness. (Multi segment/Center weighted/Spot)
<b>Flash Comp.</b>	Adjusts the intensity of flash output. (+2.0EV to -2.0EV)
<b>White Balance</b>	Adjusts the color tone of images. (Auto WB/Daylight/Shade/Cloudy/Incandescent/Fluor.: Warm White/Fluor.: Cool White/Fluor.: Day White/Fluor.: Daylight/Flash/Color Temp./Color Filter/Custom)

<b>DRO/Auto HDR</b>	Compensates for the brightness and contrast automatically. (Off/D-Range Opt./Auto HDR)
<b>Creative Style</b>	Selects your desired image processing. (Standard/Vivid/Portrait/Landscape/Sunset/Black & White)
<b>Picture Effect</b>	Shoots with the desired effect filter to achieve more impressive expression. (Off/Toy Camera/Pop Color/Posterization/Retro Photo/Soft High-key/Partial Color/High Contrast Mono./Soft Focus/HDR Painting/Rich-tone Mono./Miniature)

# The functions selected with the MENU button

You can set up the basic settings for the camera as a whole or execute functions such as shooting, playback, or other operations. Press the MENU button, then set up the desired item with ▲/▼/◀/▶ on the control button, then press the center of the control button.

Select a page of the menu

Select an item on the menu

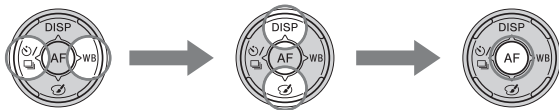

## Still shooting menu



<b>Image Size</b>	Selects the size of still images. (L:24M/M:12M/S:6.0M (When [Aspect Ratio] is set to 3:2) L:20M/M:10M/S:5.1M (When [Aspect Ratio] is set to 16:9))
<b>Aspect Ratio</b>	Selects the aspect ratio for still images. (3:2/16:9)
<b>Quality</b>	Sets the image quality for still images. (RAW/RAW & JPEG/Fine/Standard)
<b>Panorama: Size</b>	Selects the size of panoramic images. (Standard/Wide)
<b>Panorama: Direction</b>	Sets the shooting direction for panoramic images. (Right/Left/Up/Down)
<b>3D Pan.: Image Size</b>	Selects the size of 3D-images. (16:9/Standard/Wide)
<b>3D Pan.: Direction</b>	Sets the shooting direction for 3D-images. (Right/Left)



<b>Long Exposure NR</b>	Sets noise reduction processing for shots in which shutter speed will be 1 second or longer. (On/Off)
-------------------------	--



<b>High ISO NR</b>	Sets noise reduction processing for high-sensitivity shooting. (High/Normal/Low)
<b>Flash control</b>	Sets the method for determining the intensity of flash output. (ADI flash/Pre-flash TTL)
<b>AF Illuminator</b>	Sets the AF illuminator, which sheds light on a dark scene to aid focusing. (Auto/Off)
<b>Color Space</b>	Changes the range of reproducible colors. (sRGB/AdobeRGB)
<b>SteadyShot</b>	Sets SteadyShot. (On/Off)
<b>Shooting Tip List</b>	Allows you to access all shooting tips.

## Movie shooting menu



<b>File Format</b>	Selects the movie file format. (AVCHD 60i/60p/AVCHD 50i/50p/MP4)
<b>Record Setting</b>	Selects the size of the recorded movie frame. (60i 24M(FX)/50i 24M(FX)/60i 17M(FH)/50i 17M(FH)/60p 28M(PS)/50p 28M(PS)/24p 24M(FX)/25p 24M(FX)/24p 17M(FH)/25p 17M(FH)/1440×1080 12M/VGA 3M)
<b>Audio Recording</b>	Sets whether or not to record audio when shooting a movie. (On/Off)
<b>Wind Noise Reduct.</b>	Reduces wind noise during movie recording. (On/Off)
<b>SteadyShot</b>	Sets SteadyShot. (On/Off)

## Custom menu

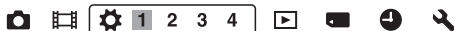





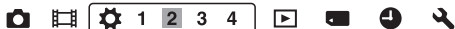













<b>Eye-Start AF</b>	Sets whether or not to use auto focus when you look through the viewfinder. (On/Off)
<b>FINDER/LCD Setting</b>	Sets the method for switching between the viewfinder and LCD monitor. (Auto/Manual)
<b>Red Eye Reduction</b>	Reduces the red-eye phenomenon during flash use. (On/Off)

<b>Release w/o Lens</b>	Sets whether shutter can open when lens is not attached. (Enable/Disable)
<b>Auto+ Cont. Shooting</b>	Sets whether or not to shoot continuously in AUTO+ mode. (Auto/Off)
<b>Auto+ Image Extract.</b>	Sets whether or not to save all the images that were shot continuously in AUTO+ mode. (Auto/Off)



<b>Grid Line</b>	Sets a grid line display to enable alignment to a structural outline. (Rule of 3rds Grid/Square Grid/Diag. + Square Grid/Off)
<b>Auto Review</b>	Displays the captured image after shooting. Sets auto review. (10 Sec/5 Sec/2 Sec/Off)
<b>DISP Button(Monitor)</b>	Allows you to select the available screen display modes of the LCD monitor that can be selected by pressing DISP on the control button. (Graphic Display/Display All Info./No Disp. Info./Level/Histogram/For viewfinder)
<b>DISP Button(Finder)</b>	Allows you to select the available screen display modes of the viewfinder that can be selected by pressing DISP on the control button. (Graphic Display/Display All Info./No Disp. Info./Level/Histogram)
<b>Peaking Level</b>	Enhances the outline of in-focus ranges with a specific color. (High/Mid/Low/Off)
<b>Peaking Color</b>	Sets the color used for the peaking function. (Red/Yellow/White)
<b>Live View Display</b>	Sets whether or not to display the effect of a function on the screen, such as the effect of the exposure compensation value. (Setting Effect ON/Setting Effect OFF)

   <span style="border: 1px solid black; padding: 2px;">1 2 3 4</span>    	
<b>Func. of AEL button</b>	Assigns the desired function to the AEL button. (Exposure Comp./Drive Mode/Flash Mode/Autofocus Mode/AF area/Face Detection/Smile Shutter/ISO/Metering Mode/Flash Comp./White Balance/DRO/Auto HDR/Creative Style/Picture Effect/Image Size/Quality/AEL hold/AEL toggle/  AEL hold/  AEL toggle/Object Tracking/AF lock/Aperture Preview/Shot. Result Preview/Smart Telecon./Focus Magnifier)
<b>ISO Button</b>	Assigns the desired function to the ISO button. (Exposure Comp./Drive Mode/Flash Mode/Autofocus Mode/AF area/Face Detection/Smile Shutter/ISO/Metering Mode/Flash Comp./White Balance/DRO/Auto HDR/Creative Style/Picture Effect/Image Size/Quality/AEL hold/AEL toggle/  AEL hold/  AEL toggle/Object Tracking/AF lock/Aperture Preview/Shot. Result Preview/Smart Telecon./Focus Magnifier)
<b>Preview Button</b>	Selects the method to be used for the operating preview button. (Shot. Result Preview/Aperture Preview)
<b>Focus Hold Button</b>	Sets the function of the focus hold button of the lens. (Focus Hold/D.O.F.Preview)
<b>Smart Telecon. Button</b>	Selects the operation method for the  button. (Smart Telecon./Focus Magnifier)

   <span style="border: 1px solid black; padding: 2px;">1 2 3 4</span>    	
<b>Lens Comp.: Shading</b>	Compensates for the shaded corners of the screen caused by the lens attached. (Auto/Off)
<b>Lens Comp.: Chro. Aber.</b>	Reduces the color deviation at the corners of the screen caused by the lens attached. (Auto/Off)
<b>Lens Comp.: Distortion</b>	Compensates for distortion on the screen caused by the lens attached. (Auto/Off)

<b>Front Curtain Shutter</b>	Sets whether or not to use the electronic front curtain shutter function. (On/Off)
<b>Face Registration</b>	Registers or changes the person to be given priority in the focus. (New Registration/Order Exchanging/Delete/Delete All)

## Playback menu



<b>Delete</b>	Deletes images. (Multiple Img./All in Folder/All AVCHD view files)
<b>View Mode</b>	Allows you to determine how to group the playback images. (Folder View(Still)/Folder View(MP4)/AVCHD View)
<b>Slide Show</b>	Shows a slide show. (Repeat/Interval/Image Type)
<b>Image Index</b>	Displays the image list. (4 Images/9 Images)
<b>3D Viewing</b>	Plays back 3D-images using a 3D-compatible TV connected to the camera.
<b>Protect</b>	Protects or cancels protection for an image. (Multiple Img./Cancel All Images/Cancel All Movies(MP4)/Cancel All AVCHD view files)
<b>Specify Printing</b>	Specifies or unspecifies the images for DPOF. (DPOF Setup/Date Imprint)

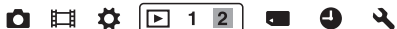

<b>Volume Settings</b>	Sets the volume for movie playback.
<b>Playback Display</b>	Sets how to play back an image recorded in portrait. (Auto Rotate/Manual Rotate)

## Memory Card Tool menu



<b>Format</b>	Formats the memory card.
<b>File Number</b>	Sets the method used to assign file numbers to still images and movies. (Series/Reset)

<b>Folder Name</b>	Sets the folder format for still images. (Standard Form/Date Form)
<b>Select REC Folder</b>	Changes the selected folder for storing still images.
<b>New Folder</b>	Creates a new folder for storing still images and movies.
<b>Recover Image DB</b>	Recovers the image database file and enables recording and playback.
<b>Display Card Space</b>	Displays the remaining recording time of movies and the recordable number of still images on the memory card.

### Clock setup menu



<b>Date/Time Setup</b>	Sets date and time, and daylight savings.
<b>Area Setting</b>	Sets the location of use.

### Setup menu



<b>Menu start</b>	Sets the default position of the cursor on the menu to the top item or the last-selected item. (Top/Previous)
<b>LCD Brightness</b>	Sets the brightness of the LCD monitor. (Auto/Manual)
<b>Viewfinder Bright.</b>	Sets the brightness of the viewfinder. (Auto/Manual)
<b>GPS Settings (SLT-A65V only)</b>	Sets the GPS functions.
<b>Power Save</b>	Sets the interval after which power save mode engages. (30 Min/5 Min/1 Min/20 Sec/10 Sec)
<b>HDMI Resolution</b>	Sets the resolution when the camera is connected to an HDMI TV. (Auto/1080p/1080i)
<b>CTRL FOR HDMI</b>	Operates the camera from a TV that support "BRAVIA" Sync. (On/Off)



<b>Upload Settings*</b>	Sets the upload function of the camera when using an Eye-Fi card. (On/Off)
<b>USB Connection</b>	Sets the USB connection method. (Auto/Mass Storage/MTP)
<b>Audio signals</b>	Sets whether or not to use the beep sound when the focus is achieved or the self-timer is working. (On/Off)
<b>Cleaning Mode</b>	Starts the cleaning mode to clean the image sensor.

\* Appears when an Eye-Fi card (sold separately) is inserted in the camera.



<b>Version</b>	Displays the camera software version.
<b>Language</b>	Selects the language.
<b>Mode Dial Guide</b>	Turns on or off the mode dial guide (the explanation of each shooting mode). (On/Off)
<b>Demo Mode</b>	Sets the demonstration playback of a movie to on or off. (On/Off)
<b>Initialize</b>	Restores the settings to their defaults. (Reset Default/Rec mode reset/Custom reset)

# Using the guide function of the camera

## In-Camera Guide

When you press the ? (In-Camera Guide) button on the Fn screen or menu screen, a guide in accordance with the currently selected function or setting appears automatically.

Select unavailable functions or settings on the Fn screen, then press the center of the control button, the appropriate setup is indicated in order to enable them.

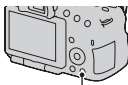

? (In-Camera Guide) button

## Shooting Tip

The camera displays the shooting tips in accordance with the shooting mode selected.

### 1 Press the ? (In-Camera Guide) button when the recording information display is displayed.

A shooting tip list in accordance with the current subject appears automatically.

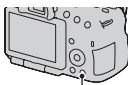

? (In-Camera Guide) button

### 2 Select the desired shooting tip with ▲/▼ on the control button, then press the center of the control button.

The shooting tip is displayed.

- You can scroll the screen with ▲/▼.
- You can select the item with ◀/▶.

### To access all shooting tips

You can search through all the shooting tips from the menu.

Use this item when you want to read shooting tips you have seen before.

**MENU button** →  **2** → **[Shooting Tip List]** → **Select the desired shooting tip**

- You can access a tip from the [Table of contents].



# Using with your computer

Following applications are contained on the CD-ROM (supplied) to allow more versatile use of images shot with your camera.

- “Image Data Converter”
- “PMB” (Picture Motion Browser)

If “PMB” has already been installed on the computer, and the version number of the previously installed “PMB” is lower than that of the “PMB” on the CD-ROM (supplied), install “PMB” also from the CD-ROM (supplied).

For detailed notes on installation, also see page 67.

## Note

- “PMB” is not compatible with Macintosh computers.

## Recommended computer environment (Windows)

The following computer environment is recommended when using the supplied software and importing images via a USB connection.

<b>OS (pre-installed)</b>	Microsoft Windows XP* SP3/Windows Vista** SP2/ Windows 7 SP1
<b>“PMB”</b>	<b>CPU:</b> Intel Pentium III 800 MHz or faster (For playing/editing the High Definition movies: Intel Core Duo 1.66 GHz or faster/Intel Core 2 Duo 1.66 GHz or faster, Intel Core 2 Duo 2.26 GHz or faster (HD FX/HD FH), Intel Core 2 Duo 2.40 GHz or faster (HD PS)) <b>Memory:</b> 512 MB or more (For playing/editing the High Definition movies: 1 GB or more) <b>Hard Disk:</b> Disk space required for installation-approximately 500 MB <b>Display:</b> Screen resolution-1024 × 768 dots or more
<b>“Image Data Converter Ver.4”</b>	<b>CPU/Memory:</b> Pentium 4 or faster/1 GB or more <b>Display:</b> 1024 × 768 dots or more

\* 64-bit editions and Starter (Edition) are not supported. Windows Image Mastering API (IMAPI) Ver.2.0 or later is required to use the function for creating discs.

\*\* Starter (Edition) is not supported.

## Recommended computer environment (Macintosh)

The following computer environment is recommended when using the supplied software and importing images via a USB connection.

<b>OS (pre-installed)</b>	<b>USB Connection:</b> Mac OS X (v10.3, 10.4, 10.5, 10.6) <b>“Image Data Converter Ver.4”:</b> Mac OS X (v10.5, 10.6 (Snow Leopard))
<b>“Image Data Converter Ver.4”</b>	<b>CPU:</b> Intel Core Solo/Core Duo/Core 2 Duo or faster <b>Memory:</b> 1 GB or more is recommended. <b>Display:</b> 1024 × 768 dots or more

### Notes

- Operation is not assured in an environment based on an upgrade of the operating systems described above or in a multi-boot environment.
- If you connect 2 or more USB devices to a single computer at the same time, some devices, including the camera, may not operate, depending on the types of USB devices you are using.
- Connecting the camera using a USB interface that is compatible with Hi-Speed USB (USB 2.0 compliant) allows advanced transfer (high speed transfer), as the camera is compatible with Hi-Speed USB (USB 2.0 compliant).
- When your computer resumes activity from suspend or sleep mode, communication between the camera and your computer may not recover at the same time.

# Using the software

## Installing the software (Windows)

Log on as Administrator.

### 1 Turn on your computer, and insert the CD-ROM (supplied) into the CD-ROM drive.

The installation menu screen appears.

- If it does not appear, double-click [Computer] (For Windows XP: [My Computer]) →  (SONYPMB) → [Install.exe].
- If the AutoPlay screen appears, select “Run Install.exe” and follow the instructions that appear on the screen to proceed with the installation.

### 2 Click [Install].

Make sure that both “Image Data Converter” and “PMB” are checked and follow the instructions on the screen.

- Connect the camera to the computer during the procedure following the instructions on the screen.
- When the restarting confirmation message appears, restart the computer following the instructions on the screen.
- DirectX may be installed depending on the system environment of your computer.

### 3 Remove the CD-ROM after the installation is complete.

The following software is installed and shortcut icons appear on the desktop.

“Image Data Converter”  
“PMB”  
“PMB Launcher”  
“PMB Help”

#### Notes

- If “PMB” has already been installed on the computer, and the version of the previously installed “PMB” is higher than that of the “PMB” on the CD-ROM (supplied), installation is not required. The usable functions are activated when the camera is connected to the computer using the USB cable.

- If a version of “PMB” under 5.0.00 has been installed on your computer, you may be unable to use some functions of those “PMB” when installing the “PMB” from the supplied CD-ROM. Also, “PMB Launcher” is installed from the supplied CD-ROM and you can start “PMB” or other software by using the “PMB Launcher.” Double-click the “PMB Launcher” short-cut icon on the computer screen to start “PMB Launcher.”

## Installing the software (Macintosh)

Log on as Administrator.

**1 Turn on your Macintosh computer, and insert the CD-ROM (supplied) into the CD-ROM drive.**

**2 Double-click the CD-ROM icon.**

**3 Copy the [IDC\_INST.pkg] file in the [MAC] folder to the hard disk icon.**

**4 Double-click the [IDC\_INST.pkg] file in the copy-to folder.**

Follow the instructions on the screen to complete the installation.

## Using “Image Data Converter”

With “Image Data Converter” you can do the following, etc.:

- To edit images recorded in RAW format with various corrections, such as tone curve, and sharpness.
- To adjust images with white balance, exposure, and creative style, etc.
- To save the images displayed and edited on a computer.
- You can either save the image as RAW format or save it in the general file format.
- To display and compare RAW/JPEG images recorded with this camera.
- To rate the images on a scale of five.
- To set color labels.

To use “Image Data Converter,” refer to Help.

Click [Start] → [All Programs] → [Image Data Converter] → [Help] → [Image Data Converter Ver.4].

## Using “PMB”

With “PMB” you can do the following, etc.:

- To set images shot with the camera and display them on the computer.
- To organize images on the computer on a calendar by shooting date to view them.
- To retouch (red-eye reduction, etc.), print, send still images as e-mail attachments, and change the shooting date.
- To display the shooting location of the image on the map (SLT-A65V only).
- To print or save still images with the date.
- To create Blu-ray discs or DVD discs from AVCHD View movies imported to a computer. (An Internet connection environment is required when a Blu-ray disc/DVD disc is created for the first time.)

### Notes

- “PMB” is not compatible with Macintosh computers.
- Movies recorded with the [60p 28M(PS)]/[50p 28M(PS)], [60i 24M(FX)]/[50i 24M(FX)] or [24p 24M(FX)]/[25p 24M(FX)] setting in [Record Setting] are converted by “PMB” in order to create an AVCHD disc. This conversion can take a long time. Also, you cannot create a disc with the original image quality. If you want to keep the original image quality, you must store your movies on a Blu-ray disc.
- “AVCHD View movies” are movies that were recorded in the [AVCHD 60i/60p]/[AVCHD 50i/50p] mode of [File Format].

To use “PMB,” refer to “PMB Help.”

Double-click the shortcut of  (PMB Help) on the desktop. Or, click [Start] → [All Programs] → [PMB] → [PMB Help].

“PMB” support page (English only)



<http://www.sony.co.jp/pmb-se/>

# Selecting the method for creating a disc of movies

You can create a disc from AVCHD View movies that have been recorded with this camera.

Depending on the disc type, playable devices may vary. Select the method that suits your disc player.

Here, 2 ways of creating a disc of movies are described; creating a disc with a computer using “PMB” or creating a disc with devices other than a computer such as a DVD writer.

Player	Disc type	Feature
<b>Blu-ray disc playback devices</b> (Blu-ray disc player, PlayStation®3, etc.)	 Blu-ray	Using a Blu-ray disc enables you to record high-definition image quality (HD) movies of a longer duration than DVD discs.
<b>AVCHD format playback devices</b> (Sony Blu-ray disc player, PlayStation®3, etc.)	 AVCHD	High-definition image quality (HD) movies can be recorded on DVD media, such as DVD-R discs, and a high-definition image quality (HD) disc is created. <ul style="list-style-type: none"><li>• You cannot play a high-definition image quality (HD) disc on ordinary DVD players.</li></ul>
<b>Ordinary DVD playback devices</b> (DVD player, computer that can play DVDs, etc.)	 STD	Standard definition image quality (STD) movies converted from high-definition image quality (HD) movies can be recorded on DVD media, such as DVD-R discs, and a standard definition image quality (STD) disc is created.

## Creating a disc using a computer

You can import AVCHD View movies to a computer using “PMB” and create an AVCHD format disc or a standard definition image quality (STD) disc.

For details on the method for creating a disc using “PMB,” see “PMB Help.”









### Notes

- To create Blu-ray discs, be sure to install [BD Add-on Software] from the “PMB” installation screen.

- The PlayStation®3 may not be available in some countries/regions.
- Movies recorded with the [60p 28M(PS)]/[50p 28M(PS)], [60i 24M(FX)]/[50i 24M(FX)] or [24p 24M(FX)]/[25p 24M(FX)] setting in [Record Setting] are converted by “PMB” in order to create an AVCHD disc. This conversion can take a long time. Also, you cannot create a disc with the original image quality. If you want to keep the original image quality, you must store your movies on a Blu-ray disc.
- To play back movies recorded with the [60p 28M(PS)]/[50p 28M(PS)] setting on a Blu-ray disc, the device that is compatible with the AVCHD Ver 2.0 format is required.
- “AVCHD View movies” are movies that were recorded in the [AVCHD 60i/60p]/[AVCHD 50i/50p] mode of [File Format].

## Creating a disc with a device other than a computer

You can create a disc with a Blu-ray disc recorder and DVD writer. The disc type you can create depends on the device used.

Device		Disc type
	Blu-ray disc recorder: To create a Blu-ray disc or DVD with standard image quality (STD)	 
	DVD writer other than DVD Direct Express: To create an AVCHD disc or DVD with standard image quality (STD)	 
	HDD recorder, etc.: To create a DVD with standard image quality (STD)	

### Notes

- For details on how to create a disc, refer to the operating instructions of the device you use.
- If you create a disc using Sony DVD Direct (DVD Writer), use the memory card slot of the DVD Writer or connect the DVD Writer via USB connection to transfer the data.
- If you use Sony DVD Direct (DVD Writer), check that the firmware is updated to the newest version.

For details, see the following URL:

<http://sony.storagesupport.com/>

- To copy movies recorded with the [60p 28M(PS)]/[50p 28M(PS)] setting to a Blu-ray disc, the device that is compatible with the AVCHD Ver 2.0 format is required. To play back the created Blu-ray disc, the device that is compatible with the AVCHD Ver 2.0 format is required.



# List of icons on the screen

## Graphic Display (LCD monitor)

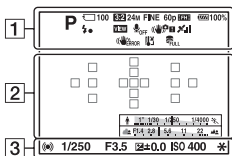

## Display All Info. (LCD monitor)

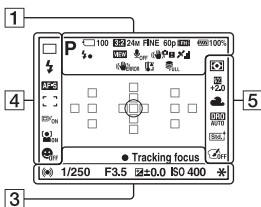

## For playback (Basic information display)

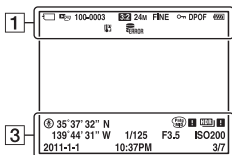

1

Display	Indication
AUTO+ P AS M 	Exposure mode (36)
	Scene Recognition icons (37)
	Memory card (21)/ Upload (61)
100	Remaining number of recordable images
3:2 16:9	Aspect ratio of still images (56)
3D	3D Sweep Panorama (39)
24M 12M 6.0M 20M 10M 5.1M WIDE STD 16:9	Image size of still images (47)
RAW RAW+J FINE STD	Image quality of still images (56)
60p 60i 24p 50p 50i 25p	Frame rate of movies (57)

Display	Indication
	Image size of movies (57)
	Remaining battery (22)
	Flash charge in progress (41)
	Setting Effect OFF (57)
	No audio recording of movies (57)
	SteadyShot/Camera shake warning (57)
	GPS triangulating status (61) (SLT-A65V only)
	SteadyShot error
	Overheating warning (10)
	Database file full/ Database file error
	View Mode (60)
<b>100-0003</b>	Folder - file number
	Protect (60)
<b>DPOF</b>	DPOF set (60)
	Remaining battery warning (22)

2

Display	Indication
	Spot metering area (54)
	AF area (54)
	Smart teleconverter (52)
	Shutter speed indicator (46)

Display	Indication
	Aperture indicator (46)

3

Display	Indication
<b>REC 0:12</b>	Recording time of the movie (m:s)
	Focus (31)
<b>1/250</b>	Shutter speed (36)
<b>F3.5</b>	Aperture (36)
	EV scale (43) (Only for viewfinder)
	Exposure compensation (43)
	AE lock (52)
	GPS information (SLT-A65V only)
<b>35° 37' 32" N</b> <b>139° 44' 31" W</b>	Latitude and longitude display (SLT-A65V only)
	Auto HDR image warning
	Picture Effect error
<b>ISO400</b>	ISO sensitivity (52)
<b>3/7</b>	File number/Number of images in the view mode
<b>2011-1-1 10:37AM</b>	Date of recording

4

Display	Indication
	Drive mode (45)

Display	Indication
	Flash mode (41)/Red-eye reduction (57)
	Focus mode (54)
	AF area (54)
	Object tracking (54)
	Face Detection (54)
	Smile Shutter (54)
	Smile Detection Sensitivity indicator

## 5

Display	Indication
	Metering mode (54)
	Flash compensation (54)
	White balance (Auto, Preset, Custom, Color temperature, Color filter) (52)
	D-Range Optimizer (54)/Auto HDR (54)
	Creative Style (54)/Contrast, Saturation, Sharpness













Display	Indication
	Picture Effect (52)

# Functions available for each shooting mode

The functions you can use depend on the selected shooting mode.

In the table below, ✓ indicates the function available. – indicates the function not available.

The functions you cannot use are displayed in gray on the screen.

Shoot Mode		Exposure Comp. (43)	Self-timer (45)	Cont. Shooting (45)	Face Detection (54)	Smile Shutter (54)
<b>AUTO</b> (30)		–	✓	✓	✓	✓
 (30)		–	✓	✓	✓	✓
<b>AUTO+</b> (37)		–	✓	✓	✓	✓
<b>SCN</b> (38)		–	✓	–	✓	✓
		–	✓	✓	✓	✓
		–	✓	–	✓	✓
		–	✓	–	✓	✓
		–	✓	–	✓	✓
		–	✓	–	✓	✓
		–	–	–	✓	–
		–	✓	–	✓	✓
 (39)		✓	–	–	–	–
 (39)		✓	–	–	–	–
 (40)		✓	–	–	–	–
<b>P</b> (36)		✓	✓	✓	✓	✓
<b>A</b> (36)		✓	✓	✓	✓	✓
<b>S</b> (36)		✓	✓	✓	✓	✓
<b>M</b> (36)		–	✓	✓	✓	✓
 (32)		✓*	✓	✓	✓	–

















\* When [Manual Exposure] is selected, this function is not available.

# Flash modes available

The flash modes you can select depend on the shooting mode and functions selected.

In the table below, ✓ indicates the function selectable. – indicates the function not selectable.

The flash modes you cannot select are displayed in gray on the screen.

Shoot Mode	 (Flash Off)	 (Autoflash)	 (Fill-flash)	 (Slow Sync.)	 (Rear Sync.)	 (Wireless)
<b>AUTO (30)</b>	✓	✓	✓	–	–	–
 (30)	✓	–	–	–	–	–
<b>AUTO+ (37)</b>	✓	✓	✓	–	–	–
<b>SCN (38)</b>		✓	✓	✓	–	–
		✓	–	✓	–	–
		✓	✓	✓	–	–
		✓	–	✓	–	–
		✓	–	✓	–	–
		✓	–	–	–	–
		✓	–	–	–	–
		–	✓	–	✓	–
 (39)	✓	–	–	–	–	–
<b>3D (39)</b>	✓	–	–	–	–	–
 (40)	–	–	✓	✓	✓	✓
<b>P (36)</b>	–	–	✓	✓	✓	✓
<b>A (36)</b>	–	–	✓	✓	✓	✓
<b>S (36)</b>	–	–	✓	✓	✓	✓
<b>M (36)</b>	–	–	✓	✓	✓	✓
 (32)	✓	–	–	–	–	–

# Learning more about the camera

## ( $\alpha$ Handbook)

“ $\alpha$  Handbook,” which explains how to use the camera in detail, is included on the CD-ROM (supplied). Refer to it for in-depth instructions on the many functions of the camera.

### For Windows users

- 1 Turn on your computer, and insert the CD-ROM (supplied) into the CD-ROM drive.**
- 2 Click [Handbook].**
- 3 Click [Install].**
- 4 Start “ $\alpha$  Handbook” from the shortcut on the desktop.**

### For Macintosh users

- 1 Turn on your computer, and insert the CD-ROM (supplied) into the CD-ROM drive.**
- 2 Select the [Handbook] folder and copy “Handbook.pdf” stored in the [GB] folder to your computer.**
- 3 After copying is complete, double-click “Handbook.pdf.”**

# Checking the number of recordable images/recording time

Once you insert a memory card into the camera and set the power switch to ON, the number of images that can be recorded (should you continue to shoot using the current settings) is displayed on the screen.

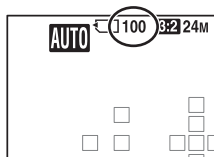

## Notes

- When “0” (the number of recordable images) flashes in yellow, the memory card is full. Replace the memory card with another one, or delete images in the current memory card (pages 34, 60).
- When “NO CARD” (the number of recordable images) flashes in yellow, it means no memory card has been inserted. Insert a memory card.

## The number of images that can be recorded on a memory card

The table shows the approximate number of images that can be recorded on a memory card formatted with this camera. The values are defined using Sony standard memory cards for testing. The values may vary depending on the shooting conditions and the type of memory card used.

**Image Size: L 24M**

**Aspect Ratio: 3:2\***

**“Memory Stick PRO Duo”**

**(Units: Images)**

Capacity \ Size	2GB	4GB	8GB	16GB	32GB
Standard	335	680	1350	2750	5500
Fine	205	410	830	1650	3300
RAW & JPEG	54	105	220	440	880
RAW	74	145	300	600	1200

\* When [Aspect Ratio] is set to [16:9], you can record more images than the numbers shown in the table above (except when [RAW] is selected).

## The number of images that can be recorded using a battery pack

The approximate number of images that can be recorded is as follows when you use the camera with the battery pack (supplied) at full capacity.

Note that the actual numbers may be less than those indicated depending on the conditions of use.

	SLT-A65	SLT-A65V
<b>LCD monitor mode</b>	Approx. 560 images	Approx. 560 images
<b>Viewfinder mode</b>	Approx. 510 images	Approx. 510 images

- The number is calculated with a battery pack at full capacity and in the following situation:
  - At an ambient temperature of 25°C (77°F).
  - Using the battery pack that is charged for an hour after the CHARGE lamp goes out.
  - Using Sony “Memory Stick PRO Duo” media (sold separately).
  - [Quality] is set to [Fine].
  - [Autofocus Mode] is set to [Automatic AF].
  - Shooting once every 30 seconds.
  - The flash strobes once every 2 times.
  - The power turns on and off once every 10 times.
  - [GPS On/Off] is set to [On] (SLT-A65V only).
- The measurement method is based on the CIPA standard.  
(CIPA: Camera & Imaging Products Association)

## Available recording time for a movie

The table below shows the approximate total recording times using a memory card formatted with this camera.



## “Memory Stick PRO Duo”

(h (hour), m (minute))

Record Setting \ Capacity	2GB	4GB	8GB	16GB	32GB
60i 24M(FX)/50i 24M(FX)	10 m	20 m	40 m	1 h 30 m	3 h
60i 17M(FH)/50i 17M(FH)	10 m	30 m	1 h	2 h	4 h 5 m
60p 28M(PS)/50p 28M(PS)	9 m	15 m	35 m	1 h 15 m	2 h 30 m
24p 24M(FX)/25p 24M(FX)	10 m	20 m	40 m	1 h 30 m	3 h
24p 17M(FH)/25p 17M(FH)	10 m	30 m	1 h	2 h	4 h 5 m
1440×1080 12M	20 m	40 m	1 h 20 m	2 h 45 m	5 h 30 m
VGA 3M	1 h 10 m	2 h 25 m	4 h 55 m	10 h	20 h 5 m

**Notes**

- The recordable time of movies varies for the reason that the camera equipped with VBR (Variable Bit Rate) which automatically adjusts image quality depending on shooting scene. When you record fast-moving subject, the image is clearer but the recordable time is shorter because it spends much memory to record. The recordable time also vary depending on the shooting condition or subject or setting of image quality/size.
- The values shown are not the continuous recording time.
- Recording time may depend on shooting conditions and the memory card used.
- When [L] is indicated, stop recording the movie. The temperature inside the camera has increased to an unacceptable level.
- For details on movie playback, see page 33.

**Notes on continuous movie recording**

- It requires a lot of power to perform high quality movie recording or continuous shooting using the APS-C size image sensor. Therefore, if you continue to shoot, the temperature inside the camera will rise, especially that of the image sensor. In such cases, the camera is turned off automatically since higher temperatures affect the quality of the images or burden the internal mechanism of the camera.
- The duration of time available for movie recording is as follows when the camera starts recording after the power of the camera has been turned off for a while. (The

following values indicate the continuous time from when the camera starts recording until the camera stops recording.)

Ambient temperature	Continuous recording time for movies
20°C (68°F)	About 29 minutes
30°C (86°F)	About 29 minutes
40°C (104°F)	About 13 minutes

- The duration of time available for movie recording varies with the temperature or condition of the camera before you start recording. If you frequently recompose or shoot images after the power is turned on, the temperature inside the camera rises and the recording time available is shorter than the values indicated in the table above.
- If the camera stops recording due to the temperature, leave it for several minutes with the power turned off. Start recording after the temperature inside the camera drops fully.
- If you observe the following points, the recording time is longer.
  - Keep the camera out of direct sunlight.
  - Turn the camera off when it is not being used.
  - If possible, use a tripod and disable the SteadyShot function.
- The maximum size of a movie file is about 2 GB. When the file size is about 2 GB, the recording stops automatically when [File Format] is set to [MP4], and a new movie file is created automatically when [File Format] is set to [AVCHD 60i/60p]/[AVCHD 50i/50p].
- The maximum continuous recording time is 29 minutes.

# Specifications

## Camera

### [System]

Camera Type	Interchangeable Lens Digital Camera
Lens	A-mount lens

### [Image sensor]

Image format	23.5 mm×15.6 mm (APS-C format) CMOS image sensor
Total pixel number of image sensor	Approx. 24 700 000 pixels
Effective pixel number of camera	Approx. 24 300 000 pixels

### [SteadyShot]

For still images	System: Image sensor-shift mechanism Effect: Approx. 2.5 EV to 4.5 EV in shutter speed (depending on shooting conditions and the attached lens)
For movies	System: Electronic

### [Anti-Dust]

System	Charge protection coating on Low-Pass Filter and image sensor-shift mechanism
--------	---

### [Auto focus system]

System	TTL phase-detection system, 15 points (3 points cross type)
Sensitivity Range	-1 EV to 18 EV (at ISO 100 equivalent)
AF illuminator	Approx. 1 m to 5 m (3.3 feet to 16.4 feet)

### [Electronic viewfinder]

Type	Electronic viewfinder (Organic Electro-Luminescence)
Screen size	1.3 cm (0.5 type)
Total number of dots	2 359 296 dots
Frame coverage	100%
Magnification	1.09 × with 50 mm lens at infinity, -1 m <sup>-1</sup> (diopter)

Eye Point	Approximately 27 mm from the eyepiece, 22 mm from the eyepiece frame at $-1 \text{ m}^{-1}$
Diopter Adjustment	$-4.0 \text{ m}^{-1}$ to $+3.0 \text{ m}^{-1}$ (diopter)

**[LCD monitor]**

LCD panel	7.5 cm (3.0 type) TFT drive
Total number of dots	921 600 (640 × 3 (RGB) × 480) dots

**[Exposure control]**

Metering Cell	“Exmor” CMOS sensor
Metering method	1 200-zone evaluative metering
Metering Range	$-2 \text{ EV}$ to $+17 \text{ EV}$ on Multi segment, Center weighted, Spot modes (at ISO 100 equivalent with F1.4 lens)
ISO sensitivity (Recommended exposure index)	Still images: AUTO, ISO 100 to 16 000 (1 EV step) Movies: AUTO, ISO 100 to 1 600 (1 EV step)
Exposure compensation	$\pm 3.0 \text{ EV}$ (1/3 EV step)

**[Shutter]**

Type	Electronically-controlled, vertical-traverse, focal-plane type
Speed range	Still images: 1/4 000 second to 30 seconds, bulb Movies: 1/4 000 second to 1/4 second (1/3 step), up to 1/60 in AUTO mode
Flash sync speed	1/160 second

**[Built-In-Flash]**



Flash G.No.	GN 10 (in meters at ISO 100)
Recycling time	Approx. 3 seconds
Flash coverage	Covering 18 mm lens (focal length that the lens indicates)
Flash compensation	$\pm 2.0 \text{ EV}$ (1/3 EV step)

## Flash range

Aperture		F2.8	F4.0	F5.6
ISO setting	100	1 m – 3.6 m (3.3 feet – 12 feet)	1 m – 2.5 m (3.3 feet – 8.2 feet)	1 m – 1.8 m (3.3 feet – 5.9 feet)
	200	1.4 m – 5 m (4.6 feet – 16 feet)	1.4 m – 3.6 m (4.6 feet – 12 feet)	1.4 m – 2.5 m (4.6 feet – 8.2 feet)
	400	2 m – 7.1 m (6.6 feet – 23 feet)	2 m – 5 m (6.6 feet – 16 feet)	2 m – 3.6 m (6.6 feet – 12 feet)
	800	2.8 m – 10 m (9.2 feet – 33 feet)	2.8 m – 7.1 m (9.2 feet – 23 feet)	2.8 m – 5 m (9.2 feet – 16 feet)

**[Continuous shooting]**

Continuous shooting speed

Continuous Advance Priority AE: Maximum 10 images per second/ Hi: Maximum 8 images per second/ Lo: Maximum 3 images per second

- Our measurement conditions. The speed of continuous shooting is slower, depending on shooting conditions.

The maximum number of continuous shots

In Continuous Advance Priority AE mode

Fine: 17 images/Standard: 18 images/RAW & JPEG:  
11 images/RAW: 13 images

In Continuous shooting

Fine: 18 images/Standard: 18 images/RAW & JPEG:  
11 images/RAW: 13 images

**[Image zooming playback]**

Scaling range

Image size: L: Approx.  $\times 1.0$  –  $\times 13.6$ /M: Approx.  $\times 1.0$  –  $\times 9.9$ /S: Approx.  $\times 1.0$  –  $\times 6.8$

**[Recording format]**

File format

JPEG (DCF Ver. 2.0, Exif Ver. 2.3, MPF Baseline) compliant, DPOF compatible

3D still images

MPO (MPF Extended (Disparity Image)) compliant

Movie (AVCHD format)

AVCHD format Ver. 2.0 compatible

Video: MPEG-4 AVC/H.264

Audio: Dolby Digital 2ch, equipped with Dolby Digital Stereo Creator

	<ul style="list-style-type: none"> <li>• Manufactured under license from Dolby Laboratories.</li> </ul>
Movie (MP4 format)	Video: MPEG-4 AVC/H.264 Audio: MPEG-4 AAC-LC 2ch

**[Recording media]**

“Memory Stick PRO Duo” media, SD card

**[Input/output terminals]**

USB	miniB, Hi-Speed USB (USB 2.0)
HDMI	HDMI minijack
Mic Terminal	∅ 3.5 mm Stereo minijack
REMOTE Terminal	

**[Power, general]**

Used battery pack	Rechargeable battery pack NP-FM500H
-------------------	-------------------------------------

**[Others]**

Microphone	Stereo
Speaker	Monaural
Exif Print	Compatible
PRINT Image Matching III	Compatible
Dimensions	Approx. 132.1 mm × 97.5 mm × 80.7 mm (5 1/4 inches × 3 7/8 inches × 3 1/4 inches) (W/H/D, excluding protrusions)
Mass	Approx. 622 g (1 lb 5.9 oz) (with battery and “Memory Stick PRO Duo” media) Approx. 543 g (1 lb 3.1 oz) (body only)
Operating temperature	0°C to 40°C (32°F to 104°F)

**On image data compatibility**

- This camera conforms with DCF (Design rule for Camera File system) universal standard established by JEITA (Japan Electronics and Information Technology Industries Association).
- Playback of images recorded with your camera on other equipment and playback of images recorded or edited with other equipment on your camera are not guaranteed.

Design and specifications are subject to change without notice.

## Battery charger/Battery

### BC-VM10A Battery charger

Input rating	100 V - 240 V AC, 50/60 Hz, 9 W
Output rating	8.4 V DC, 0.75 A
Operating temperature range	0°C to 40°C (32°F to 104°F)
Storage temperature range	-20°C to +60°C (-4°F to +140°F)
Maximum dimensions	Approx. 70 mm × 25 mm × 95 mm (2 7/8 inches × 1 inch × 3 3/4 inches) (W/H/D)
Mass	Approx. 90 g (3.2 oz)

### Rechargeable battery pack NP-FM500H

Used battery	Lithium-ion battery	
Maximum voltage	DC 8.4 V	
Nominal voltage	DC 7.2 V	
Maximum charge voltage	DC 8.4 V	
Maximum charge current	2.0 A	
Capacity	Typical	11.8 Wh (1 650 mAh)
	Minimum	11.5 Wh (1 600 mAh)
Maximum dimensions	Approx. 38.2 mm × 20.5 mm × 55.6 mm (1 9/16 inches × 13/16 inches × 2 1/4 inches) (W/H/D)	
Mass	Approx. 78 g (2.8 oz)	

## Lens

Name (Model name)	DT 18-55mm F3.5-5.6 SAM (SAL1855)	DT 55-200mm F4-5.6 SAM (SAL55200-2)	DT 18-135mm F3.5-5.6 SAM (SAL18135)
Equivalent 35mm-format focal length* (mm)	27-82.5	82.5-300	27-202.5
Lens groups-elements	7-8	9-13	11-14
Angle of view*	76°-29°	29°-8°	76°-12°
Minimum focus** (m (feet))	0.25 (0.82)	0.95 (3.2)	0.45 (1.48)

Name (Model name)	DT 18-55mm F3.5-5.6 SAM (SAL1855)	DT 55-200mm F4-5.6 SAM (SAL55200-2)	DT 18-135mm F3.5-5.6 SAM (SAL18135)
Maximum magnification (X)	0.34	0.29	0.25
Minimum f-stop	f/22-36	f/32-45	f/22-36
Filter diameter (mm)	55	55	62
Dimensions (maximum diameter × height) (approx., mm (in.))	69.5×69 (2 3/4 × 2 3/4)	71.5×85 (2 7/8 × 3 3/8)	76×86 (3 × 3 1/2)
Mass (approx., g (oz.))	210 (7 4/8)	305 (10 3/4)	398 (14)

\* The values for equivalent 35mm-format focal length and angle of view are based on Interchangeable Lens Digital Camera equipped with an APS-C sized image sensor.

\*\* Minimum focus is the shortest distance from the image sensor to the subject.

- This lens is equipped with a distance encoder. The distance encoder allows more accurate measurement (ADI) by using a flash for ADI.
- Depending on the lens mechanism, the focal length may change with any change of the shooting distance. The focal length assumes the lens is focused at infinity.
- The infinity position provides for some adjustment to compensate for focus shift caused by change in temperature. To shoot a subject at infinite distance in MF mode, use the viewfinder and set focus.



### On focal length

The picture angle of this camera is narrower than that of a 35 mm-format camera. You can find the approximate equivalent of the focal length of a 35 mm-format camera, and shoot with the same picture angle, by increasing the focal length of your lens by half.

For example, by using a 50 mm lens, you can get the approximate equivalent of a 75 mm lens of a 35 mm-format camera.



## Trademarks

- **α** is a trademark of Sony Corporation.
- “Memory Stick,” , “Memory Stick PRO,” **MEMORY STICK PRO**, “Memory Stick Duo,” **MEMORY STICK DUO**, “Memory Stick PRO Duo,” **MEMORY STICK PRO DUO**, “Memory Stick PRO-HG Duo,” **MEMORY STICK PRO-HG DUO**, “Memory Stick Micro,” “MagicGate,” and **MAGICGATE** are trademarks of Sony Corporation.
- “InfoLITHIUM” is a trademark of Sony Corporation.
- “PhotoTV HD” is a trademark of Sony Corporation.
- “AVCHD Progressive” and “AVCHD Progressive” logotype are trademarks of Panasonic Corporation and Sony Corporation.
- Blu-ray Disc <sup>TM</sup> and Blu-ray <sup>TM</sup> are trademarks of the Blu-ray Disc Association.
- Dolby and the double-D symbol are trademarks of Dolby Laboratories.
- Microsoft, Windows, DirectX, and Windows Vista are either registered trademarks or trademarks of Microsoft Corporation in the United States and/or other countries.
- HDMI, the HDMI logo and High-Definition Multimedia Interface are trademarks or registered trademarks of HDMI Licensing LLC.
- Macintosh and Mac OS are trademarks or registered trademarks of Apple Inc.
- PowerPC is a registered trademark of IBM Corporation in the United States.
- Intel, Intel Core, MMX, and Pentium are trademarks or registered trademarks of Intel Corporation.
- SDXC Logo is a trademark of SD-3C, LLC.
- Eye-Fi is a trademark of Eye-Fi Inc.
- MultiMediaCard is a trademark of MultiMediaCard Association.
- “” and “PlayStation” are registered trademarks of Sony Computer Entertainment Inc.
- Adobe is a registered trademark or a trademark of Adobe Systems Incorporated in the United States and/or other countries.
- In addition, system and product names used in this manual are, in general, trademarks or registered trademarks of their respective developers or manufacturers. However, the <sup>TM</sup> or ® marks are not used in all cases in this manual.



- Add further enjoyment with your PlayStation 3 by downloading the application for PlayStation 3 from PlayStation Store (where available.)
- The application for PlayStation 3 requires PlayStation Network account and application download.

Accessible in areas where the PlayStation Store is available.



# Index

## Numerics

3D ..... 39

## A

AEL button ..... 52

AF area ..... 54

AF Illuminator ..... 57

Aperture Priority ..... 36

Area Setting ..... 28

Aspect Ratio ..... 56

Audio signals ..... 62

Auto HDR ..... 55

Auto Review ..... 58

AUTO+ ..... 37

Autofocus Mode ..... 54

AVCHD ..... 57, 71

## B

Battery pack ..... 19, 21

Bracket ..... 45

## C

Cleaning Mode ..... 62

Continuous Advance Priority AE ..... 40

Continuous shooting ..... 45

Creative Style ..... 55

## D

Date Imprint ..... 60

Date/Time setup ..... 27

DC IN terminal ..... 16

Delete ..... 34, 60

Diopter-adjustment ..... 29

Disc creation ..... 71

DPOF Setup ..... 60

D-Range Optimizer ..... 55

Drive mode ..... 45

## E

Enlarged image ..... 49

Exposure compensation ..... 43

Eye-Fi ..... 62

Eye-Start AF ..... 57

## F

Face Detection ..... 54

Flash compensation ..... 54

Flash mode ..... 41, 77

Flash Off ..... 30, 41

Fn button ..... 52, 54

Focal length ..... 88

Focus Hold Button ..... 59

Focus Magnifier ..... 59

Folder Name ..... 61

Format ..... 60

## G

GPS ..... 61

## H

Hand-held Twilight ..... 38

Histogram ..... 58

## I

Image Data Converter ..... 68

Image Index ..... 50

Image quality ..... 56

Image size ..... 47

ISO sensitivity ..... 54

## J

JPEG ..... 56

- L**
- Landscape .....38
  - Language .....62
  - LCD Brightness .....61
  - LCD monitor .....73
  - Lens .....24
- M**
- Macro .....38
  - Manual Exposure .....37
  - Memory card .....21
  - Menu .....56
  - Metering Mode .....54
  - Movie Audio Recording .....57
  - Movie File Format .....57
- N**
- Night Portrait .....38
  - Night Scene .....38
  - Number of recordable images.....79, 80
- P**
- Playback Display .....60
  - PMB .....69
  - Portrait .....38
  - Power Save .....61
  - Program Auto .....36
  - Protect .....60
- R**
- RAW .....56
  - Recording movies .....32
  - Recover Image DB .....61
  - Red Eye Reduction .....57
  - Remote Commander .....16
  - Reset .....62
  - Rotate .....52
- S**
- Scene Selection ..... 38
  - Select REC Folder ..... 61
  - Self-timer ..... 45
  - Set the clock ..... 27
  - Shooting ..... 30
  - Shooting Tip ..... 63
  - Shutter Priority ..... 36
  - Slide Show ..... 60
  - Slow sync ..... 41
  - Smile Shutter ..... 54
  - Software ..... 67
  - Specifications ..... 83
  - Sports Action ..... 38
  - SteadyShot function ..... 57
  - Sunset ..... 38
  - Sweep Panorama ..... 39, 47
- U**
- USB Connection ..... 62
- V**
- Version ..... 62
  - Viewfinder ..... 57
  - Viewing image ..... 33
  - Viewing images on a TV screen ..... 51
- W**
- White balance ..... 54







Additional information on this product and answers to frequently asked questions can be found at our Customer Support Website.

<http://www.sony.net/>

Printed using VOC (Volatile Organic Compound)-free vegetable oil based ink.



4287953130