

Video Cassette Recorder

Operating Instructions



<i>SLV-SE840B</i>	Hi-Fi	SHOWVIEW [®]
<i>SLV-SE740B</i>	Hi-Fi	SHOWVIEW [®]
<i>SLV-SE640B</i>	Hi-Fi	
<i>SLV-SE240B</i>		

WARNING

To prevent fire or shock hazard, do not expose the unit to rain or moisture.

To avoid electrical shock, do not open the cabinet. Refer servicing to qualified personnel only.

To prevent fire or shock hazard, do not place objects filled with liquids, such as vases, on the apparatus.

Mains lead must only be changed at a qualified service shop.

Precautions

Safety

- This unit operates on 220 – 240 V AC, 50 Hz. Check that the unit's operating voltage is identical with your local power supply.
- If anything falls into the cabinet, unplug the unit and have it checked by qualified personnel before operating it any further.
- The unit is not disconnected from the mains as long as it is connected to the mains, even if the unit itself has been turned off.
- Unplug the unit from the wall outlet if you do not intend to use it for an extended period of time. To disconnect the cord, pull it out by the plug, never by the cord.

Installing

- Do not install this equipment in a confined space such as a book or similar unit.
- Allow adequate air circulation to prevent internal heat buildup.
- Do not place the unit on surfaces (rugs, blankets, etc.) or near materials (curtains, draperies) that may block the ventilation slots.
- Do not install the unit near heat sources such as radiators or air ducts, or in a place subject to direct sunlight, excessive dust, mechanical vibration or shock.
- Do not install the unit in an inclined position. It is designed to be operated in a horizontal position only.
- Keep the unit and cassettes away from equipment with strong magnets, such as microwave ovens or large loudspeakers.
- Do not place heavy objects on the unit.
- If the unit is brought directly from a cold to a warm location, moisture may condense inside the VCR and cause damage to the video head and tape. When you first install the unit, or when you move it from a cold to a warm location, wait for about three hours before operating the unit.

Caution

Television programmes, films, video tapes and other materials may be copyrighted. Unauthorized recording of such material may be contrary to the provisions of the copyright laws. Also, use of this recorder with cable television transmission may require authorization from the cable television transmitter and/or programme owner.

Compatible colour systems

- This VCR is designed to record using the PAL (B/G) and SECAM colour systems and play back using the PAL (B/G) and SECAM colour systems. Recording of video sources based on other colour systems cannot be guaranteed.
- Tapes recorded with the MESECAM colour system can be played back on this VCR using a TV or a colour monitor supporting the SECAM colour system.

SHOWVIEW is a registered trademark of Gemstar Development Corporation. The SHOWVIEW system is manufactured under license from Gemstar Development Corporation.

Table of contents

Getting Started

- 4 Index to parts and controls
- 11 Step 1 : Unpacking
- 12 Step 2 : Setting up the remote commander
- 16 Step 3 : Connecting the VCR
- 19 Step 4 : Setting up the VCR with the Auto Set Up function
- 21 Setting the clock
- 23 Downloading the TV tuner's preset data (not available on SLV-SE640B and SE240B)
- 24 Selecting a language
- 25 Presetting channels
- 28 Changing/disabling programme positions
- 33 Setting the Canal Plus decoder

Basic Operations

- 36 Playing a tape
- 39 Recording TV programmes
- 43 Recording TV programmes using the Dial Timer (SLV-SE840B only)
- 48 Recording TV programmes using the ShowView® system (not available on SLV-SE640B and SE240B)
- 52 Recording TV programmes using the timer

Additional Operations

- 55 Playing/searching at various speeds
- 57 Setting the recording duration time
- 58 Synchronized Recording (not available on SLV-SE640B and SE240B)
- 60 Checking/changing/cancelling timer settings
- 62 Recording stereo and bilingual programmes (not available on SLV-SE240B)
- 65 Searching using the index function (not available on SLV-SE240B)
- 67 Adjusting the picture
- 68 Reducing the VCR's power consumption
- 69 Changing menu options

Editing

- 71 Connecting to a VCR or stereo system
- 73 Basic editing
- 74 Audio dubbing (SLV-SE840B only)

Additional Information

- 75 Troubleshooting
- 79 Specifications
- 81 Index

Back Cover

Quick Start Guide

Index to parts and controls

Refer to the pages indicated in parentheses () for details.

Front panel

For SLV-SE840B

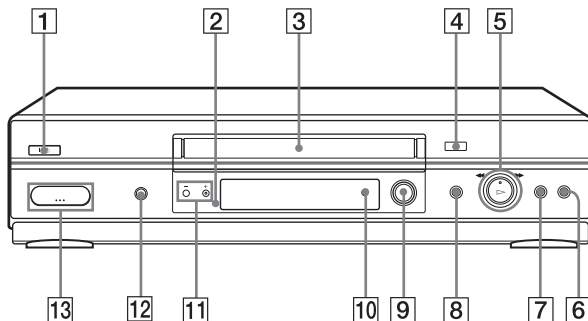

- 1** I/⏻ (on/standby) switch
- 2** Remote sensor (12)
- 3** Tape compartment
- 4** ⏏ (eject) button (36)
- 5** ▷ (play) button* (36) (55)/▶▶ (fast-forward)/◀◀ (rewind) (37) (56)/Playback Dial (37) (56)
- 6** ■ (stop) button (20) (36) (73) (74)
- 7** || (pause) button (36) (47) (73) (74)
- 8** ENR ● (record) button (40) (57) (73)
- 9** ⌚ PROG (Dial Timer) (43)
- 10** DOUBLAGE SON button (74)
- 11** CHAINE +/- buttons* (44) (56) (67)
- 12** ENR SYNCHRO (Synchronized Recording) button*² (59)
- 13** ↻ LIGNE-2 G (left) ↻ D (right) jacks (covered)* (71) (72) (74)

How to open the jack cover

- 1** Press the bottom of the cover.
- 2** Hook your finger on the top edge of the cover and pull it open.

* The ▷ (play), CHAINE + buttons and jack cover have a tactile dot.

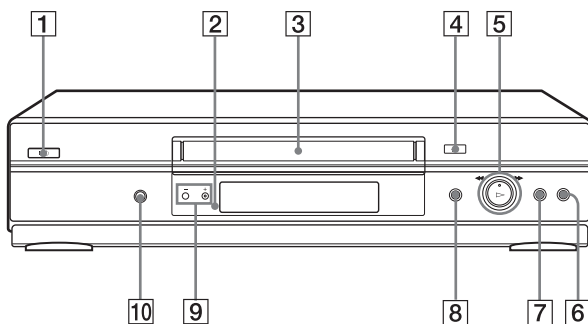

- 1** I/⏻ (on/standby) switch
- 2** Remote sensor (12)
- 3** Tape compartment
- 4** ≡ (eject) button (36)
- 5** ▷ (play) button*¹ (36) (55)/▶▶ (fast-forward)/◀◀ (rewind) (37) (56)/Playback Dial (37) (56)
- 6** ■ (stop) button (20) (36) (73) (74)

- 7** || (pause) button (36) (73) (74)
- 8** ENR ● (record) button (40) (57) (73)
- 9** CHAINE +/- buttons*¹ (56) (67)
- 10** ENR SYNCHRO (Synchronized Recording) button*² (59)

*¹ The ▷ (play) and CHAINE + buttons have a tactile dot.

*² not available on SLV-SE640B

For SLV-SE240B

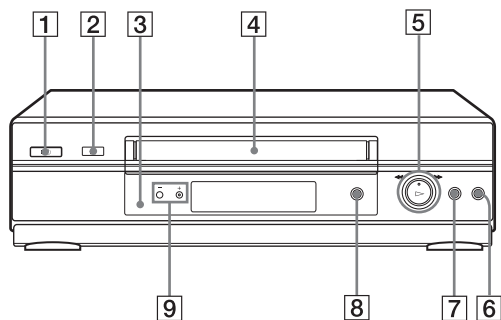

1 I/⏻ (on/standby) switch

2 ⏏ (eject) button (36)

3 Remote sensor (12)

4 Tape compartment

5 ▷ (play) button* (36) (55)/▶▶ (fast-forward)/◀◀ (rewind) (37) (56)/Playback Dial (37) (56)

6 ■ (stop) button (20) (36) (73) (74)

7 || (pause) button (36) (73) (74)

8 ENR ● (record) button (40) (57) (73)

9 CHAINE +/- buttons* (56) (67)

* The ▷ (play) and CHAINE + buttons have a tactile dot.

Display window

For SLV-SE840B and SE740B

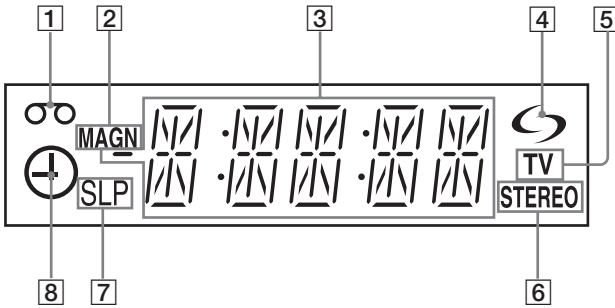

- | | |
|--|--|
| 1 Tape indicator | 5 TV indicator (42) |
| 2 MAGN indicator (16) (40) | 6 STEREO indicator (62) |
| 3 Time counter/clock/line/programme position indicator (37) (39) (73) | 7 Tape speed indicators (39) |
| 4 ↻ (smartlink) indicator (17) | 8 Timer/recording indicator (40) (45) (50) (53) |

For SLV-SE640B and SE240B

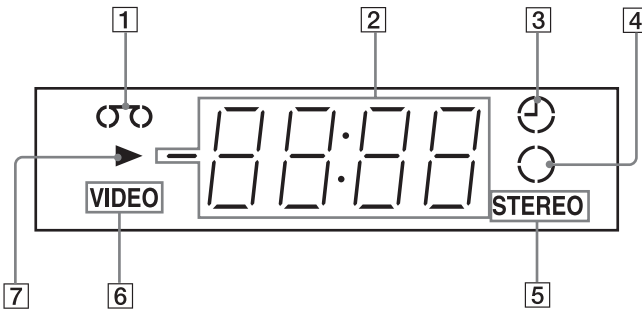

- | | |
|--|--|
| 1 Tape indicator | 5 STEREO indicator* (62) |
| 2 Time counter/clock/line/programme position indicator (37) (39) (73) | 6 VIDEO (video) indicator (16) (40) |
| 3 Timer indicator (45) (50) (53) | 7 Playback indicator |
| 4 Recording indicator (40) | * not available on SLV-SE240B |

continued

Rear panel

For SLV-SE840B, SE740B and SE640B

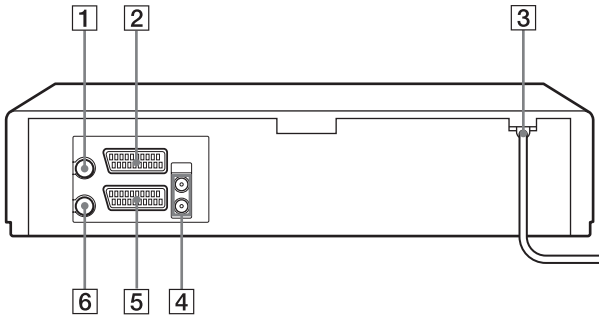

For SLV-SE240B

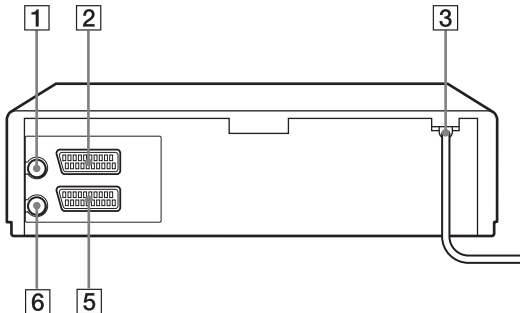

1 Υ (in from antenna) connector (16)

2 LIGNE-3 (DEC/EXT) connector*¹
LIGNE-2 (DEC/EXT) connector*²
(18) (33) (72)

3 Mains lead (16)

4 AUDIO (OUT/SORTIE) R/D (right)
L/G (left) jacks*³ (18)

5 LIGNE-1 (EURO AV) connector
(16) (33) (71)

6  (out to tv) connector (16)

*¹ SLV-SE840B only

*² SLV-SE740B, SE640B and SE240B only

*³ not available on SLV-SE640B

Remote commander

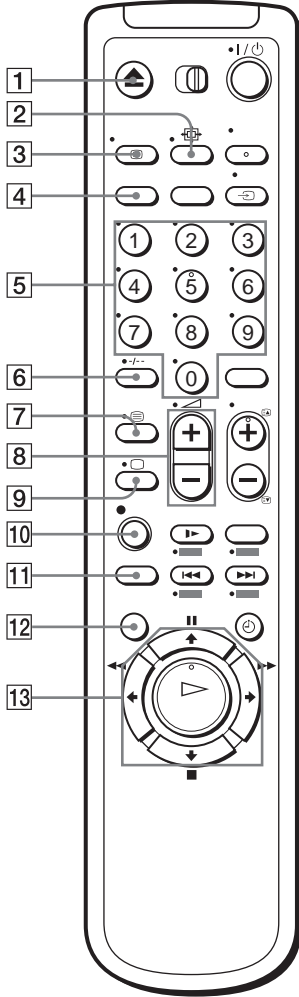

- 1 ▲ (eject) button (36)
- 2 ⇄ (wide) button (*for TV*) (14) (15)
- 3 [TV] AFFICH button (14) (37) (40)
- 4 [TV] COMPT/DUREE REST button (40)
- 5 Programme number buttons*¹ (13) (41)
- 6 -/- (ten's digit) button (13) (41)
- 7 [TV] (Teletext) button (*for TV*)*² (14)
- 8 ▲ (volume) +/- buttons (*for TV*) (13)
- 9 [TV] TV power on/TV mode select button (*for TV*)*² (13)
- 10 ● ENR (record) button (40) (57)
- 11 [TV] SP (Standard Play)/LP (Long Play) button*³ (39)
- 12 [TV] MENU button (21) (60)
- 13 || (pause)/↑ button (21) (36)
 ■ (stop)/↓ button (21) (36)
 ◀◀ (rewind)/← button (21) (36) (55)
 ▶▶ (fast-forward)/→ button (21) (36) (55)
 ▷ (play)/OK button*¹ (21) (36) (55)

*¹ The ▷ (play), CHOIX SON, number 5 and CHAINE + buttons have a tactile dot.

*² SLV-SE840B only

*³ not available on SLV-SE240B

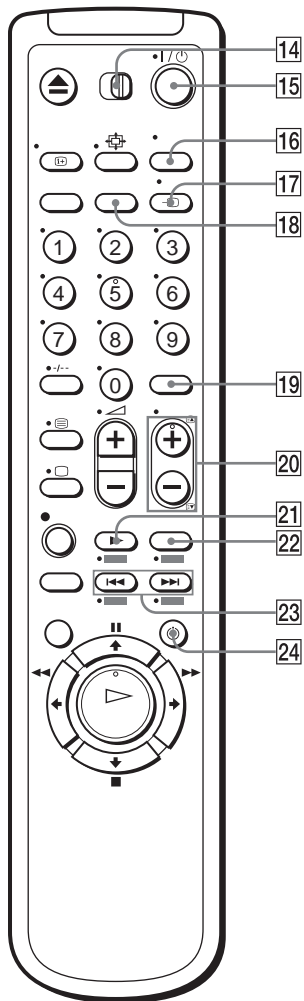

- 14** **TV** / **MAGN** remote control switch (12)
- 15** **I/O** (on/standby) switch (13) (14) (50)
- 16** **CHOIX SON** button*¹*³ (14) (63)
- 17** **TV/MAGN** button (13) (16) (40)
- 18** **ANNUL/0** button (37) (49) (60)
- 19** **CHOIX ENTREE** button (39) (53) (73)
- 20** **CHaine** (programme) +/- buttons*¹ (13) (39)
- 21** **RALENTI** button*⁴ (55)
- 22** **x2** button*⁴ (55)
- 23** **index search** buttons*³*⁴ (65)
- 24** **MINUTERIE** button (48) (52)

Teletext page access buttons (for TV)*² (14)

- *¹ The **play** (▶), **CHOIX SON**, number 5 and **CHaine +** buttons have a tactile dot.
- *² SLV-SE840B only
- *³ not available on SLV-SE240B
- *⁴ **FASTTEXT** buttons (for TV) (SLV-SE840B only)

Step 1 : Unpacking

Check that you have received the following items with the VCR:

- Remote commander
- Aerial cable

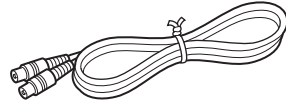
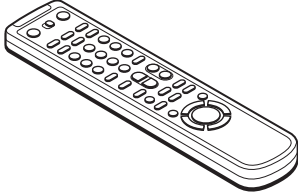

- R6 (size AA) batteries
- PERITEL cable

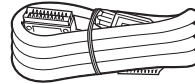
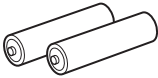

Note

- The supplied remote commander is for the exclusive use of this VCR.

How to use this manual

The instructions in this manual are for the 4 models: SLV-SE840B, SE740B, SE640B and SE240B. Check your model name by looking at the rear panel of your VCR.

SLV-SE840B is the model used for illustration purposes. Any difference in operation is clearly indicated in the text, for example, "SLV-SE840B only."

This manual mainly explains operations using the remote, but the same operations can also be performed using the buttons on the VCR having the same or similar names.

Step 2 : Setting up the remote commander

Inserting the batteries

Insert two R6 (size AA) batteries by matching the + and – on the batteries to the diagram inside the battery compartment.

Insert the negative (–) end first, then push in and down until the positive (+) end clicks into position.

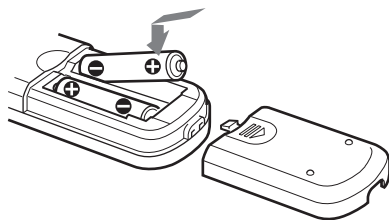

Using the remote commander

You can use this remote commander to operate this VCR and a Sony TV. Buttons on the remote commander marked with a dot (•) can be used to operate your Sony TV. If the TV does not have the  symbol near the remote sensor, this remote commander will not operate the TV.

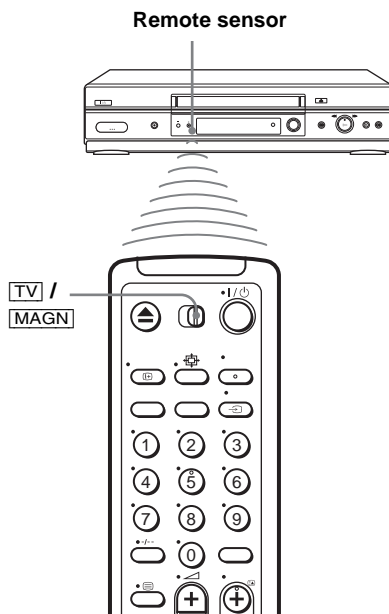



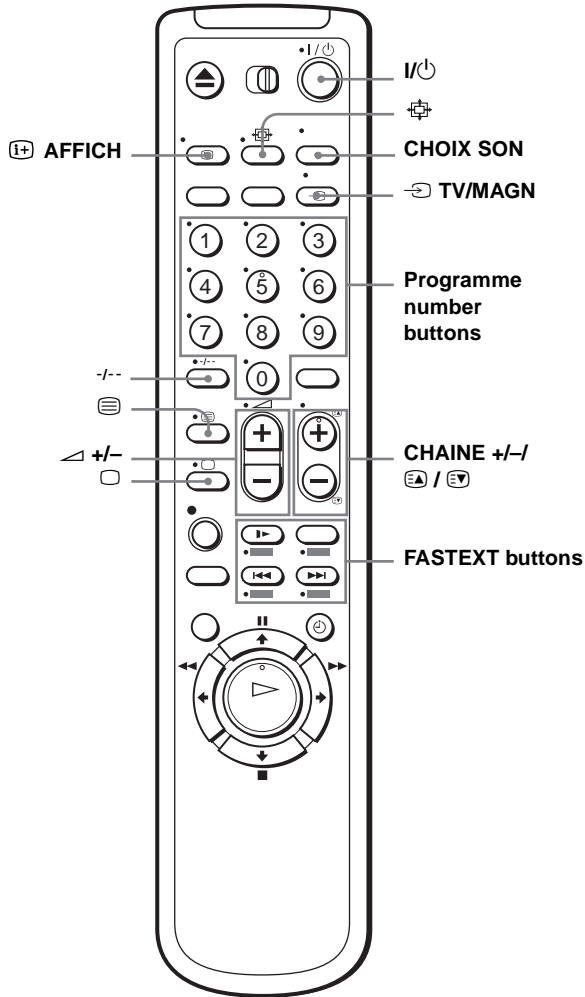

To operate	Set TV / MAGN to
the VCR	MAGN and point at the remote sensor at the VCR
a Sony TV	TV and point at the remote sensor at the TV



TV control buttons

To	Press
Set the TV to standby mode	I/Power
Select an input source: aerial in or line in	TV/MAGN
Select the TV's programme position	Programme number buttons, -/--, CHAINE +/-
Adjust the volume of the TV	Volume +/-
Switch to TV (Teletext off)*1	□ (TV)

continued

To	Press
Switch to Teletext* ¹	 (Teletext)
Select the sound* ²	CHOIX SON
Use FASTEXT* ¹	FASTEXT buttons
Call up the on-screen display	 AFFICH
Change the Teletext page* ¹	 / 
Switch to/from wide mode of a Sony wide TV (For other manufactures' wide TVs, see "Controlling other TVs with the remote commander (SLV-SE840B only)" below.)	 (wide)

Notes



- With normal use, the batteries should last about three to six months.
- If you do not use the remote commander for an extended period of time, remove the batteries to avoid possible damage from battery leakage.
- Do not use a new battery together with an old one.
- Do not use different types of batteries together.
- Do not leave the remote commander in an extremely hot or humid place.
- Do not drop any foreign object into the remote casing, particularly when replacing the batteries.
- Do not expose the remote sensor to direct light from the sun or lighting apparatus. Doing so may cause a malfunction.
- Some buttons may not work with certain Sony TVs.



*¹ SLV-SE840B only

*² not available on SLV-SE240B











Controlling other TVs with the remote commander (SLV-SE840B only)

The remote commander is preprogrammed to control non-Sony TVs. If your TV is listed in the following table, set the appropriate manufacturer's code number.

1 Set  /  at the top of the remote commander to .

2 Hold down , and enter your TV's code number using the programme number buttons. Then release .

Now you can use the following TV control buttons to control your TV:

, , programme number buttons,  (ten's digit), CHAINE +/-,  +/-,  (TV),  (Teletext), FASTEXT buttons,  (wide)*, MENU*,  /  /  / *, and OK*.

* These buttons may not work with all TVs.

Code numbers of controllable TVs



If more than one code number is listed, try entering them one at a time until you find the one that works with your TV.





To switch to wide mode, see the footnotes below this table for the applicable code numbers.

Manufacturer	Code number
Sony	01* ¹ , 02
Akai	68
Ferguson	52
Grundig	10* ¹ , 11* ¹
Hitachi	24
JVC	33
Loewe	45
Mivar	09, 70
NEC	66
Nokia	15, 16, 69* ³

Manufacturer	Code number
Panasonic	17* ¹ , 49
Philips	06* ¹ , 07* ¹ , 08* ¹
Saba	12, 13
Samsung	22, 23
Sanyo	25
Sharp	29
Telefunken	36
Thomson	43* ²
Toshiba	38

*1 Press  (wide) to switch the wide picture mode on or off.

*2 Press  (wide), then press  +/- to select the wide picture mode you want.

*3 Press  (wide). The menu appears on the TV screen. Then, press /// to select the wide picture you want and press OK.

Tip

- When you set your TV's code number correctly while the TV is turned on, the TV turns off automatically.

Notes

- If you enter a new code number, the code number previously entered will be erased.
- If the TV uses a different remote control system from the one programmed to work with the VCR, you cannot control your TV with the remote commander.
- When you replace the batteries of the remote commander, the code number may change. Set the appropriate code number every time you replace the batteries.

Step 3 : Connecting the VCR

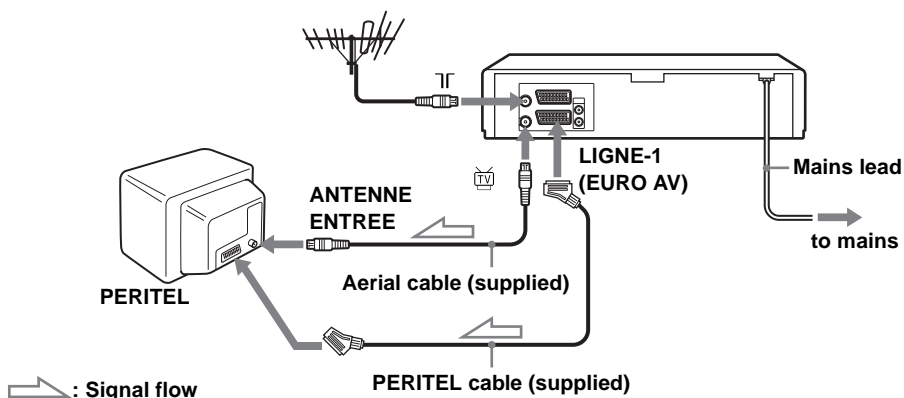

- 1 Disconnect the aerial cable from your TV and connect it to on the rear panel of the VCR.

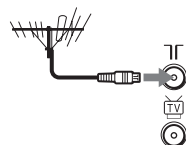

- 2 Connect of the VCR and the aerial input of your TV using the supplied aerial cable.

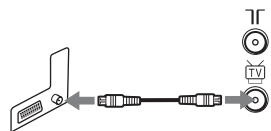

- 3 Connect LIGNE-1 (EURO AV) on the VCR and the PERITEL connector on the TV with the supplied PERITEL cable.

Whenever you want to watch the VCR picture, press TV/MAGN to display the MAGN*¹ or VIDEO*² indicator in the display window.

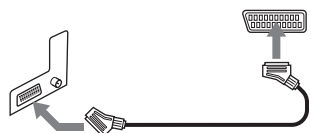

- 4 Connect the mains lead to the mains.

*¹ SLV-SE840B and SE740B only

*² SLV-SE640B and SE240B only

About the SMARTLINK features (not available on SLV-SE640B and SE240B)

If the connected TV complies with SMARTLINK, MEGALOGIC*¹, EASYLINK*², Q-Link*³, EURO VIEW LINK*⁴, or T-V LINK*⁵, this



VCR automatically runs the

SMARTLINK function after you complete the steps on the previous page (the  indicator appears in the VCR's display window when you turn on the TV). You can enjoy the following SMARTLINK features.

- **TV Direct Rec**
You can easily record what you are watching on the TV when the VCR is turned on. For details, see “Recording what you are watching on the TV (TV Direct Rec) (not available on SLV-SE640B and SE240B)” on page 42.
- **One Touch Play**
With One Touch Play, you can start playback automatically without turning on the TV. For details, see “Starting playback automatically with one button (One Touch Play) (not available on SLV-SE640B and SE240B)” on page 38.
- **One Touch Menu**
When the VCR is turned on, you can turn on the TV, set the TV to the video channel, and display the VCR's on-screen display automatically by pressing MENU on the remote commander.
- **One Touch Timer**
When the VCR is turned on, you can turn on the TV, set the TV to the video channel, and display the timer recording menu (the MINUTERIE menu or the SHOWVIEW menu) automatically by pressing  MINUTERIE on the remote commander.
You can set which timer recording menu is displayed using OPTIONS PROG. in the FONCTIONS AVANCÉES menu (see page 70).
- **NexTView Download**
You can easily set the timer by using the NexTView Download function on your TV. Please refer to your TV's instruction manual.

*¹“MEGALOGIC” is a registered trademark of Grundig Corporation.

*²“EASYLINK” is a trademark of Philips Corporation.

*³“Q-Link” is a trademark of Panasonic Corporation.

*⁴“EURO VIEW LINK” is a trademark of Toshiba Corporation.

*⁵“T-V LINK” is a trademark of JVC Corporation.

Note

- Not all TVs respond to the functions above.

continued

Additional connections

To a stereo system (not available on SLV-SE640B and SE240B)

You can improve sound quality by connecting a stereo system to the AUDIO R/D L/G jacks as shown on the right.

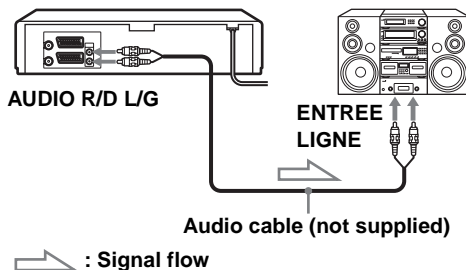

To a satellite or digital tuner with Line Through

Using the Line Through function, you can watch programmes from a satellite or digital tuner connected to this VCR on the TV even when the VCR is turned off. When you turn on the satellite or digital tuner, this VCR automatically sends the signal from the satellite or digital tuner to the TV without turning itself on.

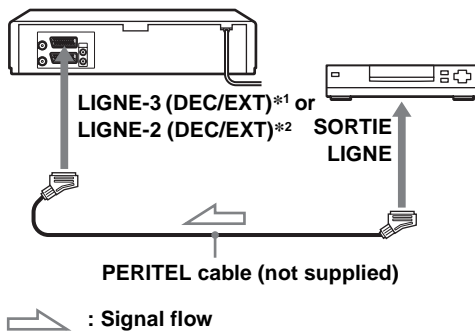

1 Connect the satellite or digital tuner to the LIGNE-3 (DEC/EXT)*1 or LIGNE-2 (DEC/EXT)*2 connector as shown above.

2 Turn off the VCR.

To watch a programme, turn on the satellite or digital tuner and the TV.

Notes

- The Line Through function will not operate properly if VEILLE ECO in the RÉGLAGES UTILISATEUR menu is set to ECO2. Set VEILLE ECO to NON or ECO1 to ensure proper operation (see page 68).
- You cannot watch programmes on the TV while recording unless you are recording a satellite or digital programme.
- This function may not work with some types of satellite or digital tuners.
- When the VCR is turned off, set the TV to the video channel.

*1 SLV-SE840B only

*2 SLV-SE740B, SE640B and SE240B only

Step 4 : Setting up the VCR with the Auto Set Up function

Before using the VCR for the first time, set up the VCR using the Auto Set Up function. With this function, you can set the TV channels, guide channels for the ShowView system*, and VCR clock* automatically.

1 Turn on your TV and set it to the video channel.

2 Connect the mains lead to the mains.
The VCR automatically turns on, and the message for the Auto Set Up function appears.

3 Press OK.
The SÉLECTION DU PAYS menu* appears.

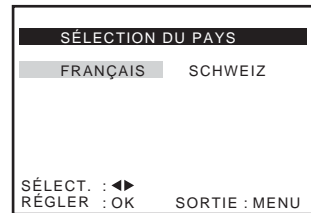

4 For SLV-SE840B, SE740B and SE240B



Press ◀/▶ to select your country, then press OK.

The VCR starts searching for all of the receivable channels and presets them (in the appropriate order for your local area).

If you want to change the order of the channels or disable unwanted programme positions, see “Changing/disabling programme positions” on page 28.

After the search or download is complete, the current time appears for any stations that transmit a time signal. If the time does not appear, set the clock manually. See “Setting the clock” on page 21.

For SLV-SE640B

The clock setting menu appears. See “Setting the clock” on page 21.



continued

To cancel the Auto Set Up function

Press MENU.

Notes

- Whenever you operate the Auto Set Up function, some of the settings (ShowView*, timer, etc.) will be reset. If this happens, you have to set them again.
- Auto preset starts automatically only when you plug in the mains lead for the first time after you purchase the VCR.
- If you want to use the Auto Set Up function again, press MENU, then press **↑/↓/←/→** to highlight INSTALLATION and press OK. Press **↑/↓** to highlight INSTALLATION AUTO, then repeat all procedures from step 3.
- Auto preset can be performed by pressing **■** (stop) on the VCR continuously for 5 seconds or more with no tape inserted.

* not available on SLV-SE640B

Setting the clock

You must set the time and date on the VCR to use the timer features properly.

The Auto Clock Set function* works only if a station in your area is broadcasting a time signal.

Before you start...

- Turn on the VCR and the TV.
- Set the TV to the video channel.
- Refer to “Index to parts and controls” for button locations.

1

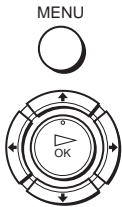

Press MENU, then press **↑/↓/←/→** to highlight RÉGLAGE HORLOGE and press OK.



2



Press **↑/↓** to set the hour.

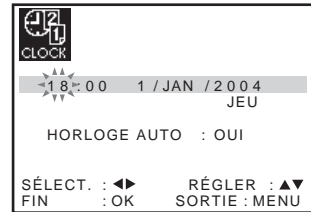

3



Press **→** to select the minutes and set the minutes by pressing **↑/↓**.



continued

4



Set the day, month, and year in sequence by pressing **→** to select the item to be set, and press **↑/↓** to select the digits, then press **→**.

The day of the week is set automatically.



5



Press **↑/↓** to select OUI for the setting of the Auto Clock Set function*.

The VCR automatically sets the clock according to the time signal broadcast between the channels ST 1 to ST 5.

If you do not need the Auto Clock Set function, select NON.

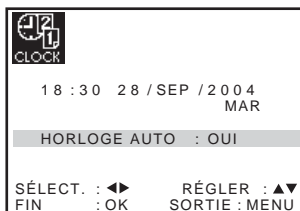

6



Press MENU to exit the menu.

Tips

- If you set HORLOGE AUTO* to OUI, the Auto Clock Set function is activated whenever the VCR is turned off. The time is adjusted automatically by making reference to the time signal from the station.
- To change the digits while setting, press **←** to return to the item to be changed, and select the digits by pressing **↑/↓**.

* not available on SLV-SE640B

Downloading the TV tuner's preset data (not available on SLV-SE640B and SE240B)

You can download your TV tuner's preset data to the VCR and tune the VCR according to that data using the SMARTLINK connection.

Before you start...

- Turn on the VCR and the TV.
- Set the TV to the video channel.
- Refer to "Index to parts and controls" for button locations.

1

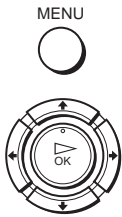

Press MENU, then press **↑/↓/←/→** to highlight **INSTALLATION** and press OK.



2



Press **↑/↓** to highlight **SMARTLINK**, then press **→**.

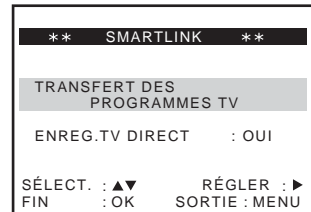

3



Press **↑/↓** to highlight **TRANSFERT DES PROGRAMMES TV**, then press **→**. Press **→** again. The Preset Download function starts and the **↻** indicator flashes in the display window during download.



Selecting a language

If you prefer an on-screen language other than French, use the on-screen display to select another language.

Before you start...

- Turn on the VCR and the TV.
- Set the TV to the video channel.
- Refer to “Index to parts and controls” for button locations.

1

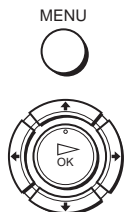

Press MENU, then press **↑/↓/←/→** to highlight **SÉLECTION LANGUE** and press OK.

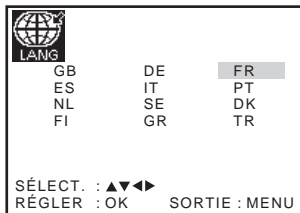

2



Press **↑/↓/←/→** to highlight the abbreviation of the desired language from the table below, then press OK.

The abbreviations of the languages are as follows:

Abbreviation	Language	Abbreviation	Language
GB	English	SE	Swedish
ES	Spanish	GR	Greek
NL	Dutch	FR	French
FI	Finnish	PT	Portuguese
DE	German	DK	Danish
IT	Italian	TR	Turkish

Presetting channels

If some channels could not be preset using the Auto Set Up function, you can preset them manually.

Before you start...

- Turn on the VCR and the TV.
- Set the TV to the video channel.
- Refer to “Index to parts and controls” for button locations.

1

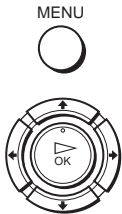

Press MENU, then press **↑/↓/←/→** to highlight INSTALLATION and press OK.



2



Press **↑/↓** to highlight INSTALLATION MANUELLE, then press **→**.

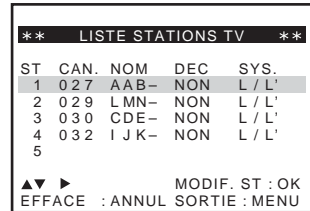

3



Press **↑/↓** to highlight the row which you want to preset, then press **→**.

To display other pages for programme positions 6 to 80, press **↑/↓** repeatedly.

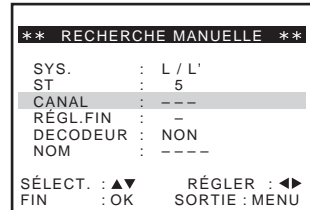

4



Press **↑/↓** to highlight SYS if necessary.

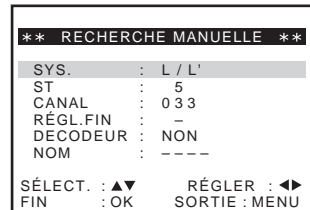

continued

5



Press **←/→** to set L/L' or B/G if necessary.

- To receive broadcast in France, highlight L/L'.
- To receive broadcast using the PAL system (for example, in Germany or Switzerland), highlight B/G.

6



Press **↑/↓** to highlight CANAL, then press **←/→** repeatedly until the channel you want is displayed.

** RECHERCHE MANUELLE **	
SYS.	: L / L'
ST	: 5
CANAL	: 033
RÉGL.FIN	: -
DECODEUR	: NON
NOM	: ----
SÉLECT. : ▲▼	RÉGLER : ◀▶
FIN : OK	SORTIE : MENU

7



Press **↑/↓** to highlight NOM, then press **→**.

** RECHERCHE MANUELLE **	
SYS.	: L / L'
ST	: 5
CANAL	: 033
RÉGL.FIN	: -
DECODEUR	: NON
NOM	: * * * *
SÉLECT. : ▲▼	RÉGLER : ◀▶
FIN : OK	SORTIE : MENU

8



Enter the station name.

- 1 Press **↑/↓** to select a character. Each time you press **↑**, the character changes as shown below.

A → B → ... → Z → 0 → 1 → ... → 9 → A

- 2 Press **→** to set the next character.

The next space flashes.

To correct a character, press **←/→** until the character you want to correct flashes, then reset it.

You can set up to 4 characters for the station name.

** RECHERCHE MANUELLE **	
SYS.	: L / L'
ST	: 5
CANAL	: 033
RÉGL.FIN	: -
DECODEUR	: NON
NOM	: * 0 * *
SÉLECT. : ▲▼	RÉGLER : ◀▶
FIN : OK	SORTIE : MENU

9



Press OK to confirm the station name.

10

MENU



Press MENU to exit the menu.

If the picture is not clear

If the picture is not clear, you may use the Manual Fine Tuning (RÉGL.FIN) function. After step 6, press **↑/↓** to select RÉGL.FIN. Press **←/→** to get a clear picture, then press MENU to exit the menu.

Tip

- To set the programme position for the decoder, see “Setting the Canal Plus decoder” on page 33.

Note

- When adjusting RÉGL.FIN, the menu may become difficult to read due to interference from the picture being received.

Changing/disabling programme positions

After setting the channels, you can change the programme positions as you like. If any programme positions are unused or contain unwanted channels, you can disable them.

You can also change the station names. If the station names are not displayed, you can enter them manually.

Changing programme positions

Before you start...

- Turn on the VCR and the TV.
- Set the TV to the video channel.
- Refer to "Index to parts and controls" for button locations.

1

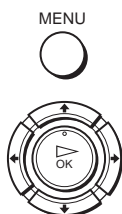

Press MENU, then press **↑/↓/←/→** to highlight **INSTALLATION** and press **OK**.



2



Press **↑/↓** to highlight **INSTALLATION MANUELLE**, then press **→**.

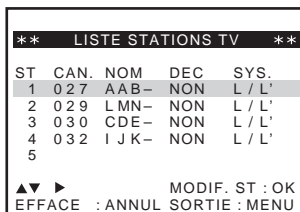

3



Press **↑/↓** to highlight the row which you want to change the programme position.

To display other pages for programme positions 6 to 80, press **↑/↓** repeatedly.

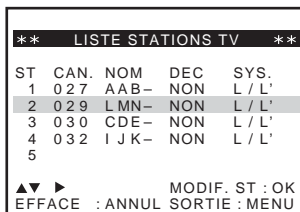

4



Press OK, then press \uparrow/\downarrow to move to the desired programme position.

** LISTE STATIONS TV **				
ST	CAN.	NOM	DEC	SYS.
1	027	AAB-	NON	L / L'
2				
3	030	CDE-	NON	L / L'
4	032	JJK-	NON	L / L'
5	029	LMN-	NON	L / L'

$\blacktriangle\blacktriangledown$ MODIF. ST : OK
 SORTIE : MENU

5



Press OK to confirm the setting.

6

To change the programme position of another station, repeat steps 3 through 5.

7



Press MENU to exit the menu.

Disabling unwanted programme positions

After presetting channels, you can disable unused programme positions. The disabled positions will be skipped later when you press the CHAINE +/- buttons.

Before you start...

- Turn on the VCR and the TV.
- Set the TV to the video channel.
- Refer to "Index to parts and controls" for button locations.

1



Press MENU, then press $\uparrow/\downarrow/\leftarrow/\rightarrow$ to highlight INSTALLATION, and press OK.

	
INSTALLATION AUTO	
INSTALLATION MANUELLE	
SMARTLINK	
SÉLECT. : $\blacktriangle\blacktriangledown$	RÉGLER : \blacktriangleright
FIN : OK	SORTIE : MENU

continued

2

Press **↑/↓** to highlight
INSTALLATION MANUELLE,
 then press **→**.

** LISTE STATIONS TV **				
ST	CAN.	NOM	DEC	SYS.
1	0 2 7	A A B-	NON	L / L'
2	0 2 9	L M N-	NON	L / L'
3	0 3 0	C D E-	NON	L / L'
4	0 3 2	I J K-	NON	L / L'
5				

▲▼ ► MODIF. ST : OK
 EFFACE : ANNUL SORTIE : MENU

3

Press **↑/↓** to highlight the row
 which you want to disable.
 To display other pages for
 programme positions 6 to 80, press
↑/↓ repeatedly.

** LISTE STATIONS TV **				
ST	CAN.	NOM	DEC	SYS.
1	0 2 7	A A B-	NON	L / L'
2	0 2 9	L M N-	NON	L / L'
3	0 3 0	C D E-	NON	L / L'
4	0 3 2	I J K-	NON	L / L'
5				

▲▼ ► MODIF. ST : OK
 EFFACE : ANNUL SORTIE : MENU

4

Press **ANNUL/O**.
 The selected row will be cleared as
 shown on the right.

** LISTE STATIONS TV **				
ST	CAN.	NOM	DEC	SYS.
1	0 2 7	A A B-	NON	L / L'
2				
3	0 3 0	C D E-	NON	L / L'
4	0 3 2	I J K-	NON	L / L'
5				

▲▼ ► MODIF. ST : OK
 EFFACE : ANNUL SORTIE : MENU

5

Repeat steps 3 and 4 for any other programme positions you want to disable.

6

Press **MENU** to exit the menu.

Note

- Be sure to select the programme position you want to disable correctly. If you disable a programme position by mistake, you need to reset that channel manually.

Changing the station names

You can change or enter the station names (up to 4 characters). The VCR must receive channel information for station names to appear automatically*.

* not available on SLV-SE640B

Before you start...

- Turn on the VCR and the TV.
- Set the TV to the video channel.
- Refer to “Index to parts and controls” for button locations.

1

MENU

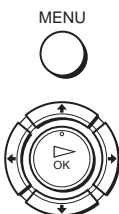

Press MENU, then press **↑/↓/←/→** to highlight INSTALLATION and press OK.

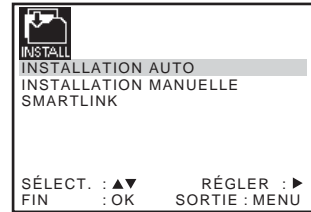

2



Press **↑/↓** to highlight INSTALLATION MANUELLE, then press **→**.

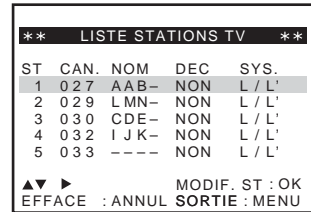

3



Press **↑/↓** to highlight the row which you want to change or enter the station name, then press **→**.

To display other pages for programme positions 6 to 80, press **↑/↓** repeatedly.

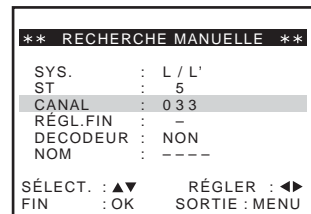

4



Press **↑/↓** to highlight NOM, then press **→**.

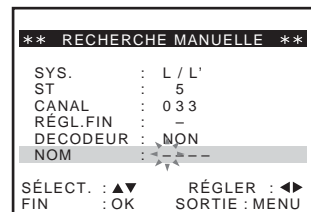

continued

5



Enter the station name.

- 1 Press **↑/↓** to select a character.
Each time you press **↑**, the character changes as shown below.

A → B → ... → Z → 0 → 1 → ... → 9 → A

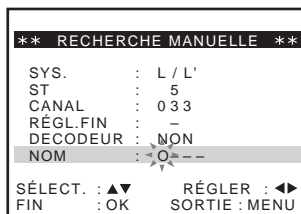

- 2 Press **→** to set the next character.

The next space flashes.

To correct a character, press **←/→** until the character you want to correct flashes, then reset it.

You can set up to 4 characters for the station name.

6



Press OK to confirm the new name.

7



Press MENU to exit the menu.

Setting the Canal Plus decoder

You can watch or record Canal Plus programmes if you connect a decoder (not supplied) to the VCR.

Connecting a decoder

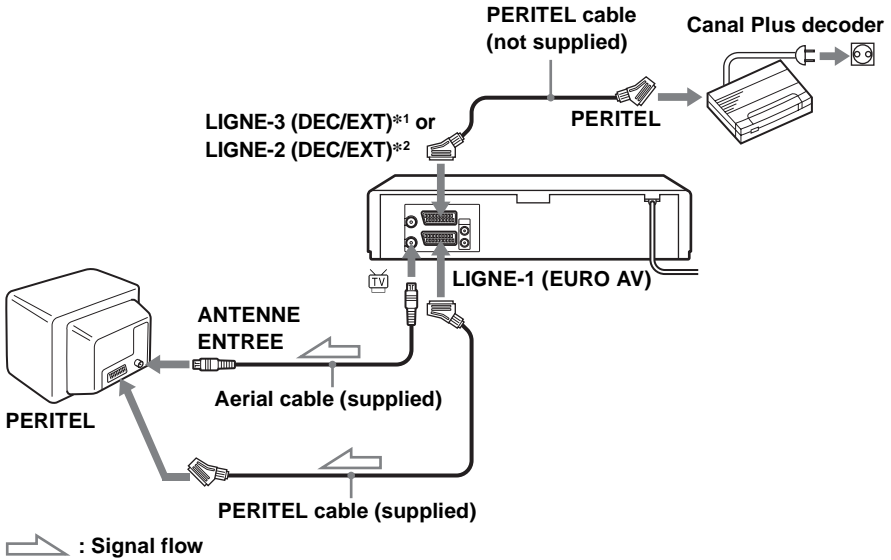

Setting Canal Plus channels

To watch or record Canal Plus programmes, set your VCR to receive the channels using the on-screen display.

In order to set the channels correctly, be sure to follow all of the steps below.

Before you start...

- Turn on the VCR, the TV, and the decoder.
- Set the TV to the video channel.
- Refer to "Index to parts and controls" for button locations.

continued

1



Press MENU, then press **↑/↓/←/→** to highlight INSTALLATION and press OK.



2



Press **↑/↓** to highlight INSTALLATION MANUELLE, then press **→**.

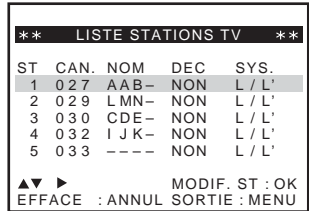

3



Press **↑/↓** to highlight the row which you want to set for the decoder, then press **→**.
To display positions 6 to 80, press **↑/↓** repeatedly.

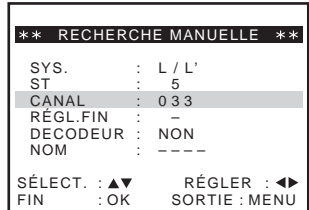

4



Press **↑/↓** to highlight SYS if necessary.

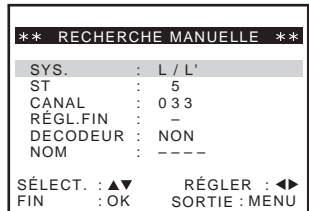

5



Press **←/→** to set L/L' or B/G if necessary.

- To receive broadcast in France, highlight L/L'.
- To receive broadcast using the PAL system (for example, in Germany or Switzerland), highlight B/G.

6



Press **↑/↓** to highlight CANAL, then press **←/→** repeatedly until the channel you want is displayed.

** RECHERCHE MANUELLE **	
SYS.	: L / L'
ST	: 5
CANAL	: 0 3 3
RÉGL.FIN	: -
DECODEUR	: NON
NOM	: - - - -
SÉLECT.	: ▲▼ RÉGLER : ◀▶
FIN	: OK SORTIE : MENU

7



Press **↑/↓** to highlight DECODEUR.

** RECHERCHE MANUELLE **	
SYS.	: L / L'
ST	: 5
CANAL	: 0 3 3
RÉGL.FIN	: -
DECODEUR	: NON
NOM	: - - - -
SÉLECT.	: ▲▼ RÉGLER : ◀▶
FIN	: OK SORTIE : MENU

8



Press **→** to set DECODEUR to OUI, then press OK.

** RECHERCHE MANUELLE **	
SYS.	: L / L'
ST	: 5
CANAL	: 0 3 3
RÉGL.FIN	: -
DECODEUR	: OUI
NOM	: - - - -
SÉLECT.	: ▲▼ RÉGLER : ◀▶
FIN	: OK SORTIE : MENU

9



Press MENU to exit the menu.

Notes

- To superimpose subtitles while watching Canal Plus programmes, make both decoder-VCR and VCR-TV connections using 21-pin PERITEL cables that are compatible with the RGB signals. You cannot record subtitles on the VCR.
- When you watch Canal Plus programmes through the RFU input of the TV, press **⇒** TV/MAGN so that the MAGN*³ or VIDEO*⁴ indicator appears in the display window.

*1 SLV-SE840B only

*2 SLV-SE740B, SE640B and SE240B only

*3 SLV-SE840B and SE740B only

*4 SLV-SE640B and SE240B only

Playing a tape

Before you start...

- Refer to “Index to parts and controls” for button locations.

1 Turn on your TV and set it to the video channel.

2 Insert a tape.
The VCR turns on and starts playing automatically if you insert a tape with its safety tab removed.

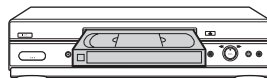

3 Press ▷ (play).
When the tape reaches the end, it will rewind automatically.



Additional tasks

To	Do this
Stop play	Press ■ (stop)
Pause play	Press (pause)
Resume play after pause	Press (pause) or ▷ (play)
Fast-forward the tape	Press ►► (fast-forward) during stop
Rewind the tape	Press ◀◀ (rewind) during stop
Eject the tape	Press ▲ (eject)

Using Playback Dial on the VCR

With Playback Dial, you can operate the following playback options.

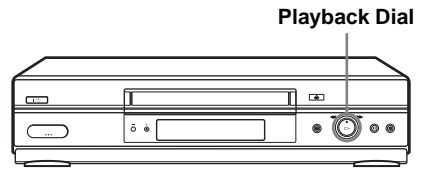

To	Do this
Resume play after pause	Press ▷ (play)
Fast-forward the tape	Quickly turn and release Playback Dial to the right (▶▶ (fast-forward)) during stop
Rewind the tape	Quickly turn and release Playback Dial to the left (◀◀ (rewind)) during stop

Note

- Do not turn Playback Dial forcibly. It may damage Playback Dial.

To set the colour system

If the playback picture has no colour, or streaks appear during playback, set the SYST. COULEUR option in the RÉGLAGES UTILISATEUR menu to conform to the system that the tape was recorded in (see page 69) (Normally set the option to AUTO).

To use the time counter

Press ANNUL/0 at the point on the tape that you want to find later. The counter in the display window resets to “0:00:00” or “00:00.” Search for the point afterwards by referring to the counter.

SE840B, SE740B

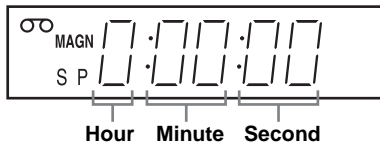

SE640B, SE240B

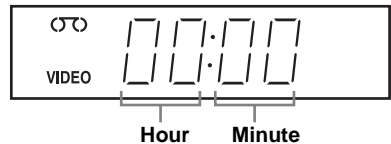

To display the counter on the TV screen, press \oplus AFFICH.

Notes

- The counter resets to “0:00:00” or “00:00” whenever a tape is reinserted.
- The counter stops counting when it comes to a portion with no recording.
- Depending on your TV, the following may occur while playing an NTSC-recorded tape:
 - The picture becomes black and white.
 - The picture shakes.
 - No picture appears on the TV screen.
 - Black streaks appear horizontally on the TV screen.
 - The colour density increases or decreases.
- Tapes recorded in the LP mode cannot be played back on SLV-SE240B.
- While setting the menu on the TV screen, buttons for playback on the remote commander do not function.

Starting playback automatically with one button (One Touch Play) (not available on SLV-SE640B and SE240B)

If you use the SMARTLINK connection, you can turn on the TV, set the TV to the video channel, and start playback automatically with one button.

1 Insert a tape.

The VCR automatically turns on.

If you insert a tape with its safety tab removed, the TV turns on and switches to the video channel. Playback starts automatically.

2 Press (play).

The TV turns on and switches to the video channel automatically. Playback starts.

Tip

- When there already is a tape in the VCR, press I/⏻ to turn on the VCR first. When you press  (play), the TV turns on, the TV is set to the video channel, and playback starts automatically in one sequence.

Note

- When you use the One Touch Play function, leave the TV on or in the standby mode.

Recording TV programmes

Before you start...

- Refer to “Index to parts and controls” for button locations.

1 Turn on your TV and set it to the video channel.
To record from a decoder, turn it on.
If no picture or sound is reproduced on the TV, press
→ TV/MAGN on the remote commander to display MAGN or
VIDEO indicator on the display window.

2 Insert a tape with its safety tab in place.

3 • CHAINE

- To record a normal channel, press CHAINE +/- until the programme position number or station name you want appears in the display window.

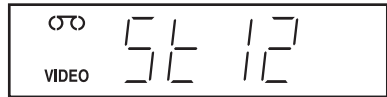

- To record from a decoder or other source connected to one or more of the LIGNE inputs, press CHOIX ENTREE until the connected line appears in the display window.



4 Press SP/LP to select the tape speed, SP or LP.*1



LP (Long Play) provides recording time twice as long as SP.
However, SP (Standard Play) produces better picture and audio
quality.



5



Press ● ENR to start recording.

The recording indicator lights up in the display window.

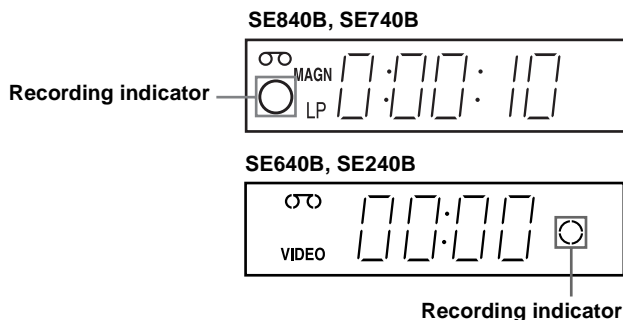

To stop recording

Press ■ (stop).

To check the remaining time

Press ⏏ AFFICH twice. With the display on, press COMPT/DUREE REST to check the remaining time. Each time you press COMPT/DUREE REST, the time counter and the remaining time appear alternately.

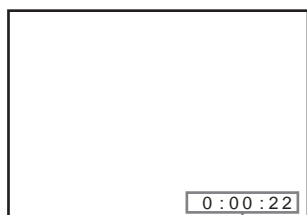

Time counter



Remaining time

In order to get an accurate remaining time indication, be sure SÉLECT.CASSETTE in the RÉGLAGES UTILISATEUR menu is set according to the tape type you use (see page 69).

To watch another TV programme while recording

- 1 Press ⏏ TV/MAGN to turn off the MAGN*² or VIDEO*³ indicator in the display window.
- 2 Select another programme position on the TV.

To save a recording

To prevent accidental erasure, break off the safety tab as illustrated. To record on the same tape again, cover the tab hole with adhesive tape.

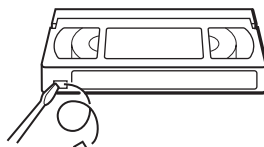

Safety tab

Tips

- To select a programme position, you can use the programme number buttons on the remote commander. For two-digit numbers, press **-/-** (ten's digit) followed by the programme number buttons.
- If you connect additional equipment to a LIGNE connector or jack, you can select the input signal using the **CHOIX ENTREE** or **CHAINE +/-** buttons.
- The **I+** **AFFICH** information appears on the TV screen indicating information about the tape, but the information will not be recorded on the tape.
- If you do not want to watch TV while recording, you can turn off the TV. When using a decoder, make sure to leave it on.

Notes

- The **I+** **AFFICH** information does not appear during still (pause) mode or slow-motion playback.
- If a tape has portions recorded in both PAL (SECAM, MESECAM) and NTSC systems, the time counter reading will not be correct. This discrepancy is due to the difference between the counting cycles of the two video systems.
- You cannot watch a Canal Plus programme while recording another Canal Plus programme.
- When you insert a non-standard commercially available tape, the remaining time may not be correct.
- The remaining time is intended for rough measurement only.
- About 30 seconds after the tape begins playback, the tape remaining time will be displayed.

*1 not available on SLV-SE240B

*2 SLV-SE840B and SE740B only

*3 SLV-SE640B and SE240B only

Recording what you are watching on the TV (TV Direct Rec) (not available on SLV-SE640B and SE240B)

If you use the SMARTLINK connection, you can easily record what you are watching on the TV (other than tapes being played on the VCR).

- 1 Press **I/⏻** to turn on the VCR.
- 2 Insert a tape with its safety tab in place.
- 3 Press **● ENR** while you are watching a TV programme or external source.

The TV indicator lights up and the VCR starts recording what you are watching on the TV.

Tip

- The TV indicator appears in the display window after you press **● ENR** in some situations such as:
 - when you are watching a source connected to the TV's line input, or
 - when the TV tuner preset data for the programme position is different from the data in the VCR tuner preset.

Notes

- You cannot record what you are watching using this method when the VCR is in the following modes; pause, timer standby, tuner preset, Auto Set Up, and recording.
- When the TV indicator is lit in the display window, do not turn off the TV nor change the TV programme position. When the TV indicator is not lit, the VCR continues recording the programme even if you change the TV programme position on the TV.
- To use the TV Direct Rec function, select SMARTLINK in the INSTALLATION menu, then set ENREG. TV DIRECT to OUI.

Recording TV programmes using the Dial Timer (SLV-SE840B only)

The Dial Timer function allows you to make timer recordings of programmes without turning on your TV. Set the recording timer to record up to eight programmes, including settings made with other timer methods, that will be broadcast within the next month. The recording start time and recording stop time can be set at one minute intervals.

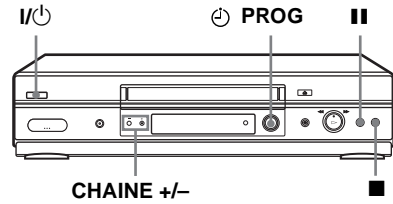

Before you start...

- Insert a tape with its safety tab in place. Make sure the tape is longer than the total recording time.
- To record from a decoder, turn it on.
- Refer to “Index to parts and controls” for button locations.

1



Press PROG.

“DATE” and “TODAY” appear alternately in the display window.

If the date and time are not set, “DAY” will appear. See step 2 in the following section, “To set the clock” to set the date and time.



2



Turn PROG to set the recording date.



continued

3



Press PROG.

“START” and the current time appear alternately in the display window.

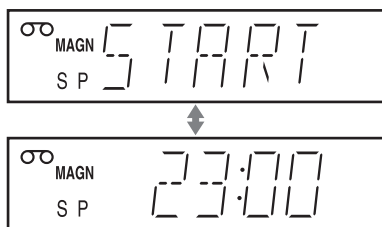

4

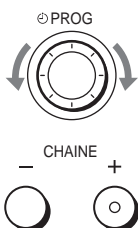

Turn PROG to set the recording start time.

You can set the recording start time in 15 minute intervals or adjust the time in one minute intervals by pressing the CHAINE +/- buttons.

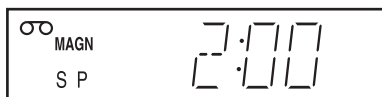

5



Press PROG.

“STOP” and the recording stop time alternately appear in the display window.

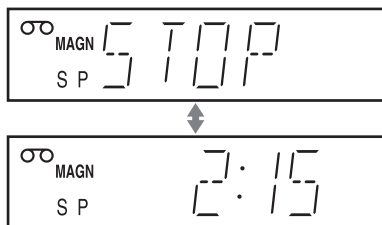

6

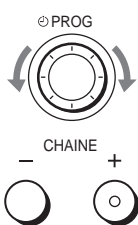

Turn PROG to set the recording stop time.

You can set the recording stop time in 15 minute intervals or adjust the time in one minute intervals by pressing the CHAINE +/- buttons.

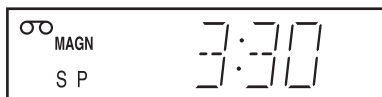

7



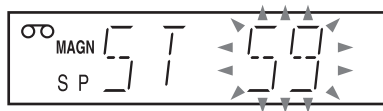

Press  PROG.

The programme position or LIGNE input appears in the display window.

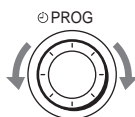

8



Turn  PROG to set the programme position.

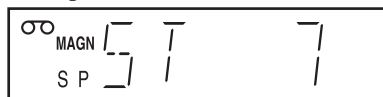

To record from a decoder or other source connected to one or more of the LIGNE inputs, turn  PROG or press CHOIX ENTREE to display the connected line in the display window.

9



Press  PROG to complete the setting.

“OK” appears in the display window for about five seconds.

The  indicator appears in the display window and the VCR stands by for recording.

To record from a decoder or other source, leave the connected equipment switched on.



To return to the previous step

To return to the previous step, press the CHAINE + and – buttons on the VCR at the same time during any of the Dial Timer settings.

To stop recording

To stop the VCR while recording, press  (stop).

To use the VCR after setting the timer

To use the VCR before a recording begins, just press . The  indicator turns off and the VCR switches on. Remember to press  to reset the VCR to recording standby after using the VCR.

You can also do the following tasks while the VCR is recording:

- Reset the counter (page 37).
- Display tape information on the TV screen (page 40).
- Check the timer settings (page 60).
- Watch another TV programme (page 40).

continued

To set the clock

- 1** Hold down ⊖ PROG so that “DAY” appears in the display window.
However, if the clock has already been set, the current setting appears.
- 2** Turn ⊖ PROG to set the day.
- 3** Press ⊖ PROG.
“MONTH” appears in the display window.
- 4** Turn and press ⊖ PROG to set the month, and then the year.
After you set the year, “CLOCK” appears in the display window again.
- 5** Turn and press ⊖ PROG to set the hour and minute.
- 6** When you have finished setting the time, press ⊖ PROG to start the clock.

Tips

- To cancel a Dial Timer setting, press ■ (stop) on the VCR while you are making the setting.
- The programme is recorded in the current tape speed mode. To change the tape speed, press SP/LP before you complete the setting in step 9.
- To check, change, or cancel the programme setting, see “Checking/changing/cancelling timer settings” on page 60.

Notes

- If eight programmes have already been set using the ShowView system or the MINUTERIE menu, “FULL” appears in the display window for about five seconds.
- The ⊖ and ○○ indicators flash in the display window when you complete the setting in step 9 with no tape inserted.
- If you set the clock using the Auto Clock Set function and HORLOGE AUTO is set to OUI, the clock will adjust itself to the incoming time signal regardless of adjustments made with the Dial Timer. Be sure you have set the Auto Clock Set correctly.
- When the time is set incorrectly, “ERROR” appears in the display window in step 9. Set the timer again from step 1.
- You cannot set the tape speed to AUTO using the Dial Timer. To select AUTO, set the tape speed in the MINUTERIE menu (see page 60).

About the Demonstration Mode

The Dial Timer function has a Demonstration Mode that allows the user, such as a salesperson, to enter more than eight examples of timer settings when demonstrating the use of the Dial Timer. It cancels the “FULL” notice which appears if eight programmes have already been set. Do not use the Demonstration Mode for making timer recordings. Doing so may cause the settings to be inaccurate.

To activate the Demonstration Mode

Press **||** (pause) on the VCR while turning the **⊖** PROG. “DEMO” appears in the display window for a few seconds.

To cancel the Demonstration Mode

Turn the power off and unplug the mains lead. Although the Demonstration Mode is cancelled, the timer settings entered while using the Demonstration Mode will remain. Be sure to manually cancel the timer settings before you use the Dial Timer or any other timer method after reconnecting the mains lead (see page 60).

Recording TV programmes using the ShowView® system (not available on SLV-SE640B and SE240B)

The ShowView system is the feature that simplifies programming the VCR to make timer recordings. Just enter the ShowView number listed in the TV programme guide. The date, times, and programme position of that programme are set automatically. You can preset a total of eight programmes, including settings made with other timer methods.



Before you start...

- Check that the VCR clock is set to the correct time and date.
- Insert a tape with its safety tab in place. Make sure the tape is longer than the total recording time.
- To record from a decoder, turn it on.
- Turn on your TV and set it to the video channel.
- Set OPTIONS PROG. to SHOWVIEW or MIXTE in the FONCTIONS AVANCÉES menu (see page 70).
- Refer to “Index to parts and controls” for button locations.

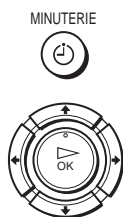
1



Press  MINUTERIE.

- When you set OPTIONS PROG. to MIXTE:
The OPTIONS PROG. menu appears on the TV screen. Press / to select SHOWVIEW, then press OK.

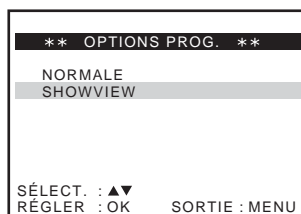

- When you set OPTIONS PROG. to SHOWVIEW:
The SHOWVIEW menu appears on the TV screen.

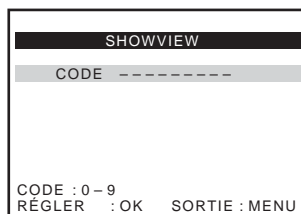

2

Press the programme number buttons to enter the ShowView number.

If you make a mistake, press ANNUL/0 and re-enter the correct number.

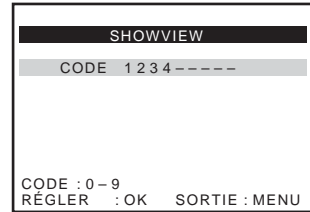
**3**

Press OK.

The date, start and stop times, programme position, tape speed and VPS/PDC setting appear on the TV screen.

CHOIX ENTREE



ANNUL/0



- If “- -” appears in the “ST” (programme) column (this may happen for local broadcasts), you have to set the appropriate programme position manually. Press \uparrow/\downarrow to select the desired programme position.
- To record from a decoder or other source connected to one or more of the LIGNE inputs, press CHOIX ENTREE to display the connected line in the “ST” position.

You will only have to do this operation once for the referred channel. The VCR will then store your setting.

If the information is incorrect, press ANNUL/0 to cancel the setting.

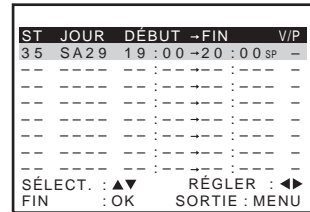
**4**

If you want to change the date, tape speed and the VPS/PDC setting:

- 1 Press \leftarrow/\rightarrow to select the item you want to change.
 - 2 Press \uparrow/\downarrow to reset it.
- To record the same programme every day or the same day every week, see “Daily/weekly recording” on page 50.
 - To use the VPS/PDC function, set V/P to P. For details about the VPS/PDC function, see “Timer recording with VPS/PDC signals” on page 50.

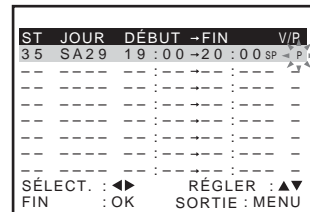
**5**

MENU



Press MENU to exit the menu.

continued

6



Press I/⏻ to turn off the VCR.

The ⊖ indicator appears in the display window and the VCR stands by for recording.

To record from a decoder or other source, leave the connected equipment switched on.

To stop recording

To stop the VCR while recording, press ■ (stop).

Daily/weekly recording

In step 4 above, press ↓ to select the recording pattern. Each time you press ↓, the indication changes as shown below. Press ↑ to change the indication in reverse order.

today → JOUR (Monday to Sunday) → S-SA (every Saturday) → S-DI (every Sunday) → 1 month later → (dates count down) → today

Timer recording with VPS/PDC signals

Some broadcast systems transmit VPS (Video Programme System) or PDC (Programme Delivery Control) signals with their TV programmes. These signals ensure that your timer recordings are made regardless of broadcast delays, early starts, or broadcast interruptions.

To use the VPS/PDC function, set V/P to P in step 4 above. You can also use the VPS/PDC function for a source connected to one or more of the LIGNE inputs.

To use the VCR after setting the timer

To use the VCR before a recording begins, just press I/⏻. The ⊖ indicator turns off and the VCR switches on. Remember to press I/⏻ to reset the VCR to recording standby after using the VCR.

You can also do the following tasks while the VCR is recording:

- Reset the counter (page 37).
- Display tape information on the TV screen (page 40).
- Check the timer settings (page 60).
- Watch another TV programme (page 40).

To use the Auto Tape Speed function

In step 4 above, press ↓ to select AUTO. When you are recording a programme in the SP mode and the remaining tape length becomes shorter than the recording time, the recording tape speed is automatically changed to the LP mode. Note that some noise will appear on the picture when the tape speed is changed. To operate this function correctly, the “SÉLECT.CASSETTE” setting in the RÉGLAGES UTILISATEUR menu must be accurate (see page 69).

Tips

- To set the line input video source, you can also use the CHOIX ENTREE button.
- You can set the extended time for the ShowView setting by 10, 20, 30, 40, 50, or 60 minutes. Set ÉTENDRE SHOWVIEW in the FONCTIONS AVANCÉES menu to the desired extended time on page 70.
- To check, change, or cancel the programme setting, see “Checking/changing/cancelling timer settings” on page 60.

Notes

- If the VPS/PDC signal is too weak or the broadcasting station failed to transmit VPS/PDC signals, the VCR will start recording at the set time without using the VPS/PDC function.
- The ⊖ and ⊕ indicators flash in the display window when you press I/⏪ with no tape inserted.
- When you set OPTIONS PROG. to NORMALE in the FONCTIONS AVANCÉES menu, the SHOWVIEW menu does not appear on the TV screen. Select SHOWVIEW or MIXTE.

Recording TV programmes using the timer

You can preset a total of eight programmes, including settings made with other timer methods.

Before you start...

- Check that the VCR clock is set to the correct time and date.
- Insert a tape with its safety tab in place. Make sure the tape is longer than the total recording time.
- To record from a decoder, turn it on.
- Turn on your TV and set it to the video channel.
- Set OPTIONS PROG.*1 to NORMALE or MIXTE in the FONCTIONS AVANCÉES menu (see page 70).
- Refer to “Index to parts and controls” for button locations.

1

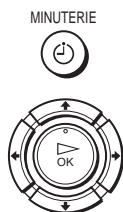

Press  MINUTERIE.

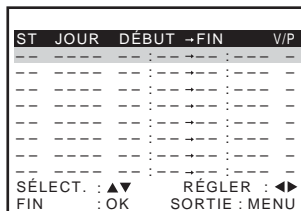

For SLV-SE640B and SE240B

The MINUTERIE menu appears on the TV screen.



For SLV-SE840B and SE740B

- When you set OPTIONS PROG. to MIXTE:

The OPTIONS PROG. menu appears on the TV screen. Press / to select NORMALE, then press OK.

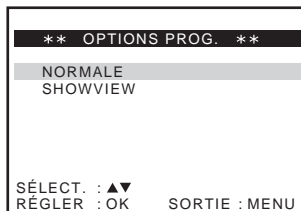

- When you set OPTIONS PROG. to NORMALE:

The MINUTERIE menu appears on the TV screen.

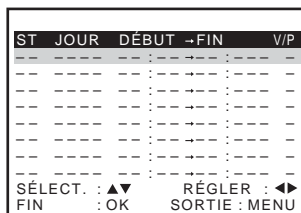

2



Set the date, start and stop times, programme position, tape speed*3 and VPS/PDC function*2:

- 1 Press → to select each item in turn.
- 2 Press ↑/↓ to set each item. To correct a setting, press ← to return to that setting and reset.

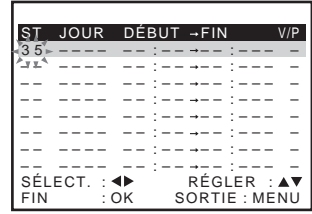

- To record the same programme every day or the same day every week, see “Daily/weekly recording” on page 53.
- To use the VPS/PDC function*2, set V/P to P. For details about the VPS/PDC function, see “Timer recording with VPS/PDC signals” on page 50.
- To record from a decoder or other source connected to one or more of the LIGNE inputs, press CHOIX ENTREE to display the connected line in the “ST” position.

3



Press MENU to exit the menu.

4



Press I/⏻ to turn off the VCR.

The ⊖ indicator appears in the display window and the VCR stands by for recording.

To record from a decoder or other source, leave the connected equipment switched on.

To stop recording

To stop the VCR while recording, press ■ (stop).

Daily/weekly recording

In step 2 above, press ↓ to select the recording pattern. Each time you press ↓, the indication changes as shown below. Press ↑ to change the indication in reverse order.

today → **JOUR (Monday to Sunday)** → **S-SA (every Saturday)** → **S-DI (every Sunday)** → **1 month later** → **(dates count down)** → **today**

continued

To use the VCR after setting the timer

To use the VCR before a recording begins, just press I/⏻. The ⊖ indicator turns off and the VCR switches on. Remember to press I/⏻ to reset the VCR to recording standby after using the VCR.

You can also do the following tasks while the VCR is recording:

- Reset the counter (page 37).
- Display tape information on the TV screen (page 40).
- Check the timer settings (page 60).
- Watch another TV programme (page 40).

To use the Auto Tape Speed function*3

In step 2 above, press ↓ to select AUTO. When you are recording a programme in the SP mode and the remaining tape length becomes shorter than the recording time, the recording tape speed is automatically changed to the LP mode. Note that some noise will appear on the picture when the tape speed is changed. To operate this function correctly, the “SÉLECT.CASSETTE” setting in the RÉGLAGES UTILISATEUR menu must be accurate (see page 69).

Tips

- To set the line input video source, you can also use the CHOIX ENTREE button.
- Even if you set OPTIONS PROG.*1 to SHOWVIEW in the FONCTIONS AVANCÉES menu, you can set the timer manually. Press MENU to select MINUTERIE, then go to step 2.
- To check, change, or cancel the programme setting, see “Checking/changing/cancelling timer settings” on page 60.

Notes

- When setting the timer with VPS/PDC*2 signals, enter the start and stop times exactly as indicated in the TV programme guide. Otherwise, the VPS/PDC function will not work.
- If the VPS/PDC*2 signal is too weak or the broadcasting station failed to transmit VPS/PDC signals, the VCR will start recording at the set time without using the VPS/PDC function.
- The ⊖ and ⊕ indicators flash in the display window when you press I/⏻ with no tape inserted.
- The VPS/PDC function*2 is automatically set to off for the timer recording of a satellite programme.

*1 not available on SLV-SE640B/SE240B

*2 not available on SLV-SE640B

*3 not available on SLV-SE240B

Playing/searching at various speeds

Before you start...

- Refer to “Index to parts and controls” for button locations.

Playback options

To	Do this
View the picture during fast-forward or rewind	During fast-forward, hold down ►► (fast-forward). During rewind, hold down ◀◀ (rewind).
Play at high speed	<ul style="list-style-type: none"> • During playback, briefly press ►► (fast-forward) or ◀◀ (rewind). The tape continues to play at high speed. • During playback, hold down ►► (fast-forward) or ◀◀ (rewind). When you release the button, normal playback resumes.
Play at twice the normal speed	During playback, press ×2.
Play in slow motion	During playback, press ►▶ RALENTI.

To resume normal playback

Press ▷ (play).

Using Playback Dial on the VCR

With Playback Dial, you can operate the following playback options.

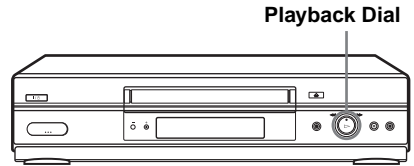

To	Do this
View the picture during fast-forward or rewind	During fast-forward, turn and hold Playback Dial to the right (▶▶ (fast-forward)). During rewind, turn and hold Playback Dial to the left (◀◀ (rewind)).
Play at high speed	<ul style="list-style-type: none"> • During playback, quickly turn and release Playback Dial to the right (▶▶ (fast-forward)) or left (◀◀ (rewind)). The tape continues to play at high speed. • During playback, turn and hold Playback Dial to the right (▶▶ (fast-forward)) or left (◀◀ (rewind)). When you release Playback Dial, normal playback resumes.

Tip

- Adjust the picture using the CHAINE +/- buttons on the VCR if:
 - Streaks appear while playing in slow motion.
 - Bands appear at the top or bottom while pausing.
 - The picture shakes while pausing.
 To set tracking to the centre position, press both buttons (+/-) at the same time.

Notes

- The sound is muted during these operations.
- In the LP mode, noise may appear or there may be no colour.
- If the playback mode mark does not appear on the TV screen, press **[i+] AFFICH.**
- The picture may show noise when playing at high speed in reverse.
- Do not turn Playback Dial forcibly. It may damage Playback Dial.

Setting the recording duration time

After you have started recording in the normal way, you can have the VCR stop recording automatically after a specified duration.

Before you start...

- Refer to “Index to parts and controls” for button locations.

1 While recording, press ● ENR.

The ⊖ indicator appears in the display window.

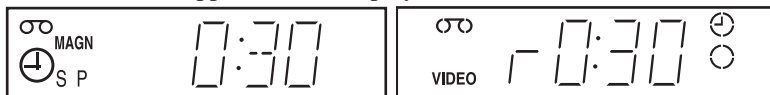

2 Press ● ENR repeatedly to set the duration time.

In SP mode

Each press advances the time in increments of 30 minutes.

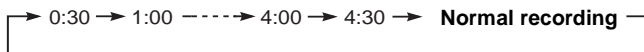

In LP mode

Each press advances the time as shown below.

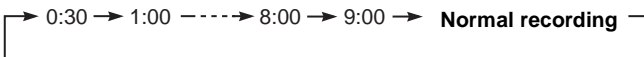

The tape counter decreases minute by minute to 0:00, then the VCR stops recording and turns off automatically.

To extend the duration

Press ● ENR repeatedly to set a new duration time.

To cancel the duration

Press ● ENR repeatedly until the ⊖ indicator disappears and the VCR returns to the normal recording mode.

To stop recording

To stop the VCR while recording, press ■ (stop).

Note

- You cannot display the current tape time in the display window when setting the recording duration time.

Synchronized Recording

(not available on SLV-SE640B and SE240B)

You can set the VCR to automatically record programmes from equipment such as a satellite tuner by connecting the equipment to the LIGNE-3 (DEC/EXT)*¹ (or LIGNE-2 (DEC/EXT)*²) connector. The connected equipment must have a timer function for this feature to work.

When the connected equipment turns on, the VCR also automatically turns on and starts recording a programme from LIGNE-3 (DEC/EXT)*¹ (or LIGNE-2 (DEC/EXT)*²).

How to connect for Synchronized Recording

Connect the LIGNE-3 (DEC/EXT)*¹ (or LIGNE-2 (DEC/EXT)*²) connector of the VCR to the TV Scart connector of the satellite tuner. Then connect the LIGNE-1 (EURO AV) connector to the TV.

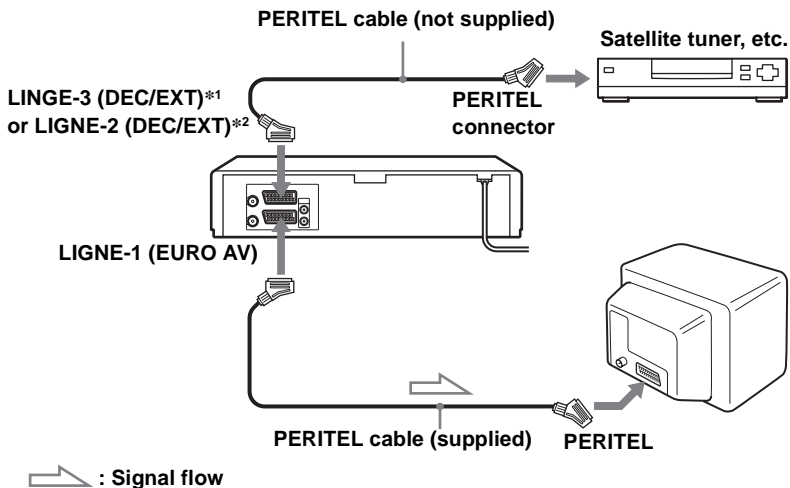

Recording programmes using the Synchronized Recording function

Before you start...

- Insert a tape with its safety tab in place. Make sure the tape is longer than the total recording time.
- Refer to “Index to parts and controls” for button locations.

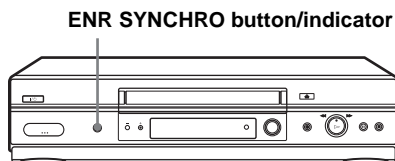

- 1** Press CHOIX ENTREE or CHAINE +/- to display “L3*1 (or L2*2)” in the display window.
- 2** Set the timer on the connected equipment to the time of the programme you want to record, then turn it off.
- 3** Press SP/LP to select the tape speed.
- 4** Hold down ENR SYNCHRO on the VCR for more than two seconds. The ENR SYNCHRO indicator lights up in red and the VCR stands by for recording.

The VCR automatically turns on and starts recording when it receives an input signal from the connected equipment.

The VCR automatically stops recording when the tape reaches the end or when the connected equipment stops transmitting an input signal.

To cancel the Synchronized Recording function

Press ENR SYNCHRO on the VCR. The ENR SYNCHRO indicator disappears.

To stop recording

Press ■ (stop) while recording.

Notes

- This function may not work with some types of satellite tuners.
- Some TVs or other equipment with timer functions will automatically turn off if no operation is performed within a certain amount of time. In this case, the Synchronized Recording also stops automatically.
- When the connected equipment turns on while the ENR SYNCHRO indicator lights up in red, recording starts automatically.
- If the settings for timer recording and Synchronized Recording overlap, the programme that starts first has priority and the second programme starts recording only after the first programme has finished.
- The Auto Clock Set function does not work while the VCR stands by for Synchronized Recording.

*1 SLV-SE840B

*2 SLV-SE740B, SE640B and SE240B

When the timer settings overlap

The programme that starts first has priority and the second programme starts recording only after the first programme has finished. If the programmes start at the same time, the programme listed first in the menu has priority.

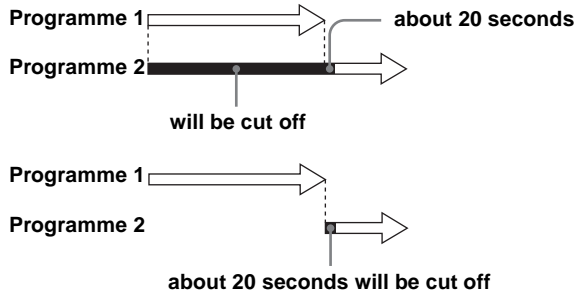

Recording stereo and bilingual programmes (not available on SLV-SE240B)

In the ZWEITON (German stereo) system

This VCR automatically receives and records stereo and bilingual programmes based on the ZWEITON system. When a stereo or bilingual programme is received, the STEREO indicator appears in the display window.

To select bilingual sound while recording

Press CHOIX SON to select the sound you want.

To listen to	On-screen display	Display window
Main	PRINCIPALE	STEREO
Sub	SECONDAIRE	STEREO
Main and sub	PRINCIP./SEC.	STEREO
Standard sound*	MONO	STEREO

* Usually the main channel heard from both the left and right in bilingual programmes

To select stereo programme while recording

To listen to	On-screen display	Display window
Stereo	STEREO	STEREO
Left channel	CANAL G	STEREO
Right channel	CANAL D	STEREO
Standard sound*	CANAL G + CANAL D	STEREO

* Usually the mixed sound of left and right channels in stereo programmes

In the NICAM system

This VCR receives and records stereo and bilingual programmes based on the NICAM system (NICAM appears on the TV screen). When a stereo or bilingual programme is received, the STEREO indicator appears in the display window.

To record a NICAM programme, NICAM in the RÉGLAGES UTILISATEUR menu should be set to OUI (initial setting). To check the menu setting, see page 70 for details.

To select the sound while recording

Press CHOIX SON to select the sound you want.

Stereo programmes

To listen to	On-screen display	Display window
Stereo	NICAM, STEREO	STEREO
Left channel	NICAM, CANAL G	STEREO
Right channel	NICAM, CANAL D	STEREO
Left and right channels*	NICAM, CANAL G + CANAL D	STEREO

* Usually the mixed sound of left and right channels

Bilingual programmes

To listen to	On-screen display	Display window
Main	NICAM, PRINCIPALE	STEREO
Sub	NICAM, SECONDAIRE	STEREO
Main and sub	NICAM, PRINCIP./SEC.	STEREO
Standard sound*	NICAM, MONO	STEREO

* Usually the main sound (monaural)

Selecting the sound during Hi-fi playback

Press CHOIX SON to select the sound you want.

To listen to	On-screen display	Display window
Stereo	STEREO	STEREO
Left channel	CANAL G	STEREO
Right channel	CANAL D	STEREO
Mix sound*	MIX	STEREO
Mono sound	MONO	No indicator

* The mixed sound of left and right channels, and the normal mono audio track

continued

How sound is recorded on a video tape

The VCR records sound onto two separate tracks. Hi-fi audio is recorded onto the main track along with the picture. Monaural sound is recorded onto the normal audio track along the edge of the tape.

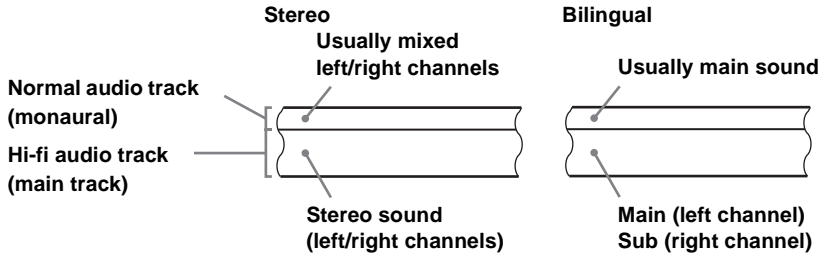

Notes

- To listen to playback sounds in stereo, you must use the PERITEL or SORTIE AUDIO connections.
- When you play a tape recorded in monaural, the sound is heard in monaural regardless of the CHOIX SON setting.

Searching using the index function (not available on SLV-SE240B)

The VCR automatically marks the tape with an index signal at the point where each recording begins. Use these signals as references to find a specific recording.

To find a specific recording by scanning (Index scan)

- 1 Insert an indexed tape into the VCR.
- 2 Press **◀◀/▶▶** (index search). The VCR starts scanning each recording for five seconds in the corresponding direction.



INDEX BALAYAGE : ▶▶

- 3 Press **▷** (play) to start playback when you find the desired point.

To search a specific recording (Index search)

- 1 Insert an indexed tape into the VCR.
- 2 Press **◀◀/▶▶** (index search) twice.
 - To search ahead, press **▶▶** (index search) twice.
 - To search backwards, press **◀◀** (index search) twice.



INDEX RECHERCHE : ▶▶ +02

- 3 Press **◀◀/▶▶** (index search) depending on the direction where your desired programme is located.

Each time you press the button, the number increases or decreases up to ± 20 , respectively.

- 4 The VCR starts searching, and playback starts automatically from that point.

To stop searching

Press **■** (stop).

Notes

- No index signal will be added when recording starts from recording pause. However, an index signal will be marked if you change the programme position during recording pause.
- When you press I◀◀ (index search), if there is nothing recorded before the selected index signal, playback may not start exactly at the index signal.

Adjusting the picture

Adjusting the tracking

Although the VCR automatically adjusts the tracking when playing a tape, distortion may occur if the recording is in poor condition. In this case, manually adjust the tracking.

During playback, press CHAINE +/- on the VCR to display the tracking meter. The distortion should disappear as you press one of the two buttons. To resume automatic tracking adjustments, eject the tape and re-insert it.

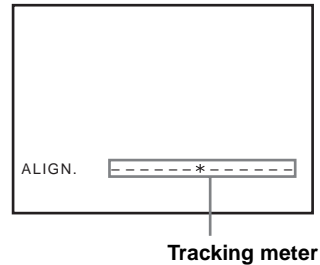

Adjusting the picture sharpness (Smart trilogic)

You can automatically adjust the sharpness of the picture.

1 During playback, press MENU, then press $\uparrow/\downarrow/\leftarrow/\rightarrow$ to highlight RÉGLAGES UTILISATEUR and press OK.

2 Press \uparrow/\downarrow to highlight SMART TRILOGIC, then press \rightarrow .

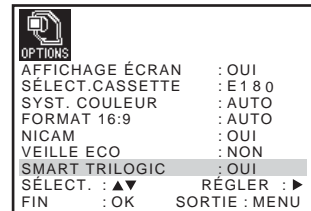

3 Press \uparrow/\downarrow to set SMART TRILOGIC to OUI or NON.

- OUI: Picture sharpness is automatically adjusted.
- NON: Adjust the picture sharpness manually.
To soften the picture, press \leftarrow .
To sharpen the picture, press \rightarrow .

4 Press MENU to return to the original screen.

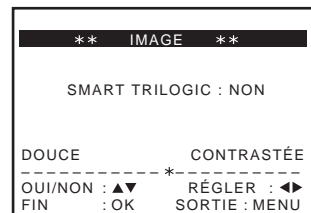

Reducing the VCR's power consumption

You can turn off the indicators in the display window when the VCR is off (standby mode) to reduce the VCR's power consumption.

- 1 Press MENU, then press **↑/↓/←/→** to highlight RÉGLAGES UTILISATEUR and press OK.
- 2 Press **↑/↓** to highlight VEILLE ECO.
- 3 Press **→** to set to ECO1 or ECO2, then press OK.
 - ECO1: To reduce the power consumption.
 - ECO2: To reduce the power consumption to a minimum.

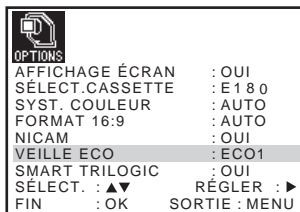

To turn on the indicators in the display window

Set VEILLE ECO to NON in step 3.

Notes

- When the VCR stands by for recording, the \odot indicator in the display window remains lit even when VEILLE ECO is set to ECO1 or ECO2.
- The Line Through function will not operate properly if VEILLE ECO is set to ECO2. Set VEILLE ECO to NON or ECO1 to ensure proper operation.

Changing menu options

- 1 Press MENU, then select RÉGLAGES UTILISATEUR or FONCTIONS AVANCÉES and press OK.

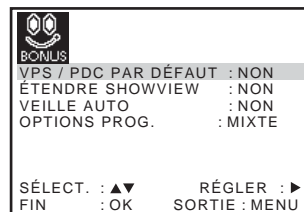
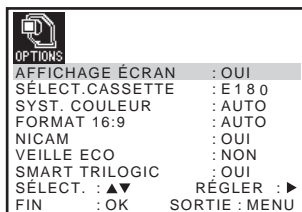

- 2 Press ↑/↓ to select the option.
- 3 Press → to change the setting, then press OK.

Menu choices

Initial settings are indicated in bold print.



RÉGLAGES UTILISATEUR

Menu option	Set this option to
AFFICHAGE ÉCRAN	<ul style="list-style-type: none"> • OUI to display the menu on the TV screen. • NON to disappear the menu from the TV screen.
SÉLECT.CASSETTE	<ul style="list-style-type: none"> • E180 to use an E-180 or shorter type tape. • E240 to use an E-240 type tape. • E260 to use an E-260 type tape. • E300 to use an E-300 type tape.
SYST. COULEUR	<ul style="list-style-type: none"> • AUTO to select the colour system automatically. • PAL to use the tape recorded in the PAL colour system. • SECAM to use the tape recorded in the SECAM colour system. • MESECAM to use the tape recorded in the MESECAM colour system. • N/B to use the tape recorded in black and white.
FORMAT 16:9	<ul style="list-style-type: none"> • AUTO when you use a wide screen TV. The VCR automatically detects if programmes being played back or recorded are in normal or wide screen format. • OUI if the VCR cannot detect wide screen TV programmes with AUTO. The VCR always plays back and records in wide screen format. • NON if you are not using a wide screen TV.

continued

Menu option	Set this option to
NICAM*1	<ul style="list-style-type: none"> • OUI to record NICAM broadcasts on the hi-fi audio track. • NON to record standard sound on the hi-fi audio track. For details, see page 62.
VEILLE ECO	<ul style="list-style-type: none"> • ECO1 to turn off the indicators in the display window to conserve the VCR's power. • ECO2 to turn off the indicators in the display window during standby mode to reduce the VCR's power consumption to a minimum. For using the Line Through function and Canal Plus function, select ECO1 or OFF. • NON to turn on the indicators in the display window while the VCR is standing by.
SMART TRILOGIC	<ul style="list-style-type: none"> • OUI to automatically adjust the sharpness of the picture. • NON to manually adjust the sharpness of the picture.

FONCTIONS AVANCÉES

Menu option	Set this option to
VPS/PDC PAR DÉFAUT*2	<ul style="list-style-type: none"> • NON to deactivate the VPS/PDC function. • OUI to activate it.
ÉTENDRE SHOWVIEW*3	<ul style="list-style-type: none"> • NON to deactivate the ShowView Extend function. • 10/20/30/.../60 (minutes) to extend the time of the ShowView setting by the selected amount of time.
VEILLE AUTO	<ul style="list-style-type: none"> • NON to deactivate the Auto Power Off function. • 2HEURES/3HEURES to turn the VCR off automatically if no signal is received and you do not press any of the buttons during this time.
OPTIONS PROG.*3	<ul style="list-style-type: none"> • MIXTE to display the OPTIONS PROG. menu for selecting NORMALE or SHOWVIEW when pressing the  MINUTERIE button. • NORMALE to display the MINUTERIE menu when pressing the  MINUTERIE button. • SHOWVIEW to display the SHOWVIEW menu when pressing the  MINUTERIE button. For details, see pages 48 and 52.

*1 not available on SLV-SE240B

*2 not available on SLV-SE640B

*3 not available on SLV-SE640B and SE240B

Connecting to a VCR or stereo system

How to connect to record on this VCR

Connect the line outputs of the other VCR to the input connector of this VCR. Refer to the examples A through C and choose the connection that best suits your VCR.

Example A

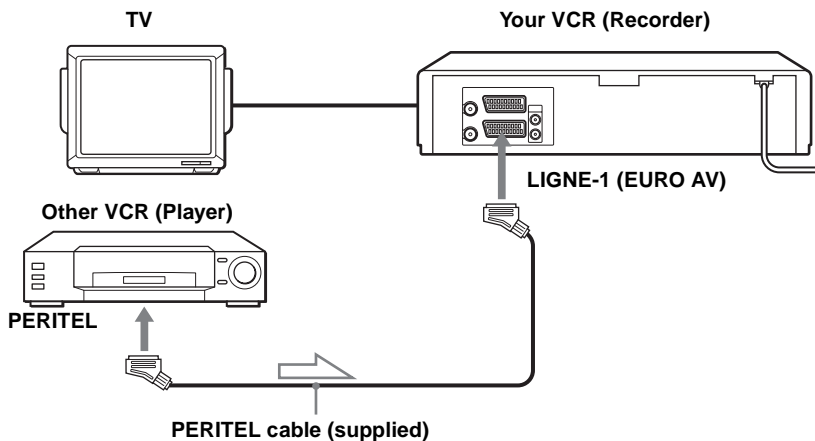

 : Signal flow

Example B (SLV-SE840B only)

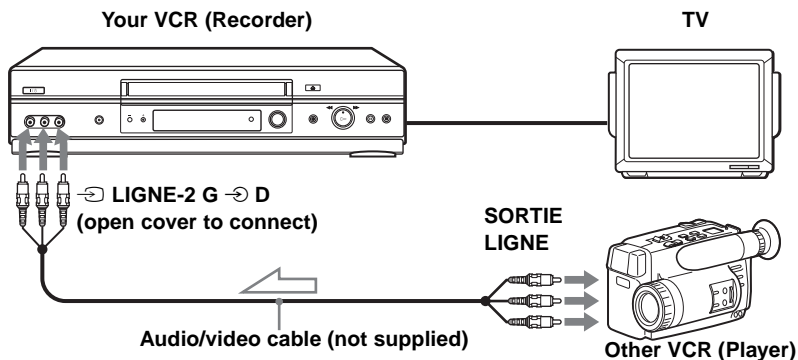

 : Signal flow

continued

Example C

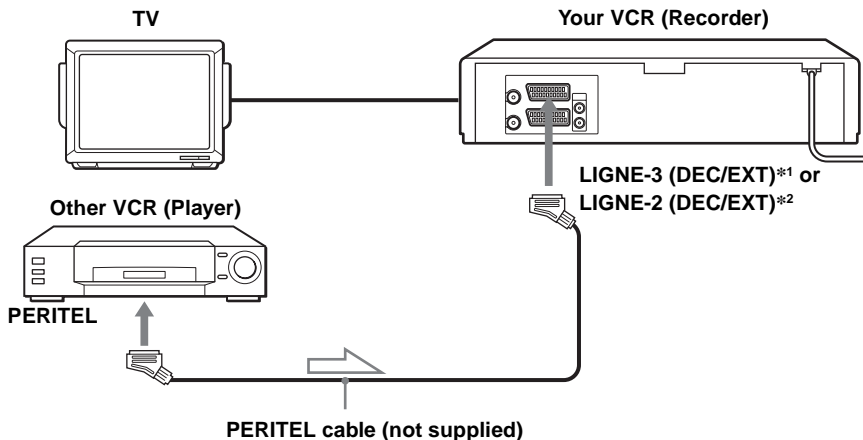

 : Signal flow

How to connect to a stereo system (SLV-SE840B only)

Connect the \ominus LIGNE-2 G \rightarrow D jacks on this VCR to the audio output jacks on the stereo system, using an audio cable (not supplied).

Notes

- Make sure you connect the plugs to jacks of the same colour.
- If the other VCR is a monaural type, leave the red plugs unconnected.
- If you connect this VCR to both the ENTREE LIGNE and SORTIE LIGNE jacks of the other VCR, select the input correctly to prevent a humming noise.
- If the other VCR does not have a PERITEL connector, use an adequate cable instead and connect the cable to the line out jacks of the other VCR.
- When you connect another VCR to the LIGNE-3 (DEC/EXT)*¹ or LIGNE-2 (DEC/EXT)*² connector, press CHOIX ENTREE to display “L3”*¹ or “L2”*² in the display window.

*¹ SLV-SE840B

*² SLV-SE740B, SE640B and SE240B

Basic editing

When recording on this VCR

Before you start editing

- Turn on your TV and set it to the video channel.
- Press CHOIX ENTREE to display the connected line in the display window.
- Press SP/LP to select the tape speed, SP or LP.*

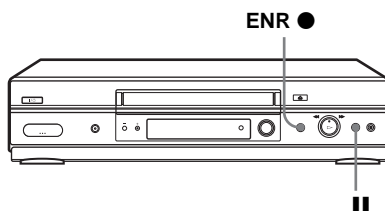

- 1** Insert a source tape with its safety tab removed into the other (playback) VCR. Search for the point to start playback and set it to playback pause.
- 2** Insert a tape with its safety tab in place into this (recording) VCR. Search for the point to start recording and press **||** (pause) to set it to playback pause.
- 3** Press ENR ● on this VCR to set it to recording pause.
- 4** To start editing, press the **||** (pause) buttons on both VCRs at the same time.

To stop editing

Press the **■** (stop) buttons on both VCRs.

Tip

- To cut out unwanted scenes while editing, press **||** (pause) on this VCR when an unwanted scene begins. When it ends, press **||** (pause) again to resume recording.



* not available on SLV-SE240B

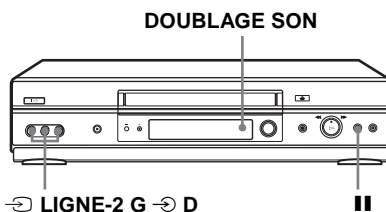

Audio dubbing (SLV-SE840B only)

This feature lets you record over the normal audio track. The monaural sound previously recorded is replaced while the original hi-fi sound remains unchanged. Use this feature to add commentary to a tape that you have recorded with a camcorder.



Before you start...

- Open the  LIGNE-2 G  D jacks cover on the front panel and connect a playback source.
- Turn on the TV and set it to the video channel.

- 1** Insert a source tape into your stereo system (or the playback VCR). Search for the point to start playback and set it to playback pause.
- 2** Insert a prerecorded tape with its safety tab in place into this (recording) VCR. Search for the start of the section to be replaced and press  (pause).
The VCR enters pause mode.
- 3** Press DOUBLAGE SON.
“A_DUB” and the  indicator appears in the display window.
- 4** To start editing, press the  (pause) buttons on this VCR and the stereo system (or other VCR) at the same time.
After you use this feature, the audio in playback mode is automatically set to monaural.

To stop editing

Press  (stop) on this VCR and the stereo system (or other VCR).

Troubleshooting

If you have any questions or problems not covered below, please consult your nearest Sony service facility.

	Symptom	Remedy
Power	The I/⏻ (on/standby) switch does not function.	<ul style="list-style-type: none"> Connect the mains lead to the mains securely.
	The power is turned on but the VCR does not operate.	<ul style="list-style-type: none"> Moisture condensation has occurred. Turn the power off, unplug the mains lead and leave the VCR to dry for over three hours.
	The VCR is plugged in but the display window remains dark.	<ul style="list-style-type: none"> Set VEILLE ECO in the RÉGLAGES UTILISATEUR menu to NON (see page 68).
Clock	The clock has stopped and “- -: -” appears in the display window.	<ul style="list-style-type: none"> The clock stops if the VCR is disconnected from the mains. Reset the clock (and timer).
Playback	The playback picture does not appear on the TV screen.	<ul style="list-style-type: none"> Make sure the TV is set to the video channel. If you are using a monitor, set it to video input. If the VCR is connected to the TV with the PERITEL cable, make sure the MAGN or VIDEO indicator is lit in the display window. Use the  TV/MAGN button on the remote commander to light up the MAGN or VIDEO indicator.
	The picture is not clear.	<ul style="list-style-type: none"> Adjust the tracking with the CHAINE +/- buttons <u>on the VCR</u>. The video heads are dirty (see the last page of Troubleshooting). Clean the video heads using a Sony video head cleaning cassette. If a Sony cleaning cassette is not available in your area, have the heads cleaned at your nearest Sony service facility (a standard service charge will be required). Do not use a commercially available liquid type cleaning cassette other than Sony's, as it may damage the video heads. The video heads may have to be replaced. Consult your local Sony service facility for more information.
	The picture has no colour.	<ul style="list-style-type: none"> The SYST. COULEUR option in the RÉGLAGES UTILISATEUR menu is set to the wrong position. Set the option to conform to the system that the tape was recorded in.

	Symptom	Remedy
Playback	The picture rolls vertically during picture search.	<ul style="list-style-type: none"> Adjust the vertical hold control on the TV or monitor.
	The picture has no sound.	<ul style="list-style-type: none"> The tape is defective. If you made A/V connections, check the audio cable connection.
	The sound from a tape recorded with the VCR is not in stereo or the STEREO indicator in the display window is flashing.	<ul style="list-style-type: none"> Adjust the tracking. The video heads are dirty. Clean the video heads using a Sony video head cleaning cassette as explained above.
Recording	No TV programme appears on the TV screen.	<ul style="list-style-type: none"> Make sure the TV is set to the video channel. If you are using a monitor, set it to video input. Select the correct source with the CHOIX ENTREE button. Select a programme position when recording TV programmes; select a line input when recording from other equipment.
	TV reception is poor.	<ul style="list-style-type: none"> Make sure the aerial cable is connected securely. Adjust the TV aerial. Make sure SYS. (L/L' or B/G) in the RECHERCHE MANUELLE menu is set to the same system in your local area.
	The tape starts playing as soon as it is inserted.	<ul style="list-style-type: none"> The safety tab has been removed. To record on this tape, cover the tab hole (see page 41).
	The tape is ejected when you press ● ENR.	<ul style="list-style-type: none"> The safety tab has been removed. To record on this tape, cover the tab hole (see page 41).
	Nothing happens when you press ● ENR.	<ul style="list-style-type: none"> Make sure the tape is not at its end.
Timer recording	The timer does not operate.	<ul style="list-style-type: none"> Check that the clock is set. Make sure a tape has been inserted. Check that the safety tab has not been removed. Make sure the tape is not at its end. Make sure a programme has been set for timer recording. Make sure your timer settings are past the current time. Check that the decoder is turned on. Check that the satellite tuner is turned on. The clock stops if the VCR is disconnected from the mains for more than one hour. Reset the clock and timer. Turn the power off and unplug the mains lead.

	Symptom	Remedy
Timer recording	The SHOWVIEW menu or the MINUTERIE menu does not appear.	<ul style="list-style-type: none"> • Check that OPTIONS PROG. in the FONCTIONS AVANÇÉES menu is set correctly (see page 70).
	The VPS/PDC function does not operate properly.	<ul style="list-style-type: none"> • Check that the clock and the date are set correctly. • Check that the VPS/PDC time you set is the correct one (there might be a mistake in the TV programme guide). If the broadcast you wanted to record did not send the good VPS/PDC information, the VCR will not start recording. • If the reception is poor, the VPS/PDC signal might be altered and the VCR might not start recording.
Synchronized Recording	The ENR SYNCHRO button turns off while recording or does not go back to recording standby mode.	<ul style="list-style-type: none"> • The tape has reached its end. Insert a new tape and press ENR SYNCHRO again.
	The Synchronized Recording function does not work.	<ul style="list-style-type: none"> • The connected equipment was not turned off. Turn off the connected equipment and press ENR SYNCHRO again. • There was a power failure. Press ENR SYNCHRO again.
	The programme recorded with the Synchronized Recording function is incomplete.	<ul style="list-style-type: none"> • If the settings for timer recordings and Synchronized Recording overlap, the programme that starts first has priority and the second programme starts recording only after the first programme has finished. • There was a power failure. Press ENR SYNCHRO again.
Canal Plus	You cannot watch Canal Plus programmes when the VCR is in standby mode.	<ul style="list-style-type: none"> • Check that DEC is set to OUI for this channel in the LISTE STATIONS TV menu. • Make sure the Canal Plus PERITEL cable is plugged securely.
	A Canal Plus programme is always recorded scrambled.	<ul style="list-style-type: none"> • Make sure the Canal Plus PERITEL cable is plugged securely. • Check that DEC is set to OUI for this channel in the LISTE STATIONS TV menu.

	Symptom	Remedy
Others	A tape cannot be inserted.	<ul style="list-style-type: none"> • Check that a tape is not already in the tape compartment.
	The remote commander does not function.	<ul style="list-style-type: none"> • Make sure you are pointing the remote commander at the remote sensor on the VCR. • Replace all the batteries in the remote commander with new ones if they are weak. • Make sure the TV / MAGN remote control switch is set correctly.
	The selected input line connector number does not appear in the display window.	<ul style="list-style-type: none"> • Press CHOIX ENTREE to display the connected line.
	The tracking meter does not appear on the TV screen.	<ul style="list-style-type: none"> • The recording condition of the tape is very poor and tracking cannot be adjusted.
	You cannot control other TVs.	<ul style="list-style-type: none"> • Set your TV's code number. The code number may change when you replace the batteries of the remote commander.
	The display window becomes dim.	<ul style="list-style-type: none"> • The display window automatically becomes dim when the VCR is in standby or timer recording mode.
	The VCR needs to be cleaned.	<ul style="list-style-type: none"> • Clean the cabinet, panel and controls with a dry, soft cloth, or a soft cloth slightly moistened with a mild detergent solution. Do not use any type of solvent, such as alcohol or benzine.
	The Line Through function does not operate.	<ul style="list-style-type: none"> • Set VEILLE ECO in the RÉGLAGES UTILISATEUR menu to NON (see page 68).

Symptoms caused by contaminated video heads

• Normal picture



• Rough picture



initial
contamination

• Unclear picture



• No picture (or black & white screen appears)

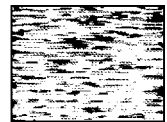

terminal



Specifications

System

Channel coverage

SECAM (L):

VHF F2 to F10

UHF F21 to F69

CATV B to Q

HYPER S21 to S41

PAL (B/G):

VHF E2 to E12

VHF Italian channel A to H

UHF E21 to E69

CATV S01 to S05, S1 to S20

HYPER S21 to S41

Aerial out

75-ohm asymmetrical aerial socket

Tape speed

SP: PAL 23.39 mm/s (recording/
playback)

NTSC 33.35 mm/s (playback only)

SECAM

23.39 mm/s (recording/
playback)

MESECAM

23.39 mm/s (playback only)

LP: PAL 11.70 mm/s (recording/
playback)*

NTSC 16.67 mm/s (playback only)

SECAM

11.70 mm/s (recording/
playback)

MESECAM

1.70 mm/s (playback only)

EP: NTSC 11.12 mm/s (playback only)*

Maximum recording/playback time

10 hrs. in LP mode (with E300 tape)

Rewind time

Approx. 1 min. (with E180 tape)

* not available on SLV-SE240B

Inputs and outputs

LIGNE-1 (EURO AV)

21-pin

Video input: pin 20

Audio input: pins 2 and 6

Video output: pin 19

Audio output: pins 1 and 3

LIGNE-2 (DEC/EXT)/LIGNE-3 (DEC/
EXT)

21-pin

Video input: pin 20

Audio input: pins 2 and 6

↻ LIGNE-2 G ↻ D*1

VIDEO IN, phono jack (1)

Input signal: 1 Vp-p, 75 ohms,
unbalanced, sync negative

AUDIO IN, phono jack (2)

Input level: 327 mVrms

Input impedance: more than 47 kilohms

AUDIO (OUT/SORTIE) R/D L/G*2

Phono jack (2)

Rated output level: 327 mVrms

Load impedance: 47 kilohms

Output impedance: less than 10 kilohms

*1 SLV-SE840B only

*2 not available on SLV-SE640B and SE240B

General

Power requirements

220 – 240 V AC, 50 Hz

Power consumption

- SLV-SE240B

15 W

1.2 W (VEILLE ECO is set to ECO2,
minimum)

- SLV-SE640B

17 W

1.2 W (VEILLE ECO is set to ECO2,
minimum)

- SLV-SE840B, SE740B

17 W

1.3 W (VEILLE ECO is set to ECO2,
minimum)

Operating temperature

5° C to 40° C

Storage temperature

-20° C to 60° C

Dimensions including projecting parts and controls (w/h/d)

Approx. 360 × 95 × 255 mm

(SLV-SE240B)

Approx. 430 × 96 × 255 mm

(SLV-SE840B, SE740B and SE640B)

Mass

Approx. 2.8 kg (SLV-SE240B)

Approx. 3.1 kg (SLV-SE840B, SE740B
and SE640B)

Supplied accessories

Remote commander (1)

R6 (size AA) batteries (2)

Aerial cable (1)

PERITEL cable (1)

Design and specifications are subject to
change without notice.

Index

A

- Adjusting
 - picture 67
 - tracking 67
- Aerial hookup 16
- Audio dubbing 74
- Audio monitor 63
- Audio track 64
- Auto Clock Set 19
- Auto Set Up 19

C

- Canal Plus 33
- Changing the programme position 28
- Changing the station name 31
- Cleaning the video heads 75
- Clock setting 21
- Colour system
 - compatible colour systems 2
 - setting 37
- Connecting
 - the VCR and your TV 16
 - to a stereo system 18, 71
 - to a TV with a PERITEL connector 16
 - to digital tuner 18
 - to satellite tuner 18
- Counter 37
- Country selection 19

D

- Demonstration 47
- Dial Timer 43
- Disabling the programme positions 29
- Dubbing. *see* Editing

E

- Editing 71

H

- Hi-fi audio track 64

I

- Index scan 65
- Index search 65

L

- Language selection 24
- LP mode 39

M

- Manual fine tuning 27
- Monaural 63

N

- NICAM broadcasts 62
- Normal audio track 64

O

- Optional setting 69

P

- PDC (Programme Delivery Control) 50
- PERITEL connection 16
- Playback 36
 - at various speeds 55
 - selecting the sound 63
 - slow motion 55
- Power save 68
- Preset download 23
- Presetting channels 25

R

- Recording 39
 - bilingual programmes 62
 - duration time 57
 - saving 41
 - stereo programmes 62
 - timer setting 52
 - using the Dial Timer 43
 - using the ShowView system 48
 - what you are watching on the TV 42
 - while watching another programme 40

S

- Safety tab 41
- Searching
 - at various speeds 55
 - using the index function 65
- ShowView
 - recording 48
- Smart trilogic 67
- SMARTLINK
 - NexTVView Download 17
 - One Touch Menu 17
 - One Touch Play 17, 38
 - One Touch Timer 17
 - TV Direct Rec 17, 42
- SP mode 39
- Stereo 62
- Synchronized Recording 59

T

- Timer setting 52
 - cancelling 60
 - changing 60
 - checking 60
 - daily/weekly recording 50, 53
 - using the Dial Timer 43
 - using the ShowView system 48

V

- VPS (Video Programme System) 50

W

- Wide screen format 69

Z

- ZWEITON broadcasts 62

Quick Start Guide

1 Connecting the VCR

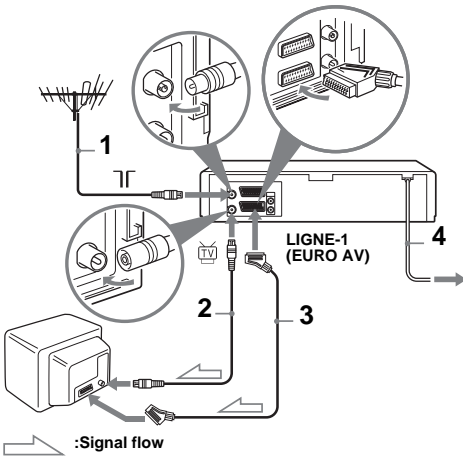

- 1 ... Connect the aerial to Γ of the VCR.
- 2 ... Connect TV and the aerial input of your TV using the supplied aerial cable.
- 3 ... For better picture and sound, connect LIGNE-1 (EURO AV) to your TV using a PERITEL cable.
- 4 ... Connect the mains lead to the mains.

2 Using the Auto Set Up function

- 1 ... Turn on your TV and set it to the video channel.
- 2 ... Connect the mains lead to the mains.
- 3 ... Press OK.
- 4 ... Press \leftarrow/\rightarrow to select your country, then press OK (not available on SLV-SE640B).

When all of the receivable channels are preset, the menu disappears from the TV screen. You can rearrange the programme position in any order (see "Changing/disabling programme positions").

3 Setting the clock

- 1 ... Press MENU, then press $\uparrow/\downarrow/\leftarrow/\rightarrow$ to highlight RÉGLAGE HORLOGE and press OK.
- 2 ... Press \uparrow/\downarrow to set the hour, then press \rightarrow .
- 3 ... Press \uparrow/\downarrow to set the minutes. Set the day, month, and year in sequence by pressing \rightarrow to select the item to be set, and press \uparrow/\downarrow to select the digits, then press OK.
- 4 ... Press MENU.

Now you can operate your VCR.