

SONY®

4-470-897-11(1)

LCD TV

Operating Instructions

Introducing Your New
BRAVIA®

Getting Started

Operating the TV

Using Features

Using the Menus

Other Information

Sony Customer Support

U.S.A.: <http://www.sony.com/tvsupport>

Canada: <http://www.sony.ca/support>

United States

1.800.222.SONY

Canada

1.877.899.SONY

Please Do Not Return
the Product to the Store

BRAVIA

KDL-50R450A

Owner's Record

The model and serial numbers are located at the side and rear of the TV. Record these numbers in the spaces provided below. Refer to them whenever you call upon your Sony dealer regarding this TV.

Model Name

Serial No.

CAUTION

To prevent electric shock and blade exposure, do not use this polarized AC plug with an extension cord, receptacle or other outlet unless the blades can be fully inserted.

- Operate the TV only on 110-240 V AC (USA/Canada 120 V AC).
- Avoid operating the TV at temperatures below 41°F (5°C).

Licensing Information

MHL, Mobile High-Definition Link and the MHL Logo are trademarks or registered trademarks of MHL Licensing, LLC.

HDMI, the HDMI logo, and High-Definition Multimedia Interface are trademarks or registered trademarks of HDMI Licensing, LLC in the United States and other countries.

Ferguson Patent Properties, LLC:

U.S. Patent No. 5,717,422

U.S. Patent No. 6,816,141

Manufactured under license from Dolby Laboratories.

Blu-ray Disc is a trademark.

"BRAVIA" and BRAVIA, BRAVIA Sync, and  are trademarks or registered marks of Sony Corporation.

"PlayStation" is a registered trademark and "PS3" is a trademark of Sony Computer Entertainment Inc.

Cleaning

When cleaning, be sure to unplug the power cord to avoid any chance of electric shock.

- Wipe the LCD screen gently with a soft cloth.
- Stubborn stains may be removed with a cloth slightly moistened with a solution of mild soap and warm water.
- If using a chemically pretreated cloth, please follow the instruction provided on the package.
- Never use strong solvents such as a thinner, alcohol or benzene for cleaning.
- See the supplied Safety Booklet for additional information.

Your BRAVIA TV is ENERGY STAR® qualified in the "Home" mode. It meets strict energy efficiency guidelines set by the U.S. Environmental Protection Agency and Department of Energy.



ENERGY STAR is a joint program of these government agencies, designed to promote energy efficient products and practices. Changes to certain features, settings, and functionalities of this TV (i.e. Picture/Sound, Light Sensor, Power Savings, Picture Scene) can increase or change the power consumption. The Auto and General picture scenes are default settings optimized for the input signal selected. Your BRAVIA TV is tested in these settings for ENERGY STAR qualification. Depending upon such changed settings, the power consumption may exceed the limits required for the ENERGY STAR qualification in the "Home" mode.



The 50 class has a 49.5 inch viewable image size (measured diagonally).

Contents

Introducing Your New BRAVIA®

Welcome to the World of BRAVIA®	4
Experiencing Stunning HD with Your BRAVIA	4
The Four Steps to a Stunning HD Experience	5
TV Feature Highlights	5

Getting Started

Setting Up Your TV	7
Attaching the Table-Top Stand	8
Locating Inputs and Outputs	9
Connecting the TV	11
Connecting Other Equipment	14
When Installing the TV Against a Wall or Enclosed Area	15
Securing the TV	16
Running Initial Setup	19

Operating the TV

Using the Remote Control	21
Remote Control Button Description	22
TV Controls and Indicators	25

Using Features

BRAVIA Sync Control	26
Using PIP Feature	27
Favorites	28
Wide Mode	29
Wide Mode with PC	30
Inputs	30
Playing back Photo/Music/Video via USB	31
Photo Frame	32

Using the Menus

Navigating through TV Menus	34
Using the Picture Settings	36
Using the Sound Settings	38
Using the Screen Settings	40
Using the Channel Settings	42
Using the Parental Lock Settings	43
Using the Setup Settings	46
Using the Eco Settings	51

Other Information

PC Input Signal Reference Chart for HDMI IN	52
Using a Wall-Mount Bracket	53
Troubleshooting	55
Important Notices	61
Specifications	62
Index	64



Customer Support

United States
<http://www.sony.com/tvsupport>
Canada
<http://www.sony.ca/support>

On-line Registration

United States
<http://productregistration.sony.com>
Canada
<http://www.sony.ca/registration>

Welcome to the World of BRAVIA®

Thank you for choosing this Sony BRAVIA® high-definition television. Use the documentation listed below to get the most out of your TV.



Safety Booklet

Contains precautionary measures to keep you and your TV safe. Read this information prior to setting up your TV.



Quick Setup Guide

Provides TV setup information with sample connection diagrams.



Operating Instructions

Provides the most detailed information to operate your TV.

Experiencing Stunning HD with Your BRAVIA

The quality of the image you see on your **BRAVIA** TV is only as good as the quality of the signal it receives. To experience the stunning detail of your new **BRAVIA** TV, you need access to HD programming. Your **BRAVIA** TV can receive and display HD programming from:

- Over-the-air broadcasting via HD-quality antenna
- HD cable subscription
- Blu-ray Disc™ player or other HD compatible external equipment

Contact your cable, satellite or HD service provider for information on upgrading to HD programming.

The Four Steps to a Stunning HD Experience

Set, Source, Sound, and Setup

Along with your **BRAVIA TV set**, a complete HD system requires a **source** of HD programming, an HD **sound** system, and a proper connection **setup**. Refer to the Quick Setup Guide, enclosed separately, for connecting optional equipment.



You can enjoy crisp, clear images, smooth movement, and high-impact visuals from 1080 HD signals as shown here.

When you compare a high-definition signal to a standard analog signal, you will notice a big difference in picture quality. If black bars appear as shown here, press **WIDE** on the remote control to fill the screen.

TV Feature Highlights

Your **BRAVIA** comes with many convenient features, such as:

- **MHL (Mobile High-Definition Link) input:** You can connect your MHL device using an MHL cable (page 13).
- **BRAVIA® Sync™:** Allows your **BRAVIA TV** to communicate with other Sony equipment supporting the **BRAVIA Sync Control** function (page 26).
- **Digital Media Accessibility:** Use the **Photo**, **Music**, and **Video** icons to access photo, music, and video files from Sony USB equipment (page 31).
- **PIP (Picture in Picture):** You can work on your PC and watch your favorite TV program simultaneously (page 27).
- **Favorites:** Your favorite channels and inputs are at your finger tips for easy access (page 28).
- **Auto Wide Mode:** Set your TV to automatically adjust the screen based on the signal resolution (page 29).
- **Input Selection:** Allows you to easily switch between the connected equipment (page 30).

- **Scene Select:** Allows you to easily adjust your TV to the most suitable picture and sound settings based on the scenes for the best quality result for the contents genre you are watching.
- **Photo Frame:** You can enjoy the large photo frame display with music (page 32).
- **On Timer:** Set timer to wake up TV automatically with preferred setting of input and volume. You can also wake up with your favorite photo and music through photo frame feature (page 48).

Setting Up Your TV

Some TV models are packaged with a detached Table-Top Stand so you can mount your TV to a wall right away. If you are not mounting the TV to a wall, you will need to attach the Table-Top Stand. You will need a Phillips screwdriver (not supplied) and the supplied screws to complete the task. Look for the supplied Table-Top Stand instruction leaflet.

Be sure to consider the following while setting up your TV:

- Disconnect all cables when carrying the TV.
- Carry the TV with the adequate number of people; larger size TVs require two or more people.
- Correct hand placement while carrying the TV is very important for safety and to avoid damage.
- Do not put stress on the LCD panel or the frame around the screen.

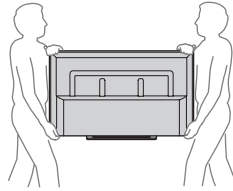

- Ensure your TV has adequate ventilation, see page 15.
- For best picture quality, do not expose the screen to direct illumination or sunlight.
- Avoid installing the TV in a room with reflective wall and floor materials.
- Avoid moving the TV from a cold area to a warm area. Sudden room temperature changes may cause moisture condensation. This may cause the TV to show poor picture and/or poor color. Should this occur, allow moisture to evaporate completely before powering the TV on.

Attaching the Table-Top Stand



- Refer to the supplied Table-Top Stand instruction leaflet for proper attachment.
- Be careful to not pinch your hands or the AC power cord when you install the TV set to the Table-Top Stand.
- For best picture quality, do not expose the screen to direct illumination or sunlight.

- 1** Place the TV set on the Table-Top Stand.
- 2** Fix the TV to the Table-Top Stand using the supplied screws.

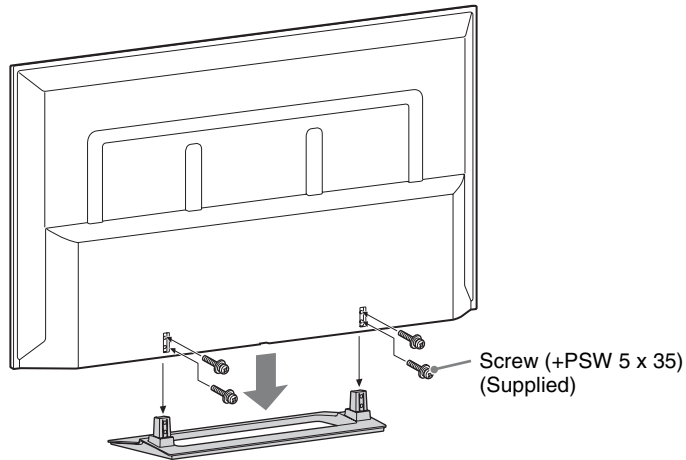

- Hold the TV with one hand to avoid it dropping when attaching.

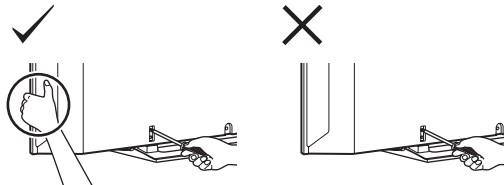

- Align the TV from the top, slide it in until the guide pins cannot be seen.
- If using an electric screwdriver, set the tightening torque at approximately 1.5 N·m (15 kgf·cm).
- Be sure to securely tighten the supplied screws, otherwise the TV may fall down.
- Use an appropriate screwdriver to attach the screws tightly without damaging the screw head.
- When detaching the Table-Top Stand, reverse the attaching procedure. Do not remove any screws other than those used when attaching the Table-Top Stand.

Locating Inputs and Outputs

Rear Panel

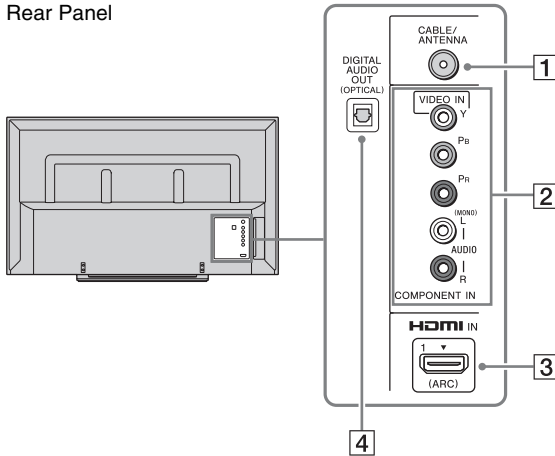

Side Panel

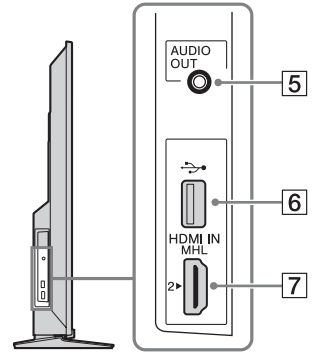

Item	Description
1	CABLE/ANTENNA RF input that connects to your Cable or VHF/UHF antenna.
2	VIDEO IN/COMPONENT IN/R-AUDIO-L (MONO) This input port can be used as a composite video input (VIDEO) or as a component video input (COMPONENT). For composite use, connect the yellow jack to Y for video and use audio L (mono) and R for audio signal. For component connection, use Y, PB, PR for video signals and also connect the audio L (mono) and R for audio signal. This TV can auto detect and switch between the VIDEO and COMPONENT when VIDEO or COMPONENT is connected. To set to auto detection, press HOME , select Settings , and then select the Setup settings. Select the Video/Component Selection option in AV Setup then set to Auto .

Item	Description
3 HDMI IN 1 (ARC)	HDMI (High-Definition Multimedia Interface) provides an uncompressed, all-digital audio/video interface between this TV and any HDMI-equipped audio/video equipment, such as a set-top box, DVD player, and A/V receiver. HDMI supports enhanced, or high-definition video, plus digital audio.
7 HDMI IN 2/MHL	<p>You can also connect your MHL (Mobile High-Definition Link) device to HDMI IN 2/MHL using an MHL cable. In addition, when you connect BRAVIA Sync-compatible equipment, communication with the connected device is supported.</p> <p>If connecting a digital audio system that is compatible with Audio Return Channel (ARC) technology, use HDMI IN 1 (ARC). If not, an additional connection with DIGITAL AUDIO OUT (OPTICAL) is necessary.</p>
4 DIGITAL AUDIO OUT (OPTICAL)	Connects to the optical audio input of digital audio equipment that is PCM/Dolby* ¹ Digital compatible.
5 AUDIO OUT	Connects to the audio input jacks of your analog audio equipment. You can use these outputs to listen to your TV's audio through your stereo system.
6 USB	Connects to USB equipment to access photo, music, and video files.

*¹Manufactured under license from Dolby Laboratories.



- An HDMI or Component video (YPbPr) connection is required to view 480i, 480p, 720p, 1080i and 1080p video formats. 1080/24p is available only with HDMI/MHL connection.
- Be sure to use only an authorized HDMI cable bearing the HDMI logo. We recommend that you use a Sony HDMI cable (high speed type).

Connecting the TV

Cable System or VHF/UHF Antenna System

You can enjoy high-definition and standard-definition digital programming (if available in your area) along with standard-definition analog programming.

This TV is capable of receiving unscrambled digital programming for both cable (QAM and 8VSB) and external VHF/UHF antenna (ATSC).

■ Cable or VHF/UHF (or VHF only)



- It is strongly recommended that you connect the CABLE/ANTENNA input using a 75-ohm coaxial cable to receive optimum picture quality. A 300-ohm twin lead cable can easily be affected by radio frequency interference, resulting in signal degradation.

Cable System and VHF/UHF Antenna System

Use an optional A-B RF switch (not supplied) to switch between the cable and over-the-air antenna programming, as indicated below.

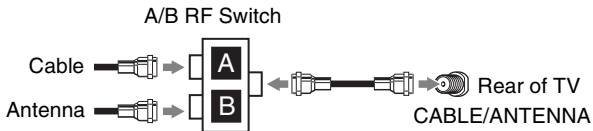

- Be sure to set the **Signal Type** setting to **Cable** or **Antenna** found under the **Channel** settings for your input signal (page 42).

HD Cable Box/HD Satellite Box

You can enjoy high-definition programming by subscribing to a high-definition cable service or a high-definition satellite service. For the best possible picture, make sure you connect this equipment to your TV via the HDMI or component video (with audio) input located on the back of your TV.

■ Shown with HDMI connection

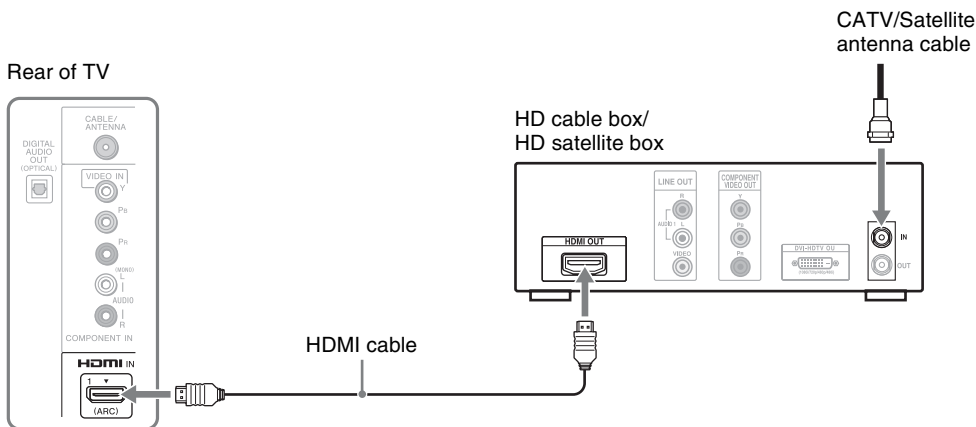

■ Shown with component connection

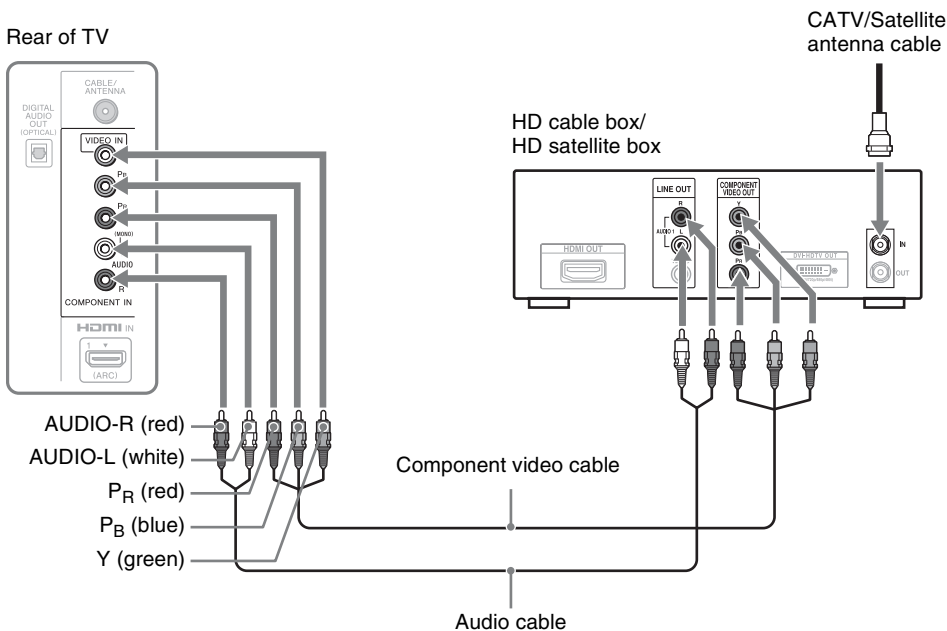

MHL Device

The MHL (Mobile High-Definition Link) enables the TV to communicate with connected MHL-compatible device. When connecting MHL-compatible device, TV simultaneously charges the connected device while playing photo/music/video from it. You can use the TV remote control to control the connected MHL-compatible device.

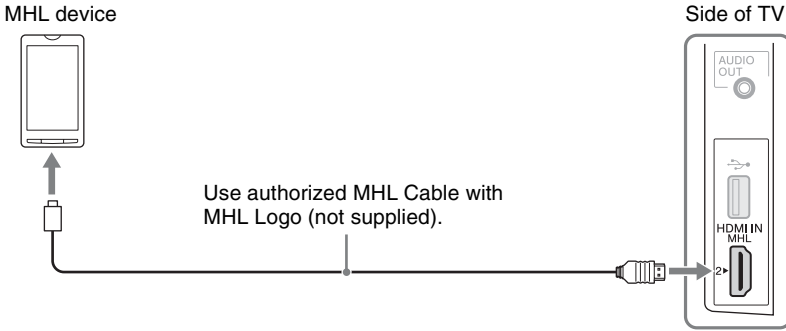

- You can continue normal usage of the connected MHL-compatible device (such as receiving calls) depending on its capability.
- Some remote control functions may not be available depending on features of the connected MHL-compatible device. Refer to the device manual for details.
- This product is officially MHL-certified for guaranteed operation with other MHL-certified devices. If you encounter any problems when using the MHL function, consult the device manufacturer for support.
- If **Auto Input Change(MHL)** is set to **On**, the TV automatically switches to HDMI IN 2/MHL from other input when MHL-compatible device is connected to HDMI IN 2/MHL jack. The availability of **Auto Input Change(MHL)** depends on whether the MHL-compatible device can support this feature.
- The TV can connect to the MHL-compatible device via its HDMI IN 2/MHL connection.

Connecting Other Equipment

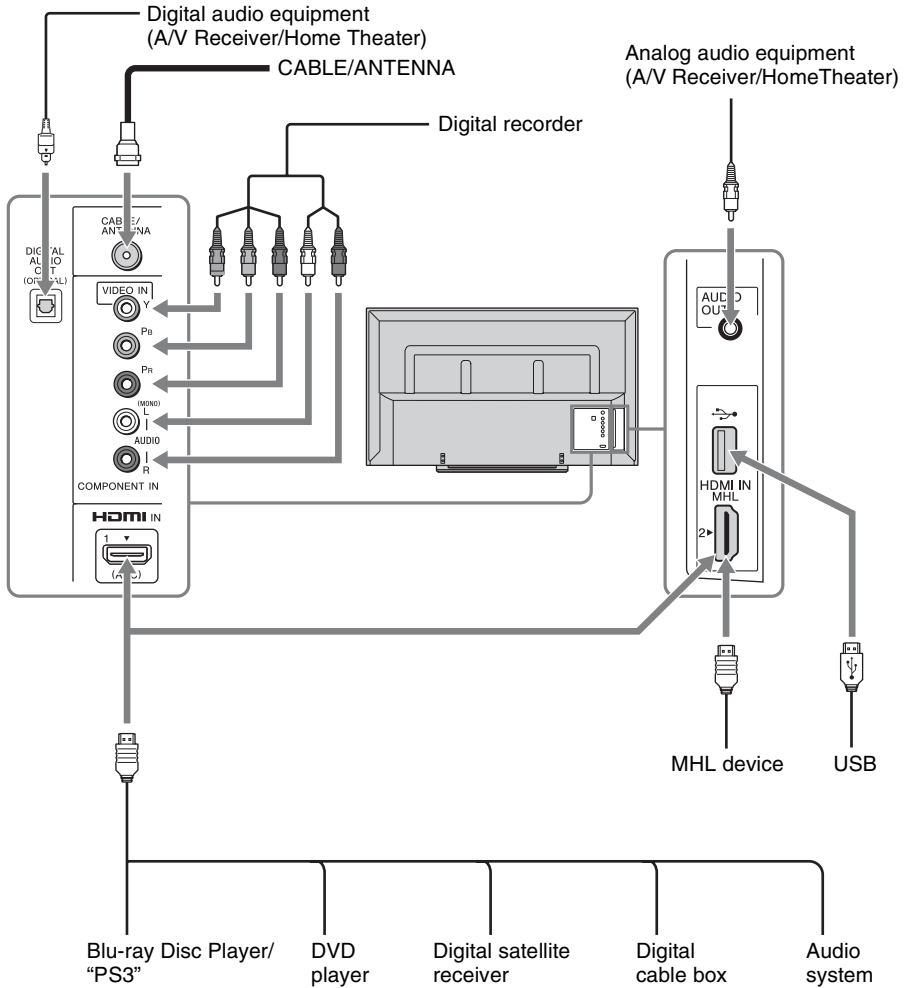

- Refer to the Quick Setup Guide (supplied) when connecting other equipment to your TV.

When Installing the TV Against a Wall or Enclosed Area

Make sure that your TV has adequate ventilation. Allow enough space around the TV as shown below. Avoid operating the TV at temperatures below 41 °F (5 °C).

Installed with stand

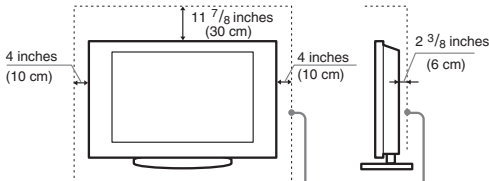

Leave at least this much space around the set.

Installed on the wall

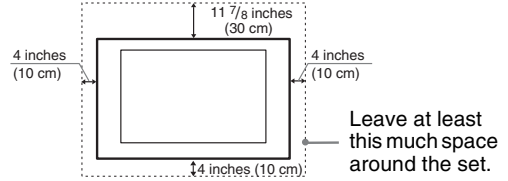

Never install the TV set as follows:

Air circulation is blocked.

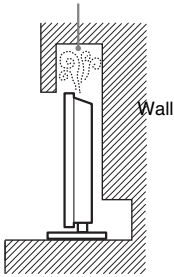

Air circulation is blocked.

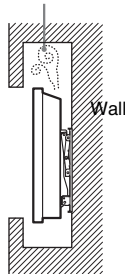

- Inadequate ventilation can lead to overheating of the TV and may cause damage to your TV or cause a fire.

Securing the TV



Sony strongly recommends taking measures to prevent the TV from toppling over. Unsecured TVs may topple and result in property damage, serious bodily injury or even death.

Preventing the TV from Toppling

- Secure the TV to a wall and/or stand.
- Do not allow children to play or climb on furniture and TV sets.
- Avoid placing or hanging items on the TV.
- Never install the TV on:
 - slippery, unstable and/or uneven surfaces.
 - furniture that can easily be used as steps, such as a chest of drawers.
- Install the TV where it cannot be pulled, pushed, or knocked over.
- Route all AC power cords and connecting cables so that they are not accessible to curious children.

Recommended Measures to Secure the TV

Consider the following measures when securing your TV to a TV stand (not supplied).

1 Secure the stand for the TV.

Make sure the TV stand can adequately support the weight of the TV. Use two angle braces (not supplied) to secure the stand.

For each angle brace use the appropriate hardware to:

- attach one side of the angle brace to the wall stud.
- attach the other side to the TV stand.

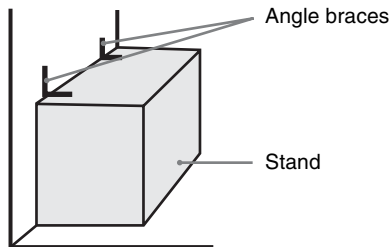

2 Secure the TV to the stand.

Use the optional hardware listed below (not supplied):

- M4 machine screw (screwed into the screw hole of the TV).
- A screw or similar (attach it to the TV stand).
- Rope or chain (strong enough to support the weight of the TV). Make sure that there is no excess slack in the rope or chain.

An alternative way to secure the TV is with an optional Sony Support Belt Kit. The Sony Support Belt Kit is available as an optional accessory, depending on your TV model.

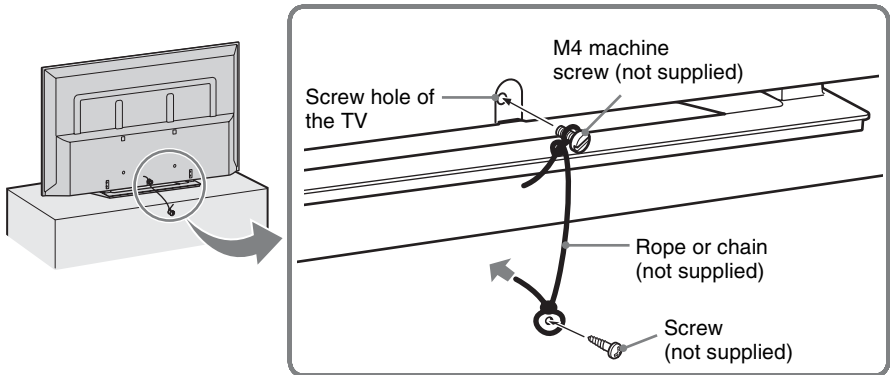

The length of the M4 machine screw differs depending on the rope or chain diameter. Please refer to below illustration.

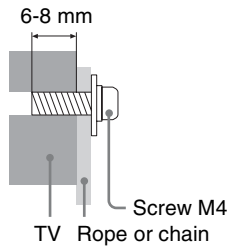

3 Anchor the TV to the wall.

Secure the Attachment Parts to the rear of the TV.

Anchor the TV to the wall by using bolts, wall anchor and chain (or rope).

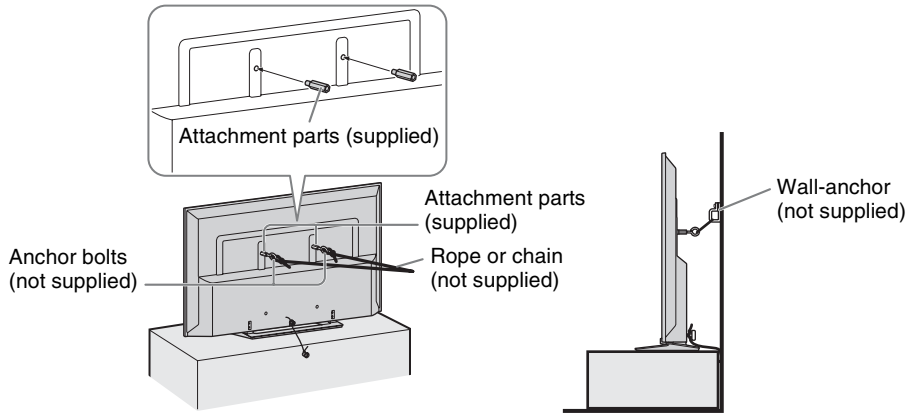

- Contact Sony Customer Support to obtain the optional Support Belt Kit by providing your TV model name.
For United States call: 1-800-488-7669 or visit: <http://www.sony.com/accessories>
For Canada call: 1-877-899-7669
- Securing the TV to the stand without securing the TV and the stand to the wall provides minimum protection against the TV toppling over. For further protection, be sure to follow the three measures recommended.

Running Initial Setup

During initial setup, you will perform the following:

- Set the language for the On Screen Display (OSD) text
- Choose your viewing environment
- Scan for digital and analog channels
- Set the current date and time after **Auto Program**.

Complete your cable connections before beginning the **Initial Setup**. Refer to the Quick Setup Guide (supplied) for sample connection diagrams.

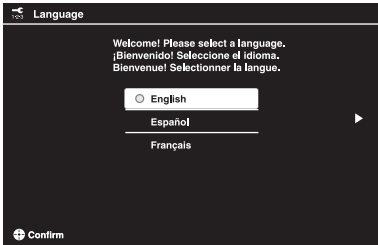

- 1 Turn on the TV.
The **Initial Setup** screen will appear.

- 2 Use the remote control buttons described below to navigate through the **Initial Setup**.

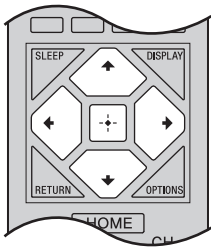

↑/↓/←/→ buttons:

Allow you to navigate and highlight options where applicable.

+ button:

Allows you to select the highlighted option and advance to the next screen.

- 3 **Auto Program** will scan for available channels from the signal source directly connected to the TV's CABLE/ANTENNA input. Follow the help text provided on the screen to run the **Auto Program**.
- 4 Set the current date and time.

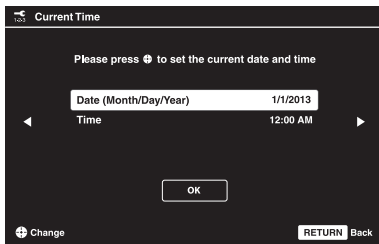



- If you cancel the **Auto Program**, any channels you have selected are not registered. To rescan for available channels, run **Auto Program**.
- Connect either your cable or antenna to the TV (you can connect both using an A-B RF switch (not supplied)); for more details see page 11.

Using the Remote Control

To Insert Batteries into the Remote Control

Insert two size AAA batteries (supplied) by matching \oplus and \ominus on the batteries to the diagram inside the battery compartment of the remote control.

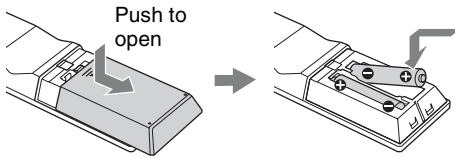

Guidelines to Follow

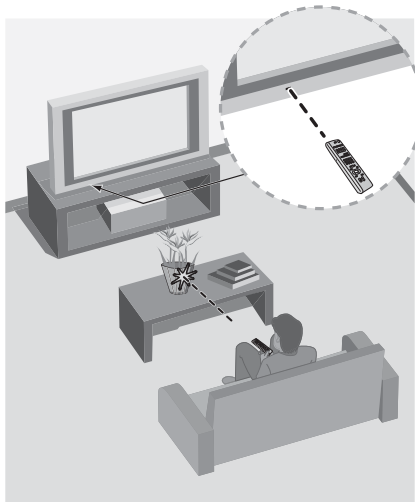

- Point your remote control directly at the IR sensor located on your TV.
- Make sure that no objects are blocking the path between the remote control and the IR sensor on your TV.
- Fluorescent lamps can interfere with your remote control; try turning off the fluorescent lamps.
- If you are having problems with the remote control, reinsert or replace your batteries and make sure that they are correctly inserted.

Remote Control Button Description

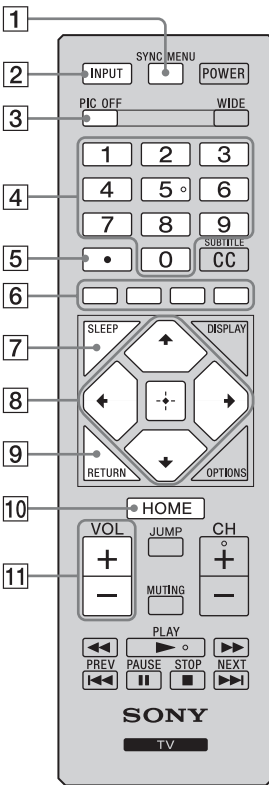

Button	Description
1 SYNC MENU	Press to display the BRAVIA Sync Menu and then select connected HDMI/MHL equipment from Device Selection .
2 INPUT	Press to display the list of External Inputs and TV mode. Press repeatedly to toggle through the inputs. See page 30.
3 PIC OFF	Press to turn picture off, and sound remains on.
4 0-9	Press 0-9 to select a channel.
5	Use with 0-9 to select digital channels. For example, to enter 2.1, press , , and .
6 Colored buttons	When the colored buttons are available, an operation guide appears on the screen.
7 SLEEP	Press repeatedly until the TV displays the time in minutes (Off/15/30/45/60/90/120) that you want the TV to remain on before shutting off. To cancel the sleep timer, press SLEEP repeatedly until Off appears.
8	Press , , , to move focus/highlight. Press to select/confirm an item.
9 RETURN	Press to go back to the previous screen or exit from the screen when displaying menu items and settings.
10 HOME	Press to display the menu with TV functions and settings. See "Using the Menus" on page 34.
11 VOL +/-	Press to adjust the volume.



- The **5**, and **CH +** buttons have a tactile dot. Use them as a reference when operating the TV.

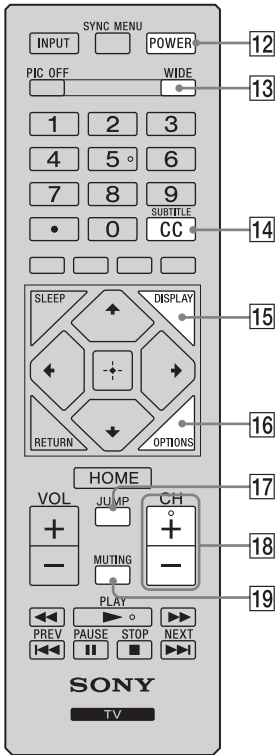

Button	Description
12 POWER	Press to turn on and off the TV.
13 WIDE	Press repeatedly to cycle through the available Wide Mode settings. See page 29.
14 CC/ SUBTITLE	Press to cycle through the available settings for Closed Captions (CC) : On, Off, and On when Muting .
15 DISPLAY	Press once to display the banner with channel/ program information you are watching. The banner will time out in a few seconds or press again to exit.
16 OPTIONS	Press to display a list of convenient functions and menu shortcuts. The options menu items vary based on current input and content.
17 JUMP	Press to jump back and forth between two channels and external inputs. The TV alternates between the current/last channel or external input selected.
18 CH +/-	Press to scan through channels. To scan quickly through channels, press and hold down either CH +/- .
19 MUTING	Press to mute the sound. Press again or press VOL + to restore the sound.



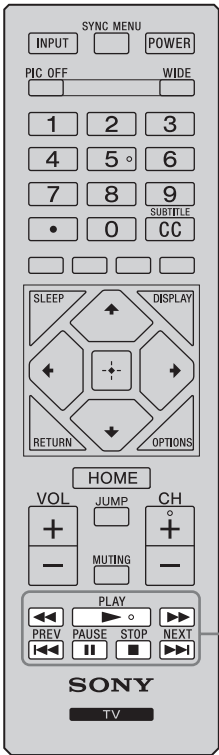

Button	Description
20 Equipment Control	<p>These buttons are used to control the equipment connected to the TV by using the BRAVIA Sync Control function (not available on all BRAVIA Sync Control equipment). Some other buttons on the remote control may also operate BRAVIA® Sync™ equipment.</p> <ul style="list-style-type: none"> ◀◀ (fast reverse): Press to play a program in fast rewind mode. ▶ (PLAY): Press to play a program at a normal speed. ▶▶ (fast forward): Press to play a program in fast forward mode. ◀◀ (PREV): Press to replay the current program from the previous chapter mark. (PAUSE): Press to pause playback. ■ (STOP): Press to stop playback. ▶▶ (NEXT): Press to advance forward to the next chapter mark.

TV Controls and Indicators

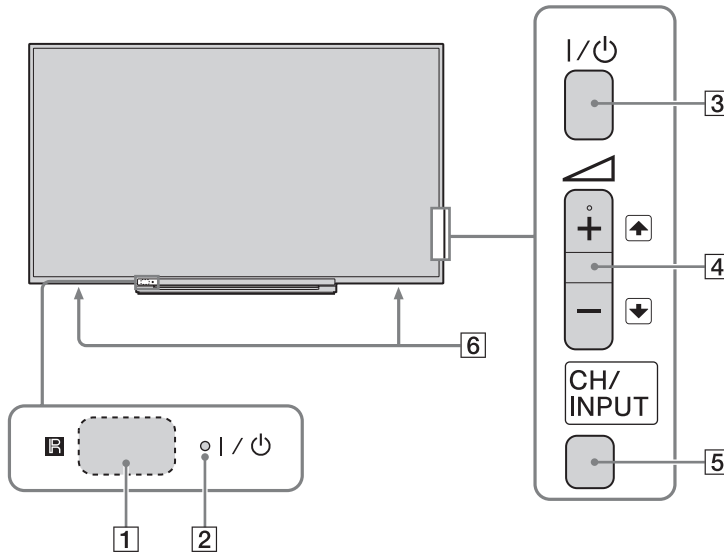

Item	Description
1 (IR) Infrared Receiver/ Light sensor	Receives IR signal from the remote control. Senses room light level and adjusts the screen brightness accordingly. Do not put anything over the sensor, doing so may affect its function.
2 I/Power LED	<ul style="list-style-type: none"> Lights up in red when the TV is in standby mode. Lights up in green when the TV is turned on. Lights up in orange when the timer is set or the TV is in Photo Frame Mode. Lights up in green when the Power Saving is set to Picture Off.
3 I/Power (Power)	Press to turn on and off the TV.
4 - / + ↓ / ↑	Press to adjust the volume, or select a channel/external input. When the volume Up/Down screen is displayed by pressing ▲ +/- , volume can be adjusted. When the channel Up/Down screen is displayed by pressing CH/ INPUT , channels can be selected. When the input select screen is displayed by pressing CH/INPUT , external input can be selected.
5 CH/INPUT	Switches between the channel Up/Down screen and input select screen.
6 Speaker	Outputs audio signal.



- For more information about setting up the external inputs labels, see page 48.
- The **▲ +** button has a tactile dot. Use it as a reference when operating the TV.
- Make sure that the TV is completely switched off before unplugging the power cord.

BRAVIA Sync Control

With the **BRAVIA Sync Control** function, **BRAVIA Sync** helps to communicate with **BRAVIA Sync**-compatible equipment using HDMI CEC (Consumer Electronics Control). Use the following settings and tips to help unify control of your connected equipment.

- 1 Press **HOME** and select **Settings**, then select the **Setup** settings.
- 2 Select the **BRAVIA Sync Settings**, then highlight **BRAVIA Sync Control**, and set to **On**.

■ Controlling BRAVIA Sync-compatible equipment

To control the equipment by using the remote control, press **SYNC MENU** and select the desired equipment from **Device Selection**.



■ BD/DVD player

- Automatically turns the **BRAVIA Sync**-compatible equipment on and switches the input to that equipment when you select it from the **Sync Menu**.
- Automatically turns the TV on and switches the input to the connected equipment when the equipment starts to play.
- Automatically turns the connected equipment off when you switch the TV to standby mode.

■ AV amplifier

- Automatically turns the connected AV amplifier on and switches the sound output from the TV speaker to the audio system when you turn the TV on.
- Automatically switches the sound output to the AV amplifier by turning the AV amplifier on when the TV is turned on.
- Automatically turns the connected AV amplifier off when you switch the TV to standby mode.
- Adjusts the volume (**VOL +/-**) and mutes the sound (**MUTING**) of the connected AV amplifier through the TV's remote control.

■ Video camera

- Automatically turns the TV on and switches the input to the connected video camera when the connected video camera is turned on.
- Automatically turns the connected video camera off when you switch the TV to standby mode.



- **BRAVIA Sync Control** is only available for the connected Sony equipment that has the **BRAVIA Sync** or is compatible with **BRAVIA Sync Control**.
- The **BRAVIA Sync Control** settings must be set on both the TV and connected equipment. For settings on the connected equipment, refer to their instruction manuals.
- When specific Sony equipment compatible with **BRAVIA Sync Control** is connected, **BRAVIA sync** is automatically activated on the equipment.

Using PIP Feature

PIP (picture in picture) displays a picture from a connected PC in full screen, and a TV program or other external input (see below “To Enter PIP” table) in an inset window. (**Closed Captions (CC)** is not available with **PIP** mode.)



To Enter PIP

PIP Supported Inputs	
In main window	In sub window
HDMI IN (PC timing)	TV channel (CABLE/ANTENNA), VIDEO IN, COMPONENT IN

- 1 Press **OPTIONS** while images from a PC appear on the screen.
- 2 Select **PIP** from the **OPTIONS** menu.
- 3 The sub window will appear.

■ To change channels

You can change the channel of the sub window by pressing **CH +/-** or entering the channel number using the **0-9** numeric and **[.]** buttons.

■ To exit from PIP

You can exit from PIP, using any of the following methods:

- ① Press **OPTIONS**, press **↑/↓** to highlight **Exit PIP**, then press **[+]** to exit to the full PC screen.
- ② Press **RETURN**.

■ To swap audio

You can swap audio between the main and sub window.

- 1 Press **OPTIONS**.
- 2 Press **↑/↓** to highlight **Audio Swap** and press **[+]**.
- 3 Press **↑/↓** to highlight the window to be audible, then press **[+]**.

Favorites

Your favorite channels and external inputs can be accessed by pressing the **HOME** button once they are added to the list.

- 1 Press **HOME**.
- 2 Press **▲/▼** to select **Favorites**, then press **+**.

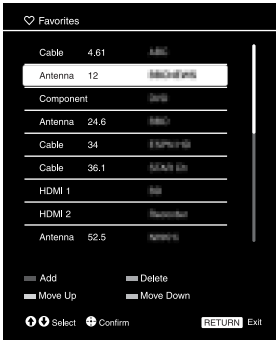

The favorites list appears.

- 3 Press **▲/▼** to select a channel or input, then press **+**.

■ To add to Favorites

While tuned to the channel you want to watch or viewing connected equipment, press **HOME** and select **Favorites** to display the list. Press the yellow button to add to the list. Your newly added item will be listed at the top of the list. When you continue to add items beyond the 18th item, the item listed at the bottom of the list will be automatically removed from the list.

■ To delete from Favorites

Select the item to delete, then press the blue button.

■ To move items in Favorites

Select the item to move, then press the red/green button.



- Favorite channels and external inputs can also be added using the **OPTIONS** button on the remote control.
- Your **Favorites** list of TV channels will be cleared each time you run the **Auto Program**.

Wide Mode

The **Wide Mode** feature allows you to select the screen display of your preference. Based on the original signal source, you may see black bars around the picture or just on the both sides of the screen. Sometimes you will see the picture filled the full screen. This is due to the signals your TV receives.







You can manually select available **Wide Mode** settings as you watch your TV by pressing the **WIDE** button on your remote control or you can set your TV to **Auto Wide**.

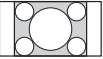

■ To set Auto Wide

Press **HOME** and select **Settings**, then select the **Screen** settings. Select **Auto Wide** and set to **On**.

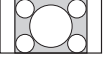
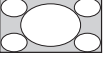
■ To change the Wide Screen mode

Press **WIDE** repeatedly to cycle through the available modes.

4:3 Original source	16:9 Original source
Standard-definition source 	High-definition source 
↓	↓
Wide Zoom 	Wide Zoom 
Normal 	Normal This mode is not available.
Full 	Full 

4:3 Original source	16:9 Original source
Zoom 	Zoom 

Normal is available with 480i or 480p sources only.

Wide Mode with PC

Wide Mode is also available for the **PC** settings. When a PC is connected to the TV and HDMI input is selected, you can change the PC Screen settings.

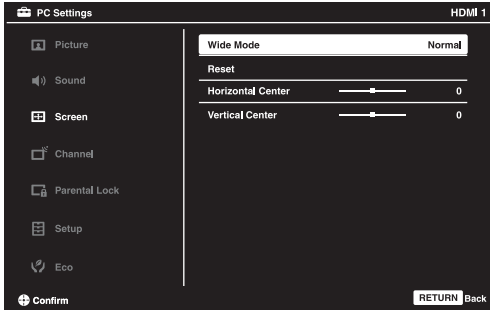

■ To change the Wide Screen mode for PC timing

Press **WIDE** repeatedly to cycle through the available modes while in the HDMI input (PC timing) mode.

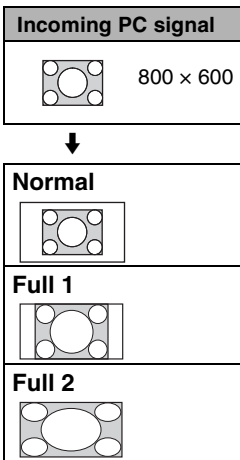

Inputs

Press **INPUT** to display the **Input** menu and toggle through the external inputs to select your video signal for viewing including the TV mode. The inputs list consists of TV mode and other equipment connected to the TV.

You can label your external inputs to identify them easily.

■ To manage on input

Press **HOME** and select **Settings**, then select the **Setup** settings. Select the **Manage Inputs** option in **AV Setup**. Press **↑/↓** to highlight the video input (**HDMI 1, HDMI 2 / MHL, Video, Component**) to which you want to assign a label; press **+** to select the input of your choice.

■ To manage label

Press **←/→** to highlight one of the displayed labels that corresponds to your connected equipment, then press **+**.

■ To manage enable

- 1 Press **←/→** to select enable column.
- 2 Press **↑/↓** to select **Auto, Always** or **Off**. The selected input will be listed always.

Playing back Photo/ Music/Video via USB

You can enjoy photo/music/video files stored in a Sony digital still camera or camcorder through a USB cable or USB storage device on your TV.

- 1 Connect a supported USB device to the TV.
- 2 Press **HOME**.
- 3 Press **▲/▼** to select **Photo**, **Music**, or **Video**, then press **□**.
The file or folder list appears.
- 4 Press **▲/▼/◀/▶** to select a file or folder, then press **□**.
When you select a folder, select a file, then press **□**.
Playback starts.



- If you connect the USB device when **USB Auto Start** is set to **On** (page 46), the thumbnail view of the last played Photo/Music/Video appears automatically.

■ Notes when playing back files

- While the TV is accessing the data on the USB device, observe the following:
 - Do not turn off the TV.
 - Do not disconnect the USB cable.
 - Do not remove the USB device.The data on the USB device may be damaged.
- Sony will not be held liable for any damage to, or loss of, data on the recording media due to a malfunction of any connected devices or the TV.
- USB playback is supported for the following photo file formats:
 - JPEG (JPEG format files with the extension “.jpg” and conforming to DCF 2.0 or Exif 2.21)
- USB playback is supported for the following music file format:
 - MP3 (files with the extension “.mp3” that have not been copyrighted)
- USB playback is supported for the following video file format:
 - MPEG1, MPEG2 (files with the extension “.mpg”)
- **USB Auto Start** shows photo files in the newest digital still camera folder (DCF-compliant, highest-numbered “DCIM” folder).
- **USB Auto Start** may not work automatically when some digital still cameras are connected.
- The file name and folder name are only supported in English.
- When you connect a Sony digital still camera, set the camera’s USB connection mode to “Auto” or “Mass Storage.” For more information about USB connection mode, refer to the instructions supplied with your digital camera.

- Use a USB storage device that is compliant with USB Mass Storage Class standards.
- The file system on the USB device supports FAT16, FAT32 and NTFS.

Photo Frame

You can enjoy looking at photos, listening to music, or seeing the clock and calendar, at the same time.

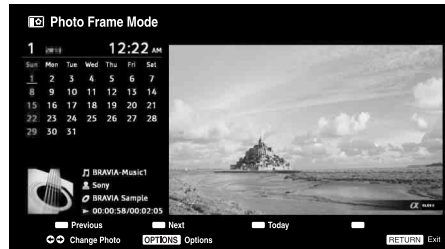

You can enter photo frame mode using any of the following methods:

- ① Press **HOME**, and then select **Photo Frame Mode**.
- ② Press **OPTIONS**, when you are playing back the photo/music files.

You can switch the frame, e.g. image and clock, full screen image or full screen clock.

For more details, see page 46.

■ To select photo

You can select photos from USB memory, using any of the following methods:

- ① Press **HOME** and select **Settings**, then **Setup > Photo Frame Settings > Image Selection**. Press **[+]** to select the file from thumbnail view.
- ② In photo frame mode, press **OPTIONS > Image Selection**. Press **[+]** to select the file from thumbnail view.
- ③ Press **HOME**, and select **Photo**. When playing back a photo, press **OPTIONS > Photo Frame Mode** to launch **Photo Frame** with the selected photo.

■ To select music

You can select music from USB memory, using any of the following methods:

- ① Press **HOME** and select **Settings**, then **Setup > Photo Frame Settings > Music Selection**. Press **[+]** to select the file from thumbnail view.
- ② In photo frame mode, press **OPTIONS > Music Selection**. Press **[+]** to select the file from thumbnail view.
- ③ Press **HOME**, and select **Music**. When playing back music, press **OPTIONS > Photo Frame Mode** to launch **Photo Frame** with the selected music.

■ To select Display mode

You can change the photo frame display by selecting **Display Mode** (page 46).

• Image and Clock



• Full Screen Image



• Full Screen Clock



■ To select Clock Display mode

There are five calendar display modes. When the **Display Mode** setting is set to **Image and Clock**, you can set to **Calendar**, **Analog Clock** or **Digital Clock**. When the **Display Mode** setting is set to **Full Screen Clock**, you can set to **Calendar**, **Calendar and Clock** or **Clock**. For more details, see page 46:

- **Calendar**
- **Analog Clock**
- **Digital Clock**
- **Calendar and Clock**
- **Clock**

■ Duration

To save power, photo frame mode will shut down after 24 hours of TV with power off automatically. After running photo frame mode for 24 hours, not use this mode for at least one hour, to avoid panel burn-in.

Duration time can be set to **Duration** in **Photo Frame Settings**. For more details, see page 46.

To avoid panel burn-in, the position of the photo, clock and calendar are switched automatically every hour.

Navigating through TV Menus

The **HOME** button allows you to access a variety of TV settings and USB media files.

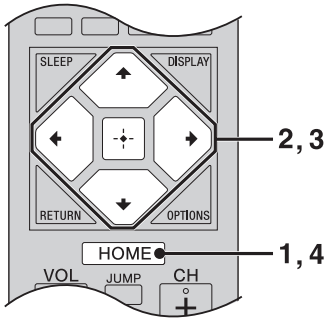

- 1 Press **HOME** on the remote control to display the menu options.
- 2 Press **↑/↓/←/→** to navigate on the menu or adjust the settings.
- 3 Press **↵** to select or confirm.
- 4 Press **HOME** to exit.



Favorites

The **Favorites** feature provides quick access to your frequently used items, such as preferred TV channels or external inputs (e.g. game console, DVD player). For details, see page 28.



Photo



Music

The **Photo**, **Music**, and **Video** icons organize your photo, music, and video files from USB connected equipment. Be sure to select the correct icon when accessing files. Refer to the feature section for more information on these icons (page 31).



Video



Photo Frame Mode

You can select **Photo Frame Mode** which enables you to enjoy photo, music and clock. For details, see page 32.



The **Settings** icon contains all of the necessary configurations to customize your TV settings. The options you can select may vary. Unavailable options are grayed out or not displayed.



Picture: adjust the picture on your TV to fit your viewing preference.



Sound: customize your sound settings to suit your audio preference. You can also change the settings to output the sound to your connected audio equipment.



Screen: adjust the size and shape of the images you see on the screen.



Channel: navigate your favorite channels and inputs and select the signal type, as well as auto program channels. You can also customize the channels you see and the labels assigned to them.



Parental Lock: set the password and limit access to programming based on rating levels. You can also block channels and inputs.



Setup: modify and customize a variety of general setting options.



Eco: changes the settings related to power consumption.



Using the Picture Settings

Option	Description
Picture Mode	Displays the options selected in the Scene Select settings. When Scene Select is set to General , the first three options below can be selected.
Customized picture viewing	Vivid Select for enhanced picture contrast and sharpness.
	Standard Select for standard picture settings. Recommended for home entertainment.
	Custom Select to store your preferred settings.
	Cinema For film-based content. Suitable in a theater-like environment.
	Graphics Optimizes picture quality for viewing graphics.
Reset	Resets the current Picture settings to their defaults, except Picture Mode .
Backlight	Adjust to brighten or darken the backlight.
Picture	Adjust to increase or decrease picture contrast.
Brightness	Adjust to brighten or darken the picture.
Color	Adjust to increase or decrease color intensity.
Hue	Adjust to increase or decrease the green tones.
Sharpness	Adjust to sharpen or soften the picture.
Color Temperature	Cool Select to give the white colors a bluish tint.
White adjustment	Neutral Select to give the white colors a neutral tint.
	Warm Select to give the white colors a reddish tint.
Noise Reduction	Select to reduce the picture noise level. Select from Auto , High , Medium , Low and Off .
MPEG Noise Reduction	Select to reduce the picture noise in MPEG-compressed videos. This is effective when viewing a DVD or digital broadcast. Select from High , Medium , Low and Off .
CineMotion	Provides improved picture movement and reduces picture blur and graininess for film-based content. Select Auto to represent original film-based content as is.

Option	Description
Advanced Settings	Reset Resets the advanced settings to the default values.
	Adv. Contrast Enhancer Automatically adjusts backlight and contrast to the most suitable settings judging from the brightness of the screen. This setting is especially effective for dark scenes, and will increase the contrast distinction of the darker picture scenes. Select from High, Medium, Low and Off .
	Black Corrector Enhances black areas of the picture for stronger contrast. Select from High, Medium, Low and Off .
	Gamma Adjusts the balance between bright and dark areas of the picture.
	Clear White Emphasizes white colors. Select from High, Low and Off .
	Live Color Makes colors more vivid. Select from High, Medium, Low and Off .
	LED Motion Mode Lights up the backlight adequately, reducing blur in movies, but the brightness decreases.



- Available **Picture** options, including options in **Advanced Settings** depend on **Scene Select** and **Picture Mode**.

Using the Sound Settings

Option	Description
Sound Mode Customized sound listening	Sets a sound mode. Sound Mode includes options best suited for video and photographs, respectively.
	Standard Optimizes sound quality for general content.
	Music Lets you experience dynamic and clear sound, like that of a concert.
	Cinema Optimizes surround sound for movies.
	Game Broadens your game-playing experience with superb sound quality.
Sports Reproduces realistic sound, like that in a stadium.	
Reset	Resets the current Sound settings to their defaults, except Sound Mode , MTS Audio , Alternate Audio , Speakers and Audio Out .
Equalizer	Adjust allows you to select your frequency response curve. Select Reset to reset the Equalizer settings to the default values.
Sound Booster	Select On to enhance treble/bass and reproduces dynamic sound, or Off to provide natural sound.
Clear Voice	Select On for spoken dialog.
Steady Sound	Select On to stabilize the volume across all programs and commercials. Select Off to disable this function.
Balance	Adjust to emphasize left or right speaker balance.
Volume Offset	Adjust the volume level of the current input relative to other inputs.
MTS Audio Enjoy stereo, bilingual and mono programs	Stereo Select for stereo reception when viewing a program broadcast in stereo.
	Auto SAP Select to automatically switch the TV to second audio programs when a signal is received. If no SAP signal is present, the TV remains in Stereo mode.
	Mono Select for mono reception. Use to reduce noise during weak stereo broadcasts.
Alternate Audio Digital channels only	Select among the available options to switch among the alternate audio streams. The program you are tuned to may be broadcasted in a different language in the alternate audio streams.
Speakers	TV Speakers Select to use the TV speakers.
	Audio System Select to use an external audio system for the TV sound. By selecting this option you are disabling the TV speakers.
Audio Out	Variable Adjusts the volume with the TV's remote control, when using an external audio system.
	Fixed Adjusts the volume using the connected audio system's remote control.



- **MTS Audio** is only available for analog programs.
- **Alternate Audio** is only available if the program is broadcast with alternate audio streams.
- You can also access **Sound Mode**, **MTS Audio** and **Alternate Audio** by using the **OPTIONS** button on the remote control.

Using the Screen Settings

Option	Description
Wide Mode	Wide Zoom Fills the screen with minimum distortion.
	Normal Select to display 4:3 picture in original size when the original source is 4:3.
	Full Select to enlarge the picture horizontally to fill the screen when the original source is 4:3 (Standard definition source). When the original source is 16:9 (High-definition source), select this mode to display the 16:9 picture in its original size.
	Zoom Select to enlarge the original picture without distorting the aspect ratio.
Auto Wide	On Select On to automatically change Wide Mode setting based on the content.
	Off If frequent screen changes are disturbing to you, select Off . Choose one of the Wide Mode options when this function is set to Off .
4:3 Default Select the default Screen Mode to use for 4:3 sources	Wide Zoom Enlarges the 4:3 picture to fill the 16:9 screen, displaying as much of the original image as possible.
	Normal Select to display the 4:3 picture in its original size.
	Off Select to continue using the current Wide Mode setting when the channel or input is changed.
Auto Display Area	Select On to automatically adjust the picture to the most appropriate display area. Select Off to disable this function.
Display Area	Full Pixel Displays pictures in their original size when parts of the picture are cut off (available depending on the TV model).
	+1 Displays pictures in their original size. This option is only available for Digital TV and HDMI/MHL input signals (non 1080i and 1080p video formats).
	Normal Displays pictures in their recommended size.
	-1 Enlarges the picture so that the edges are outside the visible display area.
Horizontal Center	Allows you to move the position of the picture left and right. (Available in Wide Zoom and Zoom .)



- **Normal** in the **Wide Mode** setting is not available when you are watching a 720p, 1080i or 1080p source.
- If **4:3 Default** is set to anything but **Off**, the **Wide Mode** setting changes only for the current channel. When you change channels (or inputs), **Wide Mode** is automatically replaced with the **4:3 Default** setting for 4:3 sources. To retain the current **Wide Mode** setting as channels and inputs are changed, set **4:3 Default** to **Off**.
- **4:3 Default** is not available if **Auto Wide** is set to **Off**.

Option	Description						
Vertical Center	Allows you to move the position of the picture up and down. (Available in Wide Zoom and Zoom .)						
PC Settings	When a PC is connected to the TV, the PC settings screen appears instead of the Screen settings. You can also select the PIP feature which allows you to view two pictures simultaneously from OPTIONS button (page 27).						
Wide Mode	<table border="1"> <tbody> <tr> <td>Normal</td> <td>Select to display in the original image size.</td> </tr> <tr> <td>Full 1</td> <td>Select to enlarge the picture to fill the display area, keeping its original aspect ratio.</td> </tr> <tr> <td>Full 2</td> <td>Select to enlarge the picture to fill the display area.</td> </tr> </tbody> </table>	Normal	Select to display in the original image size.	Full 1	Select to enlarge the picture to fill the display area, keeping its original aspect ratio.	Full 2	Select to enlarge the picture to fill the display area.
Normal	Select to display in the original image size.						
Full 1	Select to enlarge the picture to fill the display area, keeping its original aspect ratio.						
Full 2	Select to enlarge the picture to fill the display area.						
Reset	Resets all PC settings to the default values, except Wide Mode .						
Horizontal Center	Allows you to move the position of the picture left and right.						
Vertical Center	Allows you to move the position of the picture up and down.						



- For the PC Input Signal Reference Chart, see page 52.



Using the Channel Settings

Option	Description
Signal Type	Cable Select if you are receiving cable channels via Cable TV provider.
	Antenna Select if you are using an antenna.
Auto Program	Automatically sets up the channel list on the TV for all receivable channels. 1 Select Auto Program . 2 Select OK to start Auto Program .
Add Digital Channels	1 Select Add Digital Channels . 2 Select OK to add digital channels.
Show/Hide Channels	Allows you to show or hide channels that appear when you use the CH +/- buttons. 1 Press ▲/▼ to scroll through the channels until you find the channel you want to show or hide. Then press [+] to select it. 2 Press ▲/▼ to determine if the channel will be shown or hidden. Then press [+] to select it.
Edit Channel Labels	Allows you to assign labels (such as station call letters) to channel numbers. 1 Press ▲/▼ to scroll through the channel numbers. Then press [+] to select the channel number that you want to assign a label. 2 Press ▲/▼ to scroll through the label characters (A-Z, 0-9, etc.). Press ▶ to move to the next character. Repeat the previous steps to add up to seven characters to the label. When finished, press [+] .
Analog Fine Tune	Allows you to fine-tune the selected analog channel manually if you feel that a slight tuning adjustment may improve picture quality. Select Auto to adjust to the most appropriate analog channel.



- You should run **Auto Program** after changing the **Signal Type** setting.
- Running **Auto Program** will clear the **Favorites** list.
- Channels that you set to be hidden can be accessed by the **0-9** and **[•]** buttons.
- You can set channels to be hidden that are automatically set in **Auto Program**.

Using the Parental Lock Settings

Option	Description
Password	The Parental Lock settings allow you to set up the TV to block programs according to their content and rating levels. Use 0-9 on the remote control to enter a four-digit password. The first time you create a password, confirm the password by entering it again.
Change Password	Select to change your password.
Country	<p>U.S.A. Select to use U.S.A. ratings (page 44).</p> <p>Canada Select to use Canadian ratings (page 45).</p>
Rating	<p>Off Turn Parental Lock off. No programs are blocked from viewing.</p> <p>Child Maximum ratings permitted are: U.S.: TV-Y, TV-G, G Canada: C, G, TV-Y</p> <p>Youth Maximum ratings permitted are: U.S.: TV-PG, PG Canada: C8+, PG, 8 ans+, TV-PG</p> <p>Young Adult Maximum ratings permitted are: U.S.: TV-14, PG-13 Canada: 14+, 13 ans+, TV-14</p> <p>Custom Select to set ratings manually. U.S.: See page 44 for details. Canada: See page 45 for details.</p>
Downloadable U.S. Rating (Available only in U.S.A. where advanced ratings exist)	<p>Off Turn Downloadable U.S. Rating off. No programs that contain downloadable ratings are blocked from viewing.</p> <p>Custom Select to block programs based on downloadable ratings.</p> <p>Clear All Select to clear the entire downloadable rating system.</p>
Unrated (Available only when Country is set to U.S.A.)	<p>Allow Allows programs and movies that are broadcasted without a rating.</p> <p>Block Blocks all programs and movies that are broadcasted without a rating.</p>
Channel Block	Allows you to block channels regardless of program ratings.
	To View a Blocked Channel
	Press  when tuned to the blocked channel then enter the password.
External Input Block	Allows you to block external inputs regardless of program ratings.
	To View a Blocked External Input
	Press  when tuned to the blocked input then enter the password.



- You need your password for any future access into the **Parental Lock** settings. If you lose your password, see “Lost password” on page 60.
- Selecting **Clear All** will delete the current **Downloadable U.S. Rating** menu and the menu will no longer be available until the TV is tuned to a channel that contains downloadable ratings.
- If you block unrated TV programs, be aware that the following types of programs may be blocked: programs broadcasted from another country, emergency broadcasts, political programs, sports, news, public service announcements, religious programs and weather.

US Models: Selecting Custom Parental Lock Rating Options

To select custom rating options for the U.S., select **U.S.A.** in the **Country** setting (page 43).

Option	Description
Movie Rating	G All children and general audience.
	PG Parental guidance suggested.
	PG-13 Parental guidance for children under 13.
	R Restricted viewing, parental guidance is suggested for children under 17.
	NC-17 and X No one 17 or under allowed.
TV Rating Block programs by their rating, content or both	Age-Based Ratings
	TV-Y All children.
	TV-Y7 Directed to children age 7 and older.
	TV-G General audience.
	TV-PG Parental guidance suggested.
	TV-14 Parents strongly cautioned.
	TV-MA Mature audience only.
	Content-Based Ratings
	FV Fantasy violence.
	D Suggestive dialog.
	L Strong language.
	S Sexual situations.
	V Violence.



- To ensure maximum blocking capability, set the Age-Based Ratings.

Canadian Models: Selecting Custom Parental Lock Rating Options

To select custom rating options for Canada, select **Canada** in the **Country** setting (page 43).

Option	Description
English Rating	C All children.
	C8+ Children 8 years and older.
	G General programming.
	PG Parental guidance.
	14+ Viewers 14 and older.
	18+ Adult programming.
French Rating	G General programming.
	8 ans+ Not recommended for young children.
	13 ans+ Not recommended for ages under 13.
	16 ans+ Not recommended for ages under 16.
	18 ans+ Programming restricted to adults.
U.S.A. Rating	See "US Models" on page 44 for details.

Viewing Blocked Programs

You can view blocked programs by entering your password. Press when tuned to a blocked program, then enter the password. This temporarily deactivates the parental control feature. To reactivate the **Parental Lock** settings, turn off the TV. When the TV is turned on again, your **Parental Lock** settings are reactivated.



Using the Setup Settings

Option	Description
Photo Frame Settings	Display Mode Allows you to select the display mode. Select from Image and Clock , Full Screen Image or Full Screen Clock . See page 33.
	Clock Display Allows you to select the clock display. Select from Calendar , Analog Clock , Digital Clock , Calendar and Clock or Clock . Calendar and Clock and Clock can be displayed only when Display Mode is Full Screen Clock .
	Audio Application Music You can enjoy music with this function. Off Turns off the music.
	Image Selection Select image from sample photo or USB photo.
	Music Selection Select music from sample music or USB music.
	Slideshow Setting Slideshow You can play a slideshow of photos. Single View Displays one photo only.
	Music Playback Setting All Tracks Listen to all music tracks. Single Track Set to listen to a single music track.
	Duration Selects the time period (1 h , 2 h , 4 h or 24 h) after which the TV automatically switches to standby mode.
	First day of the week Set Sunday or Monday as the first day of the week on the calendar.
	USB Auto Start Select On to show the thumbnail view automatically when the TV is turned on and a digital still camera or other device containing photo, music or video files is still connected to the USB port then turned on.

Option	Description
Closed Captions (CC)	CC Display
	On Closed Captions (CC) is turned on.
	Off Closed Captions (CC) is turned off.
	On when Muting Closed Captions (CC) is turned on when the TV is muted.
Analog CC	Allows you to select basic analog (EIA-608) closed caption options.
	CC1, CC2, CC3, CC4 Displays a printed version of the dialog or sound effects of a program. (Should be set to CC1 for most programs.)
	Text1, Text2, Text3, Text4 Displays network/station information presented using either half or the whole screen (if available).
Digital CC	When the digital closed caption service is available, select from the Service 1-6 or CC1-4 .
Digital CC Options	Allows you to make additional settings for digital closed caption options. Select As Broadcast or Custom . The Custom option is available on the Digital CC setting.
	Custom Allows you to customize the following settings:
	Character Size Small, Standard, Large
	Character Style Style 1-7
	Character Color Color 1-8
	Character Opacity Solid, Translucent
	Edge Type None, Raised, Depressed, Outline, Left Shadow, Right Shadow
	Edge Color Color 1-8
	Background Color Color 1-8
	Background Opacity Solid, Translucent
Audio Description	Provides an audio description (narration) of visual information, when available.



- You can turn on **Closed Captions (CC)** options (**On**, **Off** or **On when Muting**) by pressing the **CC** button on the remote control.

Option	Description
Info Banner	Displays the information related to the input signal you are watching. Select Small to display minimal channel and program title or select Large to display detailed channel and program information along with the TV icon if you are viewing the TV. Select Hidden to hide information about the TV channel or program. This information will appear if it is available from the broadcaster. Info Banner appears on the screen each time the channel and external inputs are changed or when DISPLAY on the remote control is pressed.
Clock/Timers	Sleep Timer Set the time in minutes (Off, 15, 30, 45, 60, 90, or 120) that you would like the TV to remain on before shutting off automatically.
	On Timer Turns on the TV from standby mode at a time you set, and tuned to a TV channel or input of your preference. Before setting this function, make sure you set the correct current Time.
	Current Time You can set the current time manually. Select Date (Month/Day/Year) to set the date, then select Time to set the time.
	 <ul style="list-style-type: none"> This TV does not have a battery powered backup for the clock. Therefore, if there is a power failure or if you disconnect the power cord, be sure to reset the current date and time.
Initial Setup	If you miss the Initial Setup when you first connect the TV or if you want to scan all receivable channels, select Initial Setup . Follow the instructions on the screen. Some settings such as Picture, Sound, and Parental Lock will not be affected by this Initial Setup . If you wish to return your TV to factory settings, please see the Troubleshooting section on page 55.
Language	Select to display all on-screen settings in your language of choice: English, Español, Français.
Startup Logo	Select On to display the logo when the TV is turned on. Select Off to disable it.
AV Setup	Manage Inputs Assigns a name to external equipment. Select Auto to display names when the equipment is connected and/or the signal of the equipment is ready to be shown, or Always to display regardless of connection status or Off to disable input (only for TV).
	Video/Component Selection Select Auto to have the TV detect and switch between the Video or Component when Video or Component is connected.



- You can assign following labels for each input (except TV):
–, Cable, Satellite, VCR, DVD/BD, Home Theater, Game, Camcorder, Digital Camera, PC, Edit
- “–” indicates that no labels are assigned.
- If you select **Edit**, you can edit video labels. Follow the same steps for **Edit Channel Labels** on page 42.

Option	Description
BRAVIA Sync Settings	Communicates with equipment compatible with the BRAVIA Sync Control function.
BRAVIA Sync Control	Links the operations of the TV and the equipment. For specific Sony equipment compatible with BRAVIA Sync Control , this setting is applied automatically to the connected equipment when set to On .
Device Auto Power Off	Select On to have your connected equipment with BRAVIA Sync Control function power off automatically when the TV is turned off. Select Off to disable this function. This feature is available when BRAVIA Sync Control is On .
TV Auto Power On	Select On to control your TV's power on from your connected equipment (except MHL-compatible device) with BRAVIA Sync Control function. Select Off to disable this function. This feature is available when BRAVIA Sync Control is On .
Auto Input Change(MHL)	Select On to switch the TV input to the corresponding device connected with an MHL cable.
BRAVIA Sync Device List	Displays a list of equipment with BRAVIA Sync Control function connected to the TV.
Device Control Keys	Select button functions of the TV's remote control to operate the connected equipment.
None	Deactivates the control by the TV's remote control.
Normal	Enables basic operations, such as navigation buttons (up, down, left or right, etc.).
Tuning Keys	For basic operations and operation of channel-related buttons, such as CH +/- or 0-9 , etc. Useful when you control a tuner or set-top box, etc; via the remote control.
Menu Keys	For basic operations and operation of the HOME/OPTIONS buttons. Useful when you select menus of a BD player, etc; via the remote control.
Tuning and Menu Keys	For basic operations and operation of channel-related buttons and HOME/OPTIONS buttons.



- Press **OPTIONS** while the equipment supporting **BRAVIA Sync Control** is connected to display the **Device Control** options. The **Device Control** option provides access to the **Home (Menu)**, **Options** and **Content List** of your connected equipment with your TV remote control.
- Some equipment with **BRAVIA Sync Control** does not support the **Device Control** feature.
- **BRAVIA Sync Settings** must be setup on the connected equipment.

Option	Description
Picture Adjustments Lock	Select Lock so no adjustment can be made to items grayed out, except Picture Mode and CineMotion . Select Unlock to allow adjustment to any of the Picture settings.
Product Support	Contact Sony Sony contact information is available on this screen for your convenience. TV specific information such as Model Name, Serial Number, Software Version and downloadable ratings (if available from the TV) are displayed here.
	Signal Diagnostics Press to display the diagnostics information for the current signal.

Using the Eco Settings

Option	Description
Reset	Resets the current Eco settings to the default values.
Power Saving	Select from Off , Low , High , Picture Off to adjust your TV's power consumption. By selecting the High option, you will reduce the power consumption more than the other available settings. While Picture Off is set, pressing VOL +/- or MUTING buttons will not disable this function. Press other buttons to disable it.
Idle TV Standby	Select to automatically power off the TV after 1 h , 2 h , or 4 h when no buttons are pressed on the remote control or the TV. Select Off to disable this function.
Light Sensor	Optimizes the picture settings according to the ambient lighting.
Auto Shut Off	Select On to automatically power off the TV when no input signal is detected for a certain period of time. Select Off to disable this function.

PC Input Signal Reference Chart for HDMI IN

After connecting the PC to the TV, set the output signal from the PC according to the chart below.

Resolution				Horizontal frequency (kHz)	Vertical frequency (Hz)	Standard
Signals	Horizontal (Pixel)	x Vertical (Line)				
VGA	640	x	480	31.5	60	VGA
SVGA	800	x	600	37.9	60	VESA Guidelines
XGA	1,024	x	768	48.4	60	VESA Guidelines
WXGA	1,280	x	768	47.4	60	VESA
	1,280	x	768	47.8	60	VESA
	1,360	x	768	47.7	60	VESA
SXGA	1,280	x	1,024	64.0	60	VESA
HDTV*	1,920	x	1,080	67.5	60	CEA-861*

* The 1080p timing when applied to the HDMI input will be treated as a video timing and not PC timing. This affects **Picture** settings and **Wide Mode** settings. To view PC content set **Wide Mode** to **Full**, and **Display Area** to **Full Pixel**.



- This TV's HDMI input does not support Sync on Green or Composite Sync.
- Your PC must support one of the above PC input signals to display on the television.
- In plug and play, signals with a 60 Hz vertical frequency will be detected automatically. (PC reboot may be necessary.)

Using a Wall-Mount Bracket

Your TV can be mounted on a wall using a Wall-Mount Bracket (not supplied) out of the box as packaged. If the Table-Top Stand is attached to the TV, the TV may require detaching the Table-Top Stand.

Prepare the TV for the Wall-Mount Bracket before making cable connections.

Sony does not supply the Wall-Mount Bracket or the installing service. For product protection and safety reasons, Sony strongly recommends that installing of your TV on the wall be performed by qualified professionals. Do not attempt to install it yourself.

- Follow the instruction guide provided with the Wall-Mount Bracket for your model. Sufficient expertise is required in installing this TV, especially to determine the strength of the wall for withstanding the TV's weight.
- The length of the screw for Wall-Mount Bracket differs depending on the mounting hook thickness. Please see below illustration.

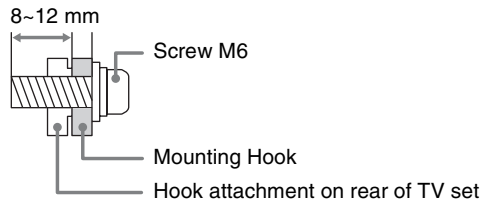

- Be sure to store the unused screws and Table-Top Stand in a safe place until you are ready to attach the Table-Top Stand. Keep the screws away from small children.



- Read the supplied Safety Booklet for additional safety information.

Securing the Attachment Parts

Secure the Attachment Parts to the rear of the TV before attaching the Wall-Mount Bracket.

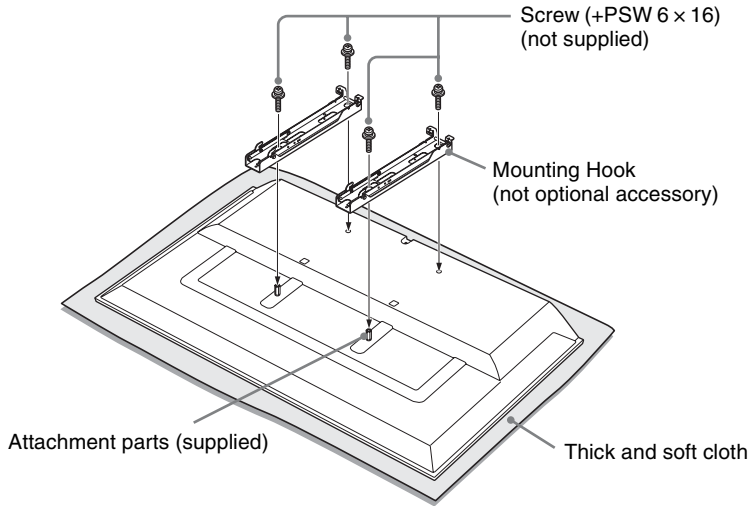

Troubleshooting

Many of the poor pictures and poor sound conditions are related to improper connection of the cables; refer to the Quick Setup Guide provided for connections.

If you have questions, service needs, or require technical assistance related to the use of your Sony TV even after you read this operating instructions manual, contact the following:

For US Support:

<http://www.sony.com/tvsupport> or call 1-800-222-SONY (7669)

For Canadian Support:

<http://www.sony.ca/support> or call 1-877-899-SONY (7669)

■ Things to consider

- Check the input selection by pressing the **INPUT** button. You may be watching the wrong input.
- If you cannot hear sound from the TV, you may have accidentally pressed the **MUTING** button on your remote control; press the **MUTING** button again or press **VOL +** to deactivate muting, or set **Speakers** to **Audio System**.
- If the remote control is not functioning properly, the batteries may be installed incorrectly or may be low or an object or light may be interfering with the remote control.
- To reset the TV to factory default settings:
 - 1 Turn on the TV.
 - 2 Press and hold down the **▲** button on the remote, press the **I/⏻** button on the TV set. (The TV will turn itself off, then back on again.)
 - 3 Release the **▲** button when the TV is turned on.

IMPORTANT: The factory reset will clear all of your customized settings including the **Parental Lock** setting.

When the Password is lost or cannot be remembered, enter the master password: 4357. This password clears your previous password and allows you to enter a new password.

Condition	Explanation/Solution
No picture	<ul style="list-style-type: none">• Check the Power Saving settings (see page 51).
Cannot receive any channels	<ul style="list-style-type: none">• Make sure the power cord is connected securely.• Turn on the power of the TV.• Check cable/antenna connections.• Make sure the Signal Type setting is correct for your TV signal source.

Condition	Explanation/Solution
TV is locked to one channel	<ul style="list-style-type: none"> Perform Auto Program to add receivable channels that are not present in the TV's memory (see pages 19 and 42).
Cannot receive or select channels	<ul style="list-style-type: none"> Perform Auto Program to add receivable channels that are not present in the TV's memory (see pages 19 and 42). To receive or select cable channels, make sure that Signal Type in the Channel settings is set to Cable (see page 42). To receive or select UHF channels over an antenna, make sure Signal Type is set to Antenna.
The TV turns off automatically	<ul style="list-style-type: none"> Check if Sleep Timer is activated (see page 48). Check Idle TV Standby in the Eco settings. Check Duration of Photo Frame Settings. Check Duration if TV is turned on by On Timer.
No picture from some video sources	<ul style="list-style-type: none"> Check the connection between the optional video equipment and the TV. Press INPUT on the remote control (see page 30).
Poor picture	
Picture quality not as good as viewed at the store	<ul style="list-style-type: none"> Picture quality depends on the signal content. See Quick Setup Guide (supplied) to display the best possible picture for that signal.
Broadcast HD formats have poor quality	<ul style="list-style-type: none"> Content and signal quality are controlled by the signal provider. Many HD channels and content are actually upscaled versions of standard-definition broadcasts. The picture is affected by the quality of the signal received, which varies between channel and program.
Double images or ghosts	<ul style="list-style-type: none"> Check cable/antenna connections. Check the antenna location and direction.
Only snow and noise appear on the screen	<ul style="list-style-type: none"> Check if the antenna is broken or bent. Check if the antenna has reached the end of its serviceable life. (3-5 years in normal use, 1-2 years at the seaside.)
Dotted lines or stripes	<ul style="list-style-type: none"> Keep the TV away from noise sources such as cars, motorcycles, or hair-dryers. If using 300 ohm twin lead, move the excess lead away from the TV or try using 75-ohm coaxial cable instead.
No color / Dark picture / Color is not correct / The picture is too bright	<ul style="list-style-type: none"> Adjust the Picture Mode options in the Picture settings (see page 36). If you set the Power Saving mode to Low or High, it will enhance the black level.
Noisy picture	<ul style="list-style-type: none"> Make sure that the antenna is connected using a 75-ohm coaxial cable (not supplied). Keep the antenna cable away from other connecting cords. To avoid TV interference, make sure to use an undamaged antenna cable.

Condition	Explanation/Solution
Blurry picture / Poor color	<ul style="list-style-type: none"> Transporting the TV from a cold to a warm location or a sudden change in room temperature may cause moisture condensation, resulting in a blurry picture or poor color. Turn off your TV and wait a few hours before powering on again.
No sound / Noisy sound	
No sound but good picture	<ul style="list-style-type: none"> Check the volume control. Press MUTING or VOL + so that "Muting" disappears from the screen (see pages 22 and 23). Set Speakers to TV Speakers in the Sound settings (see page 38). If it is set to Audio System, sound is not output from the TV's speakers regardless of the TV's volume control. When using HDMI input with Super Audio CD or DVD-Audio, DIGITAL AUDIO OUT (OPTICAL) may not provide an audio signal. When tuned to a digital channel with Alternate Audio, the broadcaster may not be broadcasting your preferred Alternate Audio language. Press OPTIONS, highlight and select Alternate Audio, and change the Alternate Audio language (see page 38).
Audio noise	<ul style="list-style-type: none"> Make sure that the antenna is connected using a 75-ohm coaxial cable (not supplied). Keep the antenna cable away from other connecting cords. To avoid TV interference, make sure to use an undamaged antenna cable.
No audio or low audio with Home Theater System	<ul style="list-style-type: none"> Set Speakers to Audio System in the Sound settings (see page 38). Set Audio Out to Fixed in the Sound settings (see page 38).
No color / Irregular picture	<ul style="list-style-type: none"> Verify that the Video/Component Selection (see page 48) is set to the current input type in use. We suggest leaving this setting to Auto.
BRAVIA Sync	
Cannot find connected BRAVIA Sync HDMI device	<ul style="list-style-type: none"> Make sure that the BRAVIA Sync Control is set up on both the TV and the optional device compatible with BRAVIA Sync (see page 26).
Second A/V receiver is not listed on the BRAVIA Sync Device List	<ul style="list-style-type: none"> Only one A/V receiver may be used with the BRAVIA Sync and BRAVIA Sync Control functions at one time (see page 49).

Condition	Explanation/Solution
PC connection	
No picture / No signal	<ul style="list-style-type: none"> • Confirm the PC is correctly connected to the TV with the HDMI IN. • Ensure the output signal from the PC is one of the formats listed on page 52. • Turn the PC off. Confirm the PC connection and restart the PC. Plug-and-play will auto-detect the TV and correctly set up PC timing. • Verify the PC is not in standby or hibernation mode.
Poor Picture	<ul style="list-style-type: none"> • Adjust the resolution (see page 52).
General	
TV screen feels warm	<ul style="list-style-type: none"> • Due to the thin profile of this television, the heat generated by the LCD panel backlight and supporting electronics will be more noticeable. This is normal operation and not a cause for concern.
One or more promotional logo(s) appears (appear) on the screen. (Demo Mode)	<ul style="list-style-type: none"> • Press RETURN on the remote control to suspend Demo Mode. Then, press HOME, select Settings and proceed with Initial Setup in the Setup settings. Be sure to select Home on the viewing environment (Location) step.
Wide Mode changes automatically	<ul style="list-style-type: none"> • The current Wide Mode setting is automatically replaced with the 4:3 Default setting when you change the channel or video input, if 4:3 Default in the Screen settings is set to other than Off. If you want to lock in Wide Mode selected with WIDE on the remote control, set 4:3 Default to Off in the Screen settings (see page 40). • Check the Auto Wide option in the Screen settings (see page 40).
Suddenly the picture gets smaller	<ul style="list-style-type: none"> • The picture gets smaller during the commercials due to the method in which the provider broadcasts their content. When HD content channels switch to SD content (commercials), the picture may be small with a black border. • Auto Wide will not expand the picture during these content changes since the content information is regulated by the channel signal provider. You can manually change the Wide Mode if you prefer (see page 29). This setting will remain in effect until you change the channel or input or manually change the Wide Mode again.
“Black box” on screen	<ul style="list-style-type: none"> • You have selected a text option and no text is available (see page 47). To turn off this feature, set the CC Display option to Off. If you were trying to select closed captioning, select CC1 instead of Text1-4.

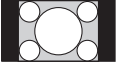

Condition	Explanation/Solution
<p>Black bands appear at the edges of the screen</p> 	<ul style="list-style-type: none"> • Some wide screen programs are filmed in aspect ratios that are greater than 16:9 (this is especially common with theatrical releases). Your TV will show these programs with black bands at the top and bottom of the screen. For more details, check the documentation that came with your DVD/Blu-ray (or contact your program provider). • Programs in 4:3 aspect ratio will have bands on left and right sides of the screen. • Programs broadcast in HD formats (720p and 1080i) with 4:3 content will commonly have black bands on the left and right sides of the screen which are added by the broadcaster (see image on left). • Some cable and satellite set-top boxes can also control the size of the picture. If you are using a set-top box, refer to the manufacturer of the set-top box for more information. • Auto Wide will not expand the picture when the black bands on the sides of the screen are added by the broadcaster. You can manually change the Wide Mode to Wide Zoom, or Zoom to fill the screen, which will remain in affect until you change the channel or input or manually change the Wide Mode again.
<p>Certain programs on DVD or other digital sources display a loss of detail, especially during fast-motion or dark scenes</p>	<ul style="list-style-type: none"> • This is due to the digital compression of the source content used by certain digital broadcasts and DVDs which may cause your TV's screen to display less detail than usual, or cause artifacts (small blocks or dots, pixelations) to appear on your screen. These signal compressions are more visible and are dependent on the clarity and resolution of the TV.
<p>Remote control does not operate</p>	<ul style="list-style-type: none"> • To determine if the problem is with the remote control or not, press a button on the TV. • Check the polarity of the batteries or replace the batteries. • Point the remote control at the remote control sensor located at the front of the TV. • Keep the remote control sensor area clear from obstacles. • Fluorescent lamps can interfere with your remote control operation; try turning off the fluorescent lamps.
<p>Some digital cable channels are not being displayed</p>	<ul style="list-style-type: none"> • Certain cable companies have limitations on the broadcast of digital cable channels. Check with your cable company for more information. • The digital cable channel may be set to Hidden in the Show/Hide Channels setting (see page 42).
<p>Some photo, music, or video files are not displaying from my USB equipment</p>	<ul style="list-style-type: none"> • The accessible file or folder limit in a directory is 1,000 for USB connected equipment. This limit includes non-supported files or just folders. Files or folders are populated based on their time stamps. Photo, music, video files or folders exceeding the limit will not be displayed.
<p>Photo images appear small in the screen</p>	<ul style="list-style-type: none"> • Set display size to expanded. • Whether or not photo images can or cannot be displayed in full-screen depends on the resolution or aspect ratio of the file.

Condition	Explanation/Solution
Photo images or folders take time to display	<ul style="list-style-type: none"> • Depending on the image dimension, file size, and number of files in a folder, some photo images or folders take time to display. • The first time a camera is connected to the TV via USB cable, it may take up to a couple of minutes for the photos to display.
Lost password	<ul style="list-style-type: none"> • Select the Password settings on the Parental Lock settings, then enter the following master password: 4357. This password clears your previous password and allows you to enter a new password (see page 43).
How to reset the TV to factory settings	<ul style="list-style-type: none"> • Turn on the TV. While holding down ▲ on the remote control, press I/⏻ on the TV. (The TV will turn itself off, then back on again.) Release ▲. IMPORTANT: The reset will clear all of your customized settings including the Parental Lock setting.
The TV surrounds become warm	<ul style="list-style-type: none"> • When the TV is used for an extended period, the TV surrounds become warm. You may feel hot when touching there by the hand.

Important Notices

Declaration of Conformity

Trade Name: SONY
Model: KDL-50R450A
Responsible Party: Sony Electronics Inc.
Address: 16530 Via Esprillo,
San Diego, CA 92127 U.S.A.
Telephone Number: 858-942-2230

This device complies with part 15 of the FCC rules. Operation is subject to the following two conditions: (1) This device may not cause harmful interference, and (2) this device must accept any interference received, including interference that may cause undesired operation.

For Customers in Canada

This Class B digital apparatus complies with Canadian ICES-003.

Pour les clients résidant au Canada

Cet appareil numérique de la classe B est conforme à la norme NMB-003 du Canada.

FCC Related Information

This equipment has been tested and found to comply with the limits for a Class B digital device, pursuant to Part 15 of the FCC Rules. These limits are designed to provide reasonable protection against harmful interference in a residential installation. This equipment generates, uses and can radiate radio frequency energy and, if not installed and used in accordance with the instructions, may cause harmful interference to radio communications. However, there is no guarantee that interference will not occur in a particular installation. If this equipment does cause harmful interference to radio or television reception, which can be determined by turning the equipment off and on, the user is encouraged to try to correct the interference by one or more of the following measures:

- Reorient or relocate the receiving antenna.
- Increase the separation between the equipment and receiver.
- Connect the equipment into an outlet on a circuit different from that to which the receiver is connected.
- Consult the dealer or an experienced radio/TV technician for help.

Pursuant to FCC regulations, you are cautioned that any changes or modifications not expressly approved in this manual could void your authority to operate this equipment.

Note

This television includes a QAM demodulator which should allow you to receive unscrambled digital cable television programming via subscription service to a cable service provider. Availability of digital cable television programming in your area depends on the type of programming and signal provided by your cable service provider.

Specifications

System	
Television system	NTSC: American TV standard ATSC (8VSB terrestrial): ATSC compliant 8VSB QAM on cable: ANSI/SCTE 07 2000 (Does not include CableCARD functionality)
Channel coverage	Analog terrestrial: 2 - 69 / Digital terrestrial: 2 - 69 Analog Cable: 1 - 135 / Digital Cable: 1 - 135
Panel system	LCD (Liquid Crystal Display) Panel, LED Backlight
Speaker output	8 W + 8 W
Input/Output jacks	
CABLE/ANTENNA	75-ohm external terminal for RF inputs
VIDEO IN	VIDEO: 1 Vp-p, 75 ohms unbalanced, sync negative AUDIO: 500 mVrms (Typical) / Impedance: 47 kilohms
COMPONENT IN	YPbPr (Component Video): Y: 1.0 Vp-p, 75 ohms unbalanced, sync negative / PB: 0.7 Vp-p, 75 ohms / PR: 0.7 Vp-p, 75 ohms / Signal format: 480i, 480p, 720p, 1080i, 1080p AUDIO: 500 mVrms (Typical) / Impedance: 47 kilohms
HDMI IN 1(ARC) HDMI IN 2/MHL	HDMI: Video: 480i, 480p, 720p, 1080i, 1080p, 1080/24p MHL: Video: 480i, 480p, 720p, 720/30p, 1080i, 1080/30p, 1080/24p Audio: Two channel linear PCM 32, 44.1 and 48 kHz, 16, 20 and 24bits, Dolby Digital PC Input (see page 52)
AUDIO OUT	500 mVrms (typical)
DIGITAL AUDIO OUT (OPTICAL)	PCM/Dolby Digital optical signal
USB	Photo, Music and Video

Model name	KDL-50R450A
Power and others	
Power requirement	110-240 V AC, 50/60 Hz (U.S.A./Canada 120 V AC, 60 Hz)
Power consumption	86 W
in use	
in standby	Less than 0.5 W with 120 V AC and less than 0.5 W with 240 V AC
Screen size*	49.5 (50 class)
(measured diagonally)	
(inches)	
(cm)	125.7
Display resolution	1,920 dots (horizontal) × 1,080 lines (vertical)
Speaker/Full range (2) (mm)	40 × 100
(inches)	(1 ⁵ / ₈ × 4)
Dimensions*	
with Table-Top Stand	1,123 × 679 × 220
(mm)	44 ¹ / ₄ × 26 ³ / ₄ × 8 ³ / ₄
(inches)	
without Table-Top Stand	1,123 × 657 × 91
(mm)	44 ¹ / ₄ × 25 ⁷ / ₈ × 3 ⁵ / ₈
(inches)	
wall-mount hole pattern (mm)	300 × 300
wall-mount screw size (mm)	M6 (length: refer to diagram on page 53)

Model name	KDL-50R450A
Mass* with Table-Top Stand (kg) (lb.)	14.0 30.9
without Table-Top Stand (kg) (lb.)	13.2 29.1
Supplied accessories	Remote control RM-YD092 (1)/Size AAA batteries (2)/Operating Instructions (1)/Quick Setup Guide (1)/Warranty Card (1)/Safety and Regulatory Booklet (1)/Software License (1)/Stand installation guide (1)/Table-Top Stand (1 set)/Screw (4)/Attachment Parts (2)
Optional accessories	Connecting cables / Support Belt Kit

- Optional accessories availability depends on its stock.
- Design and specifications are subject to change without notice.
- * Dimensions and mass are approximate values.

Index

I/⏻ button 25

I/⏻ LED 25

0-9 buttons 22

4:3 Default 40

A

Add Digital Channels 42

Advanced Settings 37

Alternate Audio 38

Analog Fine Tune 42

Audio Description 47

AUDIO OUT 10

Audio Out 38

Auto Display Area 40

Auto Program 19, 42

Auto Shut Off 51

Auto Wide 40

AV Setup 48

B

Backlight 36

Balance 38

BRAVIA Sync Settings 49

Brightness 36

C

CABLE/ANTENNA 9

CC/SUBTITLE button 23

CH +/- button 23

CH/INPUT button 25

Change Password 43

Channel Block 43

CineMotion 36

Clear Voice 38

Clock/Timers 48

Closed Captions (CC) 47

Color 36

Color Temperature 36

Colored buttons 22

COMPONENT IN 9

Country 43

D

DIGITAL AUDIO OUT (OPTICAL)
10

Display Area 40

DISPLAY button 23

Downloadable U.S. Rating 43

E

Edit Channel Labels 42

English Rating 45

Equalizer 38

Equipment Control button 24

External Input Block 43

F

French Rating 45

64

H

HDMI IN 10

HOME button 22

Horizontal Center 40

Hue 36

I

Idle TV Standby 51

Info Banner 48

Infrared Receiver (IR) 25

Initial Setup 48

INPUT button 22

Installing the TV on a wall 53

J

JUMP button 23

L

Language 48

Light sensor 25, 51

M

Movie Rating 44

MPEG Noise Reduction 36

MTS Audio 38

Music 31

MUTING button 23

N

Noise Reduction 36

O

OPTIONS button 23

P

Password 43

PC Settings 41

Photo 31

Photo Frame 32

Photo Frame Settings 46

PIC OFF button 22

Picture 36

Picture Adjustments Lock 50

Picture Mode 36

PIP 27

POWER button 23

Power Saving 51

Product Support 50

R

Rating 43

Reset 36, 38, 51, 60

RETURN button 22

S

Scene Select 36

Settings

Channel 42

Eco 51

Parental Lock 43

Picture 36

Screen 40

Setup 46

Sound 38

Sharpness 36

Show/Hide Channels 42

Signal Type 42

SLEEP button 22

Sound Booster 38

Sound Mode 38

Speaker 25

Speakers 38

Startup Logo 48

Steady Sound 38

SYNC MENU button 22

T

Troubleshooting 55–60

TV Rating 44

U

U.S.A. Rating 45

Unrated 43

USB 10

USB Auto Start 46

V

Vertical Center 41

Video 31

VIDEO IN 9

Viewing Blocked Programs 45

VOL (⏮) +/- button 22, 25

Volume Offset 38

W

WIDE button 23

Wide Mode 40

For Your Convenience

Online Registration:

Be sure to register your TV.

United States <http://productregistration.sony.com>

Canada <http://www.sony.ca/registration>

