

SONY

SONY®

**Multi Format
Switcher System**
MVS-8000/8000SF System (With CCP-8000 Series)

Multi Format Switcher System

MVS-8000/8000SF System
(With CCP-8000 Series Center Control Panel)

User's Guide
Volume 1
2nd Edition (Revised 1)

English

User's Guide English

Volume 1
2nd Edition (Revised 1)

3-206-016-12 (1)

SONY®

MVS-8000/8000SF System

(With CCP-8000 Series Center Control Panel)

User's Guide

Multi Format Switcher System

Volume 1

English

2nd Edition (Revised 1)

Software Version 7.20 and Later

NOTICE TO USERS

© 2001 Sony Corporation. All rights reserved. This manual or the software described herein, in whole or in part, may not be reproduced, translated or reduced to any machine readable form without prior written approval from Sony Corporation.

SONY CORPORATION PROVIDES NO WARRANTY WITH REGARD TO THIS MANUAL, THE SOFTWARE OR OTHER INFORMATION CONTAINED HEREIN AND HEREBY EXPRESSLY DISCLAIMS ANY IMPLIED WARRANTIES OF MERCHANTABILITY OR FITNESS FOR ANY PARTICULAR PURPOSE WITH REGARD TO THIS MANUAL, THE SOFTWARE OR SUCH OTHER INFORMATION. IN NO EVENT SHALL SONY CORPORATION BE LIABLE FOR ANY INCIDENTAL, CONSEQUENTIAL OR SPECIAL DAMAGES, WHETHER BASED ON TORT, CONTRACT, OR OTHERWISE, ARISING OUT OF OR IN CONNECTION WITH THIS MANUAL, THE SOFTWARE OR OTHER INFORMATION CONTAINED HEREIN OR THE USE THEREOF.

Sony Corporation reserves the right to make any modification to this manual or the information contained herein at any time without notice.

The software described herein may also be governed by the terms of a separate user license agreement.

Functions Newly Supported in Version 7.20

The functions newly supported in the MVS-8000 system version 7.20 are as follows.

Functions relating to switcher processor

Classification	Functions supported	Menu No.	See page	
			Vol. 1	Vol. 2
System	1080P/59.94 and 1080P/50 formats and dual link support ^{a)}	7313	245	-
Transition	Preset color mix with an image selected on the utility 2 bus in place of a color matte ^{b)}	1171	342	-
Key	Fixing key fill and key source in key drop off mode (frame delay mode) ^{c)}	1112.4	55, 393	-
Frame memory	Clip transition ^{b)}	1176.1	42, 93	-
	Recording and playback of ancillary data ^{b)}	2525, 7316.8	92	314
	Recording and recalling of extended clip ^{d)}	2521, 2522, 2523	87	-
DME	Applying DME effects to a maximum of three keys on the SDI interface in combination with a dedicated interface ^{b)}	7337.7	-	423
Files	<ul style="list-style-type: none"> • File operations of extended clips ^{d)} • Converting between frame memory clips and extended clips ^{d)} • Importing extended clips ^{d)} 	7151, 7151.1, 7162	205	468, 476, 482
Macros	Creating and editing macro timelines	5441, 5441.1	216	546
	Macro take operation using a GPI input	7325.1, 7352	-	369, 436
	Setting a macro attachment without changing cross-points	7326.6	-	381, 530
	Recalling frame memory clips	-	212	-
	Recording with external devices	-	212	-
	Changing the registers for saving macros	7142.3	-	502
Color corrector	All the internal signals of the switcher can be selected for color correction ^{c)}	7335	-	410

Classification	Functions supported	Menu No.	See page	
			Vol. 1	Vol. 2
Multi program 2	Re-entry between the main and sub sides of the same M/E bank ^{b)}	7331	240	-
	When recalling snapshot, keys on main or sub side can be recalled independently. ^{b)}	-	239	-
Diagnosis	Displaying communication status ^{b)}	7431	-	567

- a) For MVS-8000G only
b) For other than MVS-8000
c) For MVS-8000G/8000GSF only
d) For MVS-8000A or MVS-8000G only

Functions relating to operability

Classification	Functions supported	Menu No.	See page	
			Vol. 1	Vol. 2
Control panel	Inhibiting cross-point button operations	7321.12, 7324	31	334
	Distinguishable color of the shifted button numbers in the Xpt Assign menu	7322.x1	-	346
External devices	Making the USB primary setting automatic	7317	-	316
Macros	Holding down [PRE MCRO] and [POST MCRO] buttons together makes it possible to set a macro attachment in macro only mode	-	218, 259	531
Files	40 or more directories can be created	71xx	-	485
Snapshot	Wipe and DME wipe snapshot operations with menu	1157, 1167	182	-

Functions relating to external devices

Classification	Functions supported	Menu No.	See page	
			Vol. 1	Vol. 2
Audio mixer	Selection of signals linked with the audio mixer	7322, 7322.11	33, 342	350
GPI output	Addition of "Device Recording" to the actions triggered by control panel or DCU GPI output	7325.3, 7354	-	370, 439

Table of Contents

Functions Newly Supported in Version 7.20	3
Chapter 1 MVS-8000 Functions	
Introduction	19
Features of the MVS-8000 Multi Format Switcher System.....	22
Video Processing Flow	24
Signal Selection	25
Basics of Signal Selection	26
Bus Selection	26
Signal Assignment and Selection	29
Signal Name Display	33
Transitions.....	34
Selecting the Next Transition	34
Independent Key Transitions.....	37
Transition Types.....	41
Executing a Transition.....	44
Keys.....	48
Key Types.....	48
Key Modifiers.....	52
Key Memory.....	56
Key Snapshots	57
Blink	57
Key Default	57
Key Modify Clear.....	58
Resizer	58
Wipes	60
Types of Wipe Pattern	60
Pattern Mix	61
Wipe Pattern Variation and Modifiers	63
Wipe Snapshots	71
Wipe Modify Clear.....	71
DME Wipes	72
Types of DME Wipe Pattern	72
DME Wipe Pattern Variation and Modifiers.....	80
Relation Between DME Wipes and Other Effects	81

DME Wipe Snapshots	82
DME Wipe Modify Clear	83
Resizer DME wipes	83
Frame Memory	85
Overview	85
Still Image File Functions	89
Frame Memory Clip Function	92
Image Data Management	94
Image Data Transfer	94
External Hard Disk Drive Access	96
Color Backgrounds	97
Copy and Swap	98
Side Flags	102
Overview	102
Side Flag Settings	102
Wipe Action on Images With Side Flags	103
DME Wipe Action for an Image With Side Flags	104
Video Process	107
Video Process Adjustments of a Primary Input Signal	107
Video Process Adjustments on a Particular Bus	107
Video Process Memory	108
Digital Multi Effects (DME)	109
Three-Dimensional Transformations	110
Transformation Operation Modes	116
Graphics Display	120
Three-Dimensional Parameter Display	122
DME Special Effects	122
Interpolation	151
Key Density Adjustment	152
Key Source Selection	152
Global Effects	152
External Devices	158
Shared Functions for External Device Control	158
Control of P-Bus Devices	159
Control of GPI Devices	160
VTR/Disk Recorder/Extended VTR Control	161
Regions and Registers	165
Regions	165
Registers	166

Keyframes	168
Effects.....	168
Saving and Recalling Effects	169
Effect Attributes	169
Effect Editing	169
Time Settings.....	171
Paths	174
Effect Execution.....	180
Master Timelines	181
Snapshots.....	182
Snapshot Types.....	182
Snapshot Attributes	183
Utility	185
Shotbox	186
Setup	187
Overview of Setup.....	187
System Setup	187
Saving and Recalling Setup Data	194
Panel Setup.....	195
Switcher Setup.....	198
DME Setup	202
Setup Relating to DCU Input/Output	202
Setup Relating to the Router Interface and Tally Interface.....	203
Simple Connection to MKS-8080/8082 AUX Bus Remote Panel (Option).....	204
Files	205
Macros	210
Overview	210
Macro Creation and Editing	212
Macro Execution	215
Macro Timeline	216
Macro Editing Using Menus	218
Macro Attachment	218
Menu Macros.....	222
Color Corrector	223
Simple P/P Software.....	227
Overview	227
Restrictions on Use.....	227
Multi Program 2	230

Overview	230
Sequence of Operations in Multi Program 2	232
Basic Operations (Required)	232
Examples of Operations in the Multi Program 2 Mode (When Sharing a Switcher Bank).....	237
Optional Operations	237
Functions Added in Multi Program 2 Mode	241
Differences Between Multi Program 2 Mode and Standard Mode	242
Restrictions on Using Multi Program 2 Mode	243
Dual Link Support.....	245

Chapter 2 Menus and Control Panel

Names and Functions of Parts of the Control Panel	251
Control Panel: Example Configuration 1 (With Standard Transition Modules)	251
Control Panel: Example Configuration 2 (With Simple Transition Modules)	252
Control Panel: Example Configuration 3 (With Compact Transition Modules)	255
Cross-Point Control Block	256
Transition Control Block (Standard Type).....	260
Flexi Pad Control Block (Standard Type)	264
Key Control Block.....	267
Device Control Block (Trackball)	271
Device Control Block (Joystick)	277
Device Control Block (Search Dial).....	278
Keyframe Control Block	281
Numeric Keypad Control Block.....	284
Fade to Black Control Block	287
Auxiliary Bus Control Block (for AUX Buses)	288
Auxiliary Bus Control Block (for Router Control)	291
Menu Control Block.....	294
Memory Card/USB Adaptor Block	295
“Memory Stick”/USB Connections Block	296
Utility/Shotbox Control Block	298
Transition Control Block and Flexi Pad Control Block (Simple Type).... 299	
Independent Key Transition Control Block (Simple Type)	304
Downstream Key Control Block	306

Downstream Key/Fade-to-Black Control Block	308
Transition Control Block (Compact Type)	310
Basic Menu Operations.....	313
Menu Organization.....	313
About the Top Menu List	313
Accessing Menus.....	314
Displaying a Menu	321
Interpreting the Menu Screen	322
Menu Operations	323
Switching Between the Main Menu Site and Subsidiary Menu Site ..	335
Shortcut Menu	335

Chapter 3 Transitions

Basic Operating Procedure.....	340
Key Priority Setting.....	343
Setting the Key Priority in the Transition Control Block.....	343
Setting the Key Priority by a Menu Operation.....	345
Display of the Key Output Status and Key Priority	346
Selecting the Transition Type by a Menu Operation	348
Super Mix Settings	349
Color Matte Settings.....	350
Executing a Transition	351
Transition Indicator Function	351
Setting the Transition Rate	352
Pattern Limit.....	355
Executing an Auto Transition.....	359
Executing a Transition With the Fader Lever (Manual Transition)	359
Combinations of Auto and Manual Transitions	360
Non-Sync State	360
Fader Lever Operation in Bus Fixed Mode.....	361
Transition Preview	363
Independent Key Transitions	364
Basic Independent Key Transition Operations.....	364
Setting the Independent Key Transition Type by a Menu Operation..	365
Setting the Independent Key Transition Rate.....	366
Fade to Black.....	369
Fade to Black Operation.....	369
Setting the Fade to Black Transition Rate	369
Simple Transition	371

Basic Operations for Simple Transitions.....	371
Display of the Key Output Status and Key Priority	373
Split Fader	373
Independent Key Transitions With a Simple Transition Module.....	374

Chapter 4 Keys

Key Setting Operations Using Menus.....	378
Key Setting Menus	378
Key Type Setting.....	379
Chroma Key Composition.....	381
Chroma Key Adjustments	382
Selecting Key Fill and Key Source	387
Key Edge Modifications.....	390
Masks.....	397
Applying a DME Effect to a Key	400
Specifying the Key Output Destination.....	403
Key Modify Clear.....	404
Blink Function	404
Video Processing	405
Key Setting Operations With the Key Control Block	406
Operations in the Key Control Block	406
Key Edge Modifications.....	410
Masks.....	414
Applying a DME Effect to a Key	415
Other Key Setting Operations	417
Resizer	419
Two-Dimensional Transformations of Keys.....	419
Resizer Interpolation Settings	424
Resizer Crop/Border Settings	424
Applying Resizer Effects.....	427
Key Snapshots.....	433
Key Snapshot Operations	433
Key Snapshot Operations Using a Simple Transition Module.....	435

Chapter 5 Wipes

Basic Procedure for Wipe Settings	438
Wipe Settings Menu	438
Wipe Pattern Selection	438
Pattern Mix	441

Setting Wipe Modifiers	443
Wipe Modify Clear.....	454
Wipe Settings for Independent Key Transitions	455
Basic Procedure for Independent Key Transition Wipe Settings.....	455
Setting Independent Key Transition Wipe Modifiers	456
Wipe Snapshots.....	460
Wipe Snapshot Operations With the Flexi Pad	460
Wipe Snapshot Operations With the Menus	463

Chapter 6 DME Wipes

Basic Procedure for DME Wipe Settings	466
DME Wipe Settings Menu	466
DME Wipe Pattern Selection	466
Setting DME Wipe Modifiers	469
DME Wipe Modify Clear.....	476
DME Wipe Settings for Independent Key Transitions	477
Basic Procedure for Independent Key Transition DME Wipe Settings	477
Setting Independent Key Transition DME Wipe Modifiers.....	478
Resizer DME Wipe Setting	481
DME Wipe Snapshots	482
DME Wipe Snapshot Operations With the Flexi Pad	482
DME Snapshot Operations With the Menus	482
Creating User Programmable DME Patterns	483
User Programmable DME Transition Mode	483

Chapter 7 Frame Memory

Still Image Operations	490
Preparations	490
Interpreting the Frame Memory Menu	490
Selecting an Input Image	494
Selecting Outputs and Target Frame Memory	495
Capturing an Input Image (Freeze).....	496
Recalling Still Images	500
Inverting the Field Polarity of a Saved Still Image (Field Invert Function)	501
Image Processing.....	502
Image Output	507
Continuously Capturing Still Images (Record)	508

Recalling a Continuous Sequence of Still Images (Animation).....	509
Frame Memory Clip Operations.....	512
Preparations for Operation	512
Recalling Clips	512
Clip Playback	514
Clip Creation	518
Creating and Handling Frame Memory Folders.....	520
Clip Output.....	521
Recording and Playback of Ancillary Data	522
Clip Transition Operations.....	524
Image Data Management.....	527
Pair File Processing	527
Moving Files.....	528
Deleting Files	529
Renaming Files	530
File Backups	531
Restoring Files.....	531
External Hard Disk Drive Access	532
Hard Disk Formatting.....	533
Saving Files	533
Recalling Files	535

Chapter 8 Color Backgrounds

Color Background Setting Operations	538
Color Background Settings Menu	538
Basic Color Background Setting Operations.....	538

Chapter 9 Copy and Swap

Basic Copy and Swap Operations	544
Copy and Swap Menu Operations	544
Copy by Button Operation	545

Chapter 10 Misc Menu, Etc.

Misc Menu Operations.....	548
Port Settings for Control From an External Device	548
Editing Keyboard Settings.....	549
Side Flag Settings.....	550
Safe Title Settings	552
Displaying a List of Transition Rates and Changing the Settings.....	553

AUX Menu Operations	555
AUX Bus Settings	555
Status Menu	556
Video Process Settings.....	557

Appendix (Volume 1)

Wipe Pattern List	560
Standard Wipes.....	560
Enhanced Wipes	561
Rotary Wipes	562
Mosaic Wipes	563
Random/Diamond Dust Wipes.....	565
DME Wipe Pattern List	566
DME Wipe Patterns Available in One-Channel Mode	566
DME Wipe Patterns Available in Two-Channel Mode.....	575
DME Wipe Patterns Available in Three-Channel Mode.....	579
Resizer DME Wipe Pattern List	580
Index	582

Chapter 1 MVS-8000 Functions

Introduction	19
Features of the MVS-8000 Multi Format Switcher System	22
Video Processing Flow	24
Signal Selection	25
Basics of Signal Selection	26
Bus Selection	26
Signal Assignment and Selection	29
Signal Name Display	33
Transitions	34
Selecting the Next Transition	34
Independent Key Transitions	37
Transition Types	41
Executing a Transition	44
Keys	48
Key Types	48
Key Modifiers	52
Key Memory	56
Key Snapshots	57
Blink	57
Key Default	57
Key Modify Clear	58
Resizer	58
Wipes	60
Types of Wipe Pattern	60
Pattern Mix	61
Wipe Pattern Variation and Modifiers	63
Wipe Snapshots	71
Wipe Modify Clear	71
DME Wipes	72
Types of DME Wipe Pattern	72

DME Wipe Pattern Variation and Modifiers	80
Relation Between DME Wipes and Other Effects	81
DME Wipe Snapshots	82
DME Wipe Modify Clear	83
Resizer DME wipes	83
Frame Memory	85
Overview	85
Still Image File Functions	89
Frame Memory Clip Function	92
Image Data Management	94
Image Data Transfer	94
External Hard Disk Drive Access	96
Color Backgrounds	97
Copy and Swap	98
Side Flags	102
Overview	102
Side Flag Settings	102
Wipe Action on Images With Side Flags	103
DME Wipe Action for an Image With Side Flags	104
Video Process	107
Video Process Adjustments of a Primary Input Signal	107
Video Process Adjustments on a Particular Bus	107
Video Process Memory	108
Digital Multi Effects (DME)	109
Three-Dimensional Transformations	110
Transformation Operation Modes	116
Graphics Display	120
Three-Dimensional Parameter Display	122
DME Special Effects	122
Interpolation	151

Key Density Adjustment	152
Key Source Selection	152
Global Effects	152
External Devices	158
Shared Functions for External Device Control	158
Control of P-Bus Devices	159
Control of GPI Devices	160
VTR/Disk Recorder/Extended VTR Control	161
Regions and Registers	165
Regions	165
Registers	166
Keyframes	168
Effects	168
Saving and Recalling Effects	169
Effect Attributes	169
Effect Editing	169
Time Settings	171
Paths	174
Effect Execution	180
Master Timelines	181
Snapshots	182
Snapshot Types	182
Snapshot Attributes	183
Utility	185
Shotbox	186
Setup	187
Overview of Setup	187
System Setup	187
Saving and Recalling Setup Data	194
Panel Setup	195

Switcher Setup	198
DME Setup	202
Setup Relating to DCU Input/Output	202
Setup Relating to the Router Interface and Tally Interface	203
Simple Connection to MKS-8080/8082 AUX Bus Remote Panel (Option)	204
Files	205
Macros	210
Overview	210
Macro Creation and Editing	212
Macro Execution	215
Macro Timeline	216
Macro Editing Using Menus	218
Macro Attachment	218
Menu Macros	222
Color Corrector	223
Simple P/P Software	227
Overview	227
Restrictions on Use	227
Multi Program 2	230
Overview	230
Sequence of Operations in Multi Program 2	232
Basic Operations (Required)	232
Examples of Operations in the Multi Program 2 Mode (When Sharing a Switcher Bank)	237
Optional Operations	237
Functions Added in Multi Program 2 Mode	241
Differences Between Multi Program 2 Mode and Standard Mode ...	242
Restrictions on Using Multi Program 2 Mode	243
Dual Link Support	245

Introduction

This manual is the User’s Guide for the MVS-8000/8000SF Multi Format Switcher system. The MVS-8000 and MVS-8000SF have different numbers of M/E banks and input/output signals, but are otherwise functionally identical. This manual refers to these generically as the “MVS-8000 system,” and describes principally the operation of the system using the CCP-8000 series of center control panels.

The User’s Guide for this system comprises two volumes.

Contents of Volume 1

Overview of functions of the MVS-8000 system, and basic switcher operations including transitions, keys, and wipes.

Contents of Volume 2

DME effects, snapshots, keyframes, and various operations such as setup which affect the overall system.

Devices and system nomenclature

In this manual, when discussing the principal components of the MVS-8000 system, in place of the formal product names, abbreviated names characterizing the functions and features are sometimes used. When distinctions between system configurations must be drawn, the terms in the following table are used.

Principal components and naming

The formal product names of the principal components of the MVS-8000 system, and the terms used in this manual are as follows.

Formal product name	Term used in this manual
MVS-8000/8000SF/8000A/8000ASF/8000G/8000GSF Multi Format Switcher Processor ^{a)}	Switcher or switcher processor
MVE-8000 (MKS-8800)/8000A Multi Format DME Processor	DME or DME processor or MVE-8000/8000A
MVE-9000 Multi Format DME Processor	DME or DME processor or MVE-9000
CCP-8000-series Center Control Panel	Control panel or center control panel
DCU-8000 (MKS-8700) Device Control Unit	DCU or MKS-8700
DCU-2000 (MKS-2700) Device Control Unit	DCU or MKS-2700

- a) Where there are differences among the MVS-8000/8000SF system, MVS-8000A/8000ASF system, and MVS-8000G/8000GSF system, these may be noted specifically in the relevant place.

System nomenclature

The following terms are used for systems, depending on the combination of installed options, and the signal format.

System configuration and features	Term for system
System with installed option boards and settings to support HDTV format	HD system
System with installed option boards and settings to support SDTV format	SD system
A system in which the center control panel has four M/E banks	4M/E system
A system in which the center control panel has three M/E banks	3M/E system
A system in which the center control panel has two M/E banks	2M/E system

Related manuals

The following manuals are supplied with the individual products of the MVS-8000 Multi Format Switcher system.

MVS-8400/8300/8200 Switcher Processor Pack

- MVS-8400/8300/8200 Operation Manual
- MVS-8400/8300/8200 Installation Manual

MVS-8000A-C/8000AS-C Switcher Processor Pack

- MVS-8000A-C/8000AS-C Operation Manual
- MVS-8000A-C/8000AS-C Installation Manual

MVS-8000G-C/8000GS-C Switcher Processor Pack

- MVS-8000G-C/8000GS-C Operation Manual
- MVS-8000G-C/8000GS-C Installation Manual

MVS-8000SF-C Switcher Processor Pack

- MVS-8000SF-C Operation Manual
- MVS-8000SF-C Installation Manual

MVE-8000-C DME Processor Pack

- MVE-8000-C Operation Manual
- MVE-8000-C Installation Manual

MVE-8000A DME Processor Pack



- MVE-8000A Operation Manual
- MVE-8000A Installation Manual

MVE-9000-C DME Processor Pack

- MVE-9000-C Operation Manual
- MVE-9000-C Installation Manual

CCP-8000 Center Control Panel Pack

- CCP-8000 Operation Manual
- CCP-8000 Installation Manual

DCU-8000 Device Control Unit Pack

- DCU-8000 Operation Manual
- DCU-8000 Installation Manual

DCU-2000 Device Control Unit Pack

- DCU-2000-C Operation Manual
- DCU-2000-C Installation Manual

Features of the MVS-8000 Multi Format Switcher System

The MVS-8000 Multi Format Switcher system boasts extensible high performance and multifunctionality. The following are some of the principal features of this system.

System configuration flexibility

Multiformat support

This system supports both HDTV and SDTV signal formats. The format selection can be switched by a simple control panel operation. The MVS-8000G supports either the HDTV or SDTV signal format, depending on the software option selection.

Extensible system configuration

By suitable combination of options, the switcher can be configured with various inputs and outputs, and different numbers of M/E banks. The system offers the flexibility to change and expand as required.

You can connect up to two MVE-8000/8000A or MVE-9000 extensible DME processors, each of which provides any number from one to four channels, for a maximum of eight channels of DME functionality.

Powerful external device interfaces

By connecting to a Sony routing switcher or similar, a large system can be built. From the control panel, it is also possible to operate other equipment, including VTRs and disk recorders.

Powerful tally system

The complete system including routing switcher provides an all-inclusive tally system. The system can be adapted to different applications and settings, using multiple tally outputs, including both on-air and recording tallies.

Comprehensive video manipulation

M/E banks

Each mix/effects bank (M/E bank) is equipped with four keyers, and each keyer is capable not only of chroma keying, but also independent key transitions separate from the background transitions. The four keys can be freely combined, to carry out four different program outputs.

Powerful frame memory functions

In an MVS-8000 system, an HDTV system can hold 58 still image frames (88 frames in 720P/59.94 format), and an SDTV system can store 222 frames in memory, while up to eight frames can be recalled and used simultaneously. In an MVS-8000A system and MVS-8000G system, an HDTV system can hold approximately 1,000 still image frames or 2,000 frames in 720P/59.94 format, and an SDTV system can hold approximately 5,000 frames in 480i/59.94 format or 4,000 frames in 576i/50 format in memory, and up to eight frames can be recalled and used simultaneously.

Link operation with DME

By means of the dedicated DME interface, a range of DME functions including DME wipes and processed keys can be handled as switcher functions.

By connecting two MVE-8000/8000A or MVE-9000 units, in any combination, you can interface to a maximum of eight DME channels.

Note that the MVE-8000A and MVE-9000 can also be used with this system by connecting through an SDI interface.

Designed for use in a live broadcasting environment

Flexible control panel layout

Because of its modular design, the various sections of the control panel can be laid out as required. This allows a flexible layout appropriate to the system operation.

High-performance user interface

The menu control block provides a large color LCD panel, with rapid touch-panel menu selection.

The source name displays and buttons in the Flexi Pad™ and shotbox control blocks have color backlit LCD displays. The signal names, and graphical representations of the patterns associated with buttons provide intuitive feedback, and allow the immediate decisions that are required in a live operating environment.

Video Processing Flow

The following illustration shows the flow of operations for carrying out a transition on an M/E bank or the PGM/PST bank.

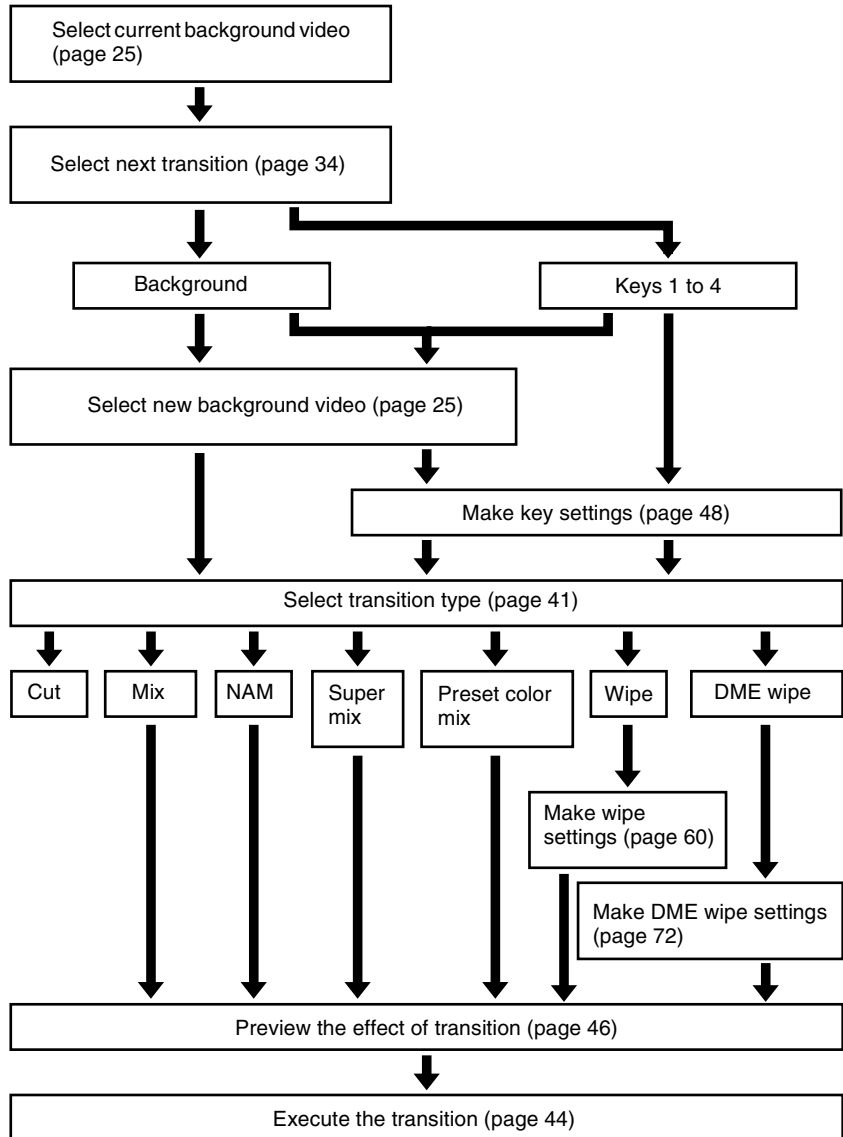

Signal Selection

You carry out signal selection with the cross-point buttons in the cross-point control block of each M/E bank or the PGM/PST bank, and the buttons in the auxiliary bus control block.

The number of buttons in each cross-point row may be 16, 24, or 32, but here the description is of the 32-button case as an example.

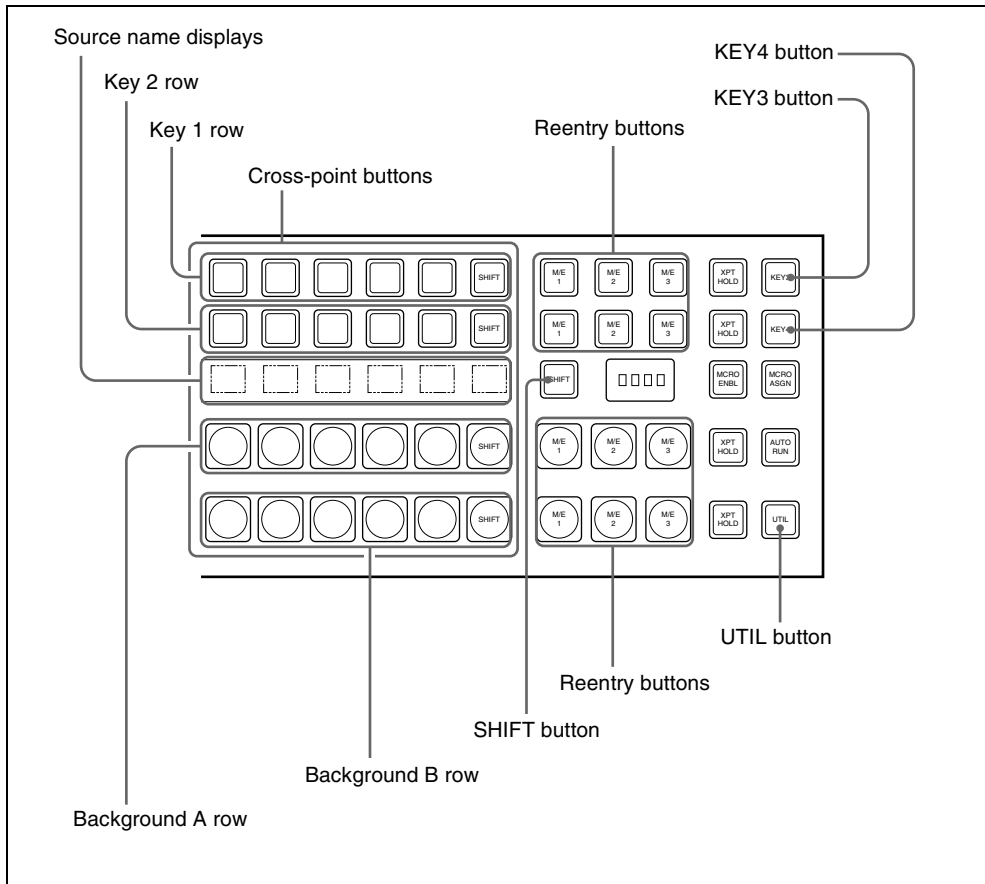

Cross-point control block

Basics of Signal Selection

Each of the M/E banks, PGM/PST bank and auxiliary bus control block has 32 cross-point buttons and three reentry buttons (four in the case of the auxiliary bus control block).

These buttons are identified by numbers common to all of the banks and block, and a signal is assigned to each number.

The basis of signal selection is to select, in a cross-point button row, the cross-point button to which is assigned the desired signal.

Reentry buttons

To use the output of one M/E bank as background input to another bank, use the reentry buttons [M/E1], [M/E2], and [M/E3] (on the auxiliary bus control block, [M/E1], [M/E2], [M/E3], and [PGM]) in the cross-point control block of the destination bank.

For example, to feed the output from the M/E-1 bank as the background B input to M/E-2, in the M/E-2 cross-point control block, press the [M/E1] button in the background B row.

Bus Selection

Each row of 32 cross-point buttons is shared by multiple buses.

For example, in the M/E-1 bank, the key 1 row of buttons can be assigned either to the key 1 bus or to the key 3 bus. The [KEY3] button switches between these two assignments.

To assign a bus to the cross-point buttons in the auxiliary bus control block, press one of the AUX delegation buttons to select the bus.

The following table illustrates the correspondence between buses and cross-point button rows, and the delegation operations.

Bank	Bus name	Cross-point button row	Delegation operation
M/E-1, M/E-2, M/E-3	Background A bus ^{a)}	Background A row	–
	Background B bus ^{a)}	Background B row	–
	Key 1 bus	Key 1 row	Turn off the [KEY3] button
	Key 2 bus	Key 2 row	Turn off the [KEY4] button
	Key 3 bus	Key 1 row	Turn on the [KEY3] button
	Key 4 bus	Key 2 row	Turn on the [KEY4] button



Bank	Bus name	Cross-point button row	Delegation operation
PGM/PST	Program bus ^{a)}	Program row	–
	Preset bus ^{a)}	Preset row	–
	DSK 1 bus	DSK1 row	Turn off the [DSK3] button
	DSK 2 bus	DSK2 row	Turn off the [DSK4] button
	DSK 3 bus	DSK1 row	Turn on the [DSK3] button
	DSK 4 bus	DSK2 row	Turn on the [DSK4] button
M/E-1, M/E-2, M/E-3, PGM/PST	Utility 1 bus	Background A row	When [UTIL] button mode is Hold, hold down the [UTIL] button
	Utility 2 bus	Background B row	
	DME external video bus	Key 1 row	Hold down the [UTIL] button
	DME utility 1 bus	Key 2 row	Hold down the [UTIL] button, and press the [KEY4] button, turning it off
	DME utility 2 bus		Hold down the [UTIL] button, and press the [KEY4] button, turning it on



Bank	Bus name	Cross-point button row	Delegation operation
Auxiliary bus control block	AUX1 to AUX48 buses	1st row, 2nd row	Turn on the appropriate buttons in accordance with the signal assignment made in the Setup menu.
	MONITOR 1 to MONITOR 8 buses		
	Frame memory source 1 and frame memory source 2 buses		
	DME 1 to DME 8 video buses		
	DME 1 to DME 8 key buses		
	Edit preview bus		
	M/E-1 UTILITY 1 and M/E-1 UTILITY 2 buses		
	M/E-2 UTILITY 1 and M/E-2 UTILITY 2 buses		
	M/E-3 UTILITY 1 and M/E-3 UTILITY 2 buses		
	P/P UTILITY 1 and P/P UTILITY 2 buses		
	M/E-1 Key 1 fill to M/E-1 Key 4 fill buses		
	M/E-1 Key 1 source to M/E-1 Key 4 source buses		
	M/E-2 Key 1 fill to M/E-2 Key 4 fill buses		
	M/E-2 Key 1 source to M/E-2 Key 4 source buses		
	M/E-3 Key 1 fill to M/E-3 Key 4 fill buses		
	M/E-3 Key 1 source to M/E-3 Key 4 source buses		
	DSK 1 fill to DSK 4 fill buses		
	DSK 1 source to DSK 4 source buses		
	M/E-1 external DME bus		
	M/E-2 external DME bus		
	M/E-3 external DME bus		
P/P external DME bus			
DME UTILITY 1 and DME UTILITY 2 buses			

a) Dual background bus mode (see below) can be selected.

Dual background bus mode

In this mode, the shifted signal on the background A row can be selected on the key 1 row, and the shifted signal on the background B row can be selected on the key 2 row.

To switch this mode on and off, it is necessary to assign this function to the [PRE MCRO] button in the cross-point control block.

For details of the assignment operation, see “Overall Control Panel Settings (Config Menu)” in Chapter 16 (Volume 2).

Note

For the following switcher banks, dual background bus mode is not available.

- When set to “Dual M/E Assign”
- When M/E Config is set to “DSK”

Signal Assignment and Selection

Assigning signals to buttons

Each of the 32 cross-point buttons and reentry buttons has a corresponding button number, to which you assign a signal.

In addition to the signals input to the PRIMARY INPUTS 1 to 80 connectors (1 to 34 connectors for the MVS-8000SF/8000ASF/8000GSF) on the rear panel of the switcher, you can also select signals generated within the switcher. Each button has assigned to it a video signal and a key signal, forming a pair. You can set these video and key combinations in a Setup menu.

For details of Setup menu operations, see “Cross-Point Settings (Xpt Assign Menu)” in Chapter 16 (Volume 2).

Cross-point button control block button numbers

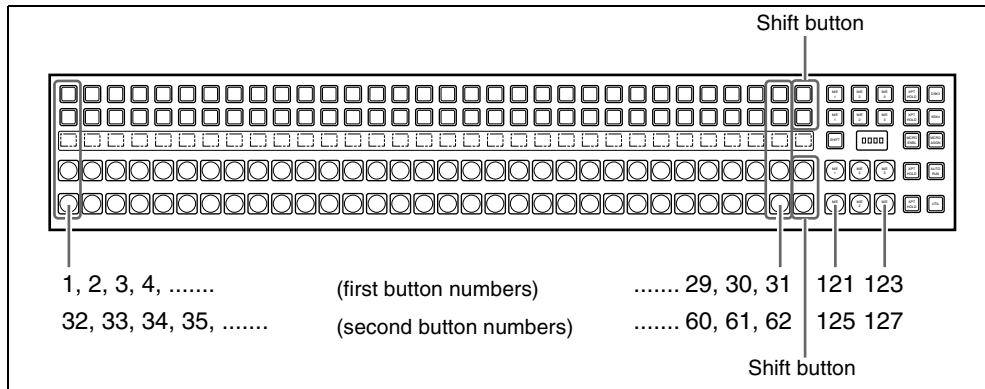

On each M/E bank and the PGM/PST bank, each cross-point button and reentry button has two button numbers, and you use the shift button to switch between these numbers.

In the case of a 32-button layout, the button numbers are as follows.

Cross-point control block button numbers

Button	Number when the shift button is not pressed	Number when the shift button is pressed
From the left end to the 31st button	1 to 31	32 to 62
Reentry buttons	121 to 123	125 to 127

Note

On the MVS-8000A/8000G, you can use the rightmost button (number 32) as a [SIDE FLAG] button. In this case, the shift button moves one to the left, to number 31, and the button numbers are offset by one.

For details of the [SIDE FLAG] button, see “Cross-Point Settings (Xpt Assign Menu)” in Chapter 16 (Volume 2).

Switching button numbers

The rightmost (32nd) button functions as a shift button.

(The shift button function can be disabled in a Setup menu.)

When selecting the signals of button numbers 1 to 31, press the cross-point button for the desired signal.

To select button numbers 32 to 62, hold down the shift button, and press the cross-point button for the desired signal.

Button numbers in the auxiliary bus control block

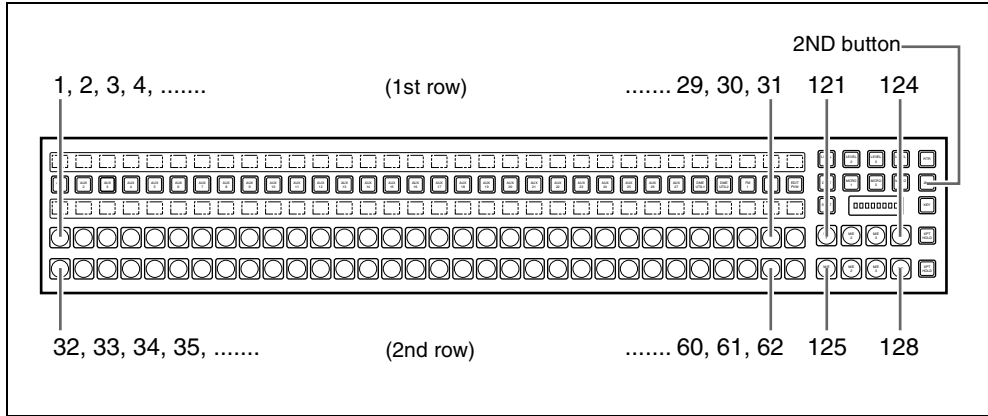

When the [2ND] button is unlit

The cross-point buttons and reentry buttons in the auxiliary bus control block have separate upper (1st row) and lower (2nd row) numbers. In the case of a 32-button layout, the button numbers are as follows.

Auxiliary bus control block button numbers ([2ND] button unlit)

Button	Button	Button numbers
1st row	From the left end to the 31st button	1 to 31
	Reentry buttons	121 to 124
2nd row	From the left end to the 31st button	32 to 62
	Reentry buttons	125 to 128

When the [2ND] button is lit

Different buses can be assigned to the 1st-row buttons and 2nd-row buttons. When the 32nd button is set as a shift button, the 1st-row buttons and 2nd-row buttons both have the following button numbers.

Auxiliary bus control block button numbers ([2ND] button lit)

Button	Number when the shift button is not pressed	Number when the shift button is pressed
From the left end to the 31st button	1 to 31	32 to 62
Reentry buttons	121 to 124	125 to 128

Inhibiting cross-point button operations

For each cross-point button, you can temporarily inhibit operations.



Note

This setting is cleared when you reset the control panel.

Assigning a button to the function of disabling cross-point button operation

You can assign the button to be used for the operation to the [PRE MCRO] button, in setup. (See Chapter 16, “Overall Control Panel Settings (Config Menu)” (Volume 2))

You can also use the [Inhibit Set] and [Inhibit All Clear] functions, assigned to user preference buttons. (See Chapter 16, “Setting Button Assignments (Prefs/Utility Menu)” (Volume 2))

Buses for which operations can be inhibited

This setting applies to the AUX control block and switcher bank cross-point buttons.

For example, if you make the setting for one cross-point button in a switcher bank, this inhibits operation of all cross-point buttons with the same number in the following buses.

The corresponding name also disappears from the source name display.

- Background A, background B
- Keys 1 to 4
- Utility 1, utility 2
- DME utility 1, DME utility 2
- External DME

To inhibit operation of a cross-point button

Hold down the button which “Inhibit Set” is assigned, and press the cross-point button whose operation you want to inhibit.

The button you pressed flashes amber, and this makes the operation inhibited.

Note

Even when you inhibit operation of a cross-point button, macro attachment settings are still possible (see page 218).

To clear a cross-point button operation inhibit setting

Hold down the button to which “Inhibit Set” is assigned, and press the button whose operation is inhibited (flashing amber).

This clears the operation inhibit setting for the button you pressed.

To clear all operation inhibit settings

Press the button to which “Inhibit Set” is assigned and the button to which “Inhibit All Clear” is assigned simultaneously.

Selection of signals linked with the audio mixer

When you select a signal in a switcher bank background A row or AUX bus control block which is set to be linked with the audio mixer, the program output of the audio mixer follows the signal selection.

For details of the setting, see Chapter 16, “Cross-Point Settings (Xpt Assign menu)” (Volume 2).

Note

- For details of audio mixers that can be connected, contact your Sony service or sales representative.
- When the signal is switched with a snapshot, keyframe, and so on, the audio mixer is not linked.
- When bus fixed mode is selected in setup (*see page 45*), the audio mixer program output is linked to the bus output as the background.

Signal Name Display

You can attach a name (source name) to each signal assigned to a cross-point button, with a maximum of 16 characters.

- The source name displays in the cross-point control block and auxiliary bus control block show the source names of the video signals assigned to numbers 1 to 31.
- To display the source names for numbers 32 to 62, press the [SHIFT] button to the right of the source name displays.
- To display the source names of the key signals assigned to buttons, hold down the [SPLIT] button in the key control block or the [KEY] button in the auxiliary bus control block.

Colors of lit cross-point buttons

In a particular row of cross-point buttons, only the last pressed button is effective, and lights amber or red. The amber indicates the “low tally” state, and the red indicates the “high tally” state, to indicate whether or not the selected signal appears in the final output video.

Significance of colors of lit cross-point buttons

Color	State	Significance
Amber	Low tally	Does not appear in final output video
Red	High tally	Appears in final output video

Transitions

In the M/E banks and PGM/PST bank, the switch from the current video stream (appearing on the corresponding program monitor) to a new video stream is referred to as a transition.

Selecting the Next Transition

To execute a transition, it is first necessary to decide how the image will be changed as a result of the transition. This selection is carried out using the next transition selection buttons (*see page 261*) in the transition control block of each M/E or PGM/PST bank.

For details of operations, “Basic Operating Procedure” (page 340).

In the M/E banks and PGM/PST bank, you can change one of the images, the background, and keys 1 to 4 (downstream keys 1 to 4 in the PGM/PST bank), and also vary combinations of these simultaneously. The following are examples of transition.

Changing the background

A background transition switches from the video currently selected on the background A bus (the current video) to the video selected on the background B bus (the new video).

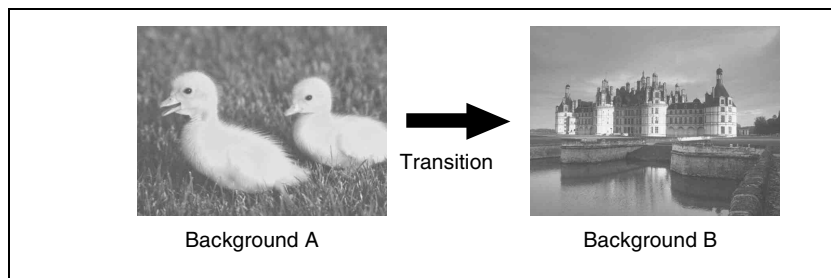

In the default selection of flip-flop mode (*see page 45*), the background always switches in the direction from the A bus to the B bus. When the transition completes, the cross-point selections on the A and B buses are interchanged.

Inserting and deleting a key

You can insert one or more of the four keys (downstream keys on the PGM/PST bank).

If you select a key which is already inserted, the transition will delete the key. A simultaneous combination of deleting and inserting keys is also possible.

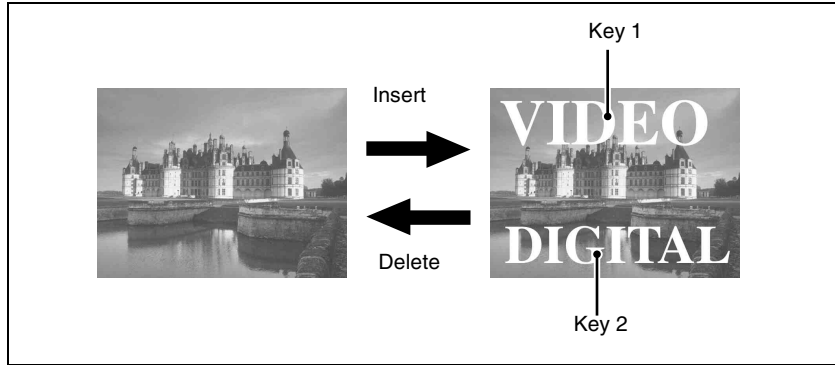

Inserting or deleting key 1 and key 2

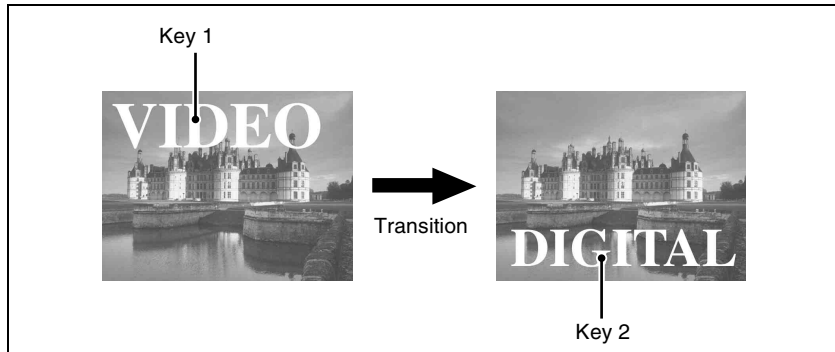

Deleting key 1 and inserting key 2

Simultaneously changing the background and keys

You can change any of the four keys (downstream keys on the PGM/PST bank) and the background at the same time.

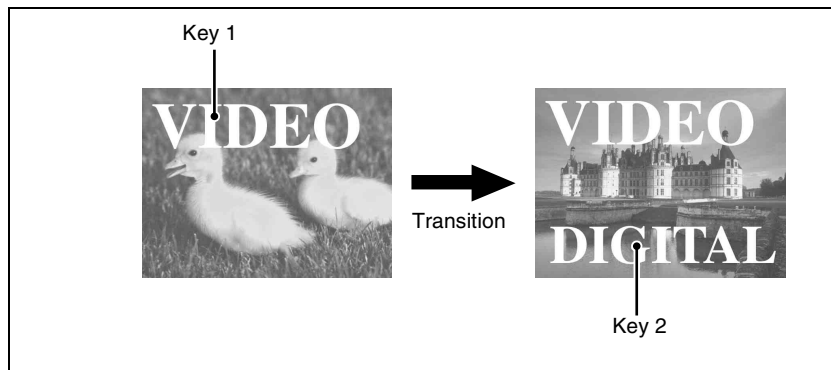

Changing the background and key 2 simultaneously

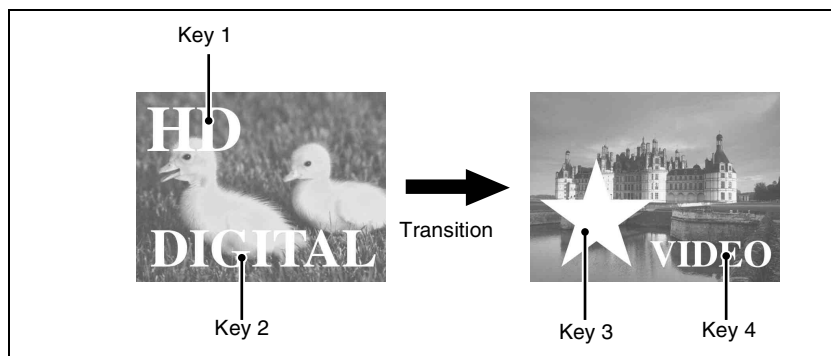

Changing the background and keys 1 to 4 simultaneously

Selecting the key priority

If a number of keys are already inserted in the current video, you can check or change the key priority, that is to say, the order in which the keys are overlaid. When a key priority ([KEY PRIOR]) is selected as the next transition, you can also change the key priority in the new video.

For details of this operation, see “Key Priority Setting” (page 343).

The key priority values go from 1 to 4, with a higher priority key being “in front” as seen on the screen.

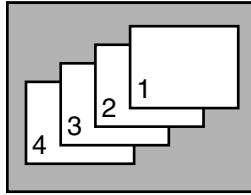

Priority sequence on the screen

Independent Key Transitions

What is an independent key transition?



In addition to common transitions, it is possible to carry out independent transitions on the keys of the M/E banks and PGM/PST bank. These are called “independent key transitions.”

By carrying out an independent key transition in combination with a common transition, different transition types can be used for the background and keys. It is also possible to use different transition types for key insertion and key deletion by means of a Setup menu setting.

For details of this operation, see “Basic Independent Key Transition Operations” (page 364).

The following description compares the independent key transition with a common transition, taking a simultaneous change of the background and key as an example.

Video used in the transition

		
Background A	Background B	Key to insert



Effect of a common transition

In the case shown in the previous illustration, carrying out a common transition produces the following change in the image.

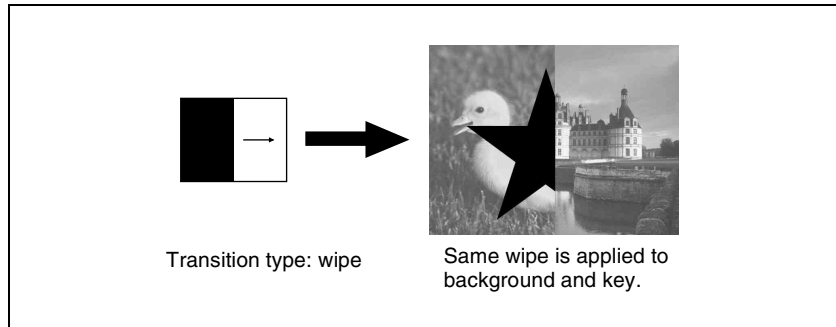

Effect of a common transition

Effect of use with an independent key transition

The key is inserted with an independent key transition as the background changes with a common transition, providing the following result.

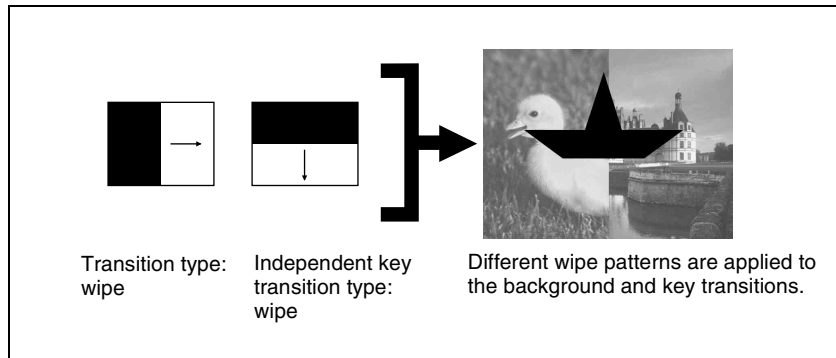

Effect of a background transition and independent key transition

Combining other transitions with independent key transitions

When you set a common transition and a key independent transition for the same key, you can apply two different effects such as a wipe and mix (dissolve) (*see page 41*) to the key simultaneously.

When carrying out such a combination of transitions simultaneously on a key as auto transitions (*see page 45*), the result depends on the timing of pressing the respective [AUTO TRANS] buttons.

Simultaneous execution

If the [AUTO TRANS] buttons for the two transitions are pressed simultaneously, the following is the result.

Note that in both cases the common transition is a wipe and the independent key transition is a mix (dissolve).

Deleting a key with simultaneous transitions: With the key inserted, it is deleted simultaneously with the two transitions.

When the common transition completes, even if the independent key transition is still not completed, the two end simultaneously.

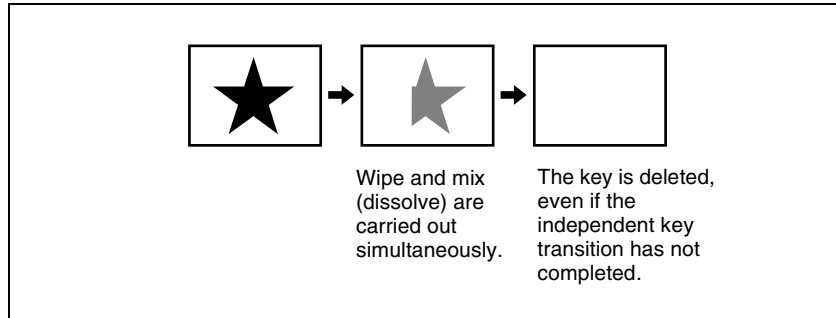

Deleting a key with simultaneous transitions

Inserting a key with simultaneous transitions: With the key not inserted, it is inserted simultaneously with the two transitions. If the common transition or independent key transition ends first, the other continues to completion.

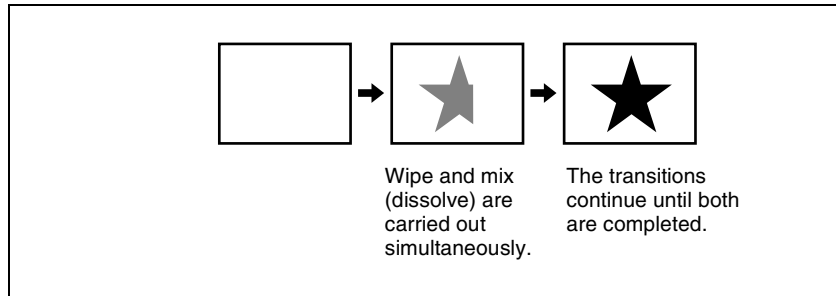

Inserting a key with simultaneous transitions

Time offset execution

If the [AUTO TRANS] buttons for the two transitions are pressed with a time offset, the following is the result.

Note that in both cases the common transition is a wipe and the independent key transition is a mix (dissolve).



Time offset execution with the key inserted: With the key inserted, it is deleted with the two transitions acting with a time offset.

Whichever button is pressed first, when the common transition completes, even if the independent key transition is still not completed, the two end simultaneously.

Example: When the independent key transition [AUTO TRANS] button is pressed later

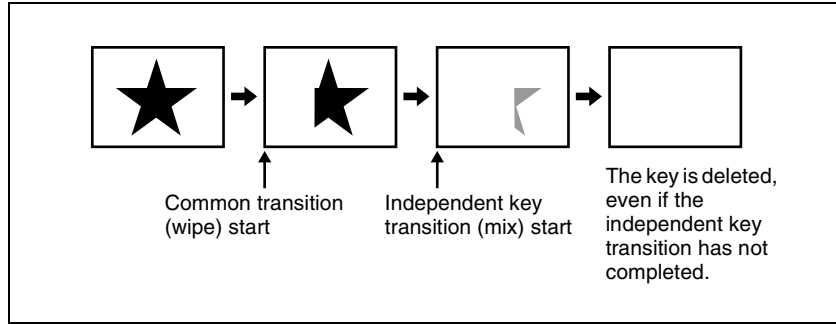

Time offset execution with the key inserted

Time offset execution with the key not inserted: With the key not inserted, it is inserted with the transition whose [AUTO TRANS] button is pressed first.

Since the key is then in the inserted state, with the transition whose [AUTO TRANS] button is pressed later, the key is deleted. When the key is completely deleted, both transitions complete.

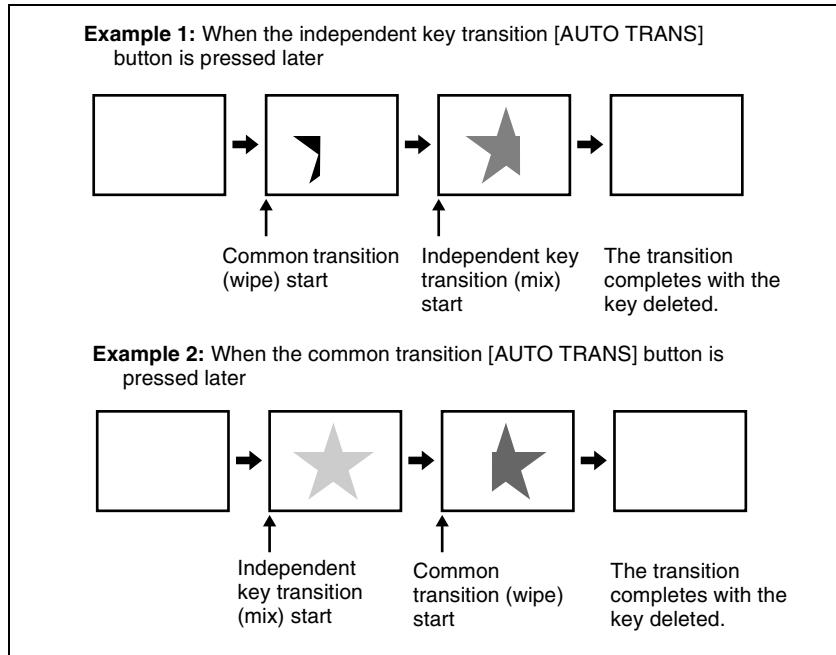

Time offset execution with the key not inserted

Transition Types

Selecting the transition type determines the way in which the transition occurs. Carry out the type selection with the transition type selection buttons in the transition control block of each M/E or PGM/PST bank.

For details of this operation, see “Basic Operating Procedure” (page 340).

The following are the transition types.

Mix

This is a dissolve, in which the new video progressively fades in over the current video, with the sum of the two video outputs maintained constant. At the mid-point of the transition (when the fader lever is in the center position), the output of each is 50%.

This transition type can also be selected for an independent key transition. In this case, the key either dissolves in or dissolves out similarly, with the progress of the transition.

NAM (non-additive mix)

In this dissolve, the current video and new video signals are compared, and the signal with the higher luminance level is given priority in the output. The current video is maintained at 100% output for the first half of the transition as the new video increases progressively to 100%, then the current video is progressively reduced from 100% to zero in the second half with the new video maintained at 100% output.

Note

This transition type is not available for an independent key transition.

Super mix

In this dissolve, the current video is maintained at 100% output for the first half of the transition as the new video is mixed while increasing progressively to 100%, then the current video is progressively reduced from 100% to zero in the second half with the new video maintained at 100% output.

Note that you can set the output levels of the current and new video signals at the mid-point of the transition, in the range 0 to 100%. (See “*Super Mix Settings*” (page 349).)

Note

This transition type is not available for an independent key transition.

Preset color mix

This is a two-stage dissolve, comprising two transitions, the first a dissolve to a color matte, and the second from the color matte to the new video.

In the first transition, the current video is replaced by the color matte in a mix (dissolve), then in the second transition the color matte is replaced by the new video also in a mix (dissolve). You can specify the color matte by luminance, saturation, and hue values. (See “*Color Matte Settings*” (page 350).)

Also, in place of a color matte you can use an image selected on the utility 2 bus.

Notes

- This transition type is not available for an independent key transition.
- In the multi-program mode, you can use a preset color mix only when selecting the background for the next transition.

One-stroke mode and one-time mode

- You can make a setting such that a preset color mix is carried out in a single transition. This is called “one-stroke mode.”



Note

When the bus fixed mode is selected with a Setup menu setting, a preset color mix is always carried out in the one-stroke mode.

- You can also make a setting such that when a preset color mix is completed, the next transition switches to the previous transition type automatically. This is called “one-time mode.”

When only the background is changed

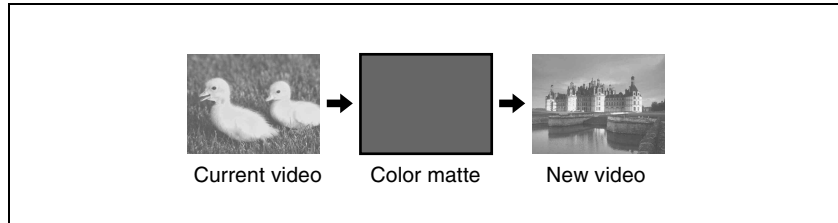

Preset color mix (changing background only)

When a key is inserted

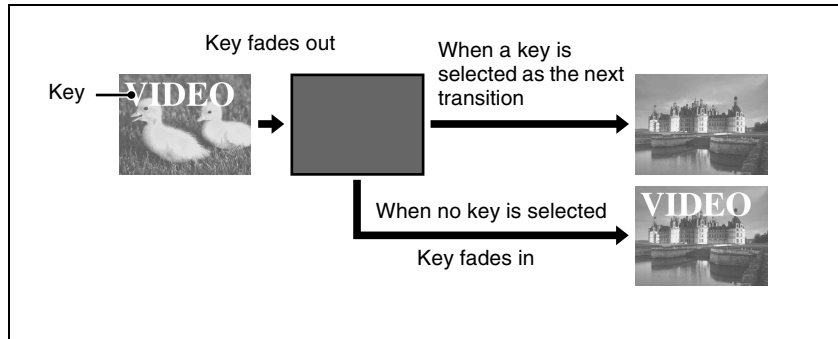

Preset color mix (transition including key)

By means of a Setup menu setting, it is possible to preserve the key state while carrying out the color matte mix.

When, with a key inserted, a key is selected in the next transition

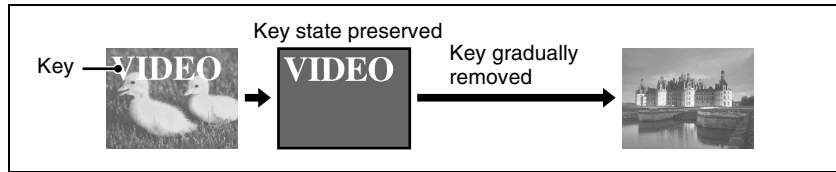

Preset color mix (when set to preserve key state)

Wipe

A wipe replaces the current video by the new video according to a predetermined pattern. This transition type can also be selected for an independent key transition.

For details, see “Wipes” (page 60) and Chapter 5 “Wipes” (page 437).

DME wipe

Using a DME effect, it is possible to obtain a transition to a new image from the current image, as in a wipe. You can also use this transition type as an independent key transition.

For details, see “DME Wipes” (page 72) and Chapter 6 “DME Wipes” (page 465).

Clip transitions

Linked to a mix (dissolve) or wipe transition, a frame memory clip (movie) is played back.

Note

The clip transition function is only supported on the MVS-8000A/8000G.

Cut

A cut switches instantaneously from the current video to the new video. When the next transition is a key transition, the key cuts in or out instantaneously.

Executing a Transition

There are two modes of executing a transition: an auto transition by button operation or a manual transition using the fader lever.

It is also possible to combine both methods, taking control with the fader lever of an auto transition which has partly completed, or complete a transition started with the fader lever as an auto transition.

By combining common transitions with independent key transitions, different transition types can be applied to the background and keys, for example allowing a key wipe combined with a background dissolve. (See “*Executing a Transition*” (page 351).)

When the audio mixer is linked in setup, you can carry out an auto transition, and also switch the sound with the audio mixer. (See “*Transition linked to the audio mixer*” (page 342).)

Auto transitions

Cut

A cut switches instantaneously from the current video to the new video. When the next transition is a key transition, the key cuts in or out instantaneously.

Auto transition

The transition from the current video to the new video is carried out automatically at a constant rate, using the transition effect selected as the transition type.

You can set the transition rate in advance. (See “*Setting the Transition Rate*” (page 352).)

Manual transitions

Using the fader lever, you can manually control the progress of the transition. Moving the fader lever from one end of its travel to the other completes the transition.

Flip-flop mode and bus fixed mode

The following describes the difference between flip-flop mode and bus fixed mode, taking an M/E bank as an example; the functionality is the same, however, on the PGM/PST bank.

Normally, when a background transition is carried out on an M/E bank, the signals selected on the A and B rows of cross-point buttons are interchanged at the end of the transition. That is to say, except during a transition, the background output is always from the background A bus. This is called “flip-flop mode.”

The alternative is known as “bus fixed mode,” in which there is no bus interchange. In this mode, when the fader lever is at the top of its travel the output from the A bus is always 100%, and when the fader lever is at the bottom of its travel the output from the B bus is 100%.

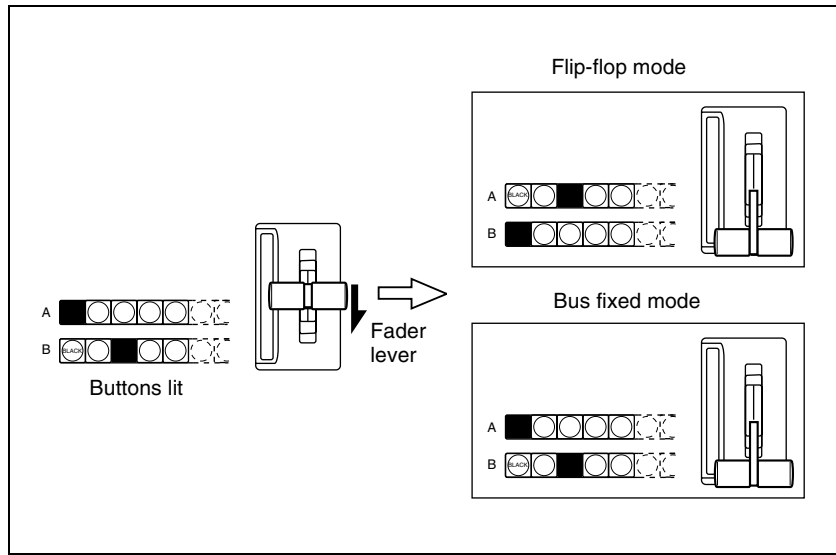

Flip-flop mode and bus fixed mode

For details of fader lever operation in bus fixed mode, see page 361.

Transition preview

With the preview output of the M/E banks and PGM/PST bank, you can check the effect of a transition in advance. To carry out a transition preview, press the [TRANS PVW] button in the transition control block. (See “Transition Preview” (page 363).)

Note

In multi-program mode, DSK mode (page 199) or bus fixed mode (page 45), it is not possible to carry out a transition preview.

Pattern limit

When a wipe or DME wipe pattern is selected for the transition, you can specify the range of movement of the wipe pattern through the course of the transition, for each bank independently.

When the pattern limit function is enabled, carrying out a transition results in the following effect for example settings.

- When the limit value is set to 50%, the effect at the end of the transition is the same as when the fader lever is at the center position in the normal case (with the pattern limit function disabled); the wipe pattern does not complete.
- When the limit value is set to 0%, the wipe effect is completely disabled, and carrying out the transition produces no change in the image.

- When the limit value is set to the maximum 100%, the image changes in exactly the same way as when the pattern limit function is off, but when the transition is completed, the cross-point selections on the background A and B buses do not interchange.

You can specify the limit value either by entering a numeric value in the menu, or by operating the fader lever to set the fader lever position. (See “*Pattern Limit*” (page 355).)

Note

The pattern limit function is not available in an independent key transition.

Fade to black

The PGM/PST bank provides a fade-to-black function, controlled with the [FTB] button in the fade to black control block. (See “*Fade to Black*” (page 369).)

Note

In multi-program mode or DSK mode, it is possible to carry out a fade-to-black on a number of programs simultaneously.

You can also make a Setup menu setting such that a fade-to-black does not apply to particular programs.

For details of the setting, see “Settings Relating to Video Switching (Transition Menu)” in Chapter 16 (Volume 2).

Keys

A key is an effect in which a part of the background image is replaced by an image or superimposed text. The signal determining how the background is cut out is termed “key source,” and the signal that replaces the cut-out part is termed “key fill.” The system component responsible for processing a key is referred to as a keyer.

Each M/E bank and the PGM/PST bank has four keyers, and all of these keyers provide the same functions.

Key Types

The key type indicates the manner in which the key source signal is used to cut out the background. In each bank, you can use the following key types. You can select the key type using the key type selection buttons in the key control block, or by a setting in the Type menu for the keyer. (*See “Key Type Setting” (page 379).*)

- Luminance key
- Linear key
- Color vector key
- Chroma key
- Wipe pattern key
- Key wipe pattern key

Luminance key

The background is cut out according to the luminance (Y) of the key source signal, and at the same time the key fill signal is cut out and then added to the background signal.

Linear key

This is a type of luminance key, but there is a reduced variability in gain, allowing more precise adjustment.

Color vector key

The key signal is created from a combination of the luminance and chrominance components of the key source signal. When perfect keying is not possible with a luminance key, this allows a key signal to be created even if the luminance level is low, provided that the colors have high saturation.

Clean mode

In a luminance key, linear key or color vector key, you can enable the clean mode. When the clean mode is on, the key source does not affect the key fill, which is added unchanged to the background. This improves the keyed image quality, but means that the part of the key fill signal which is not to be inserted must be completely black, or it will color the background. You set the clean mode with the Type menu of the respective keyer. (See “Setting the key type in a menu” (page 379).)

Note that in the following situations, the clean mode goes off, and cannot be turned on.

- When the key type is a pattern key
- When key inversion is on
- When the key fill is a matte
- When the key edge is an outline
- When the key edge is normal with soft edge being on
- When fine key is on
- When the key positioner is on

Chroma key

A key signal based on a particular color is used to cut out the background, and the key fill is then inserted. The inserted signal is also referred to as the foreground, and the composite image is called a chroma key image.

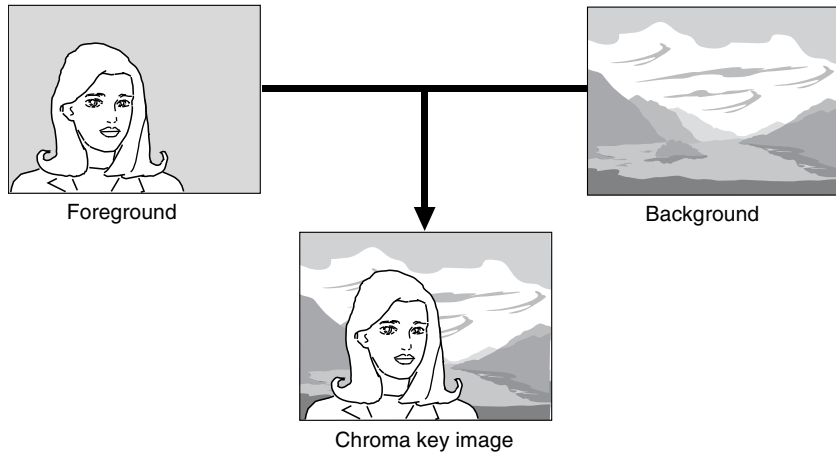

Normal mix and additive mix

In creating a chroma key image, either a normal mix or an additive mix can be used. To select which, use the Type >Chroma Adjust menu for the keyer. (See “Chroma Key Composition” (page 381).)



Normal mix: The foreground is cut out with the key signal, and then combined with the background, which has also been cut out with the key signal.

Additive mix: The background, which has been cut out with the key signal, is combined with the unshaped foreground. This is effective for a natural-looking composite when the scene includes glass or other translucent objects.

Plane function

In an additive mix, the foreground is not shaped by the key signal, and variations in the (blue) background appear in the composite image. To prevent this, it is possible to set a particular luminance level for the background, and any parts below this level are cut forcibly.

Methods of adjusting the composite obtained from chroma keying include automatic adjustment with the auto chroma key function, and manual adjustment carrying out the necessary processing separately. The optimum results will be obtained by first carrying out adjustments with the auto chroma key function, then making any fine adjustments as required.

The following manual adjustments are possible.

Key active

When this function is off, only the foreground is output and you can make adjustments of color cancel (*see the next paragraph*).

Color cancel

If the foreground image includes shades of the background color, turn this function on to remove the color from the foreground image.

Chroma key window

You can adjust the range over which the key signal is determined as matching the specified hue. When this adjustment is off the default ranges are used.

Chroma keying generates a key signal based on a particular color (reference color) in the foreground (typically a plain blue background), and the “window” refers to the range of colors which are regarded as matching this specified reference color to create the key signal.

As seen on a vectorscope (that is, in the hue-saturation color space), the range for this matching corresponds to a truncated sector. This range is specified by two parameters: the “Angle” parameter, which determines the range of the hue parameter, and the “Crop” parameter, which determines the degree of truncation (*see the following figure*).

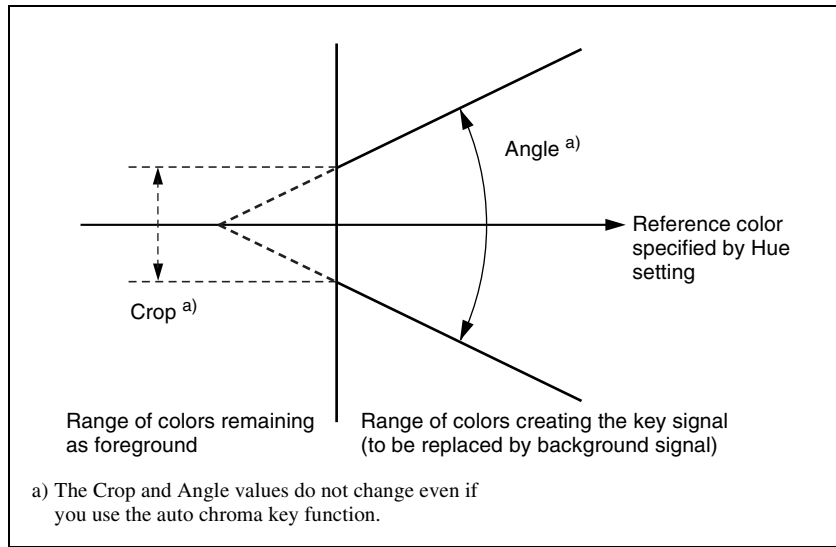

Window adjustment

Y balance

In normal chroma keying, the key signal is based on the chrominance component only, and all elements of the foreground with the same hue are replaced by the background. Using the Y balance function, you can specify a luminance level range within which the key is active, and replace the specified part by the background.

You can use the Y balance function independently on the key signal for the composition and the key signal for the color cancel function. When applied to the key signal for the composition, this produces the foreground with the color cancel effect applied. This can therefore be used to provide an impression of smoke, for example.

When the Y balance function is applied to the color cancel key, the relevant part is output in its original color without canceling, and therefore it is possible to combine colors which are the same color as the background (i.e. typically blue) in the foreground.

Chroma key shadow

This function provides a more realistic treatment when the shadow of an object in the field of view falls on the blue background. Since parts of the blue background darker than a specified intensity are treated as shadows, there is no effect on cutting out of the foreground.

Video signal adjustment

You can vary the foreground signal gain, or change the hue. There are separate adjustments for the gain of the overall video signal, and Y and C components.

For details of video adjustment operations and the adjustment items, see “Chroma Key Adjustments” (page 382).

Wipe pattern key

This uses the wipe pattern selected for a transition as the key source.

Key wipe pattern key

This uses the wipe pattern selected for an independent key transition as the key source.

Note on wipe pattern modifiers

In a wipe pattern key or key wipe pattern key, you can apply various modifications, depending on the pattern used, and the modifiers in common with a wipe.

However, modifiers which relate to the wipe direction and edge are not reflected.

Key Modifiers

Edge modifiers

You can apply borders and other effects to the edge of the key. (See “Key Edge Modifications” (pages 390 and 410).)

Normal

This is the state with no key edge modifiers applied.



Border

This applies a uniform width border to the edge of the key. You can adjust the border width and density. You can also enable the separate edge function, and adjust the top, bottom, left, and right border widths separately.

**Drop border**

This applies a border below and to the right for example, of the key. You can adjust the border width, position, and density.

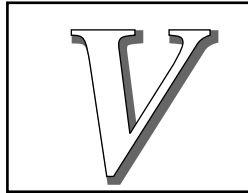
**Shadow**

This applies a shadow below and to the right for example, of the key. You can adjust the shadow width, position, and density.

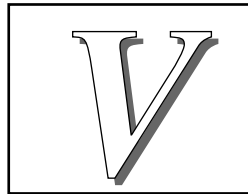



Outline

This uses the outline of the original key as the key. You can adjust the width and density of the outline. You can also enable the separate edge function, and adjust the top, bottom, left, and right outline widths separately.



Emboss

This applies an embossing effect to the outline of the key. You can adjust the width and position of the embossing, and the density. You can adjust the density separately for key fill and key edge. When embossing is on, the Fine Key and zabton functions go off.

Soft edge

This softens the edge of the key.

Zabton

This inserts a translucent pattern behind a key. You can adjust the pattern size, softness, density and color.

Edge type and key fill/key source position

The key edge modification function has two modes: a mode (“key drop ON mode”) in which the key fill/key source position moves downward, and a mode (“key drop OFF mode”) in which it does not move downward.

Key drop ON mode: The key fill/key source position moves downward by eight scan lines or four scan lines. When a drop border or shadow is selected, it is possible to apply a border to the top edge of the key.

Key drop OFF mode: The key fill/key source position does not move. When a drop border or shadow is selected, it is not possible to apply a border to the top edge of the key.

In the key drop ON mode, a menu setting selects between the mode (“4H mode”) in which the key fill/key source position is lowered by four scan lines, and the mode (“8H mode”) in which the key fill/key source position is lowered by eight scan lines.

When Fine Key is on, the edge width is forced to the range 0.00 to 4.00.

Note that in the following situations, the key drop mode is forcibly turned on.

- When the edge type is border, outline, or emboss
- When the edge type is normal with soft edge being on
- When Fine Key is on

To fix key fill / key source in key drop off mode

In the Edge menu, switch frame delay mode on (*see page 393*).

Regardless of the fine key and edge type settings, key fill and key source are fixed in key drop off mode. In this mode key image has a one-frame delay.

Notes

- This function is only valid on the MVS-8000G/8000GSF.
- This function uses the resizer, and therefore the normal effect of the setting is not obtained while using DME wipe or other effect that uses the resizer.

Edge fill

When a border, drop border, or shadow modifier is selected, you can select a signal to fill these edge effects.

The edge fill may be either the signal from the dedicated color matte generator, or the signal currently selected on the utility 1 bus.

In the case of an outline, there is no edge fill signal selection, because the key fill signal fills the outline, and the rest of the image remains as the background. For the emboss effect, in place of the edge fill signal, the emboss fill matte 1 and emboss fill matte 2 signals are used.

Masks

A mask is used to inhibit the effect of a key over a part of the image. This allows parts of the background which would otherwise be keyed to be protected, or to correct the key if it is not of the desired shape.

For details of masking operations, see “Masks” (pages 397 and 414).

Key mask and background mask

There are two types of mask: a key mask and a background mask.

Key mask: This masks out a part of the key, which will result in the background appearing.

Background mask: This masks out a part of the background, which will result in the key fill appearing.

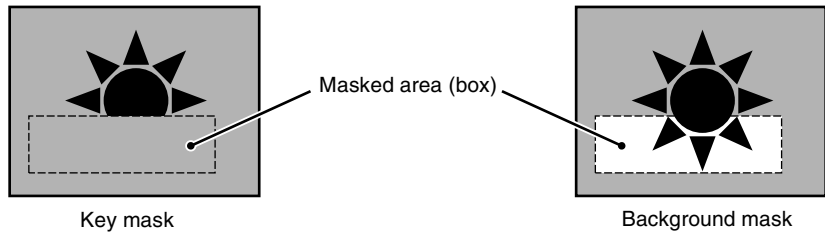

Main mask and subsidiary (“sub”) mask

Each keyer allows two masks to be used simultaneously, and these are referred to as the main mask and the sub mask. The signal that determines the mask shape and size is termed the mask source, and different sources are used for the main mask and sub mask.

Main mask: This uses the signal from the dedicated box generator provided on each keyer, or the signal from the dedicated pattern generator as the mask source.

When the box generator is selected, a rectangular mask is formed. You can adjust the positions of the four sides of the box separately.

When the pattern generator is selected, you can select the pattern and apply modifiers.

Sub mask: This uses the wipe generator signal or the signal selected on the utility 1 bus, as the mask source.

When the wipe generator is selected, the patterns and the pattern modifiers are the same as in a wipe transition.

Key Memory

The key memory function allows the keyer settings on each cross-point button to be automatically stored, so that the next time the same cross-point button is selected these settings are recalled automatically.

There are two modes for key memory: simple mode and full mode.

The parameters stored in each mode are as follows.

Simple mode: key type, clean mode (including the plane setting for chroma keying), key position, key inversion, and adjustment values for the particular key type (Clip, Gain, Density, Filter, etc. This includes color vector key, wipe pattern key, key wipe pattern key, and chroma key. However, in the case of a chroma key, it excludes color cancel, Y balance, foreground CCR, window, and shadow.)

Full mode: All settings except transition (the same parameters as simple mode, Fine Key, key modifiers, main and sub mask settings, chroma key detailed settings, and so on)

For the settings for these modes, see “Settings Relating to Keys, Wipes and Frame Memory (Key/Wipe/FM Menu)” in Chapter 16 (Volume 2).

Key Snapshots

Key settings other than the key on/off status and the key priority can all be instantaneously saved in a dedicated register, for recall when required. A key snapshot comprises three values: a cross-point button number, key memory full mode, and independent key transition, and can be called in any combination. There are four key snapshot registers for each keyer.

For details of key snapshot operations, see “Key Snapshots” (page 433).

Blink

The blink function provides the following effects.

Key blink: The key is inserted and deleted at the specified frequency.

You can also set the frequency and the proportion of the cycle for which the key is inserted.

Edge blink: Key fill and key edge fill are interchanged at the specified frequency. You can specify both the frequency and the proportion of the cycle for which the interchange occurs.

The blink settings are in the Transition menu for each key. (*See “Blink Function” (page 404).*)

Key Default

With a simple operation you can return the key adjustment values to their defaults.

The adjustment values which can be returned to their default values are as follows.

- Adjustment values for the particular key type (Clip, Gain, Density, Filter, etc.)
In the case of chroma keying, all adjustment values return to their default values.
- Key position
- Key inversion

- Clean mode

For details, see “Returning the key adjustment values to their defaults” (page 418).

For the menu operation to return the key adjustment values to their defaults, see “Returning to default state in function groupings” (page 324).

Key Modify Clear

A simple button operation or a menu operation returns the key settings to the initial status settings.

For details of the initial status, see “Selecting the State After Powering On (Start Up Menu)” in Chapter 16 (Volume 2).

For the menu operation to return the key state to that set in initial status, see “Returning to default state in function groupings” (page 324).

Resizer

Resizer allows you to apply DME-like effects such as image shrinking, magnification and movement, as well as change of the aspect ratio, to the processed key.

The following functions are available.

- Two-dimensional transformations of keys
- Resizer interpolation settings
- Resizer crop/border settings
- Resizer effect settings
(wide key border, drop shadow, edge enhance, mosaic, defocus, mask)

Notes

- The resizer function is supported on the MVS-8000G only.
- The image of the key manipulated by resizer has a one-frame delay.
- Some effects of resizer are different from what you would expect of DME effects.

Restrictions on the use of effects

There are restrictions on combined use of resizer effects themselves and that with DME wipes.

For details, see “Impossibility of simultaneous use within the same keyer” (page 432).

Relation between resizer and other effects

You cannot apply DME effects to a key for which the resizer function is enabled. When one of the three functions – resizer, DME wipe and DME effects – is enabled, the other two are disabled.



Wipes

A wipe is a transition from the current video stream to a new video stream, using a wipe pattern.

Changing the background by means of a wipe is referred to as a “background wipe,” and inserting or deleting a key with a wipe is termed a “key wipe.”

There are two types of wipe: those that can be selected in a common transition, and those that can be selected in an independent key transition.

For details of independent key transitions, see page 37.

Types of Wipe Pattern

The patterns that can be used for a wipe are divided into a number of groups, as follows. Note that only the standard wipe patterns can be used for an independent key transition.

For wipe patterns, see “Wipe Pattern List” in Appendix (Volume 1) (page 560).

Standard wipe patterns

Patterns consisting of straight lines vertically, horizontally, or diagonally, and circular patterns.

Enhanced wipes

More complex shapes such as hearts, stars, and round corners.

Rotary wipes

These patterns involve rotation of the image about a point.

Mosaic wipe pattern

This divides the image into small tiles.

Random and diamond dust wipe patterns

These patterns consist of small random tiles, or fine particles.

Pattern Mix

You can create a new pattern by combining two selected patterns (main and “sub”).

Note

It is not possible to apply a pattern mix to an independent key transition.

For details, see “Pattern Mix” (page 441).

Types of pattern mix

There are four ways in which patterns can be combined in a pattern mix, as follows.

Mix: The effect of the sub pattern is applied to the main pattern, modifying the outline or nature of the main pattern.

Positive NAM (+Nam): Creates a pattern with an outline which contains all points within the outlines of either of the main pattern and the sub pattern.

Negative NAM (-Nam): Creates a pattern with an outline which contains all points within the outlines of both of the main pattern and the sub pattern.

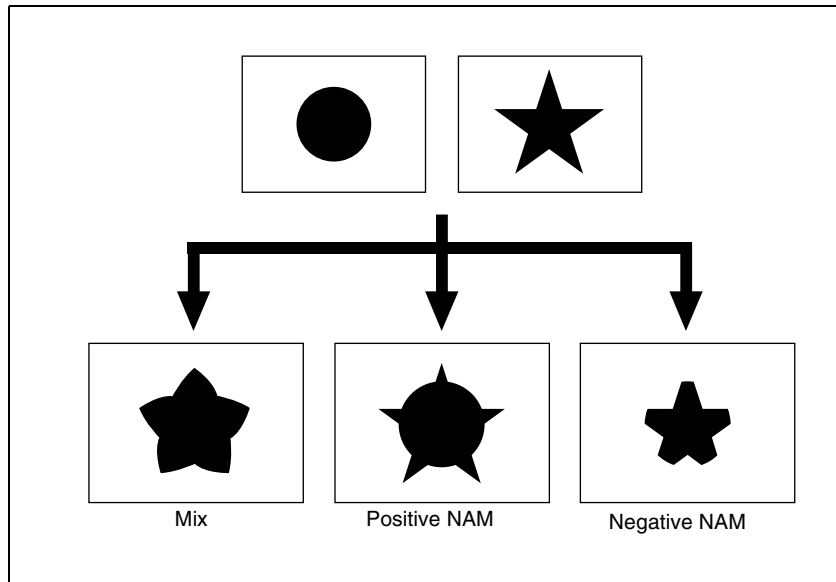

Morphing: As the transition progresses, the pattern morphs from the main pattern, through the “mix” combination, to the sub pattern.

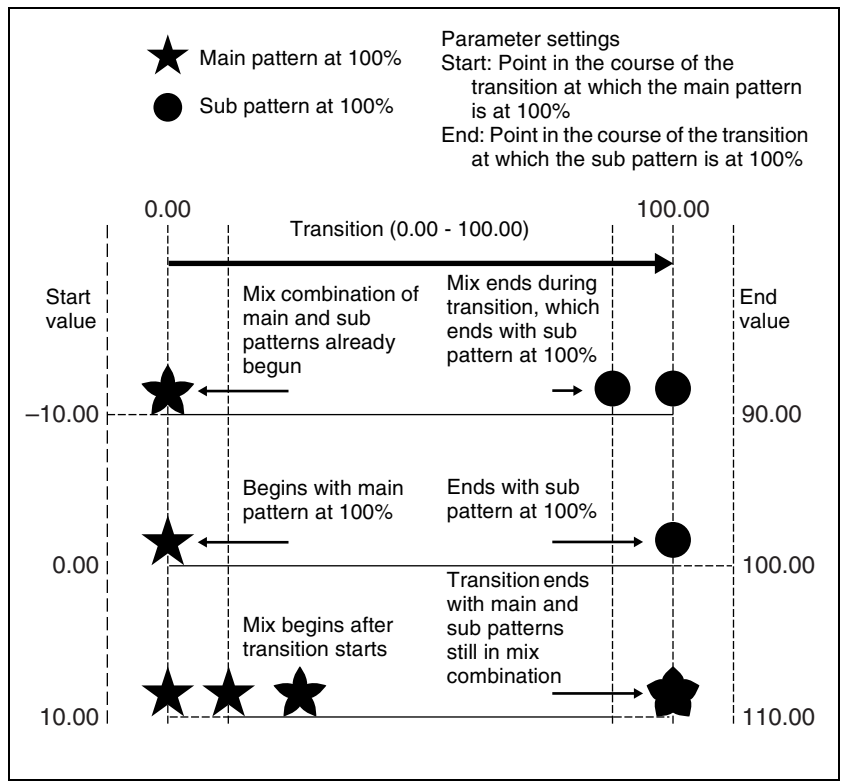

- A value of 0.00 corresponds to the beginning of the transition, and a value of 100.00 to the end of the transition.
- A negative Start value signifies that the main and sub patterns are already combined when the transition starts.
- An End value of 100.00 or more signifies that the main and sub patterns are still combined when the transition complete.
- If the Start and End values are the same, the main and sub patterns are interchanged instantaneously at the corresponding point in the transition.
- If End is less than Start, as the transition proceeds, it changes from the sub pattern to the main pattern.

Dust mix

You can apply the effect of a diamond dust wipe to a selected pattern. You can also apply the diamond dust wipe effect to the pattern resulting from a pattern mix. (See "Pattern Mix" (page 441).)

When the pattern mix function is off, turning dust mix on results in the main pattern and the diamond dust pattern being mixed. This state is the same as a pattern mix when the diamond dust pattern is selected for the sub pattern.

Main and sub modifier link function

When carrying out a pattern mix, it is possible to link the modifier settings for the main pattern and sub pattern. There are two modes for this function.

FULL LINK (fully linked) mode

In this mode, all modifier settings are the same for the main pattern and sub pattern.

Changing the modifier settings for one pattern automatically changes the settings for the other.

SEMI LINK (semi-linked) mode

Only the parameter settings of the modifiers are linked. The modifier on/off settings are not linked. When the parameter values for the modifiers of the main pattern and sub pattern are different, then after this link mode is selected, changing the value of a parameter for one pattern changes the value of the parameter for the other pattern to maintain the same difference between the two.

Note

When carrying out a wipe transition using a pattern mix, it is recommended that you set the modifier link function to “FULL LINK” mode.

If the link function is off, or SEMI LINK mode is selected, the desired effect may not be obtained at the start or end of the transition.

Wipe Pattern Variation and Modifiers

You can carry out a wipe with the following variations and modifications to the selected pattern.

For details, see “Setting Wipe Modifiers” (page 443).

Direction

You can specify the direction of the wipe: the regular direction is referred to as “normal,” and the other direction as “reverse.” You can also select alternating directions each time the transition is completed (normal/reverse mode).

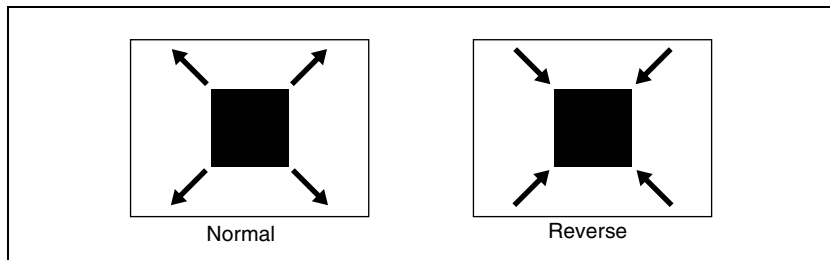

Split

This splits the pattern, making the parts of the wipe move in opposite directions.

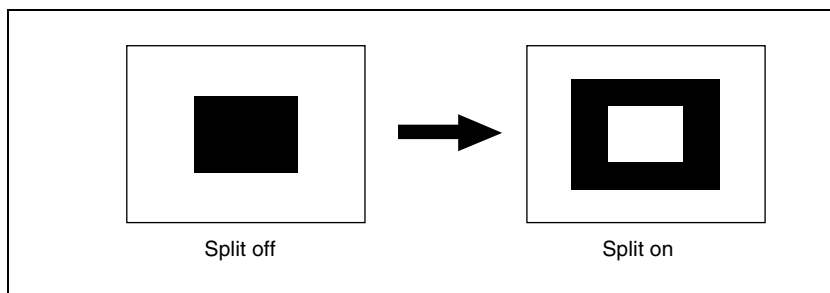

The parameter `Split No` specifies the number of splits.
The parameter `Spacing` specifies the spacing between adjacent patterns.

Edge

You can apply a border to the pattern, soften the edges, or soften the applied border.

In an independent key transition, only the “Soft” setting is available.

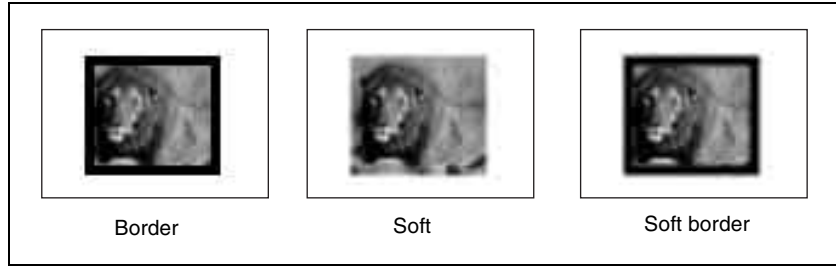

Border: You can adjust the border width.

Soft: You can adjust the edge softness.

Soft border: You can adjust the border width, and the softness of the inner and outer edges of the border.

When a border or soft border is selected, the signal filling the border is called edge fill. For the edge fill, you can use a matte generated by the dedicated color matte generator, or the signal selected on the utility 2 bus. A matte can include color 1 and color 2, and a combination of the two colors (a “color mix”).

Positioner

You can move the wipe pattern to any position.

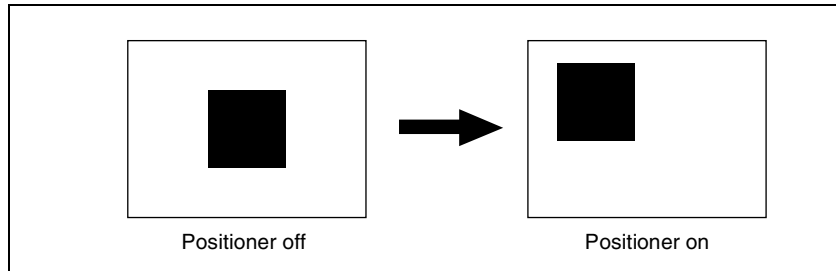

- The parameter H Position controls the horizontal position of the pattern. A negative value moves the pattern to the left, and a positive value moves the pattern to the right.
- The parameter V Position controls the vertical position of the pattern. A negative value moves the pattern down, and a positive value moves the pattern up.

Rotation

You can rotate the pattern. There are three rotation modes, as follows.



Angle

This carries out a wipe with the pattern in a fixed angle.

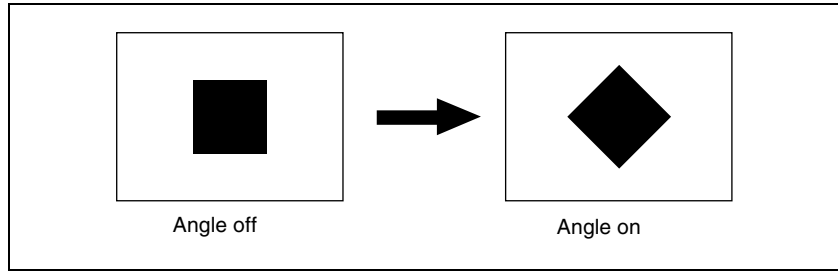

The parameter Angle determines the angle of pattern rotation. A value of -100.00 of the parameter Angle corresponds to one whole turn counterclockwise; a value of $+100.00$ corresponds to one whole turn clockwise. With a value of 0.00 there is no rotation.

Speed

Through the course of the transition the wipe pattern rotates at a fixed specified speed.

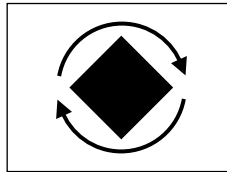

The parameter Speed determines the speed of pattern rotation. A value of -100.00 of the parameter Speed corresponds to one turn per second counterclockwise; a value of $+100.00$ corresponds to one turn per second clockwise. With a value of 0.00 the pattern is stationary.

Magnitude

Through the course of the transition the wipe pattern rotates through the specified angle.

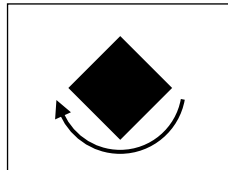

The parameter Angle determines an angle of pattern inclination at the beginning of the transition.

- A value of -100.00 corresponds to the angle rotated one whole turn counterclockwise.
- A value of $+100.00$ corresponds to the angle rotated one whole turn clockwise.
- With a value of 0.00 the pattern is stationary.

The parameter Magnitude determines an angle of pattern rotation through the course of the transition.

- A value of -200.00 corresponds to a rotation of two turns counterclockwise.
- A value of $+200.00$ corresponds to a rotation of two turns clockwise.
- With a value of 0.00 the pattern is stationary.

Aspect ratio

You can freely change the aspect ratio of the pattern.

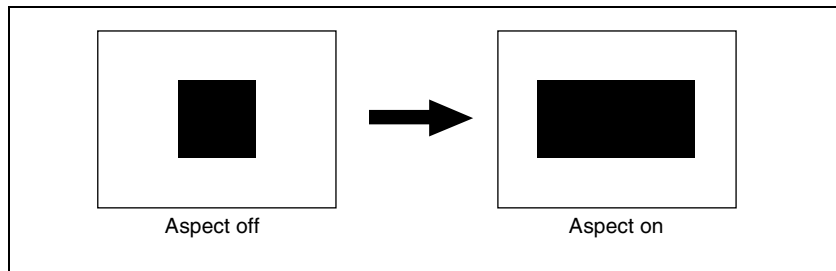

A negative value of the parameter Aspect stretches the pattern vertically; a positive value stretches the pattern horizontally.

Pattern replication (“Multi”)

The same pattern can be repeated horizontally and vertically or both, up to 63 times. You can also change the orientation of alternate copies, or change the position.

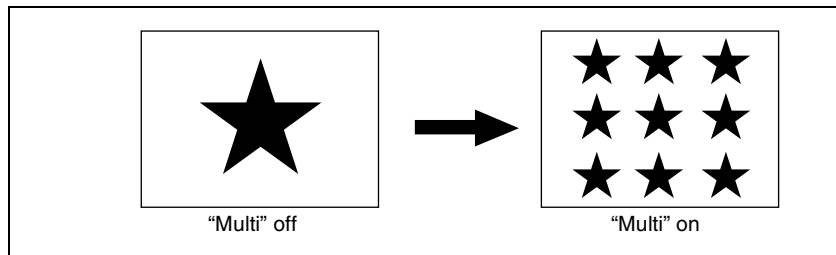



- The parameter H Multi determines the number of pattern replications horizontally, and the parameter V Multi determines the number of pattern replications vertically.
- The parameter Shift determines the manner of replication.
At a value of -100.00 , the pattern of the adjacent odd-numbered column on the left lines up with the central coordinate horizontally.
At a value of $+100.00$, the pattern of the adjacent odd-numbered column on the right lines up with the central coordinate horizontally.

For an independent key transition wipe, you can use the “Invert Type” parameter to select from the following four types of replication pattern.

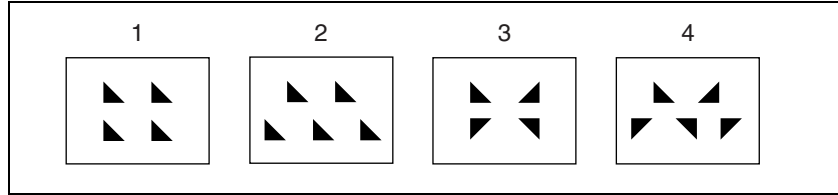

- 1: All replications in the same orientation
- 2: Even-numbered rows staggered
- 3: Even-numbered columns and rows inverted
- 4: Even-numbered columns and rows inverted, and even-numbered rows staggered

Pairing

This slits the pattern into multiple strips, making it like a venetian blind.

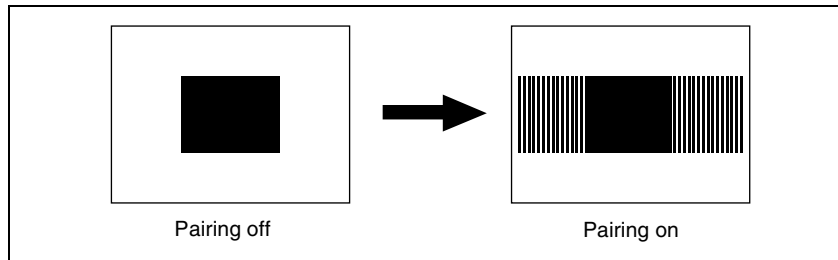

- H:** Create slits in the horizontal direction.
- V:** Create slits in the vertical direction.
- The parameter Width determines the width of the slits.
- The parameter H Offset determines the spacing in the horizontal direction.
If a negative value is set, the even-numbered pairs of strip and slit move to the left, and the odd-numbered pairs move to the right. The value -100.00 represents the maximum movement.
If a positive value is set, the even-numbered pairs of strip and slit move to

the right, and the odd-numbered pairs move to the left. The value +100.00 represents the maximum movement.

- The parameter V Offset determines the spacing in the vertical direction. If a negative value is set, the even-numbered pairs of strip and slit move upward, and the odd-numbered pairs move downward. The value -100.00 represents the maximum movement. If a positive value is set, the even-numbered pairs of strip and slit move downward, and the odd-numbered pairs move upward. The value +100.00 represents the maximum movement.

Modulation

The pattern signal can be modulated, giving waves on the horizontal or vertical edges, or radially.

The parameter Shape determines the form of the modulation.

1: sine wave, 2: triangular wave, 3: rectangular wave

Note

When using 1080PsF mode in an HD system, the modulation function is not available.

Horizontal modulation

This modulates the pattern, applying waviness in the horizontal direction to edges.

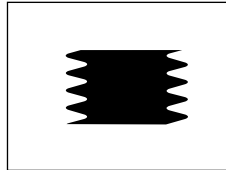

The parameter Speed determines the speed of waves.

A value of -100.00 generates the maximum downward speed of waves, and a value of +100.00 the maximum upward speed.



Vertical modulation

This modulates the pattern, applying waviness in the vertical direction to edges.

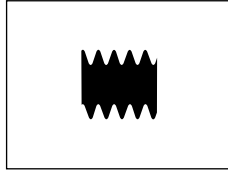

The parameter Speed determines the speed of waves. A value of -100.00 generates the maximum leftward speed of waves, and a value of $+100.00$ the maximum rightward speed.

Fringe

This modulates the pattern, applying waviness in the radial direction to edges.

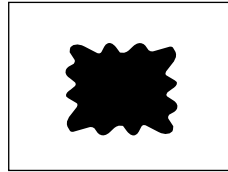

The parameter Speed determines the speed of waves. A value of -100.00 generates the maximum counterclockwise speed of waves, and a value of $+100.00$ the maximum clockwise speed.

Spring

As the transition progresses, the edge of the pattern is subjected to barrel or pincushion distortion.

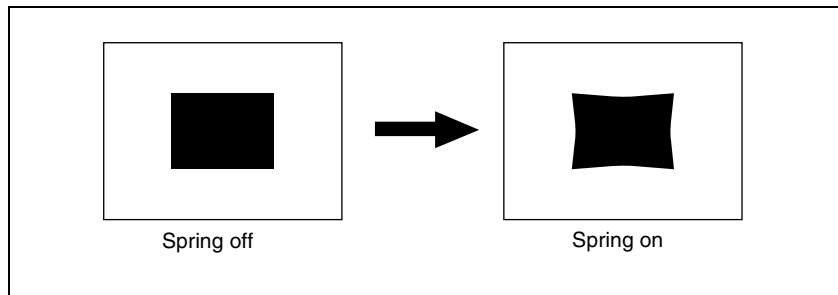

A negative parameter value produces pincushion distortion, and a positive value produces barrel distortion.

Spiral

This deforms the pattern spirally.

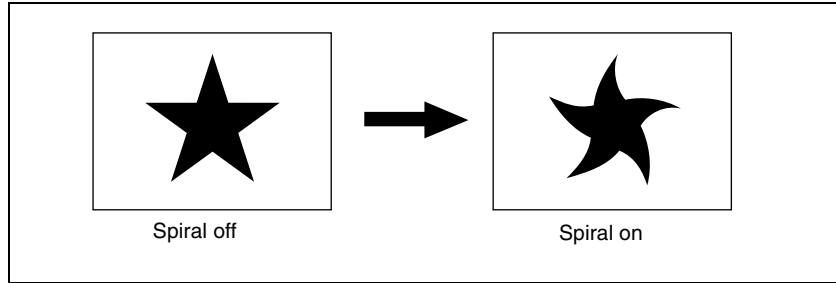

- The parameter Magnitude determines the size and direction of the spiral. A value of -100.00 represents the maximum movement in the counterclockwise direction, and a value of $+100.00$ represents the maximum movement in the clockwise direction.
- The parameter Wave Speed determines the speed of the lateral waves. A value of -100.00 represents the maximum speed to the left, and a value of $+100.00$ represents the maximum speed to the right.

Wipe Snapshots

You can snapshot and save a wipe pattern together with the current settings of its modifiers and pattern limit in a dedicated register for recall when required. There are 10 wipe snapshot registers on each M/E bank and the PGM/PST bank.

Use the Flexi Pad control block in each switcher bank or the Menu control block to save and recall wipe snapshots. (*For details, see “Wipe Snapshots” (page 460).*)

For simple transitions (*see page 371*), there are eight wipe snapshot registers on each M/E bank and the PGM/PST bank.

Wipe Modify Clear

By a simple operation, you can return the wipe state to that set in initial status.

For details of the menu operation to return the wipe state to that set in initial status, see “Returning to default state in function groupings” (page 324).

DME Wipes

A DME wipe is a wipe transition that uses a DME effect to change from one video image to the next.

There are two types of DME wipe: those which can be selected for a normal transition, and those which can be selected for an independent key transition.

For independent key transitions, see page 37.

Note

On the MVS-8000G, it is also possible to carry out a DME wipe on a key using the resizer (*see page 58*).

Types of DME Wipe Pattern

The patterns used for a DME wipe fall into two broad classes.

Preset patterns: predetermined fixed patterns

User programmable DME patterns: patterns which you can create using keyframe effects

DME wipe execution mode and pattern numbers that can be used

There are three DME wipe execution modes, depending on the number of DME channels available: one-channel mode, two-channel mode and three-channel mode. The pattern numbers that can be used in these modes are as follows.

Execution mode	Preset pattern numbers that can be used	User programmable DME pattern numbers that can be used
One-channel mode	1000 series	1901 to 1999
Two-channel mode	2000 series	2901 to 2999
Three-channel mode	3000 series	3901 to 3999

DME wipe pattern groups

The patterns used in DME wipes fall into the following groups.

For each group (excluding user programmable DMEs), for schematic patterns and numbers, see “DME Wipe Pattern List” in Appendix (Volume 1) (page 566). The black part of the pattern represents the old video, and the white part the new video, with the wipe taking place in the direction of the arrow.

- Slide:** The new video slides in over the old video.
(Pattern numbers: 1001 to 1008 (one-channel mode), 2601 to 2608 (two-channel mode))
- Squeeze:** The new video appears squeezed over the old video, and progressively expands to cover it.
(Pattern numbers: 1021 to 1031 (one-channel mode), 2621 to 2628 (two-channel mode))
- Split:** The old video splits, and the new video appears in the gap.
(Pattern numbers: 1011 to 1013 (one-channel mode))
- Door:** The new video moves like a door closing, and progressively covers the old video.
(Pattern numbers: 1041 to 1048 (one-channel mode))
- Flip tumble:** The old video rotates about an axis and is replaced by the new video. During the transition, the signal from the utility 2 bus of the M/E bank appears as the background.
(Pattern numbers: 1101 to 1104, 1109, 1110, 1121, 1122, 1124, 1131 to 1133, 1135 (one-channel mode))
- Mirror:** The new video appears over the old video as a mirror effect slides in all four directions.
(Pattern numbers: 1355 to 1358 (one-channel mode))
- Sphere:** The new video appears wrapped around a sphere over the old video, then returns to the original video while unwrapping.
(Pattern number: 1365 (one-channel mode))
- Character trail:** The new video appears with a trail over the old video. Next this gradually returns to the original from the periphery.
(Pattern numbers: 1371, 1372 (one-channel mode))
- Wave:** The new video appears with a wave-like effect over the old video. Next this returns to the original video as the effect reduces.
(Pattern numbers: 1378, 1379 (one-channel mode))
- Ripple:** The new video appears over the old video like outwardly moving ripples.
(Pattern number: 1381 (one-channel mode))
- Page turn:** The old video moves like a page turning, and the new video appears behind it.
(Pattern numbers: 1301 to 1313, 1315 to 1318, 1341 to 1345 (one-channel mode), 2701 to 2713, 2715 to 2718, 2741 to 2745 (two-channel mode))
- Page roll:** The new video unrolls like a scroll over the old video. This is a type of page turn.
(Pattern numbers: 1321 to 1333, 1335 to 1338, 1346 to 1350 (one-channel mode), 2721 to 2733, 2735 to 2738, 2746 to 2750 (two-channel mode))
- Frame in-out:** Completed in two transitions. In the first transition, the new video appears, then on the second transition the new video goes out and the old video returns.
(Pattern numbers: 1201 to 1208, 1221 to 1224 (one-channel mode), 2851 to 2854, 2861 to 2864 (two-channel mode))



Picture-in-picture: The one-channel mode and two-channel mode differ as follows.

In one-channel mode, this completes in two transitions. In the first transition, the old video shrinks, and the new video appears behind it. In the second transition, the old video expands again until it is its original size.

(Pattern number: 1251 (one-channel mode))

In two-channel mode, in the first half of the transition, the old video shrinks, and the new video appears. In the second half of the transition, the new video expands, and the old video disappears. You can move the pattern from the current position by a relative amount. During the transition, the signal from the utility 2 bus of the M/E bank appears as the background.

(Pattern numbers: 2651 and 2652 (two-channel mode))

2D trans: The new video appears over the old video, while undergoing expansion, two-dimensional rotation and translation.

(Pattern numbers: 1051 to 1058, 1061 to 1064, 1068 (one-channel mode))

3D trans: In one-channel mode, the new video appears over the old video, while undergoing expansion, three-dimensional rotation and translation. (Pattern numbers: 1071, 1072, 1074, 1076, 1077, 1088, 1091 to 1094 (one-channel mode))

In two-channel mode, the old video changes to the new video while both undergo expansion, three-dimensional rotation and translation.

(Pattern numbers: 2631 to 2634, 2642, 2644 (two-channel mode))

Sparkle: The new video appears over the old video with a nonlinear effect applied, such as broken glass, explosion, or melt. Next this returns to the original video as the effect gradually reduces.

(Pattern numbers: 1391, 1393, 1394, 1396, 1398, 1399 (one-channel mode))

Split slide: The new video appears in strip form while sliding interleaved in the opposite direction over the old video.

(Pattern numbers: 1384 to 1389 (one-channel mode))

Mosaic: In the first half of the transition, a mosaic is gradually applied to the old video, then at the 50% point the inner image changes to the new video. In the second half, the mosaic effect on the new video is gradually reduced, returning to the original image at 100%.

(Pattern number: 1701 (one-channel mode))

Defocus: In the first half of the transition, the old video is gradually defocused, then at the 50% point the inner image changes to the new video. In the second half, the defocusing effect on the new video is gradually reduced, returning to the original image at 100%.

(Pattern number: 1702 (one-channel mode))

Brick: In two-channel mode, a brick such that the side surface is visible slides in over the old video, then rotates so that the new video can be seen.

(Pattern numbers: 2801 to 2804, 2811 to 2814 (two-channel mode))

In three-channel mode, a brick appears over the old video as the image is expanding and rotating, and switches to the new video.

(Pattern number: 3601 (three-channel mode))

User programmable DME: Using a DME keyframe effect created with a keyframe operation, this executes a DME wipe.

(Pattern numbers: 1901 to 1999 (one-channel mode), 2901 to 2999 (two-channel mode), 3901 to 3999 (three-channel mode))

For details of creating keyframe effects, see “Creating User Programmable DME Patterns” (page 483).

Notes

- To use the Split, Page Turn, and Page Roll effects on the MVE-8000 requires the optional MKS-8830M Nonlinear Effect Board.
- In an independent key transition, the following patterns can be used.

Execution mode	DME wipe patterns that can be used
One-channel mode	Slide, split, squeeze, door, 2D trans, 3D trans, frame in-out, page turn, page roll, mirror, sphere, character trail, wave, ripple, split slide, sparkle, user programmable DME
Two-channel mode	Page turn, page roll

User programmable DME in transition mode

For the transition mode set when creating a keyframe effect for a user programmable DME pattern, the following can be used.

- **Single:** single transition mode
- **Flip tumble (Flip Tumble):** flip tumble transition mode
- **Dual:** dual transition mode
- **Picture-in-picture (PinP):** one-channel and two-channel picture-in-picture transition mode
- **Compress:** a type of picture-in-picture, in which the new image is the background, and the currently visible image shrinks, and then expands to its original size. (See example in the next item.)
- **Frame in-out (Frame I/O):** frame in-out transition mode. When the first transition completes, if you move the position of the image, you can move it both horizontally and vertically.
- **Frame in-out H (Frame I/O H):** a type of frame in-out mode, which is specified when creating a transition effect in the horizontal direction. The image movement is reflected at both the transition start point and end point. (See page 77.)
The operation is carried out according to DME wipe patterns 1202, 1203, or 1204.
- **Frame in-out V (Frame I/O V):** a type of frame in-out mode, which is specified when creating a transition effect in the vertical direction. The image movement is reflected at both the transition start point and end point. (See page 78.)

Transition mode “Compress”

The change in the image when the transition mode is set to “Compress” is as follows, in comparison to the case of “Picture-in-picture.”

- Example of the image change in the transition mode “Picture-in-picture” (one-channel mode)

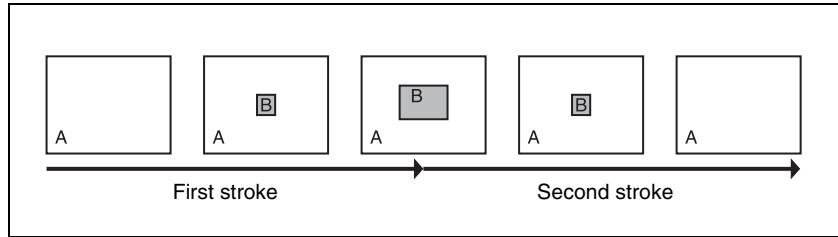

- Example of the image change in the transition mode “Compress”

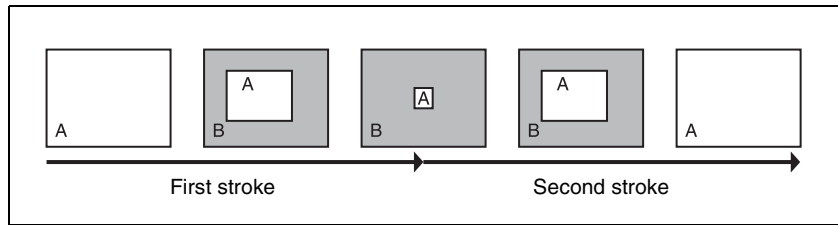

Transition mode “frame in-out”

In this mode, when the first transition has completed, you can move the image with the positioner in both horizontal and vertical directions, but the image position at the transition start point and end point does not change.

The description is of an example of creating an effect such as the following.

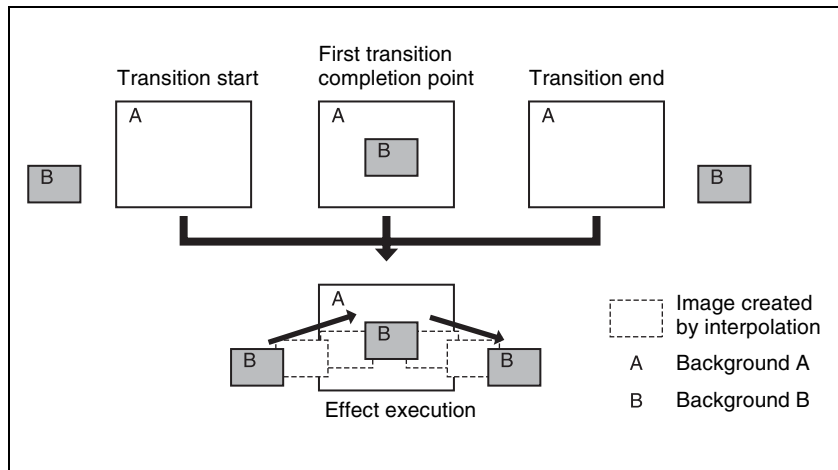

At the first transition completion point, if you move the image with the positioner, the transition appears as in the following figure.

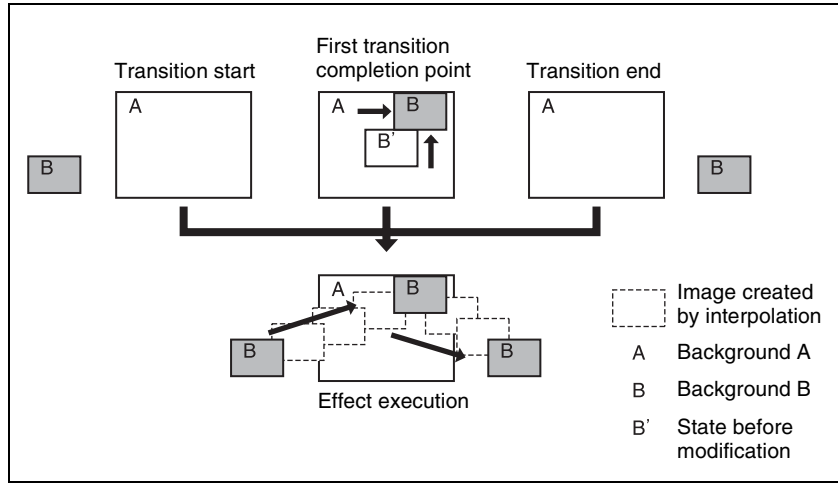

Transition mode “frame in-out H”

This mode is specified when creating a transition effect in the horizontal direction.

In this mode, when the first transition has completed, you can move the image with the positioner in both horizontal and vertical directions. The image at the transition start point and end point also moves.

The description is of an example of creating an effect such as the following.

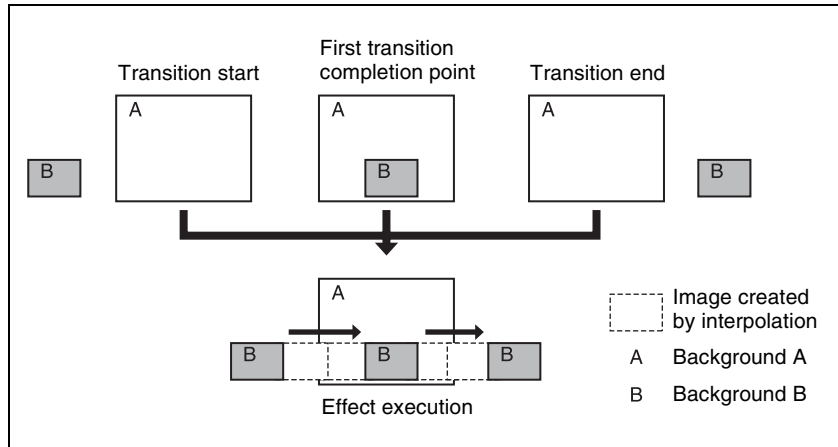

At the first transition completion point, if you move the image with the positioner, the transition appears as in the following figure.

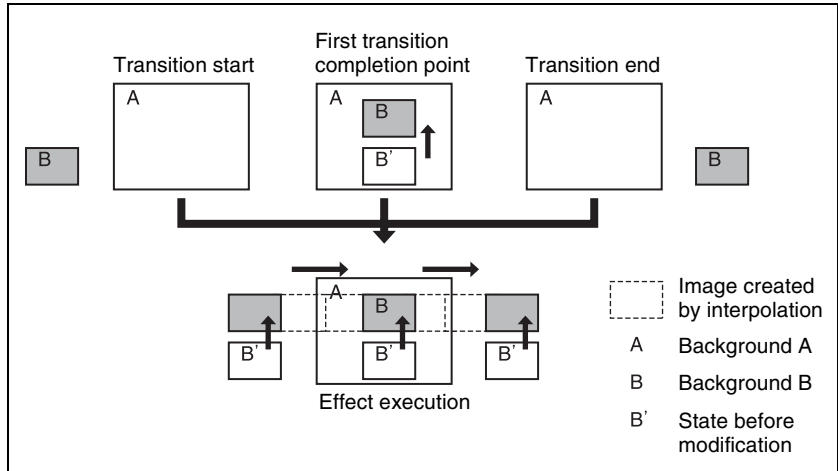

Transition mode “frame in-out V”

This mode is specified when creating a transition effect in the vertical direction.

In this mode, in the state at completion of the first transition, you can move the image with the positioner in both horizontal and vertical directions. The image at the transition start point and end point also moves.

The description is of an example of creating an effect such as the following.

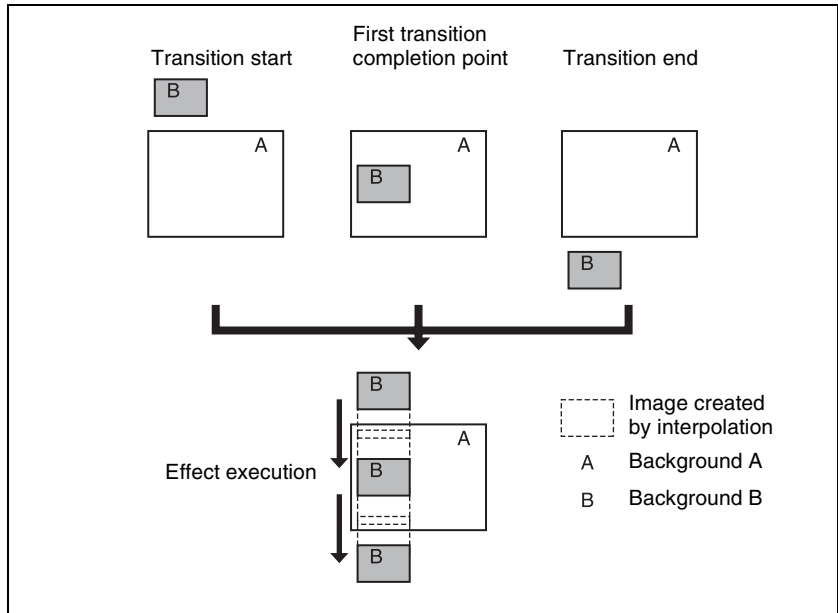

At the first transition completion point, if you move the image with the positioner, the transition appears as in the following figure.

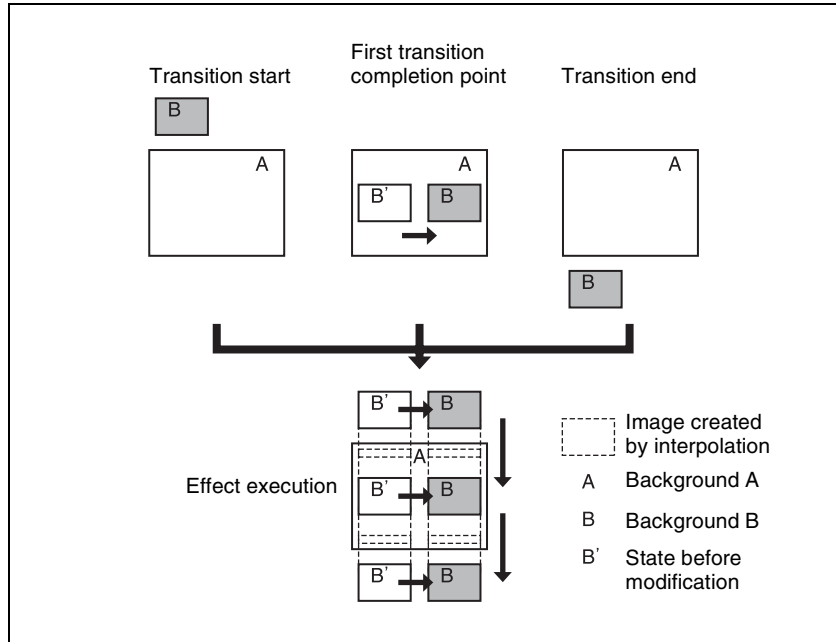

Signals forming part of the background for a DME wipe

For a two-channel mode page turn, page roll, brick, frame in-out, and so on, the part of the pattern shown in gray (*see Appendix (Volume 2)*) is filled with the signal selected on the DME external video bus.

For three-channel mode brick, the part of the pattern shown in dark gray is filled with the DME external video signal, and the light gray portion with the signal selected as follows.

For a DME dedicated interface

When the DME channel used is 3 or 4, the signal selected on the DME utility 1 bus. For channel 7 or 8, the signal selected on the DME utility 2 bus.

For an MVE-8000A or MVE-9000 SDI interface

Signal selected on the AUX bus assigned in the Engineering Setup >Switcher >Device Interface >DME Type Setting >DME SDI interface menu. (The AUX bus is determined by which DME channel is being used.)

Note

For the SDI interface on the MVE-8000A or MVE-9000, in some cases the AUX bus is used in place of the DME external bus.

For details, see “*Interfacing With External Devices (Device Interface Menu)*” in “*Setup Relating to Switcher Processor*” section of Chapter 16 (Volume2).

DME Wipe Pattern Variation and Modifiers

You can modify the selected DME wipe pattern in the same way as an ordinary wipe pattern, as follows.

For the setting operations, see “*Setting DME Wipe Modifiers*” (page 469).

Direction: You can set the DME wipe direction to normal, reverse, or alternating normal/reverse (page 64), except for a key transition, which is always in normal/reverse mode. However, a key transition can only be specified when the following patterns are selected, and when other patterns are selected, this is fixed, as normal/reverse.

Patterns: 1204, 1207, 1221 to 1224

Edge: You can apply a border or soft border (see page 65).

In the case of those user programmable DME patterns for keys in which an edge has already been applied to the effect, the behavior is as follows.

- When the DME wipe edge setting is on, only part of the edge applied in the effect is enabled, and that portion can be adjusted (page 470).
- When the DME wipe edge setting is off, the edge applied in the effect is enabled as is.

Note

In an MVS-8000 system, edge cannot be used for a key DME wipe.

Positioner: You can move the DME wipe pattern or center of the effect to an arbitrary position. Using the position select function, you can also instantaneously move the pattern.

- 1031

When this pattern number is selected, with the progress of the transition the pattern center automatically moves initially from the set position toward the center of the screen (see page 65). In other words, the effect obtained is the same as in a normal wipe with the positioner set to “AUTO CENTER”.

- 1201 to 1208, 1221 to 1224, 1251

When these pattern numbers are selected, you can set the pattern position when the first transition completes.

- 1381, 1391, 1393, 1394, 1396
When these pattern numbers are selected, you can set the center of the transition effect.
- 2651, 2652
When these pattern numbers are selected, you can move the pattern for each channel, or with values relative to the current position the two channels simultaneously.
- 2801 to 2804, 2811 to 2814
When these pattern numbers are selected, you can set the vertical position as the brick slides in.
- 2851 to 2854, 2861 to 2864
When these pattern numbers are selected, you can set the pattern position for each channel setting when the first transition completes.

Pattern limit: You can restrict the range of the transition as desired. However, this is not available for a DME wipe in the independent key transition control block.

For more details, see “Pattern Limit” (page 355).

Size: This can only be used when one of the following pattern numbers is selected.

- 1201 to 1208, 1221 to 1224, 1251
- 2651, 2652, 2851 to 2854, 2861 to 2864

You can set the size of the image.

Crop: You can crop the image. It is also possible in 16:9 mode to crop both sides, to convert the image to a 4:3 aspect ratio. For the execution of a DME wipe crop transition, you can select from the following three possibilities.

- Cut
- Last 5%
- Linear

When [Last 5%] is selected, you can set the [Release Transition] as follows.

- Last 30%
- Last 5%
- Off

Notes

- When pattern numbers 1701 and 1702 are selected, crop cannot be used.
- The MVS-8000 does not support the [Last 5%] setting for [Release Transition].

Relation Between DME Wipes and Other Effects

The relations between DME wipes and other effects are as follows.

Relation to ordinary wipes

- DME wipes do not use the wipe generator built into the switcher. Therefore, during the execution of a DME wipe, you can still use a pattern produced by the wipe generator as the source for a pattern key or mask.
- A DME wipe pattern cannot be used as the source for a pattern key or mask.

Relation to processed keys

When using the DME for a processed key, if you select a DME wipe, an available DME is automatically allocated to the DME wipe. If all of the DME channels are in use, then it is not possible to select a DME wipe. If in a Setup menu a setting has been made for DME allocation, that Setup menu setting takes precedence (*see “Setting the assignments of DME channels to use on the individual M/E banks” in Chapter 16 (Volume 2).*)

Relation to resizer (for MVS-8000G only)

When resizer is enabled, it is not possible to select a DME wipe. For the key 1 and key 2, or key 3 and key 4 combinations, if one is used for a dual resizer effect, the other key cannot be used for a DME wipe.

Number of DME wipes that can be used simultaneously on a single M/E bank

DME wipes can be used in five places, including the four independent key transitions. When the DME dedicated interface is used, a maximum of two DME wipes can be used simultaneously, and when the SDI interface is used, only one DME wipe can be used at one time.

Note

When combining the SDI interface with the dedicated interface, it may be possible to use up to three wipes simultaneously.

For details, see “Interfacing With External Devices (Device Interface Menu)” in “Setup Relating to Switcher Processor” section of Chapter 16 (Volume2).

DME Wipe Snapshots

You can snapshot and save a DME wipe pattern together with the current settings of its modifiers and pattern limit in a dedicated register for recall when required.

There are 10 DME wipe snapshot registers for each of the M/E and P/P banks.

To save and recall these registers, use the Flexi Pad control block in each switcher bank or the Menu control block. (See “DME Wipe Snapshots” (page 482).)

In the case of a simple transition system, there are eight DME wipe snapshot registers for each switcher bank.

DME Wipe Modify Clear

By a simple operation, you can return the DME wipe state to that set in initial status.

For details of the menu operation to return the DME wipe state to that set in initial status, see “Returning to default state in function groupings” (page 324).

Resizer DME wipes

Using the resizer, you can carry out key DME wipes.

Note

This function is supported by the MVS-8000G.

DME wipe patterns available for resizer DME wipe

You can use the following patterns of the DME wipe pattern one-channel mode that can be used in a resizer DME wipe. (7000-series numbers)

- Slide (pattern numbers: 7001 to 7008)
- Squeeze (pattern numbers: 7021 to 7031)
- frame in-out (pattern numbers: 7201 to 7208, 7221 to 7224)

Relation between resizer DME wipes and other effects

The following relations hold between resizer DME wipes and other effects.

Relation with processed keys

It is not possible to select a resizer DME wipe for a key for which processed key is enabled.

Relation with resizer

A resizer DME wipe cannot be used for a key for which resizer is enabled. Additionally, a resizer DME wipe cannot be used for a key paired with a key for which the dual resizer effect is enabled. Paired keys refer to the

combinations of key 1 and key 2, or key 3 and key 4. For example, when a dual resizer effect is enabled for key 1, a resizer DME wipe cannot be used for key 2.



Frame Memory

Overview

Frame memory is a function whereby a frame of input video can be frozen and written to memory, for further use as material for editing. You can also play recorded frame memory clips (movies).

Frame capacity

The maximum number of images that can be written to memory is as follows.

MVS-8000 system

HD system: 58 frames (88 frames in 720P/59.94 format)

SD system: 222 frames

MVS-8000A system and MVS-8000G system

HD system:

(Without ancillary data)

Video format	Memory capacity
1080i/50	Approx. 1000 frames
1080i/59.94	Approx. 1000 frames
1080i/60	Approx. 1000 frames
1080PsF/24	Approx. 1000 frames
1080PsF/25	Approx. 1000 frames
1080PsF/29.97	Approx. 1000 frames
1080PsF/30	Approx. 1000 frames
720P/50	Approx. 2300 frames
720P/59.94	Approx. 2300 frames

(With ancillary data)

Video format	Memory capacity
1080i/50	Approx. 700 frames
1080i/59.94	Approx. 800 frames
1080i/60	Approx. 800 frames
1080PsF/23.976	Approx. 600 frames
1080PsF/24	Approx. 600 frames
1080PsF/25	Approx. 700 frames



Video format	Memory capacity
1080PsF/29.97	Approx. 800 frames
1080PsF/30	Approx. 800 frames
720P/50	Approx. 1400 frames
720P/59.94	Approx. 1700 frames

SD system:

(Without ancillary data)

Video format	Memory capacity
480i/59.94	Approx. 5600 frames
576i/50	Approx. 4800 frames

(With ancillary data)

Video format	Memory capacity
480i/59.94	Approx. 4700 frames
576i/50	Approx. 3900 frames

Note

For the MVS-8000A and MVS-8000G, up to two frame memory boards can be installed (MKS-8440A for the MVS-8000A, MKS-8442G for the MVS-8000G). The above-stated maximum number applies when one frame memory board is installed.

When two boards are installed, the figures are doubled, but of the two boards only one can be used for frame memory clips.

Note that for the MVS-8000/8000SF, MVS-8000ASF and MVS-8000GSF, it is not possible to install two frame memory boards.

For details of operations, see “Still Image Operations” (page 490).

Types of image and terminology used

The following types of image are handled in frame memory.

Freeze image: An input image that has been frozen, but not saved to memory.

Still image: A freeze frame that has been saved to memory as a file. Each file (still file) holds just one still image.

Frame memory clip: A clip consists of a sequence of still images, which appears as a movie on playback. In this manual this is also referred to simply as a “clip.” The files (still files) constituting clips are referred to as a “clip file.”

When the above distinctions are not being made, an image is simply referred to as an “image.”

About extended clips

When two frame memory boards (MKS-8440A for the MVS-8000A, MKS-8442G for the MVS-8000G) are installed, one is dedicated to clips. Such clips held in a frame memory board are called “extended clips.”

Use of frame memory

There are eight frame memory channels, FM1 to FM8, and each channel independently allows a freeze image to be saved or recalled.

By allocating FM1 to FM8 to cross-point buttons you can use the still image output or clip output from each channel as input material.

Note

On the MVS-8000A, an extended clip can only be recalled from FM1 or FM2. It is not possible to recall from FM3 to FM8. Note that this restriction does not apply to the MVS-8000G.

Correspondence between input and output

There are two buses for capturing frame memory material: the frame memory source 1 bus and the frame memory source 2 bus.

These input buses are used by allocation to one of the pairs of output, FM1&2, FM3&4, FM5&6, and FM7&8. You can freeze a frame in each channel separately, or freeze in the two channels simultaneously.

The source buses allocated to FM1 to FM8 are as follows.

Input	Frame memory source bus 1	Frame memory source bus 2
Output	FM1	FM2
	FM3	FM4
	FM5	FM6
	FM7	FM8

Pair mode

By enabling the pair mode, you can link FM1 and FM2, FM3 and FM4, FM5 and FM6, and FM7 and FM8. For example, when a freeze or image processing is carried out on FM1, the same operation is carried out on FM2. The same applies to the other pairs. When a pair of images are captured in pair mode, the image frozen in FM1 (3, 5, or 7) is referred to as the main file and the other frozen in FM2 (4, 6, or 8) is referred to as the sub file.

Pair files and single files

A file that can be recalled in pair mode is termed a “pair file.” A pair file can be created by setting pair mode and capturing an image, or by using the coupling function (*see page 94*) to combine two single files.

A file other than a pair file is termed a “single file.” A single file can be created by switching off pair mode and capturing an image, or by using the separation function (*see page 94*) to split a pair file.

Operation modes

The frame memory has the following operation mode.

V/K mode: When the pair mode is active, the key signal is automatically selected on frame memory source bus 2. This is convenient for handling the video and key signals together in frame memory. For example, when you select a video signal on frame memory source bus 1, the key signal assigned to it is automatically selected on frame memory source bus 2. You can also use the signal automatically selected on frame memory source bus 2 as a key signal when processing keyframe memory 1.

To change the pair mode or operation mode, use the Frame Memory menu.

Frame memory folders

Still images and clips can be managed in a maximum of twelve groups. Such a group is called a “frame memory folder.” Folders can be added or deleted, and can be given a name of up to 8 characters.

Notes

- This function is not supported on the MVS-8000.
- When the system is powered off, the folder names are deleted. The folder names need to be saved on media.
- The following names cannot be used for folders.
Flash1, Flash2
CON, PRN, AUX, CLOCK\$, NUL, COM0, COM1, COM2, COM3,
COM4, COM5, COM6, COM7, COM8, COM9
LPT0, LPT1, LPT2, LPT3, LPT4, LPT5, LPT6, LPT7, LPT8, LPT9
A folder named “Default” is provided, and this folder cannot be renamed or deleted.
- Still images and clips in different frame memory folders cannot have the same name.

Still Image File Functions

The frame memory functions provides the following still image file functions.

- Freezing an input image
- Saving a still image
- Recalling a still image
- Processing an image
- Image output
- Continuously capturing images (record)
- Recalling a continuous sequence of images (animation)

Capturing an input image (freeze)

As the input material for the frame memory, you can use the signal selected on the frame memory source bus. For this signal you can use video processing (video levels or hue value adjustment) or masking.

Allocating a frame memory source bus signal to one of FM1 to FM8, then carrying out a freeze captures a still image in the corresponding frame memory output image, and saves it in temporary memory.

For a freeze, an image can be captured either as video frame (a “frame freeze”) or a video field (“field freeze”).

Note

When the system is powered off, any freeze images written to temporary memory are lost.

Saving a still image (store)

You can save an image in temporary memory which has been placed with the freeze function as a file in memory. You can save a single image in a single file and apply a name of up to eight characters to the file.

Note

The following names cannot be used:

CON, PRN, AUX, CLOCK\$, NUL, COM0, COM1, COM2, COM3, COM4, COM5, COM6, COM7, COM8, COM9

LPT0, LPT1, LPT2, LPT3, LPT4, LPT5, LPT6, LPT7, LPT8, LPT9

When the system is powered off, all the files saved in memory are erased.

Freeze and store mode

When this mode is set to On, the freeze and store operations occur simultaneously. You can set it to On in the Frame Memory >Still >Freeze/Store menu (*see page 498*).

This function is not supported on the MVS-8000.

Recalling a still image (recall)

You can recall an image file saved in memory, and allocate to any of the FM1 to FM8 outputs.

Processing an image

You can combine the background image (a still image file allocated to any of FM1 to FM8, a freeze image written to temporary memory, or a black signal) and the input signal.

The following types of processing are available.

Pattern key: Using the signal from a dedicated pattern generator, you can cut out the background image and insert the signal selected on the frame memory source bus or a color matte signal. You can adjust the size and position of the pattern, and add modifiers.

External key: When processing an image in FM1 (3, 5, 7), you can use the signal selected on the frame memory source bus 2 to cut out the background image, and fill with the signal selected on the frame memory source bus 1, or a color matte signal.

When processing an image in FM2 (4, 6, 8), you can use the signal selected on the frame memory source bus 2 to cut out the background image, and fill with a color matte signal (always white).

Note

An external key can only be used when the pair mode is enabled (*see page 87*).

MIX: Mix the background image with the signal selected on the frame memory source bus or color matte signal. The mix ratio can be set.

NAM: Non-additive mix the background image with the signal selected on the frame memory source bus or color matte signal.

Image output

Moving the output image (reposition function)

For up to two channels of FM1 to FM8 (one from FM1, FM3, FM5 and FM7 and the other from FM2, FM4, FM6 and FM8), you can move the output image with respect to the screen. The area of the screen around the image that has been moved is filled with black. There are two ways of carrying out this repositioning.

Normal mode: Movement in the horizontal direction is in two-pixel increments.

Black and white mode: Movement in the horizontal direction is in one-pixel increments, and for each pixel moved the color is inverted.

Note

It is not possible to save an image moved with the reposition function directly to frame memory.

Fixing the output image selection (lock function)

For the output of each of FM1 to FM8, this fixes the image at the current output. When this lock is enabled, even if the output is recalled in a snapshot or keyframe, the images output to FM1 to FM8 are preserved.

Continuously capturing still images (record)

You can continuously capture (freeze) a sequence of input video frames and store the sequence of the still images over a specified time interval.

The name of each image recorded in this way consists of a first character string followed by a second string.

First character string: A common part of name assigned to all the still images captured in one record operation. This string includes a maximum of four characters, which can be specified using a menu before carrying out the capture. The first string is automatically used as the clip name when the images are treated as a frame memory clip.

Second character string: A four-digit number (0000 or greater), which is incremented each time a still image is captured.

Notes

- When using the record function to continuously capture frames, it is not possible to use the mask function.
- On the MVS-8000, the image file name is “anmxyyy” (“anm” is constant, “xx” is a two-digit number from 00 to 99 incremented by 1 for ever recording operation, and “yyy” is a three-digit number from 000 to 999, incremented by 1 for each captured image).

Recalling a continuous sequence of still images (animation)

You can use a continuous sequence of images captured with the record function as keyframes to create an effect. By executing this effect you can recall the continuous sequence (animation).

Notes

- For example, to create an effect using FM1, FM1 must be assigned to a user region. (*For details of user region settings, see “Settings for Switcher Configuration (Config Menu)” in Chapter 16 (Volume 2).*)
- To execute the effect, you must assign the user region to which FM1 is assigned to a region selection button in the numeric keypad control block. (*For details of assigning to region selection buttons in the numeric keypad*

control block, see “Overall Control Panel Settings (Config Menu)” in Chapter 16 (Volume 2).)

In the Frame Memory menu, effect creation follows the image file names. Of the eight characters in the file names, if files have the same characters except for the last three characters they are treated as an image file group, and the effect is created with the last three (numeric) characters in sequence.

Note

When creating the effect in pair mode (see page 87), the files used must be main files and sub files with the same last three (numeric) characters in the file name.

Frame Memory Clip Function

The frame memory clip function is not supported on the MVS-8000.

What is a “frame memory clip”?

Movies can be read into frame memory, and recalled and played back. A movie held in frame memory is called a “frame memory clip.”

A frame memory clip can be named using up to four characters. (For details of frame memory clip names, see “Continuously capturing still images (record)” (page 91).)

Ancillary data

In a frame memory clip, in addition to the video image, you can also record and play back ancillary data which can be used as embedded audio (MVS-8000A and MVS-8000G only).

To record the ancillary data, in the Setup menu the frame memory saving mode must be set to “save with ancillary data” (see “Saving a frame memory clip including ancillary data” in Chapter 16 (Volume 2)).

Notes

- With this setting, the saving mode for still images also changes to “save with ancillary data,” but when playing back a still image the ancillary data is never played.
- When you change the saving mode, the frame memory is initialized, and any existing recorded frame memory data is lost.

When the frame memory saving mode is set to “save with ancillary data,” the following ancillary data status information is added to a frame memory clip.

- **Disable(d)**
In this state the ancillary data is not played. This is the status when the [Ancillary Enable] button in the Frame Memory >Clip menu is set to Off.
- **Enable(d)**
In this state, ancillary data is present, and can be played back. This is the status when the [Ancillary Enable] button in the Frame Memory >Clip menu is set to On. This is the status after a clip recording operation.

This status information is saved in a file, and is followed when the file is recalled.

Frame memory clip settings

For frame memory clips, you can make the following settings using a menu or device control block (trackball/search dial/joystick).

- Start point
- Stop point
- Loop On/Off

The above settings can be saved in a snapshot register as snapshot attributes, and recalled.

Note

On the MVS-8000A, it is only possible to replay extended clips as output from FM1 or FM2.

Clip transitions

A frame memory clip (movie) is played back, linked to a transition using a mix (dissolve) or wipe.

Note

The clip transition function is only supported by the MVS-8000A/8000G.

The following restrictions apply to the use of a clip transition.

- Key frame capture is not possible.
- It is not possible to apply a pattern limit.
- Transitions executed in two strokes, such as a preset color mix with the stroke mode set to Normal, or a DME wipe with a picture-in-picture pattern, will not execute correctly.
- It is not possible to vary the transition rate of a clip transition.
- Transition preview cannot be used.
- The clip transition settings cannot be copied or swapped among the M/E and PGM/PST banks.
- No instantaneous state of a clip transition can be saved as a snapshot.

- When recalling a snapshot including a clip transition during executing another clip transition, the follow-on transition does not operate properly. Be sure to complete the transition before recalling a snapshot.

Image Data Management

Frame memory folder editing

Create: Create a new folder.

Delete: Specify a folder and delete it. You can also delete all folders together in a single operation.

Rename folder: Rename a specified folder.

File management

The following operations are possible on files created to hold images.

Delete: Specify a file to be deleted. It is also possible to delete all files simultaneously in a single operation.

Rename file: Change the name of the specified file.

Move file: Move a file from one folder to another.

Backup: Save all files to hard disk in a single operation.

Restore: Restore the files which have been backed up.

Pair file processing

Couple: You can create a pair file from two single still image files or clip files.

Separate: You can also separate a pair file into two single still image files or clip files.

Note

This function is not supported on the MVS-8000.

Image Data Transfer

Files, including ancillary data, can be transferred between such devices as a hard disk and memory card.

In the File menu, files can be saved and recalled.

It is possible to import images such as BMP files or convert frame memory files into a different format and save them in an external device.

For details, see Chapter 17 “Files” (Volume 2).

Notes on transferring multiple still images together

- Transferring all of the still image files within frame memory together fails if the capacity of the memory card is too small to hold all of the images. In this case, replace with a larger capacity memory card, or delete still images until saving is possible.

The following table roughly shows the relation between memory card capacity and number of images that can be saved.

Memory card capacity	Number of images that can be saved	
	SD system	HD system ^{a)}
256 MB	214	46

a) For all available signal formats except 720P

Note that when transferring to the hard disk, there is ample capacity, so that problems such as this do not occur.

- If you cancel the operation during a data transfer between frame memory and hard disk or memory card, then an image which was not completely transferred will not be reproducible. Avoid canceling such operations.
- When loading a still image file from hard disk or memory card, if [Freeze Enable] in the Freeze menu is on, the loaded still image file may sometimes be overwritten by the frame memory input image.

To avoid this when loading a file, ensure that [Freeze Enable] is turned off.

Notes on saving or recalling a frame memory still image for or by a snapshot/keyframe

- The saving and recalling of frame memory images for snapshots and keyframes is restricted to the still images or clips on the eight frame memory outputs. The settings made for frame memory images in the Freeze menu, Composite menu or other menus do not apply to snapshots or keyframes.
- To reproduce a frame memory still image or a clip of them by recalling a snapshot or keyframe, you must have the same images that were present in the frame memory when you saved the snapshot or keyframe. Therefore, when saving a snapshot or keyframe using frame memory, you must also save the images to a storage media such as the hard disk.

Note on transferring ancillary data

Ancillary data is recorded when the frame memory saving mode is set to “save with ancillary data,” and can be saved to an external storage device such as a hard disk or memory card, and recalled. However, the ancillary data can only be saved or recalled when the frame memory saving mode is set to “save with ancillary data,” and when ancillary data is present in the saved or recalled frame memory file, and moreover when the system signal format is the same as the signal format in the file.

External Hard Disk Drive Access

In an MVS-8000A system and MVS-8000G system, you can connect a hard disk drive to the IEEE1394 port of the switcher processor, to carry out the following operations.

Format: Format the hard disk.

Backup: Batch saving of files from frame memory to the hard disk.

Restore: Restoring frame memory from files saved on the hard disk.

Color Backgrounds

The dedicated generators generate color signals, and these can be used as color backgrounds in video effects.

Color background selection

There are two color backgrounds, color background 1 and color background 2, which you use by assigning to cross-point buttons.

Color combinations (“color mix”)

The color generators can output the result of combining two colors, which are color 1 and color 2.

Using a pattern from a dedicated pattern generator, color 1 and color 2 can be combined in the boundary region, forming a color gradation. This is referred to in the menu system as “color mix.”

You can also apply modifiers to the selected pattern.

When the “color mix” function is not used, the result is a flat color, and color 1 is always output.

For details of operations, see “Color Background Setting Operations” (page 538).



Copy and Swap

You can copy and swap the settings among the M/E-1 to M/E-3, and PGM/PST banks or between keyers.

The following settings can be copied or swapped.

- Overall settings for the M/E-1 to M/E-3, and PGM/PST banks
- Keyer settings
- Wipe settings in a transition control block
- Wipe settings in an independent key transition control block
- DME wipe settings in a transition control block
- DME wipe settings in an independent key transition control block
- Matte data (color 1, color 2, and how to compose them)
- Color settings
- DME channel settings
- Format converter input settings (copy only)
- Format converter output settings (copy only)

You can carry out copy operations with a simple button operation. Swap operations, and copy operations on DME data can only be done with a menu operation.

For details of the operations, see Chapter 9 “Copy and Swap” (page 543) and for color correction settings, “Copy and Swap Operations” in Chapter 19 (Volume 2).

M/E copy and M/E swap

You can copy and swap the overall bank settings among the M/E-1 to M/E-3, and PGM/PST banks.

Target bank	Target data
M/E-1 M/E-2 M/E-3 PGM/PST	Bank settings excluding the following data items: <ul style="list-style-type: none">• Setup data• Flexi Pad settings• Snapshots• Keyframe effects• Key snapshots• Key memory

Note

If a DME is being used on the source M/E bank, then if for example there are insufficient DME channels, it may not be possible to select the DME. There are no such restrictions on a swap.

Keyer copy and keyer swap

You can carry out copy and swap operations among the 16 keyers listed in the following table.

Target bank	Target keyer	Target data
M/E-1 M/E-2 M/E-3	Keys 1 to 4	Key settings excluding the following data items: <ul style="list-style-type: none"> • Setup data • Key snapshots • Key memory
PGM/PST	Downstream keys 1 to 4	

Note

If a DME is being used on the source keyer for a copy or either keyer for a swap, then if for example there are insufficient DME channels, or the limit on using DME channels within an M/E bank is exceeded, it may not be possible to select the DME.

Wipe copy and wipe swap

You can copy and swap the wipe settings among the banks listed in the following table.

Target bank	Target data
M/E-1 M/E-2 M/E-3 PGM/PST	Wipe settings. It is not, however, possible to carry out copy or swap involving independent key transition wipe settings.

Wipe copy and wipe swap in the independent key transition control block

You can copy and swap the wipe settings among the 16 keyers listed in the following table.

Target bank	Target keyer	Target data
M/E-1 M/E-2 M/E-3	Keys 1 to 4	Wipe settings in the independent key transition control block.
PGM/PST	Downstream keys 1 to 4	It is not, however, possible to copy or swap wipe settings to or from an external downstream keyer.

DME wipe copy and DME wipe swap

You can copy and swap the DME wipe settings among the banks listed in the following table.

Target bank	Target data
M/E-1 M/E-2 M/E-3 PGM/PST	DME wipe settings. It is not, however, possible to carry out copy or swap involving independent key transition DME wipe settings.

DME wipe copy and DME wipe swap in the independent key transition control block

You can copy and swap the DME wipe settings among the 16 keyers listed in the following table.

Target bank	Target keyer	Target data
M/E-1 M/E-2 M/E-3	Keys 1 to 4	DME wipe settings in the independent key transition control block.
PGM/PST	Downstream keys 1 to 4	

Matte data copy and swap

You can copy or swap the matte data among the 38 color generators listed in the following table.

Target bank	Target keyer and data	
M/E-1 M/E-2 M/E-3 PGM/PST	<ul style="list-style-type: none"> Keys 1 to 4 Downstream keys 1 to 4 	<ul style="list-style-type: none"> Matte data for key fill Matte data for key edge fill
	Matte data for wipe border edge	
Color background	<ul style="list-style-type: none"> Matte data for color background 1 Matte data for color background 2 	

Color data copy and swap

You can copy or swap the color data among the 152 color generators listed in the following table.

Target bank	Target keyer and data	
M/E-1 M/E-2 M/E-3 PGM/PST	<ul style="list-style-type: none"> Keys 1 to 4 Downstream keys 1 to 4 	<ul style="list-style-type: none"> Colors 1 and 2 for key fill Colors 1 and 2 for key edge fill “Zabton” color data
	Colors 1 and 2 for wipe border	
	Color data for preset color mix	
Color background	<ul style="list-style-type: none"> Colors 1 and 2 for color background 1 Colors 1 and 2 for color background 2 	
Frame memory	<ul style="list-style-type: none"> FM1 color FM2 color 	



Target bank	Target keyer and data
DME ch1 to ch8	<ul style="list-style-type: none">• Background• Border• Sepia• Light• Shade• Drop shadow (other than DME ch4 and DME ch8)• Trail

DME channel copy and swap

You can copy and swap the channel data among DME channels 1 to 4 or DME channels 5 to 8.

It is not possible to copy or swap the channel data between DME channels 1 to 4 and DME channels 5 to 8.

Copying format converter data

On the MVS-8000G, you can copy data from one format converter input to another or from one output to another.

Side Flags

Overview

The term “side flags” refers to the areas to left and right of an image with aspect ratio 4:3 embedded within a 16:9 frame, when these areas are filled with a separate image selected from the utility 1 bus. (See following figure.) You can adjust the width of the side flag area.

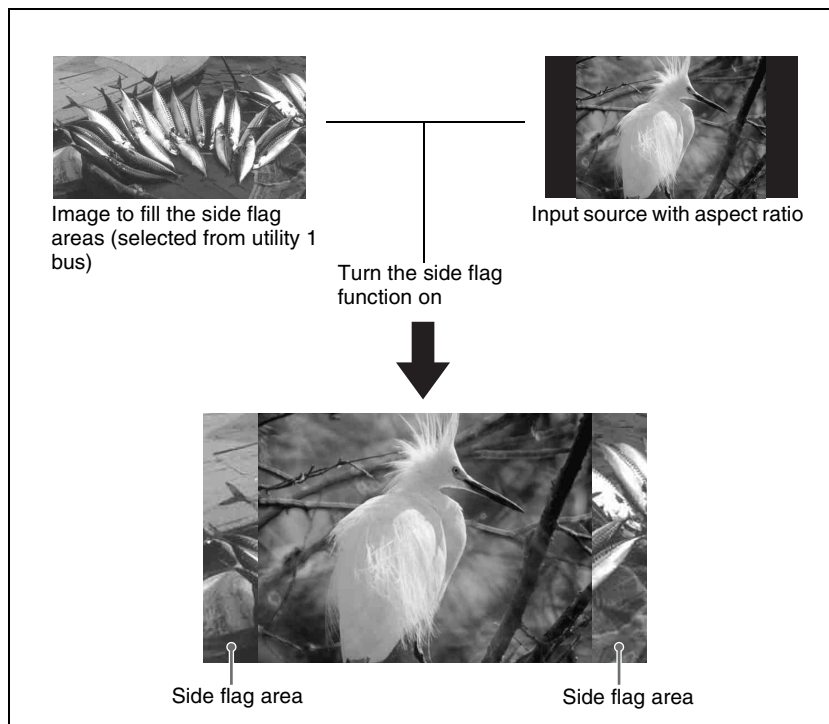

Note

The side flag function is only supported on the MVS-8000A/8000G.

Side Flag Settings

To use the side flags, the following settings are required.

Input source aspect ratio, auto side flags, and auto crop settings

Aspect ratio 4:3 setting

Set the input signal to aspect ratio 4:3. If set to 16:9, the side flags are disabled.

Auto side flag setting

This function automatically applies side flags when a 4:3 signal is selected in the cross-point control block.

Auto crop setting

When carrying out a DME wipe, this function automatically crops the image during transition to 4:3.

Adjusting the width of the side flag area

You can set the left and right sides separately.

For the operation for the above setting, see “Settings for Switcher Configuration (Config Menu)” in Chapter 16 (Volume 2).

Side flag enable/disable setting

Using the Misc menu or a button operation, you can enable or disable the side flags for the background bus of each of the M/E-1 to M/E-3 and PGM/PST banks.

For more details, see “Side Flag Settings” (page 550).

Assigning the side flag function to a cross-point button

To switch the side flags on and off with a button operation, it is first necessary to assign [SIDE FLAG] to the rightmost cross-point buttons.

For more details, see “Cross-Point Settings (Xpt Assign Menu)” in Chapter 16 (Volume 2).

Wipe Action on Images With Side Flags

When a wipe is carried out on an image with side flags, all wipe patterns can be used.

The following illustration shows the action in a wipe.

Wipe from a 4:3 image to a 16:9 image

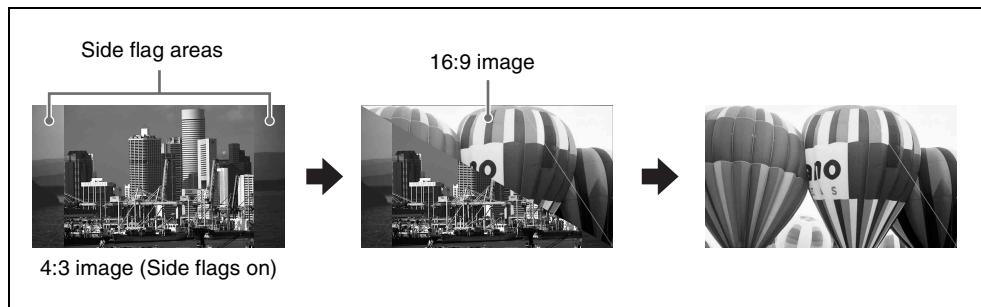

Wipe from a 4:3 image to another 4:3 image (when side flags are on for both images)

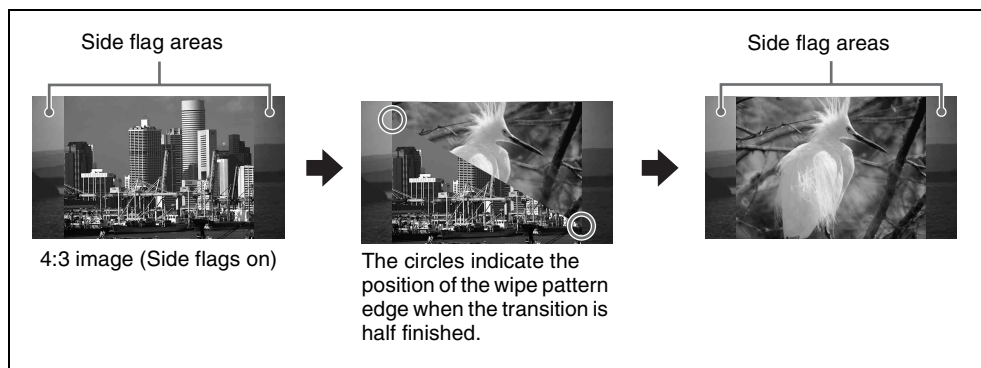

DME Wipe Action for an Image With Side Flags

When a DME wipe is carried out on an image with side flags, all wipe patterns can be used.

Depending on the setting (On/Off) of [Auto Crop] in the Engineering Setup >Switcher >Config menu, the appearance of the 4:3 image changes.

Notes

- When using the MVE-9000/MVE-8000A through SDI interface with [Auto Crop] being off, side flags are not added to the new image during DME wipe.
- For signals with the following DME wipe pattern selected on the DME external video bus (gray part shown in the pattern illustration), side flags are not applied when auto side flags are set to Off.
 - Two-channel page turn
 - Two-channel page roll

- Two-channel frame in-out
- Two-channel brick
- Three-channel brick

The following illustration shows the action in a DME wipe.

DME wipe from a 4:3 image to a 16:9 image

Wipe action using slide (No. 1001)

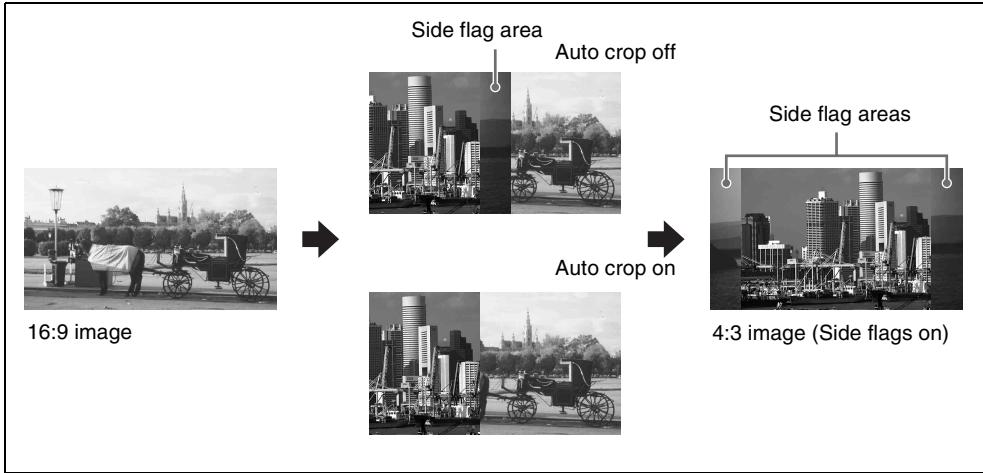

DME wipe from a 4:3 image to another 4:3 image (when side flags are on for both images)

Wipe action using squeeze (No. 1031)

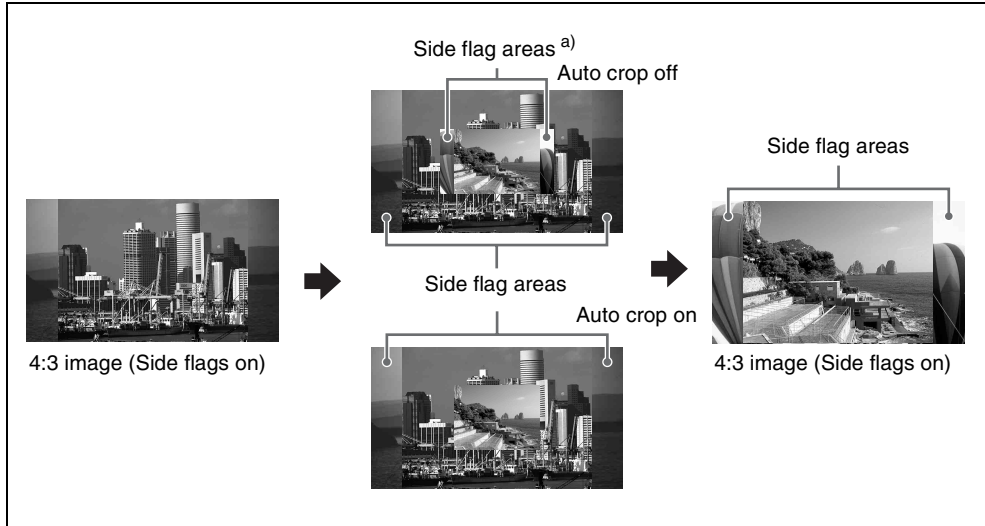

a) When using the MVE-9000/MVE-8000A through SDI interface, side flags are not added during a DME wipe.

Video Process

The term “video process” is applied to adjustments to the luminance and hue of the input video signal.

There are two types of adjustment, depending on the application:

- Adjustment of an individual primary input signal
- Image effects on a particular bus

Note

These types of adjustment may be carried out independently. However, since they are implemented by the same hardware, if the same signal is subjected to processing twice, there may be limitations on the range of effects obtained in the final result.

Video Process Adjustments of a Primary Input Signal

For each of primary inputs 1 to 80, you can switch video process adjustments on or off, and can adjust the parameters (Video Gain, Y Gain, C Gain, Hue Delay, and Black Level) in the Setup menu. The adjustments do not, however, apply to the output video on the MON (monitor) bus.

For details of the settings, see “Signal Input Settings” in Chapter 16 (Volume 2).

Video Process Adjustments on a Particular Bus

Buses to which the adjustments apply

For each of the following buses, you can switch video process adjustments on or off, and adjust the parameters.

- Following buses in the M/E-1 to M/E-3, and PGM/PST banks
 - Key fill buses for keys 1 to 4
 - Background A and background B buses
 - Utility 1 and utility 2 buses
- Frame memory source 1 and frame memory source 2 buses
- Aux 1 to 48 buses

These settings also apply to keyframes and snapshots.

Making the adjustments

Adjust VIDEO GAIN, Y GAIN, BLACK LEVEL, C GAIN, and HUE DELAY in the following menus.

Applicable bus		Menu used for operation	See page
M/E-1 to M/E-3 banks	Key fill buses for keys 1 to 4	M/E-1 to M/E-3 menus	page 405
	Background A and B buses	Video Process menu	page 557
	Utility 1 and 2 buses		
PGM/PST bank	Key fill buses for DSK1 to DSK4	PGM/PST menu	page 405
	Background A and B buses	Video Process menu	page 557
	Utility 1 and 2 buses		
Frame memory source 1 and 2 buses		Frame Memory menu	page 498
Aux 1 to 48 buses		AUX/MON menu	page 555

Video Process Memory

When using video process adjustments for an image effect on a bus, this function saves the final values for each pair number for the signals. The video process on/off setting is not saved.

When you change the adjustments the values are automatically saved, and these last values are recalled when the pair number is selected.

In other words, by switching video process memory on, regardless of the video process information for each bus, you can carry out video process adjustments for each input signal.

The parameters saved are as follows.

VIDEO GAIN, Y GAIN, BLACK LEVEL, C GAIN, HUE DELAY

Switch the video process memory on or off in the Setup menu.

For details of setting operations, see “Settings Relating to Keys, Wipes and Frame Memory (Key/Wipe/FM Menu)” in Chapter 16 (Volume 2).

Digital Multi Effects (DME)

DME allows you to add three-dimensional effects such as image movement, rotation, magnification and shrinking, as well as a wide variety of special effects. DME is the general name for all of these effects.

You can use up to eight channels as dedicated DME channels. Each channel can be used on its own or in combination with other channels, which allows you to create advanced effects with more complexity.

Functions that can be used differ with the models of DME. For details, see “Functional Differences With Models of DME” in the Appendix (Volume 2).

MVE-8000A Multi Format DME Processor

The MVE-8000A is a “Digital Multi Effects” with multi-format support. For the MVE-8000A, a dedicated interface (MKE-9020M) is available to enable the MVE-8000A to be used in an MVS-8000 series switcher. Installation of an optional MKE-8021A Input/Output Board in the MVE-8000A provides an SDI interface.

Note

When using the SDI interface, the following operations are required.

- Setting the interface between the MVE-8000A and the switcher.

See “Setting the interface between the DME and the switcher” in Chapter 16 (Volume 2).

- Setting the input signals from the switcher to the MVE-8000A (AUX bus outputs), and signals returned to the switcher as primary inputs (reentry inputs). However, “Ext In” cannot be set for the DME channel.

See “Setting the AUX bus output and reentry input” in Chapter 16 (Volume 2).

- Selecting the combiner channels not in the key control block, but in the Global Effect menu.

See “Combiner Settings” in Chapter 11 (Volume 2).

MVE-9000 Multi Format DME Processor

The MVE-9000 is a “Digital Multi Effects” with multi-format support. Two interfaces are available for the MVE-9000: a dedicated interface (MKE-9020M) for use in an MVS-8000 series switcher, and an SDI interface (MKE-9021M).

Note

When using the SDI interface, the following operations are different from when using the dedicated interface.

- Setting the input signals from the switcher to the MVE-9000 (AUX bus outputs), and signals returned to the switcher as primary inputs (reentry inputs).

See “*Setting the AUX bus output and reentry input*” in *Chapter 16 (Volume 2)*.

- Selecting the combiner channels not in the key control block, but in the Global Effect menu.

See “*Combiner Settings*” in *Chapter 11 (Volume 2)*.

Three-Dimensional Transformations

Transformation is the process of placing a video image in a three-dimensional DME coordinate space and subjecting it to manipulations such as movement, rotation, magnification or shrinking.

Three-dimensional coordinate space

Source coordinate space and target coordinate space

Images are placed in one of two types of coordinate space: source coordinate space and target coordinate space.

- The source coordinate space is a three-dimensional coordinate space with reference to the image itself. The x- and y-axes are defined parallel to the plane of the image, and the z-axis is defined perpendicular to the plane of the image. When you move the image, the coordinate axes also move.
- The target coordinate space is a three-dimensional coordinate space with reference to the output monitor screen. The x- and y-axes are defined parallel to the plane of the monitor screen, and the z-axis is defined perpendicular to the plane of the monitor screen. The coordinates do not move even if the image moves.

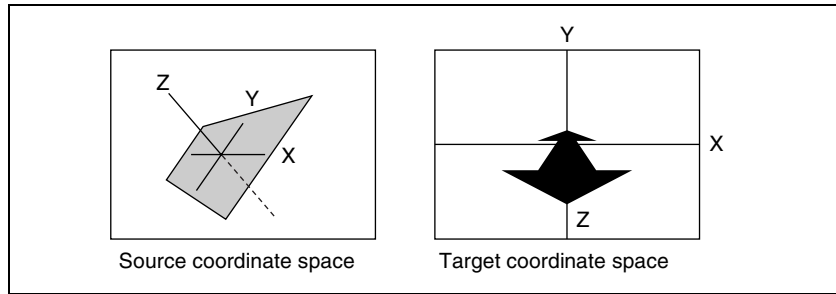

Source coordinate space and target coordinate space

For example, as shown in the following figure, the image moves in a different direction when you move it along the x-axis of the source coordinate space and along the x-axis of the target coordinate space.

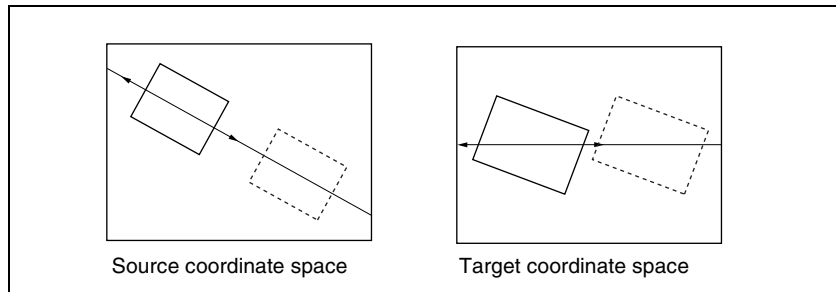

Movement along the x-axes of the source coordinate space and target coordinate space

Local coordinate space and global coordinate space

The coordinates of an individual DME channel are called its local coordinate space. The coordinates common to all channels are called the global coordinate space.

By switching from local to global coordinate space, you can add new movement to the movement of images in individual channels, and also apply transformation effects to multiple channels that have been combined by Global effects (*page 152*).

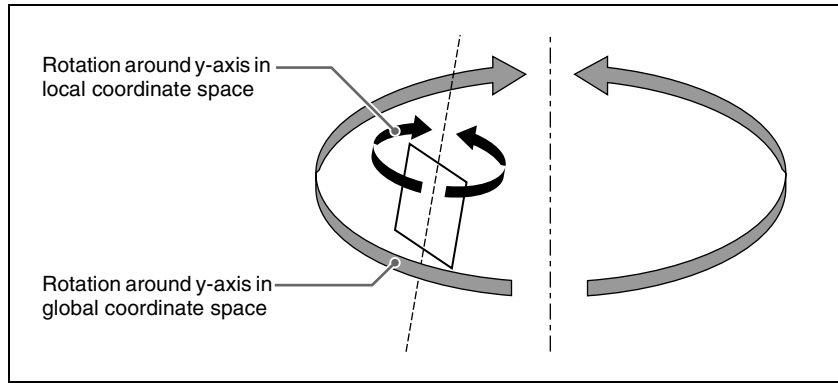

Local coordinate space and global coordinate space

Three-dimensional parameters

Three-dimensional parameters are x, y, and z values which define the position of an image, its axis of rotation, the position of an imaginary point of view on the image, and so on.

The standard values of parameters are as follows, depending on the aspect ratio of your monitor (4:3 or 16:9).

Values for 4:3 mode

- **Origin at center of image (source coordinate space) or center of monitor (target coordinate space)**

$x = 0.00, y = 0.00, z = 0.00$

- **Upper right corner of image or monitor**

When using SD format signals: $x = 4.00, y = 3.00, z = 0.00$

When using HD format signals: $x = 12.00, y = 9.00, z = 0.00$

- **Lower left corner of image or monitor**

When using SD format signals: $x = -4.00$, $y = -3.00$, $z = 0.00$

When using HD format signals: $x = -12.00$, $y = -9.00$, $z = 0.00$

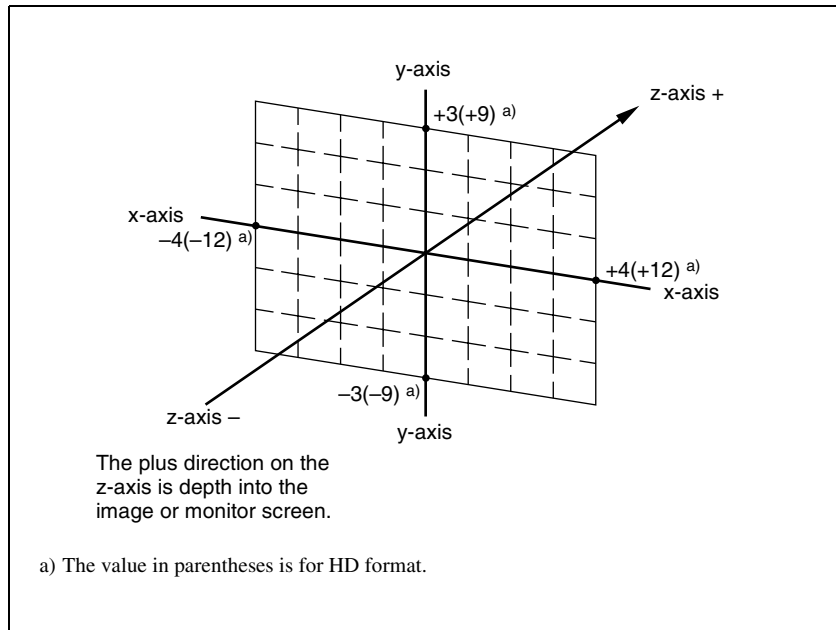

Values for x-, y-, and z-axes (4:3 mode)

- **Values for 16:9 mode**

- **Origin at center of image (source coordinate space) or center of monitor (target coordinate space)**

$x = 0.00$, $y = 0.00$, $z = 0.00$

- **Upper right corner of image or monitor**

When using SD format signals: $x = 4.00$, $y = 2.25$, $z = 0.00$

When using HD format signals: $x = 16.00$, $y = 9.00$, $z = 0.00$

• **Lower left corner of image or monitor**

When using SD format signals: $x = -4.00, y = -2.25, z = 0.00$

When using HD format signals: $x = -16.00, y = -9.00, z = 0.00$

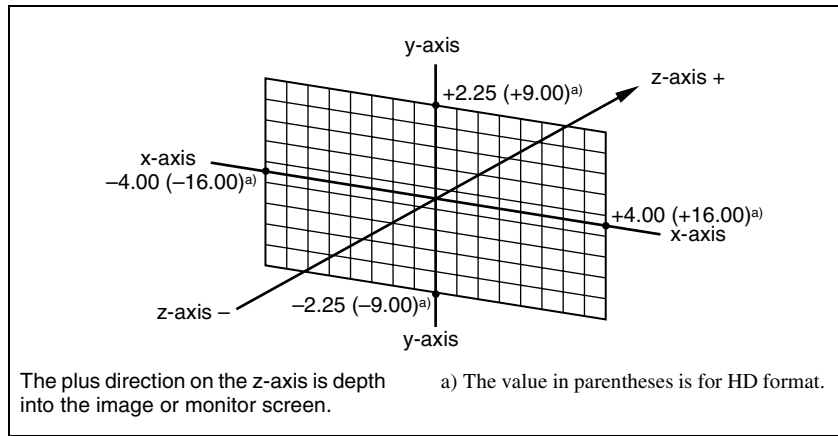

Values for x-, y- and z-axes (16:9 mode)

Limits of three-dimensional parameters

The following table shows the limits of three-dimensional transformation parameters.

The three-dimensional parameters of an image change when you use the trackball or Z-ring to execute a transformation. You can also execute a transformation by entering parameter values from the numeric keypad control block.

Operation mode	Limits of three-dimensional transformation parameters		
Location XYZ	HD format:		-999.9999 to +999.9999
	SD format:	4:3	-333.3333 to +333.3333
		16:9	-250.0000 to +250.0000
Rotation, Spin	-999.9999 to +999.9999		
Axis Location	HD format:		-999.9999 to +999.9999
	SD format:	4:3	-333.3333 to +333.3333
		16:9	-250.0000 to +250.0000
Location Size	0.0000 to +999.9999		
Aspect	0.0000 to +2.0000		
Perspective (x, y)	HD format:		-999.9999 to +999.9999
	SD format:	4:3	-333.3333 to +333.3333
		16:9	-250.0000 to +250.0000
Perspective (z)	0.0000 to 999.9999		

Operation mode	Limits of three-dimensional transformation parameters
Skew	-9.9999 to +9.9999

Detents

The system defines points called detents at regular intervals on the three-dimensional space. Pressing the [CTR] button in the device control block sets the current three-dimensional parameter values to the closest detent points. (For details, see “Three-Dimensional Transformation Operations” in Chapter 11 (Volume 2).)

The following table shows the interval between successive detents for each transformation operation mode (see page 116).

Operation mode	Detent interval
Location XYZ	1.0000
Rotation, Spin	0.2500
Axis Location	1.0000
Location Size	0.2500
Aspect	1.0000 ^{a)}
Perspective (x, y)	1.0000
Perspective (z)	1.0000 ^{a)}
Skew	0.1000

a) When a value is smaller than 1, 1/Aspect or 1/Perspective (z) is adjusted to an integral value.

Three-dimensional parameter default values

Each of the transformation operation modes has default values for three-dimensional parameters. If required, you can return the current value to the defaults by pressing the [CTR] button in the device control block twice in rapid succession. (For details, see “Three-Dimensional Transformation Operations” in Chapter 11 (Volume 2).)

The following table shows the default parameter values for each transformation operation mode.

Operation mode	Default value
Location XYZ	0.0000
Rotation, Spin	0.0000
Axis Location	0.0000
Location Size	1.0000
Aspect	1.0000

Operation mode	Default value
Perspective (x, y)	0.0000
Perspective (z)	1.0000
Skew	0.0000

Resetting of parameter values set in the source coordinate space

In some transformation operation modes, if you switch to the target coordinate space after setting up a three-dimensional transformation in the source coordinate space, the setting values in the source coordinate space (three-dimensional parameter values) are converted to values in the target coordinate space (source/target conversion).

Once a conversion has taken place, the original source coordinate space parameters do not return to their original values when you switch back to the source coordinate space. They are reset to zeros.

Source/target conversion occurs in the following operation modes:

- Location XYZ
- Rotation

Transformation Operation Modes

The following operation modes are available for three-dimensional DME transformations. These operations are carried out in the device control block (trackball or joystick). (For details, see “Three-Dimensional Transformation Operations” in Chapter 11 (Volume 2).)

Location XYZ

Moves the image on the x-axis, y-axis, or z-axis. The direction of movement differs depending on whether you are manipulating the image in the source coordinate space or the target coordinate space.

Image movement in the source coordinate space

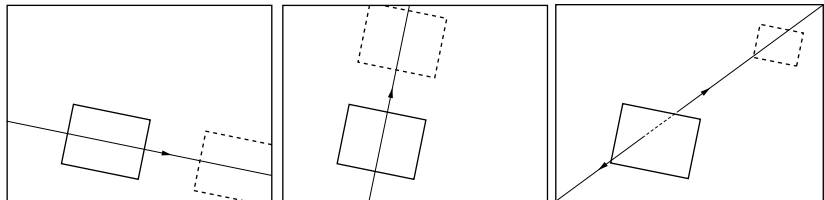

Movement on the x-axis

Movement on the y-axis

Movement on the z-axis

Image movement in the target coordinate space

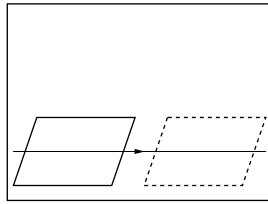

Movement on the x-axis

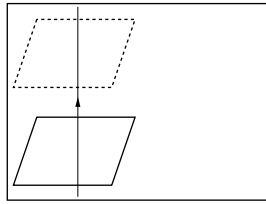

Movement on the y-axis

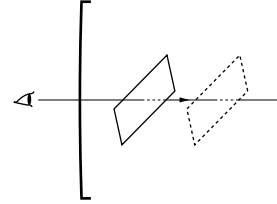

Movement on the z-axis

Rotation

Rotates the image on the x-axis, y-axis, or z-axis. The type of rotation differs depending on whether you are manipulating the image in the source coordinate space or the target coordinate space.

Image rotation in the source coordinate space

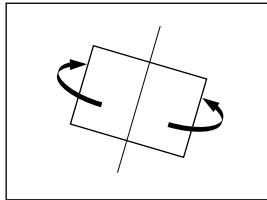

Rotation around the y-axis

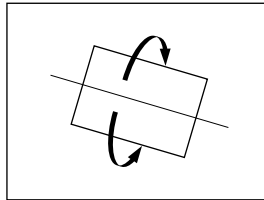

Rotation around the x-axis

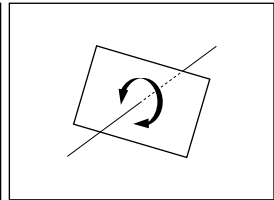

Rotation around the z-axis

Image rotation in the target coordinate space

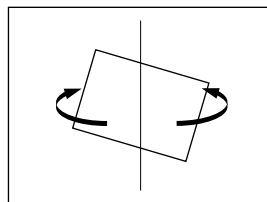

Rotation around the y-axis

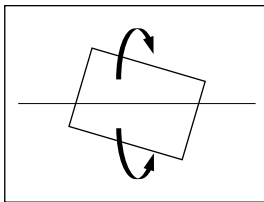

Rotation around the x-axis

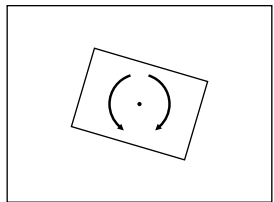

Rotation around the z-axis

Spin

When rotating the image in Rotation mode, it may not always be possible to achieve the kind of rotation around an axis that you want. Combining Rotation mode with Spin mode creates an effect that rotates the image around a specified axis. The type of rotation differs depending on whether you are manipulating

the image in the source coordinate space or the target coordinate space. (The way the image rotates around an axis is the same as in Rotation mode.)

Axis Location

Moves an axis of rotation in the source coordinate space.

Axis movement

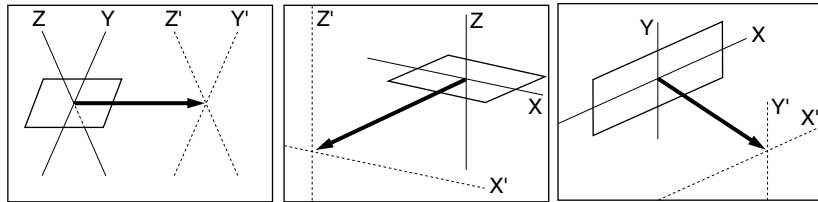

Movement on the x-axis

Movement on the y-axis

Movement on the z-axis

Location Size

Changes the size of the whole image.

- Because shrinking and magnification of the image in the source coordinate space is done in three-dimensional space, magnifying the image emphasizes the sense of perspective.
- Because shrinking and magnification of the image in the target coordinate space is a conversion of the two-dimensional image displayed on the monitor, shrinking and magnification does not change the shape of the image.

Magnification and shrinking in the source coordinate space

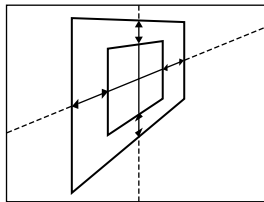

Magnification and shrinking in the target coordinate space

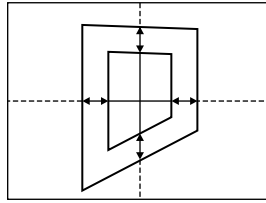

Aspect

In the source coordinate space, changes the aspect ratio in the x-axis direction and y-axis direction, either independently or simultaneously.

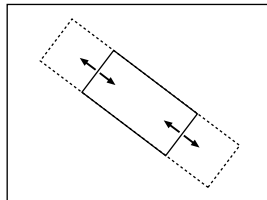

Change of aspect ratio in x-axis direction

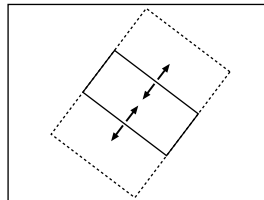

Change of aspect ratio in y-axis direction

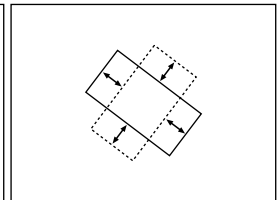

Simultaneous change aspect ratio in x-axis direction and y-axis direction

Perspective

In the target coordinate space, changes the perspective on the image by changing an imaginary view point, without changing the position of the image. The x-axis and y-axis values define the position of the view point. The z-axis value defines its distance from the image.

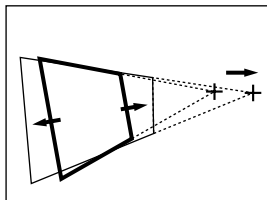

Change of view point on x-axis

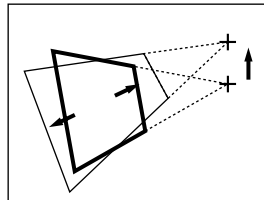

Change of view point on y-axis

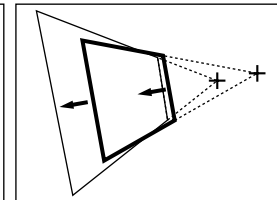

Change of distance from view point to image

Skew

In the source coordinate space, change the skew of the image on the x-axis or y-axis.

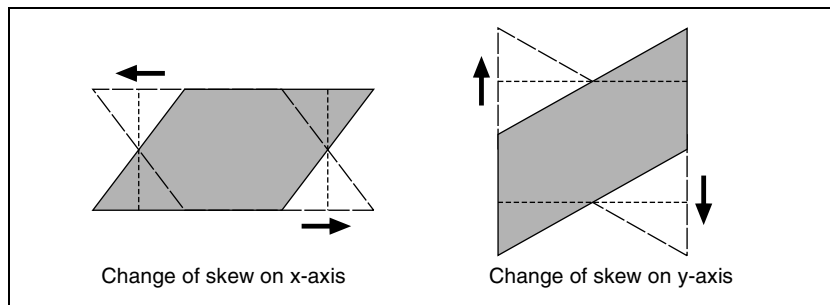

Graphics Display

Graphics display is a function that allows you to display wire frames, coordinate axes and a grid over the current DME image, to make it easier to create effects in three-dimensional coordinate space. Graphics displayed by this function can also be output to the monitor output connector.

Note

On the MVE-8000 and the MVE-8000A (when using the DME dedicated interface), these graphics cannot be output to the monitor output connector.

To make graphics display settings, use the DME menu. (*For details, see "Graphics Display" in Chapter 11 (Volume 2).*)

You can display the following kinds of graphics.

Wire frames

A wire frame displays an image enclosed in a frame, so that you can check the position and size of the image. If there is a shadow (*see page 157*), a frame is shown for the shadow as well.

Coordinate axes

This is a three-dimensional display of coordinates in local or global coordinate space. You can check the origin of the axes and the directions of the x-, y-, and z-axes.

Channel ID

This displays the channel number so that you can check which channel you are using, a useful feature when you are working with multiple channels.

Channel IDs are displayed differently in local and global coordinate space.

- In local coordinate space, the channel number is displayed along with “F” or “B” to indicate whether you are looking at the front (F) or back (B) of the current wire frame. For example, “1F” means the front of the wire frame on channel 1 in local coordinate space.
- In global coordinate space, the channel number is displayed along with “G” to indicate global. For example, “G2” means channel 2 in global coordinate space.

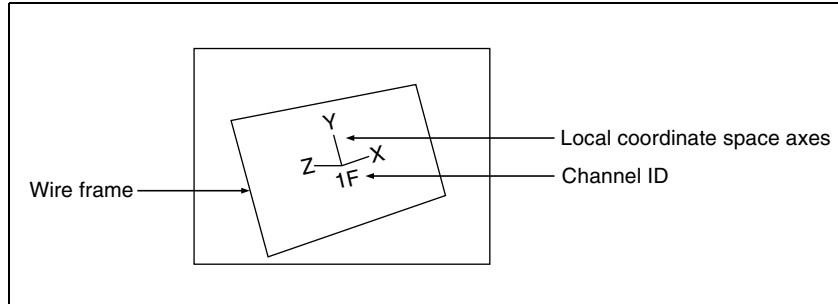

Wire frame, local coordinate space axes, and channel ID

Grid

This is a grid pattern representing the whole of the monitor screen. The grid makes it easy to set the position of an image in two-dimensional coordinates.

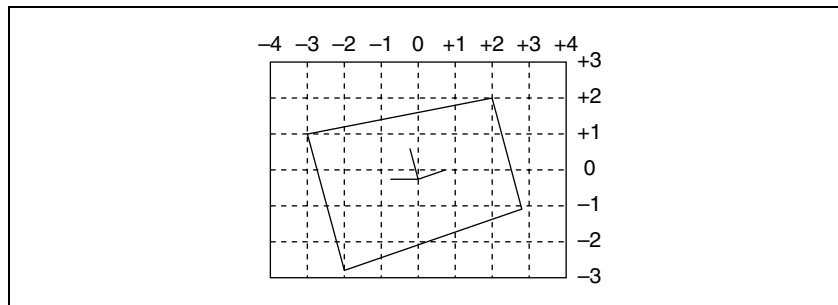

Grid (SD format, 4:3 mode)

Shrinking the graphics display

You can shrink the graphics display so that you can see beyond the range displayed on the normal monitor screen. This makes it possible to visually set the location of images in a larger space. The range displayed on a normal monitor screen is indicated by a frame.

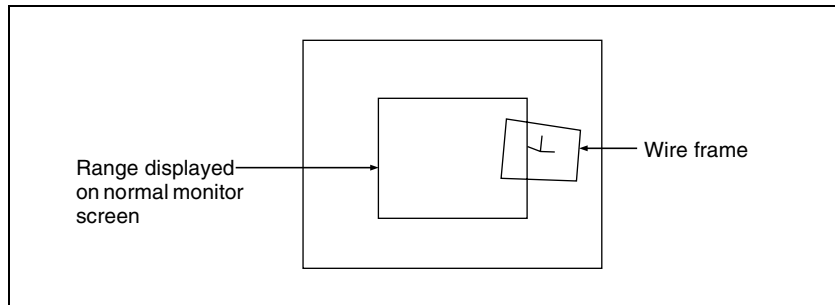

To automatically erase the graphic display

Turn Auto Erase on. The graphic display is erased automatically whenever a keyframe is executed. It is displayed again after the keyframe ends, after the time set in Recovery Time.

Flex Shadow center axis

When using the Flex Shadow function (*see page 125*), turn Flex Shadow Axis on to display the Flex Shadow center axis. This is an effective aid in making settings for this function.

Note

The Flex Shadow center axis function is not supported on the MVE-8000/8000A.

Three-Dimensional Parameter Display

You can display a three-dimensional parameter list for the currently controlled image. When more than one DME channel is selected, the status of the reference channel is displayed.

For the method of displaying a parameter list and an example display, see “Three-Dimensional Parameter Display” in Chapter 11 (Volume 2).

DME Special Effects

You can use DME to add a variety of special effects. To add effects, use the DME menu. (*See “DME Special Effect Operations” in Chapter 11 (Volume 2).*)

Border

This effect adds a border to the image frame. You can adjust the width (or thickness) of the border, its color, and the softness of the border edges.



Crop

This effect crops away the edges of the image. You can crop the top, bottom, left, and right sides individually or all together. You can also soften the cropped edges.

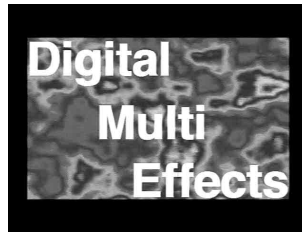

Defocus

Defocuses the whole image. The degree of defocusing can be set simultaneously or separately for video and key signals. (However, when the DME dedicated interface is used, the degree of defocusing can be set for video signals only.) You can also cancel the black level leaking that occurs at the edge of the screen when the Defocus effect is used.

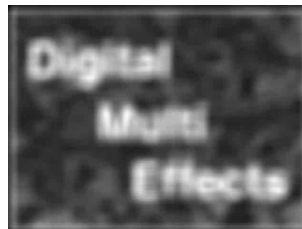

Blur

Applies a rounded blurring to the whole image.

Beveled Edge

This gives an image a beveled edge. You can set the edge width and color. The inner edge softness and edge boundary softness can also be set.

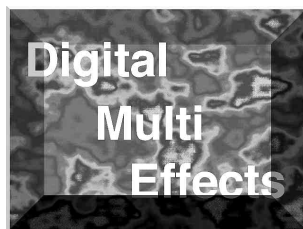

Light

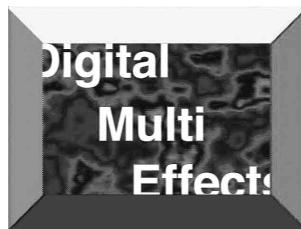

Color

Key Border

This effect adds borders to keys or gives a key consisting of an outline only.



Note

The Key Border function is not supported on the MVE-8000/8000A.

Art Edge

Adds edges to the inner and outer side of the input image.

The following items can be set.

- Art edge width and position
- Separate softening of the art edge inner and outer sides
- Color of art edges

Examples of Art Edge source



Gradation Matte

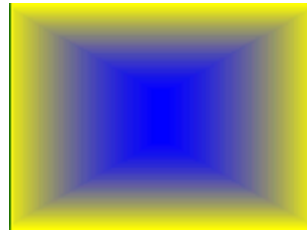

Radial Gradation

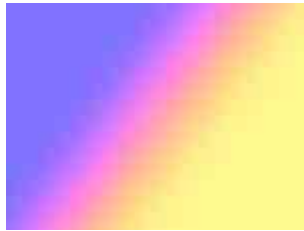

Rainbow Matte

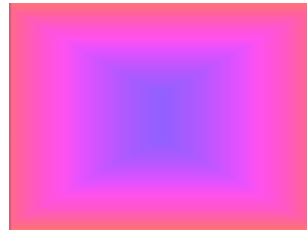

Radial Rainbow

Example effect using Art Edge source [Rainbow Matte]



Note

The Art Edge function is not supported on the MVE-8000/8000A.

Flex Shadow

This effect allows a shadow to be added to the image using only one DME channel.

The following settings can be made for the shadow.

- The signal to use for the shadow
 - **External:** Generate shadow using input key signal.



- **Internal:** Generate shadow using an internally generated, full-size DME key signal.
- Shadow shrinking and magnification
- Shadow position
- Shadow color and density
- Center axis of deformation
- Shadow slant and perspective



External

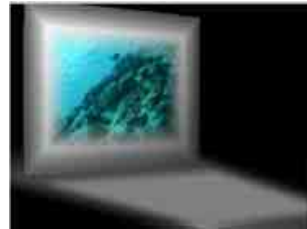

Internal

Note

The Flex Shadow function is not supported on the MVE-8000/8000A.

Wipe crop

This effect crops the video image to be visible inside or outside a wipe pattern.

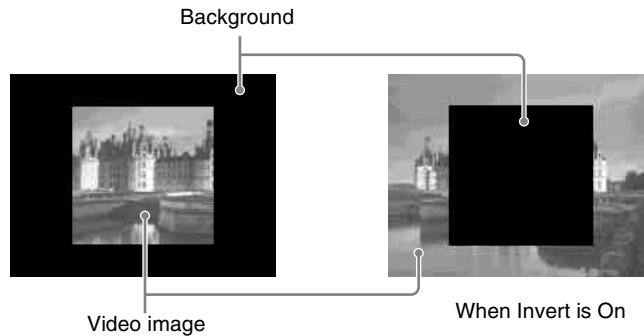

Note

The Wipe Crop function is not supported on the MVE-8000/8000A.

Color mix

This is a combination of two colors with a pattern generator. This color mix signal can be used to fill parts such as a background or border.

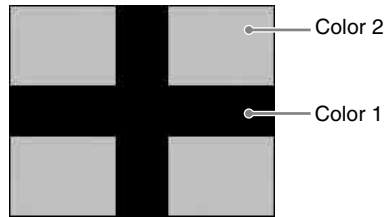

Note

The Color Mix function is not supported on the MVE-8000/8000A.

Multi Move

Shrinks the image and lines up a number of copies vertically and horizontally. You can specify the center point of the shrinking, the shrinking ratio, and the aspect ratio of the image screen.



Sepia

Overlays a specified color onto the image. You can adjust the sepia color that is overlaid, and specify the degree of mixing between the original image and the sepia image.

Mono

Converts the image into a monochrome image.



Posterization

Coarsens the luminance gradations of the image, for a painting-like effect. You can specify the degree of luminance coarsening.

Solarization

Like the Posterization effect, creates a painting-like effect, but does so by coarsening the chroma gradations of the image. You can specify the degree of chroma coarsening.

Nega

Reverses the luminance and/or chroma of the image.

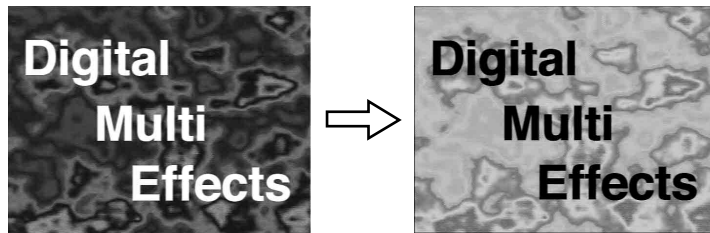

Contrast

Changes the contrast of the luminance and/or chroma of the image.

Mosaic

Divides the image into small tiles so that it looks like a mosaic. You can specify the size and aspect ratio of the tiles.

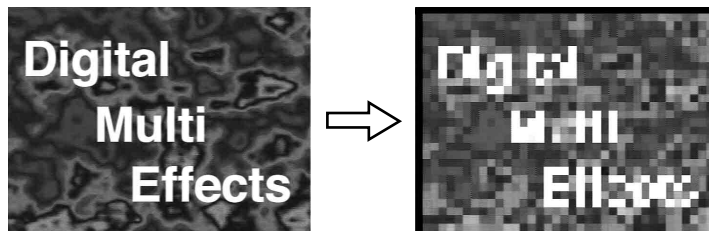

Sketch

Provides a sketch-like effect based on the outlines of the image, using different touches such as sketch, edge color, drawing, relief, and sharp.

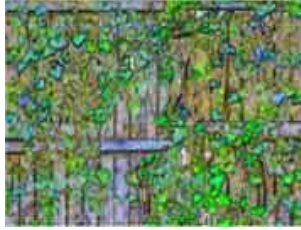

Sketch

Note

The Sketch function is not supported on the MVE-8000.

Metal

Provides a metallic gloss like that from gold, silver, or a rainbow colored surface. A metallic gloss can also be given to a freely selected color.



Note

The Metal function is not supported on the MVE-8000.

Dim and Fade

Dim makes the picture progressively dimmer into its depths. Fade progressively makes the depths of the picture fade into the background.



Fade

Note

The Dim and Fade functions are not supported on the MVE-8000/8000A.

Glow

Softens the edges of highlights, giving an effect like being struck by a soft light.



Note

The Glow function is not supported on the MVE-8000.

Mask

Masks part of the image so that special effects are applied only inside a selected pattern.

The mask function is applied in units made up of the following groups.

The Mask effect can be applied using effect group 1 and effect group 2 simultaneously.

Effect group 1: Posterization, Solarization, Nega, Sepia, Mono, Contrast, Mosaic, Sketch, Metal

Effect group 2: Defocus, Blur, Glow



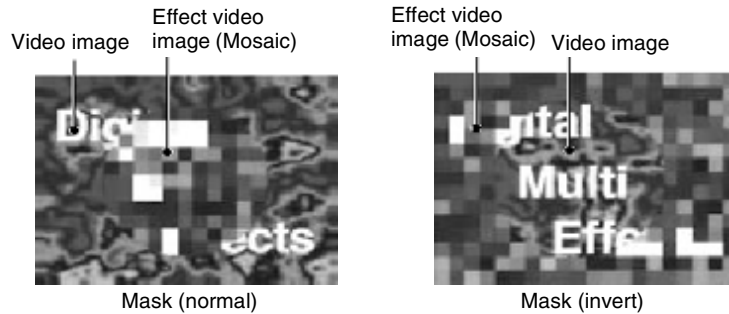

Notes

- The Mask function is not supported on the MVE-8000.
- On the MVE-8000A, the Mask function cannot be applied to both effect group 1 and effect group 2 simultaneously.

Freeze

Freezes the input video. The following types are available:

Hard Freeze: Freezes the input video at an arbitrary timing.

Time Strobe: Freezes the input video at specified intervals for a specified length.

Film: Slows the apparent frame rate, for an effect like film. You can specify the ratio of advancement.

For Hard Freeze and Time Strobe, you can select the first field or the frame as the freeze timing.

Nonlinear Effects

You can add a variety of effects, including effects that change the shape of the image as a whole.

The following nonlinear effects are available.

For more information about settings and operations with nonlinear effects, see “Nonlinear Effect Settings” in Chapter 11 (Volume 2).

Note

It is not possible to apply two or more nonlinear effects at the same time. Turning any nonlinear effect on automatically turns all other nonlinear effects off.

Wave

Produces a wave-like effect in the image.

There are two modes: H&V and Size. You can set the size and frequency of the waves, the wave form, the amount of wave movement, and the range. In H&V mode, you can also set the wave angle.



Note

When 720P/59.94 signal format is used, the wave effect is not supported on the MVE-8000.

Mosaic Glass

Makes the image rougher and finer at a specified interval.

There are two modes: H&V and Size. You can set the size and frequency of waves in the image, the wave form, the amount of wave movement, and the angle. In H&V mode, you can also set the wave angle.



Flag

Applies an effect like a flag waving in the wind.

There are two modes: H&V and Size. You can set the size and frequency of waves in the image, the wave form, the amount of wave movement, and the range. In H&V mode, you can also set the wave angle.

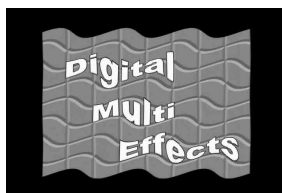

Twist

Twists the image.

You can twist the image in the horizontal or vertical direction.

You can set the size and frequency of waves in the image, the wave form, the amount of wave movement, and other parameters.

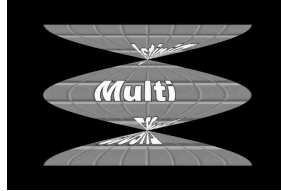

Ripple

Applies an effect like ripples moving across the image.

There are four modes: Radial, Angular, Both, and Shape. The direction of modulation differs depending on the mode. You can set the size and frequency of the ripples, their direction and speed, their center point, and other parameters. In Shape mode, you can select ripple shapes other than circles (stars, etc.).

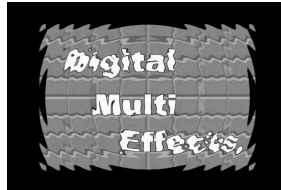

Rings

Partitions the image into rings that rotate while moving in the same direction.

You can set the degree of transition, the degree of randomness in the distance moved by each block, the amount of movement, the width of the partitions, the degree of randomness in partition width, the center point, the starting angle, and other parameters.

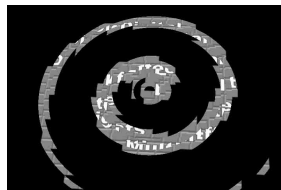



Broken Glass

Partitions the image like broken glass, with shards flying outward.

You can set the degree of transition, the degree of randomness in the distance moved by each block, the amount of movement, the width of the partitions, the degree of randomness in partition width, the center point, the starting angle, and other parameters.

You can also fix the direction in which shards scatter.

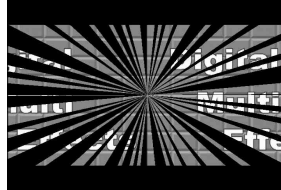

Flying Bar

Divides the image into bars which peel off in two blocks as they move.

You can set the degree of transition, the degree of randomness in the distance moved by each block, the direction of movement, the width of the partitions, the degree of randomness in partition width, the partition angle, and other parameters.

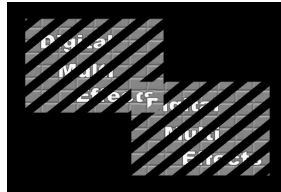

Blind

Divides the image into bars or wedges, with blocks rotating like the slats of venetian blinds.

There are two modes: Bar and Wedge. You can set the number of rotations by blocks, the perspective, the width and position of blocks, the direction, the center position, and other parameters.

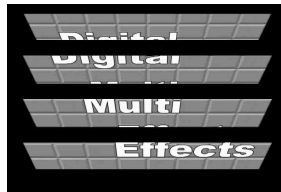

Split

Splits the image upper and lower, left and right.

You can set the degree to which the image is split, the split positions, and other parameters.

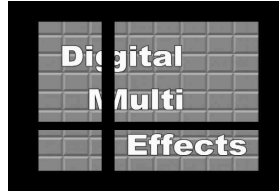

Split Slide

Divides the image into bars which slide alternately in reverse directions.

You can set the degree of transition, the degree of randomness in the distance moved by each block, the degree of sliding, block width, block angle, and other parameters.



Mirror

Partitions the image vertically and horizontally, creating an image like a reflection in a mirror.

You can choose to reflect in the directions left to right, right to left, bottom to top, top to bottom, or any combination of directions. You can also set the position of the border between original and reflections.

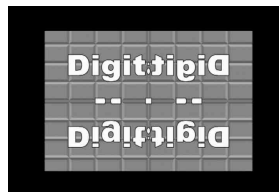

Multi Mirror

Divides the image into originals and reflections, lining them up vertically and horizontally.

You can set the width of the original, the center position of the original, the offset of the image with fixed mirrors, the direction of the mirrors, and other parameters.

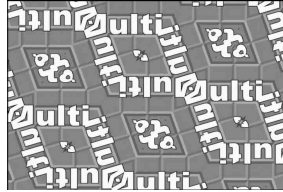

Kaleidoscope

Creates an image like a view into a kaleidoscope.

You can set the number of blocks, the partition reference point and angle, horizontal and vertical offsets, a reflection position, and other parameters.

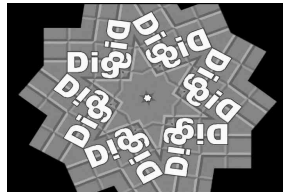

Lens

Creates an image like a view through a lens.

You can set the shape and aspect ratio of the lens, the angle, the magnification ratio, the curve ratio, the size, the center position, and other parameters.

You can also choose to display only the portion of the image that is seen through the lens.



Circle

Makes a circle with the image.



You can set the size of the circle, and make the axis of modulation vertical.



Panorama

Curves the upper and lower edges of the image to emphasize the sense of perspective.

You can set the horizontal and vertical curve ratio, and the curve center position.



Page Turn

Turns the image like a turning page.

There are four modes: H&V, H, V, and Off. You can select the turn position, the radius of the turned portion, the amount and angle of turning, and the input video for the front and back pages.

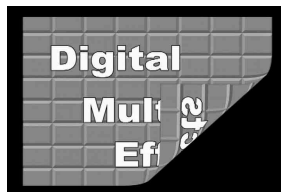

Roll

Rolls the image up.

There are four modes: H&V, H, V, and Off. You can select the turn position, the radius of the turned portion, the amount and angle of turning, and the input video for the front and back pages.



Cylinder

Winds the whole image onto a cylinder.

You can set the degree of winding onto the cylinder, the radius, the horizontal position of the wound image, and front and back side output for the image.



Sphere

Winds the whole image onto a sphere.

You can set the degree of winding onto the sphere, the radius, the horizontal position of the wound image, and front and back side output for the image.



Note

You cannot monitor the part of a rotating sphere that corresponds to its axis on the monitor screen.

Explosion

Divides the image into fragments which expand as they fly out.

You can set the pattern shape and aspect ratio, the center position, the amount of movement by fragments, the curvature of the transition path, and other parameters.



Swirl

Swirls the image.

You can set the amount of swirl, the swirl region, the amount of rotation, and the swirl center position.

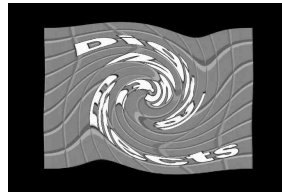

Melt

Melts the image away from a specified part.

You can set the degree of transition, the degree of extension in the image, the jaggedness of the melting sections, and the amplitude, frequency, amount of movement, and speed of the melting sections. You can also set the slant of the borders, the shape of the sections that begin to melt, and other parameters.



Character Trail

Extends the edge of the image like a trail.

You can set the effect starting position, the degree of expansion, the slant angle of the effect region, and trail direction, the degree to which the image disappears, the trail type and amount of stardust, and other parameters.

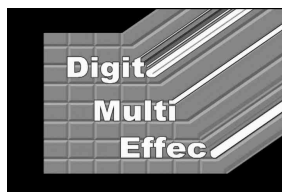

Lighting

Provides the effect of light striking the image. You can specify the intensity and color of the light and the lighting pattern. The following lighting patterns are available:

Plane: Illumination of the entire screen.

Bar: Bar illumination. You can specify the width and angle of the bar, and its softness.

Preset: Lighting pattern suitable for nonlinear effects.

When Bar is selected, the following modes can be selected.



Normal



Specular



Mat

Normal: Emphasizes the bar highlight area.

Specular: An effect like light striking a surface with metallic reflections.

Mat: An effect like light striking paper, cloth, or another diffusively reflective surface.

Note

The function for setting the bar mode of the lighting area is not supported on the MVE-8000/8000A.

Combine Shadow

When there are several images, add a flex shadow in the depth of an image or overlays multiple flex shadows.

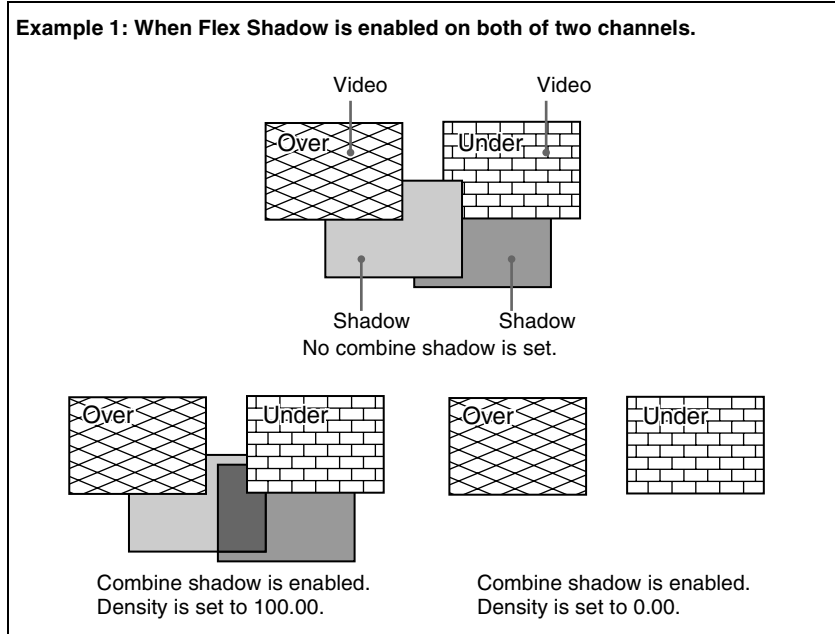

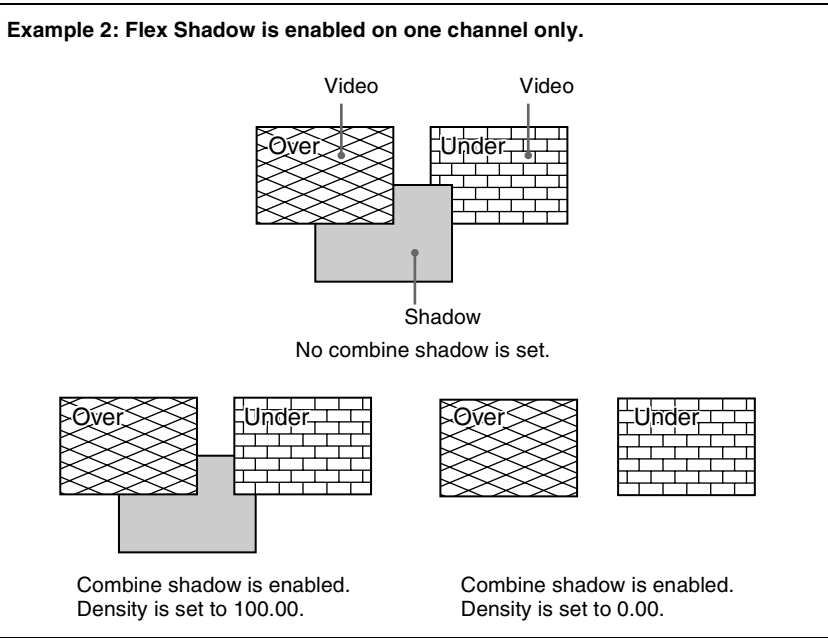

Trail

Recursively freezes the input video at regular intervals so that a trail of afterimages is created. You can make the afterimages stardust trails.

Note

Of the three effects of trail, motion decay and keyframe strobe, only one can be on at a time. When one of them is on, turning another of them on automatically turns off the one that has been on.

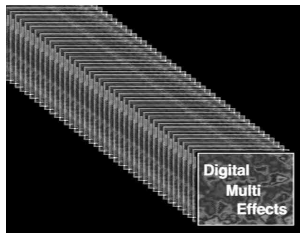

Motion Decay

Blurs the motion of a moving video by creating afterimages of the moving video. (See "Note" in the preceding section "Trail.")

You can make the afterimages stardust trails.



Keyframe Strobe

Freezes the video each time the effect passes a keyframe. (See “Note” in the section “Trail.”)

You can make the afterimages stardust trails.

Wind

This effect strobos the image at regular intervals, and moves the frozen image in a fixed direction, leaving an afterimage.

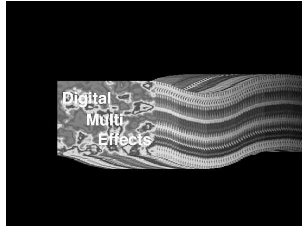

Note

The Wind function is not supported on the MVE-8000/8000A.

Spotlighting

Creates the effect of a spotlight striking the surface of the image.

You can set up to three light sources (lights 1 to 3).

Notes

- The Spotlighting function is not supported on the MVE-8000/8000A.
- The BZDM-9050 Texture Lighting Software (for MVE-9000) is required to set lights 2 and 3.

Adjustments to the image surface

The following adjustments can be made to the image surface struck by the light.

- **Adjusting the brightness of the whole image**
- **Selecting the image surface effect**

Flat: The image surface is unchanged, causing the selected light source to appear as the effect.

Texture: A texture appears on the surface of the image. Textures can be selected from among 30 patterns.

See the appendix “Texture Patterns” (Volume 2) for the texture patterns.

Non Linear: Spotlighting effect is applied to an area to which a DME nonlinear effect is applied.

Note

The BZDM-9050 is required to enable Texture and Non Linear settings.

- **Test sphere function**

A test sphere is a translucent sphere virtually embedded in the center of the input picture to provide an intuitive way for you to check the position and direction of the spotlight. When you change the position or direction of a light source, the side of the sphere closest to the light source grows brighter. You can easily check the position and direction of the light source by viewing the test sphere.

For more information about test sphere, see “Relation between test spheres and parallel rays” (page 148).

- **Adjusting the bumpiness of the image surface**
- **Coordinate axis on surface of image**

Specify where to apply the texture or test sphere on the image surface.

Move: The texture moves together with the DME image.

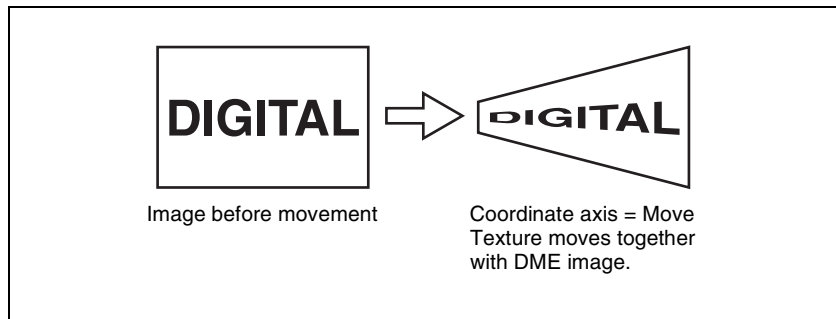

Fix: The texture does not move, even if the DME image moves.

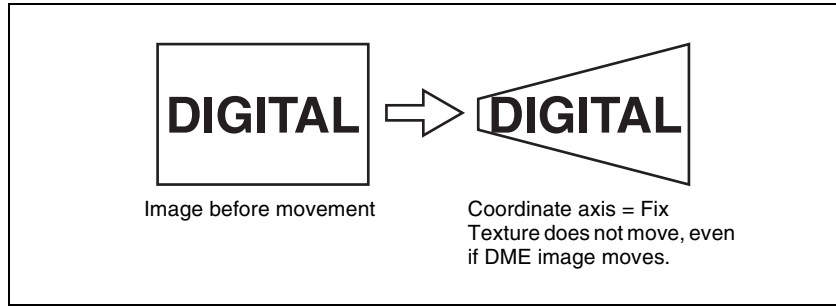

• **Texture deformations**

You can change the texture pattern, position, and size, and use the repetition function.

The following figure shows examples of a texture pattern repeated in the X and Y directions.

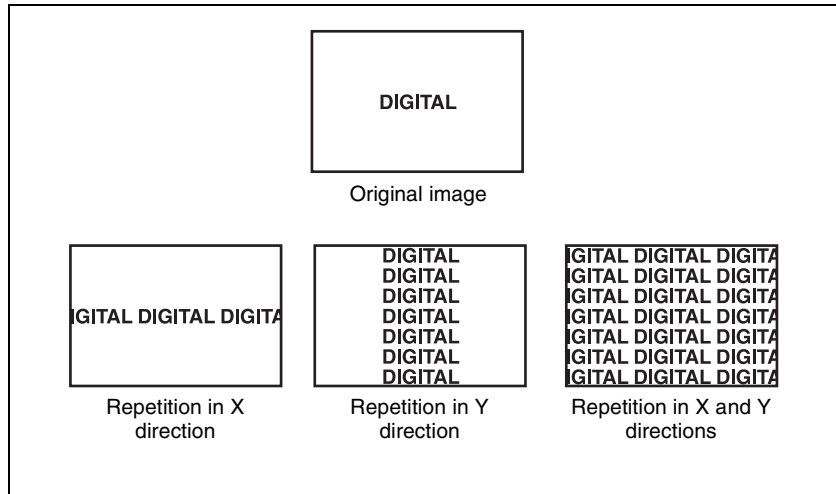

Setting lights

• **Light source types**

The following type of light sources are available (*see figure*).

Parallel: Parallel light source

Point: Point light source. As the light source is placed further away, the illuminated range becomes wider and the light become weaker.

Line: Line light source

Whole: Non-directional light source which illuminates the whole image.

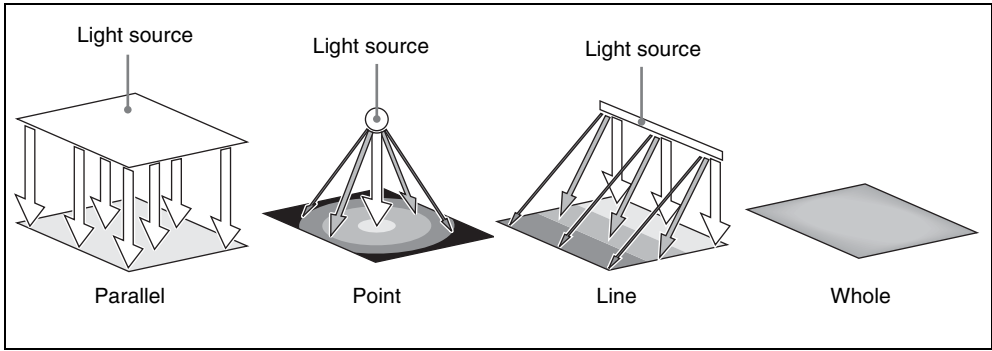

• **Linking and unlinking image and spotlight**

The spotlight can move together with a DME image, or be fixed in place.

Source: Place the light source in source coordinate space. The spotlight is linked and moves when the image moves.

Target: Place the light source in target coordinate space. The spotlight does not move, even when the image moves.

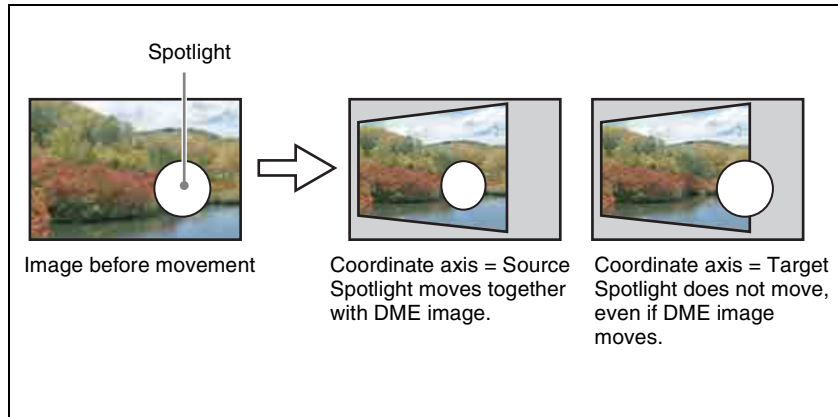

• **Selecting the lighted area**

You can select the area lit by the spotlight.

FRGD: The light strikes the image foreground.

BKGD: The light strikes the image background.

Both: The light strikes both foreground and background.

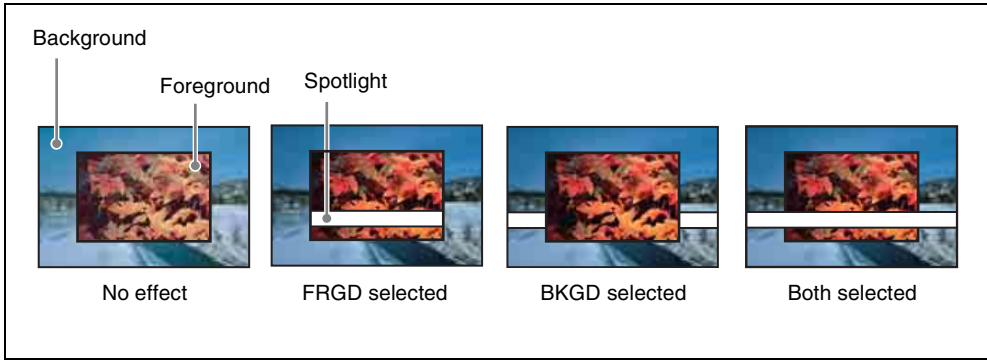

- **Surface Flat**

For the currently selected light source only, you can forcibly make the image surface effect flat.

This is effective when you have selected texture as image surface effect and want a flat effect for one light source only.

- **Light shape**

Creates the light shape.

- Select the shape pattern

For shape patterns, see the appendix “Shape Patterns” (Volume 2).

- Set the size, degree of deformation, softness, and rotation.

- **Ring settings**

Shines the light with a hole in the middle, like a doughnut. Adjust the following parameters.

Offset: Distance to move the center of the ring from the initial position (the position set when selecting the light source in the <Spot Mode> group).

Radius: Inner side radius of the ring.

Angle: When an Offset is set, the rotation angle of the ring around the initial center position.

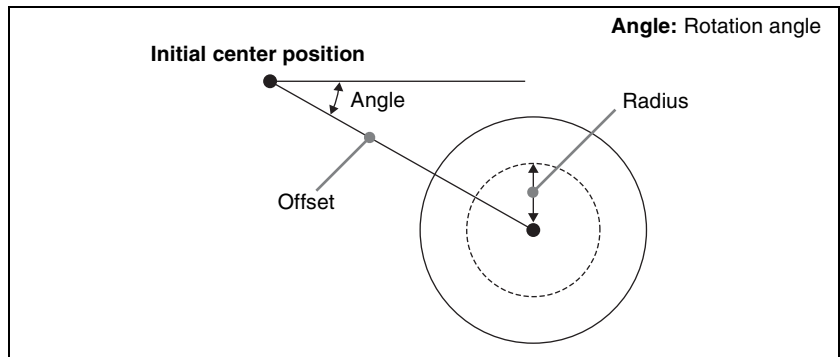



- **Fill blending modes**

Specifies the way in which the light is blended with the image.

Mix: Light as if reflected from a mirror. The light can be given a color.

Multiply: Light as if reflected from a dull surface (diffuse reflection).

Relation between test spheres and parallel rays

The following figure shows an example of the effect of parallel rays on a test sphere.

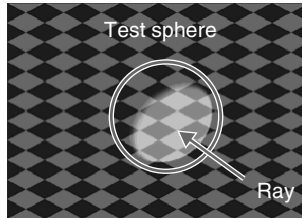

The direction of a ray is defined by longitude and latitude.

- Longitude: A direction (angle), expressed as a plus value for clockwise rotation in the plus direction with respect to the X axis of the input picture.
- Latitude: Latitude

The following figure shows the relationships between the longitude and latitude of parallel rays, input picture, and test sphere.

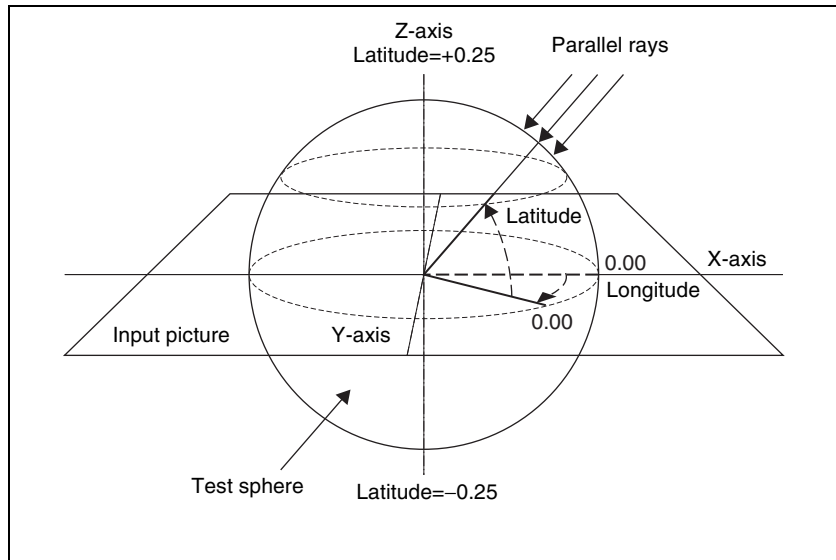

The unit of these direction parameters is the number of rotations, with 360° (1 rotation) expressed as 1.00, in the same way as 3D rotation parameters. The following relationships apply in the example shown in the figure.

Parameter	Setting	Angle
Longitude	0.12	45°
Latitude	0.12	45°

The fractional part of the setting after the decimal point corresponds to an angle 0 to 360° . If the fractional parts of two setting values are the same, the effect is the same even if the integral parts are different.

The integral part of a setting value is used when moving a light source with keyframes.

For example, when the longitude of a light source rotates in the clockwise direction from 0.88 (315°) to 0.12 (45°), it rotates in the counterclockwise direction (the angle grows smaller) if the above values are used. In this case, the value of the second keyframe can be set to 1.12 ($330^\circ + 45^\circ$).

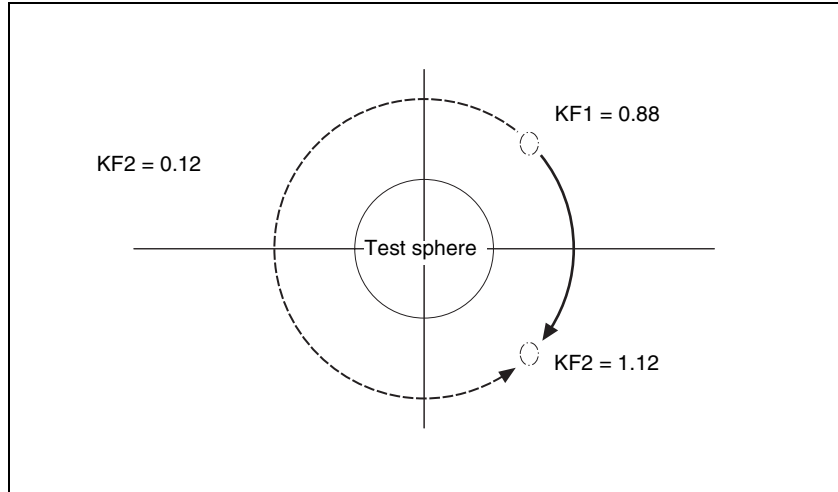

Keyframe trajectory

User texture pattern

In the spotlighting function, a user generated texture pattern can now be selected for the pattern with which the light falls on the image surface. To add a texture pattern, create a texture package from a bitmap file, and install it.

The installed texture pattern can be selected in the same way as the texture patterns provided by default.



Note

The user texture pattern function is not supported on the MVE-8000/8000A.

For details of spotlighting, see page 143.

For details of how to create a user texture pattern, see “Adding user texture patterns” in Chapter 16 (Volume 2), and for how to select a pattern once created, see “To select a texture pattern” in Chapter 11 (Volume 2).

Background

Adds a color or inputs an external signal to the background of the image.

Note

Signal selection for this purpose is not supported on the MVE-8000/8000A.

Separate Sides

Applies separate video signals and key signals to the front and back of the image.

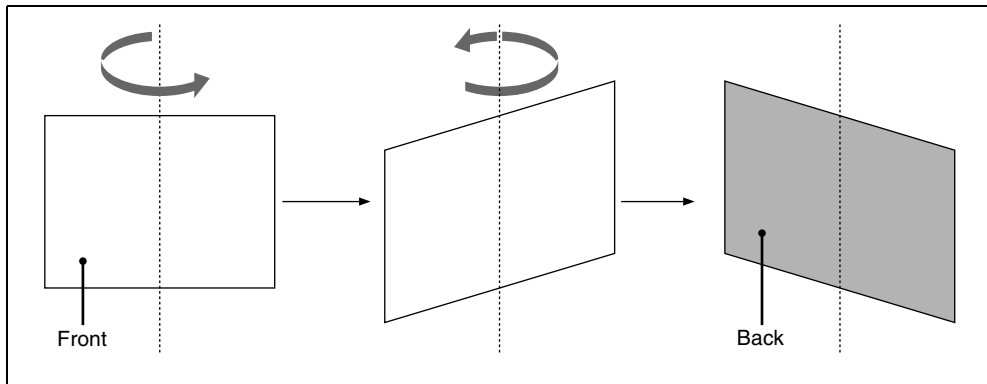

Front and back sides

Shaped Video

For each of the front and back sides of the image, specifies whether to handle input video from the switcher as shaped video (key processed signals).

Note

The shaped video function can only be used with the MVE-8000A/9000 (SDI interface).

Invert

Inverts the input video signal and/or key signal horizontally or vertically. You can make separate settings for the front and back.

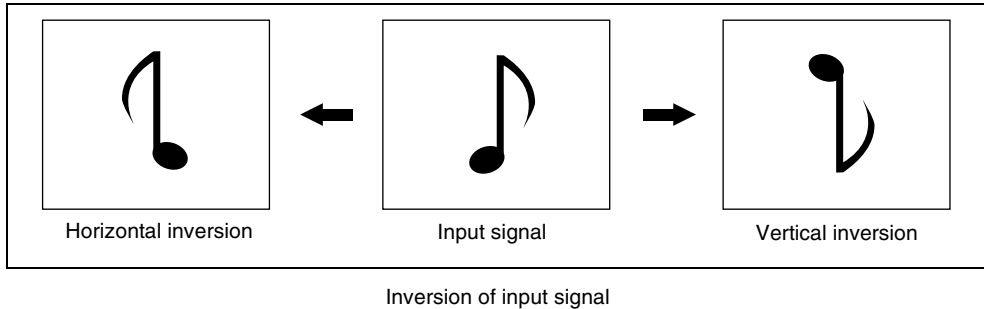

Interpolation

Specifies the methods used for interpolation processing of input video signals and input key signals.

For input video signals, you can select from the following four methods.

- Detect changes in the luminance and chrominance signals separately, and switch automatically between fields and frames. You can select the degree of change detection.
- Detect changes in the luminance signal separately, and switch automatically between fields and frames. You can select the degree of change detection.
- Do interpolation in field units.
- Do interpolation in frame units.

For input key signals, you can select from the following three methods.

- Detect changes in the luminance signal separately, and switch automatically between fields and frames. You can select the degree of change detection.
- Do interpolation in field units.
- Do interpolation in frame units.

You can also select the number of pixels used in interpolation processing, and select the method used to show the picture reduced or expanded.

Further, you can apply an anti-moire filter to reduce the moire patterns created by interpolation.

Notes

- Interpolation processing is possible for the following signal formats and DME systems.

- MVE-8000/8000A: 480i/59.94, 576i/50
- MVE-9000: 480i/59.94, 576i/50, 1080i/59.94, 1080i/50, 1080i/60
- The anti-moire filter function is only effective when the MVE-8000/8000A is used in an HD system.

Key Density Adjustment

You can adjust the key density for the key signal input to the DME.

Key Source Selection

You can select either the key signals received from the switcher or the key signals generated in the DME for application to the front and back of the image (*see page 150*).

Global Effects

Global effects are special effects created by combining the images of successive channels. The Global Effect menu is used to add these effects.

For details of this menu, see “Global Effect Operations” in Chapter 11 (Volume 2).

The following types of global effects are available.

Combiner

When multiple channels are selected on one keyer or for one transition, the Combiner automatically combines the selected images. Up to four channels can be combined.

You can also control the way in which the combination is carried out, as a mix or an overlap with priority set automatically. For a mix, you can control the relative amounts of each channel.

Images can also be crossed in three dimensions.

Note

Three-dimensional image crossing is not supported on the MVE-8000/8000A.

Combination of channel 1 (Ch1) and channel 2 (Ch2)

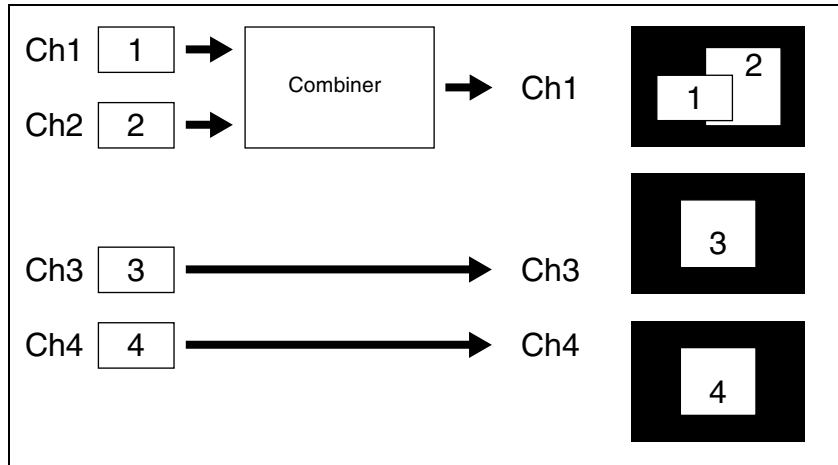

Combination of Ch1, Ch2, and Ch3

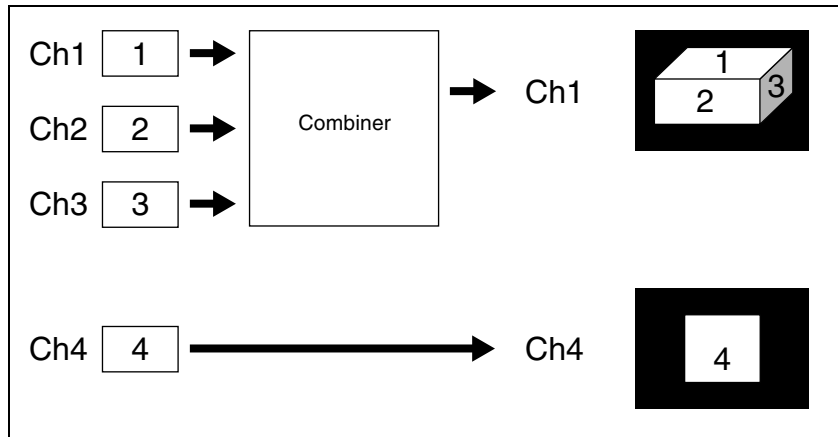



Combination of Ch1 and Ch2 / combination of Ch3 and Ch4

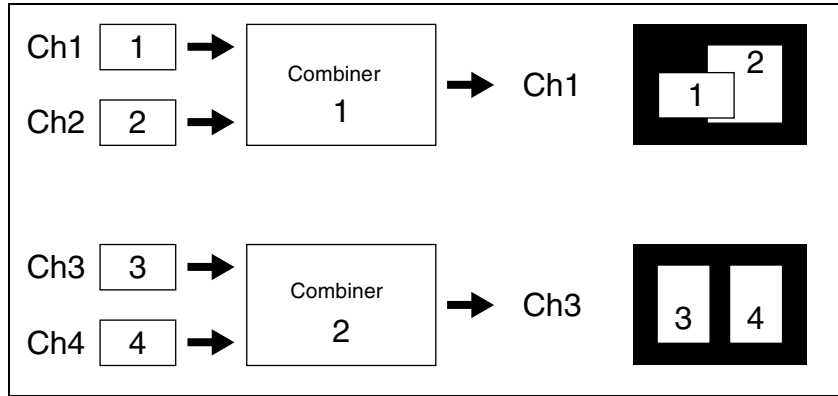

Combination of Ch1, Ch2, Ch3, and Ch4

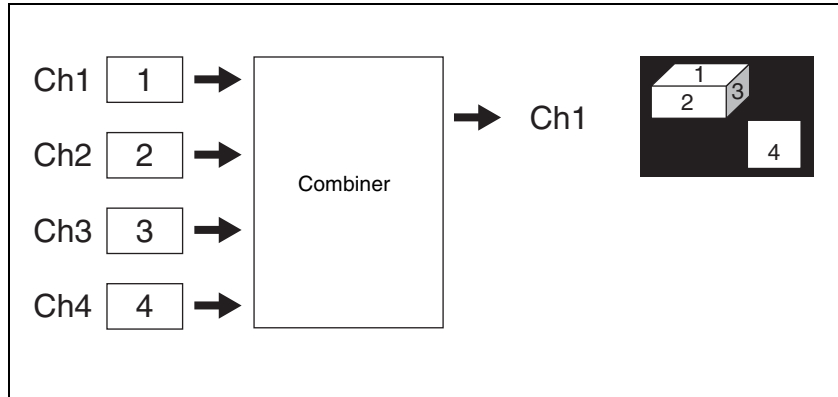

Mixing Ch1 and Ch2

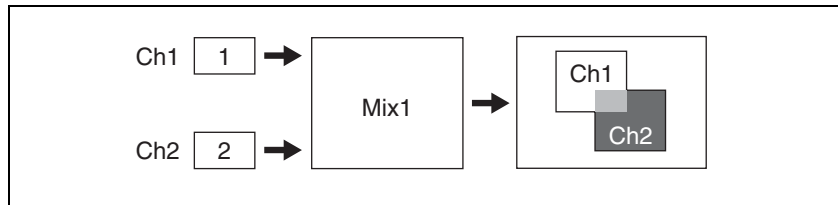

If the Mix1 setting is 70, the proportion of the channels in the mixed portion in the previous illustration is as shown in the following table.

Combination	Indication in figure	Ch1	Ch2
Ch1 and Ch2		30%	70%

Mixing Ch1, Ch2, and Ch3

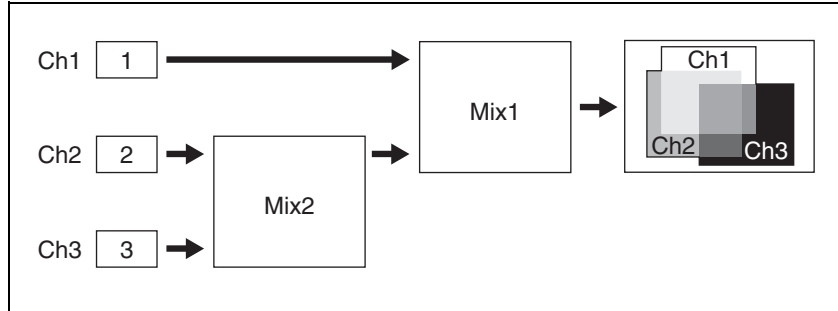



If the Mix1 setting is 70 and the Mix2 setting is 40, the proportions of the channels in the mixed portions in the previous illustration are as shown in the following table.

Combination	Indication in figure	Ch1	Ch2	Ch3
Ch1 and Ch2		30%	70%	–
Ch2 and Ch3		–	60%	40%
Ch1 and Ch3		30%	–	70%
Ch1, Ch2, and Ch3		30%	42%	28%

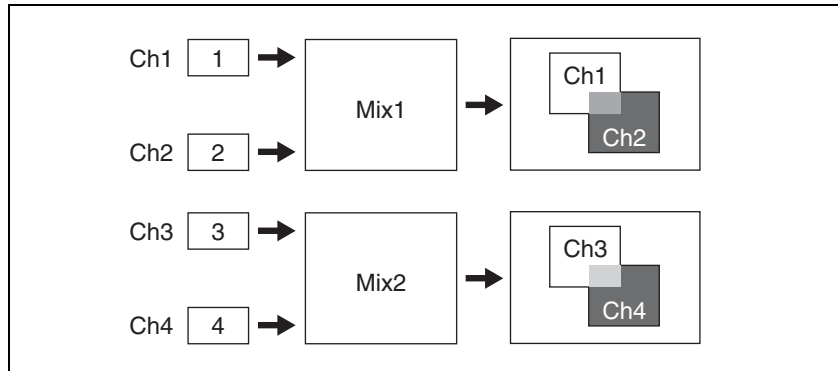
Pairwise mixing of Ch1 and Ch2, and Ch3 and Ch4



If the Mix1 setting is 70 and the Mix2 setting is 40, the proportions of the channels in the mixed portions in the previous illustration are as shown in the following table.

Combination	Indication in figure	Ch1	Ch2	Ch3	Ch4
Ch1 and Ch2		30%	70%	–	–
Ch3 and Ch4		–	–	60%	40%

Ch1 crossed with Ch2

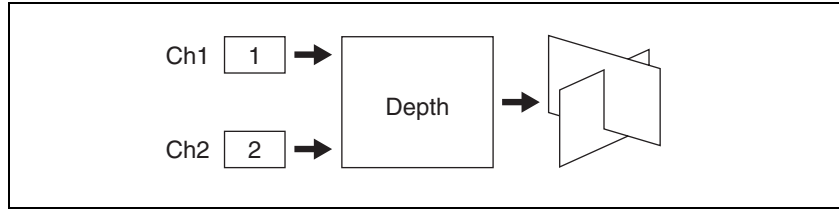

Brick

This effect creates a rectangular parallelepiped from 3 successive channels. The Brick effect can combine Ch1, Ch2, and Ch3, or combine Ch2, Ch3, and Ch4. The three images are displayed as shown in the following figure.

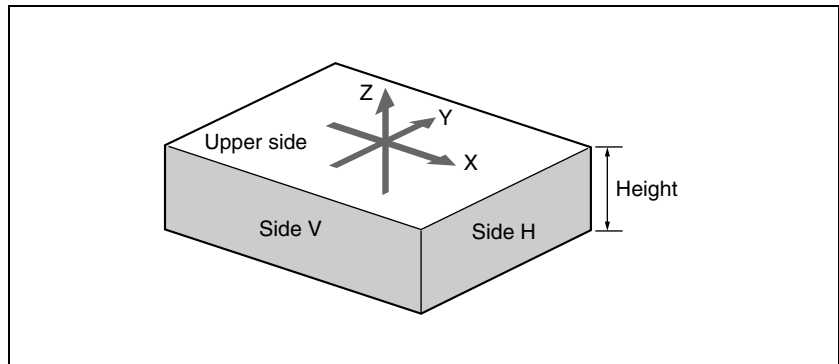

An example of the Brick effect

Combinations of Ch1, Ch2, and Ch3

Upper side: Ch1 image

Side V: Ch2 image

Side H: Ch3 image

Combinations of Ch2, Ch3, and Ch4

Upper side: Ch2 image

Side V: Ch3 image

Side H: Ch4 image

You can adjust the height of the brick, the overlap between the three images and the way to insert the side images.

Shadow

This effect gives the image a shadow. The effect uses two successive channels. You can adjust the position and density of the shadow with respect to the image, and the color of the shadow. The channel with the largest number (for example, Ch2 in the case of Ch1 and Ch2) becomes the shadow.

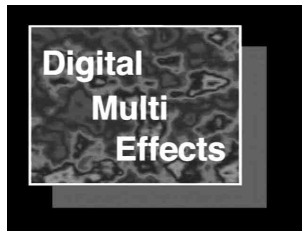

External Devices

In this system, you can operate while controlling the following types of external device:

- Devices supporting P-Bus (Peripheral II protocol) (referred to as “P-Bus devices” in the manual)
- Devices supporting GPI
- VTRs
- Disk recorder (Sony disk 9-pin protocol and video disk communications protocol)
- Extended VTR (Abekas A53 protocol)

The following is an outline of external device control.

For external device control operations, see Chapter 12 “External Devices” (Volume 2).

For details on the devices that can be connected, consult your Sony representative.

Shared Functions for External Device Control

Keyframe functions

There are 99 registers, numbered 1 to 99, holding external device control data as keyframe data.

The following are the keyframe functions that can be used.

- RECALL (1-99), STORE (1-99), RECALL UNDO, STORE UNDO, empty register search, AUTO SAVE, RECALL MODE (RECALL, RECALL & REWIND)
- EDIT ENABLE, EDIT UNDO
- CONST DUR, EFF DUR, KF DUR, DELAY, PAUSE, INSERT BEFORE, INSERT AFTER, MODIFY, DELETE, COPY, PASTE BEFORE, PASTE AFTER, FROM TO, ALL
- PREV KF, NEXT KF, GOTO TC, GOTO KF, RUN, REWIND, FF, STOP NEXT KF, NORMAL, JOG, KF FADER

Note

Actions set in a keyframe are executed only when the keyframe effect is executed in the normal direction. Take care when executing simultaneously with a switcher or DME keyframe effect, since the actions are not executed in the reverse direction.

The following keyframe functions cannot be used.

- KF LOOP, EFFECT LOOP, REVERSE, NORMAL/REVERSE
- PATH

Saving to registers

Set the data for controlling external devices in the Device menu. You can save the set data in keyframe, snapshot, or shotbox registers. You can recall the register in which the data is saved, and carry out operations on it with the keyframe control block.

For details, see Chapter 12 “External Devices” (Volume 2).

Editing registers

You can carry out the following operations on the registers in which the data for controlling external devices is saved.

- Copy
- Move
- Swap
- Merge (this cannot be carried out for registers holding VTR, disk recorder, or Extended VTR control data.)
- Lock
- Name

File related functions

As effect data, you can save and recall, using the File menu.

Control of P-Bus Devices

You can control P-Bus devices from this system through the 9-pin serial port of a DCU.

P-Bus device control modes

There are two modes of P-Bus device control, as follows.

P-Bus trigger mode: Operating a previously specified button outputs the command for an action assigned to that button.

P-Bus timeline mode: Carrying out a keyframe effect under the control of the center control panel controls external devices.

In the setup, select which of P-Bus trigger mode and P-Bus timeline mode to use.



P-Bus trigger mode actions

The actions that can be used in P-Bus trigger mode are as follows.

- Store
- Recall
- Trigger

For details of the buttons assigned to each action, see Chapter 12, “External Devices” (Volume 2).

P-Bus timeline

At a keyframe point on the P-Bus timeline, you can set an action (setting what action command is output to which device). At any single keyframe point you can set actions for a maximum of 24 devices.

P-Bus timeline mode actions

The actions that can be used in P-Bus timeline mode are as follows.

- Store
- Recall
- Trigger

For the action setting (or P-Bus timeline editing), use the Device menu.

You can save the data set in the Device menu in keyframe effect registers.

Recalling the register starts execution of the keyframe effect, and when this reaches the keyframe point at which actions are set, action commands are output to external devices through the 9-pin serial port assigned to P-Bus.

For details, see Chapter 12 “External Devices” (Volume 2).

Control of GPI Devices

You can control GPI devices from the control panel of this system, or through the GPI output port of a DCU.

GPI timeline

For a keyframe effect controlled from the center control panel, the GPI timeline allows you to set an action (setting a trigger output from a particular GPI output port) at a keyframe point on the GPI timeline. At any keyframe point, you can make a maximum of eight GPI output port settings.

GPI timeline actions

The actions that can be used on the GPI timeline are as follows.

- Control panel GPI output port
- DCU GPI output port

For the GPI output settings (keyframe editing), use the Device menu.

The data set in the Device menu are saved in a keyframe effect register. When you recall this register and start execution of the keyframe effect, and advance the effect to the keyframe point for which the GPI output is set, a trigger pulse is output to the external device from the specified GPI output port.

VTR/Disk Recorder/Extended VTR Control

In this system, for up to 12 VTRs, disk recorders or Extended VTRs connected to a DCU, you can carry out the following manual operations and timeline settings.

- Controlling manually from the device control block (trackball or search dial)
- Saving a start point, stop point, start delay time, variable speed and so on in a data register, then recalling the register to control automatically from the keyframe control block. (Cueup & Play and VTR/disk recorder/Extended VTR timeline)
- In the Device menu, you can check the following VTR, disk recorder and Extended VTR information:
 - Device name
 - Register number
 - VTR/disk recorder/Extended VTR status
 - Current time
 - Start point
 - Stop point
 - Variable speed
 - Start delay time
 - Loop setting
 - Recue setting

Manual operation

In the device control block, you can carry out the following operations manually.

- **VTR, disk recorder or Extended VTR selection**
- **Tape transport and disk drive control:** You can use the following tape transport and disk drive control buttons:
 REC, REW, PLAY, FF, CUE UP, VAR PLAY, SHTL, JOG, STANDBY OFF, STOP, and ALL STOP. (For details of the operation of the buttons, see “Device Control Block (Trackball)” (page 271), “Device Control Block (Joystick)” (page 277) and “Device Control Block (Search Dial)” (page 278).)

Depending on the settings made in the Setup menu, the CUE UP, PLAY and STOP operations can be carried out from the transition control block. (For details of the operation of the buttons, see “Transition Control Block



(Standard Type)” (page 260) and “Transition Control Block (Compact Type)” (page 310).

- **Setting a start point:** For each selected VTR/disk recorder/Extended VTR you can set the start point timecode value as keyframe data.
- **Setting a stop point:** For each selected VTR/disk recorder/Extended VTR you can set the stop point timecode value as keyframe data.
- **Setting a start delay time:** For each selected VTR/disk recorder/Extended VTR you can set the start delay as key frame data.
- **Recording to VTR or disk recorder:** Record video to the selected VTR/disk recorder.
- **Loop/recue¹⁾ setting:** You can select loop or recue as the playback mode. These operate as follows.
 - When loop is selected:** Playback repeats from the start to the end of the currently recalled file.
 - When recue is selected:** When playback reaches the stop point, automatically cue up to the start point.

1) EVS XT server (EVS Broadcast Equipment) dedicated function

Cueup & Play

By saving the start point timecode, stop point timecode, start delay time, and so on for a VTR, disk recorder or Extended VTR in an effect register, and recalling this register, you can operate the following buttons in the keyframe control block to automatically control the VTR, disk recorder or Extended VTR.

[REWIND] button: Cue up to the start point timecode

[RUN] button: Play

With this function you can also stop the VTR, disk recorder or Extended VTR used for playback at the stop point timecode recalled from the same register.

Disk recorder (video disk communications protocol) operation when loop /recue is set

When loop is set: playback repeatedly between the start point and stop point.

When recue is set: when playback reaches the stop point, automatically cue up to the start point.

VTR/disk recorder/Extended VTR timeline

For a keyframe effect controlled from the center control panel, the timeline allows you to set a VTR, disk recorder or Extended VTR action at a keyframe point on the timeline.

Timeline actions

The actions that can be used on the timeline are as follows.

- Start

- Stop
- Cue up
- Variable speed

Notes

- For a disk recorder, the maximum number of files for a single register is eight.
- The timeline does not support loop and recue.

For the action settings (VTR/disk recorder/Extended VTR timeline editing), use the Device menu.

The data set in the Device menu are saved in a keyframe effect register. When you recall this register and start execution of the keyframe effect, and advance the effect to the keyframe point for which the action is set, an action command is output to the external device through the 9-pin serial port assigned to the VTR, disk recorder or Extended VTR.

Recalling disk recorder/Extended VTR files

Material held on a disk recorder/Extended VTR is managed in units of files. You can recall a file to play it back. (In the case of an Extended VTR, the register number is recalled.)

Accessing the file list

Before playback and suchlike operations on a disk recorder/Extended VTR, it is first necessary to display a list of the disk recorder files on the DCU. The file list includes the following information.

- File name
- Date of last update ¹⁾
- Duration of recorded material ¹⁾

To recall the file list, use the Device menu.

1) Not displayed in the case of an Extended VTR

Recalling a file

In the recalled list of files, select the file you want to play back, and open the file.

File list sharing

You can connect multiple DCU serial ports to a single disk recorder/Extended VTR.

You can share the recalled list of files between serial ports connected to the same disk recorder/Extended VTR.

For settings relating to file list sharing, see “Serial Port Settings (Serial Port Assign Menu)” in Chapter 16 (Volume 2).

File creation

To record a new file on the disk recorder, use the Device menu to create a new file.

Note

In the case of an Extended VTR, it is not possible to record a new file.



Reference region

When multiple regions are selected, only one region appears in the displays for menu and numeric keypad operations. This is called the “reference region.” The reference region is determined according to the following precedence.

M/E1 >M/E2 >M/E3 >P/P >User1 > User2 > User3 >User4 >User5
 >User6 >User7 >User8 >DME ch1>DME ch2 >DME ch3 >DME ch4
 >DME ch5 >DME ch6 >DME ch7 >DME ch8 >Device1 >Device2
 >Device3 >Device4 >Device5 >Device6 >Device7 >Device8 >Device9
 >Device10 >Device11 >Device12 >P-Bus >GPI >Router >Macro

Master region

The regions saved in a master snapshot register or master timeline register and the register numbers saved in such regions can be recalled at a time as the master region.

The master region can be saved or recalled using the numeric keypad control block.

Registers

A register is an area of memory in a device which holds a snapshot, keyframe, macro, and so on.

For details of macros, see page 210.

Keyframe effect registers

Dedicated effect registers

There are 99 dedicated registers for keyframe effects in each region, numbered 1 to 99.

Shared user-programmable DME registers

In addition to the 99 DME registers for each region (i.e. each channel), there are also shared registers for each processor as shown in the following table. These are used for user-programmable DME.

Register number	Register allocation
101 to 199	Shared register for one-channel effects
201 to 299	Shared register for two-channel effects
301 to 399	Shared register for three-channel effects

Note

When operating with these shared registers, be sure to select the appropriate regions depending on the number of channels. When recalling registers in the

200 range, select two consecutive channels for the regions, as for example [DME1] and [DME2]. Similarly, for registers in the 300 range, select three consecutive registers.

Work register

This is a temporary register used when editing keyframes.

When you recall an effect, it is read from the effect register into the work register, and when you save, the contents of the work register are written to the effect register.

Master timeline registers

There are 99 master timeline registers, numbered 1 to 99, for each control panel. They store keyframe effect regions and the register numbers saved in the regions.

Snapshot registers

These are registers for snapshots, and there are 99, numbered 1 to 99 for each region.

Master snapshot registers

There are 99 master snapshot registers, numbered 1 to 99, for each control panel. They store snapshot regions and the register numbers saved in the regions.

Keyframes

A keyframe represents an instantaneous state of an image; it can be saved and recalled for reuse.

Effects

By arranging a number of keyframes on the time axis, and interpolating between successive keyframes, you can create an effect in which there is a continuous change from each keyframe to the next.

The following figure shows three keyframes created with a wipe pattern (the circle) in different positions. This is interpolated to create the effect shown.

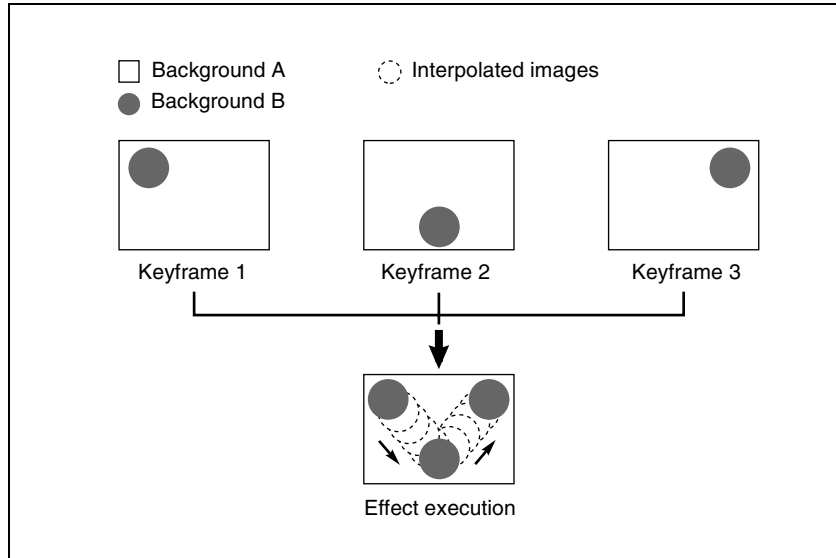

Example of keyframes and effect execution

You can save the sequence of keyframes representing a single effect in a register. Then by recalling this register, you can replay the same effect.

For details of keyframe effect registers, see “Regions and Registers” (page 165).

Saving and Recalling Effects

To create a new effect, first recall an empty register, then create the keyframes one at a time in this register. To run an effect, it is also necessary to set the time and the path.

To edit an existing effect, recall the register holding the effect, then make the changes.

When you have finished creating or editing the effect, save it in the recalled register or another specified register.

Auto save function

When you recall an effect, the currently recalled effect is automatically saved in a register. This is called the auto save function. You can disable this function in a Setup menu.

Effect Attributes

An individual effect may also have attached special conditions relating to switcher or DME operation when the effect is recalled.

These conditions are called “attributes” of the effect, and can be added when the keyframe effect is saved or recalled.

Type of attribute

The attribute that can be attached to an effect is as follows.

Effect dissolve: The transition from the state before the effect recall to the state at the effect start point is carried out smoothly, by a dissolve. The dissolve duration can be set in the Effect menu.

Temporary attributes

When a keyframe is recalled, independently of the attributes held in the register, you can also enable or disable temporary attributes. These temporary attributes are set when the keyframe effect is recalled.

Effect Editing

For editing operations such as to insert, delete, or modify a keyframe, it is necessary to stop the effect at the corresponding point on the time axis. This is termed an “edit point.”

You can edit either on a keyframe within the effect, or at any point between keyframes.

Insert: Insert the current image as a keyframe. Inserting a keyframe in an existing effect may change the duration of the effect (*see page 172*).

Modify: Modify a keyframe. You can modify a single keyframe or a range of keyframes in the effect together.

Delete: Delete a keyframe. You can delete a single keyframe or a range of keyframes in the effect together. Deleting keyframes from an effect reduces the duration of the effect (*see page 173*).

After deleting a keyframe, you can reinsert the keyframe with a paste operation.

Copy: Copy a keyframe. You can copy a single keyframe or a range of keyframes in the effect together.

Paste: Paste the keyframe last copied or deleted anywhere within the effect.

Pause: You can set a pause on a particular keyframe, so that when the effect is run it pauses on this keyframe. You can make this setting on any number of keyframes. To restart the paused effect, repeat the operation to run the effect.

KF Loop: Execute the effect the specified number of times through the keyframes in the specified range.

Undo an edit operation: Undo the effect of the last operation to insert, modify, delete, or paste a keyframe.

Duration modes

In keyframe editing, there are two duration modes; switch between them in the keyframe operation section. (*See “Time Settings” in Chapter 13 (Volume 2).*)

Variable duration mode: In this mode, inserting or deleting a keyframe increases or reduces the duration.

Constant duration mode: In this mode, inserting or deleting a keyframe does not change the duration. This is useful for keyframe editing of an effect with a fixed duration.

In the variable and constant duration modes, the keyframes to which a modify operation applies, and the effect of a paste operation are different.

Difference in keyframes to which a modify operation applies

Effect position	Variable duration mode	Constant duration mode
On a keyframe	Applies to currently selected keyframe	Applies to currently selected keyframe
Between two keyframes	Applies to previous keyframe	Modify operation not possible ^{a)}

a) A new keyframe is inserted at the effect position.

Difference in the effect of a paste operation

Variable duration mode: The copied keyframe is inserted at the specified position.

Constant duration mode: The copied keyframe is written over the specified position.

Transition mode

You can use an effect created with keyframes as a DME wipe pattern on the switcher. In this case, it is necessary to set the transition mode (the way in which the effect behaves).

For details of the setting, see “User Programmable DME Transition Mode” (page 483).

Time Settings

Keyframe duration and effect duration

You can determine the execution time of an effect by setting either the keyframe durations or the effect duration.

Keyframe duration: This is the time from the keyframe to the next keyframe. You can set this time in the keyframe control block. (See “Time Settings” in Chapter 13 (Volume 2).)

In constant duration mode (see page 170), it is not possible to change the keyframe duration setting.

Effect duration: This is the total execution time of the effect, from the first keyframe to the last. You can set this time in the keyframe control block. (See “Time Settings” in Chapter 13 (Volume 2).)

When you change the effect duration, the keyframe duration for each keyframe in the effect is automatically recalculated proportionally.

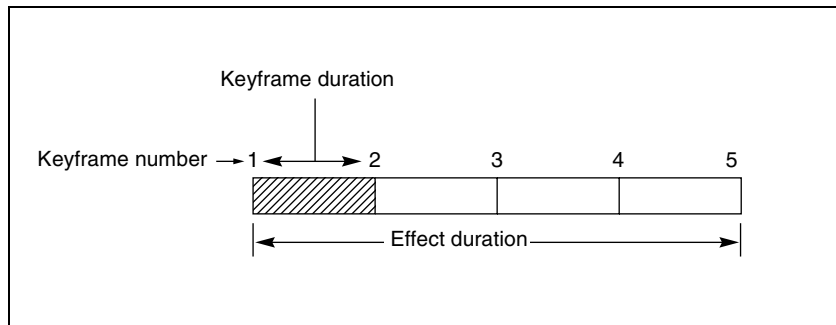

Schematic view of keyframe duration and effect duration

The effect duration may also be changed by inserting or deleting keyframes.

Changes in the effect duration caused by inserting a keyframe

- When the effect is stopped on a keyframe, inserting a keyframe increases the effect duration by the duration of the inserted keyframe.
- When the effect is stopped between two keyframes, inserting a keyframe does not change the effect duration.

Note

In constant duration mode (*see page 170*), the duration of the current keyframe is reduced to zero, and the new keyframe is inserted with the previous duration of the current keyframe. Thus the effect duration does not change.

Insertion position	Change in effect duration
Insertion before the first keyframe	
Insertion between two keyframes	
Insertion at an existing keyframe	
Insertion at the last keyframe	

Keyframe insertion position and the change in effect duration



Changes in the effect duration caused by deleting a keyframe

- When the effect is stopped on a keyframe, a delete operation deletes the keyframe, and reduces the effect duration by the duration of the deleted keyframe.
- When the effect is stopped between two keyframes, a delete operation deletes the preceding keyframe, and reduces the effect duration by the duration of the deleted keyframe.

Note

In constant duration mode (*see page 170*), the duration of the keyframe before the deleted keyframe is increased by the duration of the deleted keyframe. Thus the effect duration does not change.

Deletion position	Change in effect duration
Deletion of the first keyframe	
Deletion of an intermediate keyframe	
Deletion between two keyframes	
Deletion of the last keyframe	

Keyframe deletion position and the change in effect duration

Delay setting

You can set the delay from the time of executing an operation to run the effect, and the effect actually starting (that is, the delay until the first keyframe). You can make this setting in the keyframe control block. (See “Time Settings” in Chapter 13 (Volume 2).)

Note that changing the delay does not alter the duration of the effect.

Paths

The term “path” refers to the specification of how interpolation is carried out from one keyframe to the next.

For details of the path setting procedure, see “Path Settings” in Chapter 13 (Volume 2).

Switcher path settings

Carry out path settings in the Key Frame menu.

For each menu, the following settings are available.

M/E-1 to M/E-3, and P/P menus

Item	Paths that can be set	
M/E1 to M/E3, P/P All	For each M/E and PGM/PST, path settings for the following items are made simultaneously.	
Key1 to Key4	Overall path settings for items relating to keys 1 to 4 are made simultaneously.	
Key 1 All to Key 4 All		
Source		Key source path for keys 1 to 4
Fill		Key fill path for keys 1 to 4
Proc		Proc path for keys 1 to 4
Trans	Transition path for keys 1 to 4	
Bkgd/Util	Overall path settings for items relating to backgrounds and utility buses are made simultaneously.	
Bkgd/Util All		
Bkgd A		Path for background A
Bkgd B		Path for background B
Util 1		Path for utility 1
Util 2		Path for utility 2
DME 2nd Video	Path for video to be used for second DME channel	

Item		Paths that can be set
Wipe/DME Wipe		Overall path settings for items relating to wipes and DME wipes are made simultaneously.
Wipe	Wipe/DME Wipe All	
	Wipe	
	DME Wipe	Path for DME wipes
Trans	–	Transition path for each M/E and P/P bank

User1 to User8 menus

The items that can be adjusted depend on the settings in the Setup menu.

For details, see “Overall Control Panel Settings (Config Menu)” in Chapter 16 (Volume 2).

Item		Paths that can be set
User1 All to User8 All		Overall path settings for the following items for each “User” are made simultaneously.
FM All		Overall path settings for frame memory items are made simultaneously.
FM Src		Overall path settings for frame memory source items are made simultaneously.
	FM Src All	
	FM Src1	
	FM Src2	Path for frame memory source 2 and video process
FM Proc		Overall path settings relating to the signal processing other than frame memory source and frame memory freeze outputs are made simultaneously.
	FM Proc All	
	FM Proc1	
	FM Proc2	Path for frame memory signal processing 2
FM Still Store		Overall path settings for frame memory freeze image output are made simultaneously.
	FM Still Store All	
	FM Still Store 1 to 8	Paths for frame memory freeze image outputs 1 to 8
Aux		Overall path settings for AUX buses are made simultaneously.
	Aux All	
	Aux 1 to 48	Paths for Aux 1 to 48
Mon		Overall path settings for monitor buses are made simultaneously.
	Mon All	
	Mon 1 to 8	Paths for monitor buses 1 to 8

Item		Paths that can be set	
Color Bkgd		Overall path settings for color backgrounds are made simultaneously.	
	Color Bkgd All		
	Color Bkgd 1		Paths for color background 1
	Color Bkgd 2		Paths for color background 2
CCR		Overall path settings for color corrector	
	CCR All		
	CCR 1		Path for color corrector 1
	CCR 2		Path for color corrector 2

Paths relating to DME

DME 3D Trans Local menu

Item		Paths that can be set	
3D Trans Local All		Overall path settings for local channel three-dimensional transform items are made simultaneously.	
Loc Size		Overall path settings for items relating to image size changes and movement are made simultaneously.	
	Loc Size All		
	Size		Path for image size
	Post Loc X, Post Loc Y		Paths for movement in the x- and y-axes
	Post Size	Path for size	
Loc XYZ		Overall path settings for items relating to image movement are made simultaneously.	
	Loc XYZ All		
	Loc X, Loc Y, Loc Z		Paths for the x-, y- and z-axes
Rot		Overall path settings for items relating to image rotation are made simultaneously.	
	Rot All		
	Rot X, Rot Y, Rot Z		Paths for the x-, y- and z-axes
Spin		Overall path settings for items relating to spin are made simultaneously.	
	Spin All		
	Spin Src X, Spin Src Y, Spin Src Z		Paths for the x-, y- and z-axes
	Spin X, Spin Y, Spin Z		Paths for the x-, y- and z-axes
Asp		Overall path settings for items relating to aspect ratio are made simultaneously.	
	Asp All		
	Rate X, Rate Y		Paths for the x- and y-axes

Item	Paths that can be set	
Skew	Overall path settings for items relating to skew are made simultaneously.	
	Skew All	
	Skew X, Skew Y	Paths for the x- and y-axes
	Aspect	Path for aspect ratio
Pers	Overall path settings for items relating to perspective are made simultaneously.	
	Pers All	
	Pers X, Pers Y, Pers Z	Paths for the x-, y- and z-axes
Axis Loc	Overall path settings for items relating to image rotation axis are made simultaneously.	
	Axis All	
	Axis X, Axis Y, Axis Z	Paths for the x-, y- and z-axes

DME 3D Trans Global menu

Item	Paths that can be set	
3D Trans Global All	Overall path settings for three-dimensional transform items in the global channel are made simultaneously.	
Loc Size	Overall path settings for items relating to image size changes and movement are made simultaneously.	
	Loc Size All	
	Size	Path for image size
	Post Loc X, Post Loc Y	Paths for movement in the x- and y-axes
	Post Size	Path for size
Loc XYZ	Overall path settings for items relating to image movement are made simultaneously.	
	Loc XYZ All	
	Loc X, Loc Y, Loc Z	Paths for the x-, y- and z-axes
Rot	Overall path settings for items relating to image rotation are made simultaneously.	
	Rot All	
	Rot X, Rot Y, Rot Z	Paths for the x-, y- and z-axes
Spin	Overall path settings for items relating to spin are made simultaneously.	
	Spin All	
	Spin Src X, Spin Src Y, Spin Src Z	Paths for the x-, y- and z-axes
	Spin X, Spin Y, Spin Z	Paths for the x-, y- and z-axes
Pers	Overall path settings for items relating to perspective are made simultaneously.	
	Pers All	
	Pers X, Pers Y, Pers Z	Paths for the x-, y- and z-axes



Item		Paths that can be set
Axis Loc		Overall path settings for items relating to image rotation axis are made simultaneously.
	Axis All	
	Axis X, Axis Y, Axis Z	Paths for the x-, y- and z-axes

DME Effect menu

Item		Paths that can be set
Effect All		Overall path settings for DME effect items are made simultaneously.
Edge		Overall path settings for edge items are made simultaneously.
	Edge All	
	Border	Path for border
	Crop/Edge Soft	Path for crop/edge softness
	Beveled Edge	Path for beveled edge
	Key Border	Path for key border ^{a)}
	Art Edge	Path for art edge ^{a)}
	Flex Shadow	Path for flex shadow ^{a)}
	Wipe Crop	Path for wipe crop ^{a)}
	Color Mix	Path for color mix ^{a)}
Video Modify		Overall path settings for video modify items are made simultaneously.
	Video Modify All	
	Defocus/Blur	Path for defocus/blur
	Multi Move	Path for “multi-move”
	Color Modify	Path for color modify
	Mosaic	Path for mosaic
	Mask	Path for mask ^{b)}
	Sketch	Path for sketch ^{b)}
	Metal	Path for metal ^{b)}
	Dim/Fade	Path for dim/fade ^{a)}
	Glow	Path for glow ^{b)}
Freeze		Path for freeze
Non-Linear		Path for nonlinear effects

Item	Paths that can be set
Light	Overall path settings for lighting items are made simultaneously.
Light All	
Lighting	Path for lighting
Spot Lighting	Path for spotlighting ^{a)}
Trail	Path for trails
In/Out	Overall path settings for items relating to input/output are made simultaneously.
In/Out All	
Bkgd	Path for background
Video/Key	Path for video/key

a) This cannot be used on the MVE-8000/8000A.

b) This cannot be used on the MVE-8000.

DME Global Effect menu

Item	Paths that can be set
Global Effect All	Overall path settings for DME global effect items are made simultaneously.
Combine	Path for combiner
Shadow	Path for shadow
Brick	Path for brick

Types of path

Path types for Curve

There are five types, as follows.



OFF: Executing the effect causes no change.



Step: There is no interpolation between keyframes, so that the effect parameters are updated each time a keyframe is passed.



Linear: Linear interpolation between keyframes, resulting in constant speed movement.



S-Curve: The rate of change accelerates and decelerates before and after a keyframe, so that the rate of change is maximum midway between two keyframes.



Spline: The effect follows a smooth curved path from each keyframe to the next.

Path types for Hue

There are four types, as follows.



CW: The hue changes in a clockwise direction as seen on a Vectorscope.



CCW: The hue changes in a counterclockwise direction as seen on a Vectorscope.



Short: The hue changes in whichever of the clockwise and counterclockwise directions is shorter.



Long: The hue changes in whichever of the clockwise and counterclockwise directions is longer.

Path types for Xpt

There are two types, as follows.



Xpt Hold off: When replaying a keyframe, change the inputs to the settings saved in memory.



Xpt Hold on: When replaying a keyframe, do not change the inputs.

Effect Execution

By pressing the [RUN] button in the keyframe control block, you can replay the effect as a continuous sequence of images. This is referred to as effect execution.

It is also possible to execute effects from the device control block (*see page 271*), the Flexi Pad control block (*see page 264*) or the transition control block (*see page 260*).

Range of execution

Each time the [RUN] button is pressed, the range of execution of the effect is from timecode 01:00:00:00 or the current time (the position at which the current effect is stopped) to the end point of the effect. However, if there is a pause set on a keyframe, the execution range is up to that point. Pressing the [RUN] button again resumes the effect, which then runs to the next pause point or the end of the effect.

Run mode setting

You can select from the following run modes for when the effect is executed.

DIRECTION: Specify the effect execution direction.

STOP NEXT KF: Run the effect, and stop at the next keyframe.

EFFECT LOOP: Repeat the effect in an endless loop.

Make these settings in the keyframe control block. (*See “Run Mode Setting” in Chapter 13 (Volume 2).*)

Master Timelines

You can save the regions selected for a keyframe effect and the register numbers saved in the regions in a master timeline register so that operation can be applied to two or more regions at a time.

To save master timeline registers, use the numeric keypad control block or menu; to recall them you can use the numeric keypad control block, menu, or the Flexi Pad control block.

For more details, see “Creating and Saving a Master Timeline” in Chapter 13 (Volume 2).



Snapshots

The term “snapshot” refers to a function whereby the various settings required to apply a particular effect to an image are saved in memory as a set of data, for recall as required, to recover the original state.

You can carry out snapshot operations using the numeric keypad control block, the Flexi Pad control block in each of the M/E-1 to M/E-3 and PGM/PST banks, and the Snapshot menu.

Note

If the M/E bank has the Inhibit setting (*see “Overall Control Panel Settings (Config Menu)” in Chapter 16 (Volume 2)*), it is not possible to recall a snapshot on that M/E bank.

For details of snapshot operations, see Chapter 14 “Snapshots” (Volume 2).

Snapshot Types

Snapshots are divided as follows.

Snapshots applying to a particular region (functional block of the switcher or DME)

The term “snapshot” alone usually refers to this type of snapshot. This only applies to regions assigned to region selection buttons in the numeric keypad control block.

Master snapshot: This applies to the selected regions and the register numbers saved in the regions. A master snapshot can be saved and recalled using the numeric keypad control block.

Snapshots applying only to particular functions

This type of snapshot includes the following.

Key snapshot: This includes the key on/off state and all key settings other than key priority for each keyer. (*See “Key Snapshots” (page 57).*)

Wipe snapshot: This includes the wipe settings of each of the M/E-1 to M/E-3 and PGM/PST banks. (*See “Wipe Snapshots” (page 71).*)

DME wipe snapshot: This includes the DME wipe settings of each of the M/E-1 to M/E-3 and PGM/PST banks.

The rest of this section describes the snapshots that apply to a particular region or regions.



Snapshot Attributes

An individual snapshot may also have attached special conditions relating to switcher or DME operation when the snapshot is recalled. These conditions are called “attributes” of the snapshot, and can be added when the snapshot is saved or recalled.

Types of attribute

There are five snapshot attributes, as follows.

Cross-point hold: When the snapshot is recalled, the cross-point button selection remains unchanged. This can be set independently for each bus.

Key disable: When the snapshot is recalled, the key settings remain unchanged. This can be set independently for each keyer. A Setup menu allows you to select whether or not the key on/off state should also remain unchanged.

For details of the setting operation, see “Settings Relating to Keys, Wipes and Frame Memory (Key/Wipe/FM/CCR Menu)” in the Chapter 16 (Volume 2).

Effect dissolve: The transition from the state before the snapshot recall to the snapshot settings is carried out smoothly, by a dissolve. The dissolve duration can be set in the Snapshot menu.

Auto transition: An auto transition starts the instant the snapshot is recalled. The auto transition setting is valid only for M/E-1, M/E-2, M/E-3, and PGM/PST.

Note

If both effect dissolve and auto transition are selected as attributes, the auto transition takes precedence.

GPI output: A GPI output is sent to the allocated GPI port the instant the snapshot is recalled.

The trigger type depends on the switcher GPI output settings made in the Setup menu.

For details, see “Interfacing With External Devices (Device Interface Menu)” under “Setup Relating to Switcher Processor” in Chapter 16 (Volume 2).

Clip event: Recall a frame memory clip immediately after the snapshot is recalled.

Note

Clip events are not supported on the MVS-8000.

Auto play: Play a frame memory clip immediately after the snapshot is recalled.

Table of available attributes

The attributes that can be used depend on the region, as follows.

Yes: Can be used No: Cannot be used

Attribute	Region		
	M/E-1, M/E-2, M/E-3, and PGM/PST	User 1 to User 8	DME ch 1 to DME ch 8
Cross-point hold	Yes	Yes	Yes
Key disable	Yes	No	No
Effect dissolve	Yes	Yes	Yes
Auto transition	Yes	No	No
GPI outputs	Yes	Yes	No
Clip event	No	Yes	No
Auto play	No	Yes	No

Attribute display

You can view the attributes of a snapshot in the Snapshot menu.

For more details, see “Snapshot Operations in the Menus” in Chapter 14 (Volume 2).

Temporary attributes

When recalling a snapshot, you can temporarily apply attributes distinct from the attributes set for each register. These are called “temporary attributes.” You can set temporary attributes when recalling a snapshot.

For details of snapshot operations, see Chapter 14 “Snapshots” (Volume 2).

Bus override

If you recall a snapshot while holding down an A or B bus button, the selection of the signal on the A or B bus does not change when the snapshot is recalled. This function is called “bus override.”

This function is effective when cross-point hold is off, and you want to temporarily maintain the cross-point setting. When cross-point hold is on, the above operation is not necessary.

Utility

The utility function refers to a function whereby you can assign an arbitrary action or a shortcut for frequently used menu to a particular button, then instantly recall the action or menu by pressing the button.

The functions you can assign include menu shortcuts, enabling/disabling functions (recalling utility commands), and recalling (shotbox registers or macro registers).

Carry out the button assignment in the Setup menu.

For details of the operation, see “Setting Button Assignments (Prefs/Utility Menu)” in Chapter 16 (Volume 2).

You can carry out the utility function in the utility/shotbox control block (*see page 298*), in the cross-point control block (*see page 256*), or using the user preference buttons in the menu control block (*see page 294*).



Shotbox

The term “shotbox” refers to a function whereby for each specified region any snapshot or keyframe effect can be recalled simultaneously.

The simultaneous recall setting data such as region names, snapshot numbers and keyframe effect numbers are stored in “registers.” There are 99 registers for each control panel.

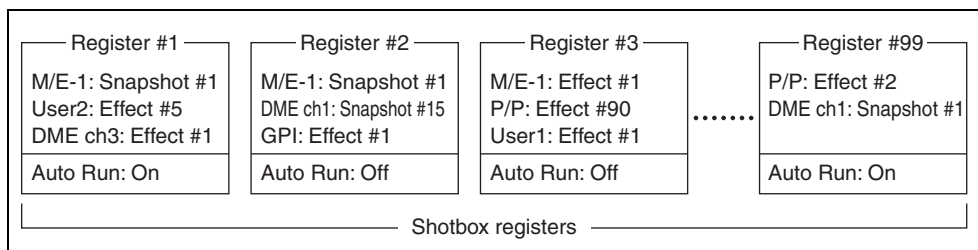

The previous figure shows schematically the settings in the 99 shotbox registers.

Each register may contain any combination of the regions to which the register applies, with the snapshots or effects to be recalled.

The Auto Run function is an attribute which can be set for each register. When this is set to On, an effect recalled by a shotbox operation is automatically run.

- When register 1 is executed, this recalls M/E-1 snapshot 1, User2 effect 5, and DME ch3 effect 1. For register 1, auto run is On, and therefore the User2 and DME ch3 effects are run as soon as they have been recalled.
- When register 3 is executed, M/E-1 effect 1, P/P effect 90, and User1 effect 1 are recalled. For register 3, auto run is off, and therefore to run the recalled effects, press the [RUN] button in the keyframe control block.

Shotbox settings and execution

Carry out shotbox register settings from the Shotbox menu or using the numeric keypad control block.

You can carry out shotbox execution using the numeric keypad control block, the Flexi Pad control block, the utility/shotbox control block, or the cross-point control block buttons.

For details of operation, see Chapter 15 “Shotbox” (Volume 2).

Setup

Overview of Setup

Various settings are required, in order to operate the switcher, control panel, DME, external devices, and so on, connected together in a single system. This is referred to as “setup,” and you can carry out the setup operations from the Engineering Setup menu.

For details of the operations, see Chapter 16 “Engineering Setup” (Volume 2).

The settings in the Engineering Setup menu are grouped under the following headings.

- **System setup (System):** Settings relating to the whole system (*see the following section “System Setup.”*)
- **Panel setup (Panel):** Settings particular to the control panel (*see page 195*)
- **Switcher setup (Switcher):** Settings particular to the switcher processor (*see page 198*)
- **DME setup (DME):** Settings particular to the DME processor (*see page 202*)
- **DCU setup (DCU):** DCU input and output settings (*see page 202*)
- **Router/tally setup (Router/Tally):** Router interface and tally settings (*see page 203*)

System Setup

The system setup settings apply to the whole system. Here the “whole system” refers to all devices connected on the Control LAN.

The DCU is connected through the control panel, but is also included in the “whole system.”

You can make the following settings.

Network configuration (Network Config)

This provides automatic configuration of all devices connected to the Data LAN (excluding the DCU), and displays a list of them.

System configuration (System Config)

Specify the overall system operation mode and the hierarchical relationship of the devices.

**Operation mode setting**

- **Single Proc mode:** The control panel controls a single switcher and up to two DMEs.
- **Single Simul mode:** See “Special system setting (Single Processor Simul mode)” (page 188).
- **Dual Simul mode:** The control panel controls two switchers and DMEs simultaneously.

Device hierarchical relationship setting

- **Panel Assign:** Specify the switcher controlled by a control panel.
- **Switcher Assign:** Specify the DME connected to a switcher.

Special system setting (Single Processor Simul mode)

When using a combination of a 4M/E switcher processor and a 4-channel DME processor in an HD system, the Single Processor Simul mode is available. In this mode, M/E-1 on the switcher processor is linked to M/E-3, and M/E-2 is linked to P/P. As a result, the M/E-1 and M/E-2 panel buttons go off, and cannot be operated.

In this mode, the screen aspect ratio is fixed, as follows.

Processor	Bank or channel	Screen aspect ratio
Switcher processor	M/E-3 and P/P	16:9
	M/E-1 and M/E-2	4:3
DME processor	Channels 1 and 2	16:9
	Channels 3 and 4	4:3

Relation between switcher and DME: Operations are linked with the screen aspect ratios the same.

Notes

- The waveforms for wipe pattern numbers 23, 24, 26, and 27 are the same in 4:3 and 16:9 modes.
- Color backgrounds, frame memory, and other functions used on the whole switcher operate at 16:9.

Note on creating a user programmable DME: The keyframe registers used for creating a user programmable DME are divided by screen aspect ratio as shown in the following table.

Register numbers	Screen aspect ratio	Switcher bank		Channel	
		M/E-3	P/P	Ch1	Ch2
101 to 149, 201 to 249, 301 to 349	16:9				

Register numbers	Screen aspect ratio	Switcher bank		Channel	
		M/E-1	M/E-2	Ch3	Ch4
151 to 199, 251 to 299, 351 to 399	4:3				

The actual operation is linked between the top and bottom rows of the table (e.g. M/E-3 and M/E-1), but the common setting values cannot be used between the two screen aspect ratios. The edges of the screen, for example, differ between 16:9 and 4:3.

For image operations in the device control block, first make the settings separately on the different channels.

Recalling a user programmable DME: When recalling a user programmable DME, select pattern numbers 1901 to 1949, 2901 to 2949, or 3901 to 3949. The effects for the 16:9 and 4:3 screen aspect ratios will be recalled linked together.

Signal format settings (Format)

Make the following settings.

Signal format

Specify the signal format to be handled by the devices.

The combinations of signal formats that can be selected are as follows.

System	Field frequency	Effective number of scan lines
HD system	50	1080i
	59.94	
	60	
	23.976	1080PsF
	24	
	25	
	29.97	
	30	
	50	720P
	59.94	
SD system	59.94	480i
	50	576i

Software options for multi-format

To use the MVS-8000G with multi-format support requires the following software options.

Product name	Model No.	Switcher
Switcher Upgrade Software	BZS-8500M	MVS-8000G
	BZS-8510M	MVS-8000GSF

The following software options are also required depending on the number of M/E banks.

Product name	Model No.	Switcher
Mix/Effect Upgrade Software	BZS-8520M	MVS-8000GSF 2M/E system or MVS-8000G 3M/E system
	BZS-8520M and BZS-8530M	MVS-8000G 4M/E system

To use the software, you are required to input an install key.

For the method of inputting an install key, see “Installation and Device Setup (Install/Unit Config Menu)” in Chapter 16 (Volume 2).

Format converter (for MVS-8000G only)

Installing the MKS-8450G Format Converter Board in the switcher enables the following signal video format conversions.

- Up-conversion: from SD (4:3) to HD (16:9)
- Down-conversion: from HD (16:9) to SD (4:3)
- Cross-conversion: from HD (720P) to HD (1080i), or from HD (1080i) to HD (720P)

The maximum number of input signals for which format conversion is possible is 16 (or 8 when only one MKS-8450G board is installed), and the maximum number of output signals is 4 (2 for output on the MVS-8000GSF).

Notes

- After format conversion, input and output signals have one-frame delays with respect to the reference signals.
- It is not possible to apply the safe title function to output signals subjected to format conversion.
- When the input reference signal for HD system is set to Tri Sync, the format converter function is not available.

For details, see “Setting the Signal Format (Format Menu)” in Chapter 16 (Volume 2).

Format combinations allowing conversion

The supported combinations of switcher signal format and format converter (inputs 1 to 8 and inputs 9 to 16) are as follows.



Switcher signal format setting	Format converter signal format setting		
	FC Input 1-8	FC Input 9-16	FC Output 1-4
480i/59.94	720P/59.94 1080i/59.94 1080PsF/29.97	720P/59.94 1080i/59.94 1080PsF/29.97	Format selected for FC Input 1-8
576i/50	720P/50 1080i/50 1080PsF/25	720P/50 1080i/50 1080PsF/25	
720P/50	576i/501080i/50	576i/501080i/50	
720P/59.94	480i/59.94 1080i/59.94	480i/59.94 1080i/59.94	
1080i/50	576i/50 720P/50	576i/50 720P/50	
1080i/59.94	480i/59.94 720P/59.94	480i/59.94 720P/59.94	
1080PsF/25	576i/50	576i/50	
1080PsF/29.97	480i/59.94	480i/59.94	

Screen aspect ratio

Switch the screen aspect ratio to 4:3 or 16:9.

Changing the input reference signal in an HD system

This changes the input reference signal.

- **Tri Sync:** tri-level sync for an HD system
- **BB (Black Burst):** black burst or sync for an SD system

The following table shows the relation between signal format and the frequency of a signal that can be used as the input reference signal.

Signal format	Input reference signal		
	Tri Sync	Black burst	
1080PsF/29.97, 1080i/59.94	59.94	Black Burst 59.94	Sync 59.94
1080PsF/25, 1080i/50	50	Black Burst 50	Sync 50
1080PsF/23.976	47.952	Black Burst 59.94 ^{a)}	Sync 59.94 ^{a)}
1080PsF/30, 1080i/60	60	–	
1080PsF/24	48	–	
720P/59.94	59.94	Black Burst 59.94	Sync 59.94
720P/50	–	Black Burst 50	Sync 50

a) Interlock mode

Selecting the start up state (Start Up)

Set the initial state of the devices when the system is powered on. For each device, you can select Resume mode or Custom mode.

Resume mode

This resumes the setting state at the previous power-off operation. This setting is only available for the switcher processor and panel.

Custom mode

This uses the settings saved in non-volatile memory or ROM within the device. In this mode, there are Setup and Initial Status settings which can be set separately.

- **Setup mode:** Select the setup state to be used after powering on from the following.
 - User:** Start up using the user data previously saved with [Setup Define].
 - Factory:** Start up with the factory default settings.
- **Initial status mode:** Select the state of each device after powering on (excluding the settings to which “setup” applies).
 - User:** Start up using the user data previously saved with [Initial Status Define]. For the control panel, this applies to the key bus delegation buttons only.
 - Factory:** Start up with the factory default settings.

For details of saving and recalling setup data, see “Saving and Recalling Setup Data” (page 194) and the appendix “Data Saved by [Setup Define] and [Initial Setup Define]” (Volume 2).

Autoload function

Switch on or off the function to automatically load predetermined register data or frame memory image data at power on. Set the data to be read in the File menu.

System reset and memory initialization (Initialize)

- **Reset:** Reset to state after powering on.
- **All Clear:** Clear the memory, and carry out initialization. The Network Config, System Config, Format, and Start Up setup values are set by reference to data stored in non-volatile memory, and the system automatically starts up. It is not necessary to reset the Date/Time settings.

For more details, see “Saving and Recalling Setup Data” (page 194).

Installation and device settings (Install/Unit Config)

This installs the software and firmware in all devices (including the DCU) connected to the Data LAN.

Install: Automatically detects the software that can be installed on each device, and installs the selected software.

There are also the following functions.

Detail Information: Gives details of the software and firmware installed in each device.

Unit Config: Carries out device settings. Switches the color corrector function of the switcher processor between secondary color correction and spot color adjustment, sets the field polarity of frame memory images, and so on.

License: Makes the license valid or invalid.

Device management (Maintenance)

- Date and time setting
- Formatting a memory card
- Primary settings for USB external storage device
- Reloading a USB driver
- Formatting the hard disk
- Locking setup menu operations
 - For each VF button group, selecting a set of candidate menus to be locked, then locking all of the candidates using a password. Except for list scrolling, moving menus, and similar operations, menu operations for all settings can be locked.
 - Changing the password

Saving and Recalling Setup Data

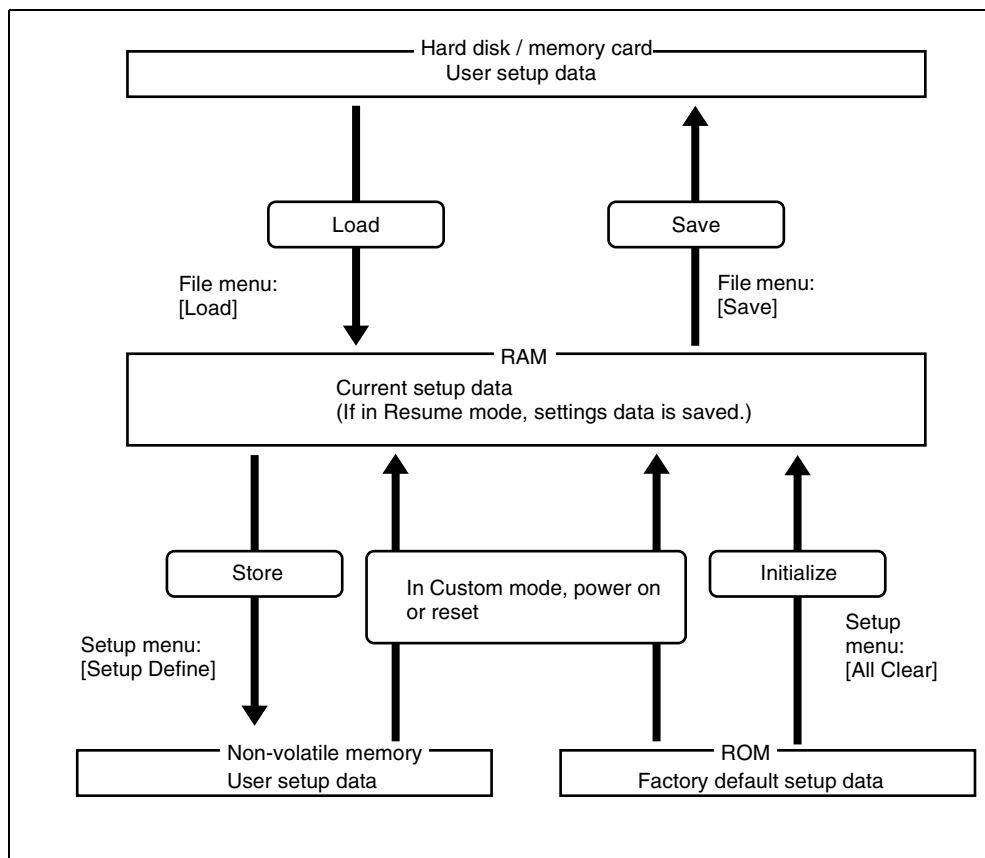

Concept of saving and recalling setup data

Updating the switcher or control panel setup data saves the updated setup data in RAM in each device.

- In Resume mode (*see page 192*), even if devices are reset or powered off, the data is preserved in RAM, and recalled when the power is turned back on.

Note

The Resume mode cannot be used for DMEs and DCUs.

- In Custom mode (*see page 192*), the user-defined settings (user setup data) saved in non-volatile memory or factory default setup data held in ROM in

each device is recalled when a reset is made or the power is turned back on. (See “Selecting the start up state (Start Up)” (page 192).) Note that the setup data in RAM can also be saved to the control panel hard disk or memory card.

Panel Setup

In panel setup, you carry out settings particular to the control panel. You can make the following settings.

For details of the operations, see “Setup Relating to Operations From the Control Panel” in Chapter 16 (Volume 2).

Panel settings (Config)

- **M/E Assign:** Set the logical configuration of the M/E and P/P banks.
- **M/E Operation:** For each of the M/E and P/P banks, make operations possible, not possible, or disabled (Enable/Disable/Inhibit).
- **Dual M/E Assign:** Using two M/E banks, assign the shift and non-shift button rows of a single M/E bank.
- **Dual M/E Xpt Swap:** When a setting has been made for Dual M/E Assign, swap the shift and non-shift button rows.
- **DSK Fader Assign:** Carry out fader function assignment and key delegation for the key delegation buttons, in each of the maximum of four downstream key control blocks.
- **External Bus Link:** Make link settings relating internal switcher buses to routing switcher destinations.
- **Key Trans Link:** Select whether or not to link transitions between keys, and if so which keyer to link to. You can set the links between keyers for each M/E bank separately.
- **Reference Module:** When a trackball module and a joystick module are both connected as device control blocks, select which is used as the reference.
- **10 Key Region Assign:** Assign any regions to the region selection buttons in the numeric keypad control block. Also used for setting the regions included in the selection when the [All] button is pressed.
- **Program Button:** Make assignments for buttons of some control blocks such as assigning the buttons in a transition control block for controlling a VTR and assigning the Flexi Pad control block to macro operation.
- **Compact Key Module Assign:** You can select which keys can be operated with an independent key transition control block (simple type).
- **M/E Operation Inhibit:** For each M/E or P/P bank, enable or inhibit utility 2 bus and key-related operations.



Cross-point button settings (Xpt Assign)

- **Xpt Assign:** For each control block or bus, display and set the assignments to the main table and tables 1 to 14. You can also carry out settings to link switcher signal selection to the audio mixer.
- **Main, V/K Pair Assign:** Make cross-point settings for the main table.
 - Assign video/key sources for button numbers 1 to 128.
 - For each table, specify whether the rightmost cross-point button in each row is used as a shift button, and the operation mode when it is used as a shift button.
 - For the [SHIFT] button in the cross-point control block and for each table, select the mode in which this is a shift button dedicated to the source name displays, or the mode in which it is a shift button for all buses.
 - Disable cross-point buttons to work.
- **Mixer Xpt Assign:** Assign audio mixer cross-points to cross-point buttons in the main table.
- **Table Button Assign:** Create tables 1 to 14 in the same way as the main table.
- **Src Name:** Set source names of up to 16 characters.
- **LCD Color:** Set the LCD color for source name display.
- **Table Copy:** Copy table contents from the main table to tables 1 to 14 or between tables 1 to 14 (it is not possible to copy tables 1 to 14 to the main table).
- **Name Export:** This function sends the source name and destination name to the S-Bus.
- **Side Flags Button Assign:** Assign the rightmost button in the background A/B row to the side flag function (inserting a selected image on both sides of a 4:3 image).

Auxiliary bus control block settings (Aux Assign)

- **Aux Assign:** Assign the AUX delegation buttons in the auxiliary bus control block to any bus.
- **Shift Mode:** Specify whether the rightmost button of the AUX delegation buttons is used as a shift button, and when it is used as a shift button, the operation mode.
- **RTR Mode Setting:** Carry out the following settings for using the auxiliary bus control block for router control.
 - Assigning destinations
 - Setting the shift operation in the destination selection button rows
 - Source table settings
 - Setting the shift operation in the source selection button rows
 - Assigning levels to the level selection buttons
 - Setting destination selection buttons to be used for snapshots

Button assignment settings (Prefs/Utility)

Assign the [PREFS 1] to [PREFS 16] buttons in the menu control block, the utility/shotbox control block buttons, and the cross-Point control block. This assigns recalling frequently used menus (menu shortcuts), enabling/disabling functions (recalling utility commands) and recalling shotbox registers or macro registers.

- **User Preference:** Make the settings for the user preference buttons in the menu control block.
- **Utility Module Assign:** Make the utility/shotbox control block settings.
- **KEY 2/4 Bus Button Assign:** Make the settings for the key 2 row buttons in the cross-point control block.

External device connections (Device Interface)

- **GPI Input:** Set the GPI input ports and trigger type, and make the action settings.
- **GPI Output:** Set the GPI output ports and trigger type, and make the action settings.
- **P-Bus Control:** Set the control mode for P-Bus devices.
- **DCU Serial Port Assign:** Assign the devices (disk recorder/VTR/Extended VTR) connected to a DCU and accessible from the control panel to the [DEV1] to [DEV12] buttons which become operative when you press the [DEV] button on the device control block. For a disk recorder or Extended VTR, you can also make settings relating to sharing of file lists. Further, you can make settings for devices (disk recorder/VTR/Extended VTR) operable from an editing keyboard.
- **Editor Port Assign:** When the BZS-8050 license is valid, make settings for the SCU editor panel port.

Operation settings (Operation)

- **Button Tally:** Set whether or not the system tally generation results are reflected in the panel tally.
- **Trans Rate Display:** Select whether the transition rate display mode is in frames or timecode units.
- **S-Bus Name Link:** Copy the S-Bus description name to the source name.
- **Effect:** For keyframe effects, you can make the following settings. (*See Chapter 13 “Keyframe Effects” (Volume 2).*)
 - Recall mode
 - Automatically turning off the [EDIT ENBL] button when an effect is recalled
 - Automatic insertion of a first keyframe when an empty register is recalled
 - Effect Auto Save
 - Default KF Duration
 - Setting whether or not to replay the first keyframe after rewinding a GPI/P-Bus/disk recorder/VTR/Extended VTR/Macro effect



- **Source/Dest Name:** For the Source/Dest (source/destination) names used by the system, select one of the following:
 - Source name set by cross-point assignment or fixed bus name
 - Description name set on routing switcher
 - “Type + Num” name set on routing switcherNames assigned with Xpt Assign can be replaced later with description names.
- **Name Display:** Specify the number of characters for display of the names selected in Source/Dest Name above, as two characters, four characters, or Auto.
- **Flexi Pad:** Carry out Flexi Pad settings. Specify the delegation selection coupling, and display mode for the LCD buttons. You can also make menu settings for wipe snapshots.
- **Custom Button:** Set the following button operation modes.
 - [ALL] button for next transition selection
 - [AUTO TRANS], [TAKE] or [FTB] button during auto transition execution
 - [RUN] button during keyframe execution
 - [AUTO TRANS] and [CUT] button replacement
 - [TRANS PVW] button
 - [UTIL] button
 - [XPT HOLD] button in key rows
 - Selection of signal assigned to the auxiliary bus control block key source bus (either key signal only, or either video signal or key signal selectable)
- **Sensitivity:** Adjust trackball, joystick and double-click sensitivity, or set the relationship between the angle of the search dial and the playback speed.
- **Main Split Fader:** When the split fader is active, specify whether the fader to control other than mix is the left side or the right side.
- **Macro:** Set the macro execution mode and the mode in which to edit macros using the standard type Flexi Pad control block.

Screen saver and other settings (Maintenance)

- **Screen Saver:** Make the menu screen saver settings.
- **LCD Brightness:** Adjust the LCD brightness.
- **LED Brightness:** Adjust the LED brightness.
- **Switch Brightness:** Adjust the switch brightness.
- **Touch Beep:** Select whether or not to sound a beep when a menu operation is carried out.
- **Touch Panel Calibration:** Calibrate the touch panel.
- **Initial Menu Set:** Specify the menu to be displayed at menu startup.

Switcher Setup

In switcher setup, make settings particular to the switcher processor.

You can make the following settings.

Settings relating to overall switcher configuration (Config)

- **System Phase:** Adjust the switcher internal reference phase.
- **Switch Timing:** Specify the timing of video switching.
- **M/E Config:** Set the program configuration for the M/E and P/P outputs.
 - **Standard mode:** Fix the maximum of four outputs (Out1 to 4) and program output configuration as follows.
 - Out1: Program output
 - Out2: Preview output
 - Out3: Clean output
 - Out4: Key preview output
 - Program output: Clean output + key 1 + key 2 + key 3 + key 4
 - **Multi-program mode:** Increase the number of M/E or P/P programs, and assign any of the following to the maximum of six outputs (Out1 to 6). (M/E Output Assign)
 - Program outputs 1 to 4, preview output, key preview outputs 1 and 2, clean output.
 - Further, you can select the program background from Clean or Utility2, and change the combination of signals from which it is configured. (PGM Config)
 - **DSK mode:** Treat P/P as four DSKs, with no background transitions. Of backgrounds 1 to 4, set one to configure the program output. (PGM Config) The signals which can be selected as the background are limited to Out1 to 6 from M/E-1 to M/E-3.
 - Regardless of the current M/E Config mode, you can set the key preview configuration to be video mode or key mode. In key mode, select whether to link the key state to the on/off operation, or have it always on. (K-PVW Config)
- **User 1 to 8 Config:** Assign the User regions, being color backgrounds 1 and 2, AUX1 to 48, monitor 1 to 8, frame memory 1 to 8, and color correctors 1 and 2, to any of User1 to User8.
- **Logical M/E Assign:** Make settings for handling PGM/PST hardware logically as an M/E.
- **DME Config:** Set the DME channel assignments used on the individual M/E and PGM/PST banks.
- **Side Flags:** Make settings relating to the side flag function (inserting a selected image on both sides of a 4:3 image).

Input signal settings (Input)

- **Input Phase Adjust:** Carry out phase adjustment for each primary input.
- **Through Mode:** Set through mode for the input side. This applies only to the primary inputs, and can be set independently for each primary input.

- **Video Process:** Switch video processing on or off for each input signal, and adjust the brightness, hue and so forth.
- **Matte Illeg. Color Limit:** Switch the illegal limiter on or off for the signal generated by the switcher internal matte generator.
- **FC Adjust (for MVS-8000G only):** Set the format converter inputs.

Output signal settings (Output)

- **Output Assign:** Assign the signals output from the Output1 to 48 ports.
- **Video Clip:** Adjust the clip levels (White Clip, Dark Clip, and Chroma Clip) for the output signals from each of the Output1 to 48 ports.
- **V Blank:** Adjust the vertical blanking width for the output signals from each of the Output1 to 48 ports. The setting is the number of scan lines from the reference blanking position of field 1 for the particular format which should be masked.
- **Through Mode:** Enable or disable through mode. Through mode can be enabled for AUX1 to 48 outputs, M/E and PGM/PST program outputs, and clean output.
- **Safe Title:** Enable or disable safe title, and carry out settings for box 1 and 2, cross and grid (for the MVS-8000G only).
- **Ref. Output Phase:** Set the reference output mode and phase adjustment (for the MVS-8000/8000A only).
- **4:3 Crop:** Set the actual video image to be cropped to a 4:3 aspect ratio when an HD system has a screen aspect ratio of 4:3.
- **FC Adjust (for MVS-8000G only):** Set the format converter outputs.

Settings relating to video switching (Transition)

- **Transition Preview:** Specify the operation mode for transition preview for each of the M/E and P/P banks.
- **Key Transition:** Specify the operation mode for independent key transitions.
- **Bus Toggle:** Switch the bus toggle for each of the M/E and P/P banks on or off.
- **Split Fader:** When the bus toggle is off, the split fader settings are enabled. For each of the M/E and P/P banks, select enable or disable.
- **Fade To Black:** Enable or disable fade-to-black for each final program output.
- **Preset Color Mix:** Set the stroke mode for a preset color mix, the key status for a transition including a key, and the mode in which the transition type after a transition ends returns to the previous setting.
- **Transition Curve:** Set the relationship when carrying out a transition, between the fader lever position and the advancement state of the transition.

Key, wipe and frame memory settings (Key/Wipe/FM/CCR)

- **Key Memory:** Set the key memory operation mode for each of the M/E and P/P banks.

- **Video Proc Memory:** Enable or disable video process memory.
- **Show Key:** Enable or disable show key for edit preview, M/E and P/P Pvw/K-Pvw.
- **Key Auto Drop:** For each switcher bank (M/E-1 to M/E-3, PGM/PST), specify a key to be turned off automatically when you press a cross-point button for the bus to be output as the background.
- **Mask/Border Process:** Set the processing order of masks and borders for each M/E or P/P bank.
- **Key Priority:** Set the key priority operation mode for each of the M/E and P/P banks. In DSK mode, the key priority is fixed.
- **Xpt Hold mode:** Set the operation mode for the cross-point hold button provided on the key bus for each of the M/E and P/P banks.
- **Pattern Limit Transition:** Set the operation mode when the pattern limit is released for each of the M/E and P/P banks.
- **Wipe Edge Default:** Adjust the wipe edge softness for each of the M/E and P/P banks.
- **CCR Internal Signal Enable:** Select whether signals generated internally to the switcher can be select as input material to the color corrector. (MVS-8000G/8000GSF only)
- **FM Auto Store:** Switch on or off the function to automatically attach a name and save in frame memory.

Link settings (Link)

- **Internal Bus Link:** Make a setting of the bus link function that links together two buses internal to the switcher.
- **GPI Link:** Make settings for linking any cross-point buttons or [CUT] and [AUTO TRANS] buttons in the cross-point control block and GPI output ports.
- **M/E Link:** Make settings to link together two M/E banks.
- **Key Trans Link:** Make settings to link key transitions.

External device connections (Device Interface)

- **Remote Assign:** Set the use of the four 9-pin ports.
- **GPI Input:** Set the GPI input ports and trigger polarities, and make the action settings.
- **GPI Output:** Set the GPI output ports and trigger polarities, and make the action settings.
- **Aux Control:** Set whether operations on the AUX buses from the four 9-pin ports are inhibited.
- **DME Type Setting:** When the DME is an MVE-9000 or MVE-8000A, carry out interface settings, and for an SDI interface set the AUX bus outputs and reentry inputs.

DME Setup

In DME setup, carry out settings particular to the DME processor.
You can make the following settings.

Input signal settings (Input)

- **Initial Crop:** Make the initial crop setting.
- **Matte Illeg. Color Limit:** Switch the illegal limiter for the signal generated by the DME internal matte generator on or off.
- **System Phase:** Adjust the operation timing of the whole system with respect to the reference signal.
- **TBC Center:** Set the TBC window center position.

Output signal settings (Output)

These settings are possible only when the DME is an MVE-9000 or SDI-interfaced MVE-8000A.

- **Monitor Output:** Set the signals output from the four monitor output connectors.
- **Clip Adjust:** Adjust the clip levels of DME1 and DME2 outputs.

Interface with external devices (Device Interface)

- **Editor Protocol:** Set the protocol to be used on the Editor port.
- **Editor Port Setting:** Make settings relating to the control of the four editor ports installed in the DME.
- **GPI Input:** Set the GPI input ports and trigger polarities, and make the action settings.
- **GPI Output:** Set the GPI output ports and trigger polarities, and make the action settings.

Setup Relating to DCU Input/Output

In DCU setup, carry out settings particular to the DCU.
You can make the following settings.

- **Input Config:** Assign GPI inputs to Parallel input ports.
- **GPI Input Assign:** Make GPI input settings.
- **Output Config:** Assign GPI outputs to parallel output ports inserted in an option slot.
- **GPI Output Assign:** Make GPI output settings.
- **Serial Port Assign:** Set the protocol to match the devices connected to a 9-pin serial port. You can also select the control panel used to control each device.

Setup Relating to the Router Interface and Tally Interface

Carry out settings relating to the interface with the routing switcher, and settings relating to the tally interface.
You can make the following settings.

Router interface setup (Router)

These settings are common to the parallel tally and serial tally.

- **Matrix Size:** Assign the switcher matrix of each switcher processor to S-Bus space, and select the matrix size and positioning level, source address settings, and so on.
- **External Box:** To obtain the signal selection status of external devices with a parallel input, assign a matrix as an external selector in the S-Bus space. Make the matrix size, assignment level, source address, and other settings.
- **Alias Name Gp:** Set the group number for an S-Bus description name to be displayed in the source name displays for a cross-point operation.

Tally interface setup (Tally)

Group tally settings (Group Tally)

- **Tally Group:** Select the group tally (Gp1 to 4 or Gp5 to 8) which can be used. (For the parallel tally, all groups can be used regardless of this setting.)
- **S-Bus Tally Enable:** Specify S-Bus tally enabled or disabled.

Wiring information input (Wiring)

Input the information which specifies the physical wiring between switcher and routing switcher or between two routing switchers.

These settings are common to the parallel tally and serial tally.

Tally enable settings (Tally Enable)

Specify the destination to be the reference for tally generation, and make various settings.

These settings are common to the parallel tally and serial tally.

- **Tally Type:** Specify the tally type.
- **Destination:** Specify the address and level.
- **Tally Enable:** Specify the timing at which a tally is enabled.
 - Enable:** Always enabled.
 - Disable:** Always disabled.
 - Tally Input:** Follow the tally input status.



Copy (Tally Copy)

Copy the tally information pertaining to a particular source to a different source.

These settings are common to the parallel tally and serial tally.

Parallel port settings (Parallel Tally)

Make the parallel port settings for output of tally information pertaining to sources and destinations.

For each of the tally output terminal numbers, specify the tally type, and source address or destination level and address.

Serial tally settings (Serial Tally)

Make the serial tally settings, including tally type and source address for each serial tally port.

Simple Connection to MKS-8080/8082 AUX Bus Remote Panel (Option)

To connect the MKS-8080/8082 AUX Bus Remote Panel to a CCP-8000 Center Control Panel using an S-Bus data link requires a BKPF-R70A Routing Switcher Controller Board or similar primary station and various settings for connection.

However, using a simple connection, the need for an S-Bus data link primary station is avoided, and direct connection to the MKS-8080/8082 is possible. A simple connection is possible if the following conditions are met:

- There are no devices other than the CCP-8000 and MKS-8080/8082 connected on the S-Bus data link.
- There are no more than 16 MKS-8080/8082 units connected on the S-Bus data link.

For details of the connection procedure, see “Procedure for Simple Connection” in Chapter 16 (Volume 2).

Files

You can save register data, including setup information and snapshot information, as a file on a hard disk or memory card, and recall it as required. You can operate on individual files or registers, or together in a batch. Regarding frame memory, it is possible to capture image data stored in an external device into frame memory. You can also convert the format of image data in frame memory into a different format and save it in an external device.

Files that can be manipulated

The following files can be saved and recalled.

- Operation mode setup data for system as a whole and individual devices
- Device status data for system startup
- Key memory setting data
- Video process memory setting data
- Keyframe effect setting data
- Snapshot setting data
- Wipe snapshot setting data
- DME wipe snapshot setting data
- Key snapshot setting data
- Shotbox setting data
- Macro setting data
- Macro attachment data
- Menu macro setting data
- Frame memory image data

File operations

You can carry out the following file operations.

When operating on individual files or registers

Save: Save the data in a register to the hard disk or memory card.

Load: Load a file from the hard disk or memory card.

Copy: Copy a file within a directory or from one directory to another. When a remote panel is used, this function applies to it, too.

Rename: Rename a file on the hard disk or memory card.

Delete: Delete a file from the hard disk or memory card.

When operating on files or registers in a batch

The Save, Load, Copy and Delete operations are performable.

Importing or exporting files to or from frame memory

Import: Import a file in a different format from hard disk or memory card into frame memory after changing its format.

Export: Export a file in a register to hard disk or memory card after changing its format.

You can import TIFF, BMP, and TARGA files as follows into frame memory.

File type	Format	File name	Notes
TIFF file	RGB uncompressed format	Maximum eight characters, plus extension .tif required	<ul style="list-style-type: none"> Layers cannot be used. If an alpha channel is present, two files are created as a pair.
BMP file	Windows ^{a)} 24-bit format	Maximum eight characters, plus extension .bmp required	–
TARGA file	RGB uncompressed/compressed format	Maximum eight characters, plus extension .tga required	<ul style="list-style-type: none"> Layers cannot be used. If an alpha channel is present, two files are created as a pair.

a) Windows is a registered trademark or trademark of Microsoft Corporation in the United States and/or other countries.

Note

This functionality has been tested and confirmed to work with TIFF files created by Photoshop, but it may not be possible to use TIFF files created with some other software. (Photoshop is a trademark of Adobe Systems Incorporated.)

About import image size

Pay attention to the following, depending on the signal format which you use.

SDTV (480i)

Images 720 × 487 pixels in size are exactly the size which fills the full screen. The following figure shows how an import image is processed when the 480i/59.94 format is used.

Images are placed with the upper left of the screen as the origin.

When an image is smaller than the screen, the remainder of the screen is filled with black. When it is larger, parts which extend beyond the screen are discarded.

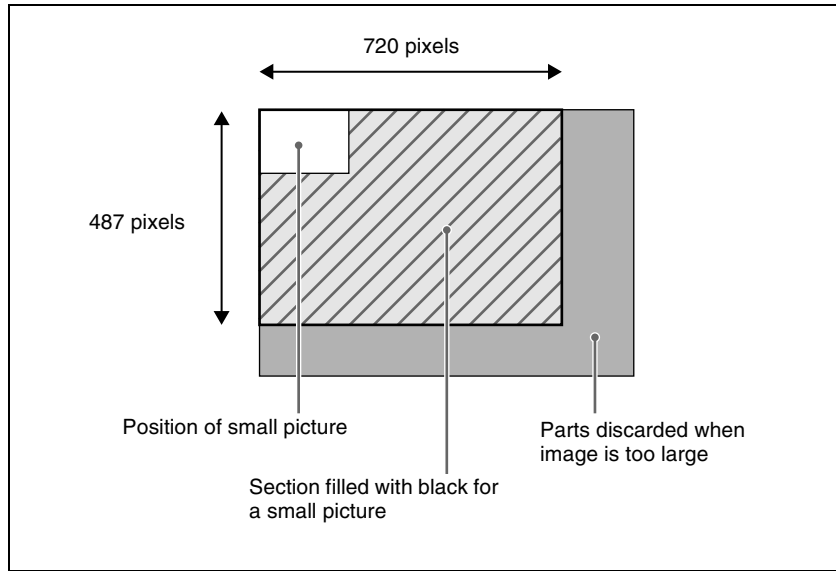

No pixel ratio conversion is performed when images are imported for the SDTV format. When the signal format is 480i/59.94, if you create an image with a size of 720 × 540 on a computer and then import it just as it is, the image will be too tall. To maintain the shape of the image, first create it as a 720 × 540 image and then use computer software tools to compress the vertical dimension to 487 pixels before importing it.

HDTV (1080i)

Images of 1920 × 1080 pixels in size are exactly the size which fills the full screen.

Like SDTV, images are placed with the upper left of the screen as the origin. When an image is smaller or larger than the screen, processing is the same as for SDTV.

Since the pixel ratio of the HDTV format is 1:1, files created on computers are imported in their original shapes.

The following table shows the image sizes which exactly fill the full screen for the various signal formats.

Signal format	Image size (H × V)
480i/59.94	720 × 487
576i/50	720 × 576



Signal format	Image size (H × V)
1080i/50	1920 × 1080
1080i/59.94	
1080PsF/23.976	
1080PsF/24	
1080PsF/25	
1080PsF/29.97	
720P/50	1280 × 720
720P/59.94	

Importing 720P movie material

To import movie material in 720P format, it is necessary to treat each frame as a separate image file.

Directory operations

You can create a new directory within a hard disk or memory card, and carry out other operations, such as renaming and deleting.

For details of operations, see “Directory Operations” in Chapter 17 (Volume 2).

File copying between different unit IDs

Switcher and DME files within the hard disk or memory card are managed by unit ID.

To copy files between different unit IDs, use the Unit ID Copy menu.

For details of operations, see “Copying Files Between Different Unit IDs” in Chapter 17 (Volume 2).

Saving data recalled by autoload

At power on, you can automatically recall data previously stored on the hard disk. (Autoload function)

The following data can be loaded by the autoload function.

- Keyframe effect setting data
- Snapshot setting data
- Wipe snapshot setting data
- DME wipe snapshot setting data
- Key snapshot setting data
- Shotbox setting data
- Macro setting data
- Macro attachment data

- Frame memory image data

To use the autoload function, the data required must first be saved.

For the on/off setting of the autoload function, see “Selecting the State After Powering On (Start Up Menu)” in Chapter 16 (Volume 2).

For details of saving operations, see “Saving Files Recalled by Autoload” in Chapter 17 (Volume 2).



Macros

Overview

The term “macro” refers to the function whereby a sequence of signal selections and other operations on the control panel is saved as data in memory, so that it can be recalled as required to automatically execute the same sequence of operations.

To record menu operations in memory, use a menu macro (*see page 222*).

For details of macro operations, see “Macros” in Chapter 18 (Volume 2).

Macro registers

The area of memory that holds a macro is termed a “macro register.” For each control panel there are 99 macro registers, numbered 1 to 99.

Events

The individual control panel operations constituting a macro are termed “events.” One macro can contain a maximum of 99 events.

The following table shows the operations for each control block of the control panel that can be saved as events in a macro.

Control block	Event
Auxiliary bus control block	Cross-point selection
	Cross-point selection in router control mode
Cross-point control block	<ul style="list-style-type: none">• Cross-point selection• Recalling a function assigned to a key 2 row button



Control block		Event
Transition control block	standard type	<ul style="list-style-type: none"> • Auto transition and cut for the transition execution section • Auto transition and key on/off for the independent key transition execution section ^{a)} • Next transition setting • Transition type selection • Pattern limit on/off • Key snapshot recall • VTR/disk recorder/Extended VTR /frame memory clips playback ^{b)} • VTR/disk recorder/Extended VTR /frame memory clips stop ^{b)} • VTR/disk recorder/Extended VTR /frame memory clips cue-up ^{b)}
	simple type	<ul style="list-style-type: none"> • Transition execution section take • Transition type selection • Pattern limit on/off
	compact type	<ul style="list-style-type: none"> • Transition execution section auto transition and cut • Independent key transition execution section auto transition ^{a)} • Next transition setting • Transition type selection • Pattern limit on/off • VTR/disk recorder/Extended VTR /frame memory clips playback ^{b)} • VTR/disk recorder/Extended VTR /frame memory clips stop ^{b)} • VTR/disk recorder/Extended VTR /frame memory clips cue-up ^{b)}
Independent key transition control block (simple type)		<ul style="list-style-type: none"> • Independent key transition execution section take and key on/off ^{a)} • Key snapshot recall • Selection of independent key transition type
Flexi Pad control block	standard type	Recalling the following data <ul style="list-style-type: none"> • Snapshots • Wipe snapshots • DME wipe snapshots
	simple type	Recalling the following data <ul style="list-style-type: none"> • Snapshots • Wipe snapshots • DME wipe snapshots
Numeric keypad control block		Recalling the following data <ul style="list-style-type: none"> • Effects • Snapshots • Shotbox • Master snapshots • Master timeline

Control block	Event
Keyframe control block	<ul style="list-style-type: none"> • Effect rewind • Effect execution • Effect fast forward • Selection of effect execution direction
Device control block (trackball) (joystick) (search dial) ^{c)}	<ul style="list-style-type: none"> • VTR/disk recorder/Extended VTR/frame memory clips start point setting • VTR/disk recorder/Extended VTR/frame memory clips playback • VTR/disk recorder/Extended VTR/frame memory clips stop • VTR/disk recorder/Extended VTR/frame memory clips cue-up • VTR/disk recorder/Extended VTR/frame memory clips fast forward • VTR/disk recorder/Extended VTR/frame memory clips rewind • VTR/disk recorder record • Frame memory clip loop setting
Downstream key control block	<ul style="list-style-type: none"> • Independent key transition execution section auto transition and cut ^{a)} • Key snapshot recall
Fade to black control block	Execution of fade to black transition
Menu control block	<ul style="list-style-type: none"> • Disk recorder/Extended VTR file recalling • Recalling the functions assigned to [PREFS 1] to [PREFS 16] buttons • Execution of a menu macro • Recalling frame memory clips
Utility/Shotbox control block	Recalling the functions assigned to memory recall buttons

- a) In the case of an event that inserts or deletes a key, the key state at the time of event registration (inserted or not inserted) is also saved in the macro. When the macro is executed, the event is only replayed if the key state matches the saved state. (Example: For a macro with an event that deletes a key, when the macro is executed, if the key is inserted it is deleted, but otherwise nothing occurs as concerns keying.)
- b) Function valid only when [PLAY], [STOP], and [CUEUP] have been set in the Setup menu.
- c) When using the device control block (search dial), this operates as a reference module. When not used, this operates on the module selected in the Panel >Config menu.
For details of reference module selection, see "Overall Control Panel Settings (Config Menu)" in Chapter 16 (Volume 2).

Macro Creation and Editing

You can create or edit a macro by recalling a macro register.
To create a new macro, recall an empty macro register, and create the desired sequence of events (by executing the sequence of operations on the control panel that you want to save as events in the macro).

To add an event to an existing macro, recall the register holding the macro, and create the event you want to add.

Note

While editing a macro, it is not possible to execute another macro.

Creating a macro

To include all information associated with an operation when registering a macro event

When registering an auto transition operation as an event, you can register the auto transition event to include the transition rate and background A/B bus selection status. When registering an effect execution, rewind, or fast forward as an event, you can also save the region to which this applies.

To use this capability, assign the following functions to user preference buttons in the menu control block or buttons in the utility/shotbox control block, and turn the relevant button on before you start an event to register.

Macro AT with Rate (Macro Auto Trans Event with/without Rate): When registering an auto transition macro event in one of the M/E banks or the PGM/PST bank, include the transition rate.

Macro AT with A/B Bus (Macro Auto Trans Event with/without A/B Bus): When registering an auto transition macro event in the transition control block, include the background A/B bus cross-point.

Macro TL with Region (Macro Timeline with Region): When registering an effect execution, rewind, or fast forward as a macro event, save the affected region together in the macro.

For details of the method of assigning these functions to buttons, see “Setting Button Assignments (Prefs/Utility Menu)” in Chapter 16 (Volume 2).

Events requiring adjustment when creating a macro

The following events require time for execution to complete, and therefore when executed within a macro sequence, a pause event must be inserted to adjust the timing.

- Rewinding effects involving external device control
- VTR/disk recorder/Extended VTR cue-up

For example, create a macro to cue up a VTR and then play back as follows.

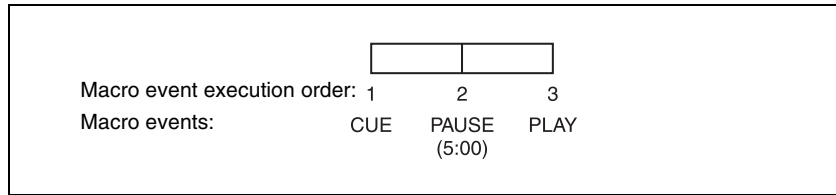

Auto insert mode on/off setting

You can switch on or off the mode (auto insert mode) in which at the same time that a control panel operation is carried out, the event is automatically saved in a macro.

Editing a macro

You can carry out the following macro editing operations.

Event insertion

Insert the control panel operation as an event in a macro.

Event modification

Modify any event. You can modify all events within a macro, or events within a specified range in a single operation.

Event deletion

Delete any one event. You can delete all events within a macro, or events within a specified range in a single operation. You can then paste the deleted event using the paste function.

Event copy

Copy any one event. You can copy all events within a macro, or events within a specified range in a single operation.

Event paste

Paste a copied or deleted event at a desired position within a macro.

Undoing an editing operation

You can undo the last event insertion, modification, deletion, or paste operation.

Macro merging

During macro editing, you can recall and copy another register to merge it with the macro being edited.

For example, while editing macro register 2 you can recall and copy register 1 to merge it as shown in the following figure.

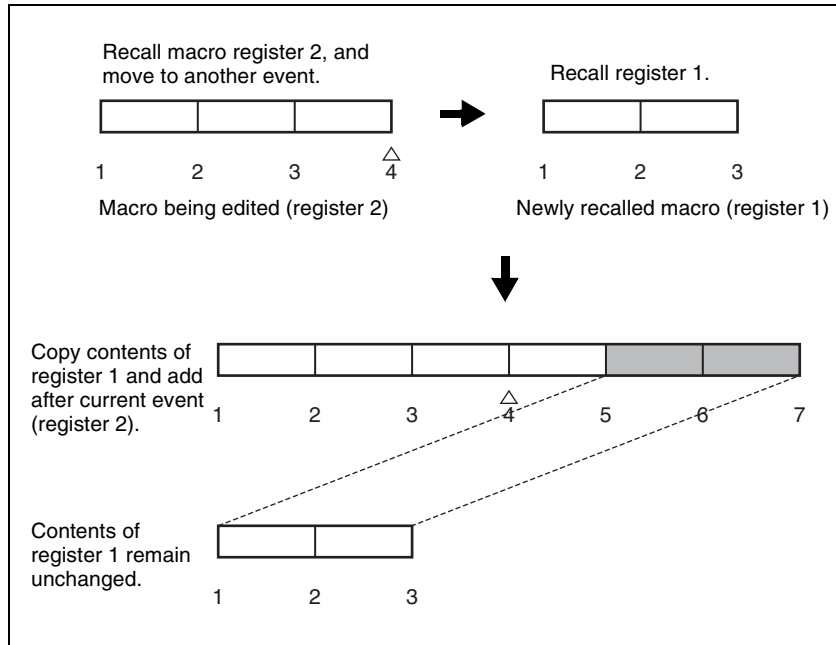

Macro Execution

To execute a macro, recall the register in which the macro is held. Simultaneous with the register recall, all events stored in the macro are played back (executed) in sequence without pause.

Pausing and restarting macro execution

It is also possible to execute a macro in the following ways.

Pause event

To adjust the execution timing of a particular event (to delay the start of execution of the event by a particular time interval), you can store a special event which pauses macro execution. This event is called a “pause event.” When you store a pause event, you can set the interval for which the macro is paused (the pause length) to any value in the range 1 to 999 frames. When the set time has elapsed, the macro is automatically executed.

Pause zero event

By including a pause event with the time set to zero, you can make macro execution pause at the pause event.

Step execution (requires a Setup menu setting)

By selecting step execution mode in the Setup menu, you can make macro execution pause every time an event is executed.

Take operation

When a paused macro is restarted, this is referred to as a “Take” operation.

Macro take operation using a GPI input

You can carry out a macro take operation using a GPI input on the control panel and DCU.

For GPI input settings, see “Interfacing With External Devices (Device Interface Menu)” and “GPI Input Setting (GPI Input Assign Menu)” in Chapter 16 (Volume 2).

Macro Timeline

By recording macro recall and execute action on a timeline, in the same way as for key frames in an effect, you can automatically execute them in a sequence. This timeline is called a “macro timeline,” and one macro timeline can have up to 99 macros being executed simultaneously in parallel.

There are 99 registers in the Macro region that can be recorded on the macro timeline, numbered 1 to 99. These registers are distinct from the registers where individual macros are stored.

Note

If you use a macro timeline to superimpose more than one macro, the macros may not be executed according to the timing information registered in the timeline.

Available key frame functions

The following lists the key frame functions that can be used on the macro timeline.

- RECALL(1 to 99), STORE(1 to 99), RECALL UNDO, STORE UNDO, search for empty register, AUTO SAVE, RECALL MODE (RECALL, RECALL & REWIND)
- EDIT ENABLE, EDIT UNDO
- CONST DUR, EFF DUR, KF DUR, DELAY, PAUSE, INSERT BEFORE, INSERT AFTER, MODIFY, DELETE, COPY, PASTE BEFORE, PASTE AFTER, FROM TO, ALL
- PREV KF, NEXT KF, GOTO TC, GOTO KF, RUN, REWIND, FF, STOP NEXT KF, NORMAL, JOG, KF FADER

The following key frame functions cannot be used

- KF LOOP, EFFECT LOOP, REVERSE, NORMAL/REVERSE
- PATH

Saving to a register

Set the recall and execute actions for the macros to be registered in the timeline, using the Macro Timeline menu. The setting data can be saved in a register as key frame data. You can manipulate this data by recalling the register in which it is saved, and using the key frame control block.

For details, see Chapter 18, “Macros” (Volume 2).

Note

An action set for a key frame is only executed when the key frame effect is executed in the forward direction. It is important to remember that the action is not executed in the reverse direction when executing simultaneously with switcher and DME key frame effects.

Forcibly ending a macro timeline

- If the timeline has completed but a macro is still executing, press the [REWIND] or [RUN] button in the key frame control block to forcibly end the macro timeline.
- In a macro timeline, since a take operation is not possible, if a macro included in the timeline has a pause event with a pause time of zero, the remainder of the timeline after the pause is ignored, and the macro timeline ends at that point.

Register editing functions

You can use the following editing functions on a register in which a macro timeline is stored.

- Copy
- Move
- Swap
- Merge
- Lock
- Name
- Delete

File-related functions

You can save and recall a created macro timeline as effect data, in the File menu.

Macro Editing Using Menus

Macro Register Editing

You can lock, copy, and delete the contents of macro registers, and rename macro registers.

Lock: Write-protect the contents of a macro register.

Copy: Copy the contents of a macro register to another macro register.

Delete: Delete the contents of a macro register.

Rename: Rename a macro register.

Online editing of macro events

Using the On Line Edit menu, you can carry out the following editing operations while checking the control panel operation sequence. You can also carry out editing using the panel and menu.

Insert: Insert a macro event.

Delete: Delete a macro event.

Modify: Modify a macro event.

Offline editing of macro events

Using the Off Line Edit menu, you can carry out the following editing operations in the menu only, unrelated to operation of the control panel.

Insert: Insert a macro event.

Add: Add a macro event.

Delete: Delete a macro event.

You can also create a new macro.

Macro Attachment

Macro attachment is a function whereby a macro register is assigned to a control panel button or a particular position of a fader lever, linking the execution of the button function or a fader lever operation with a macro execution.

Setting a macro attachment to a button

Select one of the following three linking modes to make the macro attachment.

Pre-macro: Mode in which the button function is executed after macro execution has completed



Post-macro: Mode in which the macro is executed after carrying out the button function

Macro only: Mode in which the button function is not executed, and the macro only is executed

The selection of pre- or post-macro mode is carried out in the cross-point control block of the PGM/PST bank or the M/E banks. For the macro-only mode, assign the selection function to a utility/shotbox control block button or user preference button, and make the selection by pressing the button.

Alternatively, without pressing the button, you can make the selection simply, by simultaneously pressing the pre-macro and post-macro selection buttons in the cross-point control block.

You can assign any one of the 99 macro registers to a button.

For a button whose function is switched by delegation, you can make a separate macro attachment for each function.

For each control panel, you can make up to 1000 macro attachment settings.

The macro attachment setting is possible for the following bus buttons. *For button locations, see pages in parentheses.*

Block	Button
PGM/PST or M/E bank	<ul style="list-style-type: none"> • Background A row cross-point buttons (<i>page 256</i>) • Background B row cross-point buttons (<i>page 256</i>) • Key 1 bus cross-point buttons (<i>page 256</i>) • Key 2 bus cross-point buttons (<i>page 256</i>) • Key 3 bus cross-point buttons (<i>page 256</i>) • Key 4 bus cross-point buttons (<i>page 256</i>) • Utility 1 bus cross-point buttons (<i>page 256</i>) • Utility 2 bus cross-point buttons (<i>page 256</i>) • DME external video bus cross-point buttons (<i>page 256</i>) • DME utility 1 bus cross-point buttons (<i>page 256</i>) • DME utility 2 bus cross-point buttons (<i>page 256</i>) • [AUTO TRANS] button ^{a)} (<i>page 260</i>) • [CUT] button (<i>page 260</i>) • [KEY1 ON] to [KEY4 ON] buttons ^{a)} (<i>pages 260, 304</i>) • The button to which the same function as that of VTR/disk recorder/Extended VTR/frame memory clips play, cue, and stop buttons (<i>page 260</i>) • Memory recall buttons ⁱ⁾ • Buttons set to "Inhibit" (<i>page 256</i>)
Auxiliary bus control block	<ul style="list-style-type: none"> • Cross-point button 1st row ^{b)} (<i>page 288</i>) • Cross-point button 2nd row ^{b)} (<i>page 288</i>)
Keyframe control block	<ul style="list-style-type: none"> • [RUN], [REWIND] and [FF] buttons (<i>page 281</i>) • [NORM], [REV], and [NORM/REV] buttons (<i>page 281</i>)

Block	Button
Device control block (trackball, joystick)	The buttons to which the same functions as those of VTR/disk recorder/Extended VTR/frame memory clips play, cue, stop, and start tc buttons (<i>page 271</i>)
Device control block (search dial)	[PLAY], [CUE], [STOP] and [START TC] buttons
Downstream key control block	<ul style="list-style-type: none"> • [DSK1 ON] to [DSK4 ON] buttons ^{a)} (<i>page 306</i>) • [TAKE] button ^{a)} (<i>page 306</i>) • [MIX], [WIPE], [DME], and [CUT] buttons (<i>page 306</i>)
Transition control block	<ul style="list-style-type: none"> • [PTN LIMIT] button ^{c) d)} (<i>page 260</i>) • [LIMIT SET] and [KF] buttons ^{c) d)} (<i>page 260</i>) • [NORM], [NORM/REV], and [REV] buttons ^{c) e)} (<i>pages 260, 310</i>) • [MIX], [NAM], [SUPER MIX], [PST COLOR MIX], [WIPE], and [DME] buttons (<i>pages 260, 299, 310</i>) • [MIX], [WIPE], and [DME] buttons ^{d)} (<i>page 260</i>) • [ALL], [KEY PRIOR], [BKGD], and [KEY1] to [KEY4] buttons (<i>pages 260, 299, 310</i>) • [CUT] button ^{f)} (<i>page 304</i>)
Fade to black control block	[FTB] button (<i>pages 287, 308</i>)
Downstream key/fade to black control block	<ul style="list-style-type: none"> • [DSK1 ON] and [DSK2 ON] buttons • [AUTO TRANS] button • [FTB] button
Utility/shotbox control block	Memory recall buttons (<i>page 298</i>)
Menu control block	[PREFS 1] to [PREFS 16] buttons (<i>page 294</i>)
Independent key transition control block (simple type) ^{h)}	<ul style="list-style-type: none"> • [KEYx ON] button ^{a) g)} • [TAKE] button ^{a)} • [MIX], [WIPE], [DME], and [CUT] buttons

- a) In the case of an event that inserts or deletes a key by an independent key transition, the key state at the time of event registration (inserted or not inserted) is also saved in the macro. When the macro is executed, the event is only replayed if the key state matches the saved state. (Example: For a macro with an event that deletes a key, when the macro is executed, if the key is inserted it is deleted, but otherwise nothing occurs as concerns keying.)
- b) Cross-point buttons of the bus assigned by AUX delegation setting.
- c) Macro attachment can be set with these buttons only when they are assigned to [Play/Stop/Cue] in the Engineering Setup >Panel >Config >Program Button >Transition Module menu and when the [DEV] button in the device control block is lit.
- d) Buttons on the standard type module only.
- e) Buttons on the standard type module and compact type module only.
- f) Independent key transition control block (simple type only).
- g) "KEYx" refers to any of KEY1 to KEY4 and DSK1 to DSK4, depending on the key assigned in setup.
- h) When there are a number of control blocks on the control panel, and the keys assigned to them in setup are the same, then the macro attachment settings for the above buttons are the same. The keys being the same includes cases such as "Key1,2" assigned to PGM/PST being the same as "DSK1,2", "Key1,2" assigned to M/E-1 being the same as "M/E-1 Key1,2", and so on.
- i) Only when key row is operated in the utility/shotbox mode

Notes

- After setting a macro attachment to a cross-point button in the auxiliary bus control block, if in the Setup menu you change the assignment of buses to the AUX delegation buttons, the macro attachment setting disappears.
- After setting a macro attachment to a button for which you can perform function replacement or function assignment, if you change the function assignment to the button, the macro attachment setting disappears.
- After setting a macro attachment to a cross-point button in the cross-point control block, if you change the function assignment to the button, the macro attachment setting disappears.

Enabling and disabling macro attachment

You can temporarily disable the macro attachment settings. When a macro attachment is disabled, pressing the button does not cause execution of the assigned macro.

You can enable and disable macro attachments for the PGM/PST bank and M/E banks individually.

Setting a macro attachment to a fader lever

You can set a macro attachment to any particular position of a fader lever in the transition control block.

Notes

- In macro-only mode it is not possible to set a macro attachment.
- It is not possible to set a macro attachment to a fader lever in the keyframe control block or downstream key control block.
- For a split fader, you can set a macro attachment to the main split fader.

For details of a split fader, see “Split Fader” (page 373).

Clearing the macro attachments

You can clear all of the macro attachments in a single operation.

Displaying the macro attachment list

You can display the macro attachment settings in the form of a list in the menu display to check them.

Menu Macros

The term “menu macro” refers to the function whereby a sequence of menu operations is saved as data in memory, so that it can be recalled as required to automatically execute the same sequence of operations.

For more details of menu macros, see “Menu Macros” in Chapter 18 (Volume 2).

Menu macro registers

The area of memory that holds a menu macro is termed a “menu macro register.” For each control panel there are 99 menu macro registers, numbered 1 to 99. You can manipulate these in the menu macro register menu.

Menu macro events

The events that can be recorded in a menu macro are operations carried out in a menu.

For menu operations which are not recorded in menu macros, see the appendix, “Menu Operations Not Recorded in a Menu Macro” (Volume 2).

Menu macro creation and editing

Carry out menu macro creation and editing in the menu.

Executing menu macros

You execute a menu macro after recalling a menu macro register. You can recall and execute simultaneously. You can also recall and execute a menu macro from a macro recalled on the control panel.



Color Corrector

The color corrector enables video signal color correction (black balance/white balance adjustment, gamma correction, knee correction, etc.).

Note

To use the color corrector function on the MVS-8000/8000A requires the MKS-8420M Color Corrector Board. To use the color corrector function on the MVS-8000G requires the MKS-8442G Frame Memory Board and BZS-8420 Color Corrector Software. To use the software, you are required to input an install key.

For the method of inputting an install key, see “Installation and Device Setup (Install/Unit Config Menu)” in Chapter 16 (Volume 2).

The color corrector includes the following functions.

Input video processing

Carrying out the following corrections to a YUV signal before conversion to an RGB signal.

- Overall gain adjustment of the video signal
- Gain adjustment of the Y signal
- Gain adjustment of the C signal
- Hue delay
- Black level adjustment

Primary color correction

Carrying out the following corrections to each of the R, G, and B signals.

Black balance adjustment: setting the output level for a 0% level input signal.

White balance adjustment: setting the output level for a 100% level input signal.

Gamma correction: adjusting the curvature of the gamma curve.

Knee correction: adjusting the position of the maximum point of the gamma curve.

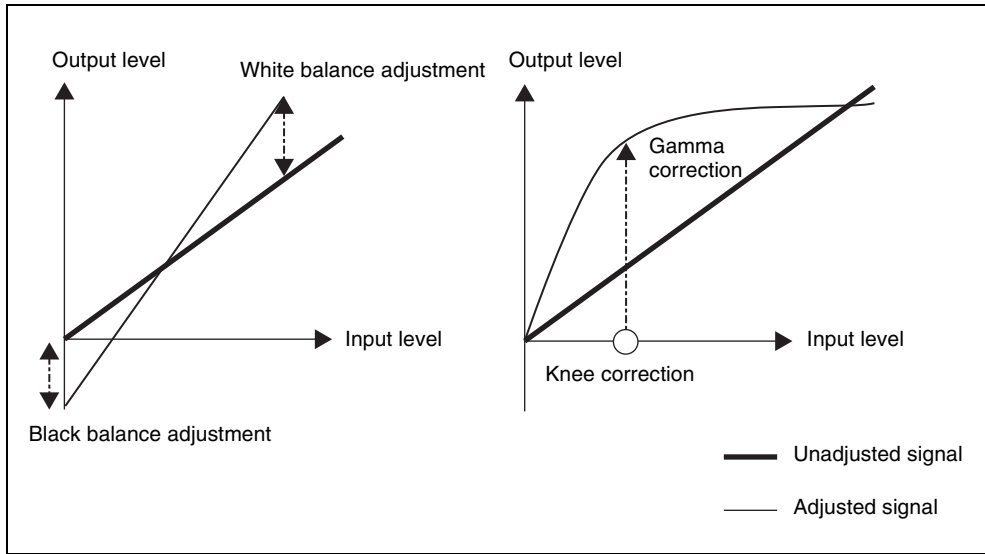

It is also possible to mask part of the region to be corrected.

Secondary color correction

For the six colors R (red), G (green), B (blue), Y (yellow), C (cyan), and M (magenta), adjust the luminance and saturation, and also the hue within a range of ± 30 degrees of the center value for each color. You can mask a part of the region to be corrected.

Note

This function is disabled when spot CCR is enabled with a setup setting. For details, see “Installation and Device Setup (Install/Unit Config Menu)” in Chapter 16 (Volume 2).

On the MVS-8000G, this function and spot CCR can be enabled at the same time.

RGB clip

For each of the R, G, and B signals, you can make dark clip and white clip adjustments.

Luminance processing

After converting a signal to which RGB color correction has been applied to a YUV signal, dividing the luminance levels into three regions, referred to as

Dark, Middle, and Bright, and applying video signal adjustments to these regions.

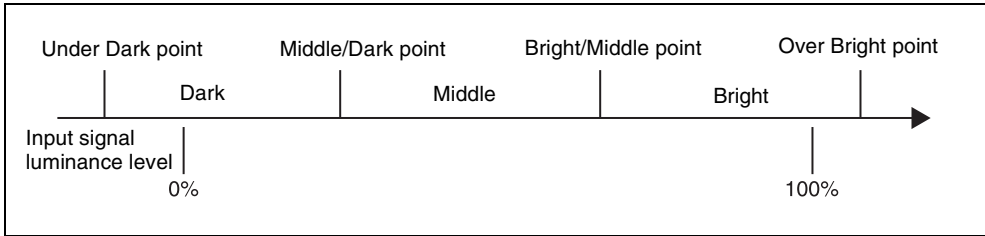

There are three modes for luminance processing, as follows.

Tint mode: adding a specified color to the original video signal.

Color Modify mode: adjusting the original video signal.

Y Modify mode: adjusting the output levels of the input luminance signal.

- White balance adjustment: setting the output level for an input luminance signal at the 100% level.
- Black balance adjustment: setting the output level for an input luminance signal at the 0% level.
- Y lift correction: adjusting the curvature of the curve.
- Y dark correction: adjusting the position of the maximum point of the curve.

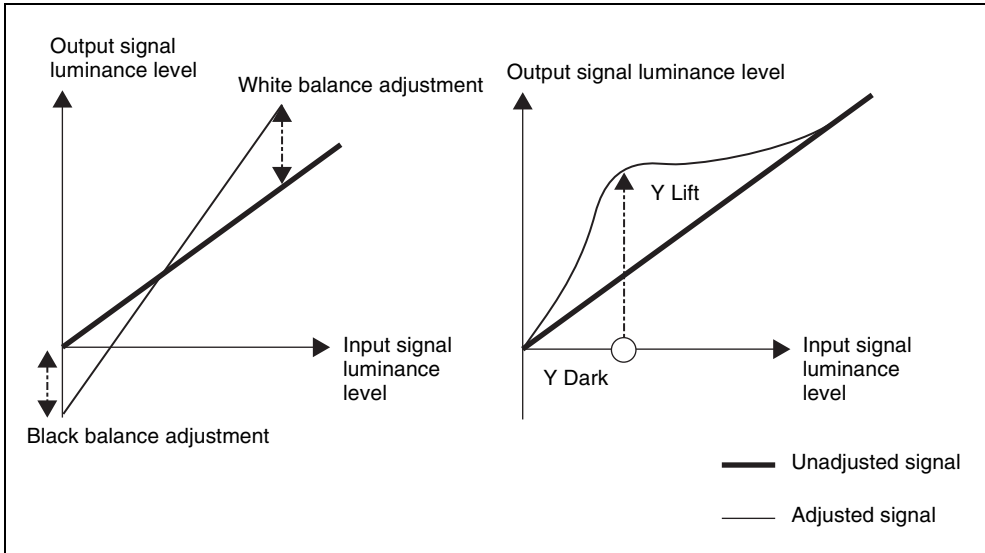

It is also possible to mask part of the region to be corrected.



Spot color adjustment

You can change the color of a specified color region to a different color, without affecting other regions. You can also mask part of such a region. Then for the region other than the region whose color you have changed, you can make the following corrections.

- Video signal overall gain adjustment
- Y signal gain adjustment
- Y signal offset adjustment
- C signal gain adjustment
- C signal hue adjustment

Note

This function is disabled when secondary CCR is enabled with a setup setting. For details, see “Installation and Device Setup (Install/Unit Config Menu)” in Chapter 16 (Volume 2).

On the MVS-8000G, this function and secondary CCR can be enabled at the same time.

Output video processing

Carrying out the following corrections on the YUV signal.

- Video signal overall gain adjustment
- Y signal gain adjustment
- Y signal offset adjustment
- C signal gain adjustment
- C signal hue adjustment

YUV clip

For each of the luminance and color difference signals, the following processing.

White clip: setting the maximum level of the luminance signal.

Dark clip: setting the minimum level of the luminance signal.

Positive clip: setting the maximum amplitude in the positive direction of the color difference signal.

Negative clip: setting the maximum amplitude in the negative direction of the color difference signal.

Copy and swap

Copying or swapping data between two color correctors (CCR1 and CCR2).

Simple P/P Software

Overview

By installing the BZS-8250 Simple P/P Software in the MVS-8000A/8000ASF/8000G/8000GSF Switcher Processor, you can use a separate program/preset function without using the M/E hardware.

Getting access to the software

To use the Simple P/P Software, you are required to enter an install key which validates the software. (If the software has been factory installed, the install key is not required.)

For the method of obtaining an install key, contact your Sony representative. On that occasion, you may be required to submit the unique device ID of the switcher you are using. You can check the unique device ID in the Install menu of the switcher. *For details of operating procedures, see Chapter 16, "Installation and Device Setup (Install/Unit Config Menu)" (Volume 2).*

Restrictions on Use

Since this software is a simple version of the program/preset function, there are some restrictions on use. The following lists the points at which operation is different from a normal program/preset function. For details of the normal operations, set the relevant sections of this manual.

Restrictions on using a downstream key

- DSK3 and DSK4 cannot be used.
For the key priority, set priority 1 or priority 2.
- The following downstream key types cannot be used.
 - Chroma key
 - Color vector key
 - Wipe pattern key
 - Key wipe pattern key
- When using a matte as the key fill for a downstream key, a mix color cannot be used.
- It is not possible to modify a downstream key edge. The edge blink also cannot be used.
- For a downstream key, main mask and sub-mask cannot be used.

- A processed key cannot be used. Therefore, it is not possible to apply a DME effect to a downstream key.
- As an independent key transition type, wipe and DME wipe cannot be used.
- The resizer cannot be used.
- The key frame delay mode cannot be used.

Restrictions on executing transitions in the transition control block

- DME wipes cannot be used.
- Wipes can be used, but there are restrictions on use. *For details, see the next item, “Restrictions when using wipes.”*

Restrictions when using wipes

- The wipe patterns that can be used are standard wipes (pattern numbers 1 to 24) only.
- A pattern mix cannot be used.
- A split (splitting the wipe pattern) cannot be used.
- When a border or soft border is selected for a wipe edge, the signal to be inserted in the edge (edge fill) is restricted as follows.
 - The utility 2 bus cannot be selected.
 - When using a matte, a mix color cannot be used.
 - Even if the wipe border width is set to the same numeric value for M/E and Simple P/P, the same image is not obtained.
- The following wipe modifiers cannot be used:
 - Replication “Shift” and Multi Adjust menu adjustments
 - Pairing
 - Modulation
 - Spring
 - Spiral
- Changing modifier parameter settings changes the wipe pattern size.

Restrictions on utility buses

The utility 1 and utility 2 buses cannot be used.

Assignment of signals to output connectors

Connectors to which the P/P row output signal assignment is fixed

The assignment of the following signals to output connectors OUT17 to OUT22 is fixed.

Output connector	Fixed assigned outputs		
	Standard mode	Multi-program mode	DSK mode ^{a)}
OUT17	Program	P/P OUT1 ^{b)}	Program 1
OUT18	Program	P/P OUT1 ^{b)}	Program 2
OUT19	Preview	P/P OUT2 ^{b)}	Key preview 1
OUT20	Clean	P/P OUT3 ^{b)}	Key preview 2
OUT21	Key preview	P/P OUT4 ^{b)}	Clean 1
OUT22	Preset	Preset	Clean 2

- a) In DSK mode, the backgrounds that can be selected in the PGM Config menu are restricted to background 1 and background 2.
b) Depends on the setting in the Engineering Setup >Switcher >Config >M/E Output Assign menu. OUT5 and OUT6 cannot be used.

Connectors for which a P/P row output signal can be selected

For an edit preview bus or AUX bus assigned to output connector OUT23 or OUT24, you can select a P/P row output signal.

If these buses are assigned to other than OUT23 or OUT24, then it is not possible to select a P/P row output signal. (Assigning these buses to the two connectors is recommended.)

Output connector	Assignable bus
OUT23	Edit preview bus
OUT24	AUX bus

Format converter output restrictions

On the MVS-8000G, the signal output from the format converter output connectors (FC1, FC2) can be assigned in either of the following ways.

- **Out#15-16:** Assignment fixed, signals OUT15 (for FC1), and OUT16 (for FC2).
- **Out#17-22:** Select from the OUT17 to OUT22 signals. (It is not, however, possible to select the same signal for FC1 and FC2.)

It is not possible to select FC1 and FC2 differently. For example, it is not possible to select “Out#15-16” for FC1 and “Out#17-22” for FC2.

FC3 and FC4 always have the same signals assigned: OUT39 and OUT40 respectively, and therefore it is not possible to select OUT17-OUT22.

Logical assignment of the physical PGM/PST

In the Engineering Setup >Switcher >Config >Logical M/E Assign menu, it is not possible to assign the physical PGM/PST as a logical PGM/PST.

In the <Logical M/E to Physical P/P> group, you can select from M/E-1, M/E-2, and M/E-3.

Multi Program 2

Overview

What is Multi Program 2?

By operating the switcher in Multi Program 2 mode, a single switcher mix/effects bank can be used to create two separate video outputs, referred to as “main” and “sub.” You can set backgrounds, keys, and transitions for each of main and sub. Keys 2 to 4, however, are common to main and sub. For example, immediately after a scene in baseball two versions of the scene can be provided as shown below, and switched simultaneously.

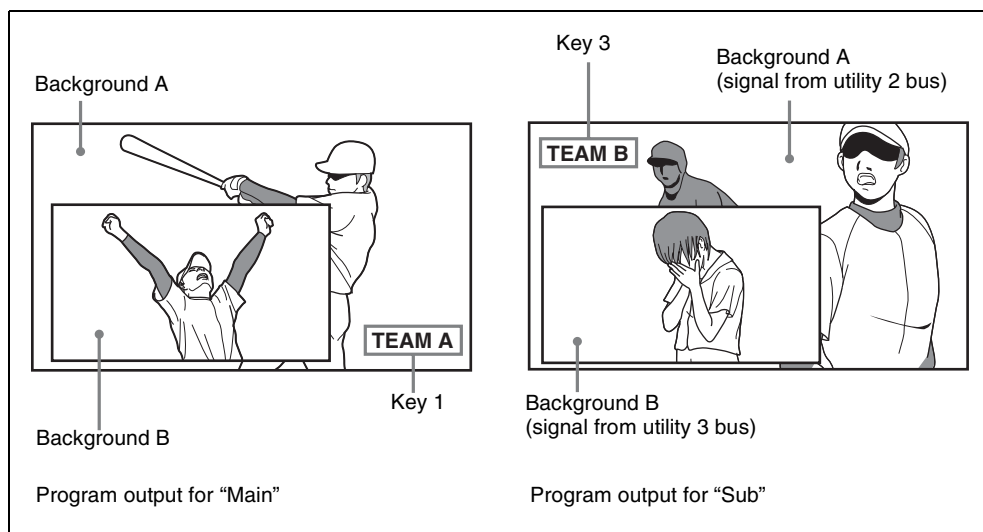

Note

The Multi Program 2 function is only supported on the MVS-8000A/8000G. To enable this function requires the BZS-8200 Multi Program 2 software. Depending on the CPU module, this function may not be supported. *For details, consult your Sony service representative or sales representative.*

Using the software

To use the Multi Program 2 software, you are required to enter an install key which validates the software. (If the software has been factory installed, the install key is not required.)

For the method of obtaining an install key, contact your Sony representative. To obtain a key, you may be required to submit the unique device ID of the switcher you are using. You can check the unique device ID in the Install menu of the switcher.

For details of the operation, see “Installation and Device Setup (Install/Unit Config Menu)” in Chapter 16 (Volume 2).

Assigning main and/or sub to switcher banks

For Multi Program 2 operations, a single switcher bank may be shared, and switched between main and sub, or two separate switcher banks may be used, each dedicated to main or sub.

Example 1: Assigning M/E-1 main and sub to a single switcher bank, and switching between them

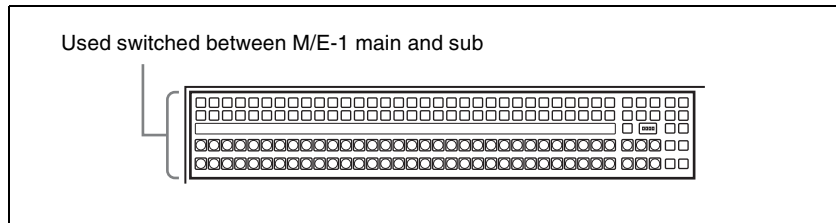

Example 2: Assigning separate switcher banks as “M/E-1 main dedicated” and “M/E-1 sub dedicated”

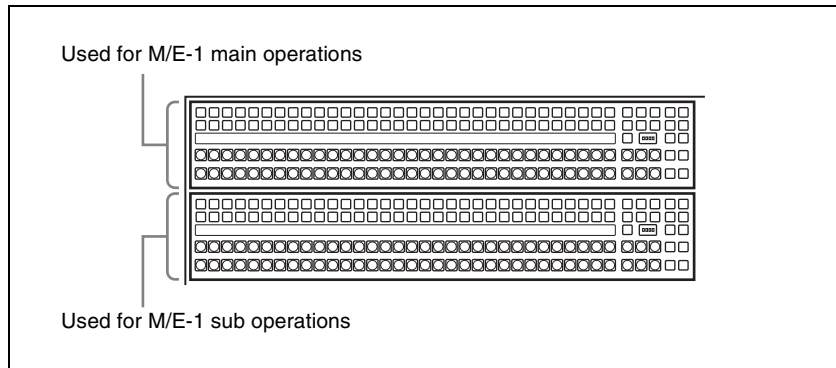

Video creation operations in Multi Program 2 mode

For each of main and sub, there are differences from the operations in standard mode.

For details, see “Differences Between Multi Program 2 Mode and Standard Mode” (page 242).

Sequence of Operations in Multi Program 2

Basic operation sequence

- Enter the BZS-8200 install key (first time only)
- ↓
- Set Multi Program 2 operating mode for each switcher bank
- ↓
- Assign output signals, and set the background configuration, key configuration, and key preview configuration
- ↓
- For each switcher bank, make a main/sub assignment (one of main dedicated, sub dedicated, and main and sub shared)
- ↓
- For a switcher bank assigned to main and sub shared, assign the [MAIN] and [SUB] delegation buttons
- ↓
- Create the main and sub images
- ↓
- Execute the transition

Optional operations

- Making cross-point settings
- Enabling DME wipe operations for sub
- Inhibiting utility 2 bus signal selection
- Including Multi Program 2 data in keyframes and snapshots
- Changing the key assignment for each output
- Assigning sub preview output to preview selection buttons in the fade-to-black control block
- Changing the matrix size to Standard
- Making settings for keyframe timeline operation

Basic Operations (Required)

Entering the BZS-8200 install key (first time only)

After installing the BZS-8200 Multi Program 2 software in the switcher, carry out the following procedure.

- 1 In the status area of the Engineering Setup >System >Install/Unit Config menu, select the switcher (SWRx), and press [License].
The License menu appears.
- 2 In the License menu, enter the BZS-8200 install key.
For details of the operation, see “Installation and Device Setup (Install/Unit Config Menu)” in Chapter 16 (Volume 2).
- 3 Shut down the menus. (*see page 333.*)
- 4 Power the switcher and SCU off and on again.

Setting the operating mode for each switcher bank

To set a desired switcher bank to Multi Program 2 mode, use the following procedure.

- 1 Display the Engineering Setup >Switcher >Config menu.
- 2 Select the switcher bank from M/E-1 to M/E-3, and P/P.
- 3 In the <M/E Config> group, select [Multi Program2].

Note

In the PGM/PST when using the simple P/P software (*see page 227*), [Multi Program2] cannot be selected.

- 4 Repeat steps 2 and 3 as required, to set the operating mode for all desired switcher banks.

Assigning output signals for Multi Program 2 mode

To assign signals to outputs

Use the Engineering Setup >Switcher >Config >M/E Output Assign menu. The difference from standard mode is that OUT1 is fixed, set to PGM1 (main program), and OUT6 is fixed, set to PGM2 (sub program), and that for the OUT2 to OUT5 signals you can assign any signal selected from the following.

PGM1, PGM2, PGM3, PGM4, PVW1, PVW2, K-PVW1, K-PVW2,
CLEAN, SUB CLEAN

Note

Each of main and sub can use a maximum of four of the six outputs (OUT1 to OUT6). The outputs can be used within the following limits.

- OUT1, OUT2: main only
- OUT3, OUT4: can be used for either main or sub
- OUT5, OUT6: sub only

For details, see “To assign the output of each bank in Multi Program mode” in Chapter 16 (Volume 2).

To set the background and key configuration

Use the Engineering Setup >Switcher >Config >PGM Config menu. The following are the differences from standard mode.

Background configuration: Consists of the following combinations.

- For main: Clean, Bkgd A, Bkgd B
- For sub: Sub Clean, Utility 2, Utility 3

Key configuration: Key1 can be set to “Enable” only when the background is Clean, Bkgd A, or Bkgd B.

For details, see “To set the output configuration for each bank” in Chapter 16 (Volume 2).

To set the key preview configuration

Use the Engineering Setup >Switcher >Config >K-PVW Config menu. The following are the differences from standard mode.

Background configuration: Clean or Sub Clean

Key configuration: Key1 can be set to “On” or “Link” only when the background is Clean.

For details, see “To set the key preview configuration” in Chapter 16 (Volume 2).

To assign sub outputs to output ports

Use the Engineering Setup >Switcher >Output >Output Assign menu. You can assign a sub output signal to a switcher output port number.

For details, see “Assigning output signals” in Chapter 16 (Volume 2).

Assigning main and/or sub to switcher banks

For each switcher bank for which Multi Program 2 mode is selected, set whether this is main dedicated, sub dedicated, or main and sub shared.

To assign main and sub to a single switcher bank

1 In the Engineering Setup >Panel >Config >MP2 Main/Sub Assign menu, select the switcher bank.

2 In the <Main/Sub Assign> group, select [Main&Sub].

Main: use for main operations.

Sub: use for sub operations.

Main&Sub: use for both main and sub operations.

When “Main&Sub” is selected, it is necessary to assign [MAIN] and [SUB] delegation buttons to the control panel.

To assign main and sub to two consecutive switcher banks

For example, to assign the first row (first switcher bank) to M/E-1 main, and the second row (second switcher bank) to M/E-1 sub, use the following procedure.

- 1** In the status area of the Engineering Setup >Panel >Config >MP2 Main/Sub Assign menu, select 1st Row (M/E-1), then press [Main] in the <Main/Sub Assign> group.
- 2** Press [Dual M/E Assign] to assign M/E to two banks.
In this state, both 1st Row and 2nd Row are set to main.
- 3** Set “2nd Row” to [Sub].
This cancels the shift/non-shift assignment for dual M/E in standard mode.

Note

It is not possible to assign the combinations of Main with Main&Sub, or Sub with Main&Sub.

Assigning the [MAIN] and [SUB] delegation buttons to buttons on the control panel

You can assign the [MAIN] and [SUB] delegation buttons to any of the following three places.

To assign to the pattern limit buttons (PTN LIMIT and LIMIT SET) in the transition control block (standard type)

For details of the transition control block (standard type), see page 260.

- 1** In the Engineering Setup >Panel >Config menu, press [Program Button].
The Program Button menu appears.
- 2** Press [Transition Module].
The Transition Module menu appears.



- 3 Select the switcher bank, then in the <PTN LIMIT/LIMIT SET/KF Button Assign> group, press [Main/Sub].

You can now use the [PTN LIMIT] button as [MAIN], and the [LIMIT SET] button as [SUB].

To assign to the wipe direction selection buttons (NORM and NORM REV) in the transition control block

This applies to a standard type and compact type transition control block.

For details of the transition control block (standard type), see page 260, and for details of the transition control block (compact type), see page 310.

- 1 In the Transition Module menu, select the switcher bank.
- 2 In the <NORM/NORM REV/REV Button Assign> group, press [Main/Sub].

You can now use the [NORM] button as [MAIN], and the [NORM/REV] button as [SUB].

To assign to macro buttons in the cross-point control block

For details of the cross-point control block, see page 256.

- 1 In the Engineering Setup >Panel >Config menu, press [Program Button].
The Program Button menu appears.
- 2 Press [Xpt Module].
The Xpt Module menu appears.
- 3 Select the switcher bank, then in the <PRE MCRO/POST MCRO> group, press [Main Sub].

You can now use the [PRE MCRO] button as [MAIN], and the [POST MCRO] button as [SUB].

To assign macro operations to different buttons

If in the above operation you assigned a Multi Program 2 function to the macro buttons, you can assign the PRE MCRO and POST MCRO functions to different buttons.

For details, see “Assigning functions to user preference buttons” or “Assigning a function to a memory recall button in the utility/shotbox control block” in Chapter 16 (Volume 2).

Examples of Operations in the Multi Program 2 Mode (When Sharing a Switcher Bank)

To create video on the M/E or PGM/PST bank assigned to both main and sub operations, use the following procedure.

- 1** Press the [MAIN] button, turning it on, and turning off the [SUB] button.
- 2** With the normal operations, create the main video.
- 3** Press the [SUB] button, turning it on, and turning off the [MAIN] button.
Now you can create the sub video.
- 4** Create the sub video.

The basic method of operation is the same as for the main video, except that the utility 2 bus signal is assigned to background A, and the utility 3 bus signal is assigned to background B.

For sub, only keys 2 to 4 can be used, and for wipes, standard wipe patterns only. There are also other differences in operation from standard mode.

For details, see “Differences Between Multi Program 2 Mode and Standard Mode” (page 242) and “Restrictions on Using Multi Program 2 Mode” (page 243).

- 5** Press the [MAIN] and [SUB] buttons simultaneously, turning them on.
If both buttons are lit, the control panel shows the status of main.
- 6** Carry out the transition.
Both main and sub video images are switched.

Optional Operations

Making cross-point settings

Cross-point assign tables can be set not only for main output but also for sub output.

You can set cross-point assign tables for the following banks.

M/E-1 SUB to M/E-3 SUB

P/P SUB

The table actually used is that for which the control panel delegation button is lit.

For details, see “Cross-Point Settings (Xpt Assign Menu)” in Chapter 16 (Volume 2).

Enabling DME wipe operations for sub

By factory default, DME wipe operations are inhibited for sub background. To enable them, in the Engineering Setup >Switcher >Config menu, set [DME Wipe Sub Enable] to On.

This enables DME wipe operations for sub background.

This setting applies to the whole control panel (all M/E banks and PGM/PST bank).

Note

If a DME wipe for sub is recalled in a snapshot or keyframe, the image will not be handled correctly.

Inhibiting utility 2 bus signal selection

In Multi Program 2 mode, you can inhibit other uses of the utility 2 bus signal in order to use the signal as the background for sub.

This setting applies to the whole control panel (all M/E banks and PGM/PST bank).

In the Engineering Setup >Panel >Config >MP2 Main/Sub Assign menu, set [Util2 Inhibit] to On.

This inhibits operations of selecting from the background B row while holding down the [UTIL] button in the cross-point control block.

Including Multi Program 2 data in recall operations of keyframes and snapshots

In the Engineering Setup >Switcher >Config menu, set [Recall M/E Config] to On.

When a keyframe or snapshot is stored or recalled, the following data is included.

M/E Config, PGM Config, M/E Output Assign, and Key PVW Config

For details of the above data, see “Setting the operating mode for each switcher bank” (page 233) and “Assigning output signals for Multi Program 2 mode” (page 233).

This setting applies to the whole control panel (all M/E banks and PGM/PST bank).

Note

M/E Config data is saved, even when this setting is Off.

Changing the key assignment for each output (Misc menu)

In Multi Program 2 mode you can change the key assignments independently. The following describes an example using M/E-1, but the operation is the same for other banks.

Notes

- This setting is linked to the setting in the Engineering Setup >Switcher > Config >PGM Config menu.
- It is not possible to make this setting while the above PGM Config menu is locked, or [Recall M/E Config] (*see previous item*) is set to Off.

1 In the M/E-1 menu, select first VF7 ‘Misc,’ then HF5 ‘Key Assign.’

The Key Assign menu appears, and the current key assignment is shown in the status area.

2 Change the setting in “Key Enable” as required.

Keys recalled in a snapshot recall

If a snapshot is recalled independently on main or sub, this only retrieves the settings for the key assigned to the recalled side. For example, if key 1 and key 2 are assigned on main, and key 3 and key 4 are assigned on sub, then if you recall a snapshot on main, this only retrieves the settings for key 1 and key 2, and the state of key 3 and key 4 assigned on sub is not affected.

Assigning sub preview output to preview selection buttons

You can assign the sub preview output to a preview selection button in the fade-to-black control block or downstream key/fade-to-black control block.

For details, see “Overall Control Panel Settings (Config Menu)” in Chapter 16 (Volume 2).

When the Multi Program 2 license is valid, by assigning the “Shift” function to a button, you can assign two preview outputs, “Shift” and “Unshift” to a single button. To use the shift output, always assign “Shift” to some button.

Changing the matrix size to Standard

When using a router, if the matrix size is set to [Compact (128×128)], it is not possible to control the utility 3 bus on the S-Bus. When using Multi Program 2, in the <Matrix Size> group of the Engineering Setup >Router/Tally >Router menu, select [Standard (136×138)].

For details, see “Assigning switcher inputs and outputs to S-Bus space” in Chapter 16 (Volume 2).

As for the bus number of the utility 3 bus, a DME Key bus number is used as follows.

No.	Bus (Standard)	Bus (MP2)
70	M/E-1 DME Key	M/E-1 Utility3
85	M/E-2 DME Key	M/E-2 Utility3
100	M/E-3 DME Key	M/E-3 Utility3
115	P/P DME Key	P/P Utility3

Making settings for timeline-related keyframe operations

To assign sub regions to the region selection buttons in the numeric keypad control block

In the Engineering Setup >Panel >Config >10 Key Region Assign menu, assign regions to the region selection buttons in the numeric keypad control block.

For details, see “Overall Control Panel Settings (Config Menu)” in Chapter 16 (Volume 2).

To make region and reference region selections using a menu

During snapshot or keyframe operations, you can select a region (including sub) in the Key Frame >Region Select menu. This is convenient for selecting some of the regions assigned to the numeric keypad control block or changing the reference region.

For details, see “Specifying the Region and Edit Points” in Chapter 13 (Volume 2).

To assign regions shown in the Timeline menu

You can select how regions assigned to region selection buttons appear in the Key Frame >Timeline menu.

For details, see “Setting the display of regions in the Timeline menu on or off” in Chapter 13 (Volume 2).

Enabling re-entry between the main and sub sides of the same M/E bank

In the Engineering Setup >Panel >Config menu, set [MP2 Free Re-Entry] to On.

Notes

- Re-entry adds a 1H delay to the video. Nested re-entry may lead to problems in the video.

- A maximum of eight re-entry stages are possible, with the final output having a delay of 4H.
- The selection order of re-entry signals affects the number of lines by which the output signal is lowered.
- If a delay occurs in the image, even when the through mode is set, the ancillary data does not pass through.
- For example, it is possible to select the re-entry of M/E-1 main on M/E-1 main.

Restrictions on Mutual Re-entry When Using Multi Program 2

The snapshot function is affected by this re-entry function.

When the [MP2 Free Re-Entry] button is On, and any of the switcher banks are in Multi Program 2 mode, then the following restrictions apply.

If you save and recall snapshots simultaneously with more than one region specified, the recorded state is played back in the order of precedence of regions (M/E-1 >M/E-2 >M/E-3 >P/P). Therefore, if you save and recall snapshots with more than one region specified, the cross-point settings may not be recalled correctly.

To recall the snapshots correctly, press the cross-point button before recalling the snapshots, to select a signal other than the re-entry signal, then recall the snapshots.

Functions Added in Multi Program 2 Mode

- You can set video processing for the utility 3 bus signal.
- In the control panel and DCU GPI input settings and switcher GPI link settings, the actions that can be selected now also include “Sub Cut” and “Sub Auto Trans.”
- A switcher GPI link can now be set also for the utility 3 bus.
- To the macro event configuration parameters and macro attachment settings, “Main & Sub” and “Sub” have been added.
- For cross-point button link settings, M/E-1 to M/E-3, and P/P “Sub Program,” “Sub Preset,” and “Sub Trans PGM” have been added to the link source bus.
- Snapshot attributes can now be set independently for main and sub.
- There are additional menus for sub which can be recalled by pressing a button twice.
- You can set [MP2 Auto Correct] to On or Off in the Effect menu or Snapshot menu. When this is set to On, for example, copy destination and source data is automatically recognized as main or sub, and the data interchanged.

Differences Between Multi Program 2 Mode and Standard Mode

The differences from operation in standard mode are as follows.

Item		Main	Sub
Keys ^{a)}		Keys 1 to 4 can be used	Keys 2 to 4 only can be used
Wipes (background)	Patterns	Same as standard mode	<ul style="list-style-type: none"> • Only standard patterns can be used • Pattern mix is not possible
	Modifiers	Same as standard mode	<ul style="list-style-type: none"> • Pairing, modulation, spring, spiral, and split cannot be used • Edge fill mattes are single-color only • Replication can be selected from four patterns
Wipes (key)		Same as wipes (background) for sub	
DME wipes	Use	Can be used	Cannot be used (Can be used, with a setting change)
	Patterns for 1 channel	For a dedicated interface, each of main and sub can be used. For the SDI interface, only one of main and sub can be used.	
	Patterns for 2 channels	Only one of main and sub can be used (For each M/E, the number of DMEs that can be used is the same as in standard mode.)	
	Patterns for 3 channels		
	Backgrounds	Wipe edge fill matte (including color mix and other settings in the Matte Adjust menu)	Wipe edge fill matte (single-color only)
	Modifiers	Same as standard mode	Wipe border colors are single-color only
Transitions	Key priority	Cannot be used	
	Transition preview	Cannot be used	
	Preset color mix	Color matte or video signal selected on the utility 2 bus	Color matte only
Snapshots	Cross-point hold	Utility 2 cannot be set	Utility 3 is added. BKGD A/B and Key1 cannot be set.
Control from an editor		Same as standard mode	Cannot be used

Item	Main	Sub
Operation setting for switcher GPI inputs and outputs	Same as standard mode	Cannot be used

a) Keys 2 to 4 are common to main and sub.

Notes

- Allow a transition to complete before carrying out main and sub delegation switching.
- The sub background A bus (utility 2 bus) is shared with wipe edge border fill. Making a change to one affects the other.
- Even if the wipe border width is set to the same numeric value for main and sub, the same image is not obtained.
- Changing the position of the wipe pattern for sub also changes the pattern size.

Restrictions on Using Multi Program 2 Mode

- The following functions are not available for sub:
 - Data copy and swap
 - Default recall (except for parametric recall)
 - M/E link
 - [TRANS] button function (*see page 268*)
 - [TRACE] button function (*see page 270*)
 - [AUTO] button function (*see page 309*)
- Re-entry is limited to four levels. Re-entry is not possible for main and sub of the same M/E.

However, this restriction can be removed. *For details, see “Enabling re-entry between the main and sub sides of the same M/E bank” (page 240).*
- In the following cases, a transition using the fader lever may not be performed correctly:
 - When the main and sub bus toggle modes are set differently
 - For a pattern mix, preset color mix, and so on
- For an Internal bus link, GPI link, or External bus link, the “Utility 2” bus cannot be selected.
- Screen aspect, show key, and [MCRO ATTCH ENBL] button settings are common to main and sub.
- If a snapshot is recalled simultaneously for main and sub, or a keyframe is executed simultaneously for main and sub, then for the following common to main and sub the main settings are reflected.
 - Key
 - M/E Config
 - DME external video bus and utility 1 bus



- When a macro attachment is set on the DME utility 1 bus or DME utility 2 bus, it is not possible to make separate main and sub settings.
- When snapshots with different M/E Config settings are recalled:
 - If M/E Config data is not to be included in the snapshot data, the current system settings are used for snapshot reproduction.
 - If M/E Config data is to be included in the snapshot data and if it was created before Version 5.30, then standard mode is used. If created in Version 5.30 or later, first M/E Config data is set, and then other snapshot data is recalled.
- The bus override function is only available on the following buses:
 - M/E-1 to M/E-3 Main BKGD A/B buses
 - M/E-1 to M/E-3 Sub BKGD A/B buses (UTIL-2, UTIL-3 buses)
 - P/P Main PGM/PST bus
 - P/P Sub PGM/PST buses (UTIL-2, UTIL-3 buses)
- When a master snapshot or master timeline is executed with a key being assigned to both main and sub, it is uncertain which data will be reflected.
- When recalling a master snapshot with different register numbers for main and sub, the recall timing may differ by one field or more between main and sub.
- The link state is maintained even when M/E Config is changed. Set the link setting again, as required.
- Since keys 2 to 4 are shared between main and sub, when the main and sub fader lever positions are different, if you move the fader lever, the video changes instantaneously to the value of the most recently moved fader lever.
- When the transition type for main or sub is set to preset color mix, it is not possible to carry out independent key transition operation (common to main and sub).

Dual Link Support

By installing the BZS-8560 switcher upgrade software in the MVS-8000G, or the BZDM-8560 DME upgrade software in the MVE-8000A, you can switch the signal format to 1080P/59.94 or 1080P/50. In this case, signal input/output uses a dual link ^{a)}.

a) Standard specified by SMPTE 372M-2002. One video signal is carried by two HD-SDI signals, allowing data with an increased frame rate to be carried.

Getting access to the software

To use the switcher upgrade software and DME upgrade software, you are required to enter an install key which validates the software. (If the software has been factory installed, the install key is not required.)

For the method of obtaining an install key, contact your Sony representative. On that occasion, you may be required to submit the unique device ID of the switcher you are using. You can check the unique device ID in the Install menu of the switcher. *For details of operating procedures, see Chapter 16, “Installation and Device Setup (Install/Unit Config Menu)” (Volume 2).*

Note

Switching the signal format to 1080P/59.94 or 1080P/50 requires the optional multi-format software.

For details of this software option, see page 189.

An MKS-8110G 17-input board and MKS-8160G 24-output board set are also required.

Setting the signal format to 1080P/59.94 or 1080P/50

You can switch the signal format to 1080P/59.94 or 1080P/50 in setup.

For details, see “Setting the Signal Format (Format Menu)” in Chapter 16 (Volume 2).

You can also switch the signal format with a GPI input.

For details, see the following sections of Chapter 16 (Volume 2), depending on the device.

- “Interfacing With External Devices (Device Interface Menu)” in “Setup Relating to Switcher Processor”

- “Interfacing With External Devices” in “Setup Relating to Operations From the Control Panel”
- “Interfacing With External Devices (Device Interface Menu)” in “Setup Relating to DME”
- “GPI Input Settings (GPI Input Assign Menu)” in “Setup Relating to DCU”
- The available input reference signals are as follows.

Signal format	Input reference signal		
	Tri Sync	Black burst	
1080P/59.94	59.94	Black Burst 59.94	Sync 59.94
1080P/50	50	Black Burst 50	Sync 50

Switching the signal type of DME output (video/key) assigned to a monitor signal

The function for switching the signal type of the monitor output (one channel) to video or key is assigned to one of the Prefs buttons of the Menu control block or one of the buttons of the Utility/Shotbox control block (DME MON KEY command).

For details of the assignment, see “Settings Button Assignment (Prefs/Utility Menu)” in Chapter 16 (Volume 2).

To switch the signal type of DME output (video/key) assigned to a monitor signal

Press the DME MON KEY command assigned button and turn it on to assign DME key output to a monitor signal. Then press the button and turn it off to assign DME video output to a monitor signal. For selection of the DME channels to be assigned to a monitor signal, see “Assigning a DME output signal as a monitor signal” (page 403) under “Applying a DME Effect to a Key” in Chapter 4.

Selecting the signal output from the DME monitor output connector

- 1 Display the Engineering Setup >DME >Output >Monitor Output menu.
- 2 Press [DME1] or [DME2] to select the DME to operate on.
- 3 On the left, select MONI OUT#1 or MONI OUT#3.
- 4 On the right, select the signal.

You can select any of Ch1 Video, Ch1 Key, Ch2 Video, and Ch2 Key.

5 Press [Set].

This assigns the signal.

Restrictions when using a dual link

When using a dual link, the switcher and DME resources are linked in duplex (link A and link B), resulting in the following restrictions.

Restrictions	Details
Functions that cannot be used in the system	Functions of the following items in the Engineering Setup >Switcher >Config menu Single Simul, Dual Simul
Functions that cannot be used in the switcher	<ul style="list-style-type: none">• Primary inputs numbers 41 to 80• Outputs number 25 to 48• Monitor buses 2/4/6/8• M/E-2 bank a)• M/E-3 bank• DME utility 1 and 2 buses• Color background 2 ^{b)}• Color corrector 2• Frame memory• Format converter• Functions of the following items in the Engineering Setup >Switcher >Config menu Switching Timing, M/E Config excluding Standard, and Logical M/E Assign
Functions that cannot be used on the DME	<ul style="list-style-type: none">• DME channels 3, 4, 7, and 8• Freeze in film mode• “Freeze Timing” in the following effects Input Freeze, Trail, Decay, KF Strobe (always set to Frame)• Brick• Editor ports 3 and 4 when the editor port operation mode is set to “Independent.”
Other restrictions	<ul style="list-style-type: none">• Auto chroma keying operates on the image of link A.• Tallies are generated for the link A signal.• Key frames are created in units of two frames.• It is not possible to change the interpolation method in the DME.

a) When the simple P/P software is not installed

b) When the switcher is a 2M/E system only



Chapter 2 Menus and Control Panel

Names and Functions of Parts of the Control Panel	251
Control Panel: Example Configuration 1 (With Standard Transition Modules)	251
Control Panel: Example Configuration 2 (With Simple Transition Modules)	252
Control Panel: Example Configuration 3 (With Compact Transition Modules)	255
Cross-Point Control Block	256
Transition Control Block (Standard Type)	260
Flexi Pad Control Block (Standard Type)	264
Key Control Block	267
Device Control Block (Trackball)	271
Device Control Block (Joystick)	277
Device Control Block (Search Dial)	278
Keyframe Control Block	281
Numeric Keypad Control Block	284
Fade to Black Control Block	287
Auxiliary Bus Control Block (for AUX Buses)	288
Auxiliary Bus Control Block (for Router Control)	291
Menu Control Block	294
Memory Card/USB Adaptor Block	295
“Memory Stick”/USB Connections Block	296
Utility/Shotbox Control Block	298
Transition Control Block and Flexi Pad Control Block (Simple Type) .. 299	299
Independent Key Transition Control Block (Simple Type)	304
Downstream Key Control Block	306
Downstream Key/Fade-to-Black Control Block	308
Transition Control Block (Compact Type)	310
Basic Menu Operations	313

Menu Organization	313
About the Top Menu List	313
Accessing Menus	314
Displaying a Menu	321
Interpreting the Menu Screen	322
Menu Operations	323
Switching Between the Main Menu Site and Subsidiary Menu Site	335
Shortcut Menu	335

Names and Functions of Parts of the Control Panel

Control Panel: Example Configuration 1 (With Standard Transition Modules)

The MVS-8000 system control panel comprises a number of modules. The following illustration shows a typical 32-button, 4-M/E configuration, with

standard transition modules used in the transition control block.

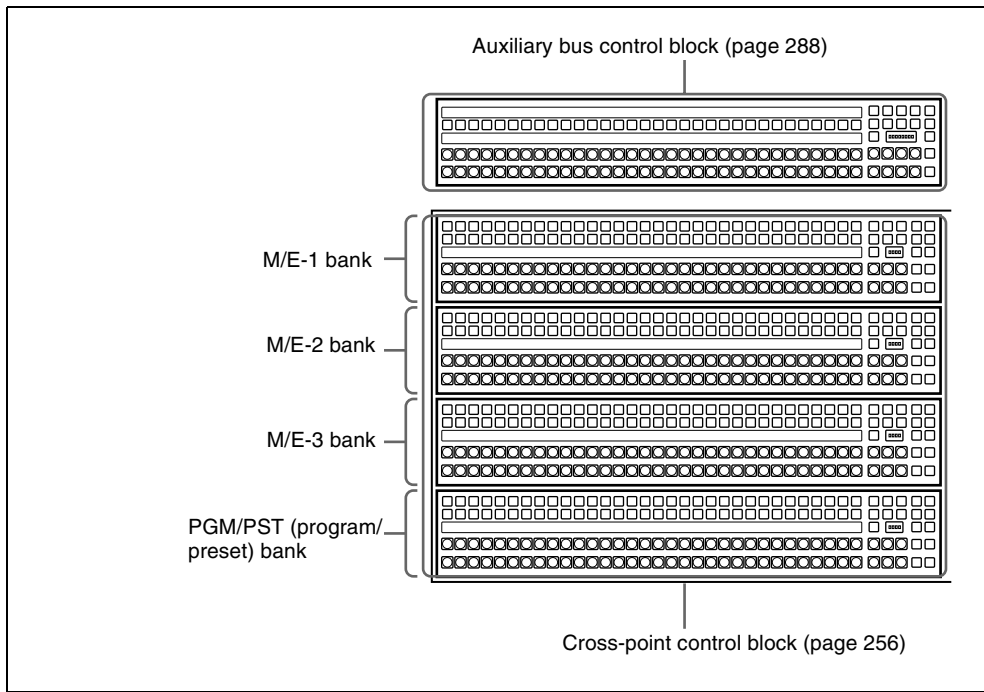

Control panel configuration 1 (left side)
(with standard transition modules)

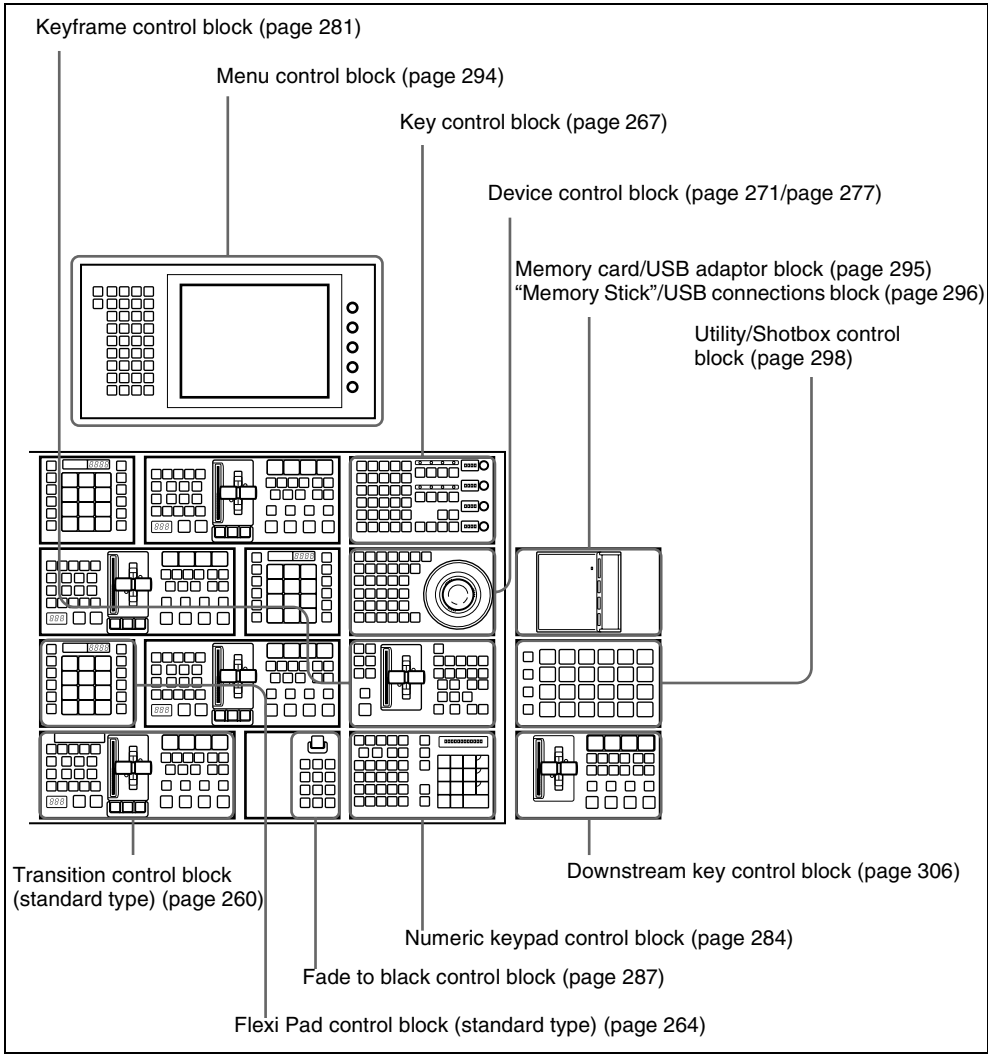

Control panel configuration 1 (right side)
(with standard transition modules)

Control Panel: Example Configuration 2 (With Simple Transition Modules)

The following illustration shows a typical configuration, with simple transition

modules used in the transition control block.

Except for the simple modules, this is the same configuration as in example configuration 1.

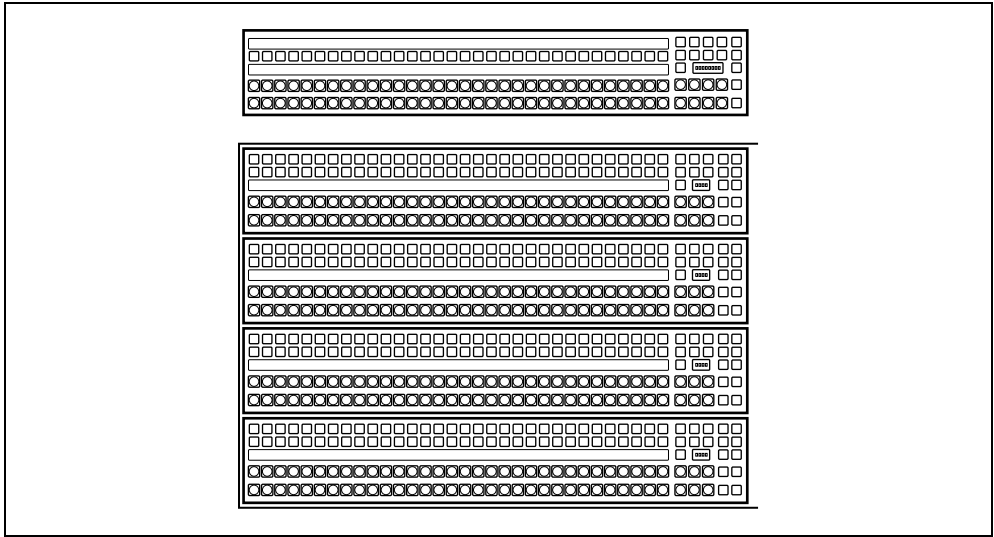

Control panel configuration 2 (left side)
(with simple transition modules)



Transition control block and Flexi Pad control block (simple type) (page 299)

Independent key transition control block (simple type) (page 304)

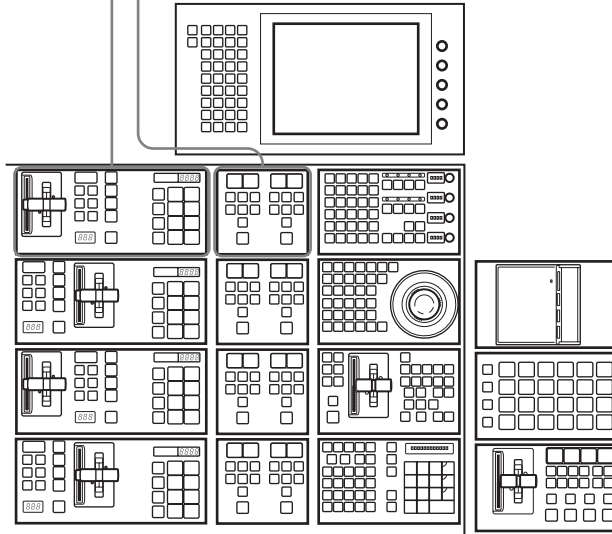

Control panel configuration 2 (right side)
(with simple transition modules)

Control Panel: Example Configuration 3 (With Compact Transition Modules)

The following illustration shows a typical configuration, with compact transition

modules used in the transition control block.

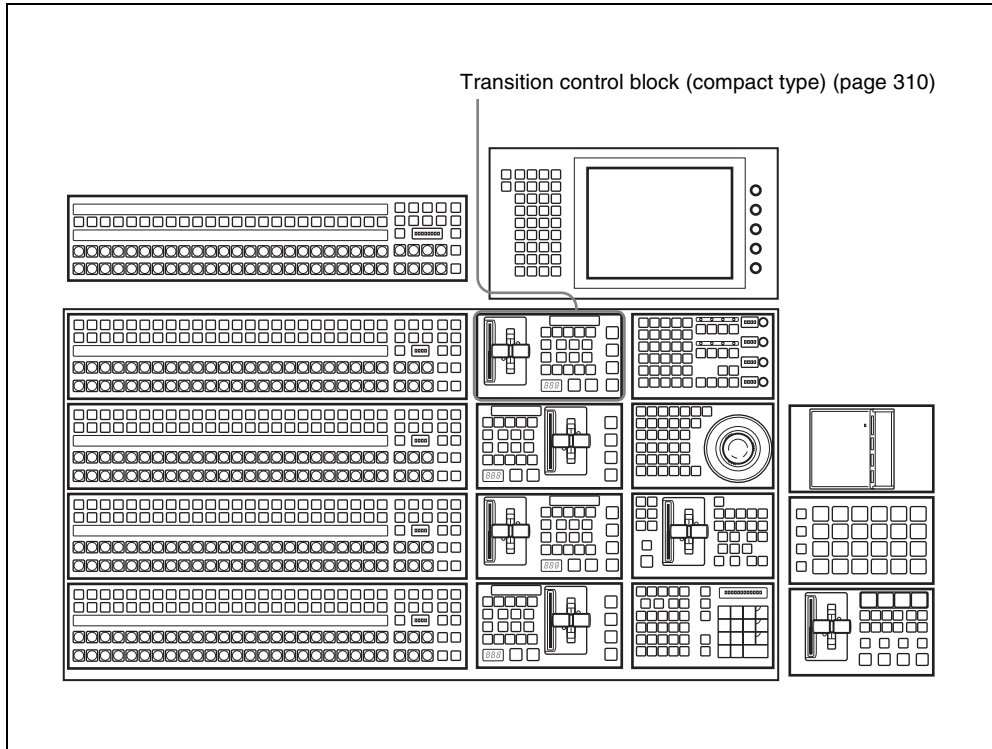

Control panel configuration 3
(with compact transition modules)



Cross-Point Control Block

In the cross-point control block, you can select the signals to be used in this M/E bank or PGM/PST bank.

There are also modules without the source name displays shown in the following figure.

All operations except those of the [SHIFT] button are the same as for a module with source name displays.

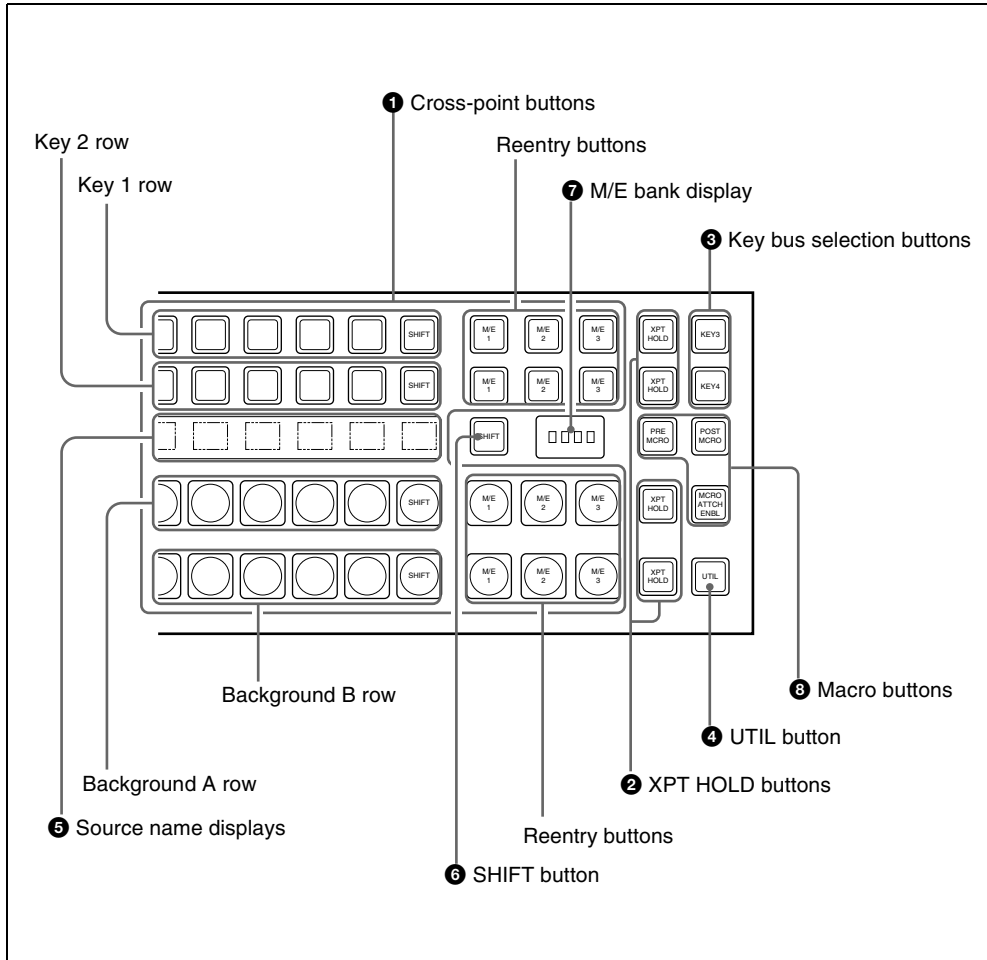

1 Cross-point buttons

These buttons select the signals used for video creation on this M/E bank or PGM/PST bank. Each row of buttons corresponds

to one or more signal buses within the switcher.

Key 1 row: The buttons in this row select the key 1 or key 3 signals to be inserted

into the video on this M/E bank or PGM/PST bank.

To select the key 1 fill signal, check that the right-hand [KEY3] button in the M/E bank (or the [DSK3] button in the PGM/PST bank) is off, then press the button assigned to the desired signal. To select the key 3 fill signal, press the [KEY3] button, turning it on. While the [UTIL] button on the right hand side is held down, these buttons are assigned to the DME external video bus allowing you to select the signal on that bus.

Key 2 row: The buttons in this row select the key 2 or key 4 signals to be inserted into the video on this M/E bank or PGM/PST bank.

To select the key 2 fill signal, check that the right-hand [KEY4] button in the M/E bank (or the [DSK4] button in the PGM/PST bank) is off, then press the button assigned to the desired signal. To select the key 4 fill signal, press the [KEY4] button, turning it on. While the [UTIL] button on the right hand side is held down, these buttons are assigned to the DME utility 1 or 2 bus as follows.

- When the [KEY4] button is off, holding down the [UTIL] button assigns these buttons to the DME utility 1 bus.
- Holding down the [UTIL] button and pressing the [KEY4] button, turning it on, assigns these buttons to the DME utility 2 bus.

Background A row: Press the desired button to select the signal as the current background video on this M/E bank or PGM/PST bank.

While the [UTIL] button on the right hand side is held down in Hold mode, these buttons are assigned to the utility 1 bus, and can be used to select the signal on that bus.

Background B row: Press the desired button to select the signal as the background after the next transition on this M/E bank or PGM/PST bank. While the [UTIL] button on the right hand side is held down in Hold mode, these buttons are assigned to the utility 2 bus, and can be used to select the signal on that bus.

Reentry buttons: These allow you to select the video created on another bank as background A or B or one of the keys 1 to 4. For example, to use the video created on the M/E-1 bank as background B on the M/E-2 bank, press the reentry button [M/E 1] in the background B row of buttons on the M/E-2 bank.

Cross-point button numbers

This description applies to the example of a 32-button system.

From the left, the first 31 buttons are numbered 1, 2, ... 30, 31. When the 32nd button is set to be a [SHIFT] button, these buttons can also be switched to select signals numbered from 32 to 62. While the [SHIFT] button is held down, these switch to numbers 32 to 62, or alternatively, every time the button is pressed, switching is made between numbers 1 to 31 and 32 to 62. Similarly, the reentry buttons can be switched between two sets of numbers: 121 to 123, and 125 to 127.

Both the assignment of the 32nd button to a [SHIFT] button and the selection of the button operation mode can be done in a Setup menu.

Assigning signals to button

You can assign a signal to each button using the Setup menu.

This assignment is common to the cross-point buttons in the M/E-1, M/E-2, M/E-3, and PGM/PST banks, and the auxiliary bus



control block. According to the settings made in the menu, the video and key signals are assigned to the cross-point buttons in pairs.

You can also make separate signal assignments for each operating control block.

Visual indications on cross-point buttons

The currently selected button in a row (i.e. the last button pressed) lights amber or red.

Amber (“low tally”): The signal selected on the bus does not form part of the program output from the switcher.

Red (“high tally”): The signal selected on the bus forms part of the program output from the switcher.

2 XPT (cross-point) HOLD buttons

Turning one of these buttons on enables you to recall a keyframe or snapshot while keeping the current cross-point selection unchanged.

When the [XPT HOLD] button in the key 1 or key 2 row is on, then the operation is as follows, depending on the setting in the Setup menu.

When the panel setup is “Normal”: The operation is as follows, depending on the setting in switcher setup.

Key Disable: The snapshot or keyframe is recalled without changing the current key settings.

Key Disable with Status: The snapshot or key frame is recalled without changing the current key settings, including the on/off status.

Xpt Hold: The snapshot or keyframe is recalled without changing the current cross-point selection.

When the panel setup is “Protect”: The cross-point settings cannot be changed by pressing panel buttons.

3 Key bus selection buttons

KEY3 button: Press this button, turning it on, to assign the key 1 cross-point buttons to the key 3 fill bus.

KEY4 button: Press this button, turning it on, to assign the key 2 cross-point buttons to the key 4 fill bus.

Pressing one of the key delegation buttons [KEY1] to [KEY4] in the transition control block (standard type) twice in rapid succession changes the state of the corresponding one of these buttons, so that you can make cross-point selections on the key bus (*see page 263*).

4 UTIL (utility) button

While this button is held down, the cross-point buttons are assigned to the following buses, respectively.

Background A row: utility 1 bus

Background B row: utility 2 bus

Key 1 row: DME external video bus

Key 2 row: DME utility 1 bus when the [KEY4] button is off, or DME utility 2 bus when the [KEY4] button is lit.

In a Setup menu, you can select either of the following two modes for these buttons.

- The button takes effect while being held down.
- Every time the button is pressed, it toggles between the on and off states for key 1 and key 2 rows. For background A and background B rows, utility buses remain disabled.

5 Source name displays

These show the names of the signals which can be selected on the cross-point buttons, in two or four characters, or in auto mode. While the [SHIFT] button on the right hand side or the [SHIFT] button assigned to the column of cross-point buttons is enabled, the source name of the signal assigned to the column of cross-point buttons in shift mode appears. You can select green, orange, or yellow for the background color

of the source name display, for each source separately. You can set the source name display mode and background color in a Setup menu.

6 SHIFT button

When this button is enabled, either the source name displays show the shifted signal names, or the shifted signals for all buses in this M/E (P/P) bank are enabled. You can select either mode in a Setup menu.

Each press of the button toggles between the enabled and disabled states.

In the case of a module without source name displays, when “Display” is selected in the Setup menu, this button is invalid.

7 M/E bank display

This indicates the notional mix/effect bank name to which the particular M/E or PGM/PST bank is assigned, as a four-character identifier.

8 Macro buttons

PRE MCRO (pre macro) button: Use this button to set a macro attachment in pre macro mode. For setting in macro only mode, use this in combination with a macro only set button assigned to the utility/shotbox control block or a user preference button. Alternatively, without using the button, you can make the selection simply, by pressing simultaneously with the [POST MCRO] button.

When dual background bus mode is selected in setup, this switches the dual background bus mode on and off.

When set to utility/shotbox mode, this enables and disables the use of the key 2 row as a utility/shotbox.

If in setup this is assigned to the function for disabling cross-point button operations, then it enables or disables cross-point button operations.

POST MCRO (post macro) button: Use this button to set a macro attachment in post macro mode. For setting in macro only mode, use this in combination with a macro only set button assigned to the utility/shotbox control block or a user preference button. Alternatively, without using the button, you can make the selection simply, by pressing simultaneously with the [PRE MCRO] button.

When dual background bus mode or utility/shotbox mode is selected in setup, this button is disabled.

If in setup the function for disabling cross-point button operations is assigned to the [PRE MCRO] button, then this button is disabled.

MCRO ATTCH ENBL (macro

attachment enable) button: When this button is on, the macro attachments set for the buttons of the M/E bank are enabled.

Transition Control Block (Standard Type)

In the transition control block, you can modify the output of the M/E bank or PGM/PST bank, and perform transitions. Both

common transition and independent key transition operations are possible.

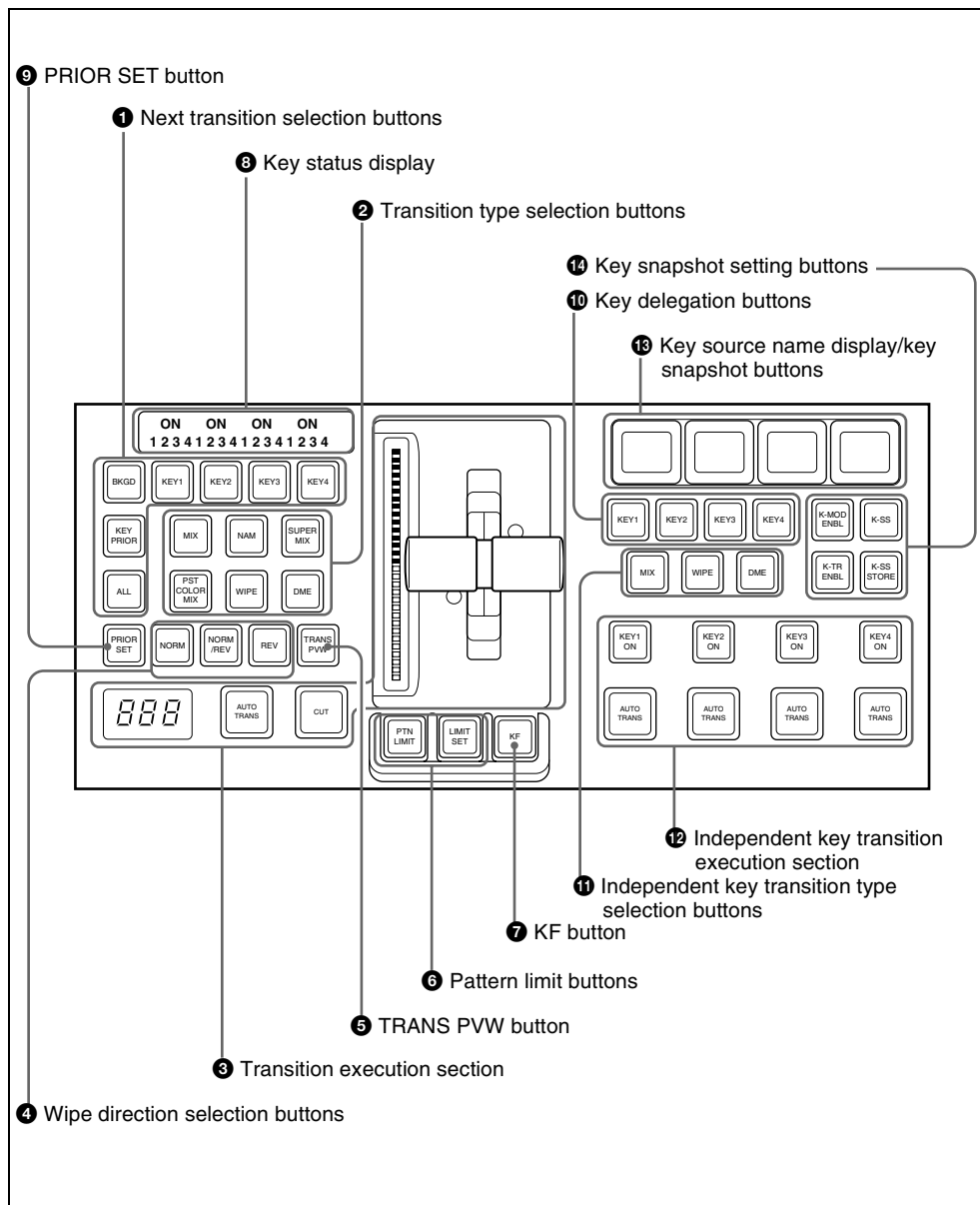



❶ Next transition selection buttons

Press these buttons, turning them on, to determine what the next transition will apply to.

BKGD: Next transition changes the background.

KEY1 to KEY4 (DSK1 to DSK4 in the PGM/PST bank): Press this button, turning it on, to make the next transition insert or remove the corresponding key (keys 1 to 4). If a key is currently inserted it will be removed, and vice versa.

In the PGM/PST bank, this inserts or removes downstream keys 1 to 4.

KEY PRIOR (priority): When this button is lit, the setting of the key priority after the next transition is enabled. The key priority after the next transition appears in the key status display.

ALL: Pressing this button turns on a preselected set of the [BKGD], [KEY1] to [KEY4], and [KEY PRIOR] buttons. Make this setting in a Setup menu.

❷ Transition type selection buttons

You can assign these buttons in setup to any transition type (see “Overall Control Panel Settings (Config Menu)” in Chapter 16 (Volume 2)).

Press one of these buttons, turning it on, to determine the type of the next transition.

When multi-program mode is selected in the Setup menu (see “Settings for Switcher Configuration (Config Menu)” in Chapter 16 (Volume 2)), two or more of the following buttons may light.

MIX: In a background transition, the new video fades in as the current video fades out. During the transition, the overall signal level is maintained at 100%.

In a key transition, the key fades in (for insertion) or out (for removal).

NAM (non-additive mix): The current and new video signals are compared, and

the signal with the higher luminance level is given priority in the output. The current video is maintained at 100% output for the first half of the transition as the new video increases progressively to 100%, then the current video is progressively reduced from 100% to zero in the second half while the new video is maintained at 100%.

SUPER MIX: The current video is maintained at 100% output for the first half of the transition as the new video is mixed while increasing progressively to 100%. The current video is then progressively reduced from 100% to zero in the second half while the new video is maintained at 100%.

PST (preset) COLOR MIX: In the first transition, the current video is replaced by the color matte in a mix (dissolve), then in the second transition the color matte is replaced by the new video also in a mix (dissolve).

In place of a color matte, you can select any signal on the utility 2 bus.

WIPE: The current video is replaced by the new video, using the wipe pattern selected in the Wipe menu.

DME: A wipe type of transition is carried out, using the DME effect selected in the DME Wipe menu.

FM1&2CIIP, FM3&4CIIP, FM5&6CIIP,

FM7&8CIIP: A recorded clip is played back together with the transition. At this point, you can also carry out a transition (wipe or mix (dissolve)) simultaneously together with the clip.

❸ Transition execution section

Transition indicator: This comprises multiple LEDs, which show the progress of the transition.

Fader lever: Move this to carry out a manual transition. Pressing the [KF]

button to turn it on allows you to use this as a key frame fader.

Transition rate display: This shows the “transition rate” (the time from the beginning of a transition to its completion) set for an auto transition, in frames.

You can set the transition rate using the numeric keypad control block, Flexi Pad control block, or menu.

AUTO TRANS (transition) button:

Pressing this button carries out an auto transition of the set transition rate (duration). The transition starts immediately, and the button lights amber. When the transition completes, the button goes off.

CUT button: Pressing this button carries out the transition as a cut (i.e. instantaneously).

4 Wipe direction selection buttons

When you have selected a wipe or DME wipe as the transition type, press one of these buttons, turning it on, to select the wipe direction.

NORM (normal): The wipe proceeds in the direction from black to white as shown on the pattern in the lists of patterns *see “Wipe Pattern List” (page 560) and “DME Wipe Pattern List” (page 566) in Appendix (Volume 1),* or in the direction of the arrow.

When the VTR/disk recorder/frame memory operation mode is enabled in setup, pressing this button plays the tape.

REV (reverse): The wipe proceeds in the opposite direction to that when the [NORM] button is pressed. When the VTR/disk recorder/frame memory operation mode is enabled in setup, pressing this button cues the tape automatically to the start point.

NORM/REV (normal/reverse): The wipe direction alternates between normal

and reverse every time a transition is executed.

When the VTR/disk recorder/frame memory operation mode is enabled in setup, pressing this button stops the tape.

5 TRANS PVW (transition preview) button

When this button is lit, you can check in advance the video changes during the transition, on the preview output from the M/E or PGM/PST bank.

During the preview, you can use the fader lever, [AUTO TRANS] button, and [CUT] button. One of the following functions of this button can be selected in a Setup mode.

- When the transition completes, the system returns to the normal mode.
- The transition preview mode is maintained while this button is pressed.
- Switching is made between the transition preview mode and normal mode every time this button is pressed.

6 Pattern limit buttons

PTN (pattern) LIMIT: Pressing this button, turning it on, enables the pattern limit function.

When the VTR/disk recorder/frame memory operation mode is enabled in setup, pressing this button plays the tape.

LIMIT SET: Use this button to set a pattern limit when the [PTN LIMIT] button is off.

Move the fader lever to the position of a particular pattern size, and stop it there, then press this button to set the pattern limit range.

When the VTR/disk recorder/frame memory operation mode is enabled in setup, pressing this button stops the tape.



7 KF (keyframe) button

When the VTR/disk recorder/frame memory operation mode is enabled in setup, pressing this button cues the tape automatically to the start point. When not, pressing this button to turn it on allows you to use the fader lever as a key frame fader.

8 Key status display

For each of keys 1 to 4, the corresponding ON indicator lights when the key is inserted. It also shows the priority (1 to 4) of each key.

9 PRIOR (priority) SET button

While this button is held down, you can set the key priority.

The setting mode when this button is pressed depends on whether or not the [KEY PRIOR] button is lit, as follows.

- When the [KEY PRIOR] button is off, the current key priority is set.
 - When the [KEY PRIOR] button is lit, the key priority after the next transition is set.
- Press the [KEY PRIOR] button as required, to switch between these two modes.

In either mode, hold down the [PRIOR SET] button, and press the button ([KEY1] to [KEY4]) corresponding to the key you want to bring to the front.

The following controls are used as the independent key transition control block.

10 Key delegation buttons

These buttons delegate this independent key transition control block to a desired keyer. Press one of the [KEY1] to [KEY4] buttons ([DSK1] to [DSK4] in the PGM/PST bank), turning it on.

You can press more than one button to select two or more keyers. While these buttons are held down, you can select a key source with the cross-point buttons for the key bus.

Pressing one of these buttons twice in rapid succession changes its state so that you can make cross-point selections on the corresponding key bus.

Key delegation button (double press)	Corresponding key bus
[KEY1]	key 1 ^{a)}
[KEY2]	key 2 ^{b)}
[KEY3]	key 3 ^{c)}
[KEY4]	key 4 ^{d)}

- The key bus selection button [KEY3] in the cross-point control block goes off.
- The key bus selection button [KEY4] in the cross-point control block goes off.
- The key bus selection button [KEY3] in the cross-point control block lights.
- The key bus selection button [KEY4] in the cross-point control block lights.

11 Independent key transition type selection buttons

Press one of the following buttons, turning it on, to select the independent key transition type.

MIX: Faded in or out.

WIPE: Inserted or deleted with a wipe.

DME (DME wipe): Inserted or deleted with a DME wipe.

12 Independent key transition execution section

KEY1 ON to KEY4 ON (DSK1 ON to DSK4 ON in the PGM/PST bank)

buttons: Press the corresponding one of these buttons to cut key 1 to key 4 in or out instantaneously. When the key corresponding to the button appears in the final program output, the button lights red, and otherwise lights amber.

AUTO TRANS (transition) buttons:

These correspond to keys 1 to 4 from left to right; press one to carry out an auto transition. The transition rate for an independent key transition can be

set in the numeric keypad control block, in the Flexi Pad control block, or in a menu.

13 Key source name display/key snapshot buttons

These display the source name selected on the corresponding keyer. In key snapshot mode, press these buttons, corresponding to registers 1 to 4 for the selected keyer, to save or recall a key snapshot.

14 Key snapshot setting buttons

K-SS (key snapshot): This enables key snapshot mode.

K-SS STORE (key snapshot store): To save a key snapshot, hold down this button, and press the key source name display/key snapshot button corresponding to the register you want to save.

K-MOD ENBL (key modifier enable): To recall key adjustment values and key modifier settings when recalling a key snapshot, press this button, turning it on.

K-TR ENBL (key transition enable): To recall independent key transition settings when recalling a key snapshot, press this button, turning it on.

Flexi Pad Control Block (Standard Type)

The Flexi Pad control block is used for saving and recalling wipe snapshots, DME wipe snapshots, and snapshots, for recalling effects, and shotbox content, and for entering the transition rate.



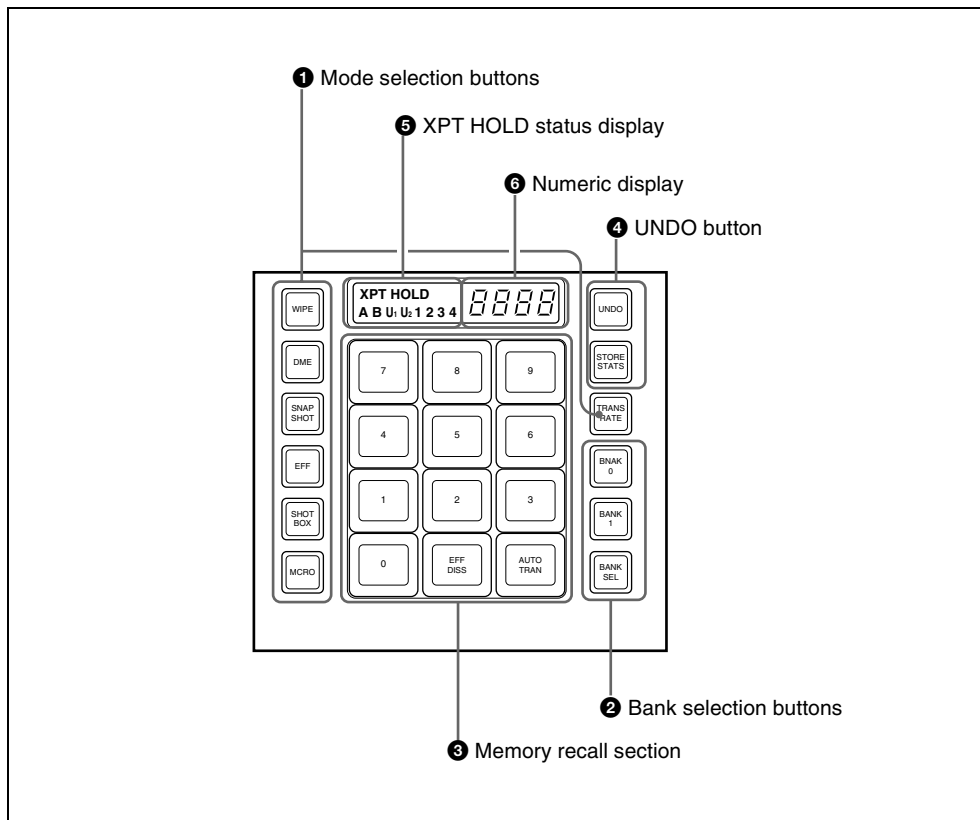

1 Mode selection buttons

WIPE: To save or recall a wipe snapshot, or recall the pattern number of a wipe pattern, use this in combination with the buttons of the memory recall section.

DME: To save or recall a DME wipe snapshot, or recall the pattern number of a DME wipe pattern, use this in combination with the buttons of the memory recall section.

SNAPSHOT: To save or recall a snapshot, use this in combination with the buttons of the memory recall section.

EFF (effect): To recall the master timeline or run an effect, use this in combination with the buttons in the memory recall section.

SHOTBOX: To recall or execute a shotbox, use this in combination with the buttons of the memory recall section.

MCRO (macro): To save, recall or edit a macro, use this in combination with the buttons of the memory recall section.

TRANS RATE (transition rate): To enter the transition rate, press this button, turning it on. To enter the independent key transition rate, hold down this button, and press the key delegation button in the independent key transition control block. To select whether the value is entered in frames or as a timecode value, switch the [TC] button in the memory recall section on or off.



② Bank selection buttons

BANK0 (bank 0): Assigns the memory recall section to bank 0, of registers 1 to 10.

BANK1 (bank 1): Assigns the memory recall section to bank 1, of registers 11 to 20.

BANK SEL (bank selection): After pressing this button, press a button in the memory recall section to select banks 0 to 9.

③ Memory recall section

This consists of 12 buttons with LCDs. These display changes, according to various operation modes.

④ UNDO button

UNDO: After recalling a register, press this button to return to the state before recalling the register.

When contents have been saved to a register, hold down the [STORE STATS] button and press this button to return the register to its state before the save operation.

STORE STATS (store status): When a save or delete operation has been carried out on a register, this button lights amber. After saving to a register, hold down this button and press the relevant register button to delete the data in the register. Again, after a save operation on a register, hold down this button and press the [UNDO] button to restore the register to its state before the save operation.

⑤ XPT HOLD (cross-point hold) status display

A bus for which cross-point hold is set appears as a green light.

⑥ Numeric display

Depending on the operation mode, this shows the pattern number of a wipe or

DME wipe, a bank number, a register number, a transition rate, and so on in up to four digits.

Key Control Block

Each of the M/E banks and the PGM/PST bank includes four keys (for keys 1 to 4), and you can delegate this control block to

any desired keyer. In this control block, you can adjust and modify keys.

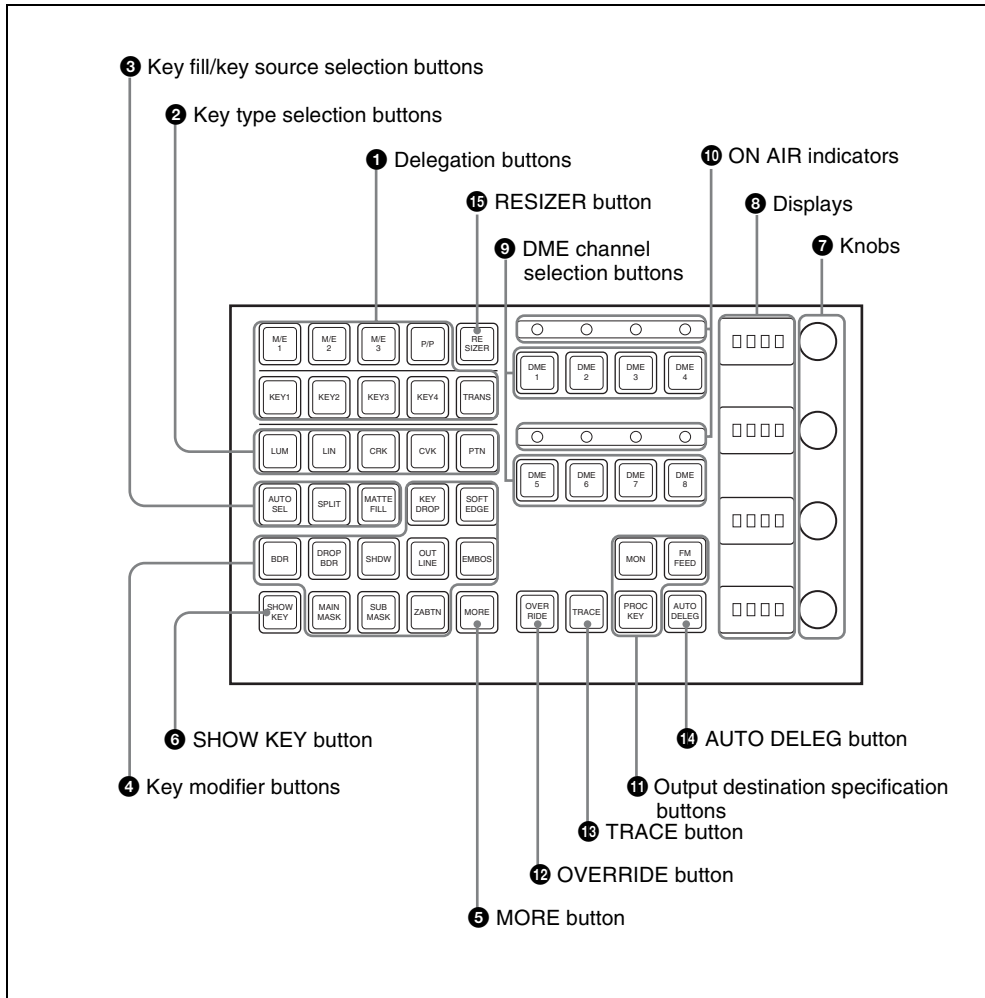

1 Delegation buttons

Key delegation: Press one of the [KEY1] to [KEY4] buttons to delegate the key control block to the corresponding keyer.

M/E delegation: Press one of the [M/E 1] to [M/E 3], and [P/P] buttons to select the bank (an M/E bank or the PGM/PST bank) to which the key control block is delegated.



TRANS: By pressing this button, you can check the DME channel used for DME wipes on the M/E or PGM/PST bank. Also, by pressing this button, then pressing one of the DME channel selection buttons, you can preset the DME channel to be used when a DME wipe is selected as the transition type for the next transition.

When presetting the DME channel for an independent key transition, hold down this button, then press one of the [KEY1] to [KEY4] buttons, turning the two buttons on, beforehand.

② Key type selection buttons

Press one of these buttons, turning it on, to select the desired key type.

Depending on the selected key type, various parameters are displayed, and you can set the values with the knobs.

LUM (luminance key): The background is cut out according to the luminance (Y) of the key source signal, and at the same time the key fill signal is cut out and then added to the background signal.

LIN (linear key): This is a type of luminance key with a reduced variation in gain and a higher adjustment precision.

CRK (chroma key): A particular hue (usually blue) in the key source signal is used to determine the hole to be cut in the background and filled with the key fill signal.

CVK (color vector key): The background is cut out with a key source created by adding the luminance and chrominance components of the key signal. If the saturation is high, this allows perfect keying even if the luminance level is low and the signal is not suitable for luminance keying.

PTN (wipe pattern key): A hole is cut in the background by a wipe pattern

selected in the transition, and this is filled with the key fill signal.

③ Key fill/key source selection buttons

AUTO SEL (selection): Use the signal selected on the key fill bus, and the paired key source signal. The setting of key fill and key source pairs is carried out in a Setup menu.

SPLIT: To use the signal selected on the key fill bus as key fill, and a signal separate from the signal assigned in a pair with key fill for key source, press this button, turning it on.

To select the signal on the key source bus, hold down this button, and press a button in the key 1 or key 2 row in the cross-point control block.

To use the signal selected on the key fill bus as key source (self keying), press the [AUTO SEL] button and [SPLIT] button at the same time, so that both are off.

MATTE FILL: To use a color matte from the internal generator as key fill, press this button, turning it on. You can adjust the color matte using the knobs. When this button is off, the signal selected on the key fill bus is used as key fill.

④ Key modifier buttons

To add an edge modifier to the key, press one of these buttons, turning it on.

Depending on the edge type selected, parameters appear in the displays, and you can set the values with the knobs.

KEY DROP: When drop border or shadow is selected, turning this button on lowers the key fill and key source position by four or eight scan lines as set in the key menu.

To select 4H or 8H, use the Key menu. When the selected edge type is “normal” and soft edge is selected or when border, outline, or emboss is

selected, this button lights automatically.

BDR (border): Apply a border of a uniform thickness to the whole key.

DROP BDR (drop border): Apply a border to two sides of the key (for example, below and to the right, or below and to the left).

SHDW (shadow): Apply a shadow to two sides of the key (for example, below and to the right, or below and to the left).

OUTLINE: Use the outline of the key.

EMBOS (emboss): Apply an embossing effect to the periphery of the key.

- To select a “normal” as the edge type (that is, a plain edge), set all five of the above buttons off.
- When border, drop border, or shadow is selected, you can use a special color matte or a signal selected on the utility 1 bus for the edge.
- When emboss is selected, you can use the dedicated color matte signal for the emboss function.
- When outline is selected, the signal selected on the key fill bus is used to fill the edge.

MAIN MASK: Press this button, turning it on, to enable the key mask using the main pattern. It also enables you to set the parameters with the knobs.

SUB MASK: Press this button, turning it on, to enable the key mask using the sub pattern. It also enables you to set the parameters with the knobs.

ZABTN (zabton): When this is pressed, turning it on, a translucent pattern is inserted behind the key. With the knobs, you can adjust the color, size, density, and softness parameters.

SOFT EDGE: Soften the edge of the key.

5 MORE button

When there are more than four parameters, this button lights amber. When it is pressed,

it changes from amber to green and the fifth and subsequent parameters are assigned to the knobs, allowing them to be adjusted.

6 SHOW KEY button

While this button is held down, a key processed key source signal is output from the specified output port. You can make the output specification independently for each of edit preview and the preview of each M/E or PGM/PST bank in a Setup menu.

7 Knobs

Turn the knobs to adjust the parameter values.

8 Displays

Each display shows the initial letters of the parameter name and the parameter value (maximum three digits including a minus sign for a negative value).

9 DME channel selection buttons

Press one of these buttons, turning it on, to delegate a DME channel to the keyer. The number of valid DME channel selection buttons depends on the number of channels installed in the DME processor.

A maximum of four consecutively numbered DME channels from the two sets, DME 1 to 4 and DME 5 to 8, can be assigned to one keyer. A DME channel assigned to a keyer cannot be selected on another keyer. However, using the override function it is possible to allocate a channel already allocated to another keyer to the currently selected keyer. If DME channel allocations have been made in a Setup menu, these buttons cannot be used to make DME channel allocations. Using the trace function, it is possible to check which keyer a DME channel is allocated to.



10 ON AIR indicators

These light red when the corresponding DME channels are included in the final program output.

11 Output destination specification buttons

MON (DME monitor): Hold down this button and press the selection button for the DME channel you want to assign to the monitor output; you can then monitor the output signal on the DME monitor output.

While this button is held down, the DME channel selection buttons light as follows, allowing you to check the monitor assignment.

Lit amber: DME channel that can currently be monitored

Lit green: DME channel currently assigned to the monitor output

FM FEED (frame memory feed): When you press this button, it lights momentarily amber, then for the currently selected keyer, the key processed signals are selected for frame memory sources 1 and 2. If a DME is selected on the currently selected keyer, the key fill and key source signals to which a DME effect is applied are assigned to frame memory sources 1 and 2; otherwise the key fill and key source are assigned.

Carrying out a frame memory feed causes the [PROC KEY] button to light amber.

PROC KEY (processed key): When this button is on, the key fill/source signal subjected to key processing or signal subjected to a DME effect on the currently selected keyer can be selected as a reentry signal (PROC V or PROC K) for the M/E or PGM/PST bank, on the auxiliary bus or the like.

12 OVERRIDE button

To select a DME channel already allocated to another keyer or transition to the currently selected keyer (or transition), hold down this button, and press the DME channel selection button.

13 TRACE button

When a DME channel is already allocated to another keyer or transition, hold down this button, and press the corresponding DME channel selection button, to switch to the state in which the keyer (or transition) to which the DME channel is allocated is currently selected.

14 AUTO DELEG (auto delegation) button

When this button is on, the key delegation selection state of the key control block is linked to the key delegation selection state of the independent key transition control block.

15 RESIZER button

Enables or disables resizer on the MVS-8000G.

For details on resizer, see page 419.

Device Control Block (Trackball)

The description below of frame memory clip operations applies only to the MVS-8000A/8000G.

The device control block is used for three-dimensional transform operations using a

DME, for wipe pattern position setting, and for VTR/disk recorder/frame memory clip operation.

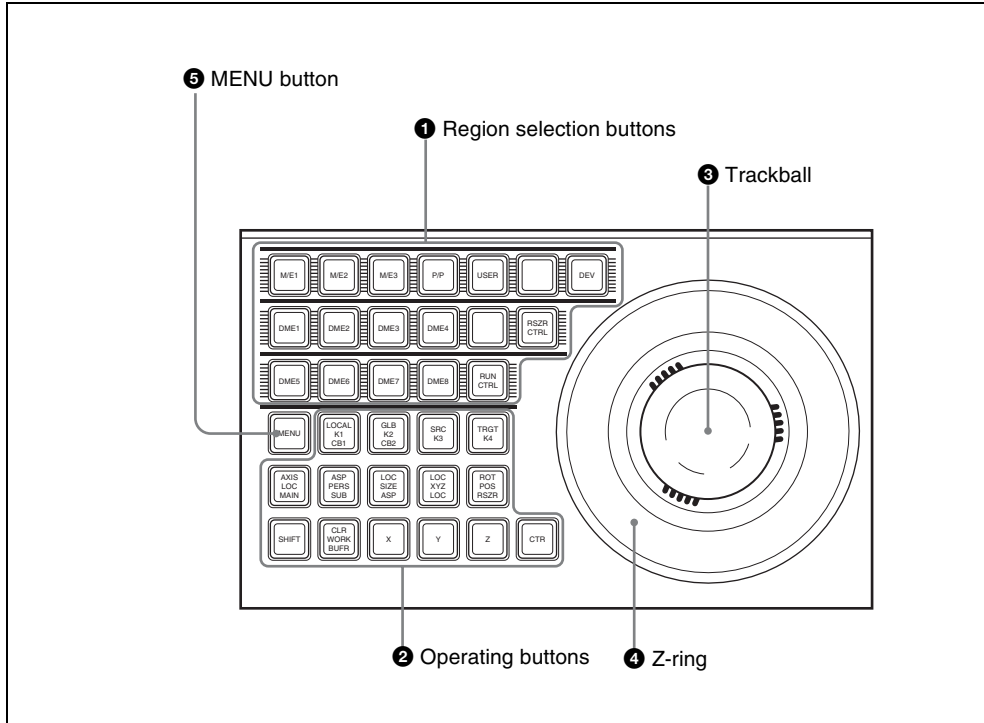

1 Region selection buttons

The operation mode allocated to the device control block depends on the selection state of the region selection buttons.

When the [M/E 1], [M/E 2], [M/E 3], and [P/P] buttons are selected: This enables the wipe pattern position setting (positioner) operation mode in the device control block. You can select multiple buttons simultaneously.

When the [USER] button is selected: This enables pattern position setting used for color backgrounds.

When the [DME 1] to [DME 8] buttons are selected: This enables the three-dimensional transform operation mode in the device control block.

Press a button, turning it on, to select a DME channel. You can select multiple buttons simultaneously.

The number of valid buttons depends on the number of DME processor channels installed.

When the [DEV] button is selected: This enables the VTR/disk recorder/frame memory operation mode in the device



control block. In this state, the [M/E 1] to [M/E 3] buttons, [P/P] button and [DME1] to [DME8] buttons function as the device 1 to device 12 allocation buttons as follows.

- [M/E1] (DEV1): device 1
- [M/E2] (DEV2): device 2
- [M/E3] (DEV3): device 3
- [P/P] (DEV4): device 4
- [USER] (FM1CLIP): frame memory clip 1
- [Unused] (FM2CLIP): frame memory clip 2
- [DME1] (DEV5): device 5
- [DME2] (DEV6): device 6
- [DME3] (DEV7): device 7
- [DME4] (DEV8): device 8
- [Unused] (FM LOOP): frame memory loop
- [DME5] (DEV9): device 9
- [DME6] (DEV10): device 10
- [DME7] (DEV11): device 11
- [DME8] (DEV12): device 12

To exit from this mode, press the [DEV] button again, turning it off.

When the [RUN CTRL] button is selected: This enables the effect run control mode in the device control block.

When the [RSZR CTRL] button is selected: This enables the resizer control mode in the device control block of the MVS-8000G.

For details on resizer, see page 419.

The functions of the operation buttons, trackball, and Z-ring vary with the operation mode as follows.

② Operation buttons

When the positioner operation mode is enabled

K1 CB1: Press this button to enable wipe pattern position setting for key 1

(DSK1).

When the [USER] button is selected, pattern position setting for color background 1 is enabled.

K2 CB2: Press this button to enable wipe pattern position setting for key 2 (DSK2).

K3: Press this button to enable wipe pattern position setting for key 3 (DSK3).

K4: Press this button to enable wipe pattern position setting for key 4 (DSK4).

MAIN: Press this button to enable main wipe pattern position setting for normal transitions.

SUB: Press this button to enable sub wipe pattern position setting for normal transitions.

Among the [K1 CB1] button, [K2 CB2] button, [K3] button, [K4] button, [MAIN] button, and [SUB] button, you can select multiple buttons.

POS: Press this button to enable pattern movement in the x-axis and y-axis directions with the trackball.

When the [USER] button is selected, this enables the trackball to move the pattern in the x-axis and y-axis directions, and the Z-ring to adjust the size of the pattern.

X, Y: These restrict the axes affected by the trackball and Z-ring to the x- or y-axis.

Z: This restricts the axes affected by the trackball and Z-ring to the z-axis.

CTR (center): When this button is pressed, the pattern position returns to the center. When the [USER] button is selected, the pattern size also returns to 50.00.

SHIFT/CLR WORK BUFR: Press this button twice in rapid succession to reset all parameters on the target M/E or PGM/PST to their initial values.



When the three-dimensional transform operation mode is enabled

LOCAL: Enable operations in the DME local coordinate space.

GLB (global): Enable operations in the DME global coordinate space.

The [LOCAL] and [GLB] buttons can be selected at the same time.

SRC (source): Enable operations in the DME source coordinate space.

TRGT (target): Enable operations in the DME target coordinate space.

The [SRC] and [TRGT] buttons cannot be selected at the same time. When these buttons are held down, trackball and Z-ring operation is switched to a finer control. (fine mode)

AXIS LOC (location): When this button is lit, the trackball moves the rotational axis of the image in the x-axis and y-axis directions, and the Z-ring moves the axis in the z-axis direction.

ASP PERS (aspect/perspective): When the [SRC] button is lit, pressing this button enables the trackball to control the x-axis and y-axis directions independently, and the Z-ring controls the x-axis and y-axis directions together, to vary the aspect ratio. When the [SHIFT] button is held down and this button is pressed, the trackball controls the skew of the image in the x-axis and y-axis directions.

When the [TRGT] button is lit, pressing this button enables the trackball to control the perspective of the image in the x-axis and y-axis directions.

The Z-ring controls the distance to the viewpoint.

LOC (location) SIZE: When this button is lit, the Z-ring controls the image size. The trackball moves the image in the x-axis and y-axis directions.

LOC (location) XYZ: When this button is lit, the trackball moves the image in the x-axis and y-axis directions, and the Z-ring moves the image in the z-axis direction.

SHIFT: While holding down this button, pressing the [ASP PERS] button or [ROT] button switches to the shifted version of the corresponding function.

CLR WORK BUFR (clear work buffer): Press this button once to clear only the three-dimensional transform parameters of the information held in the work buffer. Press twice in rapid succession to clear all of the parameters, and return to the default state.

ROT (rotation): When this button is lit, the trackball rotates the image about the x- and y-axes, and the Z-ring rotates the image about the z-axis. Pressing this while holding down the [SHIFT] button enables rotation of the image in the “Spin” mode. The trackball and Z-ring operate in the same manner.

X, Y, Z: These restrict which axes the trackball and Z-ring can control. You can select more than one.

When one of these buttons is selected, you can enter the parameter value for the corresponding axis using the numeric keypad control block.

CTR (center): Pressing this button changes the values of the three-dimensional parameters currently controlled by the trackball and Z-ring to the closest detent values. Pressing twice in rapid succession returns the parameter values to their defaults.

When the VTR/disk recorder/frame memory operation mode is enabled



LOCAL (DELAY): Press this button, turning it on, to enter a delay value from the numeric keypad control block.

GLB (STB OFF: standby off): Press this button to switch to standby off mode. This button cannot be used for frame memory clip operations.

SRC (REC: record): Press this button at the same time as the [Y] button to start recording. This button cannot be used for frame memory clip operations.

TRGT (STOP): Press this button to stop the tape, disk or frame memory clip.

AXIS LOC (START TC: start timecode): Press this button to set the timecode of the start point at that time. The timecode of the start point is updated to the current time each time this button is pressed. When the device the operation applies to is a VTR/disk recorder, the start point updated by the setting of the [MENU] button is as follows.

When the [MENU] button is On: start point of the timeline

When the [MENU] button is Off: start point of Cueup & Play

ASP PERS (STOP TC: stop timecode): Press this button to set the timecode of the stop point at that time. The timecode of the stop point is updated to the current time each time this button is pressed. When the device the operation applies to is a VTR/disk recorder, the stop point updated by the setting of the [MENU] button is as follows.

When the [MENU] button is On: stop point of the timeline

When the [MENU] button is Off: stop point of Cueup & Play

LOC SIZE (VAR: variable speed playback): Pressing this button and turning the Z-ring plays back the tape, disk or frame memory clip at a variable

speed and direction proportional to the rotation angle of the Z-ring. The variable speed range is -1 to +3 times normal playback speed.

LOC XYZ (SHTL: shuttle): Pressing this button and turning the Z-ring plays back the tape, disk or frame memory clip at a speed and direction proportional to the rotation angle of the Z-ring.

ROT (JOG): Pressing this button and turning the Z-ring plays back the tape, disk or frame memory clip at a speed and direction proportional to the rotation of the Z-ring.

CLR WORK BUFR (CUE): Pressing this button cues the tape, disk or frame memory clip automatically to the start point.

X (REW: rewind): Press this button to rewind the tape, disk or frame memory clip.

Y (PLAY): Press this button to play the tape, disk or frame memory clip.

Z (FF): Press this button to fast forward the tape, disk or frame memory clip.

CTR (ALL STOP): Press this button to stop all tape transport/disk drive/frame memory operations.

When the resizer control mode is enabled (for the MVS-8000G only)

LOCAL (K1): Select key 1.

GLB (K2): Select key 2.

SRC (K3): Select key 3.

TRGT (K4): Select key 4.

LOC SIZE (ASP: aspect): Pressing this button and operating the trackball or Z-ring changes the aspect ratio of a key to which the resizer function is applied to. When this button is held down, the trackball or Z-ring operation is switched to a finer control. (fine mode)

LOC XYZ (LOC: location): Pressing this button and operating the trackball or Z-

ring moves, shrinks, or magnifies a key to which the resizer function is applied to. When this button is held down, the trackball or Z-ring operation is switched to a finer control. (fine mode)

ROT (RSIZE: resizer): Press this button, turning it on, to enable the resizer.

CLR WORK BUFR (CLR WORK BUFR): Pressing this button once returns the two-dimensional transformation settings to the defaults. Pressing twice in rapid succession returns all resizer parameter values to the defaults.

X, Y: These restrict the axes affected by the trackball and Z-ring to the x- or y-axis.

Z: This restricts the axes affected by the trackball and Z-ring to the z-axis.

CTR (center): Pressing this button once changes the two-dimensional transformation settings to the closest detent values. Pressing twice in rapid succession returns the two-dimensional transformation settings to the defaults.

③ Trackball

When the positioner operation mode is enabled

By moving this, you can move the pattern in the x-axis and y-axis directions.

When the three-dimensional transform operation mode is enabled

Move the trackball to control the x- and y-axes in a three-dimensional transform. When the [SRC] or [TRGT] button is held down, the trackball operation is switched to a finer control. (fine mode)

When the resizer control mode is enabled (for the MVS-8000G only)

By turning the trackball, you can move in the x- and y-directions of the key to which the resizer is applied, and change the aspect ratio.

When the [LOC SIZE] or [LOC XYZ] button is held down, the trackball operation is switched to a finer control. (fine mode)

④ Z-ring

When the positioner operation mode is enabled

When the [USER] button is selected, by turning the ring you can adjust the size of the pattern.

When the three-dimensional transform operation mode is enabled

Turn this ring to control the z-axis in a three-dimensional transform.

When the [SRC] or [TRGT] button is held down, the Z-ring operation is switched to a finer control. (fine mode)

When the effect run control mode is enabled

By turning the Z-ring, you can run the keyframe effect, independent of the STOP NEXT KF, EFF LOOP, and similar settings in the keyframe control block. Turn clockwise to run the effect in the normal direction, and counterclockwise for the reverse direction.

When the resizer control mode is enabled (for the MVS-8000G only)

By turning the ring, you can zoom the key to which the resizer is applied, and change the aspect ratio.

When the [LOC SIZE] or [LOC XYZ] button is held down, the Z-ring operation is switched to a finer control. (fine mode)

When the VTR/disk recorder/frame memory operation mode is enabled

Turning the Z-ring controls the tape transport/disk drive/frame memory clip operations, at a speed determined by the operating buttons. Turn clockwise for the normal direction, and counterclockwise for the reverse direction.

⑤ MENU button

Press this button, turning it on, to enable adjusting the parameters allocated to the knobs in the menu using the trackball and Z-ring.

In the case of the DME menu, the operation applies to the selected DME channel.

In VTR/disk recorder/frame memory operation mode, press this button, setting it to On. This makes it possible to carry out timeline start/stop point setting operation for the device selected with the device selection buttons.



Device Control Block (Joystick)

The description below of frame memory clip operations applies only to the MVS-8000A/8000G.

of the trackball, except that the trackball and Z-ring operations are carried out with the joystick.

All functions of the joystick type device control block are equivalent to the functions

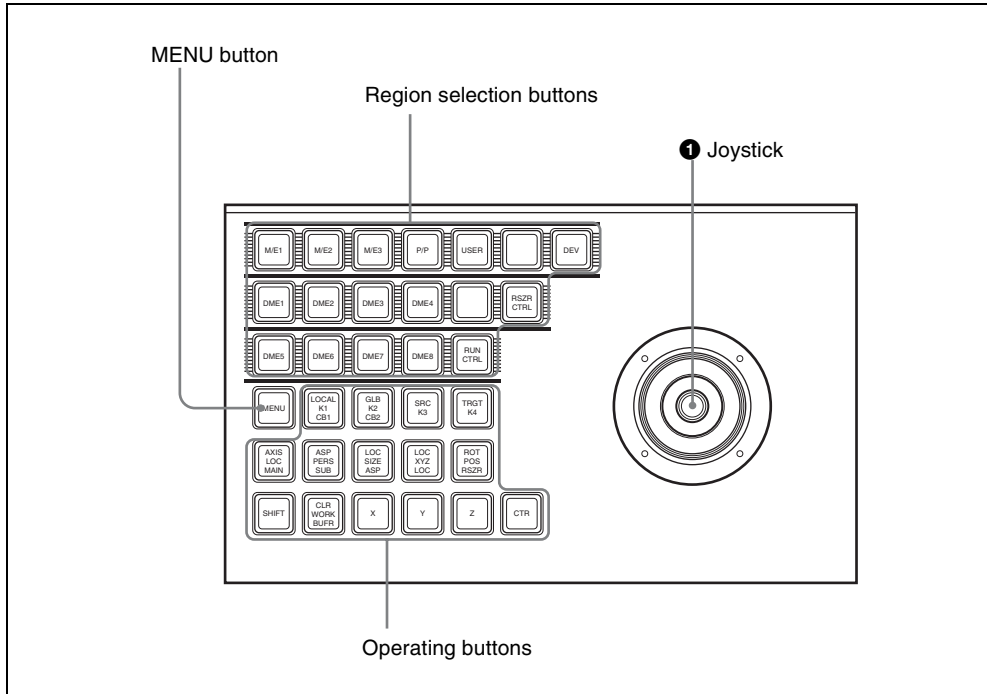

1 Joystick

When the positioner operation mode is enabled

By moving this, you can move the pattern in the x-axis and y-axis directions.

When the three-dimensional transform operation mode is enabled

By moving this, you can carry out operations in the x-, y-, and z-axes.

When the following buttons are held down, the joystick operation is switched to a finer control. (fine mode)

- The button on the end of the joystick
- [SRC] button
- [TRGT] button

Depending on the settings made in the Setup menu, the operation speed multiple can be changed.

When the effect run control mode is enabled

By moving the joystick sideways, you can run the keyframe effect, independent of the STOP NEXT KF, EFF LOOP, and similar settings in the keyframe control block.

Move to the right to run the effect in the normal direction, and to the left for the reverse direction.

When the VTR/disk recorder/frame memory operation mode is enabled

Moving the joystick sideways controls the tape transport/disk drive/frame memory clip operation, at a speed determined by the operating buttons.

When the resizer control mode is enabled (for the MVS-8000G only)

Move for operations in the x-, y-, and z-axes. Hold down the button on the tip of the joystick to switch the joystick operation to a finer control. (fine mode).

Move to the right for the normal direction, and to the left for the reverse direction.

Device Control Block (Search Dial)

The description below of frame memory clip operations applies only to the MVS-8000A/8000G.

Using the device control block (search dial), you can directly operate an XDCAM,

disk recorder, VTR, other external device, frame memory clip, or shot box. The device control block (trackball) and device control block (joystick) can be used together.

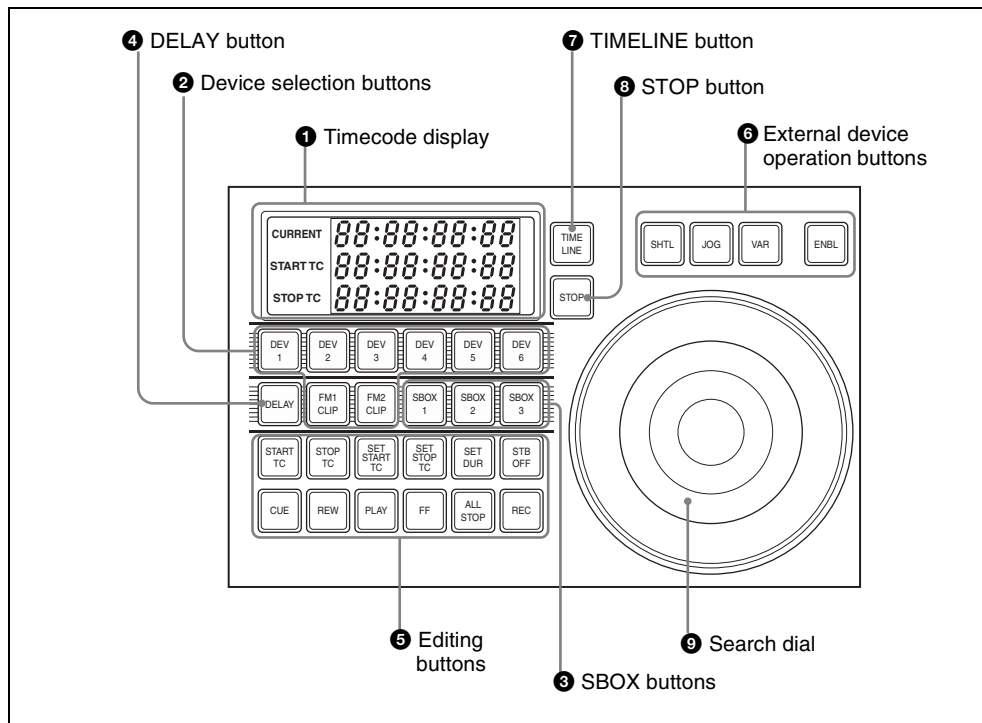



❶ Timecode display

This shows the current time (CURRENT) and the start and stop point timecode values for the current reference device (START TC, STOP TC). When you press a device selection button, the button lights, selecting the assigned device as the reference device, and displaying its setting value.

In the case of the [SBOX] buttons, the display does not change. When the operation applies to a VTR/disk recorder, the displayed setting value depends on whether the [TIMELINE] button is on or off, as follows.

When the [TIMELINE] button is on:

Displays the start and stop points of the last set keyframe on the timeline. When the keyframe number is changed and the last register and keyframe change, the display also changes. (timeline setting mode)

When the [TIMELINE] button is off:

Displays the Cueup & Play (rewind action) start and stop points.

❷ Device selection buttons

These buttons are used for selecting assigned external devices or frame memory clips. Each button can only be assigned to a single device. Carry out the assignment in the Setup menu (see “Overall Control Panel Settings (Config Menu)” in Chapter 16 (Volume 2)). To select an assigned device, press the corresponding button, which lights green. To select more than one device simultaneously, hold down the button for the first selection, while pressing the buttons for the other selections in turn. The second and subsequent selected buttons light amber. If you press another button without holding down the first selected button, the second button will be the reference device and light green.

DEV: Assign external devices DEV1 to DEV12.

FM CLIP: Assign frame memory clips FM1 to FM8.

Device selection buttons can be set as SBOX buttons or DELAY button in the Setup menu.

❸ SBOX (shotbox) buttons

Assign a shotbox saved in registers 1 to 99. When you press a button, the assigned shotbox is selected, and executed. Carry out the assignment in the Setup menu (see “Overall Control Panel Settings (Config Menu)” in Chapter 16 (Volume 2)). SBOX buttons can be set as device selection buttons or DELAY button in the Setup menu.

❹ DELAY button

When pressed, this button lights green, the numeric keypad control block display changes to DELAY__ : , and you can set the start delay time for the selected device. The setting range is from 00:00 to 59:29 (depends on the video format). This button goes off when another timecode setting button ([START TC], [STOP TC], [SET START TC], [SET STOP TC], or [SET DUR]) is pressed. Carry out the assignment in the Setup menu (see “Overall Control Panel Settings (Config Menu)” in Chapter 16 (Volume 2)).

The DELAY button can be set as a device selection button or an SBOX button in the Setup menu.

❺ Editing buttons

These buttons set start and stop points. These operations are only valid while a device is selected with the device selection buttons.

START TC: Press this button to set the timecode of the start point at that time. The timecode of the start point is updated to the current time each time this button is pressed.

When the device the operation applies



to is a VTR/disk recorder, the start point updated by the setting of the [TIMELINE] button is as follows.

When the [TIMELINE] button is

On: start point of the timeline

When the [TIMELINE] button is

Off: start point of Cueup & Play

STOP TC: Press this button to set the timecode of the stop point at that time. The timecode of the stop point is updated to the current time each time this button is pressed.

When the device the operation applies to is a VTR/disk recorder, the stop point updated by the setting of the [TIMELINE] button is as follows.

When the [TIMELINE] button is

On: stop point of the timeline

When the [TIMELINE] button is

Off: stop point of Cueup & Play

SET START TC, SET STOP TC, SET

DUR: When pressed, these buttons light green, “START TC”, “STOP TC” or “DUR” appears in the numeric keypad control block display, and you can enter a timecode from the numeric keypad. If you enter a numeric value and press the [ENTER] button, the button goes off, whereas if you press the [ENTER] button without entering a numeric value the numeric keypad control block display shows “--:--:--:--”. To exit the numeric value entry mode, either repeat pressing the same button, or press a different numeric keypad control block linked button, or a mode selection button such as the [EFF] and [SNAPSHOT] buttons in the numeric keypad control block. If the timecode has been set correctly, the entered numeric value appears in the timecode display.

STB (standby) OFF: When pressed, this button flashes amber, and the device selected with the device selection

buttons exits from the standby mode. This button cannot be used for frame memory clip operations.

CUE: When pressed, this button flashes amber together with the [ALL STOP] button, and the device selected with the device selection button is cued up to the start point of the material. When more than one device is selected, the amber flashing continues until the reference device is cued up, and when the cueing up is finished, this button lights green.

REW: When pressed, this button lights amber, and material of the device selected with the device selection buttons is rewind. To stop during the rewind, press the [STOP] button or [ALL STOP] button.

PLAY: When pressed, this button lights amber, and the device selected with the device selection buttons plays. The playback stops not only if the [STOP] button is pressed, but also if any of the [STB OFF], [SHTL], [JOG], [CUE], [REW], [PLAY], [FF], and [ALL STOP] buttons is pressed. When the [VAR] button is pressed while the device is playing back, the device plays at one times normal speed in variable mode.

FF: When pressed, this button lights amber, and the material of the device selected with the device selection buttons is fast forwarded. To stop during the fast-forward, press the [STOP] button or [ALL STOP] button.

ALL STOP: When pressed, all device material playback and other operations stop. During cueing up of any of the devices, this button flashes amber, and when all cueing up operations are completed, it lights green.

REC: When pressed simultaneously with the [PLAY] button, this button lights red (the [PLAY] button lights amber),

and the image from the selected device is recorded.

This button cannot be used for frame memory clip operations.

⑥ External device operation buttons

ENBL (enable): When this is pressed, turning it on, the search dial [VAR], [JOG], and [SHTL] button operations are enabled.

VAR (variable): Sets the search dial to variable mode.

JOG: Sets the search dial to jog mode.

SHTL (shuttle): Sets the search dial to shuttle mode.

⑦ TIMELINE button

Press to switch the device selected with the device selection buttons to timeline setting mode.

⑧ STOP button

When pressed, this lights amber, and operation of the device selected with the device selection buttons stops.

⑨ Search dial

Use this for search and other operations on the material of an external device.

For details of the method of use, see “Controlling Tape/Disk Transport” in Chapter 12 (Volume 2).

Keyframe Control Block

In the keyframe control block, you can carry out effect editing and execution.



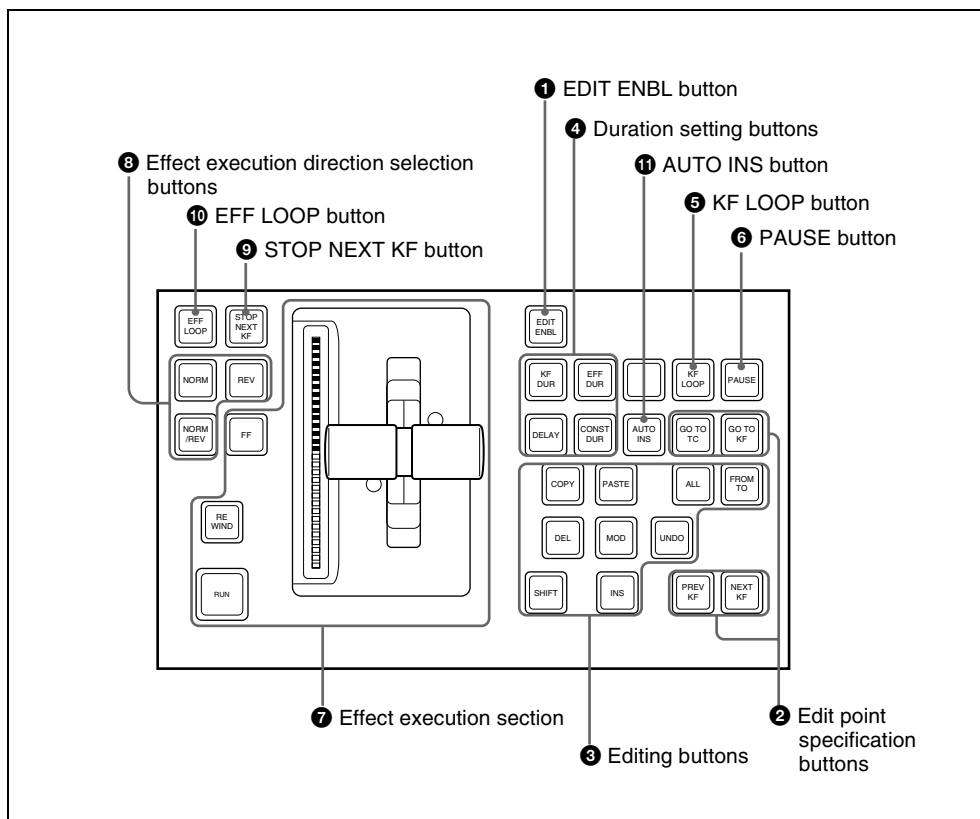

1 EDIT ENBL (edit enable) button
Press this button, turning it on, to enable effect editing operations with the keyframe control block.

When macro editing is carried out, this button lights red.

2 Edit point specification buttons

GO TO TC (Go to timecode): Press this button, turning it on, to enter a numeric value from the numeric keypad control block, and move the edit point to the specified timecode position.

GO TO KF (Go to keyframe): Press this button, turning it on, to enter a numeric value from the numeric keypad control block, and move the edit point to the specified keyframe.

During macro editing, pressing this button moves the edit point to the event number specified by numeric entry with the numeric keypad control block.

PREV KF (previous keyframe): When this button is pressed, the edit point moves to the keyframe immediately before the current time (the position where the effect is currently stopped). During macro editing, pressing this button moves the edit point to the event immediately before the current event.

NEXT KF (next keyframe): When this button is pressed, the edit point moves to the keyframe immediately after the current time.

During macro editing, pressing this

button moves the edit point to the event immediately after the current event.

③ Editing buttons

ALL: Press this button, turning it on, to select all keyframes (during macro editing, all events) in the effect.

FROM TO: Press this button, turning it on, to enter numeric values from the numeric keypad control block, and select a specified range of keyframes (during macro editing, the specified range of events).

INS (insert): When this button is pressed, a new keyframe is inserted after the current keyframe. Pressing this button while holding down the [SHIFT] button inserts a new keyframe before the current keyframe. During macro editing, pressing this button registers an event after the current event.

MOD (modify): When this button is pressed, the selected keyframe is modified with the values of the current keyframe. When the edit point is between two keyframes, the immediately preceding keyframe is modified. You can also select multiple keyframes, and modify them in a single operation. At this time, pressing this button while holding down the [SHIFT] button modifies all selected keyframes with the changed values taken as relative values.

During macro editing, pressing this button amends the selected event.

DEL (delete): When this button is pressed, the selected keyframe is deleted. When the edit point is between two keyframes, the immediately preceding keyframe is deleted. During macro editing, pressing this button deletes the selected event. You can also select multiple keyframes or macro events, and delete them in a single operation.

COPY: When this button is pressed, the selected keyframe (during macro editing, macro event) is copied. You can also select multiple keyframes or macro events, and copy them in a single operation.

PASTE: When this button is pressed, the deleted or copied keyframe (during macro editing, macro event) is inserted after the current keyframe (during macro editing, macro event). Pressing this button while holding down the [SHIFT] button inserts the deleted or copied keyframe (during macro editing, macro event) before the current keyframe (during macro editing, macro event).

SHIFT: Hold down this button, and press the [INS] button, [MOD] button, or [PASTE] button, to obtain the shifted function for the button.

UNDO: When this button is pressed, the last executed keyframe (during macro editing, macro event) insertion, modification, or deletion, or paste operation is canceled.

④ Duration setting buttons

KF DUR (keyframe duration): Press this button, turning it on, to set the keyframe duration of the selected keyframe, by numeric value entry from the numeric keypad control block.

EFF DUR (effect duration): Press this button, turning it on, to set the effect duration from the numeric keypad control block.

DELAY: Press this button, turning it on, to enter a delay value from the numeric keypad control block.

CONST DUR (constant duration): Select the duration mode. When this is lit, the mode is constant duration mode, and when off, variable duration mode.

**5 KF LOOP (keyframe loop) button**

Press this button, turning it on, to execute the effect the specified number of times through the keyframes in the specified range.

6 PAUSE button

When this button is pressed, a pause is applied to the selected keyframe. When editing a macro, press this button, turning it on, to include a pause event in the macro. The pause length can be set in the numeric keypad control block.

7 Effect execution section

RUN: When this button is pressed, the effect is run from the first keyframe to the last keyframe. However, if a pause is set on a keyframe, the effect stops at that point. Press this button again to resume execution, and continue to the next pause point or the end of the effect.

Effect indicator: This comprises multiple LEDs, which show the progress of the effect.

Fader lever: Moving this up or down manually runs the effect.

REWIND: When this button is pressed, the currently recalled effect is rewound to the first keyframe.

FF (fast forward): When this button is pressed, the currently recalled effect is advanced to the last keyframe.

8 Effect execution direction selection buttons

NORM (normal): When this button is lit, effect execution runs from the first keyframe to the last keyframe.

REV (reverse): When this button is lit, effect execution runs from the last keyframe to the first keyframe.

Pressing one of these buttons automatically turns the other off.

NORM/REV (normal/reverse): Press this button, turning it on, to reverse the direction of the effect when it reaches the last keyframe or first keyframe.

9 STOP NEXT KF (stop next keyframe) button

When this button is pressed, turning it on, the effect execution range is from the current time to the next keyframe.

10 EFF LOOP (effect loop) button

When the effect reaches the last keyframe with this button on, it returns to the first keyframe and repeats.

11 AUTO INS (auto insert) button

When editing a macro, press this button, turning it on, to enable the auto insert function, so that every control panel operation you carry out is added to the macro as an event.

Numeric Keypad Control Block

The numeric keypad control block is used for region selection, for saving and recalling snapshots, effects and shotboxes, for entering numeric values for trackball operation and keyframe operation, and for transition rate entry.

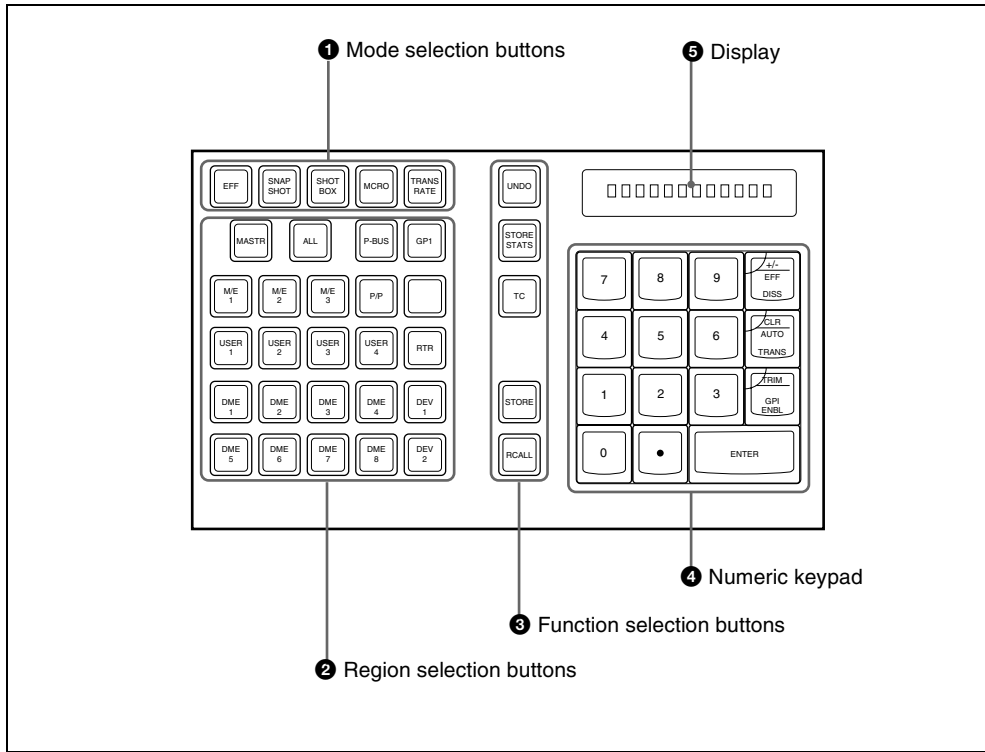

1 Mode selection buttons

EFF (effect): Press to save or recall an effect.

SNAPSHOT: Press to save or recall a snapshot.

SHOTBOX: Press to save or recall a shotbox.

MCRO (macro): Press to save, recall or edit a macro.

TRANS RATE (transition rate): Press to set the transition rate.

Hold down this button, and press one of the key delegation buttons [KEY1] to [KEY4] in the transition control block to set an independent key transition rate.

2 Region selection buttons

These select the functional block (“region”) of the control panel to which operations apply.

You can select more than one region at the same time.

The first button you press is taken as the reference region, and lights green, while the next pressed button lights amber.

With the exception of the [MASTER] and [ALL] buttons, you can change the region assignment to the buttons as desired in the Setup menu.

MASTR: Press this, turning it on, to save region information in a master snapshot register or master timeline register, or to recall such region information.



ALL: Select all regions. When any region is already selected, pressing this button makes all regions unselected.

M/E 1 to M/E 3, P/P: Select the corresponding regions, M/E-1, M/E-2, M/E-3, and PGM/PST.

USER 1 to USER 8: Select a User region.

DME1 to DME8: Select a DME channel.

P-Bus: Select the P-Bus region.

GPI: Select the GPI region.

RTR: Select the router region.

DEV1 to DEV12: Select the Device 1 to Device 12 regions respectively.

MCRO: Select the macro region.

③ Function selection buttons

UNDO: After recalling a register, press this button to return to the state before recalling the register.

STORE STATS (store status): This lights amber when data is stored in a register. After saving data to a register, hold down this button and press the [UNDO] button to return the register to the state before the data was saved.

TC (timecode): Press this button, turning it on, to switch transition rate entry to the timecode entry mode.

STORE: Press this button to switch to the mode for saving a snapshot, effect, shotbox or macro in a register.

RCALL (recall): Press this button to switch to the mode for recalling a snapshot, effect, shotbox or macro from a register.

[STORE] button or [RCALL] button flashes amber when one or more of the regions assigned to the Region selection buttons are not selected by the Region Select menu.

④ Numeric keypad

In addition to the buttons for numeric input, this includes buttons for adding attributes to snapshots.

0 to 9: Used to input numeric digits.

. (period): Enters the decimal point.

When the [TRANS RATE] button is lit, enters “00.” When the [EFF] button, [SNAPSHOT] button or [SHOTBOX] button is lit, this is used to find an empty register.

+/- EFF DISS (effect dissolve): Invert the sign, negative or positive.

When the [SNAPSHOT] button is lit, applies the effect dissolve attribute to a snapshot.

CLR/AUTO TRANS (clear/auto transition): Clear an input value, returning to the previous state.

When the [SNAPSHOT] button is lit, applies the auto transition attribute to a snapshot.

TRIM/GPI ENBL (enable): After entering a difference value to be added to an existing setting, press this button to confirm the change.

ENTER: Confirm an entered value.

⑤ Display

This shows the selected region name and entered numeric values.

Fade to Black Control Block

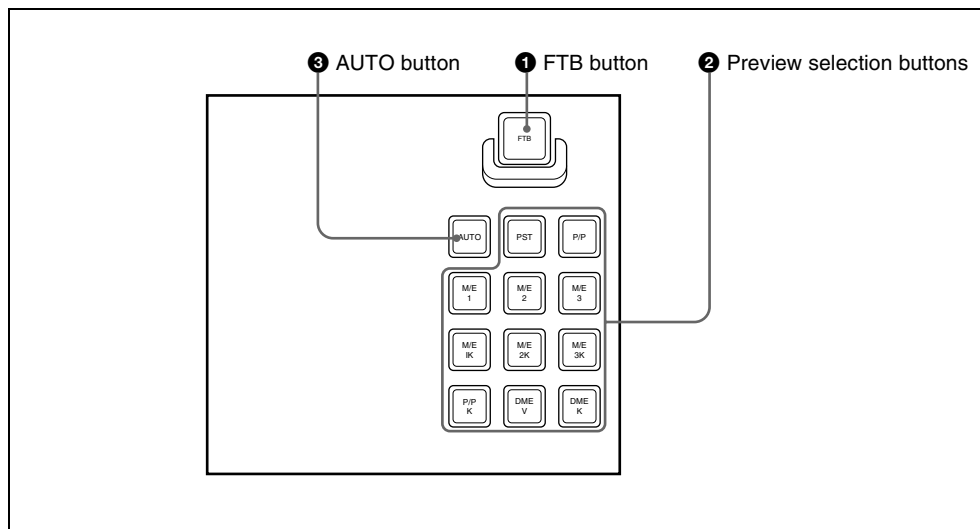

1 FTB (fade to black) button

Press this button to fade to black the program output of the PGM/PST bank, at the set transition rate. You can set the fade to black transition rate in the menu.

2 Preview selection buttons

Press one of these buttons to select a signal on the edit preview bus. Each button can be assigned to any preview output in setup (see Chapter 16 “Overall Control Panel Settings (Config Menu)” (Volume 2)).

PST (preset): When this button is pressed, the signal selected on the background B row of the PGM/PST bank is selected on the edit preview bus.

M/E 1 to M/E 3, P/P (M/E1 to M/E 3, P/P preview): The preview signal (M/E-1 PVW, M/E-2 PVW, M/E-3 PVW, P/P PVW) of the M/E or PGM/PST bank corresponding to the pressed button is selected on the edit preview bus.

M/E1 K to M/E3 K, P/P K (M/E1 to M/E 3, P/P key preview): The key preview

signal (M/E-1 K-PVW, M/E-2 K-PVW, M/E-3 K-PVW, P/P K-PVW) of the M/E or PGM/PST bank corresponding to the pressed button is selected on the edit preview bus.

DME V (DME monitor video): When this button is pressed, the DME monitor output video signal (DME MON V) is selected on the edit preview bus.

DME K (DME monitor key): When this button is pressed, the DME monitor output key signal (DME MON K) is selected on the edit preview bus.

3 AUTO button

When this button is pressed, the M/E or PGM/PST bank preview signal selected on the edit preview bus is automatically switched to the program signal depending on the on-air status.

Auxiliary Bus Control Block (for AUX Buses)

There are also models without the selected source name displays and source name displays shown in the following figure.

All operations except those of the [DEST] button and [SHIFT] button are the same as for a model with selected source name displays and source name displays.

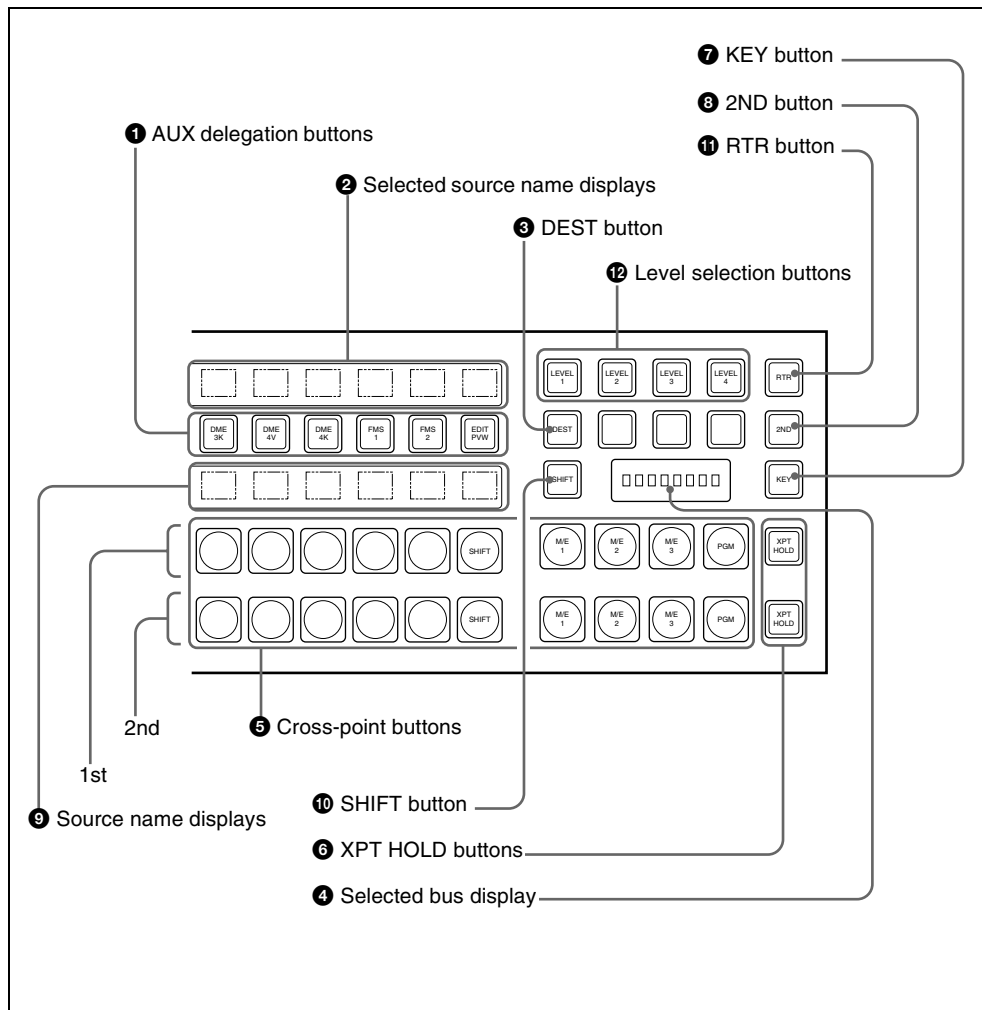

1 AUX delegation buttons

Press one of these buttons, turning it on, to select the bus to which to assign the cross-

point buttons in the auxiliary bus control block.

The buses that can be selected are as follows.

- AUX buses 1 to 48
- MONITOR 1 to MONITOR 8 buses
- FMS 1 (frame memory source 1) and FMS 2 buses
- DME 1V to DME 8V buses
- DME 1K to DME 8K buses
- EDIT PVW (preview) bus
- M/E-1 UTILITY 1 and M/E-1 UTILITY 2 buses
- M/E-2 UTILITY 1 and M/E-2 UTILITY 2 buses
- M/E-3 UTILITY 1 and M/E-3 UTILITY 2 buses
- P/P UTILITY 1 and P/P UTILITY 2 buses
- DSK 1 fill to DSK 4 fill buses
- DSK 1 source to DSK 4 source buses
- M/E-1 Key 1 fill to Key 4 fill buses
- M/E-2 Key 1 fill to Key 4 fill buses
- M/E-3 key 1 fill to M/E-3 key 4 fill buses
- M/E-1 Key 1 source to Key 4 source buses
- M/E-2 Key 1 source to Key 4 source buses
- M/E-3 key 1 source to M/E-3 key 4 source buses
- M/E-1 external DME bus
- M/E-2 external DME bus
- M/E-3 external DME bus
- P/P external DME bus
- DME UTILITY1 and DME UTILITY2 buses
- CCR (color corrector) 1 and 2 buses

2 Selected source name displays

These show the name of the currently selected signal (source) on the bus corresponding to the delegation button.

3 DEST (destination) button

Press this button, turning it on, to display the names of buses allocated to the delegation buttons in the selection source name displays.

In the case of a module without selected source name displays, this button is invalid.

4 Selected bus display

This shows the name of the bus selected by the auxiliary bus delegation buttons.

5 Cross-point buttons

The cross-points in the auxiliary bus control block are arranged in two rows: an upper row (1st row) and a lower row (2nd row), and are allocated to the buses selected with the AUX delegation buttons. The 1st row contains the cross-point buttons for unshifted buses, and the 2nd row contains the cross-point buttons for shifted buses. When the DME 1V/K to 8V/K buses are selected with the AUX delegation buttons, the 1st row cross-point buttons are for the currently showing side of DME, and the 2nd row are for the reverse side.

By holding down the [2ND] button and making an AUX delegation selection, you can allocate the 2nd row to a different bus from the 1st row.

In this case, if the 32nd button is set to be a [SHIFT] button (in a 32-button system), the cross-point buttons switch to the shifted allocation while the [SHIFT] button is enabled.

6 XPT HOLD (cross-point hold) buttons

Press one of these buttons, turning it on, to enable cross-point hold.

7 KEY button

While this button is held down, you can use the cross-point row of buttons to select key signals.

8 2ND button

After selecting a bus with an AUX delegation button, hold down this button, and select another AUX delegation, thus allocating a different bus in the 2nd row from the 1st row.



⑨ Source name displays

These show the names of the source signals which can be selected by the cross-point buttons. While the [SHIFT] button is enabled, the shifted signal name is displayed. If a different bus is allocated to the 2nd row, while the [2ND] button is held down, the 2nd row signal name is displayed.

While the [KEY] button is held down, the source name of the key signal assigned to the cross-point buttons appears.

⑩ SHIFT button

While this button is enabled, the shifted signal names appear in the source name display. Pressing this buttons toggles the source name display between the shifted signal names and unshifted signal names. In the case of a module without source name displays, this button is invalid.

⑪ RTR (router) button

Press this button, turning it on, to assign the auxiliary bus control block to router control.

For details of the names and functions of parts for router control, see the next section.

⑫ Level selection buttons

Used when the auxiliary bus control block is carrying out router control.

Auxiliary Bus Control Block (for Router Control)

Press the [RTR] button, turning it on, to assign the auxiliary bus control block to router control.

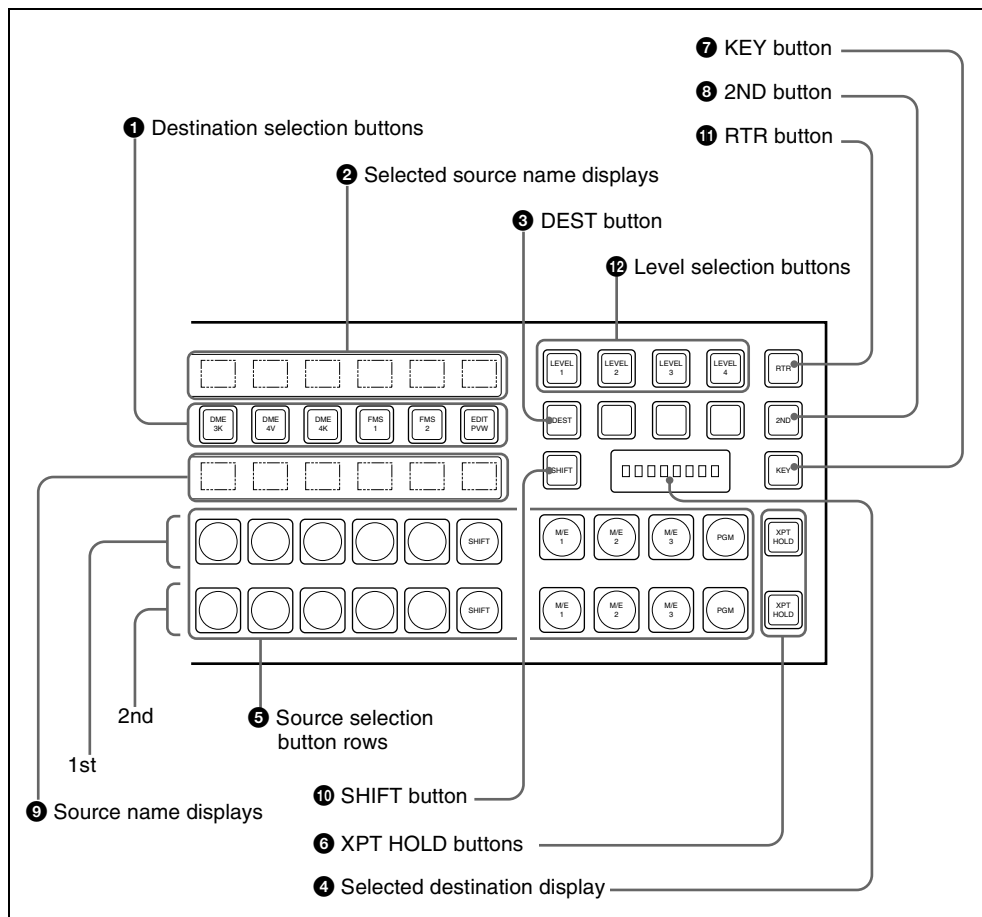

1 Destination selection buttons

Press a button, turning it on, to select the destination to which the router source is assigned.

The button pressed to assign a destination to a source selection button in the 1st row lights amber. When another button is pressed to assign a different destination to a

source selection button in the 2nd row, it lights green.

2 Selected source name displays

These show the source name selected for the destination.

If the source names and destination names are set in the Setup menu to “SW’er Local”

mode, then the description names appear here.

3 DEST (destination) button

Press this button, turning it on, to display the names of the destinations assigned to the destination selection buttons in the selected source name displays.

4 Selected destination display

This shows the name of the destination selected by the destination selection buttons. If a protected destination is selected, the indication “PROTECT” appears.

5 Source selection button rows

The destination selected with a destination selection button is assigned to a source selection button. Press a source selection button to select a source. The 1st row of buttons are source selection buttons for the unshifted destinations, and the 2nd row are shifted source selection buttons. By holding down the [2ND] button, and selecting a destination, you can assign a different destination from the 1st row to the 2nd row. In the 1st row, the button to which a destination is assigned lights amber. If a different destination is assigned to a button in the 2nd row, the button lights green. When the 32nd button is set as a [SHIFT] button (in a 32-button system), while the [SHIFT] button is active, these switch to the shifted source selection buttons. By using the [KEY] button, you can expand the source selection as follows.

Source selection	[SHIFT]	[KEY]	Selection operation
1 to 31	Off	Off	Press the source selection button.
32 to 62	On	Off	Press the [SHIFT] button, then press the source selection button.

Source selection	[SHIFT]	[KEY]	Selection operation
63 to 93	Off	On	Hold down the [KEY] button, and press the source selection button.
94 to 124	On	On	Hold down the [KEY] button, and press the [SHIFT] button, turning it on (the [SHIFT] button locks here, even when in Hold mode), then press the source selection button.

6 XPT HOLD (cross-point hold) buttons

Not used in router control mode.

7 KEY button

When this button is enabled by a setting in the Setup menu, by holding it down during a source selection you can expand the function of the [SHIFT] button. (See “Expanding the shift function” in Chapter 16 (Volume 2).)

8 2ND button

After selecting a destination with the destination selection buttons, hold down this button and make another destination selection to assign a different destination from the 1st row to the 2nd row.

9 Source name displays

These display the names of signals (sources) that can be selected with the cross-point buttons. While the [SHIFT] button is active, the shifted signal names appear. While the [KEY] button is held down, the expanded signal names appear. When a different destination is assigned to the 2nd row, the 2nd row signal names

appear only while the [2ND] button is held down.

⑩ SHIFT button

While this button is active, the source name displays show the shifted signal names. Press this button to toggle between the shifted and unshifted states.

⑪ RTR (router) button

Press this button, turning it on, to assign the auxiliary bus control block to router control.

⑫ Level selection buttons

To each of the four buttons, plural S-Bus levels are assigned in the Setup menu. Press a button, turning it on, to make operations apply to those S-Bus levels.



Menu Control Block

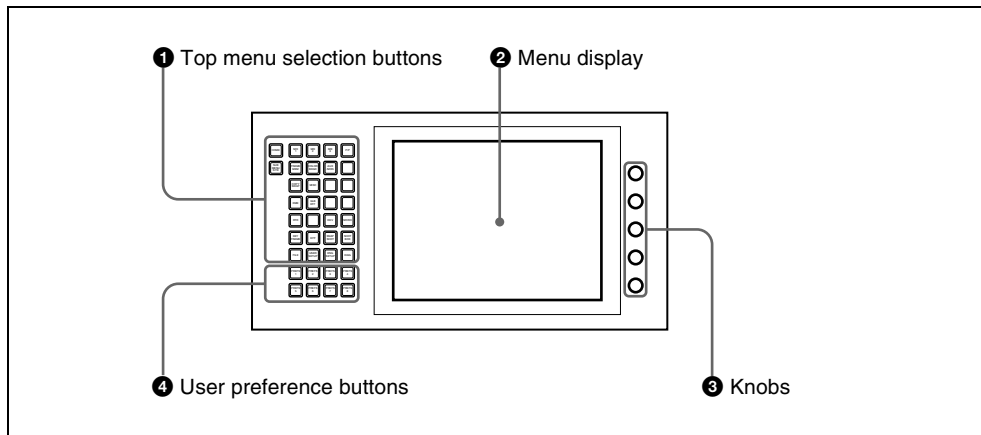

1 Top menu selection buttons

These select the menu appearing in the menu display. It is also possible to change the assignment of these buttons in setup. For details, see “Overall Control Panel Settings (Config Menu)” in Chapter 16 (Volume 2).

3 Knobs

These adjust the parameter values appearing in the menu.

4 User preference buttons

These recall the functions or menus assigned to them in the Setup menu. In the default setup, nothing is assigned to the [PREFS 1] to [PREFS 7] buttons. It is also possible to change the assignment of these buttons in setup. For details, see “Overall Control Panel Settings (Config Menu)” in Chapter 16 (Volume 2).

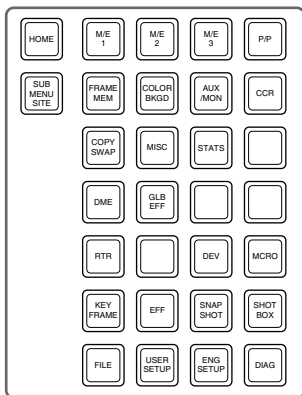

PREFS 8 button: When this button is on, control of an editor from the Remote1 port on the rear panel of the switcher is possible. However, even when it is off, control of the Edit PVW bus is always possible.

2 Menu display

This shows the menu currently in use.

Memory Card/USB Adaptor Block

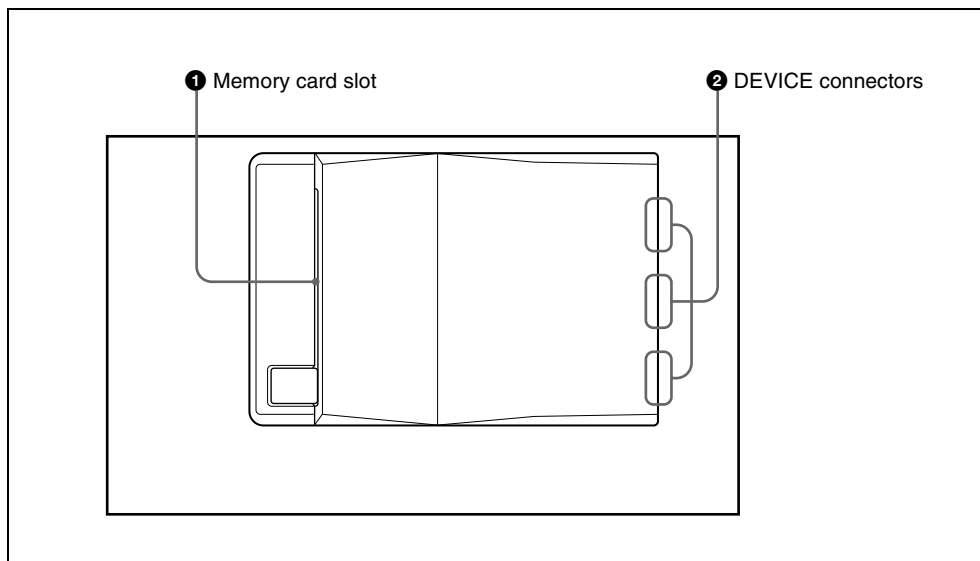

1 Memory card slot

This slot accepts a PCMCIA Type II compliant memory card. You can use it in software installation, and for saving and reading in data, such as snapshot, keyframe, effect, and setup data.

2 DEVICE connectors

There are three USB connectors. You can connect a device such as a mouse, keyboard, pen tablet, and so on, that is equipped with a USB interface to any of these connectors.

For details on the devices that can be connected, consult your Sony representative.

“Memory Stick”/USB Connections Block

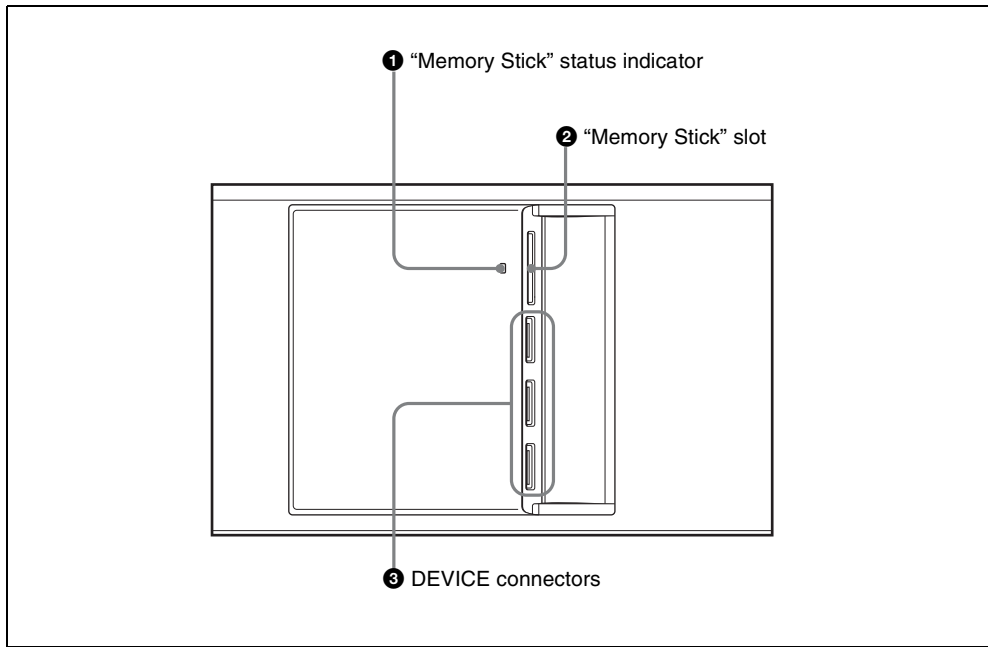

- 1 “Memory Stick” status indicator**
Lights in red during access to a “Memory Stick.”

Note

Do not power the unit off or remove a “Memory Stick” when the “Memory Stick” status indicator is lit.

- 2 “Memory Stick” slot**
Insert “Memory Sticks.” You can use it in software installation, and for saving and reading data, such as snapshot, keyframe, effect, and setup data.

See the next item, “Memory Sticks” for more information about the usable “Memory Sticks” and their handling.

- 3 DEVICE connectors**
There are three USB connectors. You can connect a device such as a mouse, keyboard, pen tablet, and so on, that is equipped with a USB interface to any of these connectors.

For details on the devices that can be connected, consult your Sony representative.

About “Memory Sticks”

- Usable “Memory Sticks”**
This unit has been confirmed to operate with those of the following “Memory Sticks” that have a capacity of 8 GB (gigabytes) or less. However, operation with all “Memory Sticks” is not guaranteed.
- “Memory Stick”

- “Memory Stick PRO”
- “Memory Stick Duo”
- “Memory Stick PRO Duo”

Notes

- When using a “Memory Stick PRO,” high-rate data transfer using parallel interface is not supported.
- A “MagicGate Memory Stick” can also be used, but this system does not support the MagicGate function.
- When using a “Memory Stick Duo,” be sure to use it with a “Memory Stick Duo Adaptor” (MSAC-M2 or equivalent). If you insert a “Memory Stick Duo” without using the adaptor, there is the possibility that the stick cannot be removed, resulting in a serious accident.

Handling “Memory Sticks”

When using “Memory Sticks,” pay attention to the following points.

- Do not touch the connector of the “Memory Stick” with anything, including your finger or metallic objects.
- Do not attach anything other than the supplied label to the “Memory Stick” labeling position.
- Attach the label so that it does not stick out beyond the labeling position.
- Carry and store the “Memory Stick” in its case.
- Do not strike, bend, or drop the “Memory Stick.”
- Do not disassemble or modify the “Memory Stick.”
- Do not allow the “Memory Stick” to get wet.
- Do not use or store the “Memory Stick” in a location that is:
 - Extremely hot, such as in a car parked in the sun
 - Under direct sunlight
 - Very humid or subject to corrosive substances



Utility/Shotbox Control Block

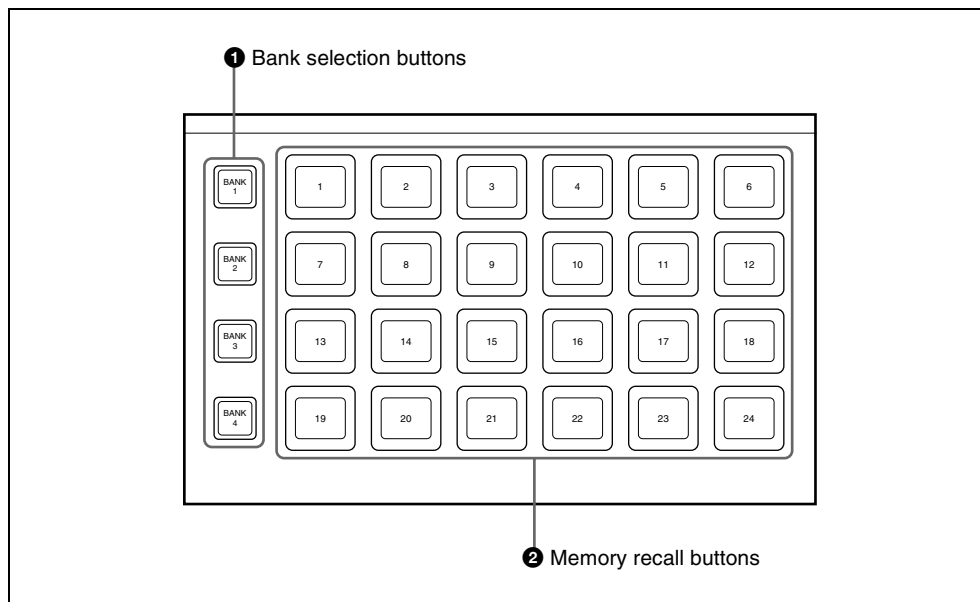

1 Bank selection buttons

Press any of the [BANK1] to [BANK4] buttons to select a bank of 24 memory recall buttons. The selected button lights amber.

2 Memory recall buttons

You can use these buttons to recall frequently used menus, utility functions, shotbox registers, or macro registers that you have assigned.

When a utility function is allocated to a button, the button lights orange (or green depending on the status), and the allocated function name appears. Pressing the button executes the allocated function. When the function constitutes a switching on/off operation, the button lights green; otherwise, it only momentarily lights green. When a shotbox register or macro register recall is assigned to a button, the button lights orange, and the assigned register name appears. (If the register is empty, the

button goes off.) In the case of a shotbox function, pressing the button executes the assigned shotbox function, and the button lights yellow. In the case of a macro register, pressing the button executes the assigned macro, and the button flashes yellow.

Transition Control Block and Flexi Pad Control Block (Simple Type)

The simple versions of the transition control block and Flexi Pad control block shown in the following figure is designed to allow simplified operations than with the standard type. The transitions carried out using these simple-type control blocks are also referred to as “simple transitions” in this User’s guide.



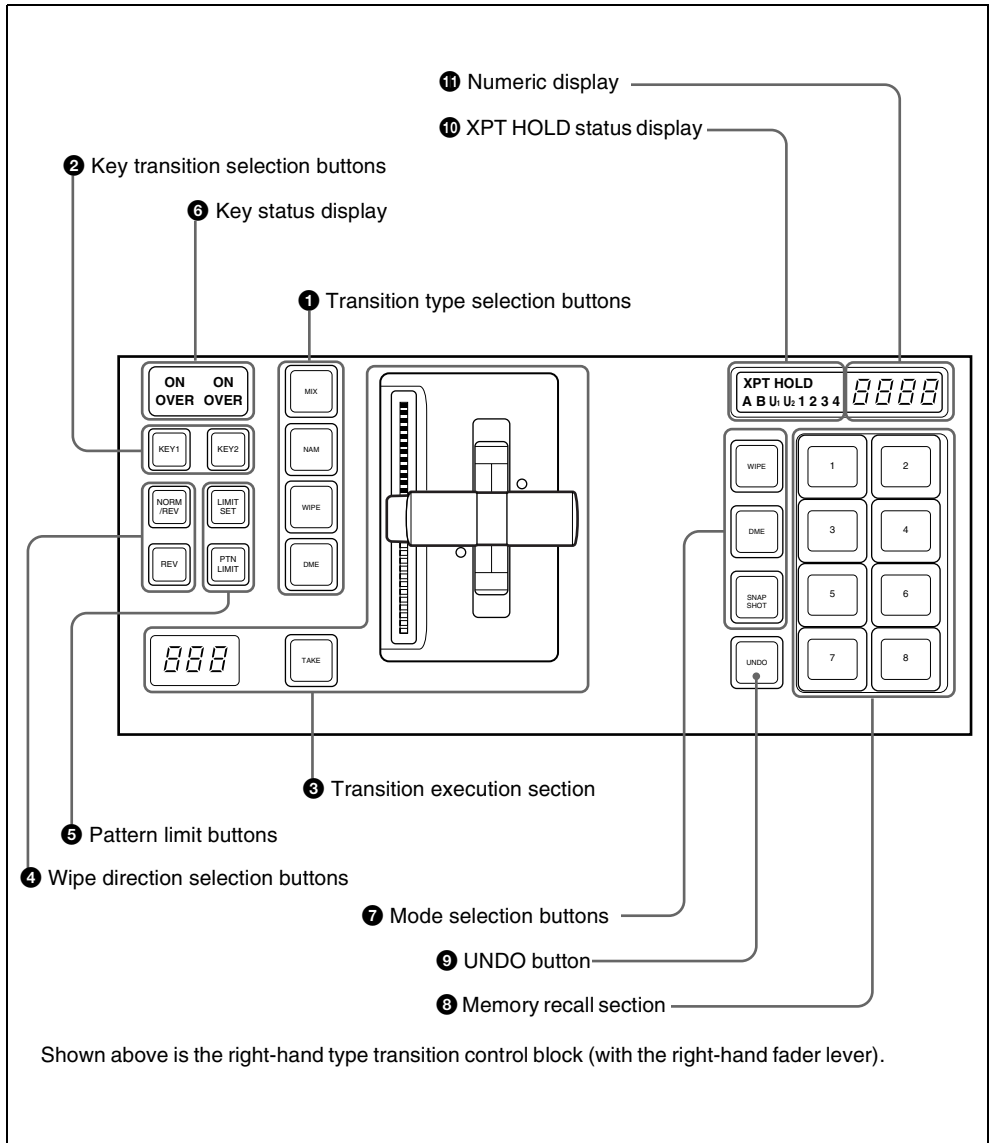

Transition Control Block and Flexi Pad Control Block (with INH button)

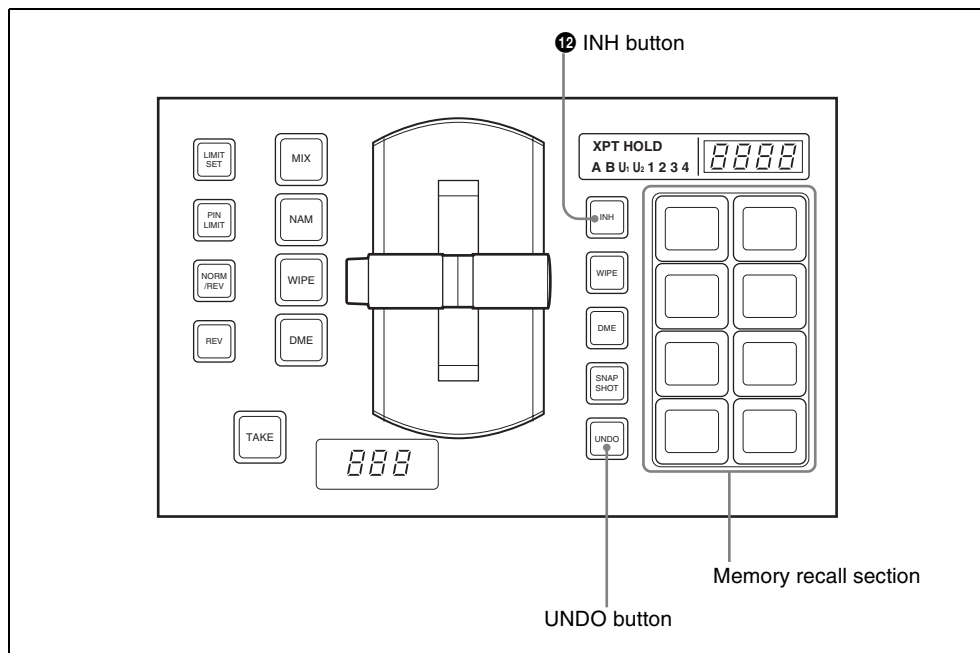

1 Transition type selection buttons

You can assign these buttons in setup to any transition type (see “Overall Control Panel Settings (Config Menu)” in Chapter 16 (Volume 2)). Press any of the following buttons, turning it on, to select the transition type.

Press one of these buttons, turning it on, to determine the type of the next transition for a background.

To select the key transition type, hold down the [KEY1] or [KEY2] button, and press one of the following buttons, turning it on. When multi-program mode is selected in the Setup menu (see “Settings for Switcher Configuration (Config Menu)” in Chapter 16 (Volume 2)), two or more of the following buttons may light.

MIX: In a background transition, the new video fades in as the current video

fades out. During the transition, the overall signal level is maintained at 100%.

In a key transition, the key fades in (for insertion) or out (for removal).

NAM (non-additive mix): The current and new video signals are compared, and the signal with the higher luminance level is given priority in the output. The current video is maintained at 100% output for the first half of the transition as the new video increases progressively to 100%, then the current video is progressively reduced from 100% to zero in the second half while the new video is maintained at 100%.

WIPE: The current video is replaced by the new video, using the wipe pattern selected in the Wipe menu.



DME: This applies a wipe-like transition, using the DME effect selected in the DME Wipe menu.

FM1&2CIIP, FM3&4CIIP, FM5&6CIIP, FM7&8CIIP: A recorded clip is played back together with the transition. At this point, you can also carry out a background transition (wipe or mix (dissolve)) simultaneously together with the clip.

2 Key transition selection buttons

To insert or delete key 1 on the next transition, hold down the [KEY1] button, and select the type of transition using the transition type selection buttons. If the key is currently not inserted, the transition will insert it, and if the key is currently inserted, the transition will delete it. You can use the [KEY2] button in a similar way.

While these buttons are held down, you can select a key source with the cross-point buttons on the key bus.

Pressing one of these buttons twice in rapid succession changes the state of the corresponding key bus so that a cross-point can be selected.

Key delegation button (double press)	Corresponding key bus
[KEY1]	key 1 ^{a)}
[KEY2]	key 2 ^{b)}

a) The key bus switching button [KEY3] in the cross-point control block goes off.

b) The key bus switching button [KEY4] in the cross-point control block goes off.

3 Transition execution section

Fader lever: Move this vertically to carry out a transition.

When the split fader function is enabled, by pressing the projection on the left side of the grip you can release the lock and separate the two halves of the fader lever. With the split fader

lever, in a background mix transition, you can control the background A and B buses independently.

Transition indicator: This comprises multiple LEDs, which show the progress of the transition.

Transition rate display: This displays the transition rate (the time from the beginning of the transition to its completion) set for an auto transition, in frames.

You can set the transition rate using the numeric keypad control block or menu.

TAKE button: Pressing this button carries out an auto transition of the set transition rate. The transition starts immediately, and the button lights amber. When the transition completes, the button goes off.

4 Wipe direction selection buttons

REV (reverse): When this button is off, the wipe proceeds in the normal direction. When the button is lit, the wipe proceeds in the reverse direction.

The normal direction refers to the black to white direction or in the direction of the arrow as shown in “Wipe Pattern List” (page 560) and “DME Wipe Pattern List” (page 566) in Appendix (Volume 1).

NORM/REV (normal/reverse): The wipe direction alternates between normal and reverse every time a transition is executed.

5 Pattern limit buttons

LIMIT SET: Move the fader lever to the position of a particular pattern size, and stop it there, then press this button to set the pattern limit range. This button is enabled when the [PTN LIMIT] button is off.

PTN (pattern) LIMIT: When a wipe or DME wipe is selected, pressing this

button, turning it on, enables the pattern limit function.

6 Key status display

For each of keys 1 and 2, when the key is inserted, the corresponding ON indicator lights. The OVER indicators show the priority between keys 1 and 2, by lighting when the corresponding key is on top. For example, when key 1 appears over key 2 on the program monitor, the OVER indicator for key 1 lights.

The following is the Flexi Pad control block.

7 Mode selection buttons

WIPE: When saving or recalling a wipe snapshot, use this in combination with the buttons of the memory recall section.

DME: When saving or recalling a DME wipe snapshot, use this in combination with the buttons of the memory recall section.

SNAPSHOT: When saving or recalling a snapshot, use this in combination with the buttons of the memory recall section.

8 Memory recall section

This consists of eight buttons with LCDs, whose display changes according to the operation mode. Use these in combination with the mode selection buttons to save or recall wipe snapshots, DME wipe snapshots, or snapshots.

9 UNDO button

After recalling a register, press this button to return to the state before recalling the register.

With a setup setting, this can be switched to a mode selection button for macro setting, and used in combination with the buttons in

the memory recall section for recalling and executing a macro.

10 XPT HOLD (cross-point hold) status display

A bus for which cross-point hold is set appears as a green light.

11 Numeric display

Depending on the operation mode, this shows a wipe or DME wipe pattern number, or a register number in up to four digits. In macro mode, this provides indications for macro editing.

12 INH (inhibit) button

Pressing this button, turning it on, disables the buttons in the memory recall section and the [UNDO] button.

Independent Key Transition Control Block (Simple Type)

The left side of this control block controls key 3, and the right side controls key 4. The control block for key 3 only is described as an example, but the operations on the key 4 control block are the same.

In setup you can assign any key to either side of this control block. For details, see “Assigning Keys to the Independent Key Transition Control Block (Simple Type)” in Chapter 16 (Volume 2).

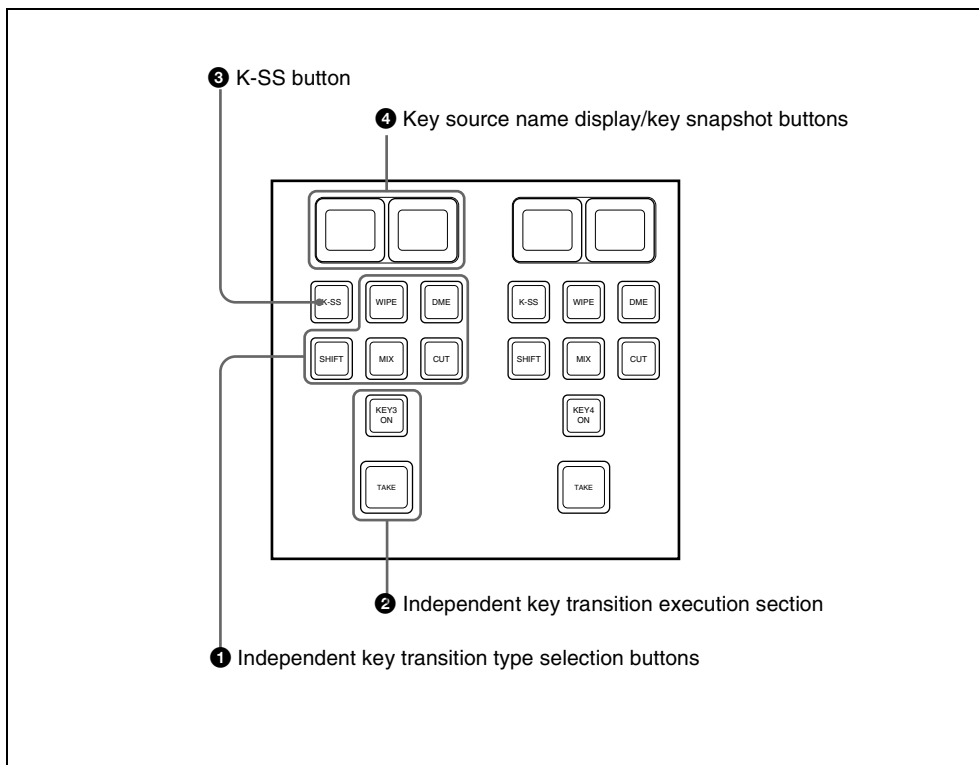

1 Independent key transition type selection buttons

Press one of the following buttons, turning it on, to select the independent key transition type.

MIX: Faded in or out.

WIPE: Inserted or deleted with a wipe.

DME: Switches the key with a DME wipe.

CUT: Inserted or deleted instantaneously.

SHIFT: This has the following functions.

- When setting is made in the Setup menu to allow a different transition type for inserting or deleting a key, it is possible to display and set the transition type after the next transition while this button is held down.

- While this button is held down, you can select a key source with the cross-point buttons for the key bus.
- If you press this button twice in rapid succession, the key bus selection button [KEY3] in the cross-point control block lights, and a key 3 key bus cross-point can be selected.
- If you press this button, while holding down [TRANS RATE] button in the numeric keypad control block, you can set the independent key transition rate on the control block.

② Independent key transition execution section

KEY3 ON button: This inserts or deletes key 3 instantaneously. When key 3 is present in the final program output from the switcher, this lights red, and otherwise lights amber.

TAKE button: This carries out an auto transition on key 3.

③ K-SS (key snapshot) button

This enables key snapshot mode. In key snapshot mode, it is possible to save and recall key snapshots.

④ Key source name display/key snapshot buttons

These show the signal name of the key fill selected for key 3 and the transition rate on two buttons. In key snapshot mode, these correspond to registers 1 and 2 for key 3; press to save or recall a key snapshot.

To save a key snapshot, with the [K-SS] button lit amber, hold down [SHIFT] button and press one of the key snapshot buttons. This saves a key snapshot in the button you pressed, which lights yellow.

Downstream Key Control Block

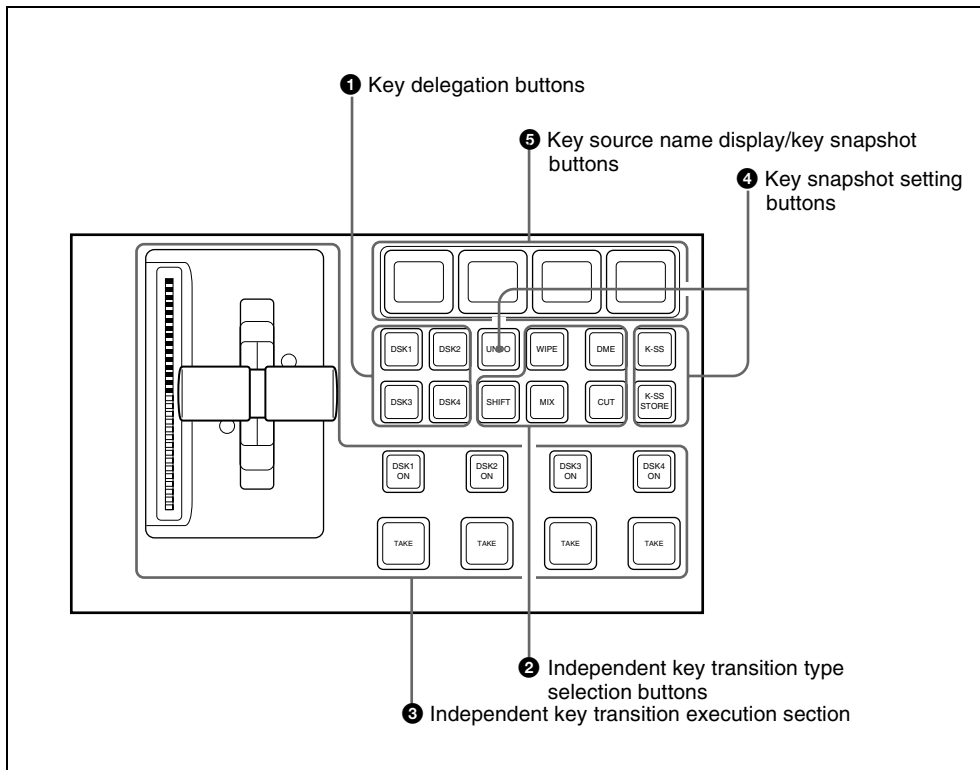

1 Key delegation buttons

Press one of the [DSK1] to [DSK4] buttons to delegate this control block to the corresponding keyer.

Using the Setup menu, it is possible to delegate this control block to key 1 to key 4 of the M/E bank.

While these buttons are held down, you can select a key source with the cross-point buttons for the key bus.

Pressing one of these buttons twice in rapid succession changes its state so that you can make cross-point selections on the corresponding key bus.

2 Independent key transition type selection buttons

Press one of these buttons, turning it on, to select the downstream key transition type.

MIX: Carry out a dissolve with the key selected with the key delegation buttons.

WIPE: Carry out a wipe with the key selected with the key delegation buttons.

DME: This switches the key selected with the key delegation buttons, using a DME wipe.

CUT: Instantaneously insert or delete the key selected with the key delegation buttons.

SHIFT: When setting is made in the Setup menu to allow a different transition type for inserting or deleting a key, it is possible to display and set the transition after the next transition while this button is held down.

③ Independent key transition execution section

DSK1 (downstream key 1) ON to DSK4

ON buttons: Press these to instantaneously cut the downstream keys 1, 2, 3, and 4 in or, when the downstream keys are already inserted, cut them out. When the key corresponding to the button appears in the final program output, the button lights red, and otherwise lights amber.

TAKE buttons: These correspond to downstream keys 1, 2, 3, and 4 from left to right; press to execute an auto transition. The transition starts immediately, and the button lights amber. When the transition completes, the button goes off.

Fader lever: Move this to carry out a manual downstream key transition.

Transition indicator: This comprises multiple LEDs, which show the progress of the downstream key transition.

④ Key snapshot setting buttons

K-SS (key snapshot): This enables key snapshot mode.

K-SS STORE (key snapshot store): To save a key snapshot, hold down this button, and press the key source name display/key snapshot button for the register you want to save.

UNDO (key snapshot recall undo): This undoes the last key snapshot recall.

⑤ Key source name display/key snapshot buttons

These display the selected source name for each corresponding keyer. In snapshot mode, they correspond to registers 1 to 4 of the selected keyer, and pressing the button saves or recalls a key snapshot.

Downstream Key/Fade-to-Black Control Block

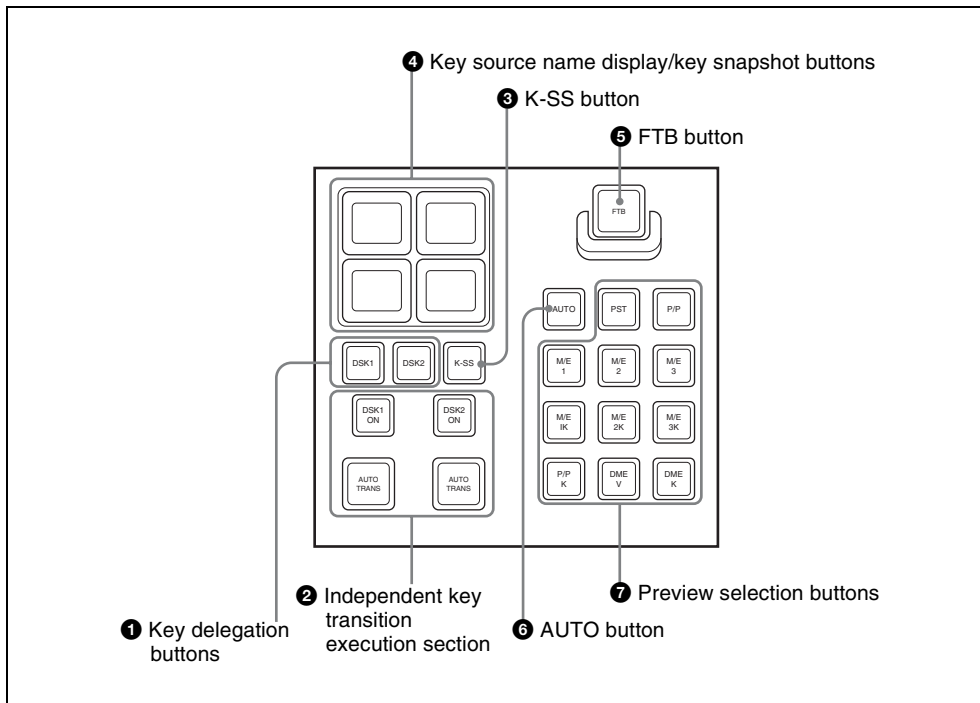

1 Key delegation buttons

Press DSK1 or DSK2, to select the keyer. Each button can be assigned to any key in setup (see Chapter 16 “Overall Control Panel Settings (Config Menu)” (Volume 2)).

While these buttons are held down, you can select a key source with the cross-point buttons on the key bus.

Pressing one of these buttons twice in rapid succession changes its state so that you can make cross-point selections on the corresponding key bus in the PGM/PST bank.

Key delegation button (double press)	Corresponding key bus
[DSK1]	key 1 ^{a)}

Key delegation button (double press)	Corresponding key bus
[DSK2]	key 2 ^{b)}

a) The key bus selection button [KEY3] in the P/P cross-point control block goes off.

b) The key bus selection button [KEY4] in the P/P cross-point control block goes off.

2 Independent key transition execution section

DSK1 ON, DSK2 ON buttons: Press these to cut in the corresponding downstream key 1 or 2. When the key is already inserted, pressing the button cuts it out. Each button lights red when the corresponding key is inserted in the program output (final output from the

switcher), and lights amber at other times.

AUTO TRANS buttons: The left button applies to DSK1 and the right button to DSK2; press these buttons to carry out an auto transition. The transition immediately starts, and the button lights amber. When the transition completes, the button goes off.

③ K-SS (key snapshot) button

Pressing this button, turning it on, enables the key snapshot mode. In this mode, you can save and recall key snapshots.

④ Key source name display/key snapshot buttons

Each column of two buttons relates to the corresponding downstream key 1 or 2. The upper button displays the name of the key fill signal selected for the key, and the lower button shows the transition rate. In key snapshot mode, these buttons correspond to registers 1 to 4 of the keyer selected with the key delegation buttons, and pressing a button recalls the key snapshot. To save a key snapshot, hold down the [STORE] button in the numeric keypad control block, and press the button for the desired register.

⑤ FTB (fade to black) button

Press this button to fade to black the program output of the PGM/PST bank, at the set transition rate. You can set the fade to black transition rate in the menu.

⑥ AUTO button

When this button is pressed, the M/E or PGM/PST bank preview signal selected on the edit preview bus is automatically switched to the program signal depending on the on-air status.

⑦ Preview selection buttons

Press one of these buttons to select a signal on the edit preview bus. Each button can be assigned to any preview output in setup (*see Chapter 16 “Overall Control Panel Settings (Config Menu)” (Volume 2)*).

PST (preset): When this button is pressed, the signal selected on the background B row of the PGM/PST bank is selected on the edit preview bus.

M/E 1 to M/E 3, P/P (M/E1 to M/E 3, P/P preview): The preview signal (M/E-1 PVW, M/E-2 PVW, M/E-3 PVW, P/P PVW) of the M/E or PGM/PST bank corresponding to the pressed button is selected on the edit preview bus.

M/E1 K to M/E3 K, P/P K (M/E1 to M/E 3, P/P key preview): The key preview signal (M/E-1 K-PVW, M/E-2 K-PVW, M/E-3 K-PVW, P/P K-PVW) of the M/E or PGM/PST bank corresponding to the pressed button is selected on the edit preview bus.

DME V (DME monitor video): When this button is pressed, the DME monitor output video signal (DME MON V) is selected on the edit preview bus.

DME K (DME monitor key): When this button is pressed, the DME monitor output key signal (DME MON K) is selected on the edit preview bus.

Transition Control Block (Compact Type)

The compact version of the transition control block shown in the following figure has fewer buttons than the standard type. Independent key transition operations can

also be controlled with the compact transition control block.

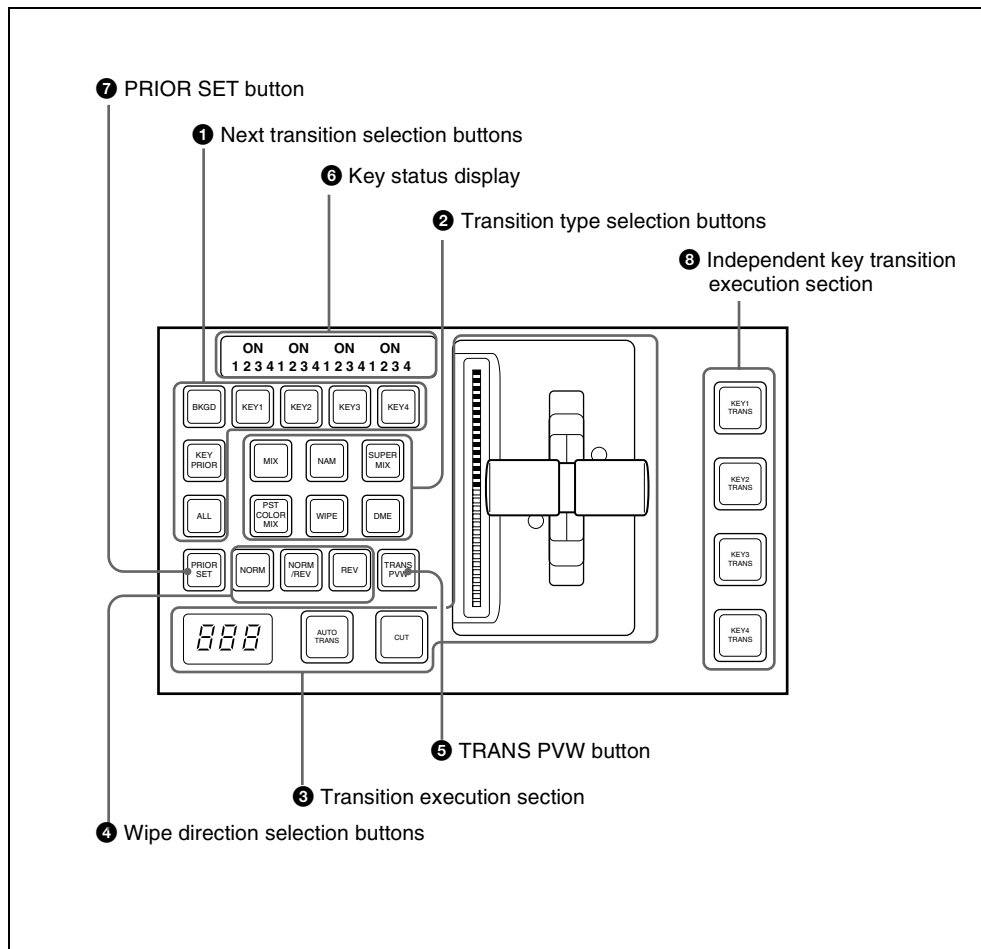

1 Next transition selection buttons
Press these buttons, turning them on, to determine what the next transition will apply to.
BKGD: Next transition changes the background.

KEY1 to KEY4 (DSK1 to DSK4 in the PGM/PST bank): Press this button, turning it on, to make the next transition insert or remove the corresponding key (keys 1 to 4). If a key is currently inserted it will be

removed, and if it is not currently inserted, it will be inserted.

In the PGM/PST bank, this inserts or removes downstream keys 1 to 4.

KEY PRIOR (priority): When this button is lit, the setting of the key priority after the next transition is enabled. The key priority after the next transition appears in the key status display.

ALL: Pressing this button turns on a preselected set of the [BKGD], [KEY1] to [KEY4], and [KEY PRIOR] buttons. Make this setting in a Setup menu.

② Transition type selection buttons

You can assign these buttons in setup to any transition type (see “Overall Control Panel Settings (Config Menu)” in Chapter 16 (Volume 2)).

Press one of these buttons, turning it on, to determine the type of the next transition. When multi-program mode is selected in the Setup menu (see “Settings for Switcher Configuration (Config Menu)” in Chapter 16 (Volume 2)), two or more of the following buttons may light.

MIX: In a background transition, the new video fades in as the current video fades out. During the transition, the overall signal level is maintained at 100%.

In a key transition, the key fades in (for insertion) or out (for removal).

NAM (non-additive mix): The current and new video signals are compared, and the signal with the higher luminance level is given priority in the output. The current video is maintained at 100% output for the first half of the transition as the new video increases progressively to 100%, then the current video is progressively reduced from 100% to zero in the second half while the new video is maintained at 100%.

SUPER MIX: The current video is maintained at 100% output for the first

half of the transition as the new video is mixed while increasing progressively to 100%. The current video is then progressively reduced from 100% to zero in the second half while the new video is maintained at 100%.

PST (preset) COLOR MIX: In the first transition, the current video is replaced by the color matte in a mix (dissolve), then in the second transition the color matte is replaced by the new video also in a mix (dissolve).

WIPE: The current video is replaced by the new video, using the wipe pattern selected in the Wipe menu.

DME: A wipe type of transition is carried out, using the DME effect selected in the DME Wipe menu.

FM1&2CIIP, FM3&4CIIP, FM5&6CIIP, FM7&8CIIP: A recorded clip is played back together with the transition. At this point, you can also carry out a transition (wipe or mix (dissolve)) simultaneously together with the clip.

③ Transition execution section

Transition indicator: This comprises multiple LEDs, which show the progress of the transition.

Fader lever: Move this to carry out a manual transition.

Transition rate display: This shows the “transition rate” (the time from the beginning of a transition to its completion) set for an auto transition, in frames.

You can set the transition rate using the numeric keypad control block, Flexi Pad control block, or menu.

AUTO TRANS (transition) button: Pressing this button carries out an auto transition of the set transition rate (duration). The transition starts immediately, and the button lights

amber. When the transition completes, the button goes off.

CUT button: Pressing this button carries out the transition as a cut (i.e. instantaneously).

4 Wipe direction selection buttons

When you have selected a wipe or DME wipe as the transition type, press one of these buttons, turning it on, to select the wipe direction.

NORM (normal): The wipe proceeds in the direction from black to white as shown on the pattern in the lists of patterns (see “Wipe Pattern List” (page 560) and “DME Wipe Pattern List” (page 566) in Appendix (Volume I)), or in the direction of the arrow.

When the VTR/disk recorder operation mode is enabled in setup, pressing this button plays the tape.

REV (reverse): The wipe proceeds in the opposite direction to that when the [NORM] button is pressed. When the VTR/disk recorder operation mode is enabled in setup, pressing this button cues the tape automatically to the start point.

NORM/REV (normal/reverse): The wipe direction alternates between normal and reverse every time a transition is executed.

When the VTR/disk recorder operation mode is enabled in setup, pressing this button stops the tape.

5 TRANS PVW (transition preview) button

When this button is lit, you can check in advance the video changes during the transition, on the preview output from the M/E or PGM/PST bank.

During the preview, you can use the fader lever, [AUTO TRANS] button, and [CUT] button. One of the following functions of this button can be selected in a Setup menu.

- When the transition completes, the system returns to the normal mode.
- The transition preview mode is maintained while this button is pressed.
- Switching is made between the transition preview mode and normal mode every time this button is pressed.

6 Key status display

For each of keys 1 to 4, the corresponding ON indicator lights when the key is inserted. It also shows the priority (1 to 4) of each key.

7 PRIOR (priority) SET button

While this button is held down, you can set the key priority.

The setting mode when this button is pressed depends on whether or not the [KEY PRIOR] button is lit, as follows.

- When the [KEY PRIOR] button is off, the current key priority is set.
 - When the [KEY PRIOR] button is lit, the key priority after the next transition is set.
- Press the [KEY PRIOR] button as required, to switch between these two modes. In either mode, hold down the [PRIOR SET] button, and press the button ([KEY1] to [KEY4]) corresponding to the key you want to bring to the front.

8 Independent key transition execution section

KEY1 TRANS (transition) to KEY4 TRANS (DSK1 TRANS to DSK4 TRANS in the PGM/PST block)

buttons: Press the corresponding one of these buttons to cut key 1 to key 4 in or out automatically at the set transition rate. When the key corresponding to the button appears in the final program output, the button lights red, and otherwise lights amber. During a transition, the button lights green.

Basic Menu Operations

Menu Organization

Operations on the MVS-8000 switcher system make frequent use of menu operations.

This section describes the menus and their interrelationships.

Overview

All detailed settings for basic operations such as transitions, keys, DME, or wipes, are made in menus. There are also menus for carrying out general system control, managing setting data, and initial setup.



To display the top menu

In the same way as for the top menu selection buttons in the menu control block, press each button to display the particular top menu in the menu display.

The top menu list button is the same as the default layout of the top menu selection buttons. However, even if the assignment of the top menu selection buttons is changed, this does not affect the top menu list.

To shut down the menus

Press the [Shutdown] button at the lower right.

This operation is the same as the shut down operation in the top menu window.

For details, "Shutting down the menus" (page 333).

About the Top Menu List

When the control panel is powered on, the top menu list appears as shown below. You can also display this by selecting VF1 'Top Menu List' after pressing the [HOME] button at the upper left in the top menu selection button area of the menu control block.

Accessing Menus

You can use any of the following methods to access a menu, and the initially displayed menu page depends on the method used.

- Pressing a top menu selection button in the menu control block.
This displays the page you last accessed in the particular menu. After initially powering on the system, however, the page of VF1 - HF1 of the particular menu is always selected.
- Pressing a button other than a top menu button twice in rapid succession (*see page 316*).
Depending on the button, this may display a fixed page or the page selected last time you accessed the menu.
- Press the menu page selection button at the top left of the menu display.
The top menu window appears; press the top menu selection button for the particular menu, or enter the menu number with the numeric keypad, and press the Enter button.

For details of the VF buttons and HF buttons, see “Interpreting the Menu Screen” (page 322).



Menus accessed from a top menu selection button

Buttons	Menus	Function	See
HOME	Home	Recalling menus using the top menu list or shortcut menu	Top menu list: page 313 Shortcut menu: page 335
M/E 1	M/E-1	Transition, keys, and wipe settings for the M/E-1 bank	page 348 (transitions), page 378 (keys), page 438 (wipes)
M/E 2	M/E-2	Transition, keys, and wipe settings for the M/E-2 bank	
M/E 3	M/E-3	Transition, keys, and wipe settings for the M/E-3 bank	
P/P	PGM/PST	Transition, downstream key, and wipe settings for the PGM/PST bank	
FRAME MEM	Frame Memory	Frame memory settings	page 490
COLOR BKGD	Color Bkgd	Color background settings	page 538
AUX/MON	Aux/Mon	AUX bus settings	page 555
CCR	CCR	Color corrector settings	Chapter 19 (Volume2)
COPY SWAP	Copy/Swap	Copy and swap settings	page 544
MISC	Misc	Safe title settings	page 548
STATS	Status	Status display	Chapter 11 (Volume2)
DME	DME	DME special effect settings	Chapter 11 (Volume 2)
GLB EFF	Global Effect	Global effect settings	Chapter 11 (Volume 2)
DEV	Device	Settings for external device operation	Chapter 12 (Volume 2)
MCRO	Macro	Macro register settings	Chapter 18 (Volume 2)
KEY FRAME	Key Frame	Keyframe settings	Chapter 13 (Volume 2)
EFF	Effect	Keyframe effect register settings	Chapter 13 (Volume 2)
SNAP SHOT	Snapshot	Snapshot register settings	Chapter 14 (Volume 2)
SHOTBOX	Shotbox	Shotbox register settings	Chapter 15 (Volume 2)
FILE	File	File settings	Chapter 17 (Volume 2)
ENG SETUP	Engineering Setup	Setup functions	Chapter 16 (Volume 2)
DIAG	Diagnosis	Status information display	Chapter 20 (Volume 2)

Menus accessed by pressing a button twice

For relevant buttons other than the top menu selection buttons, pressing twice in rapid succession directly recalls a related menu page. The following table lists these

buttons of each control block, together with the menus they recall. (XX represents the HF menu recalled last in the VF menu.)

Cross-point control block

Buttons	Menus	See
FM1 to 8 signals assigned buttons	Frame Memory >Still >Recall	page 500
Color Bkgd1 signal assigned button	Color Bkgd >Color Bkgd1	page 538
Color Bkgd2 signal assigned button	Color Bkgd >Color Bkgd2	
CCR1 signal assigned button	CCR >CCR1 >XX	Chapter 19 (Volume 2)
CCR2 signal assigned button	CCR >CCR2 >XX	

Transition control block (standard type, compact type)

Buttons	Menus	See
KEY1 (DSK1) ^{a)}	<ul style="list-style-type: none"> M/E-1, 2, 3 >Key1 >XX PGM/PST >DSK1 >XX 	page 378
KEY2 (DSK2) ^{a)}	<ul style="list-style-type: none"> M/E-1, 2, 3 >Key2 >XX PGM/PST >DSK2 >XX 	
KEY3 (DSK3) ^{a)}	<ul style="list-style-type: none"> M/E-1, 2, 3 >Key3 >XX PGM/PST >DSK3 >XX 	
KEY4 (DSK4) ^{a)}	<ul style="list-style-type: none"> M/E-1, 2, 3 >Key4 >XX PGM/PST >DSK4 >XX 	
WIPE	M/E-1, 2, 3, PGM/PST >Wipe >Main Pattern	page 438
DME	M/E-1, 2, 3, PGM/PST >DME Wipe >XX	page 467
SUPER MIX	M/E-1, 2, 3, PGM/PST >Misc >Transition	page 349
PST COLOR MIX	M/E-1, 2, 3, PGM/PST >Misc >Transition	page 350
FM1&2 CLIP, FM3&4 CLIP, FM5&6 CLIP, FM7&8 CLIP	M/E-1, 2, 3, PGM/PST >Misc >Clip Transition	page 524
PRIOR SET	M/E-1, 2, 3, PGM/PST >Misc >Key Priority	page 345
KEY PRIOR	M/E-1, 2, 3, PGM/PST >Misc >Next Key Priority	page 346
WIPE (Independent key transition type selection button (standard type))	<ul style="list-style-type: none"> M/E-1, 2, 3 >Key1, 2, 3, 4 >Transition >Wipe Adjust >Pattern Select PGM/PST >DSK1, 2, 3, 4 >Transition >Wipe Adjust >Pattern Select 	page 455

Transition control block (standard type, compact type)

Buttons	Menus	See
DME (Independent key transition type selection button (standard type))	<ul style="list-style-type: none"> M/E-1, 2, 3 >Key1, 2, 3, 4 >Transition >DME Wipe Adjust >1ch Pattern Select PGM/PST >DSK1, 2, 3, 4 >Transition >DME Wipe Adjust >1ch Pattern Select 	page 477
K-SS STORE	Snapshot >Key Snapshot >XX	Chapter 14 (Volume 2)

a) Including the key delegation buttons of the transition control block (standard type).

Independent key transition control block (simple type) ^{a)}

Buttons	Menus	See
WIPE	<ul style="list-style-type: none"> M/E-1, 2, 3 >Key1, 2, 3, 4 >Transition >Wipe Adjust >Pattern Select PGM/PST >DSK1, 2, 3, 4 >Transition >Wipe Adjust >Pattern Select 	page 455
DME	<ul style="list-style-type: none"> M/E-1, 2, 3 >Key1, 2, 3, 4 >Transition >DME Wipe Adjust >1ch Pattern Select PGM/PST >DSK1, 2, 3, 4 >Transition >DME Wipe Adjust >1ch Pattern Select 	page 477
SHIFT	<ul style="list-style-type: none"> M/E-1, 2, 3 >Key1, 2, 3, 4 >XX PGM/PST >DSK1, 2, 3, 4 >XX 	page 378

a) The menu to be recalled depends on the setup of the key assignment.

Flexi Pad control block (standard type)

Buttons	Menus	See
WIPE	M/E-1, 2, 3, PGM/PST >Wipe >Main Pattern	page 438
DME	M/E-1, 2, 3, PGM/PST >DME Wipe >XX	page 467
SNAPSHOT	Snapshot >Snapshot >XX	Chapter 14 (Volume 2)
EFF	Effect >Effect 1-99 >XX	Chapter 13 (Volume 2)
SHOTBOX	Shotbox >Register >Store/Recall	Chapter 15 (Volume 2)
MCRO	Macro >Register >XX	Chapter 18 (Volume 2)



Key control block ^{a)}

Buttons	Menus	See
KEY1	<ul style="list-style-type: none"> M/E-1, 2, 3 >Key1 >XX PGM/PST >DSK1 >XX 	page 378
KEY2	<ul style="list-style-type: none"> M/E-1, 2, 3 >Key2 >XX PGM/PST >DSK2 >XX 	
KEY3	<ul style="list-style-type: none"> M/E-1, 2, 3 >Key3 >XX PGM/PST >DSK3 >XX 	
KEY4	<ul style="list-style-type: none"> M/E-1, 2, 3 >Key4 >XX PGM/PST >DSK4 >XX 	
LUM	<ul style="list-style-type: none"> M/E-1, 2, 3 >Key1, 2, 3, 4 >Type PGM/PST >DSK1, 2, 3, 4 >Type 	page 379
LIN		
CVK		
PTN		
CRK	<ul style="list-style-type: none"> M/E-1, 2, 3 >Key1, 2, 3, 4 >Type >Chroma Adjust PGM/PST >DSK1, 2, 3, 4 >Type >Chroma Adjust 	page 382

a) The menu recalled depends on which of the M/E delegation buttons and key delegation buttons are selected in the key control block.

Numeric keypad control block

Buttons	Menus	See
EFF	<ul style="list-style-type: none"> Effect >Effect 1-99 >XX ^{b)} Effect >Master Timeline >Store ^{c)} 	Chapter 13 (Volume 2)
SNAPSHOT	<ul style="list-style-type: none"> Snapshot >Snapshot >XX ^{b)} Snapshot >Master Snapshot >Store ^{c)} 	Chapter 14 (Volume 2)
SHOTBOX	Shotbox >Register >Store/Recall	Chapter 15 (Volume 2)
MCRO	Macro >Register >XX	Chapter 18 (Volume 2)
TRANS RATE ^{a)}	Misc >Transition	page 355
STORE RCALL	Key Frame >Region Select ^{d)}	Chapter 13 Chapter 14 (Volume 2)

a) The menu recalled depends on which of the M/E-1 to M/E-3 banks and PGM/PST bank the numeric control block is delegated to.

b) When other than [MASTR] is selected with the region selection buttons.

c) When [MASTR] is selected with the region selection buttons.

d) When the [SNAPSHOT] button or [EFF] button is set to On, or lit green.

Downstream key control block ^{a)}

Buttons	Menus	See
DSK1	<ul style="list-style-type: none"> M/E-1, 2, 3 >Key1 >XX PGM/PST >DSK1 >XX 	page 378
DSK2	<ul style="list-style-type: none"> M/E-1, 2, 3 >Key2 >XX PGM/PST >DSK2 >XX 	
DSK3	<ul style="list-style-type: none"> M/E-1, 2, 3 >Key3 >XX PGM/PST >DSK3 >XX 	
DSK4	<ul style="list-style-type: none"> M/E-1, 2, 3 >Key4 >XX PGM/PST >DSK4 >XX 	
WIPE	<ul style="list-style-type: none"> M/E-1, 2, 3 >Key1, 2, 3, 4 >Transition >Wipe Adjust >Pattern Select PGM/PST >DSK1, 2, 3, 4 >Transition >Wipe Adjust >Pattern Select 	page 455
DME	<ul style="list-style-type: none"> M/E-1, 2, 3 >Key1, 2, 3, 4 >Transition >Wipe Adjust >Pattern Select PGM/PST >DSK1, 2, 3, 4 >Transition >DME Wipe Adjust >Pattern Select 	page 477
K-SS STORE ^{b)}	Snapshot >Key Snapshot >XX	Chapter 14 (Volume 2)

a) The menu recalled depends on which of keyers 1 to 4 the downstream key control block is delegated to.

b) Recalling is possible only when the [K-SS] button is On.

Auxiliary bus control block

Buttons	Menus	See
FMS1, FMS2	Frame Memory >Still >Freeze/Store	page 496
FM1 to 8 signals assigned buttons	Frame Memory >Still >Recall	page 500
Color Bkgd1 signal assigned button	Color Bkgd >Color Bkgd1	page 538
Color Bkgd2 signal assigned button	Color Bkgd >Color Bkgd2	
CCR1 signal assigned button	CCR >CCR1 >XX	Chapter 19 (Volume 2)
CCR2 signal assigned button	CCR >CCR2 >XX	

Device control block (trackball or joystick)

Buttons	Menus	See
DME1 to DME8 ^{a)}	DME >XX	Chapter 11 (Volume 2)
DEV1 to DEV12 assigned buttons	<ul style="list-style-type: none"> Device >DDR/VTR >Cueup & Play ^{b)} Device >DDR/VTR >Timeline ^{c)} 	Chapter 12 (Volume 2)

Device control block (trackball or joystick)

Buttons	Menus	See
FM1CLIP to FM8CLIP assigned buttons	Frame Memory >Clip >Recall	–
K1 to K4 ^{d)}	<ul style="list-style-type: none"> M/E-1, 2, 3 >Key1, 2, 3, 4 >Processed Key PGM/PST >DSK1, 2, 3, 4 >Processed Key 	page 419

- a) When the three-dimensional transformation operation mode is enabled.
 b) When the [MENU] button is Off.
 c) When the [MENU] button is On.
 d) For the MVS-8000G in resizer control mode

Device control block (search dial)

Buttons	Menus	See
DEV1 to DEV12	<ul style="list-style-type: none"> Device >DDR/VTR >Cueup & Play ^{a)} Device >DDR/VTR >Timeline ^{b)} 	Chapter 12 (Volume 2)
FM1CLIP to FM8CLIP assigned buttons	Frame Memory >Clip >Recall	–

- a) When the [TIMELINE] button is Off.
 b) When the [TIMELINE] button is On.

Downstream key/fade-to-black control block

Buttons	Menus	See
DSK1, DSK2	<ul style="list-style-type: none"> PGM/PST >DSK1, 2 >XX ^{a)} 	Chapter 16 (Volume 2)

- a) When a key other than DSK1 or DSK2 is assigned, the menu for the corresponding key appears.

Transition control block and Flexi Pad control block (simple type)

Buttons	Menus	See
KEY1 (DSK1)	<ul style="list-style-type: none"> M/E-1, 2, 3 >Key1 >XX PGM/PST >DSK1 >XX 	page 378
KEY2 (DSK2)	<ul style="list-style-type: none"> M/E-1, 2, 3 >Key2 >XX PGM/PST >DSK2 >XX 	
WIPE	<ul style="list-style-type: none"> M/E-1, 2, 3 >Wipe >Main Pattern PGM/PST >Wipe >Main Pattern 	page 438
DME	<ul style="list-style-type: none"> M/E-1, 2, 3 >DME Wipe >XX PGM/PST >DME Wipe >XX 	page 467
SNAPSHOT	Snapshot >Snapshot >XX	Chapter 14 (Volume 2)
MCRO ^{a)}	Macro >Register >XX	Chapter 18 (Volume 2)

- a) When the button is assigned to macro function in the Setup menu.

Displaying a Menu

To display, for example, the M/E-1 >Key1 >Type menu, use either of the following operations.

- Press the top menu selection button [M/E 1], then press the VF1 ‘Key1’ button and the HF1 ‘Type’ button in that order.
- Press the menu page number button in the upper left corner of the menu screen to display the top menu window, then enter

the page number of the M/E-1 >Key1 >Type menu, which is 1111, and press the [Enter] button.

For details of the menu page numbers, see the appendix “Menu Tree” (Volume 2).

The M/E-1 >Key1 >Type menu appears in the menu display as follows.

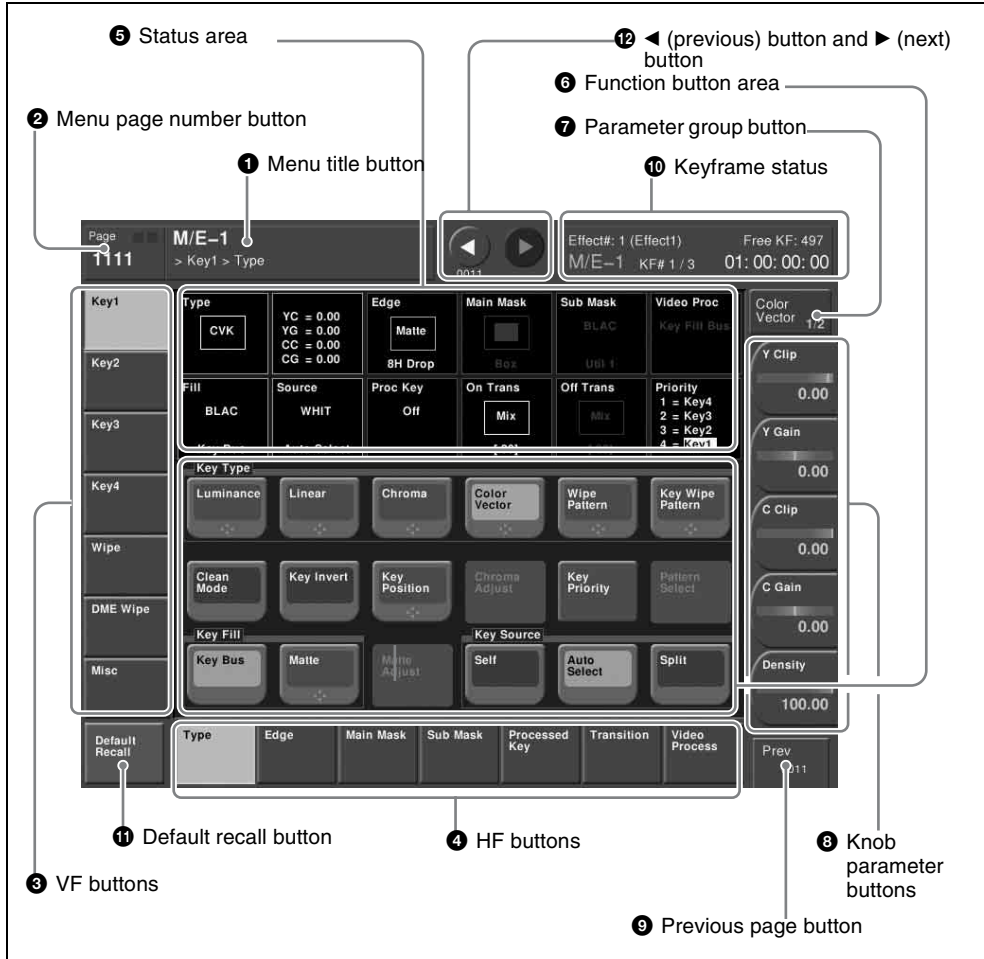

M/E-1 >Key1 >Type menu

Interpreting the Menu Screen

The menu screen consists of the following principal parts.

When buttons on the screen are lit or represented in a depressed state, this indicates that the corresponding item or function is selected (set on).

1 Menu title button

This shows the title of the menu screen. You can set different colors for the main menu site and subsidiary menu site (see page 335).

2 Menu page number button

This shows the menu screen page number. When you press this button, the top menu window (see page 332) appears. You can enter the page number for the desired menu, or press one of the top menu selection buttons in the window, to display that menu.

While the system is accessing the hard disk, the indicator lights red.

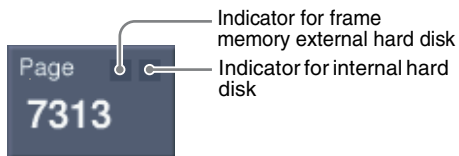

Note

When the indicator is lit, do not power off the switcher, or disconnect the IEEE1394 cable ¹⁾.

1) When an external hard disk drive is connected

3 VF buttons

These indicate the larger subdivisions of this menu.

Depending on the selected item, the menu screen contents including the HF button indications change.

4 HF buttons

These indicate the items within the menu. Depending on the selected item, the menu indications change.

Depending on the function, if any one is on, the status is shown by an orange bar, as in the following figure.



5 Status area

This shows the status of the settings items controlled by the selected menu.

An orange frame appears around the parameter area relating to the displayed menu. For each of the twelve areas, pressing the display jumps to the related menu.

6 Function button area

This shows the functions which can be operated in the currently selected menu by means of buttons.

Each function button corresponds to a function which can be set in the currently selected menu. Press it to enable the function, to display a parameter group and adjust the parameters with the knobs, or to execute the function.

These buttons are in groups by function. In the screen example shown on the previous page, the [Key Bus] and [Matte] function buttons constitute the <Key Fill> group.

7 Parameter group button

This displays parameter group names for which the knobs can make adjustments, the current parameter setting page number, and



the total number of the parameter setting pages. (Example: Color Vector 1/2)

When there are more than five parameters within the same parameter group, press this button to display the sixth and subsequent parameters, which can then be controlled by the knobs.

8 Knob parameter buttons

These show the parameters currently controlled by the knobs and their values. Pressing one of these buttons displays the numeric keypad window (*see page 330*), and you can then enter a new value for the corresponding parameter with the numeric keypad.

9 Previous page button

This shows the page number of the previously displayed menu screen. Press it to go back to that page. When the indication [Parent] appears, this displays the parent directory.

10 Keyframe status

This shows the keyframe status of the reference region. Pressing this button switches the menu screen as follows.

When a menu other than the Key Frame menu is currently shown: The menu screen switches to the Key Frame menu.

When the Key Frame menu is currently shown: The menu screen switches to the menu that was on the screen immediately before the Key Frame menu.

In some parts of menus such as the File menu, this functions as a “Region selection area,” for selecting the region to which operations apply.

11 Default recall button

This only appears in those menus for which the default recall function is available. (*See*

“Menus allowing a return to default settings” (page 325).)

Press this button, turning it on, then press a VF button or knob parameter button to return the settings to their default values, in the following groupings.

- Function grouping: the functions within an HF menu under the VF button
- Knob parameters (parameters currently controlled by the knobs)

12 ◀ (previous) button and ▶ (next) button

The ◀ button returns to the previous menu. Press the ▶ button to continue to the next menu.

Menu Operations

Selecting an item

1 Press the VF button (1 to 7) for the desired group of items.

The HF button (1 to 7) indications change to show the items within the selected group.

2 Press the HF button for the desired item.

The indications in the status area and function button area change, and you can now make various changes to the selected item.

Selecting a function

Press the appropriate function button within the function button area.

Shape and color of the button

Pressing the button turns it on, and it lights, showing the state.

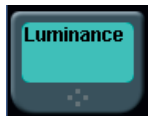

Lit pale blue: The function is enabled, and the parameters can currently be adjusted with the knobs.

Lit orange: The function is enabled.

Lit purple: Execution button. Pressing the button immediately executes the function. (Example: [Auto Start] button in the Chroma Adjust menu)



Pressing a button of this type displays a further menu, allowing more detailed settings. (Example: [Chroma Adjust] button in the Type menu)

Example: When wipe pattern key is selected

Knob	Parameter	Adjustment	Setting values
1	Size	Pattern size	0.00 to 100.00
2	Soft	Edge softness	0.00 to 100.00
3	Density	Key density	0.00 to 100.00

When the [MENU] button in the device control block is lit, you can use the trackball and Z-ring to control the parameters.

- Move the trackball on the x-axis to control the parameter for knob 1 or on the y-axis to control the parameter for knob 2. Moving up or to the right increases the parameter value, and moving down or to the left decreases the parameter value.
- Use the Z-ring to adjust the parameter for knob 3. Turning clockwise increases the parameter value, and turning counterclockwise decreases the parameter value.

Setting parameters



This marking on a function button indicates that there are parameters which can be adjusted with the knobs.

Pressing this function button assigns parameters to the knobs.

You can set the parameter values by either of the following methods.

- Turn the knob (1 to 5) corresponding to the parameter, to adjust the value.
- Press the knob parameter buttons (1 to 5) corresponding to the parameter. This displays the numeric keypad window allowing you to enter the desired value.

In the description of specific setting procedures, the knob adjustment is described, as follows.

Going back to the previous menu

To return to the last displayed menu, press the previous page button.

Returning to default state in function groupings

- 1 Press the [Default Recall] button, turning it on.

This enters the menu default recall mode.

- 2 Press the VF button you want to return to the default state.

This returns the settings within the function grouping to the default state, and the [Default Recall] button goes off.

Note

The default state of the settings depends on the setting of the initial status mode, set in the Setup menu of system setup, as follows.

User: The state when [Initial Status Define] is executed.

Factory: Factory default settings

Returning knob parameters to default state

1 Press the [Default Recall] button, turning it on.

This enters the menu default recall mode.

2 Press the knob parameter button you want to return to the default state.

This returns the knob parameter value to the default state, and the [Default Recall] button goes off.

Notes

- In the following table, “Menus allowing a return to default settings,” the default recall function does not apply to some knob parameters. For details, see the table, “Knob parameters subject to restriction on default recall” on page 328.
- The default recall function does not return the horizontal (H) and vertical (V) position settings to their default state individually. Returning the horizontal (H) position to its default state also returns the vertical (V) position to its default state automatically, and vice versa. For details, see the table, “Knob parameters subject to restriction on default recall” on page 328.

Menus allowing a return to default settings

Top menu selection button name	VF number (HF number)	Menu number	Menu name
M/E1	VF1	1110-series	Key1 ^{a)}
	VF2	1120-series	Key2 ^{a)}
	VF3	1130-series	Key3 ^{a)}
	VF4	1140-series	Key4 ^{a)}
	VF5	1150-series	Wipe ^{a)}
	VF6	1160-series	DME Wipe ^{a)}
	VF7	1170-series	Misc ^{a)}





Top menu selection button name	VF number (HF number)	Menu number	Menu name
M/E2	VF1	1210-series	Key1 ^{a)}
	VF2	1220-series	Key2 ^{a)}
	VF3	1230-series	Key3 ^{a)}
	VF4	1240-series	Key4 ^{a)}
	VF5	1250-series	Wipe ^{a)}
	VF6	1260-series	DME Wipe ^{a)}
	VF7	1270-series	Misc ^{a)}
M/E3	VF1	1310-series	Key1 ^{a)}
	VF2	1320-series	Key2 ^{a)}
	VF3	1330-series	Key3 ^{a)}
	VF4	1340-series	Key4 ^{a)}
	VF5	1350-series	Wipe ^{a)}
	VF6	1360-series	DME Wipe ^{a)}
	VF7	1370-series	Misc ^{a)}
P/P	VF1	1410-series	DSK1 ^{a)}
	VF2	1420-series	DSK2 ^{a)}
	VF3	1430-series	DSK3 ^{a)}
	VF4	1440-series	DSK4 ^{a)}
	VF5	1450-series	Wipe ^{a)}
	VF6	1460-series	DME Wipe ^{a)}
	VF7	1470-series	Misc ^{a)}
COLOR BKGD	VF1	2210	Color Bkgd 1 ^{a)}
	VF2	2220	Color Bkgd 2 ^{a)}
CCR	VF1	2410-series	CCR1 ^{a)}
	VF2	2420-series	CCR2 ^{a)}
FRAME MEM	VF1	2510-series	Still ^{b)}
	VF2	2520-series	Clip ^{b)}
	VF3	2530-series	Reposition/Lock ^{b)}
	VF4	2540-series	File ^{b)}
	VF5	2550-series	Folder ^{b)}
AUX/MON	VF1	2311	Aux Bus ^{b)}



Top menu selection button name	VF number (HF number)	Menu number	Menu name
DME	VF1	4110-series	Edge ^{b)}
	VF2	4120-series	Video Modify ^{b)}
	VF3	4131	Freeze ^{b)}
	VF4	4141	Non-Linear ^{b)}
	VF5	4150-series	Light/Trail ^{b)}
	VF6	4160-series	Input/Output ^{b)}
	VF7	4170-series	Enhanced Video Modify ^{b)}
GLB EFF	VF1	4210-series	Ch1–Ch4 ^{b)}
	VF2	4220-series	Ch5–Ch8 ^{b)}
KEY FRAME	(HF3)	6113	Path ^{b)}

- a) Menu to return to the default settings for particular functions or for particular knob parameters (for the relevant knob parameters, see page 327)
- b) Menu to return to the default settings for particular knob parameters (for the relevant knob parameters, see page 327)

Knob parameters to which default recall does not apply

Menu number ^{a)}	Menu name	Button name	Knob	Parameter
1111	Type	[Luminance] and [Linear] in <Key Type> group	4	Filter
		[Color Vector] in <Key Type> group	1 2 (Parameter group [2/2])	Y Filter, C Filter
1111.1	Type >CRK Adjust	[Key Active]	5	Filter
		[Color Cancel] in <Color Cancel> group	5	Filter
1112.1	Edge >Matte	[Mix Color] in <Edge Matte> group	5	Pattern
		[Multi]	3	Invert Type
1113	Main Mask	[Pattern]	5	Pattern
		[Multi]	3	Invert Type

Knob parameters to which default recall does not apply

Menu number ^{a)}	Menu name	Button name	Knob	Parameter
1116	Transition	[Wipe] in <ON Transition Type> group	1 5	Transition Rate Pattern
		[Wipe] in <OFF Transition Type> group	1 5	Transition Rate Pattern
		[Key Blink] and [Edge Blink] in <Blink> group	1	Blink Rate
		[Mix] in <Transition Type> group	1	Transition Type
		[Wipe] in <Transition Type> group	1 5	Transition Rate Pattern
1116.1	Transition > Wipe Adjust	[Multi]	3	Invert Type
		[H] and [V] in <Pairing> group	1	Width
		[H], [V], and [Fringe] in <Modulation> group	4	Shape
1154	Edge/Direction	[Split] in <Edge> group	1	Split No
1154.1	Edge/Direction > Matte Adjust	[Mix Color] in <Edge Matte> group	3	Pattern
		[Multi]	3	Invert Type
1155	Main Modify	[H] and [V] in <Pairing> group	1	Width
		[H], [V], and [Fringe] in <Modulation> group	4	Shape
1164	Edge/Direction	[Independent Trans Rate] in <Pattern Limit Release> group	1	Transition Rate
1171	Transition	[Mix], [Nam], [Super Mix], [Preset Color Mix], [Wipe], [DME Wipe], and [FTB] in <Transition Type> group	1	Transition Rate

a) The menu numbers shown by way of example are those for M/E-1: the same applies for M/E-2, M/E-3, and P/P. Also, content applying to Key1 applies equally to Key2, Key3, and Key4.

Knob parameters subject to restriction on default recall

Menu number	Menu name	Button name	Knob	Parameter
1111.1 ^{a)}	Type >CRK Adjust	[Sample Mark] in the <Auto> group	1 2	Position H Position V
1112.1 ^{a)}	Edge >Matte Adjust	[Position]		
1113 ^{a)}	Main Mask	[Position]		
1116.1 ^{a)}	Transition >Wipe Adjust	[Position]		



Knob parameters subject to restriction on default recall

Menu number	Menu name	Button name	Knob	Parameter
1116.3 ^{a)}	Transition >DME Wipe Adjust	[Position]	1 2	H V
1154.1 ^{a)}	Edge Direction >Matte Adjust	[Position]	1 2	Position H Position V
1155 ^{a)}	Main Modify	[Position] in the <Position> group		
1155.1 ^{a)}	Main Modify >Multi Adjust	[Position]		
1156 ^{a)}	Sub Modify	[Position] in the <Position> group		
1156.1 ^{a)}	Sub Modify >Multi Adjust	[Position]		
2122.2	Composite >Pattern Adjust	[Position]		
2131	Reposition	[Normal]		
		[Black&White]		
2210	Color Bkgd1 ^{b)}	[Position]		
2412.1 ^{c)}	Primary CCR >Mask1 Adjust ^{d)}	[Position]		
4116	DME >Edge >Wipe Crop	[Position/Size]	5	Pattern
4127	DME >Video Modify >Mask	[Position/Size]		

- a) The menu numbers shown by way of example are those for M/E-1: the same applies to M/E-2, M/E-3, and P/P. Equally, content applying to Key1 applies equally to Key2, Key3, and Key4.
b) The same applies to Color Bkgd2.
c) The menu numbers shown by way of example are those for CCR1: the same applies to CCR2.
d) The sample applies to Mask2 Adjust.

Numeric keypad window

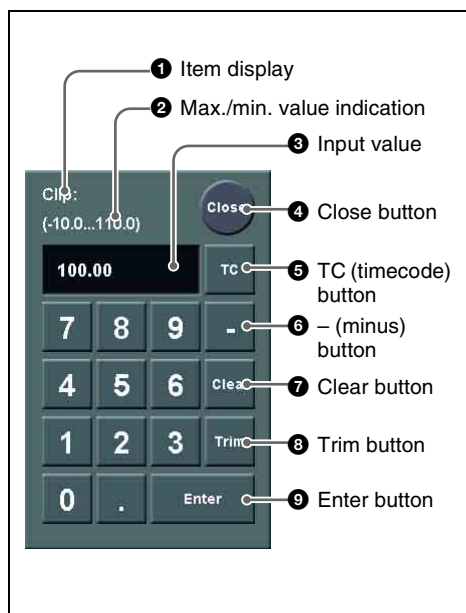

1 Item display

This is the name of the parameter being set in the numeric keypad window.

2 Max./min. (maximum/minimum) value indication

This shows the maximum and minimum settings of the parameter.

3 Input value

This is the value being input into the numeric keypad window.

4 Close button

This closes the numeric keypad window.

5 TC (timecode) button

When the numeric keypad window is opened for a setting requiring a timecode value to be entered, this button appears in a depressed state.

You can enter a timecode value in the range that depends on the signal format (*see page 189*) as follows:

00:00:00:00 to 23:59:59:nn,
where nn = (number of frames per second) – 1.

6 - (minus) button

This toggles the sign of the entered value. When it is pressed, the value is negative.

7 Clear button

This clears the input. It does not change the parameter setting.

8 Trim button

After entering the difference from the current value, press this button to confirm the numeric input.

9 Enter button

This confirms the entered value. If correctly set, the numeric keypad window closes. If not correctly set, the input display changes color.

Keyboard window

Note

Except when changing source names, the following characters cannot be used. The same applies to macro file editing.

space, \, /, ;, :, , (comma), . (dot), <, >, *, ?, ", |

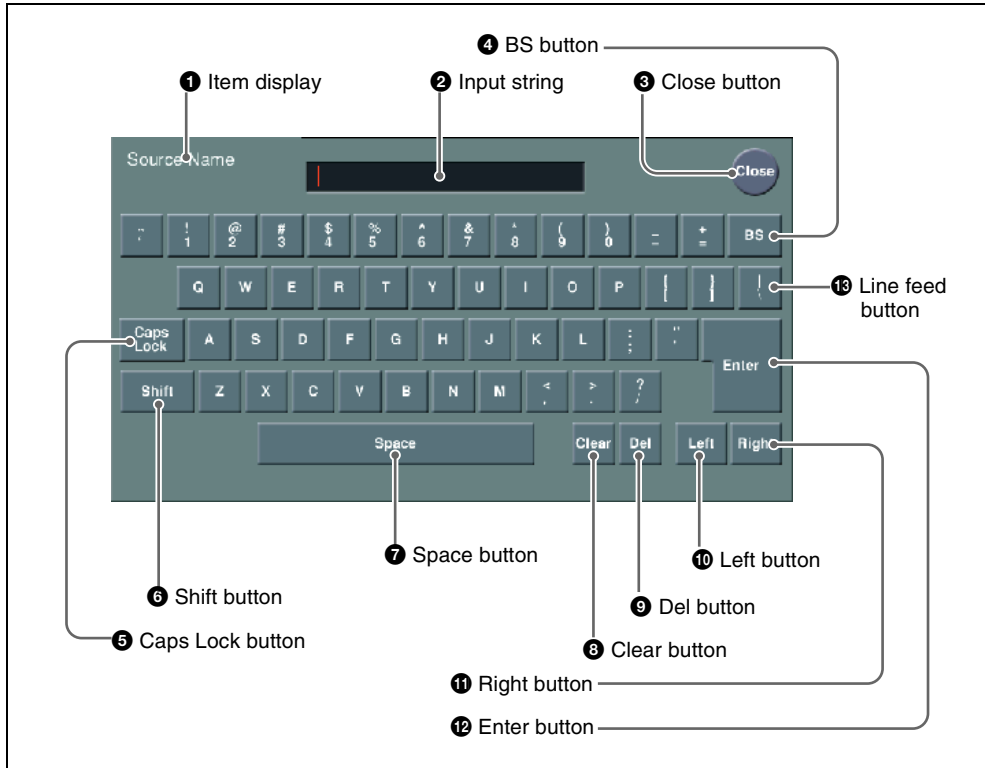

1 Item display

This is the name of the parameter being set in the keyboard window.

2 Input string

This is the character string being input in the keyboard window.

3 Close button

This closes the keyboard window.

4 BS button

This clears the character immediately before the cursor in the input string.

5 Caps Lock button

This enables input of capital letters only.

Note

You can enter items to be displayed on the control panel LCD using lowercase letters, but these will be converted to capitals for display.

MS-DOS does not distinguish case in filenames, and therefore you are recommended to enter filenames in capital letters.

6 Shift button

This selects the characters on the shift side of the keys. The shift is released when you enter a character.

7 Space button

This enters a space character.

8 Clear button

This clears all of the characters in the input string.

9 Del button

This clears the character immediately after the cursor in the input string.

10 Left button

This moves the cursor one character to the left in the input string.

11 Right button

This moves the cursor one character to the right in the input string.

12 Enter button

This sets the input string as a parameter value, and closes the keyboard window if the value has been entered correctly. If the value has not been entered correctly, the display color changes.

13 Line feed button

After pressing the Shift button, press this button to feed a line. The input string shows “|”.

Function of the top menu window

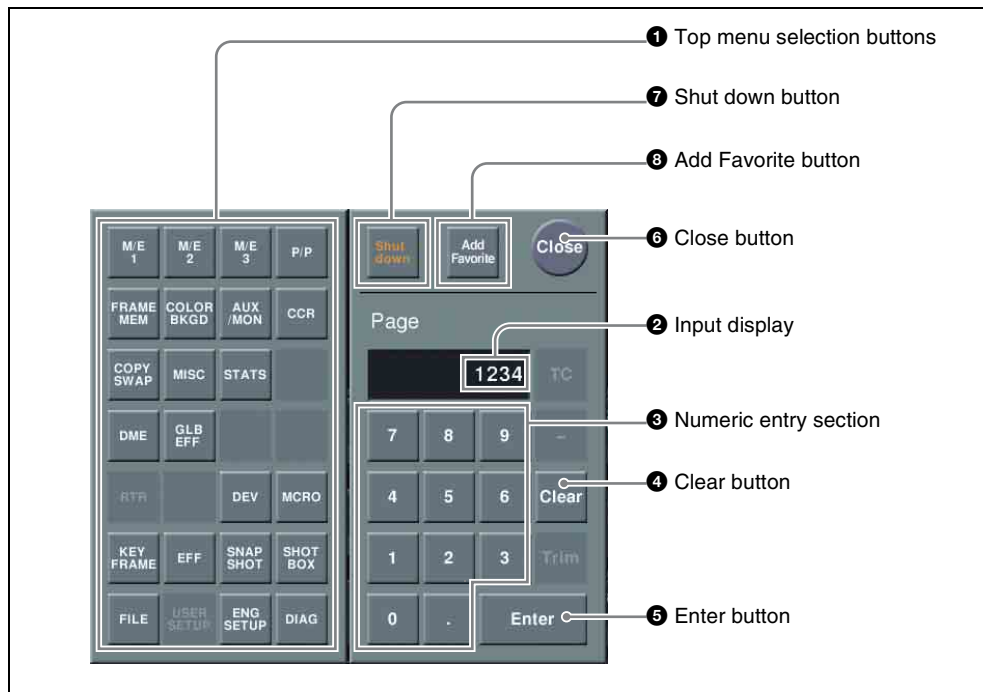

1 Top menu selection buttons

These are the same as the top menu selection buttons in the menu control block. Pressing one of these buttons closes the top menu window and displays the selected menu in the menu display.

2 Input display

This shows the page number entered with the numeric entry section.

3 Numeric entry section

Enter a page number.

4 Clear button

Press this to clear the input display.

5 Enter button

Pressing this button without entering a page number closes the top menu window with the current menu remaining in the menu display.

If you enter a page number then press this button, this confirms the value in the input display. If it is a correct page number, the top menu window closes, and the menu display shows the new menu. If it is not correctly set, the input display changes color.

6 Close button

Press this to close the top menu window.

7 Shut down button

Shuts down the menus.

Note

Be sure to shut down the menus before powering off the control panel.

Use of the color palette window

When a parameter is assigned to the knobs as a combination of luminance, saturation,

Shutting down the menus

- 1 In the menu screen, press the menu page number button to open the top menu window.

For details of the top menu window, see “Function of the top menu window” (page 332).

- 2 Press [Shut down].

A confirmation message appears.

- 3 Press [Yes].

This shuts down the menu system after a while, and the menu display changes to black. Now power off the system.

To restart menu operations

Power on the control panel once more.

8 Add Favorite button

Pressing this button allows the currently displayed menu to be registered to the Shortcut menu.

Registering a menu to the Shortcut menu

- 1 In the Home >Favorites >Shortcut menu, select the desired group.
- 2 Display the menu you want to register, and then press the [Add Favorite] button.

The currently displayed menu is automatically registered to a blank button.

and hue, pressing a knob parameter button displays a color palette window.

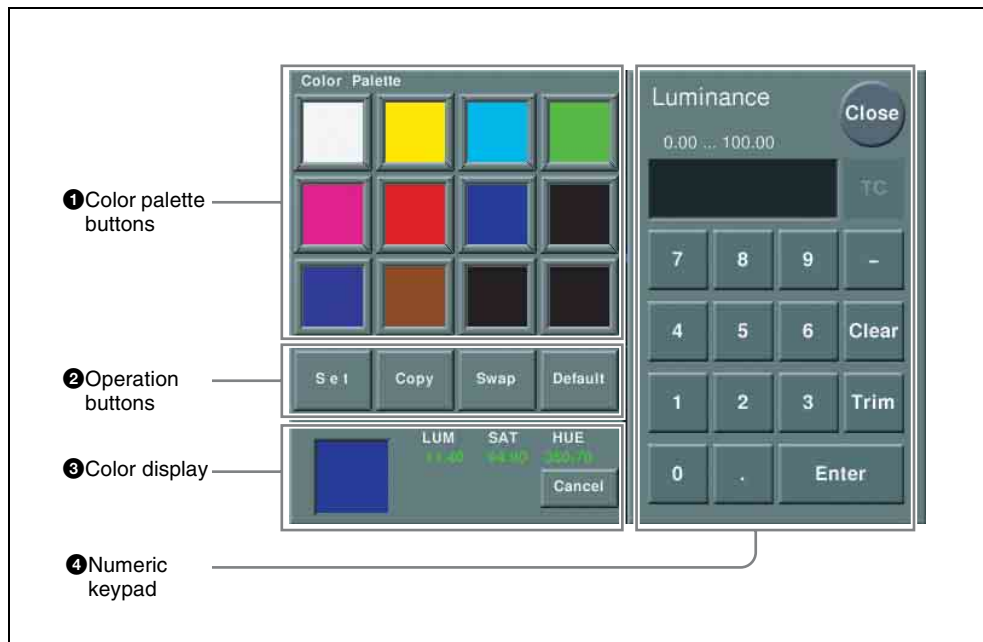

1 Color palette buttons

Press one of these to enter the corresponding color in the display. By default the following settings are available.

First row: white, yellow, cyan, green

Second row: magenta, red, blue, black

Third row: all black

2 Operation buttons

Set: If you press any color palette button with this button held down, the color shown in the color display is assigned to the color palette button.

Copy: If you press a color palette button with this button held down, the color is used as the source for copying. Next press a different color palette button to copy to that button.

Swap: If you press two color palette buttons in sequence with this button held down, the two colors are swapped.

Default: If you press any color palette button with this button held down, the color palette button is set to the default color.

3 Color display

This shows the setting color, and the parameters (LUM, SAT, and HUE). By adjusting the parameters with the knobs, you can create any color.

If a parameter value is outside the permitted range for RGB (0 to 255), the indication “Illegal Color” appears, and this is adjusted to a value in range.

Cancel: Pressing this button returns to the state when the color palette window was opened.

4 Numeric keypad

Use this to enter numeric values for parameters.

For details of use, see page 330.

Switching Between the Main Menu Site and Subsidiary Menu Site

For menu transitions, you can store two separate versions in the main and subsidiary menu sites.

By switching sites, and pressing the ◀ button and the ▶ button you can trace the history in each menu.

To switch the subsidiary menu site on and off

Assign [SUB MENU SITE] to a menu control block top menu selection button or user preference button. To switch to the subsidiary menu site, press this button, turning it on.

For details of the assignment operation, see “Assigning functions to the menu control block Top menu and user preference buttons” in Chapter 16 (Volume 2).

Shortcut Menu

Recalling a menu using the shortcut menu

- 1 In the Home menu, select VF2 ‘Favorites’ and HF1 ‘Shortcut.’

The following menu appears.



- 2 In the [Group Select] box, select the group.

The group buttons appear.

- 3 Press the button for the desired menu.

Creating a shortcut menu

Assign frequently used menus to buttons, to create a “Favorites” menu.

To create a menu group

- 1 In the Home menu, select VF2 ‘Favorites’ and HF1 ‘Shortcut.’

The following menu appears.



- 2 Press [Group Edit].

The following menu appears.



3 With the cursor, select the group name (in this case a blank button) for the operation.

4 Press [Rename].

A keyboard window appears.

5 Enter a group name (maximum 24 characters), and press Enter.

This confirms the group name.

To copy a menu group

1 In the Home >Favorites >Group Edit menu, press the button for the copy source group.

2 Press [Copy].

3 Press the button for the copy destination group.

4 Press [Paste].

This copies the menu group settings.

To delete menu group settings

1 In the Home >Favorites >Group Edit menu, select the group to be deleted.

2 Press [Clear].

A confirmation message appears.

3 Press [Yes].

This deletes the settings.

To register a menu on a button

You can register 15 buttons in one group.

1 In the Home >Favorites >Shortcut menu, press [Button Edit].



Menu No.



Button name

2 Move the cursor to the position where you want to display the button. To change the content of an already displayed button, press the button to select it.

3 Press [Page Set].

A page number input window appears.

4 Enter the page number for the menu you want to register.

5 Press [Rename].

A keyboard window appears.

6 Enter the button name (maximum 24 characters).

7 To change the button color, press [Color Set].

Button color samples appear.

8 Press the desired color.

This completes the assignment of the menu to the button.

9 Repeat steps **2** to **8** to complete the “Favorites” menu.

To copy button settings

1 In the Home >Favorites >Button Edit menu, press the copy source button to select it.

2 Press [Copy].

3 Press the copy destination button to select it.

4 Press [Paste].

This copies the button settings.

To delete button settings

In the Home >Favorites >Button Edit menu, press [Clear].

This deletes the button settings.

Note

The shortcut menu settings are handled as part of the control panel setup. You can recall and save them in the same way as setup data.





Chapter 3 Transitions

Basic Operating Procedure	340
Key Priority Setting	343
Setting the Key Priority in the Transition Control Block	343
Setting the Key Priority by a Menu Operation	345
Display of the Key Output Status and Key Priority	346
Selecting the Transition Type by a Menu Operation	348
Super Mix Settings	349
Color Matte Settings	350
Executing a Transition	351
Transition Indicator Function	351
Setting the Transition Rate	352
Pattern Limit	355
Executing an Auto Transition	359
Executing a Transition With the Fader Lever (Manual Transition) ..	359
Combinations of Auto and Manual Transitions	360
Non-Sync State	360
Fader Lever Operation in Bus Fixed Mode	361
Transition Preview	363
Independent Key Transitions	364
Basic Independent Key Transition Operations	364
Setting the Independent Key Transition Type by a Menu Operation	365
Setting the Independent Key Transition Rate	366
Fade to Black	369
Fade to Black Operation	369
Setting the Fade to Black Transition Rate	369
Simple Transition	371
Basic Operations for Simple Transitions	371
Display of the Key Output Status and Key Priority	373
Split Fader	373
Independent Key Transitions With a Simple Transition Module	374

Basic Operating Procedure

The positions of the principal buttons used for basic transition operation are as follows.

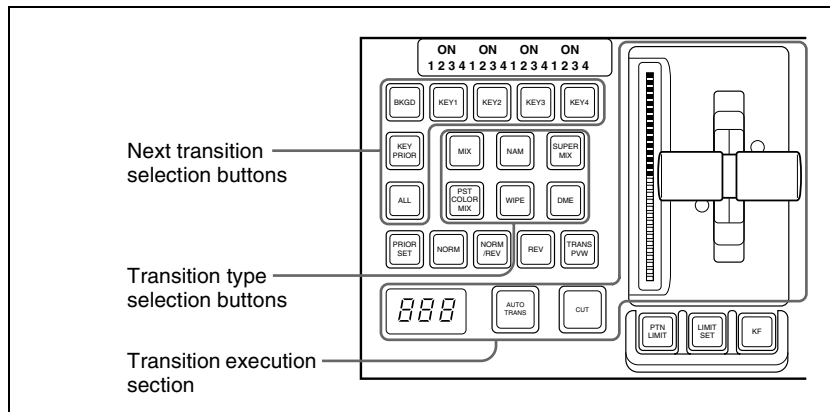

Transition control block (for standard transitions)

- 1 In the cross-point control block, select the background video with the background A row of cross-point buttons.
- 2 Select the way in which the transition will affect the image, using the next transition selection buttons in the transition control block.

For an overview, see “Selecting the Next Transition” (page 34).

To change the background: Press the [BKGD] button, turning it on.

To insert or delete a key: Press one of the [KEY1] to [KEY4] buttons (or [DSK1] to [DSK4] buttons in the PGM/PST bank), turning it on.

To enable the key priority setting, which determines the key overlay order after the transition: Press the [KEY PRIOR] button, turning it on.

You can press more than one button at the same time.

To change the keys and background presets in Setup menus simultaneously: Press the [ALL] button.

To allocate a particular next transition button to the [ALL] button function, see “Operation Settings (Operation Menu)” in Chapter 16 (Volume 2).

- 3** For the transition to change the key priority, set the priority for after the transition.

*For details of the key priority, see “Selecting the key priority” (page 36).
For details of the key priority setting operation, see “Key Priority Setting” (page 343).*

- 4** Select the new video used for the transition.

- In the background B row of cross-point buttons, select the new background video.
- When inserting a key, select the key signal, and make any required settings.

For details of key settings, see Chapter 4 “Keys” (page 377).

To carry out a cut transition, skip to step **7**; otherwise continue to step **5**.

- 5** Select one of the transition type selection buttons in the transition control block.

To carry out a dissolve to the new video: Press one of the [MIX], [NAM], [SUPER MIX], and [PST COLOR MIX] buttons, turning it on.

To carry out a wipe: Press the [WIPE] or [DME] button, turning it on.

To carry out a transition while playing back a frame memory clip: Press one of the buttons corresponding to the clip to be used (FM1&2CLIP, FM3&4CLIP, FM5&6CLIP, and FM7&8CLIP).

You can also use the Misc >Transition menu to select a desired transition type for the M/E or PGM/PST bank. (*See “Selecting the Transition Type by a Menu Operation” (page 348).*)

For an overview of the transition types, see “Transition Types” (page 41).

Note

The transition type selection buttons in the transition control block can be interchanged in the setup menu.

For details, see “Overall Control Panel Settings (Config Menu)” in Chapter 16 (Volume 2).

- 6** Make the required settings, according to the selected transition type.

For details of the settings, see the relevant section.

Super mix: *“Super Mix Settings” (page 349)*

Preset color mix: *“Color Matte Settings” (page 350)*

Wipe: *“Basic Procedure for Wipe Settings” (page 438)*

DME Wipe: “Basic Procedure for DME Wipe Settings” (page 466)

Clip transition: “Clip Transition Operations” (page 524)

Using the transition preview function (page 363), you can check the transition on the preview monitor.

7 Carry out the transition in the transition execution section.

For a gradual transition such as a mix (dissolve) or wipe: Press the [AUTO TRANS] button, or operate the fader lever.

To execute a transition by pressing the [AUTO TRANS] button, first set the transition rate (specified as the duration of the transition).

(See “Setting the Transition Rate” (page 352).)

When you have selected a wipe or DME wipe as the transition type, you can also set the transition range. (See “Pattern Limit” (page 355).)

For an instantaneous transition: Press the [CUT] button.

For details, see “Executing a Transition” (page 351).

Transition linked to the audio mixer

If the video signal selected in the background B row is linked to the audio mixer in setup, then the audio mixer sound changes with the transition. That is, pressing the [AUTO TRANS] button gives a cross fade, and pressing the [CUT] button gives an instantaneous sound switch.

For details of setup, see “Cross-Point Settings (Xpt Assign Menu)” in Chapter 16 (Volume 2).

Notes

- The audio mixer is not linked to a snapshot or key frame transition.
- The audio mixer is not linked to a transition using the fader lever.
- If the bus-fixed mode (see page 45) is selected in the setup menu, and the fader lever is in the lowest position, there is a cross fade from the audio selected on the B row to the audio selected on the A row.
- The audio mixer is not linked to a key transition.
- In the following cases, the audio and video may be out of sync.
 - When carrying out a cross fade in some DME wipes (for example, “picture in picture”)
 - When executing a preset color mix in two-stroke mode
- For details of audio mixers that can be used, Sony service or sales representative.



Key Priority Setting

You can select the key priority, that is, the order in which the keys are laid over each other, in the current video and after the transition. There are two ways of setting the priority: either using the [PRIOR SET] button in the transition control block, or using the Misc menu to access the Key Priority menu for the M/E or PGM/PST bank.

Note

When the operating mode is set to multi program, the key priority setting cannot be made.

Setting the Key Priority in the Transition Control Block

The positions of the buttons used for the operation are as follows.

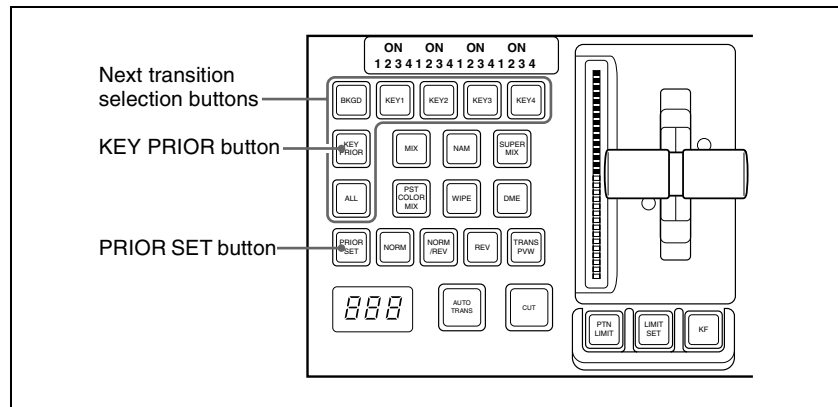

Transition control block (standard type)

Changing the currently inserted key priority

- 1 If the next transition selection button [KEY PRIOR] is on, press another next transition selection button to turn the [KEY PRIOR] button off.
(When the [KEY PRIOR] button is on, the transition control block switches to the mode for changing the key priority for after the transition.)

- 2 Holding down the [PRIOR SET] button, press the one of the next transition selection buttons [KEY1] to [KEY4] ([DSK1] to [DSK4] buttons in the PGM/PST bank) for the key to appear on top.

The selected key now appears on top, on the program monitor.
The priority of keys other than the selected one does not change.

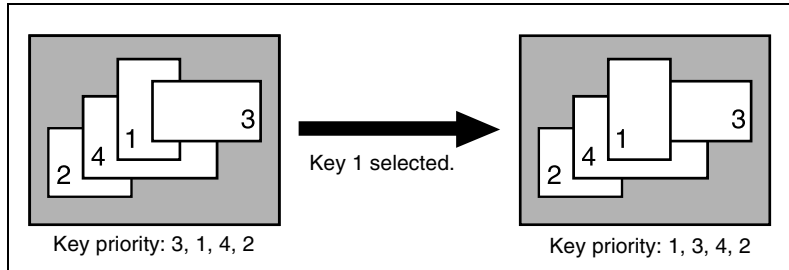

To change the priority of more than one key, repeat this operation as required.

Changing the key priority for after the transition

When executing a transition, turning on the next transition selection button [KEY PRIOR] causes the keys to be rearranged based on the set priority. To set the key priority for after the transition, use the following procedure.

- 1 In the transition control block, hold down the [PRIOR SET] button and press the [KEY PRIOR] button to turn it on. Do not release the [PRIOR SET] button before advancing to step 2.

The [KEY PRIOR] button lights green, and it becomes possible to change the key priority setting for after the transition.

- 2 Hold down the [PRIOR SET] button, and press the one of the next transition selection buttons [KEY1] to [KEY4] ([DSK1] to [DSK4] buttons in the PGM/PST bank) for the key you want to bring to the front after the transition.

To set the priority to be the same as before the transition, press the [BKGD] button.

Note

The [BKGD] button is only effective when in the mode for changing the key priority for after the transition.

When the next transition selection button [KEY PRIOR] is on, the selected key appears on top on the preview monitor. The priority of keys other than the selected one does not change.

3 To change the priority of more than one key, repeat the previous operation as required.

4 Execute the transition.

The keys are rearranged based on the set priority.

Setting the Key Priority by a Menu Operation

Changing the priority of the currently inserted keys

1 In the M/E or PGM/PST menu, select first VF7 'Misc,' then HF3 'Key Priority.'

The Key Priority menu appears.

2 For each of <Priority1>, <Priority2>, <Priority3>, and <Priority4>, select a key, to determine the key priority sequence.

The keys are inserted in the key priority sequence with priority 1 at the front.

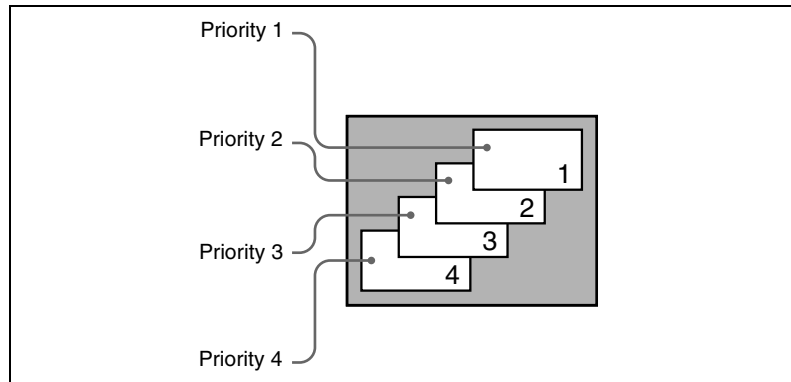

Note

It is not possible to select the same key for two or more priority numbers.

The keys appear in the set order on the program monitor.

Changing the key priority for after the transition

- 1** In the M/E or PGM/PST menu, select first VF7 ‘Misc,’ then HF4 ‘Next Key Priority.’
The Next Key Priority menu appears.
- 2** For each of <Priority1>, <Priority2>, <Priority3>, and <Priority4>, select a key, to determine the key priority sequence.
For details of the key priority sequence, see the figure shown for step 2 in the previous item (see page 345).
The keys appear in the set order on the preview monitor.
- 3** Execute the transition.
The keys are rearranged in the set order on the program monitor.

Display of the Key Output Status and Key Priority

You can check whether keys are currently output, and the key priority setting, using the key status display in the transition control block of the M/E or PGM/PST bank.

The display is above the next transition selection buttons [KEY1] to [KEY4] ([DSK1] to [DSK4] buttons in the PGM/PST bank).

Display of the key output status

When a key is included in the output from the M/E or PGM/PST bank, the corresponding ON indicator lights.

Key priority display

The key priority is indicated by numerals 1 to 4 lighting.

The topmost key as seen on the program monitor is priority 1, and the keys underneath are numbered 2, 3, 4 away from the viewer (*see page 345*).

To display the key priority for after the transition, press the [KEY PRIOR] button in the transition control block, turning it on. For keys for which the priority after the transition is different from the current priority, the corresponding numerals 1 to 4 flash. For a key with the same priority, the indication remains on.

Example key status display given when the [KEY PRIOR] button is pressed:
Current key priority: 1, 2, 3, 4



Key priority after the transition: 3, 2, 1, 4

Indicators: 1, 3 (flashing), 2, 1 (flashing), 3, 4

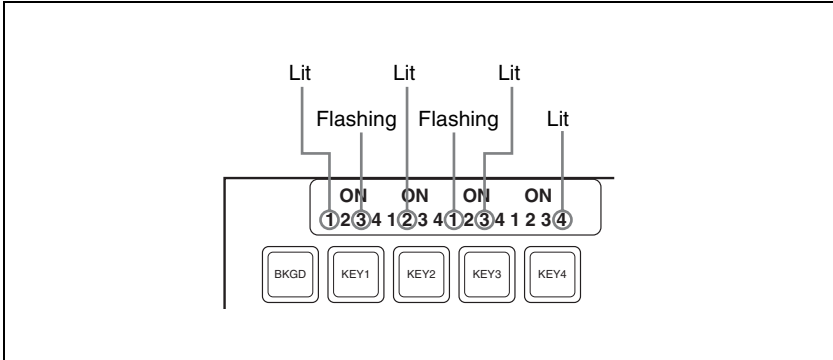

Example key status display (showing the key priority after the transition)



Selecting the Transition Type by a Menu Operation

You can also select the required transition type by a menu operation.

- 1** In the M/E or PGM/PST menu, select first VF7 'Misc,' then HF1 'Transition.'

The Transition menu appears.

- 2** Select the required transition type in the <Transition Type> group.

The parameter settings can now be adjusted with the knobs according to the selected transition type.

For details, see the following.

- “*Super Mix Settings*” (page 349)
- “*Color Matte Settings*” (page 350)
- “*Setting the Transition Rate*” (page 352)

Note

When multi-program mode is selected in the Setup menu (see “*Settings for Switcher Configuration (Config Menu)*” in Chapter 16 (Volume 2)), there may be cases in which two or more transition types have been selected.

Super Mix Settings

For an overview of the super mix, see page 42.

- 1** In the M/E or PGM/PST menu, select first VF7 'Misc,' then HF1 'Transition.'

The Transition menu appears.

- 2** Select [Super Mix] in the <Transition Type> group.

- 3** Turn the knobs to adjust the output levels.

Knob	Parameter	Adjustment	Setting values
2	A Gain	Background A output level	0.00 to 100.00%
3	B Gain	Background B output level	0.00 to 100.00%

Color Matte Settings

To set the color matte of a preset color mix, use the following procedure.

For an overview of the preset color mix, see page 42.

- 1** In the M/E or PGM/PST menu, select first VF7 ‘Misc,’ then HF1 ‘Transition.’

The Transition menu appears.

- 2** Select [Preset Color Mix] in the <Transition Type> group.

- 3** In the <Preset Color Mix Fill> group, select one of the following.

Flat Color: monochrome color matte

Utility 2 Bus: signal selected on the utility 2 bus

Note

The utility 2 bus cannot be selected on the MVS-8000.

- 4** When “Flat Color” is selected, turn the knobs to adjust the color matte.

Knob	Parameter	Adjustment	Setting values
2	Luminance	Luminance	0.00 to 100.00
3	Saturation	Saturation	0.00 to 100.00
4	Hue	Hue	359.99 to 0.00



Executing a Transition

There are two ways of executing a transition: as an auto transition by a button operation, and as a manual transition using the fader lever. You can also use a combination of these two modes.

For an overview of the auto transitions and manual transitions, see “Executing a Transition” (page 44).

Transition Indicator Function

In each of the M/E banks and PGM/PST bank, to the left of the fader lever is a transition indicator composed of multiple LEDs. This indicator shows the state of the transition, whether auto or manual, by which LEDs are lit.

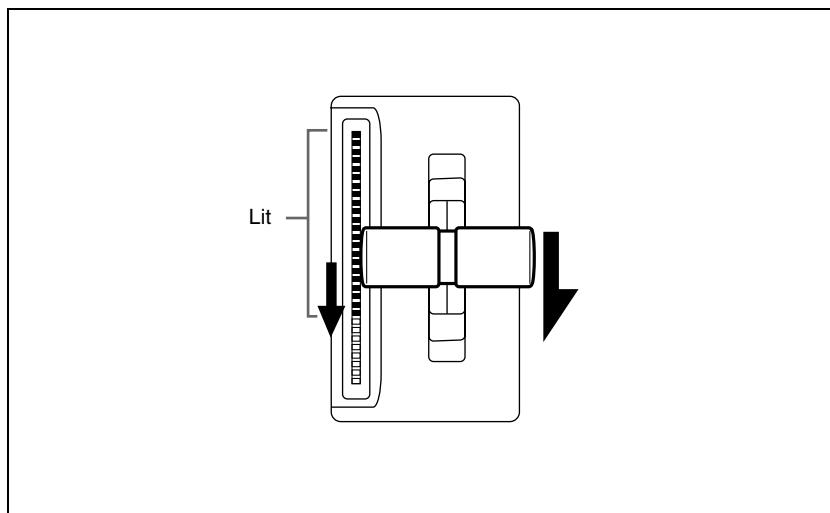

Transition indicator

For example, in the previous illustration, it can be seen that the transition is more than half completed.

When the transition is completed, all of the LEDs go off.

Setting the Transition Rate

There are two ways of setting the transition rate: using the Flexi Pad control block or numeric keypad control block to enter a numeric value, or using the Misc menu to access the Transition menu for the M/E or PGM/PST bank. You can also display the transition rate, independent key transition rate, and fade-to-black transition rate for each of the M/E and PGM/PST banks, and change the settings. (See “*Displaying a List of Transition Rates and Changing the Settings*” (page 553).)

Note

When a clip transition is selected as the transition type, it is not possible to set the transition rate.

Frame input mode and timecode input mode

For numeric input of the transition rate value, there are two modes: frame input mode and timecode input mode. You select one of these modes using either the Flexi Pad control block (page 353) or the numeric keypad control block (page 354).

Frame input mode: The entered value is a number of frames.

Example: Entering 123 constitutes an entry of 123 frames

Timecode input mode: The entered value is a timecode value.

Example: Entering 123 constitutes an entry of 1 second 23 frames.

Note

Whereas you can enter a value of up to 999 in frame input mode, a value not smaller than 10 seconds cannot be entered in timecode input mode.

Frame display mode and timecode display mode

For the transition rate display in the transition control block, there are two modes: frame display mode and timecode display mode. You can select one of these modes in setup. (See “*Operation Settings*” in Chapter 16 (Volume 2).)

Note

The setting is common to all banks of the switcher.

Frame display mode: Values are shown as from 0 to 999 frames. In this display mode, a value entered in timecode input mode is converted for display as a number of frames.

Timecode display mode: Values are shown as timecode values, consisting of seconds and frames. In this display mode, a value entered in frame input



mode is converted for display as a timecode value. If the value consists of four or more digits, the last digit is not shown.

Example: A value of 9 seconds 23 frames appears as “9.23” and a value of 10 seconds 1 frame appears as “10.0.”

Setting the transition rate in the Flexi Pad control block

Note

In the PGM/PST bank or when using a simple-type transition control block, you cannot use the Flexi Pad control block to set the transition rate.

- 1 In the M/E bank Flexi Pad control block, press the [TRANS RATE] button.

The memory recall section display is now ready to accept the entered transition rate.

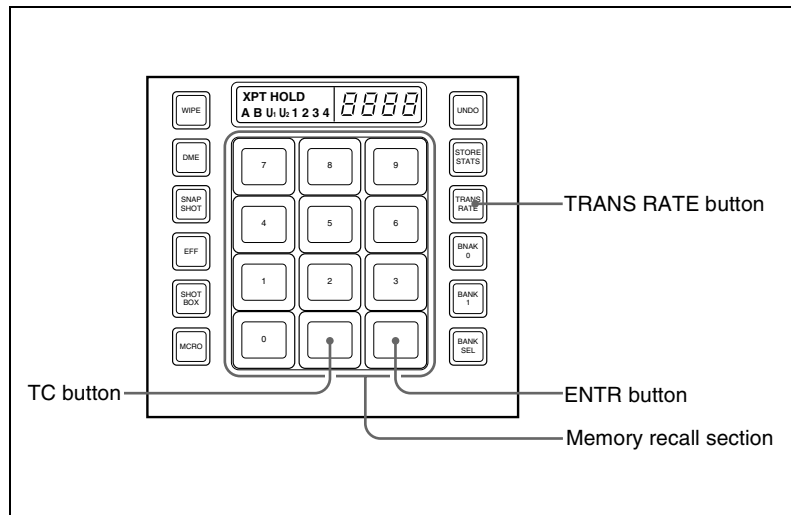

Flexi Pad control block (standard type)

- 2 Enter the desired transition rate with the numeric keypad. If required, press the [TC] button to toggle the input mode (frame input or timecode input).

- Enter a value of up to three digits.
- To cancel the entry, press any of the six buttons in the leftmost column ([WIPE], [DME], ...) or the [TRANS RATE] button.

- 3 Press the [ENTR] button.

This confirms the entry, and the new setting appears in the transition control block display.

Setting the transition rate in the numeric keypad control block

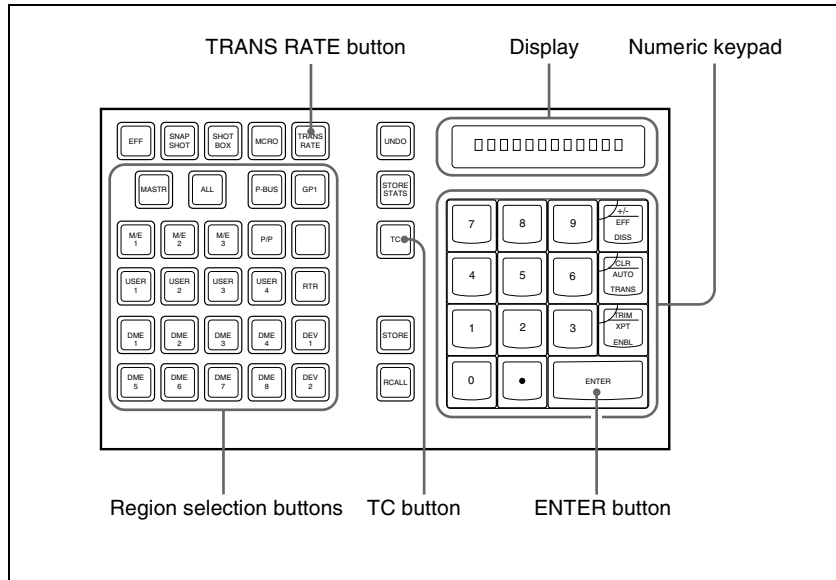

Numeric keypad control block

- 1 In the numeric keypad control block, press the [TRANS RATE] button.
- 2 Press the region selection button for the M/E or PGM/PST bank for which you want to set the transition rate, turning it on.

The numeric keypad control block display now shows the selected region name and the current transition rate setting for the region.

- 3 With the numeric keypad, enter the transition rate.
If required, press the [TC] button to toggle the input mode (frame input or timecode input).

- Enter a value of up to three digits.
- To clear the entry, press the [CLR] button.

- 4 Press the [ENTER] button.



This confirms the entry, and the selected region name and the set transition rate appear in the numeric keypad control block display. The transition control block display of the same bank (M/E or PGM/PST) also shows the setting.

To enter a difference from the current value

After pressing the [+/-] button, enter the difference and press the [TRIM] button.

To change the sign (+ or -), press the [+/-] button.

Setting the transition rate by a menu operation

- 1 In the M/E or PGM/PST menu, select first VF7 ‘Misc,’ then HF1 ‘Transition.’

The Transition menu appears.

- 2 Select any transition type in the <Transition Type> group.

- 3 Turn the knob to set the transition rate.

Knob	Parameter	Adjustment	Setting values
1	Transition Rate	Transition Rate	0 to 999 (frame count)

Displaying the transition rates in a menu and changing the settings

For each of the M/E and PGM/PST banks, you can display the transition rate, independent key transition rate and fade-to-black transition rate, and change the settings.

For more details, see “Displaying a List of Transition Rates and Changing the Settings” (page 553).

Pattern Limit

There are two ways of setting a pattern limit: either by operating the fader lever to save the fader position, or by using the Wipe menu or DME Wipe menu to access the Edge/Direction menu for the M/E or PGM/PST bank.

For an overview of the pattern limits, see page 46.

Notes

- A pattern limit only applies when a wipe or DME wipe is selected as the transition type.
- A pattern limit cannot be applied to an independent key transition (*see page 364*).

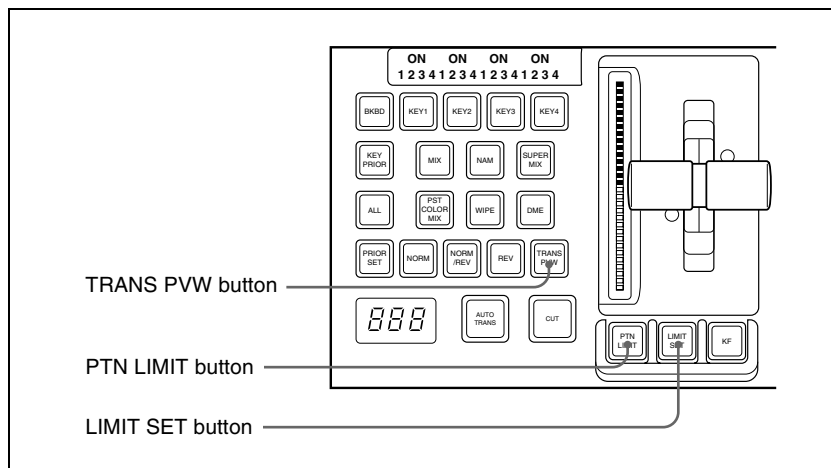

Transition control block (standard type)

Setting the pattern limit with the fader lever

- 1 Move the fader lever to the position corresponding to a particular pattern size.
 - First make sure that the [PTN LIMIT] button is off.
 - To check the pattern size on the preview monitor, first press the [TRANS PVW] button, to select the transition preview mode (*see page 363*).

- 2 Press the [LIMIT SET] button.

This sets the current fader lever position as the pattern limit.

Setting the pattern limit by a menu operation

- 1 When a wipe is selected as the transition type, in the M/E or PGM/PST menu, select first VF5 'Wipe,' then HF4 'Edge/Direction.'

When a DME wipe is selected as the transition type, in the M/E or PGM/PST menu, select first VF6 'DME Wipe,' then HF4 'Edge/Direction.'

The Edge/Direction menu appears.

2 Press the [Pattern Limit] button, turning it on.

3 Turn the knobs to adjust the following parameters.

Knob	Parameter	Adjustment	Setting values
1	Pattern Limit	Pattern limit	0.00 ^{a)} to 100.00% ^{b)}

a) 0.00%: Executing the transition does not change the video output at all.

b) 100.00%: The transition is the same as when no pattern limit is set, but the cross-point button selections of the background A and B buses do not interchange when the transition completes.

Executing a pattern limit transition

1 Press the [PTN LIMIT] button, turning it on.

The button you pressed lights amber.

2 Carry out the transition.

The transition progresses as far as the set pattern limit. Even if the transition completes, the cross-point button assignments of the background A and B buses do not interchange.

3 Carry out the transition once again.

The status before the previous transition is restored.

To cancel the pattern limit

To cancel the pattern limit after completion of step **3** in the previous procedure, press the [PTN LIMIT] button, turning it off.

If after carrying out step **2** in the previous procedure, the pattern limit has been reached, carry out the following procedure.

1 Press the [PTN LIMIT] button.

The button you pressed lights green.

2 Carry out the transition.

The [PTN LIMIT] button goes off, and the pattern limit state is released. Depending on the way in which the transition was executed, the action will be as follows.

- When you press the [CUT] button, the pattern limit is immediately released, and the image switches instantaneously.
- When you press the [AUTO TRANS] button, until the state of the next transition, the transition is carried out over the duration given by the transition rate.

- When you move the fader lever, the transition is carried out from the pattern limit state to the state before the pattern limit transition was carried out.
Moving the fader lever even a little synchronizes the fader lever position with the transition state, and you can move the fader lever either in the forward direction or in the reverse direction.

Depending on the Setup settings, the transition may be executed at the instant you press the [PTN LIMIT] button, and the button goes off. In this case, execution continues for the time specified by the dedicated transition rate in the menu setting, as far as the state of the next transition.

For details of the setting, see “Settings Relating to Keys, Wipes and Frame Memory (Key/Wipe/FM Menu)” in Chapter 16 (Volume 2).

To set the transition rate when the pattern limit is released

- 1** In the <Pattern Limit Release> group of the Edge/Direction menu, select one of the following.

Auto Trans Rate: Use the transition rate set in the transition rate control block

Independ Trans Rate: Independent transition rate

- 2** If you selected “Independ Trans Rate” in step **1**, adjust the following parameter.

Knob	Parameter	Adjustment	Setting values
1	Transition Rate	Independent transition rate	0 to 999 (frames)



Executing an Auto Transition

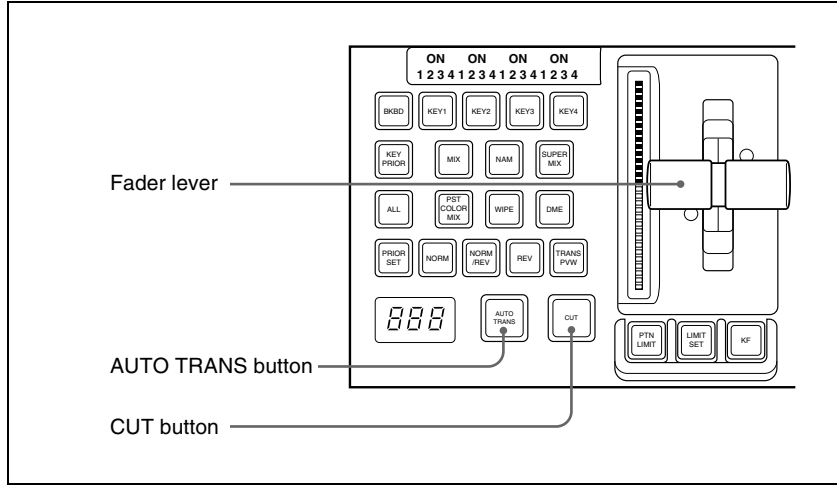

Transition control block (standard type)

To execute a transition on the M/E or PGM/PST bank by a button operation, use the following procedure in the transition control block.

For an overview of the auto transition, see page 45.

To carry out an instantaneous cut transition: Press the [CUT] button.

To carry out a gradual transition: Press the [AUTO TRANS] button.

This executes the transition at the preset transition rate (*see page 352*).

While the transition is executing, the [AUTO TRANS] button lights amber. When it completes the button goes off.

To complete a partially executed transition instantaneously: Press the [CUT] button.

The [AUTO TRANS] button goes off.

Executing a Transition With the Fader Lever (Manual Transition)

To execute a manual transition with the transition control block fader lever, use the following procedure.

For an overview of the manual transition, see page 45.

To carry out the transition completely: Move the lever over the full range of its travel.

To pause a partly executed transition: Stop moving the fader lever.

To resume a paused transition: Resume moving the fader lever.

Combinations of Auto and Manual Transitions

Using the [AUTO TRANS] button, the [CUT] button, and the fader lever, use the following procedures.

Moving the fader lever during an auto transition

During an auto transition started by pressing the [AUTO TRANS] button, operating the fader lever immediately enables the fader lever, and the [AUTO TRANS] button goes off. Thereafter, the fader lever controls the progress of the transition.

Executing an auto transition after partly moving the fader lever

- Press the [CUT] button to instantaneously complete the transition.
- Press the [AUTO TRANS] button to complete the rest of the transition at the preset transition rate.

If the transition rate is set to 100 frames, and the fader lever has moved through $\frac{1}{4}$ of the transition, then the remaining $\frac{3}{4}$ of the transition is carried out in 100 frames.

Non-Sync State

If the fader lever is in an intermediate position when a transition is completed as an auto transition, then the lever position no longer agrees with the transition state. This is termed a non-sync state.

In a non-sync state, two lit LEDs indicate the position from which a normal transition can be carried out. This is either at one end position or both end positions of the fader lever travel.

Moving the fader lever toward the position of the lit LEDs does not carry out a transition, but when the fader lever reaches the end position the non-sync state is released, and it is now possible to carry out the next transition.



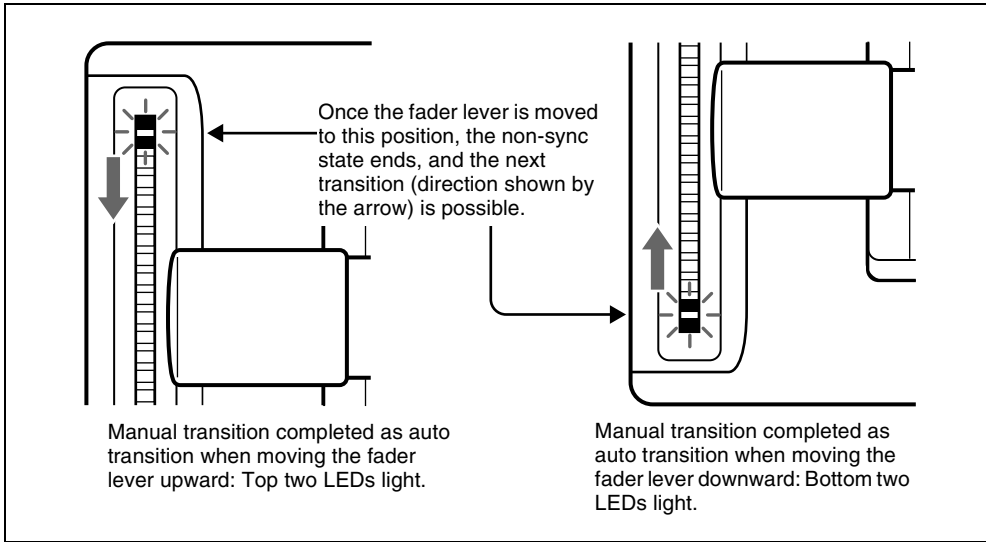

- If the fader lever is moved in the direction away from the lit LEDs, this carries out the next transition, over the remaining part of the fader lever travel.
- Even in a non-sync state, you can carry out an auto transition by pressing the [AUTO TRANS] button. During the auto transition, the indicators show the transition progress in the usual way, but when the transition completes, they once again indicate the non-sync state.

Fader Lever Operation in Bus Fixed Mode

In the bus fixed mode there is a fixed relationship between the position of the fader lever and the signal output on each bus. Depending on the direction of the transition, the fader lever must therefore always be moved in a particular direction, as shown in the following table. This does not affect an auto transition, which is executed regardless of the fader lever direction.

For an overview of the bus fixed mode, see “Flip-flop mode and bus fixed mode” (page 45).

Fader lever operating direction in bus fixed mode

Next transition	Transition direction	Fader lever movement
Background	A → B	Downward
	B → A	Upward

Next transition	Transition direction	Fader lever movement
Keys 1, 2, 3, and 4	On → Off (deletion)	Downward
	Off → On (insertion)	Upward

- When a transition applies to a combination of more than one of the background and keys 1, 2, 3, and 4, then the transition for all of these must be in the same direction complying with the above table.
- If as a result of an auto transition, for example, the fader lever position does not agree with the signal output, this is a non-sync state (*see page 360*) and LEDs light at both end positions of the fader lever travel. Moving the fader lever does not carry out a transition, but when the fader lever reaches the end position the non-sync state is released, and it is now possible to carry out the next transition. If the fader lever is moved in the direction away from the lit LEDs, this carries out the next transition, over the remaining part of the fader lever travel.



Transition Preview

Carrying out a transition preview

For an overview of the transition preview, see page 46.

- 1 In the M/E or PGM/PST bank transition control block, press the [TRANS PVW] button.

The [TRANS PVW] button lights green, and the switcher is now in the transition preview mode. At this point, the preview output is the same as the program output before the [TRANS PVW] button was pressed.

- 2 Operate the fader lever, or press the [AUTO TRANS] button or [CUT] button.

On the preview monitor, you can check the effect of the transition.

To terminate a transition preview

There are three modes for a transition preview. To terminate a transition preview, carry out the operation which depends on the mode, and press the [TRANS PVW] button, turning it off.

Lock: Toggling the [TRANS PVW] button on and off switches between the transition preview mode and the normal mode.

Hold: The preview mode obtains only while the [TRANS PVW] button is held down.

One Time: Each time a transition ends, it reverts to the normal mode.

Set the transition preview mode in the following combinations. *For details, see Chapter 16 “Engineering Setup” (Volume 2).*

Transition Preview mode	Switcher setup (Transition menu) <Transition Preview> group	Panel setup (Operation >Custom Button menu) <Trans Pvw> group
Lock	Normal	Lock
Hold	Normal	Hold
One Time	One Time	–

Notes

- During a transition, whether executed with the [AUTO TRANS] button or the fader lever, it is not possible to press the [TRANS PVW] button.
- In bus fixed mode (*see page 45*), transition previews are not available.
- When using the simple-type transition control block (*see page 371*), transition previews are not available.

Independent Key Transitions

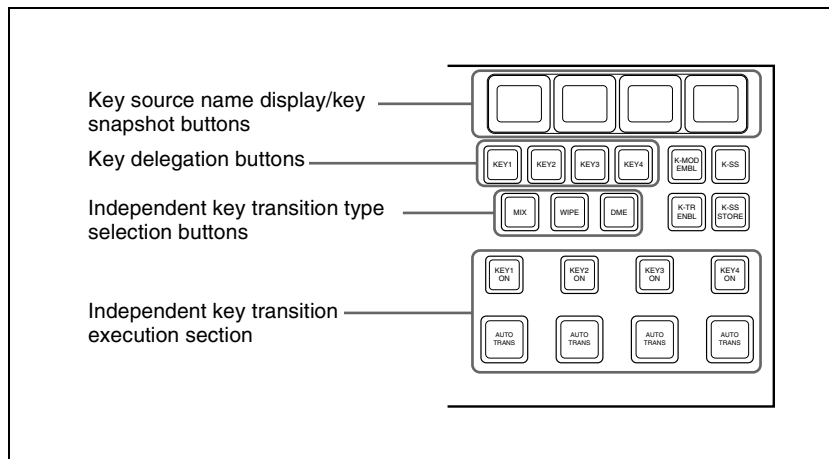

Independent key transition control block (standard type)

To set independent transitions for the keyers on the M/E or PGM/PST bank, use the independent key transition control block.

For an overview of the independent key transitions, see page 37.

Basic Independent Key Transition Operations

- 1 Select one or more of the delegation buttons [KEY1] to [KEY4] ([DSK1] to [DSK4] in the PGM/PST bank), turning them on.

You can press more than one button at the same time.

- 2 Select the transition type.

To fade a key in or out: Press the [MIX] button, turning it on.

To insert or delete a key using a dedicated wipe pattern: Press the [WIPE] button, turning it on.

To insert or delete a key using a dedicated DME wipe pattern: Press the [DME] button, turning it on.

If, in the Setup menus, you set insertion and deletion as independent modes, make the settings for the next transition in the independent key



transition control block.

Separate settings are required both when inserting a key and when deleting it. For example, with the key not inserted, if you select the transition type and carry out a transition, this will be the setting when inserting a key.

You can also use the Transition menu to select a desired independent key transition type for each key (*see the next section*).

For details of the wipe settings, see “Wipe Settings for Independent Key Transitions” (page 455). For details of DME wipe settings, see “DME Wipe Settings for Independent Key Transitions” (page 477).

3 Execute the transition.

To insert or delete the key gradually with a mix or wipe transition:

Press the [AUTO TRANS] button.

For details of the transition rate, see “Setting the Independent Key Transition Rate” (page 366).

For details of operation together with a common transition, see “Combining other transitions with independent key transitions” (page 38).

To cut the key in or out instantaneously: Press the [KEY ON] button on the keyer.

Note

In an independent key transition, the pattern limit function is not available.

Setting the Independent Key Transition Type by a Menu Operation

You can also select the required independent key transition type by a menu operation.

- 1 In the M/E or PGM/PST menu, select first the desired one from VF1 ‘Key1’ to VF4 ‘Key4,’ then HF6 ‘Transition.’

The Transition menu for the selected appears.

- 2 Select the required transition type in the <Transition Type> group.

If, in the Setup menus, you set insertion/deletion as independent modes, make the settings for insertion in the <On Transition Type> group, and the settings for deletion in the <Off Transition Type> group.

Setting the Independent Key Transition Rate

There are two ways of setting the transition rate: using the Flexi Pad control block or numeric keypad control block to enter a numeric value, or using the Key menu to access the Transition menu for the M/E or PGM/PST bank.

You can also display the transition rate, independent key transition rate, and fade-to-black transition rate for each of the M/E and PGM/PST banks, and change the settings. (See “*Displaying a List of Transition Rates and Changing the Settings*” (page 553).)

When the setup selection is for separate transition rates for inserting or deleting a key, you can set both rates independently. For example, with the system in the state with the key not inserted, the transition rate setting applies to key insertion.

Setting the independent key transition rate in the Flexi Pad control block

Note

In the PGM/PST bank or when using a simple-type transition control block, you cannot use the Flexi Pad control block to set the transition rate.

- 1** In the Flexi Pad control block of the M/E bank, hold down the [TRANS RATE] button, and in the independent key transition control block, press the delegation button [KEY1] to [KEY4] for the key for which you want to set the transition rate.

The memory recall section display is now ready to accept the entered independent key transition rate.

- 2** Enter the desired transition rate with the numeric keypad.
 - Enter a value of up to three digits.
 - To cancel the entry, press any of the six buttons in the leftmost column ([WIPE], [DME], ...) or the [TRANS RATE] button.

For details of frame input mode and timecode input mode, see page 352.

- 3** Press the [ENTR] button.



Setting the independent key transition rate in the numeric keypad control block

Note

You cannot use the numeric keypad control block to set the transition rate for a simple transition.

- 1 In the numeric keypad control block, hold down the [TRANS RATE] button, and in the independent key transition control block, press the delegation button [KEY 1] to [KEY 4] ([DSK 1] to [DSK 4] in the PGM/PST bank) for the key for which you want to set the transition rate.

The numeric keypad control block changes to the mode for inputting the independent key transition rate, and its display now shows the corresponding region name and the current transition rate set for the region.

- 2 With the numeric keypad, enter the transition rate.

- Enter a value of up to three digits.
- To clear the entry value, press the [CLR] button.

For details of frame input mode and timecode input mode, see page 352.

- 3 Press the [ENTER] button.

This confirms the entry, and the selected region name and the set transition rate appear in the numeric keypad control block display.

To enter a difference from the current value

After pressing the [+/-] button, enter the difference and press the [TRIM] button.

To change the sign (+ or -), press the [+/-] button.

Setting the independent key transition rate by a menu operation

- 1 In the M/E or PGM/PST menu, select first the desired one from VF1 'Key1' to VF4 'Key4,' then HF6 'Transition.'

The Transition menu for the selected key appears.

- 2 Select any transition type in the <Transition Type> group.

If, in the Setup menus, you set insertion/deletion as independent modes, make the settings for insertion in the <On Transition Type> group, and the settings for deletion in the <Off Transition Type> group.

3 Turn the knob to set the transition rate.

Knob	Parameter	Adjustment	Setting values
1	Transition Rate	Transition rate	0 to 999 (frame count)

Independent key transition rate display

To check the set independent key transition rate, press the key source name display/key snapshot button above the corresponding delegation button when the [K-SS] button is off.

Displaying the independent key transition rates in a menu and changing the settings

For each of the M/E and PGM/PST banks, you can also display the transition rate, independent key transition rate and fade-to-black transition rate, and change the settings.

For more details, see “Displaying a List of Transition Rates and Changing the Settings” (page 553).



Fade to Black

Fade to Black Operation

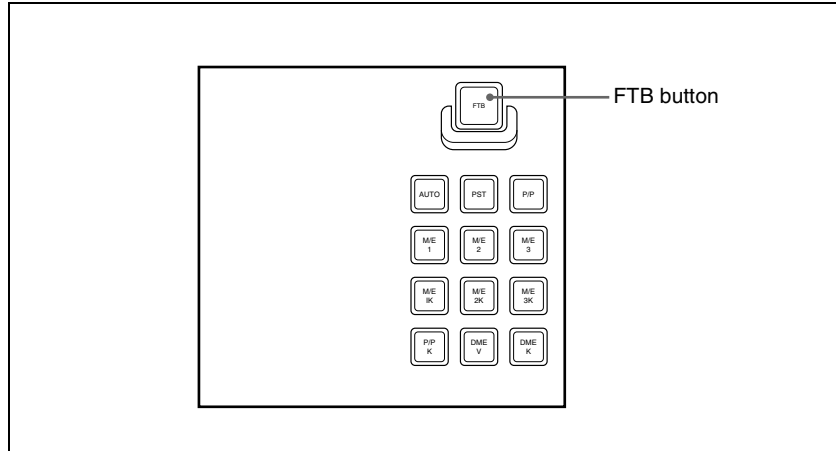

Fade to black control block

Carrying out a fade to black

To carry out a fade to black, press the [FTB] button in the fade to black control block.

The fade to black is carried out with the transition rate set for the program output of the PGM/PST bank.

During the transition, the [FTB] button lights amber. When the transition completes (the video is completely black), the button lit color changes to red.

For an overview of the fade to black, see page 47.

Setting the Fade to Black Transition Rate

Setting the fade to black transition rate

- 1 In the PGM/PST menu, select first VF7 'Misc,' then HF1 'Transition.'

The Transition menu appears.

- 2 Select [FTB].
- 3 Turn the knob to set the fade to black transition rate.

Knob	Parameter	Adjustment	Setting values
1	Transition Rate	Transition rate	0 to 999 (frame count)

Displaying the transition rates in a menu and changing the settings

You can also display the transition rate, independent key transition rate, and fade-to-black transition rate for each of the M/E and PGM/PST banks, and change the settings.

For more details, see “Displaying a List of Transition Rates and Changing the Settings” (page 553).



Simple Transition

The “simple transitions” refer to the transitions carried out using the simple-type transition control block (or simple-type independent key transition control block).

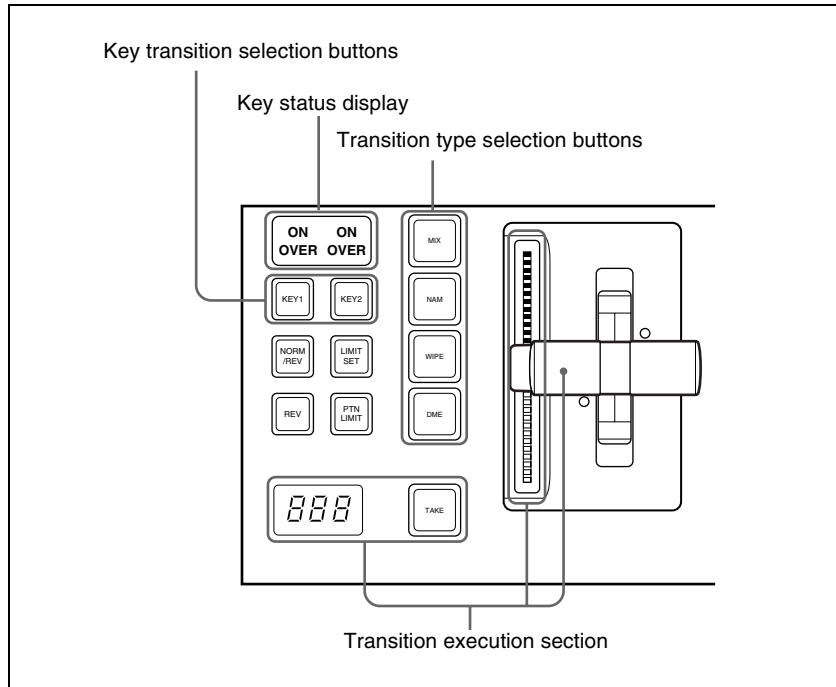

Transition control block (simple right-hand type)

Basic Operations for Simple Transitions

Carrying out a transition using a simple-type transition control block

- 1 With the background A row of cross-point buttons in the cross-point control block, select the background video.

2 Using one of the following methods, select the way in which the transition will affect the image.

Use a combination of the transition type selection buttons ([MIX], [NAM], [WIPE] and [DME]) and the next transition selection buttons ([KEY1] and [KEY2]).

For an overview of the mix, NAM, wipe, and DME wipe transition types, see “Transition Types” (page 41).

To change the background only: Press one of the [MIX], [NAM], [WIPE], and [DME] buttons.

The [KEY1] and [KEY2] buttons go off, and the system changes to the background transition mode.

To insert or delete key 1: Hold down the [KEY1] button and press one of the [MIX], [NAM], [WIPE], and [DME] buttons.

To insert or delete key 2: Hold down the [KEY2] button and press one of the [MIX], [NAM], [WIPE], and [DME] buttons.

To insert or delete key 1 and key 2 simultaneously: Hold down the [KEY1] and [KEY2] buttons, and press one of the [MIX], [NAM], [WIPE], and [DME] buttons.

To use a super mix or preset color mix: Select [Super Mix] or [Preset Color Mix] in the Misc > Transition menu for the M/E or PGM/PST bank.

To set the key priority, use the Misc > Key Priority menu for the M/E or PGM/PST bank. For details, see “Setting the Key Priority by a Menu Operation” (page 345).

Note

The transition type selection buttons ([MIX], [NAM], [WIPE], and [DME]) can be assigned to other transition types in setup.

For details, see “Overall Control Panel Settings (Config Menu)” in Chapter 16 (Volume 2).

3 Select the new background for after the transition.

- Select the background video with the background B row of cross-point buttons.
- To insert a key, select the key signal, and make various settings as required.

For details of key settings, see Chapter 4 “Keys” (page 377).

4 Depending on the transition type selected in step 2, make the required settings.

For details of the settings, see the following sections:

- Super mix:** “*Super Mix Settings*” (page 349)
- Preset color mix:** “*Color Matte Settings*” (page 350)
- Wipe:** “*Basic Procedure for Wipe Settings*” (page 438)
- DME Wipe:** “*Basic Procedure for DME Wipe Settings*” (page 466)
- Clip transition:** “*Clip Transition Operations*” (page 524)

5 Carry out the transition in the transition execution section.

For a gradual transition such as a mix or wipe: Press the [TAKE] button, or operate the fader lever.

See “Setting the Transition Rate” (page 352) and “Pattern Limit” (page 355) as required.

Display of the Key Output Status and Key Priority

You can check the output status of keys 1 and 2 and the key priority setting, in the key status display in the transition control block. The key status display includes two ON indicators corresponding to keys 1 and 2.

Display of the key output status

When the key is inserted in the output from the M/E or PGM/PST bank, the indication “ON” lights, and when it is not inserted, the indication goes off.

Key priority display

The key lying in front on the program monitor has an indication “OVER” lit.

To set the key priority, use the Misc >Key Priority menu for the M/E or PGM/PST bank. For details, see “Setting the Key Priority by a Menu Operation” (page 345).

Split Fader

What does “split fader” mean?

The term “split fader” refers to the function of carrying out a transition with the fader lever split into left and right halves, so that the background A and background B buses can be manipulated separately.

To use the split fader, the following conditions must be met.

- The fader lever is in bus fixed mode. (*See “Settings Relating to Video Switching (Transition Menu)” in Chapter 16 (Volume 2).*)

- The necessary settings have been made in a Setup menu to enable the split fader (See “Settings Relating to Video Switching (Transition Menu)” in Chapter 16 (Volume 2).)
- A background is selected for the next transition.
- For the transition type, [MIX] or [NAM] is selected.

Split fader operation

The two halves of the split fader lever correspond to the buses as follows.

Right fader lever: Background A bus

Left fader lever: Background B bus

The relationship between the positions of the two fader levers and the image output in a mix is as follows.

Left lever position	Right lever position	A bus output	B bus output
Top	Top	100%	0%
Bottom	Top	100%	100%
Top	Bottom	0%	0%
Bottom	Bottom	0%	100%
Center	Center	50%	50%

- When the transition type is NAM, the outputs of the A bus and B bus in the above table are the outputs subjected to NAM.
- The transition indicators always show the progress of the background A bus.
- The operation of the left lever and that of the right lever can be swapped. (See “Operation Settings (Operation Menu)” in Chapter 16 (Volume 2).)

Independent Key Transitions With a Simple Transition Module

You carry out independent key transition operations using the independent key transition control block (simple type). This controls only keys 3 and 4. However, each key button can be assigned to any key in setup (see Chapter 16 “Overall Control Panel Settings (Config Menu)” (Volume 2)).



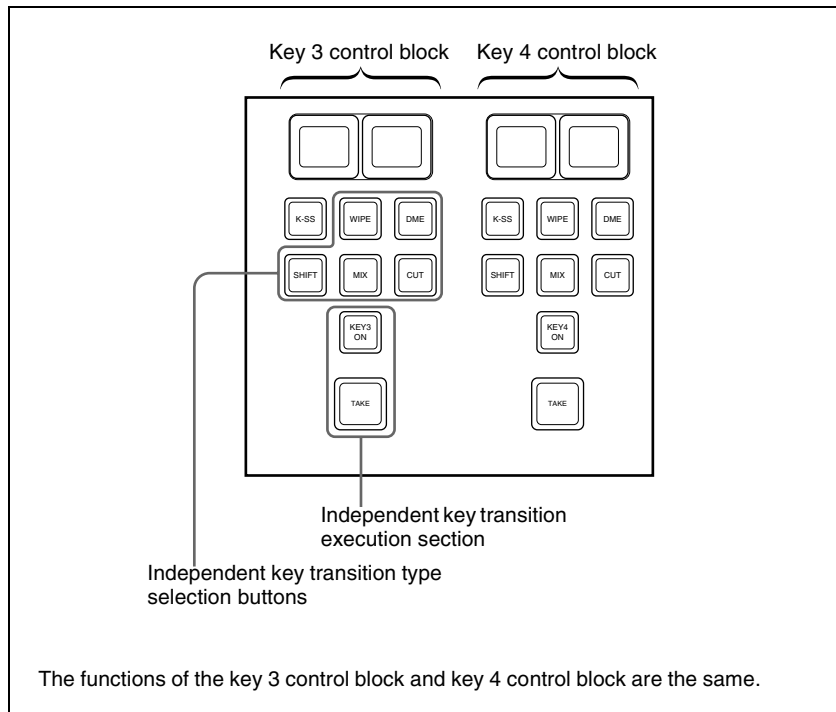

Independent key transition control block (simple type)

Carrying out a transition using a simple-type independent key transition control block

- 1 Select the transition type for key 3 or key 4 using the independent key transition type selection buttons.

To fade a key in or out: Press the [MIX] button, turning it on.

To insert or delete a key using a dedicated wipe pattern: Press the [WIPE] button, turning it on.

To insert or delete a key using a dedicated DME wipe pattern: Press the [DME] button, turning it on.

For details of wipe settings, see “Wipe Settings for Independent Key Transitions” (page 455). For details of DME wipe settings, see “DME Wipe Settings for Independent Key Transitions” (page 477).

To cut the key instantaneously in or out: Press the [CUT] button, turning it on.

If, in the Setup menus, you set insertion and deletion as independent modes, make the settings for the next transition in the independent key transition control block.

Separate settings are required both when inserting a key and when deleting it. For example, with the key not inserted, if you select the transition type and carry out a transition, this will be the setting when inserting a key.

- 2** Carry out the transition in the independent key transition execution section.

To insert or delete the key gradually with a mix or wipe transition:

Press the [TAKE] button.

To set the independent key transition rate using a simple-type transition control block, use the key 3 and key 4 Transition menus. For details, see “Setting the Independent Key Transition Rate” (page 366).

To cut the key in or out instantaneously: Press the [KEY 3 ON] button or [KEY 4 ON] button.

Note

In an independent key transition, the pattern limit function is not available.



Chapter 4 Keys

Key Setting Operations Using Menus	378
Key Setting Menus	378
Key Type Setting	379
Chroma Key Composition	381
Chroma Key Adjustments	382
Selecting Key Fill and Key Source	387
Key Edge Modifications	390
Masks	397
Applying a DME Effect to a Key	400
Specifying the Key Output Destination	403
Key Modify Clear	404
Blink Function	404
Video Processing	405
Key Setting Operations With the Key Control Block	406
Operations in the Key Control Block	406
Key Edge Modifications	410
Masks	414
Applying a DME Effect to a Key	415
Other Key Setting Operations	417
Resizer	419
Two-Dimensional Transformations of Keys	419
Resizer Interpolation Settings	424
Resizer Crop/Border Settings	424
Applying Resizer Effects	427
Key Snapshots	433
Key Snapshot Operations	433
Key Snapshot Operations Using a Simple Transition Module	435

Key Setting Operations Using Menus

There are two ways of making key settings: either using menus, or using the key control block.

This section describes basic procedures for making key settings using the menus, taking the M/E-1 >Key1 menu as an example.

Operations in the Key menus are the same for all banks (M/E-1 to M/E-3 and PGM/PST).

For details of the method of using the key control block, see “Key Setting Operations With the Key Control Block” (page 406).

Key Setting Menu

The key setting menus for each bank (M/E-1 to M/E-3 and PGM/PST) are as follows.

Bank	Keys set	Menus
M/E-1	Keys 1 to 4	M/E-1 >Key1 to 4
M/E-2	Keys 1 to 4	M/E-2 >Key1 to 4
M/E-3	Keys 1 to 4	M/E-3 >Key1 to 4
PGM/PST	Downstream keys 1 to 4	PGM/PST >DSK1 to 4

Accessing a key setting menu

For example, to access the M/E-1 >Key1 menu, carry out any of the following procedures.

- In the menu control block, select the top menu selection button [M/E 1], then press VF1 ‘Key1.’
- In the M/E-1 bank transition control block, press the KEY1 next transition selection button twice in rapid succession.
- In the M/E-1 bank independent key transition control block, press the key delegation button [KEY1] twice in rapid succession.
- In the key control block, press the M/E delegation button [M/E1], then press the key delegation button [KEY1] twice in rapid succession.

Any of the above operations displays the M/E1 >Key1 menu.

Note that you can access the DSK menus by pressing the button for the corresponding key in the downstream key control block twice in rapid succession.

Key Type Setting

Setting the key type in a menu

- 1** In the M/E-1 >Key1 menu, select HF1 'Type.'

The Type menu appears.

- 2** In the <Key Type> group, select the key type.

Luminance: luminance key

Linear: linear key

Chroma: chroma key

Color Vector: color vector key

Wipe Pattern: wipe pattern key

Key Wipe Pattern: key wipe pattern key

For the selected key type, you can now set the parameters.

For an overview of the key types, see page 48.

- 3** Carry out the following settings as required, depending on the key type selected in step 2.

To enable clean mode (see page 49) for a luminance key, linear key or color vector key: Select [Clean Mode] so that it is set on.

When clean mode is enabled, key fill is added to the background without cutting out with key source.

When chroma key is selected: Select [Chroma Adjust] to access the Chroma Adjust menu (see page 382), and make the required settings.

When a wipe pattern key is selected: In the M/E-1 >Wipe menu (see page 438), select the pattern and set any modifiers, then return to the M/E-1 >Key1 menu.

When a key wipe pattern key is selected: In the M/E-1 >Key1 >Transition >Wipe Adjust menu (see page 455), carry out pattern selection and modifier setting, then return to the M/E-1 >Key1 >Type menu.

Note

For a wipe pattern selected for a wipe pattern key or key wipe pattern key, the [Edge] and [Direction] modifier settings are not available.

- 4** Set the parameters.

- **When a luminance key or linear key is selected**

Knob	Parameter	Adjustment	Setting values
1	Clip	Reference level for generating the key signal	+109.59 to -7.31
2	Gain	Key sensitivity	-100.00 to +100.00
3	Density	Key density	0.00 to 100.00
4	Filter	Filter coefficient	1 to 9 ^{a)}

a) Setting this value to 1, produces the “through” state in which no filter is applied. The larger the value, the more strongly the filter applies.

• **When a chroma key is selected**

Knob	Parameter	Adjustment	Setting values
3	Density	Key density	0.00 to 100.00

• **When a color vector key is selected**

Parameter group [1/2]

Knob	Parameter	Adjustment	Setting values
1	Y Clip	Reference level for creating luminance signal	+109.59 to -7.31
2	Y Gain	Luminance signal sensitivity	-100.00 to +100.00
3	C Clip	Reference level for creating chrominance signal	100.00 to 0.00
4	C Gain	Chrominance signal sensitivity	-100.00 to +100.00
5	Density	Key density	0.00 to 100.00

Parameter group [2/2]

Knob	Parameter	Adjustment	Setting values
1	Y Filter	Luminance signal filter coefficient	1 to 9
2	C Filter	Chrominance signal filter coefficient	1 to 9

• **When a wipe pattern key or key wipe pattern key is selected**

Knob	Parameter	Adjustment	Setting values
1	Size	Pattern size	0.00 to 100.00
2	Soft	Degree of edge softness	0.00 to 100.00
3	Density	Key density	0.00 to 100.00

5 Make the following settings as required.



To invert the black and white sense of the key source: Press [Key Invert], turning it on.

To adjust the horizontal position or key source width for a luminance key, linear key, or chroma key: Press [Key Position], turning it on, and set the parameters.

Knob	Parameter	Adjustment	Setting values
1	H Phase	Key horizontal position	-4.00 to +4.00
2	Left	Key left edge position	-4.00 to +4.00
3	Right	Key right edge position	-4.00 to +4.00

To set the key priority: Press [Key Priority] or select VF7 'Misc' and HF3 'Key Priority' to access the Key Priority menu.

For details, see "Setting the Key Priority by a Menu Operation" (page 345).

Chroma Key Composition

Composing an image by chroma keying

There are two types of composition for chroma keying: normal mix, and additive mix.

For an overview of the chroma key composition, see page 49.

1 In the M/E-1 >Key1 menu, select HF1 'Type.'

2 Select [Chroma] in the <Key Type> group.

It becomes possible to adjust the key density (*see page 380*).

3 Select [Chroma Adjust].

The Chroma Adjust menu appears.

4 Carry out auto chroma key adjustments.

Also carry out manual adjustments if necessary to obtain an optimum chroma key image.

For the adjustment procedures, see page 382.

5 In the <Mix Mode> group, select [Normal Mix] or [Additive Mix] depending on the desired type of chroma key composition.

When using an additive mix for chroma keying, the (typically blue) background parts of the foreground video must be converted to black. For this, use the color cancel function (*see page 383*).

Using the plane function

In an additive mix, since no key is applied to the foreground, any variations in the (typically blue) background may appear in the composite image. To avoid this, a particular luminance level can be set for the (blue) background, and regions of lower luminance forcibly cut.

- 1** In the Chroma Adjust menu, set [Plane] on.
- 2** Adjust the following parameter.

Knob	Parameter	Adjustment	Setting values
1	Luminance	Luminance level	0.00 to 100.00

Chroma Key Adjustments

There are two ways of making chroma key adjustments: automatically, using the auto chroma key function, or manually, making individual adjustments such as color cancel adjustments and window adjustments.

Making auto chroma key adjustments

Auto chroma key is an automatic adjustment function which allows you to specify a part of the foreground video (for example, the blue background color) and use it as a reference for creating the chroma key image.

- 1** In the M/E-1 >Key1 menu, select HF1 ‘Type,’ then select [Chroma] in the <Key Type> group.
- 2** Select [Chroma Adjust].
The Chroma Adjust menu appears.
- 3** Select [Sample Mark] in the <Auto> group.
The foreground video only appears on the monitor, with a white box-shaped sample selector.
- 4** Adjust the position and size of the sample selector, to specify the color to be used as the basis of chroma keying (typically a blue background).



Knob	Parameter	Adjustment	Setting values
1	Position H	Horizontal position	-100.00 to +100.00 ^{a)}
2	Position V	Vertical position	-100.00 to +100.00 ^{a)}
3	Size	Size	1.00 to 100.00

a) The setting ranges depend on the signal format, screen aspect ratio, and size settings.

5 Select [Auto Start] in the <Auto> group.

This executes an auto chroma key based on the color specified by the sample selector, and displays the composite image on the monitor.

Making key active adjustments

When the key active function is on, the composite image is output to the monitor, and you can watch the monitor while manually adjusting the keying. When the key active function is off, only the foreground image appears. Set this off when manually adjusting color cancel (*see the next section*).

- 1 In the Chroma Adjust menu, set [Key Active] on.
- 2 Adjust the following parameters.

Knob	Parameter	Adjustment	Setting values
1	Clip	Chroma key reference level	0.00 to 100.00
2	Gain	Key gain	-100.00 to +100.00
3	Hue	Hue	359.99 to 0.00
4	Density	Density	0.00 to 100.00
5	Filter	Filter coefficient	1 to 9

Making color cancel adjustments

If the background color is leaking into the foreground video, turning the color cancel function on allows you to eliminate this leakage.

- 1 In the Chroma Adjust menu, turn [Key Active] off.
Only the foreground image appears on the monitor.
- 2 In the <Color Cancel> group, set [Color Cancel] on.
- 3 Adjust the following parameters.

Knob	Parameter	Adjustment	Setting values
1	Luminance	Luminance	0.00 to 100.00
2	Saturation	Saturation	0.00 to 100.00
3	Hue	Hue	359.99 to 0.00
5	Filter	Filter coefficient	1 to 9

4 Set [Key Active] on.

The chroma key composite image now appears in the monitor.

Making key signal adjustments for color cancel

When the color cancel function is set on, you can adjust the key signal for color cancel.

1 In the <Color Cancel> group of the Chroma Adjust menu, set [Color Cancel] on.

2 In the <Color Cancel> group, set [Cancel Key] on.

The cancel key is now on, and you can now adjust the key signal for color cancel.

Knob	Parameter	Adjustment	Setting values
1	Clip	Color cancel key reference level	0.00 to 100.00
2	Gain	Color cancel key gain	-100.00 to +100.00

3 Make the following settings, as required, in the <Color Cancel> group.

- **When setting [Key Position] on and adjusting the color cancel key edge position**

Knob	Parameter	Adjustment	Setting values
1	H Phase	Move left and right edges of the color cancel key simultaneously	Left edge position value shown
2	Left	Move left edge of the color cancel key	-3.00 to +3.00
3	Right	Move right edge of the color cancel key	-3.00 to +3.00

- **When setting [Window] on and adjusting the detection range of the color cancel key**

Knob	Parameter	Adjustment	Setting values
1	Crop	Crop value	100.00 to 0.00



Knob	Parameter	Adjustment	Setting values
2	Angle	Angle value	180.00 to 0.00

For details of the crop and angle parameters, see “Chroma key window” (page 50).

- When setting [Y Balance] on and adjusting the ratio in which Y balance is added to the color cancel key

Knob	Parameter	Adjustment	Setting values
1	Mixture	Ratio of Y balance key	0.00 to 100.00

Adjusting the window

Setting the window function on allows you to adjust the detection range used to determine the key signal. When this function is off, the default range is used for the key.

For an overview of the window, see “Chroma key window” (page 50).

After making sure that the values of Clip, Gain, and Hue are adjusted appropriately, use the following procedure to make the window adjustment.

- 1 In the Chroma Adjust menu, set [Window] on.
- 2 Adjust the following parameters.

Knob	Parameter	Adjustment	Setting values
1	Crop	Crop value	100.00 to 0.00
2	Angle	Angle value	180.00 to 0.00

Adjusting the Y balance

Setting the Y balance on allows you to specify that, even if the hue is the same, only portions of a particular luminance will be replaced by the background.

For an overview of the Y balance, see page 51.

- 1 In the Chroma Adjust menu, set [Y Balance] on.
- 2 Adjust the following parameters.

Knob	Parameter	Adjustment	Setting values
1	Clip	Luminance range	0.00 to 100.00
2	Gain	Key gain	-100.00 to +100.00

Knob	Parameter	Adjustment	Setting values
3	Luminance	Luminance	0.00 to 100.00

Adjusting the chroma key shadow

This function allows a shadow falling on the (typically blue) background color to be rendered more realistically. Since portions of the (blue) background of less than a certain luminance are treated as shadows, there is no effect on cutting out of the foreground.

- 1** In the Chroma Adjust menu, set [Shadow] on.
- 2** Adjust the following parameters.

Knob	Parameter	Adjustment	Setting values
1	Luminance	Reference luminance for shadows	0.00 to 100.00
2	Gain	Shadow key gain	-100.00 to +100.00
3	Density	Shadow opacity	0.00 to 100.00
4	Soft	Shadow softness	0.00 to 100.00

Note

When chroma key shadow is on, key edge is changed to normal, and soft edge is switched off.

Adjusting the video signal

You can change the gain of the foreground signal, or vary the Hue. There are separate adjustments for the gain of the whole video signal, or Y and C individually.

- 1** In the Chroma Adjust menu, set [FRGD CCR] on.
- 2** Adjust the following parameters.

Knob	Parameter	Adjustment	Setting values
1	Video Gain	Overall gain of video signal	-100.00 to +100.00
2	Y Gain	Y signal gain	-100.00 to +100.00
3	C Gain	C signal gain	-100.00 to +100.00
4	Hue	Hue offset amount	-180.00 to +180.00



Selecting Key Fill and Key Source

Selecting key fill and key source

To select key fill and key source for key 1 on the M/E-1 bank, use the following procedure.

- 1** In the M/E-1 >Key1 menu, select HF1 'Type.'
The Type menu appears.
- 2** In the <Key Fill> group, select either of the following for use as key fill.

Key Bus: signal selected on the key 1 fill bus

Matte: signal from the dedicated color matte generator

- 3** If you selected [Key Bus] in step 2, select the key fill signal on the key 1 row in the cross-point control block.

To select key fill for key 3 or key 4 in the cross-point control block, press the [KEY3] button or [KEY4] button to the right of the key bus buttons, turning it on, to allocate the key 1 row or key 2 row to the key 3 fill or key 4 fill, then press the desired cross-point button.

- 4** If you selected [Matte] in step 2, in the same Type menu, press the [Matte Adjust] button to display the Matte Adjust menu, then adjust the single-color or two-color combination color matte. Select whether to use a single-color matte or a two-color combination in the <Fill Matte> group.

Flat Color: Adjust color 1 with the following parameters.

Knob	Parameter	Adjustment	Setting values
1	Luminance	Luminance	0.00 to 100.00
2	Saturation	Saturation	0.00 to 100.00
3	Hue	Hue	359.99 to 0.00

Mix Color: Carry out a color mix. Adjust color 1 and color 2, and select a mix pattern (*see the next section*).

- 5** In the <Key Source> group, specify the key source selection mode.

Self: The key fill bus signal is automatically selected as the key source.

When the key type is selected as chroma key, select [Self].

Auto Select: The signal allocated, being paired with the key fill bus signal, to a cross-point button is automatically selected as the key source. The setting of key fill and key source pairs is carried out in the Setup menu.

(See “Cross-Point Settings (Xpt Assign Menu)” in Chapter 16 (Volume 2).)

Split: You can select a key source signal independently of the key source automatically selected in Auto Select mode.

- 6** When [Split] was selected in step 5, hold down the [SPLIT] button in the key control block, then in the cross-point control block key 1 row, select the key source signal. Alternatively, hold down the key delegation button in the transition control block and press a cross-point button in the key 1 row to select the key source signal.

Notes

- In the above-stated key 1 row operation, you can only select a key signal assigned to a cross-point button. For the method of selecting a video signal, see “To select a video signal assigned to a cross-point button” below.
On the MVS-8000, the video signal selection operation is not supported.
- When [Split] is selected, the key memory function (*see page 56*) is disabled.

To select a video signal assigned to a cross-point button

By selecting the key source bus with an auxiliary bus control block AUX delegation button, and pressing the cross-point button, it is possible to select the video signal assigned to the cross-point button.

(If you press the cross-point button with holding down [KEY], the key signal assigned to the cross-point button.)

Note

In the above operation, the following settings must have been made.

- Assigning the key source bus to an AUX delegation button

For details, see “Auxiliary Bus Control Block Settings (Aux Assign Menu)” in Chapter 16 (Volume 2).

- Setting the [KEY] button operating mode

For details, see “Operation Settings (Operation Menu)” in Chapter 16 (Volume 2).

This operation is not supported on the MVS-8000.

Carrying out a color mix for key fill

When [Matte] is selected for key fill, you can combine color 1 and color 2. For the combination, you can use not only a key wipe generator pattern, but also the dedicated pattern for key edge color mix.



- 1 In the <Key Fill> group of the Type menu, select [Matte] and press [Matte Adjust].

The Matte Adjust menu appears.

- 2 Select [Mix Color] in the <Fill Matte> group.
- 3 Adjust the following parameters.

Knob	Parameter	Adjustment	Setting values
1	Size	Pattern size	0.00 to 100.00
2	Soft	Softness of the edge of the pattern	0.00 to 100.00

- 4 Select the combining pattern in the <Mix Pattern> group.

Key Wipe: The wipe pattern selected for an independent key transition is used for combination. You can change this pattern by pressing [Pattern Select] to open the menu for key wipe pattern selection (Pattern Select menu), and make adjustments by pressing [Pattern Adjust] to open the menu for pattern adjustment (Wipe Adjust menu).

Key Edge Pattern: Combine using the dedicated pattern selected for the color mix in the key edge fill. You can change this pattern by pressing [Pattern Select] to open the menu for edge color mix dedicated wipe pattern selection (Mix Pattern Select menu), and make adjustments by pressing [Pattern Adjust] to open the menu for pattern adjustment (Matte Adjust menu).

For details, see “Carrying out a color mix for the key edge fill matte” (page 394).

- 5 In the Type menu, adjust color 1 and color 2.

To adjust color 1, select [Color1], and to adjust color 2, select [Color2], then adjust the following parameters.

Knob	Parameter	Adjustment	Setting values
1	Luminance	Luminance	0.00 to 100.00
2	Saturation	Saturation	0.00 to 100.00
3	Hue	Hue	359.99 to 0.00

- 6 To interchange color 1 and color 2, press the [Color Invert] button, turning it on.

Key Edge Modifications

To modify the key edge of key 1 on the M/E-1 bank, use the following procedure.

- 1 In the M/E-1 >Key1 menu, select HF2 ‘Edge.’

The Edge menu appears.

- 2 Select the edge type in the <Edge> group.

For an overview of the key edge modifications, see “Edge modifiers” (page 52).

Normal: unadorned edge

Border: edge with border applied

Drop Border: edge with drop border applied

Shadow: edge with shadow applied

Outline: edge used as outline

Emboss: embossing effect applied to edge

If you select [Normal], skip to step 7.

- 3 Set the border width and other parameters.

When border or outline is selected: The setting parameters depend on the key type and whether the separate edge function is enabled or not. To enable the separate edge function, press [Separate Edge], setting it on.

- **Separate edge off**

Knob	Parameter	Adjustment	Setting values
1	Width	Width	0.00 to 8.00 ^{a)} (0.00 to 100.00) ^{b)}
3	Density	Density	0.00 to 100.00

a) In the “4H mode” and when [Fine Key] (page 393) is on, the setting value range is 0.00 to 4.00.

b) When a wipe pattern key or key wipe pattern key is selected as the key type

- **Separate edge on**

The left, right, top, and bottom border or outline widths can be adjusted



independently. The separate edge function is only valid when a luminance key, linear key, or chroma key is selected as the key type.

Knob	Parameter	Adjustment	Setting values
1	Top	Top edge width	0.00 to 8.00 ^{a)}
2	Left	Left edge width	0.00 to 8.00 ^{a)}
3	Right	Right edge width	0.00 to 8.00 ^{a)}
4	Bottom	Bottom edge width	0.00 to 8.00 ^{a)}
5	Density	Density	0.00 to 100.00

a) In the “4H mode” and when [Fine Key] (page 393) is on, the setting value range is 0.00 to 4.00.

When drop border or shadow is selected: The setting parameter values depend on the on/off setting of key drop and the selection of 4H mode/ 8H mode (see page 54).

• “Key drop OFF” mode

Knob	Parameter	Adjustment	Setting values
1	Width	Width	0.00 to 8.00
2	Position	Position	359.99 to 180.00
3	Density	Density	0.00 to 100.00

• “Key drop ON” mode

Knob	Parameter	Adjustment	Setting values
1	Width	Width	0.00 to 8.00 ^{a)}
2	Position	Position	359.99 to 0.00
3	Density	Density	0.00 to 100.00

a) In the “4H mode” and when [Fine Key] (page 393) is on, the setting value range is 0.00 to 4.00.

When emboss is selected:

Knob	Parameter	Adjustment	Setting values
1	Width	Width	0.00 to 4.00
2	Position	Position	359.99 to 0.00
3	Density ^{a)}	Density	0.00 to 100.00

a) The Density adjustment only affects the key edge. This can be adjusted separately from Key Density, and if Key Density is set to 0.00, the embossed edge effect only can be applied.

To make edge fill adjustments, carry out the settings in step 6.

- 4** Select the edge fill signal in the <Edge Fill> group.

Utility 1 Bus: signal selected on the utility 1 bus

Matte: signal from dedicated color matte generator.

It becomes possible to adjust color 1.

Knob	Parameter	Adjustment	Setting values
1	Luminance	Luminance	0.00 to 100.00
2	Saturation	Saturation	0.00 to 100.00
3	Hue	Hue	359.99 to 0.00

When the edge type is outline, in place of the edge fill signal, the selected key fill signal fills the outline, and elsewhere remains as the background.

- 5** Carry out the following operation, depending on the selection in step 4.

When [Utility 1 Bus] is selected: Hold down the [UTIL] button in the cross-point control block, and select the signal in the background A bus row.

While the [UTIL] button is held down, the background A bus changes to the utility 1 bus.

Note

To enable the [UTIL] button, its operation mode must be set to [Hold] beforehand. (See “Operation Settings (Operation Menu)” in Chapter 16 (Volume 2).)

When [Matte] is selected: Press [Matte Adjust] in the same EDGE menu, to display the Matte Adjust menu, and adjust a single color or two-color combination color matte.

You can select whether to use a single color matte or a two-color combination color matte in the <Edge Matte> group.

For the color mix operation, see “Carrying out a color mix for the key edge fill matte” (page 394).

- 6** When emboss is selected for the edge type, adjust the color in the <Emboss Fill> group.

To adjust matte 1 press [Matte1], and to adjust matte 2 press [Matte2], then adjust the following parameters.

Knob	Parameter	Adjustment	Setting values
1	Luminance	Luminance	0.00 to 100.00



Knob	Parameter	Adjustment	Setting values
2	Saturation	Saturation	0.00 to 100.00
3	Hue	Hue	359.99 to 0.00

- 7** To make the edge soft, press [Soft Edge] to set it on, and adjust the softness.

Knob	Parameter	Adjustment	Setting values
1	Soft	Edge softness	0.00 to 100.00

For a normal edge, when [Soft Edge] is enabled, [Key Drop] is kept on.

- 8** To make separate fine adjustments to the positions of the left, right, top, and bottom of the source edge, press [Fine Key], to set it on, and adjust the following parameters.

Parameter group [1/2]

Knob	Parameter	Adjustment	Setting values
1	Top	Key top edge position	-2.00 to +2.00
2	Left	Key left edge position	-2.00 to +2.00
3	Right	Key right edge position	-2.00 to +2.00
4	Bottom	Key bottom edge position	-2.00 to +2.00

Parameter group [2/2]

Knob	Parameter	Adjustment	Setting values
1	H Phase	Key horizontal position	Left edge position value shown
2	V Phase	Key vertical position	Top edge position value shown

Note

In the emboss function it is not possible to set [Fine Key] on.

- When the edge type is normal, drop border or shadow, enabling the [Fine Key] function keeps [Key Drop] on.
- When applying a border to the key edge, enabling the [Fine Key] function halves the border width setting range.

To fix key fill and key source in key drop off mode

- 1** In the Edge menu, press [Key Delay Mode].

The Key Delay Mode menu appears.

Note

This function is only supported on the MVS-8000G.

- 2 Press [Frame Delay], setting it to On.

Note

This function uses the resizer, and therefore the expected result of the setting may not be obtained if conditions do not allow the resizer to be used.

Carrying out a color mix for the key edge fill matte

When you select 'Matte' for the edge fill of a border, drop border, or shadow, you can create a combination of color 1 and color 2 using a wipe pattern generated by the dedicated pattern generator.

- 1 In the <Edge Fill> group of the Edge menu, select [Matte], then press [Matte Adjust].

The edge fill Matte Adjust menu appears.

- 2 In the <Edge Matte> group, select [Mix Color], turning it on.

- 3 Adjust the following parameters.

Knob	Parameter	Adjustment	Setting values
1	Size	Pattern size	0.00 to 100.00
2	Soft	Softness of pattern edge	0.00 to 100.00
3	Pattern	Pattern number	1 to 24 ^{a)}

a) The patterns are the same as standard wipes. (For details, see "Wipe Pattern List" in Appendix (Volume 1) (page 560).)

To select the pattern, display the Mix Pattern Select menu by pressing [Mix Pattern] in the edge fill Matte Adjust menu. After selecting one of the patterns (standard wipe patterns 1 to 24) displayed in the Mix Pattern Select menu, you can adjust the following parameters.

Knob	Parameter	Adjustment	Setting values
1	Size	Pattern size	0.00 to 100.00
2	Soft	Softness of pattern edge	0.00 to 100.00

- 4 Adjust color 1 and color 2.

To adjust color 1 press [Color 1], and to adjust color 2 press [Color 2], turning it on respectively, and adjust the following parameters.

Knob	Parameter	Adjustment	Setting values
1	Luminance	Luminance	0.00 to 100.00
2	Saturation	Saturation	0.00 to 100.00
3	Hue	Hue	359.99 to 0.00

5 If required, set the pattern modifiers.

• When turning [Position] on and setting the pattern position

Knob	Parameter	Adjustment	Setting values
1	Position H	Horizontal position	-200.00 to +200.00 ^{a)}
2	Position V	Vertical position	-200.00 to +200.00 ^{a)}

a) See page 65.

• When turning [Multi] on and replicating the pattern

Knob	Parameter	Adjustment	Setting values
1	H Multi	Number of repetitions of pattern horizontally	1 to 63
2	V Multi	Number of repetitions of pattern vertically	1 to 63
3	Invert Type	Replication layout	1 to 4 ^{a)}

a) See page 68.

• When turning [Aspect] on and setting the aspect ratio of the pattern

Knob	Parameter	Adjustment	Setting values
1	Aspect	Aspect ratio	-100.00 to +100.00 ^{a)}

a) See page 67.

• When turning [Angle] on in the <Rotation> group and inclining the pattern

Knob	Parameter	Adjustment	Setting values
1	Angle	Angle of pattern rotation	-100.00 to +100.00 ^{a)}

a) See page 66.

- When turning [Speed] on in the <Rotation> group and rotating the pattern at a constant speed

Knob	Parameter	Adjustment	Setting values
1	Speed	Rotation rate of pattern	-100.00 to +100.00 a)

a) See page 66.

- 6 To interchange color 1 and color 2, press [Color Invert], turning it on.

Applying the zabton effects

- 1 In the Edge menu, press [Zabton], turning it on.
- 2 Adjust the following parameters.

Knob	Parameter	Adjustment	Setting values
1	Size	Pattern size	0.00 to 100.00
2	Soft	Pattern edge softness	0.00 to 100.00
3	Density	Density	0.00 to 100.00

Note

If in the pattern selection described below you select “Mask Pattern,” and “Box” for the main mask, the “Size” parameter here cannot be adjusted. Set “Size” in the Main Mask menu.

- 3 To adjust the pattern and color, press [Zabton Adjust].
The Zabton Adjust menu appears.
- 4 In the <Zabton Pattern> group, select the pattern.

Key Wipe: Use a key wipe.

You can change this pattern by pressing [Pattern Select] to open the menu for key wipe pattern selection (Pattern Select menu), and make adjustments by pressing [Pattern Adjust] to open the menu for pattern adjustment (Wipe Adjust menu).

Key Edge Pattern: Use a color mixing pattern for key edge.

You can change this pattern by pressing [Pattern Select] to open the menu for edge color mix dedicated wipe pattern selection (Mix Pattern Select menu), and make adjustments by pressing [Pattern Adjust] to open the menu for pattern adjustment (Matte Adjust menu).

Mask Pattern: Use the main mask Box or Pattern.

You can also press [Pattern Select], and in the corresponding pattern adjustment menu, change the pattern.



- 5 To adjust the color, press [Zabton Color] and adjust the following parameters.

Knob	Parameter	Adjustment	Setting values
1	Luminance	Luminance	0.00 to 100.00
2	Saturation	Saturation	0.00 to 100.00
3	Hue	Hue	359.99 to 0.00
4	Density	Density	0.00 to 100.00

Masks

There are two masks, which can be used to mask off unneeded parts of a key or background, or to remove defects, and these are known as the main mask and subsidiary mask. You can either use the main mask and subsidiary mask independently, or at the same time.

For an overview of the masks, see page 55.

Using the main mask

For example, to use the main mask for key 1 on the M/E-1 bank, use the following procedure.

- 1 In the M/E-1 >Key1 menu, select HF3 'Main Mask.'

The Main Mask menu appears.

- 2 In the <Mask Type> group, select the mask type.

Key Mask: Masks a part of a key.

Bkgd Mask: Masks a part of a background.

- 3 In the <Mask Source> group, select the mask source.

Box: signal from the dedicated box generator

Pattern: signal from the dedicated pattern generator

- 4 Set the mask source parameters.

• **When a box is selected**

Knob	Parameter	Adjustment	Setting values
1	Top	Top position	-100.00 to +100.00

Knob	Parameter	Adjustment	Setting values
2	Left	Left position	-100.00 to +100.00
3	Right	Right position	-100.00 to +100.00
4	Bottom	Bottom position	-100.00 to +100.00
5	Soft	Box softness	0.00 to 100.00

• **When a pattern is selected**

Knob	Parameter	Adjustment	Setting values
1	Size	Pattern size	0.00 to 100.00
2	Soft	Edge softness	0.00 to 100.00
5	Pattern	Pattern number	1 to 24 ^{a)}

a) The pattern is the same as a standard wipe. (See “Wipe Pattern List” in Appendix (Volume 1) (page 560).)

To select the pattern, display the Mask Ptn Select menu by pressing the [Mask Ptn Select] button in the Main Mask menu. After selecting one of the patterns (standard wipe patterns 1 to 24) displayed in the Mask Ptn Select menu, you can adjust the following parameters.

Knob	Parameter	Adjustment	Setting values
1	Size	Pattern size	0.00 to 100.00
2	Soft	Edge softness	0.00 to 100.00

5 To invert the black and white sense of the mask source, press the [Mask Invert] button, turning it on.

6 When a pattern is selected as the mask source, set the pattern modifiers as required.

• **When turning [Position] on and setting the pattern position**

Knob	Parameter	Adjustment	Setting values
1	Position H	Horizontal position	-200.00 to +200.00 ^{a)}
2	Position V	Vertical position	-200.00 to +200.00 ^{a)}

a) See page 65.

• **When turning [Multi] on and replicating the pattern**

Knob	Parameter	Adjustment	Setting values
1	H Multi	Number of repetitions of pattern horizontally	1 to 63



Knob	Parameter	Adjustment	Setting values
2	V Multi	Number of repetitions of pattern vertically	1 to 63
3	Invert Type	Replication layout	1 to 4 ^{a)}

a) See page 68.

• **When turning [Aspect] on and setting the aspect ratio of the pattern**

Knob	Parameter	Adjustment	Setting values
1	Aspect	Aspect ratio	-100.00 to +100.00 ^{a)}

a) See page 67.

• **When turning [Angle] on in the <Rotation> group and setting the angle of the pattern rotation**

Knob	Parameter	Adjustment	Setting values
1	Angle	Pattern angle	-100.00 to +100.00 ^{a)}

a) See page 66.

• **When turning [Speed] on in the <Rotation> group and setting the rate of pattern rotation**

Knob	Parameter	Adjustment	Setting values
1	Speed	Rate of pattern rotation	-100.00 to +100.00 ^{a)}

a) See page 66.

Using the subsidiary mask

For example, to use the subsidiary mask for key 1 on the M/E-1 bank, use the following procedure.

1 In the M/E-1 >Key1 menu, select HF4 'Sub Mask.'

The Sub Mask menu appears.

2 In the <Mask Type> group, select the mask type.

Key Mask: Masks a part of a key.

Bkgd Mask: Masks a part of a background.

3 In the <Mask Source> group, select the mask source.

Wipe: wipe pattern selected for a transition

If you select [Wipe], select the pattern and make modifier settings in

the M/E-1 >Wipe menu (see page 438), then return to this M/E-1 >Key1 menu.

In the case of a wipe pattern selected for a mask, the modifier [Edge] and [Direction] settings are not available.

Utility 1 Bus: signal selected on the utility 1 bus

When you selected [Utility 1 Bus], hold down the [UTIL] button in the M/E-1 bank cross-point control block, and select the signal with the background A bus buttons. While the [UTIL] button is pressed, the background A bus switches to the utility 1 bus.

Note

To enable the [UTIL] button, its operation mode must be set to [Hold] beforehand. (See “Operation Settings (Operation Menu)” in Chapter 16 (Volume 2).)

4 Set the mask source parameters.

• **When wipe is selected**

Knob	Parameter	Adjustment	Setting values
1	Size	Pattern size	0.00 to 100.00
2	Soft	Edge softness	0.00 to 100.00

• **When utility 1 bus is selected**

Knob	Parameter	Adjustment	Setting values
1	Clip	Reference level for creating mask signal	+109.59 to -7.31
2	Gain	Gain	-100.00 to +100.00

5 To invert the black and white sense of the mask source, press the [Mask Invert] button, turning it on.

Applying a DME Effect to a Key

Note

For one M/E bank, DME effects (including DME wipes) can be used in up to two places on the dedicated interface and in only one place on the SDI interface simultaneously.

When combining the SDI interface with the dedicated interface, you can apply DME effects to a maximum of three keys. (Requires a setting in setup.)

For details, see “Interfacing With External Devices (Device Interface Menu)” in Chapter 16 (Volume 2).

Assigning a DME to a key

- 1** In the M/E-1 >Key1 menu, select HF5 ‘Processed Key.’
The Processed Key menu appears.
- 2** In the <DME Select> group, select the DME channel (DME1 to DME8) to be used.

The lit colors of [DME1] to [DME8] indicate the DME assignment.

Lit green: Shows the DME assigned to the currently selected key.

Lit amber: Shows the DME assigned to a key other than the currently selected key.

Off: DME is not assigned.

To select a DME being used by another keyer

Press [Override], turning it on, then select the DME channel.

The later selection is valid, and the button lights green.

Using two or three DME channels on one keyer

When using the DME dedicated interface, proceed as follows.

- 1** Select the DME for the first channel (*see the previous item, “Assigning a DME to a key”*), then select the successive channel for the second channel. For the third channel select the channel after that.
- 2** To select the video signal for the second channel, hold down the [UTIL] button in the cross-point control block, and select the signal in the Key1 row (DME external video bus).
- 3** To select the video signal for the third channel, hold down the [UTIL] button in the cross-point control block, and carry out the following operation.
 - If the selected DME is channel 3 or channel 4, turn off the [KEY4] button in the key 2 row, then select the signal in the key 2 row (DME utility 1 bus).
 - If the selected DME is channel 7 or channel 8, turn on the [KEY4] button in the key 2 row, then select the signal in the key 4 row (DME utility 2 bus).

Using four DME channels on one keyer

When using the DME dedicated interface, proceed as follows.

- 1** Select the DME channel 1 (or channel 5) for the first channel (*see “Assigning a DME to a key” (page 401)*). In the same way, select the DME channel 2 (channel 6) for the second channel, the DME channel 3 (channel 7) for the third channel, and the DME channel 4 (channel 8) for the fourth channel.
- 2** To select the video signal for the second channel, hold down the [UTIL] button in the cross-point control block, and select the signal in the Key1 row (DME external video bus).
- 3** To select the video signal for the third channel, hold down the [UTIL] button in the cross-point control block, and carry out the following operation.
 - If the selected DME is channel 3, turn off the [KEY4] button in the key 2 row, then select the signal in the key 2 row (DME utility 1 bus).
 - If the selected DME is channel 7, turn on the [KEY4] button in the key 2 row, then select the signal in the key 4 row (DME utility 2 bus).
- 4** To select the video signal for the fourth channel, hold down the [UTIL] button in the cross-point control block, and carry out the following operation.
 - If the selected DME is channel 4, turn on the [KEY4] button in the key 2 row, then select the signal in the key 4 row (DME utility 2 bus).
 - If the selected DME is channel 8, turn off the [KEY4] button in the key 2 row, then select the signal in the key 2 row (DME utility 1 bus).

When using the SDI interface

The operations to select the video signals for the third and fourth channels differ from those in the previous procedure: select the video signals on the AUX bus allocated in a Setup menu (Engineering Setup >Switcher >Device Interface >DME Type Setting >DME SDI Interface menu).

Note

In setup (Engineering Setup >Switcher >Device Interface menu), if “Up to 3Keys” is selected, the second channel video signal is also selected on the AUX bus.

For details, see “Interfacing With External Devices (Device Interface Menu)” in Chapter 16 (Volume 2).

You can check the DME operating status in the Status menu (*see page 556*).



Assigning a DME output signal as a monitor signal

- 1** In the Processed Key menu, press [Monitor].
The Monitor menu appears.
- 2** Press [Monitor Set], turning it on.
- 3** In the <DME Select> group, select the DME channel (DME1 to DME8) to be used.

This assigns the selected DME output to DME MON V and DME MON K. The colors with which [DME1] to [DME8] are lit show the key assignment status.

Lit green: DME currently being monitored

Lit amber: DME that can be monitored

Off: Unassigned DME

Specifying the Key Output Destination

Using the key processed keyer signals (external processed key)

To select the key processed keyer key fill and key source signals on the AUX buses, press [Ext Proc Key], turning it on, in the Processed Key menu.

This assigns the key fill and key source signals for M/E-1 key 1 to reentry signals PROC V and PROC K.

Note

You cannot select the PROC V and PROC K signals using the cross-point selection buttons of the M/E or PGM/PST bank.

Using the key processed keyer signals or signals to which a DME effect is applied in frame memory (frame memory feed)

To use the key processed keyer key fill and key source signals on the frame memory source buses, in the Processed Key menu, press [FM Feed]. [Ext Proc Key] turns on, and the key fill and key source signals processed on the currently selected keyer are automatically assigned to frame memory source buses 1 and 2. When a DME is selected on the keyer, the key fill and key source signals to which a DME effect is applied are assigned.

Key Modify Clear

Press [Default Recall] at the lower left of the menu display, turning it on, then press the corresponding VF button (VF1 to VF4) to return the key settings to their initial status.

For details of menu operations, see “Menu Operations” (page 323).

Blink Function

With the blink function, you can obtain the following effects.

Key blink: The key is alternately inserted and deleted at regular intervals. You can set the period of blinking, and the proportion of each cycle for which the key is inserted.

Edge blink: The key fill and key edge fill signals are interchanged at regular intervals. You can set the period of blinking, and the proportion of each cycle for which the original state holds.

Using the blink function

For example, to make the required settings for key 1 on the M/E-1 bank, use the following procedure.

- 1** In the M/E-1 >Key1 menu, select HF6 ‘Transition.’
The Transition menu appears.
- 2** In the <Blink> group, select [Key Blink] or [Edge Blink] to set it on.
- 3** Set the blink parameters.

- **When key blink is selected**

Knob	Parameter	Adjustment	Setting values
1	Blink Rate	Length of blink cycle	1 to 100
2	Duty	Proportion of cycle for which key inserted	0.00 to 100.00

- **When edge blink is selected**

Knob	Parameter	Adjustment	Setting values
1	Blink Rate	Length of blink cycle	1 to 100
2	Duty	Proportion of cycle for which original state holds	0.00 to 100.00



Video Processing

You can adjust the luminance and hue of the selected key fill signal. For example, to apply video processing to the signal selected on the M/E-1 bank key 1 fill bus, use the following procedure.

- 1** In the M/E-1 >Key1 menu, select HF7 'Video Process.'
The Video Process menu appears.
- 2** Press [Video Process], turning it on.
- 3** Adjust the following parameters.

Knob	Parameter	Adjustment	Setting values
1	Video Gain	Video gain	-200.00 to +200.00
2	Y Gain	Luminance gain	-200.00 to +200.00
3	C Gain	Chrominance gain	-200.00 to +200.00
4	Hue Delay	Hue delay	-180.00 to +180.00
5	Black Level	Luminance black level	-7.31 to +109.59

To return adjustment values to their defaults

Press [Unity].

Key Setting Operations With the Key Control Block

This section describes the basic procedures for key settings using the key control block.

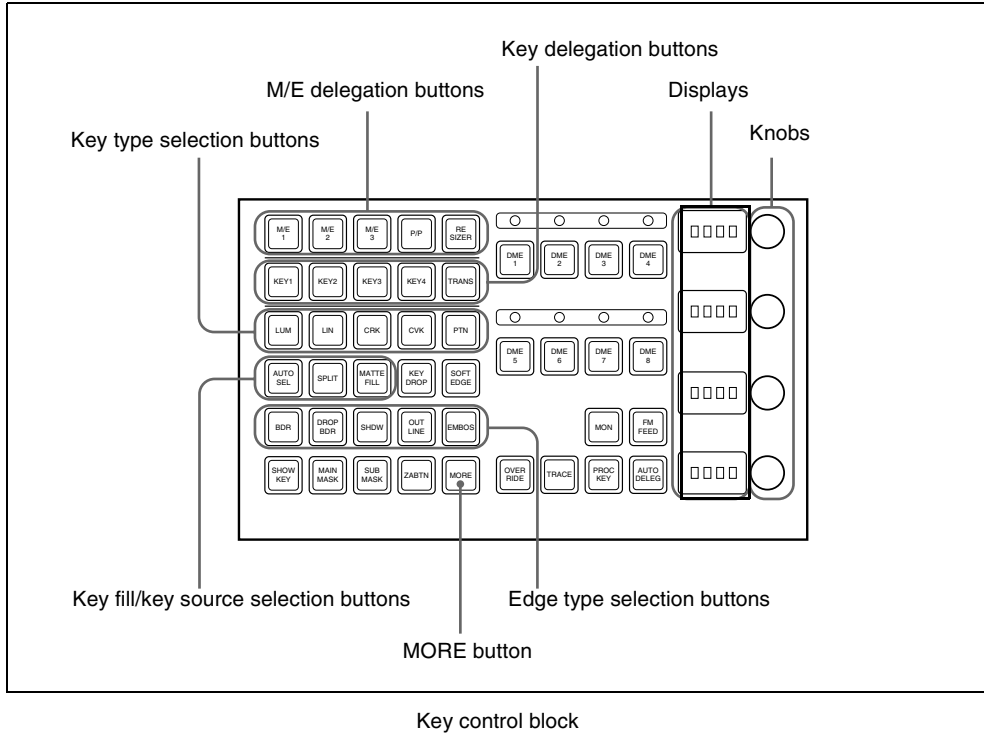

Operations in the Key Control Block

Parameter adjustment with the knobs

When the button for a function requiring parameter settings is pressed (that is, on), you can set the parameters with the four knobs. If there are more than four values to be assigned to the knobs, the [MORE] button lights amber. At this point, press the [MORE] button, which turns green, to assign the fifth and subsequent parameters to the knobs, so that the parameter settings can be made.

Selecting the bank and keyer

To make key settings, first select the bank (from M/E-1 to M/E-3 and PGM/PST) and keyer, then assign them to the key control block.

For example, to set key 1 on M/E-1 with the key control block, use the following procedure.

- 1 Using the M/E delegation buttons in the key control block, press the [M/E1] button, setting it on.
- 2 Using the key delegation buttons in the key control block, press the [KEY1] button, setting it on.

This assigns the key control block to M/E-1 key 1.

Selecting the key type

To select the key type, press one of the key type selection buttons in the key control block.

[LUM] button: luminance key

[LIN] button: linear key

[CRK] button: chroma key

[CVK] button: color vector key

[PTN] button: key wipe pattern key

When using a wipe pattern key as the key type, in the <Key Type> group of the Type menu for the keyer, select [Wipe Pattern] and make the settings.

For an overview of the key types, see page 48.

The button you pressed lights green, and you can now adjust the parameters with the knobs. The display beside each knob shows the first letter of the parameter name and the three-digit setting value.

• When the [LUM] or [LIN] button is lit green

Knob	Parameter	Adjustment	Setting values
1	Clip	Reference level for generating the key signal	+109 to -7
2	Gain	Key sensitivity	-100 (shown as -00) to +100
3	Density	Key density	0 to 100
4	Filter	Filter coefficient	1 to 9

• When the [CRK] button is lit green

Knob	Parameter	Adjustment	Setting values
1	Clip	Chroma key reference level	0 to 100
2	Gain	Key sensitivity	-100 (shown as -00) to +100
3	Hue	Hue	0 to 359
4	Density	Key density	0 to 100

- When [Key Active] is off, only the parameters Hue and Density are displayed.
- When both [Key Active] and [Color Cancel] are off, only the parameter Density is displayed.

- **When the [CVK] button is lit green**

Parameter group [1/2]

Knob	Parameter	Adjustment	Setting values
1	Y Clip	Reference level for Y signal	+109 to -7
2	Y Gain	Y signal sensitivity	-100 (shown as -00) to +100
3	C Clip	Reference level for chrominance signal	100 to 0
4	C Gain	Chrominance signal sensitivity	-100 (shown as -00) to +100

Parameter group [2/2]

Knob	Parameter	Adjustment	Setting values
1	Y Filter	Y signal filter coefficient	1 to 9
2	C Filter	Chrominance signal filter coefficient	1 to 9
4	Density	Key density	0 to 100

- **When the [PTN] button is lit green**

Knob	Parameter	Adjustment	Setting values
1	Size	Pattern size	0 to 100
2	Soft	Edge softness	0 to 100
3	Density	Key density	0 to 100

Selecting key fill

Select whether to use a color matte as key fill, or the signal on the key fill bus.

When using a color matte: Press the [MATTE FILL] button, setting it on. The button lights green, and you can now set the parameters with the knobs.

Knob	Parameter	Adjustment	Setting values
1	Luminance	Color 1 luminance	0 to 100
2	Saturation	Color 1 saturation	0 to 100
3	Hue	Color 1 hue	359 to 0

When [Mix Color] is selected in the key fill Matte Adjust menu, you can further adjust color 2.

When [Mix Color] is on, and the [MORE] button is lit amber

Knob	Parameter	Adjustment	Setting values
1	Luminance	Color 1 luminance	0 to 100
2	Saturation	Color 1 saturation	0 to 100
3	Hue	Color 1 hue	359 to 0
4	Size	Pattern size	0 to 100

When [Mix Color] is on, and the [MORE] button is lit green

Knob	Parameter	Adjustment	Setting values
1	Luminance	Color 2 luminance	0 to 100
2	Saturation	Color 2 saturation	0 to 100
3	Hue	Color 2 hue	359 to 0
4	Soft	Edge softness	0 to 100

When using the key fill bus signal: Press the [MATTE FILL] button, turning it off.

To select the key fill signal, use the key 1 or key 2 bus buttons in the cross-point control block.

To select the key fill signal for key 3 or key 4 in the cross-point control block, press the [KEY3] button or [KEY4] button to the right of the key bus buttons, turning it on, to allocate the key 1 bus row or key 2 bus row to the key 3 fill bus or key 4 fill bus, then press the desired cross-point button.

Selecting key source

- To use the key source paired with the key fill signal selected on the key fill bus, press the [AUTO SEL] button, turning it on. The pairing of the cross-point buttons for key fill and key source is carried out in the Setup menu. (See “Cross-Point Settings (Xpt Assign Menu)” in Chapter 16 (Volume 2).)
- To select key source independently of the key fill signal selected on the key fill bus and paired with key source, hold down the [SPLIT] button, turning it on, then press the desired Key 1 or Key 2 button in the cross-point control block.

- To use as key source the same signal as the key fill signal selected on the key fill bus, select the SELF mode by pressing the [AUTO SEL] button and [SPLIT] button simultaneously so that both are off. When chroma key is selected as the key type, select the SELF mode.

Key Edge Modifications

To apply a modification to the key edge, press one of the edge type selection buttons in the key control block.

[BDR] button: border

[DROP BDR] button: drop border

[SHDW] button: shadow

[OUTLINE] button: outline

[EMBOS] button: emboss

For an overview of the edge modifications, see page 52.

The pressed button lights green, and you can now adjust the parameters with the knobs. The display beside each knob shows the first letter of the parameter name and the three-digit setting value.

Setting the border parameters

When the [BDR] button is lit green, the parameter settings depend on the key type and whether the separate edge function is active. To activate the separate edge function, press [Separate Edge], setting it on, in the Edge menu for the key.

- **Separate edge off**

Knob	Parameter	Adjustment	Setting values
1	Width	Border width	0 to 8 ^{a)} (0 to 100) ^{b)}
4	Density	Border density	0 to 100

a) In the “4H mode” and when [Fine Key] (page 393) is on, the setting value range is 0 to 4.

b) When a wipe pattern key or key wipe pattern key is selected as the key type

- **Separate edge on**

The border width settings can be made independently for left, right, top, and bottom sides. The separate edge function is only available when luminance key, linear key, or chroma key is selected as the key type.

Knob	Parameter	Adjustment	Setting values
1	Top	Top edge width	0 to 8 ^{a)}
2	Left	Left edge width	0 to 8 ^{a)}
3	Right	Right edge width	0 to 8 ^{a)}
4	Bottom	Bottom edge width	0 to 8 ^{a)}

a) In the “4H mode” and when [Fine Key] (page 393) is on, the setting value range is 0 to 4.

To adjust the edge fill color

When [BDR] is selected, the [MORE] button lights amber. Pressing the [MORE] button to turn it green then allows you to adjust the edge fill color parameters with the knobs.

Knob	Parameter	Adjustment	Setting values
1	Luminance	Luminance	0 to 100
2	Saturation	Saturation	0 to 100
3	Hue	Hue	359 to 0
4	Density	Density	0 to 100

Setting the drop border or shadow parameters

When the [DROP BDR] or [SHDW] button is lit green, the parameter settings differ between the “key drop OFF” and “key drop ON” modes (*see page 54*) as shown below. Switching between these two modes is made by turning the [KEY DROP] button on or off.

• “Key drop OFF” mode

Knob	Parameter	Adjustment	Setting values
1	Width	Width	0 to 8 ^{a)}
2	Position	Position	359 to 180
4	Density	Density	0 to 100

a) In the “4H mode” and when [Fine Key] (page 393) is on, the setting value range is 0 to 4.

• “Key drop ON” mode

Knob	Parameter	Adjustment	Setting values
1	Width	Width	0 to 8 ^{a)}
2	Position	Position	359 to 0
4	Density	Density	0 to 100

a) In the “4H mode” and when [Fine Key] (page 393) is on, the setting value range is 0 to 4.

To adjust the edge fill color

When [DROP BDR] or [SHDW] is selected, the [MORE] button lights amber. Pressing the [MORE] button to turn it green then allows you to adjust the edge fill color parameters with the knobs.

Knob	Parameter	Adjustment	Setting values
1	Luminance	Luminance	0 to 100
2	Saturation	Saturation	0 to 100
3	Hue	Hue	359 to 0
4	Density	Density	0 to 100

Setting the outline parameters

When the [OUTLINE] button is lit green, the parameter settings depend on the key type and whether the separate edge function is active. To activate the separate edge function, press [Separate Edge], setting it on, in the Edge menu for the key.

• Separate edge off

Knob	Parameter	Adjustment	Setting values
1	Width	Outline width	0 to 8 ^{a)} (0 to 100) ^{b)}
4	Density	Outline density	0 to 100

a) In the “4H mode” and when [Fine Key] (page 393) is on, the setting value range is 0 to 4.

b) When a wipe pattern key or key wipe pattern key is selected as the key type

• Separate edge on

The outline width settings can be made independently for left, right, top, and bottom sides. The separate edge function is only available when luminance key, linear key, or chroma key is selected as the key type.

Knob	Parameter	Adjustment	Setting values
1	Top	Top edge width	0 to 8 ^{a)}
2	Left	Left edge width	0 to 8 ^{a)}
3	Right	Right edge width	0 to 8 ^{a)}
4	Bottom	Bottom edge width	0 to 8 ^{a)}

a) In the “4H mode” and when [Fine Key] (page 393) is on, the setting value range is 0 to 4.

When [Outline] is selected with separate edge on, the [MORE] button lights amber. Pressing the [MORE] button to turn it green then allows you to adjust the key fill density parameter with a knob.



Knob	Parameter	Adjustment	Setting values
4	Density	Outline density	0 to 100

Setting the embossing parameters

When the [EMBOS] button is lit green, adjust the following parameters.

Knob	Parameter	Setting values
1	Width	0 to 4
2	Position	359 to 0
4	Density	0 to 100

Selecting a normal edge

When all five edge type selection buttons are off, a normal edge is selected. If one of the buttons is lit, press it, turning it off.

Softening the edge

Press the [SOFT EDGE] button, turning it on. The button lights green, and you can now adjust the softness with the knob.

Knob	Parameter	Adjustment	Setting values
1	Soft	Edge softness	0 to 100

- For a normal edge, when [SOFT EDGE] is enabled, “Key Drop” mode turns on.
- When a luminance key or linear key is selected as the key type, and clean mode is enabled, enabling [SOFT EDGE] ends the clean mode.

Applying the zabton effects

When the [ZABTN] button is lit green, adjust the following parameters.

Knob	Parameter	Adjustment	Setting values
1	Size	Pattern size	0 to 100
2	Soft	Pattern edge softness	0 to 100

Press the [MORE] button lit amber, changing it to green, then adjust the following parameters.

Knob	Parameter	Adjustment	Setting values
1	Luminance	Luminance	0 to 100
2	Saturation	Saturation	0 to 100

Knob	Parameter	Adjustment	Setting values
3	Hue	Hue	359 to 0
4	Density	Density	0 to 100

Masks

Using the main mask

In the key control block, press the [MAIN MASK] button, turning it on. The parameter settings depend on the mask source selected as [Box] or [Pattern] in the <Mask Source> group of the Main Mask menu for the key.

- **When box is selected**

Knob	Parameter	Adjustment	Setting values
1	Top	Top position	-100 (shown as -00) to +100
2	Left	Left position	-100 (shown as -00) to +100
3	Right	Right position	-100 (shown as -00) to +100
4	Bottom	Bottom position	-100 (shown as -00) to +100

When box is selected and the [MORE] button is lit amber, there are more settings. Press the [MORE] button, so that it changes from amber to green to make the extra setting.

Knob	Parameter	Adjustment	Setting values
1	Soft	Box softness	0 to 100

- **When pattern is selected**

Knob	Parameter	Adjustment	Setting values
1	Size	Pattern size	0 to 100
2	Soft	Edge softness	0 to 100
3	Pattern	Pattern number	1 to 24 ^{a)}

a) The pattern is the same as a standard wipe. (See “Wipe Pattern List” in Appendix (Volume 1) (page 560).)

Using the subsidiary mask

In the key control block, press the [SUB MASK] button, turning it on. The parameter settings depend on the mask source selected as [Wipe] or [Utility 1 Bus] in the <Mask Source> group of the Sub Mask menu for the key.

- **When wipe is selected**

Knob	Parameter	Adjustment	Setting values
1	Size	Pattern size	0 to 100
2	Soft	Edge softness	0 to 100

- **When utility 1 bus is selected**

Knob	Parameter	Adjustment	Setting values
1	Clip	Reference level for creating mask signal	+109 to -7
2	Gain	Gain	-100 (shown as -00) to +100

Applying a DME Effect to a Key

Note

For one M/E bank, DME effects (including DME wipes) can be used in up to two places on the dedicated interface and in only one place on the SDI interface simultaneously.

When combining the SDI interface with the dedicated interface, you can apply DME effects to a maximum of three keys. (Requires a setting in setup.)

Assigning a DME to a key

- 1** In the key control block, press the delegation buttons [M/E1] and [KEY1].
- 2** Using the DME channel selection buttons, select the DME channel (DME1 to DME8) for applying the effect.

The lit colors of the [DME1] to [DME8] buttons indicate the DME assignment.

Lit green: Shows the DME assigned to the currently selected key.

Lit amber: Shows the DME assigned to a key other than the currently selected key.

Off: DME is not assigned.

To select a DME being used by another keyer

Press [Override], turning it on, then select the DME channel.

The later selection is valid, and the button lights green.

Using two or three DME channels on one keyer

When using the DME dedicated interface, proceed as follows.

- 1** Select the DME for the first channel (*see the previous item, “Assigning a DME to a key”*), then select the successive channel for the second channel. For the third channel select the channel after that.
- 2** To select the video signal for the second channel, hold down the [UTIL] button in the cross-point control block, and select the signal in the Key1 row (DME external video bus).
- 3** To select the video signal for the third channel, hold down the [UTIL] button in the cross-point control block, and carry out the following operation.
 - If the selected DME is channel 3 or channel 4, turn off the [KEY4] button in the key 2 row, then select the signal in the key 2 row (DME utility 1 bus).
 - If the selected DME is channel 7 or channel 8, turn on the [KEY4] button in the key 2 row, then select the signal in the key 4 row (DME utility 2 bus).

Using four DME channels on one keyer

When using the DME dedicated interface, proceed as follows.

- 1** Select the DME channel 1 (or channel 5) for the first channel (*see “Assigning a DME to a key” (page 415)*). In the same way, select the DME channel 2 (channel 6) for the second channel, the DME channel 3 (channel 7) for the third channel, and the DME channel 4 (channel 8) for the fourth channel.
- 2** To select the video signal for the second channel, hold down the [UTIL] button in the cross-point control block, and select the signal in the Key1 row (DME external video bus).
- 3** To select the video signal for the third channel, hold down the [UTIL] button in the cross-point control block, and carry out the following operation.
 - If the selected DME is channel 3, turn off the [KEY4] button in the key 2 row, then select the signal in the key 2 row (DME utility 1 bus).
 - If the selected DME is channel 7, turn on the [KEY4] button in the key 2 row, then select the signal in the key 4 row (DME utility 2 bus).
- 4** To select the video signal for the fourth channel, hold down the [UTIL] button in the cross-point control block, and carry out the following operation.
 - If the selected DME is channel 4, turn on the [KEY4] button in the key 2 row, then select the signal in the key 4 row (DME utility 2 bus).



- If the selected DME is channel 8, turn off the [KEY4] button in the key 2 row, then select the signal in the key 2 row (DME utility 1 bus).

When using the SDI interface

The operations to select the video signals for the third and fourth channels differ from those in the previous procedure: select the video signals on the AUX bus allocated in a Setup menu (Engineering Setup >Switcher >Device Interface >DME Setting >DME SDI Interface menu).

Note

When using a second key in combination with a dedicated interface, select the signal to be used on the AUX bus.

You can check the DME operating status in the Status menu (*see page 556*).

Assigning the DME output signal to a monitor signal

- 1 Holding down the output destination specification button [MON] in the key control block, use the DME channel selection buttons to select the DME channel (DME1 to DME8) you want to use.

The selected DME output is assigned to DME MON V and DME MON K.

- 2 To check the DME assignment status, hold down just the [MON] button.

While it is held down, the lit color of the [DME1] to [DME8] buttons shows the key assignment status.

Lit green: Shows the DME currently being monitored.

Lit amber: Shows a DME which can be monitored.

Off: DME is not assigned.

Other Key Setting Operations

Using an external processed key

You can select and use the key processed keyer key fill and key source signals on the AUX buses.

- 1 Select the keyer to be allocated.
- 2 In the key control block, press [PROC KEY], turning it on.

The button lights amber, and on the currently selected keyer, the key fill and key source are assigned to reentry signals PROC V and PROC K.

Note

You cannot select the PROC V and PROC K signals using the cross-point selection buttons of the M/E or PGM/PST bank.

Using a frame memory feed

When you press the [FM FEED] button in the key control block, it lights momentarily amber, then the key fill and key source signals processed in the currently selected keyer are assigned to frame memory sources 1 and 2.

If a DME is selected on the currently selected keyer, then the key fill and key source signals to which a DME effect is applied are assigned to frame memory sources 1 and 2.

Carrying out a frame memory feed causes the [PROC KEY] button to light amber.

Using the show key function

While the [SHOW KEY] button is held down, the key-processed key source signal appears on the specified output. (Show key mode)

Even when the [SHOW KEY] button is released, for a preset time the show key mode is maintained. You can specify the output to which the show key function is applied and set the time for which the show key mode is maintained after releasing the button in a Setup menu.

For details see “Settings Relating to Keys, Wipes and Frame Memory (Key/Wipe/FM Menu)” in Chapter 16 (Volume 2).

Using the auto delegation function

To couple the selection in the key delegation buttons of the independent key transition control block so that the key control block delegation selection is automatically switched, in the key control block press the [AUTO DELEG] button, turning it on.

Returning the key adjustment values to their defaults

Holding down a key type button ([LUM], [LIN], [CRK], [CVK], or [PTN]) recalls the key default values (*page 57*).

Key modify clear

When an M/E delegation button is held down, holding down a key delegation button together returns the key settings to the initial status settings.

For details of the initial status, see “Selecting the State After Powering On (Start Up Menu)” in Chapter 16 (Volume 2).



Resizer

Resizer allows you to apply DME-like effects such as image shrinking, magnification and movement, as well as change of the aspect ratio, to the processed key.

Notes

- The resizer function is supported on the MVS-8000G only.
- The image of the key manipulated by resizer has a one-frame delay.

Two-Dimensional Transformations of Keys

Note

When the screen aspect ratio is 4:3 in HD format, when the resizer is used to shrink a video image, this is applied to the 16:9 screen including the added video on the left and right sides. Use the crop function as required to extract the 4:3 image.

Menu operations for key shrinking, magnification and movement

For example, to shrink, magnify or move key1 of the M/E-1 bank, use the following procedure.

- 1 In the M/E-1 >Key1 >Processed Key menu, press [Resizer], turning it on.
- 2 Adjust the following parameters with the knobs.

Parameter group [1/2]

Knob	Parameter	Adjustment	Setting values	
1	Location X	Move key horizontally	HD	-99.9999 to +99.9999
			SD 4:3	-33.3333 to +33.3333
			SD 16:9	-24.9999 to +24.9999

Parameter group [1/2]

Knob	Parameter	Adjustment	Setting values	
2	Location Y	Move key vertically	HD	-99.9999 to +99.9999
			SD 4:3	-33.3333 to +33.3333
			SD 16:9	-24.9999 to +24.9999
3	Size	Magnify or shrink key	0.0000 to 99.9999	

Parameter group [2/2]

Knob	Parameter	Adjustment	Setting values	
1	Aspect X	Change aspect ratio horizontally	0.0000 to 99.9999	
2	Aspect Y	Change aspect ratio vertically	0.0000 to 99.9999	
3	Aspect Ratio	Change aspect ratio horizontally and vertically at a time	0.0000 to 2.0000	



Key control block operations for key shrinking, magnification and movement

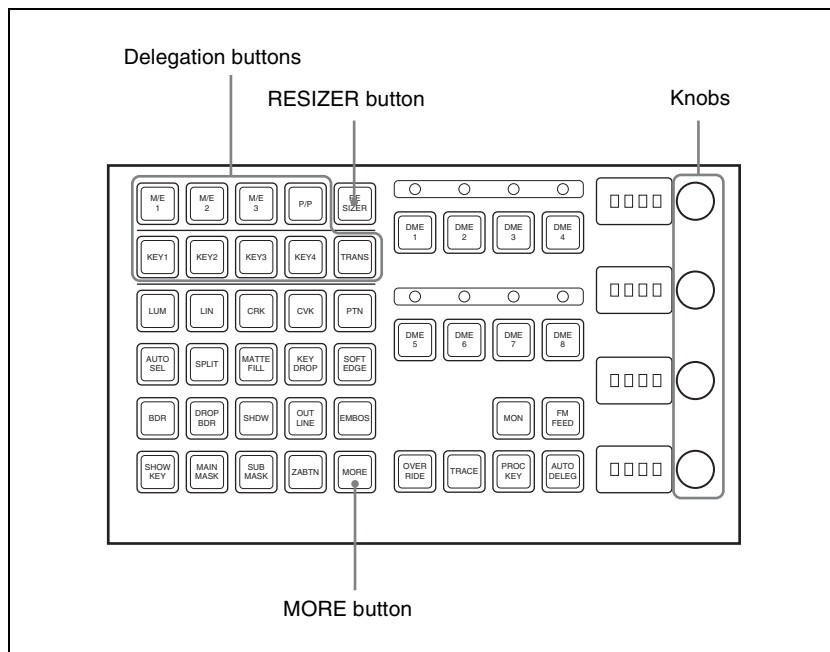

- 1 Use the delegation buttons to select the key to which you want to apply a resizer function.
- 2 Press the [RESIZER] button, turning it on.
- 3 Adjust the following parameters with the knobs.
(To switch between displaying parameter group 1/2 and 2/2, press the [MORE] button.)

Parameter group [1/2]

Knob	Parameter	Adjustment	Setting values	
1	X	Move key horizontally	HD	-99 to +99
			SD 4:3	-33 to +33
			SD 16:9	-24 to +24
2	Y	Move key vertically	HD	-99 to +99
			SD 4:3	-33 to +33
			SD 16:9	-24 to +24

Parameter group [1/2]

Knob	Parameter	Adjustment	Setting values
3	S	Magnify or shrink key	0.0 to 99

Parameter group [2/2]

Knob	Parameter	Adjustment	Setting values
1	X	Change aspect ratio horizontally	0.0 to 99
2	Y	Change aspect ratio vertically	0.0 to 99
3	R	Change aspect ratio horizontally and vertically at a time	0.0 to 2.0

Device control block operations for key shrinking, magnification and movement

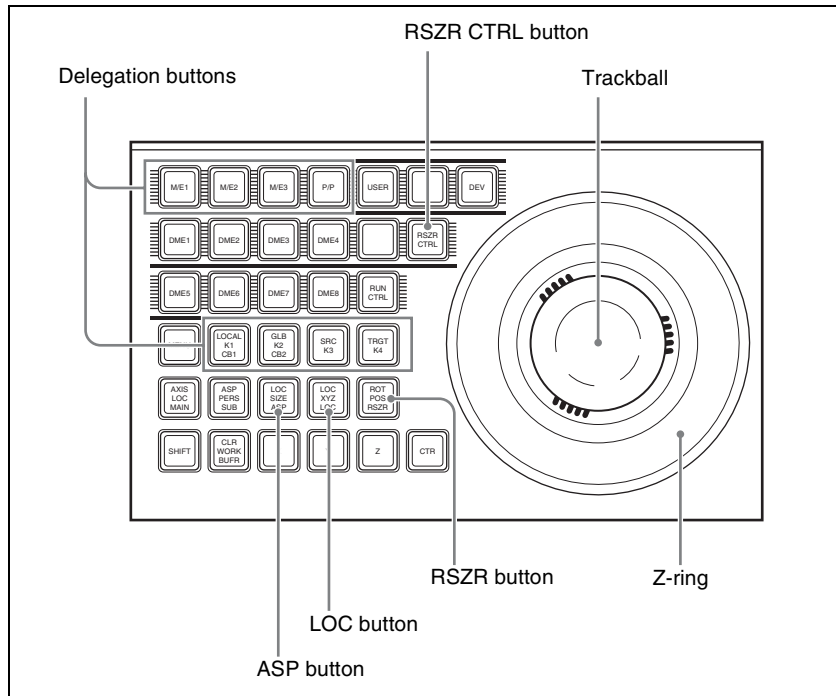

- 1 Press the [RSZR CTRL] button, turning it on.

- 2** Press the delegation button to select the key.
- 3** Press the [RSZR] button, turning it on.
- 4**
 - To change the aspect ratio, turn on the [LOC SIZE(ASP)].
 - To shrink, magnify, or move the key , turn on the [LOC XYZ(LOC)].Hold these buttons down while carrying out the operation of step **5** to enable fine adjustment (fine mode).
- 5** Use the trackball and joystick for the operation.

*For details of parameters, see step **3** of “Key control block operations for key shrinking, magnification and movement” (page 421).*

*For details of parameters, see step **3** of “Key control block operations for key shrinking, magnification and movement” (page 421).*

Entering parameters

This operation is the same as DME three-dimensional parameter input.

For details, see “Entering Three-Dimensional Parameter Values” in Chapter 11 (Volume 2).

Resetting parameters

This operation is the same as DME three-dimensional parameter resetting.

For details, see “Entering Three-Dimensional Parameter Values” in Chapter 11 (Volume 2).

Clearing resizer effects

To clear two-dimensional transform parameters only and set the initial state

In the device control block, press the [CLR WORK BUFR] button in the operation buttons.

To clear all resizer parameters, and set the initial state

In the device control block, press the [CLR WORK BUFR] button in the operation buttons, twice in rapid succession.

For the initial state, you can select either the factory default settings or user settings.

For details of how to make this selection, see “Selecting the State After Powering On (Start Up Menu)” in Chapter 16 (Volume 2).

Resizer Interpolation Settings

For example, to make the interpolation settings for key 1 of the M/E-1 bank, use the following procedure.

- 1** In the M/E-1 >Key1 >Processed Key menu, press [Resizer], turning it on.
This enables the resizer function.
- 2** Press [Resizer Process].
The Resizer Process menu appears.
- 3** In the <Video Field/Frame Mode> and other groups, make the interpolation settings.

These settings are the same as those for input video signals. For details, see “Interpolation Settings” in Chapter 11 (Volume 2).

Resizer Crop/Border Settings

Making a crop setting for a key for which resizer is on

For example, to make the crop settings for key 1 of the M/E-1 bank, use the following procedure.

- 1** In the M/E-1 >Key1 >Processed Key menu, press [Resizer], turning it on.
This enables the resizer function.
- 2** Press [Border/Crop].
The Border/Crop menu appears.
- 3** Press [Crop], turning it on.
This enables the adjustment of crop.
- 4** Set the parameters.

These settings are the same as those for crop of DME. For details, see “Crop Settings” in Chapter 11 (Volume 2).



Note

If mosaic or defocus is enabled, and in the <Mosaic/Defocus Mode> group you select Video/Key, then the crop is disabled.

Applying a border to a key for which resizer is on

- 1 In the M/E-1 >Key1 >Processed Key menu, press [Resizer], turning it on.

This enables the resizer function.

- 2 Press [Border/Crop].

The Border/Crop menu appears.

- 3 Press [Boreder], turning it on.

This enables the adjustment of crop.

- 4 Set the parameters.

The valid ranges of the parameter values depend on the combination of signal format (SD/HD) and aspect ratio (4:3/16:9) selected in the system, as follows.

- **SD format**

Knob	Parameter	Adjustment Setting	Values
1	H	Simultaneously adjust width of left and right borders	0.00 to 4.00
2	V	Simultaneously adjust width of top and bottom borders	0.00 to 3.00 (4:3) 0.00 to 2.25 (16:9)
3	All	Simultaneously adjust width of all four borders	Value of H shown
5	Density	Density of the borders	0.00 to 100.00

- **HD format**

Knob	Parameter	Adjustment Setting	Values
1	H	Simultaneously adjust width of left and right borders	0.00 to 12.00 (4:3) 0.00 to 16.00 (16:9)
2	V	Simultaneously adjust width of top and bottom borders	0.00 to 9.00
3	All	Simultaneously adjust width of all four borders	Value of H shown
5	Density	Density of the borders	0.00 to 100.00

To apply color to a border

- 1 In the <Border Mode> group of the Border/Crop menu, press [Flat Color].
- 2 Adjust the following parameters.

Knob	Parameter	Adjustment Setting	Values
1	Luminance	Luminance	0.00 to 100.00
2	Saturation	Saturation	0.00 to 100.00
3	Hue	Hue	359.99 to 0.00

To soften the inner edge of a border

- 1 In the Border/Crop menu, press [Border Soft].
- 2 Adjust the following parameters.

Knob	Parameter	Adjustment Setting	Values
1	Inner Soft	Border inner softness	0.00 to 100.00

To apply a beveled light edge

- 1 In the <Border Mode> group of the Border/Crop menu, press [Beveled Light Edge].
- 2 Adjust the following parameters.

Knob	Parameter	Adjustment Setting	Values
1	Top	Top edge	-100.00 to +100.00
2	Left	Left edge	-100.00 to +100.00
3	Right	Right edge	-100.00 to +100.00
4	Bottom	Bottom edge	-100.00 to +100.00
5	All	Four edges	Value of Left shown

- 3 Press [Border Soft].
- 4 Adjust the following parameters.

Knob	Parameter	Adjustment Setting	Values
1	Inner Soft	Border inner softness	0.00 to 100.00
2	Bound Soft	Border boundary softness	0.00 to 100.00



To apply a beveled color edge

- 1 In the <Border Mode> group of the Border/Crop menu, press [Beveled Color Edge].
- 2 In the <Color Adjust> group, select the edges for adjustment among the [Top], [Left], [Right], and [Bottom] edges. To select all the four edges, press [All].
- 3 Set the color parameters.
For details, see “To apply color to a border” (page 426)
- 4 Press [Border Soft].
- 5 Adjust the following parameters.

Knob	Parameter	Adjustment	Setting values
1	Inner Soft	Border inner softness	0.00 to 100.00
2	Bound Soft	Border boundary softness	0.00 to 100.00

Applying Resizer Effects

For example, to apply effects to key 1 of the M/E-1 bank, use the following procedure.

- 1 In the M/E-1 >Key1 >Processed Key menu, press [Resizer], turning it on. This enables the resizer function.
- 2 Press [Enhanced Effect].
The Enhanced Effect menu appears.

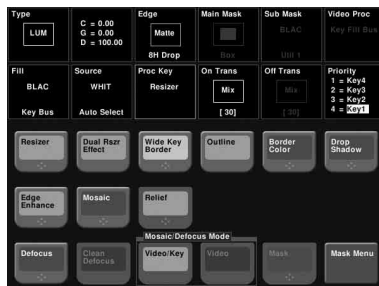

Applying a wide key border

- 1 In the M/E-1 >Key1 >Processed Key >Enhanced Effect menu, press [Dual Rszr Effect], turning it on.
- 2 Press [Wide Key Border], turning it on.
- 3 Adjust the following parameters.

Knob	Parameter	Adjustment	Setting values
1	H	Simultaneously adjust border width of left and right edges	0.00 to +100.00
2	V	Simultaneously adjust border width of upper and lower edges	0.00 to +100.00
3	All	Simultaneously adjust border width of all four edges	Value of H shown
4	Soft ^{a)}	Softness of border	0.00 to +100.00
5	Density	Density of border	0.00 to +100.00

a) Shared with the drop shadow “Soft” value.

- 4 To add an outline, press [Out Line], turning it on.
- 5 To adjust the border color, press [Border Color].
- 6 Set the color parameters.

For details, see “To apply color to a border” (page 426)

Applying a drop shadow

- 1 In the M/E-1 >Key1 >Processed Key >Enhanced Effect menu, press [Dual Rszr Effect], turning it on.
- 2 Press [Drop Shadow], turning it on.
- 3 Set the parameters.

The valid ranges of the parameter values depend on the combination of signal format (SD/HD) and aspect ratio (4:3/16:9) selected in the system, as follows.

- **SD format**



Knob	Parameter	Adjustment	Setting values
1	H	Horizontal position of shadow	-8.00 to +8.00
2	V	Vertical position of shadow	-6.00 to +6.00 (4:3) -4.50 to +4.50 (16:9)
3	Size	Shadow size	0.00 to 2.00
4	Soft ^{a)}	Softness of shadow	0.00 to 100.00
5	Density	Density of shadow	0.00 to 100.00

a) Shared with the wide key border “Soft” value.

• HD format

Knob	Parameter	Adjustment	Setting values
1	H	Horizontal position of shadow	-24.00 to +24.00 (4:3)-32.00 to +32.00 (16:9)
2	V	Vertical position of shadow	-18.00 to +18.00
3	Size	Shadow size	0.00 to 2.00
4	Soft ^{a)}	Softness of shadow	0.00 to 100.00
5	Density	Density of shadow	0.00 to 100.00

a) Shared with the wide key border “Soft” value.

Edge enhancement

Adjusting the gain sharpens the image.

- 1** In the M/E-1 >Key1 >Processed Key >Enhanced Effect menu, press [Edge Enhance], turning it on.
- 2** Adjust the following parameters.

Knob	Parameter	Adjustment	Setting values
1	H	Horizontal gain adjustment	0.00 to 100.00
2	V	Vertical gain adjustment	0.00 to 100.00
3	All	Both horizontal and vertical adjustment	H value is displayed

Applying a mosaic

- 1** In the M/E-1 >Key1 >Processed Key >Enhanced Effect menu, press [Mosaic], turning it on.

- 2 Set the parameters.

This operation is the same as the DME mosaic setting. For more details, see “Mosaic Settings” in Chapter 11 (Volume 2).

- 3 In the <Mosaic/Defocus Mode> group, select the signal to which to apply the mosaic effect.

Video/Key: Video signal and key signal

Video: Video signal only

Note

If mosaic is enabled, and in the <Mosaic/Defocus Mode> group you select Video/Key, then the crop and mask are disabled.

- 4 Set the parameters.

Knob	Parameter	Adjustment	Setting values
1	H	Horizontal defocusing	0.00 to 100.00
2	V	Vertical defocusing	0.00 to 100.00
3	All	Horizontal and vertical defocusing	H value shown

To make the mosaic like a relief pattern

- 1 With [Mosaic] on, press [Relief], turning it on.
- 2 In addition to the mosaic parameters, set the following parameters.

Knob	Parameter	Adjustment	Setting values
3	Gain	Relief depth of mosaic cells	0.00 to 100.00
4	Angle	Light source direction	-8.00 to +8.00

Defocusing

- 1 In the M/E-1 >Key1 >Processed Key >Enhanced Effect menu, press [Defocus], turning it on.

- 2 Set the parameters.

This operation is the same as the defocusing setting when using the DME with the DME dedicated interface. However, <Mosaic/Defocus Mode> appears in place of <Defocus Mode>. For more details, see “Defocus Settings” in Chapter 11 (Volume 2).

Note

If defocus is enabled, and in the <Mosaic/Defocus Mode> group you select Video/Key, then the crop and mask are disabled.

Applying a mask to mosaic or defocus

1 In the M/E-1 >Key1 >Processed Key >Enhanced Effect menu, press [Dual Rszr Effect], turning it on.

2 Press [Mask], turning it on.

This enables the mask function.

To make the mask settings, continue with steps **3** and following.

3 Press [Mask Menu].

The Mask menu appears.

4 In the <Mask Source> group, select either of [Box] and [Circle].

Box: Use a box pattern as the mask signal.

Circle: Use a circle pattern as the mask signal.

5 Set the parameters.

The valid ranges of the parameter values depend on the combination of signal format (SD/HD) and aspect ratio (4:3/16:9) selected in the system, as follows.

The parameters are the same as for drop shadow. For more details, see “Applying a drop shadow” (page 428), except that knobs 3 and 5 are as follows.

Knob	Parameter	Adjustment	Setting values
3	Size	Size	0.00 to 100.00
5	Aspect	Aspect ratio	-100.00 to +100.00

The rotation and inversion operations are the same as for a DME mask setting. For more details, see Chapter 11 “Mask Settings” (Volume 2).

Notes

- When a mask effect is applied to a border, the boundary becomes discontinuous, giving an unnatural effect. Avoid applying a mask to a border.
- If mosaic or defocus is enabled, and in the <Mosaic/Defocus Mode> group you select Video/Key, then the mask is disabled.

Restrictions on resizer effects

Restrictions on the use of effects

Of the resizer effects, using mask, drop shadow, or wide key border requires two units of hardware for the resizer function.

These are called “dual resizer effects”.

In a dual resizer effect, predetermined combinations, key 1 and key 2, or key 3 and key 4 are used.

For example, if either of key 1 and key 2 has resizer set to On, the other key cannot be used for a dual resizer effect.

The same restriction applies when using a resizer DME wipe in place of resizer.

Impossibility of simultaneous use within the same keyer

The following combinations of resizer effects cannot be simultaneously on.

- Mosaic and edge enhance
- Defocus and wide key border
- Mask and drop shadow
- Mask and wide key border



Key Snapshots

Using the key snapshot function, you can instantaneously save all of the key settings, except the key insertion state (on/off) and key priority, in dedicated registers for later recall as required.

For an overview of the key snapshots, see page 57.

Key Snapshot Operations

Key snapshot operations are carried out in the independent key transition control block or downstream key control block. Each keyer is provided with four dedicated key snapshot registers.

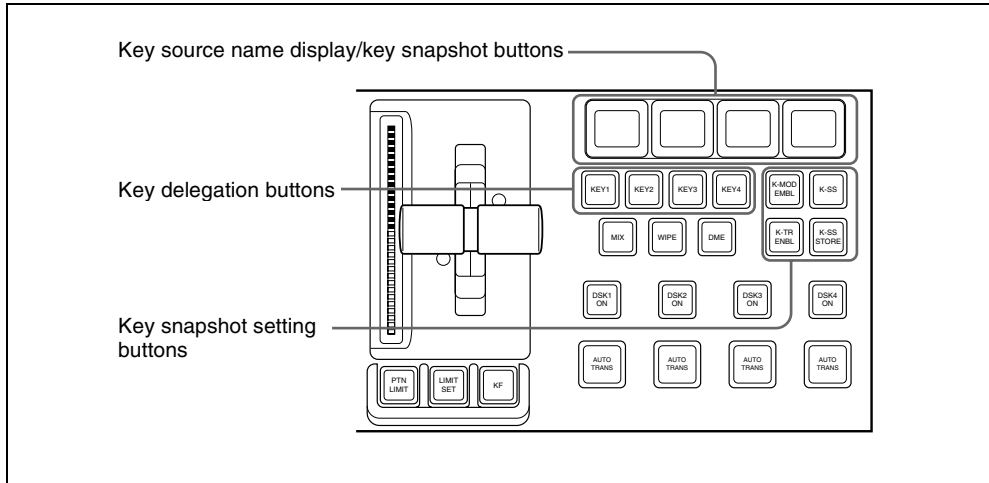

Independent key transition control block (standard type)

Saving a key snapshot

For example, the following procedure saves the state of the M/E-1 key 1 settings.

- 1** In the M/E-1 independent key transition control block, press the key delegation button [KEY1], turning it on.
- 2** Press the [K-SS] button, turning it on.

The system switches to key snapshot mode, and the key source name display/key snapshot buttons show the status of registers 1 to 4 for key 1.

Off: Nothing is saved in the register.

Lit orange: Settings are saved in the register.

For a register holding a snapshot, the register name is shown as up to eight characters.

- 3** Hold down the [K-SS STORE] button, and press the key source name display/key snapshot button corresponding to the register in which you want to save the snapshot.

The key source name display/key snapshot button which you pressed lights yellow.

Note

If you save a key snapshot in a register for which the button is lit orange or yellow, the existing contents of the register are overwritten.

Recalling a key snapshot

For example, the following procedure recalls the state of the M/E-1 key 1 settings.

- 1** In the M/E-1 independent key transition control block, press the key delegation button [KEY1], turning it on.
- 2** Press the [K-SS] button, turning it on.
- 3** Set the following buttons on or off, depending on the information you want to recall.
(These buttons are not provided in the downstream key control block.)

[K-MOD ENBL] button: When this is on, the key settings and key modifiers are recalled. When this is off, they are not recalled.

[K-TR ENBL] button: When this is on, the independent key transition settings are recalled. When this is off, they are not recalled.

If both buttons are off, the key memory function is enabled and only the saved selection of key fill and key source signals is recalled.

- 4** Press the key source name display/key snapshot button corresponding to the register you want to recall.

The button you pressed lights yellow, and this recalls the key snapshot.

To cancel a recall carried out in the downstream key control block, press the [UNDO] button in the downstream key control block.



Key Snapshot Operations Using a Simple Transition Module

When using a simple transition module, the key snapshots hold the settings for key 3 and key 4. However, each key control block can be assigned to any key in setup (see Chapter 16 “Overall Control Panel Settings (Config Menu)” (Volume 2)).

You can carry out key snapshot operations in the independent key transition control block (simple type) and Flexi Pad control block (simple type).

There are two dedicated key snapshot registers for each of keys 3 and 4.

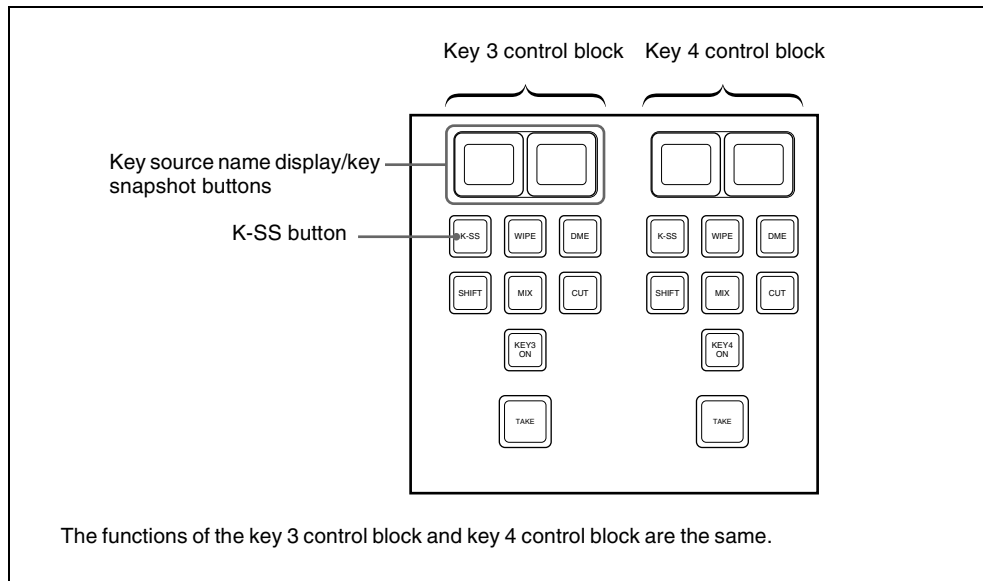

Independent key transition control block (simple type)

Saving a key snapshot

For example, to save the settings of M/E-1 key 3, use the following procedure.

- 1 In the M/E-1 independent key transition control block, press the [K-SS] button in the key 3 control block, turning it on.

This switches to key snapshot mode, and the key source name display/key snapshot button shows the state of registers 1 and 2 for key 3.

Off: Nothing is saved in the register.

Lit orange: Settings are saved in the register.

For a register holding a snapshot, the register name is shown as up to eight characters.

- 2 In the Flexi Pad control block, hold down the [SNAPSHOT] button and press the key source name display/key snapshot button corresponding to the register in which you want to save the snapshot.

The key source name display/key snapshot button which you pressed lights yellow.

Note

If you save a key snapshot in a register for which the button is lit orange or yellow, the existing contents of the register are overwritten.

Recalling a key snapshot

For example, the following procedure recalls the state of the M/E-1 key 3 settings.

- 1 In the M/E-1 independent key transition control block, press the [K-SS] button in the key 3 control block, turning it on.
- 2 Press the key source name display/key snapshot button corresponding to the register you want to recall.

The button you pressed lights yellow, and this recalls the key settings (excluding the key insertion state (on/off) and key priority).



Chapter 5 Wipes

Basic Procedure for Wipe Settings	438
Wipe Settings Menu	438
Wipe Pattern Selection	438
Pattern Mix	441
Setting Wipe Modifiers	443
Wipe Modify Clear	454
Wipe Settings for Independent Key Transitions	455
Basic Procedure for Independent Key Transition Wipe Settings	455
Setting Independent Key Transition Wipe Modifiers	456
Wipe Snapshots	460
Wipe Snapshot Operations With the Flexi Pad	460
Wipe Snapshot Operations With the Menus	463

Basic Procedure for Wipe Settings

You carry out wipe setting operations principally using the Wipe menu for each of the M/E-1 to M/E-3 and PGM/PST banks.

This section describes the basic procedures for wipe settings, taking the M/E-1 >Wipe menu as an example.

For details of independent key transition wipe settings, see “Wipe Settings for Independent Key Transitions” (page 455).

Wipe Settings Menu

Accessing the wipe settings menu

To access the M/E-1 >Wipe menu, use any of the following operations.

- In the menu control block, select the top menu selection button [M/E 1], and press VF5 ‘Wipe.’
- In the transition control block of the M/E-1 bank, press the transition type selection button [WIPE] twice in rapid succession.
- In the Flexi Pad control block of the M/E-1 bank, press the [WIPE] button twice in rapid succession.

Any of the above operations displays the M/E-1 >Wipe menu.

Wipe Pattern Selection

You can select a wipe pattern in the Wipe menu, or by entering a pattern number from the Flexi Pad control block.

For how to use the Flexi Pad control block, see “Selecting a wipe pattern in the Flexi Pad control block” (page 440).

Selecting a wipe pattern by a menu operation

- 1** In the M/E-1 >Wipe menu, select HF1 ‘Main Pattern.’

The Main Pattern menu appears.

- 2** Select the wipe pattern group with the pattern group selection button.

Standard: standard wipes

- Enhanced:** enhanced wipes
- Rotary:** rotary wipes
- Mosaic1 to Mosaic3:** mosaic wipes
- Random/Dust:** random/diamond dust wipes

The patterns from the selected pattern group appear on the screen.

For details of wipe patterns, see “Types of Wipe Pattern” (page 60) and “Wipe Pattern List” in Appendix (Volume 1) (page 560).

- 3** Press the button to select the desired pattern.
- 4** The parameters change according to the selected pattern, and you can adjust the pattern.

- **When a polygon wipe is selected** (pattern number 49)

Knob	Parameter	Adjustment	Setting values
1	No	Number of points	3 to 64
2	Star Rate	Angularity of star	-100.00 to +100.00 a)

a) A value of -100.00 completely removes the star “rays,” leaving a circle; at +100.00 the “rays” are at their sharpest.

- **When a mosaic wipe is selected** (pattern numbers 200 to 203, 206 to 213, 224 to 247, 250 to 257, 260 to 269)

Knob	Parameter	Adjustment	Setting values
1	H Tile No	Number of tiles horizontally	2 to 36
2	V Tile No	Number of tiles vertically	2 to 18

- **When a karaoke wipe is selected** (pattern numbers 220 to 223)

Knob	Parameter	Adjustment	Setting values
1	Start	Position of start tile	-100.00 to +100.00 a)
2	Row No	Number of rows of tiles	1 to 36
3	Phase	Delay for next row	-100.00 to +100.00 b)

a) At -100.00 tiles appear from the top (or left edge) of the screen; at +100.00 from the bottom (or right edge) of the screen.

b) At -100.00 all rows appear simultaneously; at +100.00 until one row of tiles is completely displayed, the next row does not start to appear.

- **When a random wipe is selected** (pattern number 273)

Knob	Parameter	Adjustment	Setting values
1	H Size	Tile width	0.00 to 100.00

Knob	Parameter	Adjustment	Setting values
2	V Size	Tile height	0.00 to 100.00
3	Volatility	Rate of tile generation	0.00 to 100.00

• **When a diamond dust wipe is selected** (pattern number 274)

Knob	Parameter	Adjustment	Setting values
1	H Size	Particle width	0.00 to 100.00
2	V Size	Particle height	0.00 to 100.00
3	Flash Rate	Rate of generation of particles	0.00 to 100.00

Note

When Flash Rate is set to 0.00, you cannot change the pattern. In this state, adjusting H Size or V Size has no effect on the pattern.

For details of a pattern mix, see the next section.

For details of applying pattern modifiers, see “Setting Wipe Modifiers” (page 443).

Selecting a wipe pattern in the Flexi Pad control block

To select a pattern with a standard type Flexi Pad control block, use the following procedure. (It is not possible to select a wipe pattern with a simple type Flexi Pad control block.)

- 1** In the M/E-1 Flexi Pad control block, press the [WIPE] button.
This switches the Flexi Pad control block to wipe snapshot mode.
- 2** In the memory recall section, press the [PTN NO] button.

This switches the Flexi Pad control block to wipe pattern number recall mode, and the memory recall section display changes as shown in the following figure.

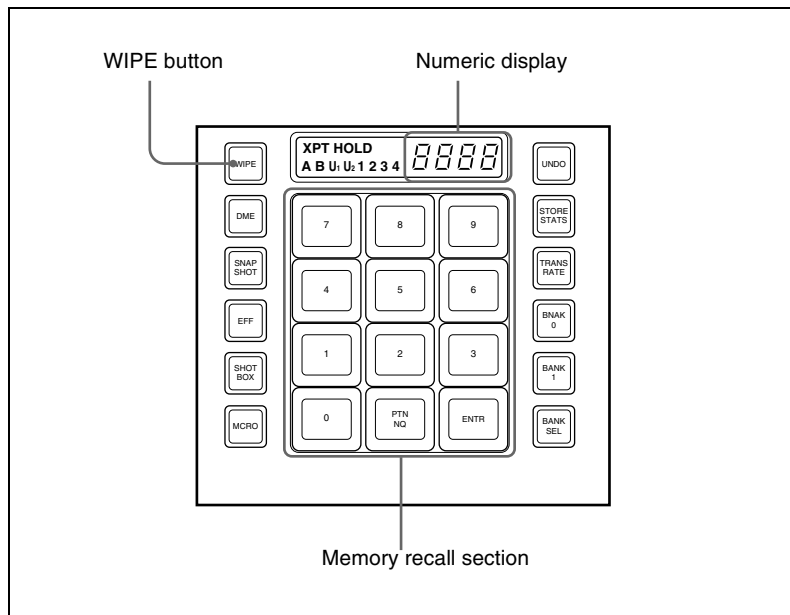

- 3** Use the buttons in the memory recall section to enter the pattern number consisting of up to three digits, and press the [ENTR] button.

The entry is confirmed, and now the numeric display shows the pattern number.

For the pattern numbers, see “Wipe Pattern List” in Appendix (Volume 1) (page 560).

Pattern Mix

Combining two patterns

You can combine two selected patterns (referred to as main and “sub”) to form a new pattern. Select a main pattern in the Main Pattern menu, then use the following procedure.

- 1** In the M/E-1 >Wipe menu, select HF3 ‘Sub Pattern.’

The Sub Pattern menu appears.

2 In the same way as for the main pattern, select the sub pattern.

The patterns that can be selected for the sub pattern depend on the pattern selected for the main pattern (*see the following table*).

Possible combinations of main pattern and sub pattern

Yes: Combination possible **No:** Combination not possible

Main pattern	Sub pattern				
	Standard	Enhanced	Rotary	Mosaic	Random/diamond dust
Standard	Yes	Yes	No	Yes	Yes
Enhanced	Yes	Yes	No	Yes	Yes
Rotary	No	No	No	No	No
Mosaic	Yes	Yes	No	No	Yes
Random/diamond dust	Yes	Yes	No	Yes	No

3 Select HF2 ‘Pattern Mix.’

The Pattern Mix menu appears.

4 In the <Pattern Mix> group, select the type of pattern mix.

Mix: mix

+Nam: positive Nam

-Nam: negative Nam

Morphing: morphing

For an overview of types of pattern mix, see page 61.

5 Depending on the selection in step 4, set the following parameters.

- **When mix, positive Nam, or negative Nam is selected**

Knob	Parameter	Adjustment	Setting values
1	Mix Ratio	Proportion of sub pattern to the main pattern	0.00 to 100.00

- **When morphing (*see page 61*) is selected**

Knob	Parameter	Adjustment	Setting values
2	Start	Point in transition at which main pattern is at 100%	-50.00 to +150.00
3	End	Point in transition at which sub pattern is at 100%	-50.00 to +150.00

- 6** In the <Main/Sub Link> group, make the main/sub modifier link function settings. (See “Main and sub modifier link function” (page 63).)

Full: fully linked mode
Semi: semi-linked mode

Applying the effect of a diamond dust wipe to the selected pattern (Dust mix)

- 1** In the Pattern Mix menu, press [Dust Mix], turning it on.
- 2** Set the following parameters as required.

Knob	Parameter	Adjustment	Setting values
1	Mix Ratio	Proportion of diamond dust pattern in mix	0.00 to 100.00
2	H Size	Particle width	0.00 to 100.00
3	V Size	Particle height	0.00 to 100.00
4	Flash Rate	Rate of generation of particles	0.00 to 100.00

You can also apply the dust mix function to the pattern generated by a pattern mix.

Note

When a random/diamond dust wipe (pattern numbers 270-274) is selected, the dust mix function is not available.

Setting Wipe Modifiers

You can apply various modifiers to the wipe pattern: setting the wipe direction, pattern position, and so on.

For an overview of the wipe modifiers, see “Wipe Pattern Variation and Modifiers” (page 63).

Note that the available modifiers may depend on the pattern you are using. For details, see “Possible combinations of wipe patterns and modifiers” (page 454).

Main pattern and sub pattern modifiers

You can make independent settings of the modifiers for the main pattern and sub pattern.



- To set the modifiers for the main pattern, in the M/E-1 >Wipe menu, select HF5 ‘Main Modify,’ and make the settings in the Main Modify menu.
 - To set the modifiers for the sub pattern, select HF6 ‘Sub Modify,’ and make the settings in the Sub Modify menu.
- Operations in the Main Modify menu and Sub Modify menu are the same.

Independently set modifiers for the main pattern and sub pattern

- Positioner
- Rotation
- Aspect ratio
- Pattern replication (MULTI)
- Pairing
- Modulation
- Spring
- Spiral

The following sections show examples of modifying the main pattern.

Specifying the wipe direction (Direction)

You can specify the wipe direction (normal/reverse).

To specify the wipe direction in a menu

- 1** In the M/E-1 >Wipe menu, select HF4 ‘Edge/Direction.’

The Edge/Direction menu appears.

- 2** In the <Direction> group, specify the wipe direction.

Normal: regular direction

Normal/Reverse: alternate between regular and reverse for each transition

Reverse: reverse direction to normal

To specify the wipe direction with a button in the transition control block

In the transition control block of each of the M/E-1 to M/E-3 and PGM/PST banks, press the following direction selection buttons.

NORM: Normal

NORM/REV: Normal/reverse

REV: Reverse

Splitting the wipe pattern

- 1** In the M/E-1 >Wipe menu, select HF4 ‘Edge/Direction.’

The Edge/Direction menu appears.

- 2 Press [Split], turning it on.
- 3 Set the following parameters.

Knob	Parameter	Adjustment	Setting values
1	Split No	Number of splits	1 to 4 (integer)
2	Spacing	Spacing between adjacent patterns	0.00 to 100.00

Modifying the wipe pattern edge

- 1 In the M/E-1 >Wipe menu, select HF4 ‘Edge/Direction.’

The Edge/Direction menu appears.

- 2 In the <Edge> group, select the edge type.

Border: border

Soft: soft edge

Soft Border: soft border

For an overview of the edge types, see “Edge” (page 65).

- 3 Set the parameters according to the selection in step 2.

- **When border is selected**

Knob	Parameter	Adjustment	Setting values
1	Width	Border width	0.00 to 100.00

- **When soft edge is selected**

Knob	Parameter	Adjustment	Setting values
1	Soft	Edge softness	0.00 to 100.00

- **When soft border is selected**

Knob	Parameter	Adjustment	Setting values
1	Width	Border width	0.00 to 100.00
2	Inner Soft	Border inner softness	0.00 to 100.00
3	Outer Soft	Border outer softness	0.00 to 100.00

- 4 When you selected border or soft border, select the edge fill signal in the <Edge Fill> group.

Utility 2 Bus: signal selected on the utility 2 bus

Matte: signal from the dedicated color matte generator



5 Depending on the operation in step **4**, carry out the following operation.

When ‘Utility 2 Bus’ is selected: Hold down the [UTIL] button in the cross-point control block, and select the signal on the background B bus.

While the [UTIL] button is held down, the background B bus changes to the utility 2 bus.

Note

To enable the [UTIL] button, its operation mode must be set to [Hold] beforehand. (See “Operation Settings (Operation Menu)” in Chapter 16 (Volume 2).)

When ‘Matte’ is selected: In the same Edge/Direction menu, press [Matte Adjust] to display the Matte Adjust menu, then adjust the single-color or two-color combination color matte. Select whether to use a single-color matte or a two-color combination in the <Edge Matte> group.

Flat Color: Adjust color 1 with the following parameters.

Knob	Parameter	Adjustment	Setting values
1	Luminance	Luminance	0.00 to 100.00
2	Saturation	Saturation	0.00 to 100.00
3	Hue	Hue	359.99 to 0.00

When you select [Mix Color] for a two-color combination, see the next paragraph.

Carrying out a color mix for the edge fill matte

When you selected [Matte] for the border or soft border edge fill, you can combine color 1 and color 2.

For the combination, you can use not only a normal wipe generator pattern, but also the dedicated color mix pattern.

1 In the <Edge Fill> group of the Edge/Direction menu, select [Matte], and press [Matte Adjust].

The Matte Adjust menu appears.

2 In the <Edge Matte> group, select [Mix Color], turning it on.

3 In the <Mix Pattern> group, make one of the following selections.

Wipe: Use the wipe pattern selected for the transition.

Pattern: Use the dedicated pattern.

4 Depending on the selection in step **3**, set the following parameters.

- When Wipe is selected

Knob	Parameter	Adjustment	Setting values
1	Size	Pattern size	0.00 to 100.00
2	Soft	Edge softness	0.00 to 100.00

- When Pattern is selected

Knob	Parameter	Adjustment	Setting values
1	Size	Pattern size	0.00 to 100.00
2	Soft	Edge softness	0.00 to 100.00
3	Pattern	Pattern number	1 to 24 ^{a)}

a) The patterns are the same as for a standard wipe. See "Wipe Pattern List" in Appendix (Volume 1) (page 560).

If you selected Pattern, you can also carry out the pattern selection by pressing the [Mix Ptn Select] button in the Matte Adjust menu, to display the Mix Ptn Select menu. Select any pattern appearing in the Mix Ptn Select menu (standard wipe patterns 1 to 24) by pressing the appropriate button, and you can then adjust the following parameters.

Knob	Parameter	Adjustment	Setting values
1	Size	Pattern size	0.00 to 100.00
2	Soft	Edge softness	0.00 to 100.00

5 If you selected Pattern in step 4, if required, the following modifiers can be added. After selecting a wipe mix, skip to step 6.

- When turning [Position] on and setting the pattern position

Knob	Parameter	Adjustment	Setting values
1	Position H	Horizontal position	-200.00 to +200.00 ^{a)}
2	Position V	Vertical position	-200.00 to +200.00 ^{a)}

a) See page 65.

- When turning [Multi] on and using replications of the same pattern

Knob	Parameter	Adjustment	Setting values
1	H Multi	Number of repetitions of pattern horizontally	1 to 63
2	V Multi	Number of repetitions of pattern vertically	1 to 63
3	Invert Type	Replication layout	1 to 4 ^{a)}



a) See page 68.

• **When turning [Aspect] on and setting the aspect ratio of the pattern**

Knob	Parameter	Adjustment	Setting values
1	Aspect	Aspect ratio	-100.00 to +100.00 ^{a)}

a) See page 67.

• **When turning [Angle] on in the <Rotation> group and slanting the pattern**

Knob	Parameter	Adjustment	Setting values
1	Angle	Angle of pattern rotation	-100.00 to +100.00 ^{a)}

a) See page 66.

• **When turning [Speed] on in the <Rotation> group and rotating the pattern at a constant rate**

Knob	Parameter	Adjustment	Setting values
1	Speed	Rotation rate of pattern	-100.00 to +100.00 ^{a)}

a) See page 66.

6 To adjust color 1, set [Color 1] on, and to adjust color 2 set [Color 2] on, then adjust the parameters.

Knob	Parameter	Adjustment	Setting values
1	Luminance	Luminance	0.00 to 100.00
2	Saturation	Saturation	0.00 to 100.00
3	Hue	Hue	359.99 to 0.00

7 To interchange color 1 and color 2, press the [Color Invert] button, turning it on.

Setting the wipe position (Positioner)

You can set the position independently for the main pattern and sub pattern.

1 In the M/E-1 >Wipe menu, select HF5 'Main Modify.'

The Main Modify menu appears.

2 In the <Position> group, press [Position], turning it on, and set the pattern position.

Knob	Parameter	Adjustment	Setting values
1	Position H	Horizontal position	-200.00 to +200.00 ^{a)}
2	Position V	Vertical position	-200.00 to +200.00 ^{a)}

a) See page 65.

To return the pattern position to the center of the screen

In the <Position> group, press [Center].

To move the pattern from its current position to the center through the course of a transition

In the <Position> group, press [Auto Center], turning it on.

To set the wipe position using the trackball or joystick

You can also set the wipe position using the trackball or joystick in the device control block.

- 1 In the device control block, press the [M/E1], [M/E2], [M/E3], or [P/P] button, turning it on.

The buttons in the device control block are assigned to the wipe position setting as follows.

Table 1: Buttons and assigned settings

Button name	Setting
MAIN	Wipe position for common transition (main pattern)
SUB	Wipe position for common transition (sub pattern)

Table 2: Buttons assigned to functions

Button name	Function
POS	Toggle Position on or off.
X, Y	Fix the operating direction.
CTR	Return the pattern position to the center of the screen.

- 2 Press the [MAIN] button or [SUB] button, turning it on.
- 3 Press the [POS] button, turning Position on.
- 4 Move the trackball or joystick, to set the wipe position. By pressing the [X] button, turning it on, you can restrict movement to the horizontal direction, and by pressing the [Y] button, turning it on, you can restrict movement to the vertical direction.

Rotating the wipe pattern (Rotation)

You can apply rotation independently to the main pattern and sub pattern.

- 1** In the M/E-1 >Wipe menu, select HF5 'Main Modify.'

The Main Modify menu appears.

- 2** In the <Rotation> group, select the rotation type.

Angle: Incline the pattern through a fixed angle.

Speed: Rotate at a fixed rate.

Magnitude: Rotate through a particular angle during the course of the transition.

For an overview of the rotation, see page 65.

- 3** According to the selection in step 2, set the following parameters.

- **When Angle is selected**

Knob	Parameter	Adjustment	Setting values
1	Angle	Angle of pattern rotation	-100.00 to +100.00 ^{a)}

a) See page 66.

- **When Speed is selected**

Knob	Parameter	Adjustment	Setting values
1	Speed	Rotation rate of pattern	-100.00 to +100.00 ^{a)}

a) See page 66.

- **When Magnitude is selected**

Knob	Parameter	Adjustment	Setting values
1	Angle	Angle of pattern rotation at start of transition	-100.00 to +100.00 ^{a)}
2	Magnitude	Angle of rotation through course of transition	-200.00 to +200.00 ^{a)}

a) See page 67.

Setting the wipe pattern aspect ratio (Aspect ratio)

You can set the aspect ratio independently for the main pattern and sub pattern.

- 1** In the M/E-1 >Wipe menu, select HF5 'Main Modify.'

The Main Modify menu appears.

2 Press [Aspect], turning it on.

3 Set the following parameter.

Knob	Parameter	Adjustment	Setting values
1	Aspect	Aspect ratio	-100.00 to +100.00 ^{a)}

a) See page 67.

Setting the wipe pattern replication (Multi)

You can set pattern replication independently for the main pattern and sub pattern.

1 In the M/E-1 >Wipe menu, select HF5 'Main Modify.'

The Main Modify menu appears.

2 Press the [Multi] button, turning it on.

3 Set the following parameters.

Knob	Parameter	Adjustment	Setting values
1	H Multi	Number of repetitions of pattern horizontally	1 to 63
2	V Multi	Number of repetitions of pattern vertically	1 to 63
3	Shift	Replication layout	-100.00 to +100.00 ^{a)}

a) See page 68.

4 To make more adjustments, press the [Multi Adjust] button.

The Multi Adjust menu appears.

5 Make the following settings, as required.

H Invert: When this is on, alternate tiles are inverted left-to-right.

V Invert: When this is on, alternate tiles are inverted top-to-bottom.

Non-Mask: When this is on, even if the positioner function is used to move the pattern position, the pattern is always present on the screen.

Position: By adjusting the following parameters, move the pattern position within the divisions determined in step **3**.

Knob	Parameter	Adjustment	Setting values
1	Position H	Horizontal position of pattern	-200.00 to +200.00 ^{a)}



Knob	Parameter	Adjustment	Setting values
2	Position V	Vertical position of pattern	-200.00 to +200.00 ^{a)}

a) See page 65.

Making a wipe pattern like a Venetian blind (Pairing)

- 1** In the M/E-1 >Wipe menu, select HF5 'Main Modify.'
The Main Modify menu appears.
- 2** In the <Pairing> group, select the slit direction.
H: Create slits in the horizontal direction.
V: Create slits in the vertical direction.
- 3** Set the following parameters.

Knob	Parameter	Adjustment	Setting values
1	Width	Width of the slits	1 to 128 (integer)
2	H Offset	Spacing in the horizontal direction	-100.00 to +100.00 ^{a)}
3	V Offset	Spacing in the vertical direction	-100.00 to +100.00 ^{a)}

a) See page 68.

Applying modulation to the wipe pattern (Modulation)

You can apply modulation independently to the main pattern and sub pattern.

Note

When using 1080PsF mode in an HD system, the modulation function is not available.

- 1** In the M/E-1 >Wipe menu, select HF5 'Main Modify.'
The Main Modify menu appears.
- 2** Depending on the desired effect, in the <Modulation> group select one of the following.
H: Modulate the pattern, applying waviness in the horizontal direction to edges.
V: Modulate the pattern, applying waviness in the vertical direction to edges.
Fringe: Modulate the pattern, applying waviness in the radial direction to edges.

3 Set the following parameters.

Knob	Parameter	Adjustment	Setting values
1	Amplitude	Amplitude of modulation	0.00 to 100.00
2	Frequency	Frequency of modulation	0.00 to 100.00
3	Speed	Speed of waves	-100.00 to +100.00 ^{a)}
4	Shape	Form of the modulation	1 to 3 ^{b)}

a) See page 69.

b) See page 69.

Applying barrel or pincushion distortion to the edge of the wipe pattern (Spring)

You can set the spring function independently for the main and sub patterns.

1 In the M/E-1 >Wipe menu, select HF5 'Main Modify.'

The Main Modify menu appears.

2 Press [Spring], turning it on.

3 Set the following parameters.

Knob	Parameter	Adjustment	Setting values
1	Gain	Degree of barrel distortion	-100.00 to +100.00 ^{a)}

a) See page 71.

Applying a spiral effect to the wipe pattern (Spiral)

You can set the spiral function independently for the main and sub patterns.

1 In the M/E-1 >Wipe menu, select HF5 'Main Modify.'

The Main Modify menu appears.

2 Press [Spiral], turning it on.

3 Set the following parameters.

Knob	Parameter	Adjustment	Setting values
1	Magnitude	Size and direction of the spiral	-100.00 to +100.00 ^{a)}
2	Wave Speed	Speed of the lateral waves	-100.00 to +100.00 ^{a)}

a) See page 71.

Possible combinations of wipe patterns and modifiers

Yes: Can be used **No:** Cannot be used

Modifiers	Type of wipe				
	Standard	Enhanced	Rotary	Mosaic	Random/ diamond dust
Direction	Yes	Yes	Yes	Yes	Yes
Split	Yes	Yes	No	Yes	No
Edge	Yes	Yes	Yes	Yes	Yes
Positioner	Yes ^{a)}	Yes ^{b)}	Yes ^{c)}	No	No
Rotation	Yes	Yes	Yes ^{c)}	No	No
Aspect ratio	Yes ^{d)}	Yes	No	No	No
Pattern replication	Yes	Yes	Yes	Yes ^{e)}	No
Pairing	Yes ^{f)}	Yes	No	No	No
Modulation (H/V)	Yes	Yes	Yes	No	No
Modulation (Fringe)	No ^{g)}	Yes	No	No	No
Spring	No ^{g)}	Yes	No	No	No
Spiral	No ^{h)}	Yes	No	No	No

a) Not patterns 1 to 16, 19, and 20

b) Not patterns 300 to 303

c) Not patterns 100 to 103, 150, 151, 516, 518, 604, and 606

d) Not patterns 1 to 8, 17, and 18

e) Not patterns 220 to 223

f) Not patterns 19 and 20

g) But patterns 21, 23 and 24 are possible

h) But patterns 21 and 23 are possible

Wipe Modify Clear

Press [Default Recall] at the lower left of the menu display, turning it on, then press VF5 ‘Wipe’ to return the wipe settings to their initial status.

For details of menu operations, see “Menu Operations” (page 323).

Wipe Settings for Independent Key Transitions

You carry out independent key transition wipe setting operations using the Wipe Adjust menu for each keyer.

For an overview of independent key transitions, see page 37.

This section describes the independent key transition wipe settings, taking the M/E-1 >Key1 >Transition >Wipe Adjust menu as an example.

Basic Procedure for Independent Key Transition Wipe Settings

Accessing the independent key transition wipe settings menu

As an example, to access the M/E-1 >Key1 >Transition >Wipe Adjust menu, carry out either of the following operations.

- In the menu control block, select the top menu selection button [M/E 1] and select VF1 'Key1' and HF6 'Transition' to display the Transition menu for key 1, then press [Wipe Adjust].
- In the independent key transition control block of the M/E-1 bank, press the key delegation button [KEY1], then press the independent key transition type selection button [WIPE] twice in rapid succession.

Carrying out the above operation displays the M/E-1 >Key1 >Transition >Wipe Adjust menu (which will be referred to below as simply the Key1 Wipe Adjust menu).

Selecting the independent key transition wipe pattern

You select the independent key wipe pattern from the list of patterns displayed in the menu.

Note

In an independent key transition, you can only use the standard wipe patterns (pattern numbers 1 to 24).

To select a wipe pattern for independent key1 on the M/E-1 bank, use the following procedure.

- 1 In the Key1 Wipe Adjust menu, select [Pattern Select].
The Pattern Select menu appears.
- 2 Press the button for the desired pattern.

Setting Independent Key Transition Wipe Modifiers

Available modifiers

You can use the following modifiers with an independent key transition wipe. Note that the available modifiers may depend on the pattern you are using.

- Direction
- Edge
- Positioner
- Rotation
- Aspect ratio
- Pattern replication

Setting the wipe direction (Direction)

In the <Direction> group of the Key1 Wipe Adjust menu, make any of the following selections.

Normal: regular direction

Normal/Reverse: alternate between regular and reverse for each transition

Reverse: reverse direction to normal

Softening the wipe pattern edge (Soft edge)

- 1 Press [Soft] in the Key1 Wipe Adjust menu, turning it on.
- 2 Set the following parameter.

Knob	Parameter	Adjustment	Setting values
1	Soft	Edge softness	0.00 to 100.00

Setting the wipe position (Positioner)

There are two methods of setting the wipe position: using the device control block, or in a menu.

To set the wipe position using the trackball or joystick

You can also set the wipe position using the trackball or joystick in the device control block.

- 1 In the device control block, press the [M/E1], [M/E2], [M/E3], or [P/P] button, turning it on.

The buttons in the device control block are assigned to the wipe position setting as follows.

Table 1: Buttons and assigned settings

Button name	Setting
K1 CB1	Wipe position for independent key 1 transition
K2 CB2	Wipe position for independent key 2 transition
K3 FM1	Wipe position for independent key 3 transition
K4 FM2	Wipe position for independent key 4 transition

Table 2: Buttons assigned to functions

Button name	Function
POS	Toggle Position on or off.
X, Y	Fix the operating direction.
CTR	Return the pattern position to the center of the screen.

- 2 Press one of the buttons in Table 1 above, to select the wipe position to which the operation applies. Multiple selection is possible.
- 3 Press the [POS] button, turning Position on.
- 4 Move the trackball or joystick, to set the wipe position. By pressing the [X] button, turning it on, you can restrict movement to the horizontal direction, and by pressing the [Y] button, turning it on, you can restrict movement to the vertical direction.

To set the wipe position by a menu operation

- 1 Press [Position] in the Key1 Wipe Adjust menu, turning it on.
- 2 Set the following parameters.

Knob	Parameter	Adjustment	Setting values
1	Position H	Horizontal position	-200.00 to +200.00 ^{a)}
2	Position V	Vertical position	-200.00 to +200.00 ^{a)}

a) See page 65.

To move the pattern from its current position to the center through the course of a transition

Press [Auto Center] in the <Position> group, turning it on.

Rotating the wipe pattern (Rotation)

- 1 In the <Rotation> group of the Key1 Wipe Adjust menu, select the rotation type.

Angle: Incline the pattern through a fixed angle.

Speed: Rotate at a speed rate.

Magnitude: Rotate the pattern through a fixed angle during the course of the transition.

- 2 According to the selection in step 1, set the following parameters.

• When Angle is selected

Knob	Parameter	Adjustment	Setting values
1	Angle	Angle of pattern rotation	-100.00 to +100.00 ^{a)}

a) See page 66.

• When Speed is selected

Knob	Parameter	Adjustment	Setting values
1	Speed	Rotation rate of pattern	-100.00 to +100.00 ^{a)}

a) See page 66.

• When Magnitude is selected

Knob	Parameter	Adjustment	Setting values
1	Angle	Angle of pattern rotation at start of transition	-100.00 to +100.00 ^{a)}
2	Magnitude	Angle of rotation through course of transition	-200.00 to +200.00 ^{a)}

a) See page 67.

Setting the wipe pattern aspect ratio (Aspect ratio)

- 1 Press [Aspect] in the Key1 Wipe Adjust menu, turning it on.
- 2 Set the following parameter.

Knob	Parameter	Adjustment	Setting values
1	Aspect	Aspect ratio	-100.00 to +100.00 ^{a)}

a) See page 67.

Replicating the wipe pattern (Multi)

- 1** Press [Multi] in the Key1 Wipe Adjust menu, turning it on.
- 2** Set the following parameters.

Knob	Parameter	Adjustment	Setting values
1	H Multi	Number of repetitions of pattern horizontally	1 to 63
2	V Multi	Number of repetitions of pattern vertically	1 to 63
3	Invert Type	Replication layout	1 to 4 ^{a)}

a) See page 68.

Wipe Snapshots

Wipe Snapshot Operations With the Flexi Pad

Buttons used

You can snapshot and save a wipe pattern together with the current settings of its modifiers and pattern limit in a dedicated register for recall when required. In a standard transition system there are ten wipe snapshot registers for each of the M/E-1 to M/E-3 and PGM/PST banks, and in a simple transition module eight registers for each bank.

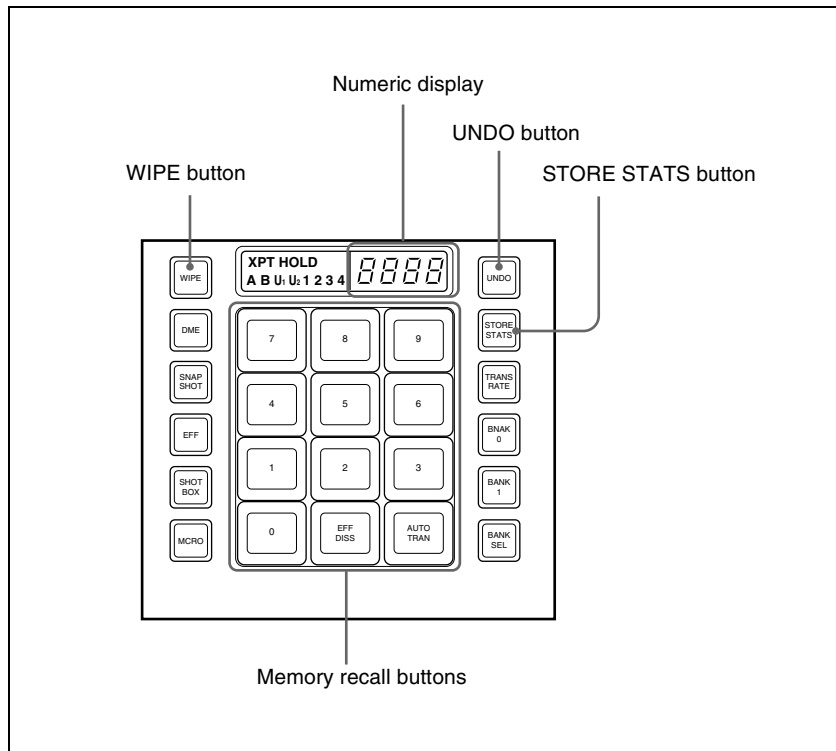

Flexi Pad control block (standard type)

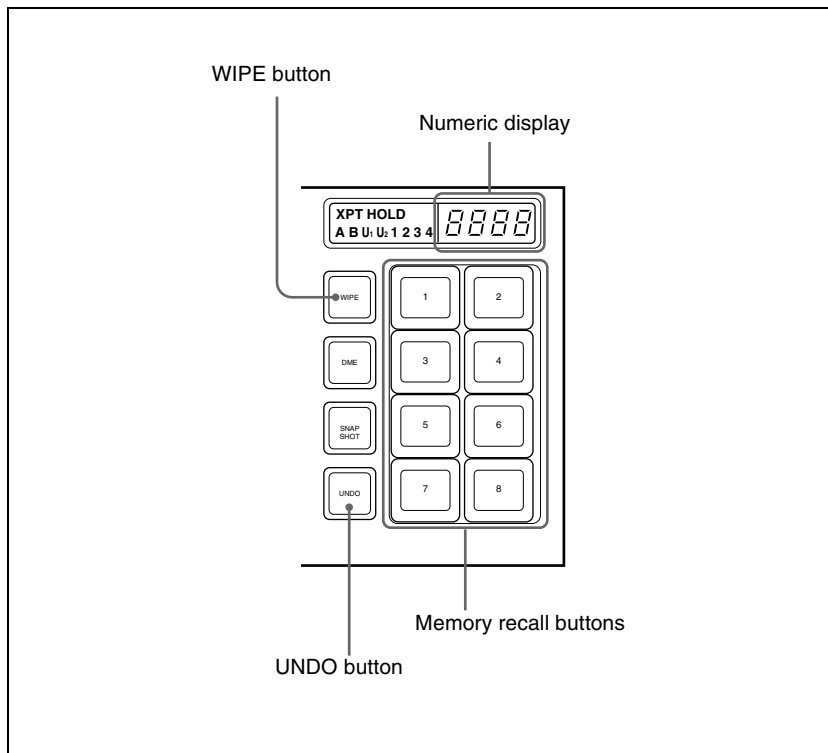

Flexi Pad control block (simple type)

Saving a wipe snapshot

- 1 Make the wipe settings that you want to save.
- 2 In the Flexi Pad control block, hold down the [WIPE] button, and press the memory recall button corresponding to the register in which you want to save.

Notes

- If you press a button which is lit orange or yellow, the existing contents of the register are overwritten.
- If you carry out a pattern mix, and both the main pattern and sub pattern are selected, then the memory recall button shows the main pattern.

The pattern appears on the button you pressed, which lights yellow. The numeric display shows the number of the corresponding pattern. It is also possible to display the register name using a Setup menu (*see “Operation Settings (Operation Menu)” in Chapter 16 (Volume 2)*).



Meaning of the state of buttons

Off: Nothing is saved in the register.

Lit orange: Settings are saved in the register.

Lit yellow: The most recently recalled register.

Canceling the saving of a wipe snapshot

To cancel the saving of a wipe snapshot immediately after performing it, hold down the [STORE STATS] button, and press the [UNDO] button. The [STORE STATS] button changes from amber to green.

Note

On a simple type Flexi Pad control block, it is not possible to cancel the saving of a wipe snapshot.

Recalling a wipe snapshot

1 In the Flexi Pad control block, press the [WIPE] button.

This switches the Flexi Pad control block to the mode for recalling a wipe snapshot.

2 Press the memory recall button for the register from which you want to recall the wipe snapshot.

The button lights, and the saved wipe snapshot is recalled. At this point, the numeric display shows the pattern number or register name.

Canceling the recall of a wipe snapshot

To cancel the recall of a wipe snapshot, press the [UNDO] button.

Deleting a wipe snapshot

When the [WIPE] button is lit in the Flexi Pad control block, hold down the [STORE STATS] button and press the memory recall button for the register in which you want to delete the wipe snapshot.

The indication of the memory recall button reverts from the wipe pattern or register name to the register number.

Note

In a simple type Flexi Pad control block, it is not possible to delete a wipe snapshot.

Wipe Snapshot Operations With the Menus

Menus used

As an example, when operating on M/E-1, select M/E-1 >Wipe >Wipe Snapshot.

The Wipe Snapshot menu appears.

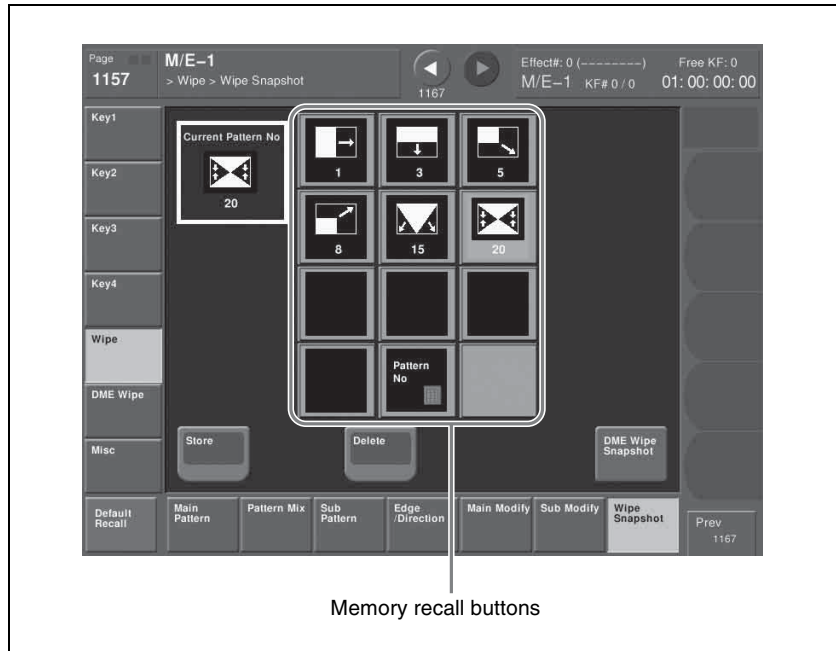

Button displays

In setup you can select whether the memory recall buttons show the pattern number or register name.

See “Operation Settings (Operation Menu)” in Chapter 16 (Volume 2).

Saving a wipe snapshot from the menu

- 1** Set up the wipe you want to save.
- 2** In the Wipe Snapshot menu, press [Store], lighting it amber.
- 3** Press the memory recall button for the register in which you want to save.



Notes

- If you press a button which is already lit, this overwrites the contents of the register.
- When both the main pattern and sub pattern are selected for a pattern mix, the button in the memory recall section shows only the main pattern.

Recalling a wipe snapshot from the menu

In the Wipe Snapshot menu, press the memory recall button for the wipe snapshot you want to recall.

This recalls the wipe snapshot, and the button you pressed lights amber.

In the upper left is shown the currently recalled register name or number.

Note

The Flexi Pad and menu settings are linked.

A setting in setup determines whether register names or pattern numbers appear.

Deleting a wipe snapshot from the menu

- 1** In the Wipe Snapshot menu, press [Delete].
- 2** Press the memory recall button for the wipe snapshot you want to delete.
This deletes the wipe snapshot.

Chapter 6 DME Wipes

Basic Procedure for DME Wipe Settings	466
DME Wipe Settings Menu	466
DME Wipe Pattern Selection	466
Setting DME Wipe Modifiers	469
DME Wipe Modify Clear	476
DME Wipe Settings for Independent Key Transitions	477
Basic Procedure for Independent Key Transition DME Wipe Settings ..	477
Setting Independent Key Transition DME Wipe Modifiers	478
Resizer DME Wipe Setting	481
DME Wipe Snapshots	482
DME Wipe Snapshot Operations With the Flexi Pad	482
DME Snapshot Operations With the Menus	482
Creating User Programmable DME Patterns	483
User Programmable DME Transition Mode	483

Basic Procedure for DME Wipe Settings

You carry out DME wipe setting operations principally using the DME Wipe menu for each of the M/E-1 to M/E-3 and PGM/PST banks.

This section describes the basic procedures for DME wipe settings, taking the M/E-1 >DME Wipe menu as an example.

For details of independent key transition DME wipe settings, see “DME Wipe Settings for Independent Key Transitions” (page 477).

For details of resizer DME wipe (for MVS-8000G only), see page 481.

Note

For one M/E bank, DME effects (including external processed keys) can be used in up to two places on the DME dedicated interface and in only one place on the SDI interface simultaneously.

When combining the SDI interface with the dedicated interface, you can apply DME effects to a maximum of three keys. (Requires a setting in setup.)

DME Wipe Settings Menu

Accessing the DME Wipe menu

To access the M/E-1 >DME Wipe menu, use any of the following operations.

- In the menu control block, select the top menu selection button [M/E 1], and press VF6 ‘DME Wipe.’
- In the transition control block of the M/E-1 bank, press the transition type selection button [DME] twice in rapid succession.
- In the Flexi Pad control block of the M/E-1 bank, press the [DME] button twice in rapid succession.

Any of the above operations displays the M/E-1 >DME Wipe menu.

DME Wipe Pattern Selection

You can select a DME wipe pattern in the DME Wipe menu, or by entering a pattern number from the Flexi Pad control block.

Selecting a DME wipe pattern by a menu operation

- 1 In the M/E-1 >DME Wipe menu, select HF1 ‘1ch’ for one-channel mode, HF2 ‘2ch’ for two-channel mode or HF3 ‘3ch’ for three-channel mode.
- 2 Select the desired DME wipe pattern group with one of the following buttons.
 - **Slide/Squeeze:** slide and squeeze
 - **Split/Door:** split and door
 - **Flip Tumble:** flip tumble
 - **Mirror/Sphere:** mirror and sphere
 - **Character Trail:** character trail
 - **Wave/Ripple:** wave and ripple
 - **Page Turn/Roll:** page turn and page roll
 - **Frame I/O/PinP:** frame in/out and picture-in-picture
 - **2D Trans/3D Trans:** 2D trans and 3D trans
 - **Sparkle/Split Slide:** sparkle and split slide
 - **Mosaic/Defocus:** mosaic and defocus
 - **Brick:** brick
 - **User Program:** user programmable DME

Selectable DME wipe pattern groups in one-channel mode: All of the above groups except for Brick.

Selectable DME wipe pattern groups in two-channel mode: Slide/Squeeze, Page Turn/Roll, Frame I/O, PinP, 3D Trans, Brick and User Program.

Selectable DME wipe pattern groups in three-channel mode: User Program and Brick.

For details of DME wipe patterns, see “Types of DME Wipe Pattern” (page 72) and “DME Wipe Pattern List” in Appendix (Volume 1) (page 566).

The patterns from the selected pattern group appear on the screen.

- 3 Press the button to select the desired pattern.

Note

For a key transition, the page turn, page roll and picture-in-picture cannot be used.

Adjusting DME wipe pattern parameters

Of the DME wipe patterns, the following have parameters that can be adjusted.

When Brick (for two channels) is selected (pattern numbers 2801 to 2804, 2811 to 2814)

Knob	Parameter	Adjustment	Setting values
1	Side V Size X	Horizontal magnification	0.01 to 8.00
2	Side V Size Y	Vertical magnification	0.01 to 8.00
3	Height	Height of brick	0.01 to 100.00
4	Center X	Horizontal center position	-100.00 to +100.00 ^{a)}
5	Center Y	Vertical center position	-100.00 to +100.00 ^{b)}

- a) The horizontal center position of the video pasted on Side V. At -100.00 the center is at the left edge of the screen, and at +100.00 the center is at the right edge of the screen.
 b) The vertical center position of the video pasted on Side V. At -100.00 the center is at the bottom edge of the screen, and at +100.00 the center is at the top edge of the screen.

When Frame in-out (for two channels) is selected

• Pattern numbers 2851 to 2854

Knob	Parameter	Adjustment	Setting values
5	Delay	Timing for video selected on a utility bus to appear on the screen	-100.00 to +100.00

• Pattern numbers 2861 to 2864

Knob	Parameter	Adjustment	Setting values
1	Rot X	Rotation about the Y axis (horizontal direction)	-100.00 to +100.00
2	Rot Y	Rotation about the X axis (vertical direction)	-100.00 to +100.00
3	Rot Z	Rotation about the Z axis	-100.00 to +100.00
5	Delay	Timing for video selected on a utility bus to appear on the screen	-100.00 to +100.00

When Brick (for three channels) is selected (pattern number 3601)

Parameter group [1/2]

Knob	Parameter	Adjustment	Setting values
1	Side V Size X	Side V horizontal magnification	0.01 to 8.00
2	Side V Size Y	Side V vertical magnification	0.01 to 8.00
3	Height	Height of brick	0.01 to 100.00 ^{a)}
4	Side V Center X	Side V horizontal center position	-100.00 to +100.00 ^{b)}



Knob	Parameter	Adjustment	Setting values
5	Side V Center Y	Side V vertical center position	-100.00 to +100.00 ^{c)}

- a) Shared with knob 3 for parameter group 2
- b) The horizontal center position of the video pasted on Side V. At -100.00 the center is at the left edge of the screen, and at +100.00 the center is at the right edge of the screen.
- c) The vertical center position of the video pasted on Side V. At -100.00 the center is at the bottom edge of the screen, and at +100.00 the center is at the top edge of the screen.

Parameter group [2/2]

Knob	Parameter	Adjustment	Setting values
1	Side H Size X	Side H horizontal magnification	0.01 to 8.00
2	Side H Size Y	Side H vertical magnification	0.01 to 8.00
3	Height	Height of brick	0.01 to 100.00 ^{a)}
4	Side H Center X	Side H horizontal center position	-100.00 to +100.00 ^{b)}
5	Side H Center Y	Side H vertical center position	-100.00 to +100.00 ^{c)}

- a) Shared with knob 3 for parameter group 1
- b) The horizontal center position of the video pasted on Side H. At -100.00 the center is at the left edge of the screen, and at +100.00 the center is at the right edge of the screen.
- c) The vertical center position of the video pasted on Side H. At -100.00 the center is at the bottom edge of the screen, and at +100.00 the center is at the top edge of the screen.

Selecting a DME wipe pattern in the Flexi Pad control block

In the standard type Flexi Pad control block, enter a 4-digit pattern number, using the [DME] button.

For details, see “Selecting a wipe pattern in the Flexi Pad control block” (page 440).

Note

You cannot select a DME wipe pattern in the simple type Flexi Pad control block.

Setting DME Wipe Modifiers

You can apply various modifiers to the DME wipe pattern: setting the DME wipe direction, pattern position, and so on.

For an overview of the DME wipe modifiers, see “DME Wipe Pattern Variation and Modifiers” (page 80).

Specifying the DME wipe direction (Direction)

You can specify the DME wipe direction (normal/reverse).

To specify the DME wipe direction in a menu

1 In the M/E-1 >DME Wipe menu, select HF4 ‘Edge/Direction.’

The Edge/Direction menu appears.

2 In the <Direction>group, specify the DME wipe direction.

Normal: regular direction

Normal/Reverse: alternate between regular and reverse for each transition

Reverse: reverse direction to normal

To specify the DME wipe direction with a button in the transition control block

In the transition control block of each of the M/E-1 to M/E-3 and PGM/PST banks, press the following direction selection buttons.

NORM: Normal

NORM/REV: Normal/Reverse

REV: Reverse

Modifying the DME wipe pattern edge

1 In the M/E-1 >DME Wipe menu, select HF4 ‘Edge/Direction.’

The Edge/Direction menu appears.

2 Depending on whether the selected pattern is in one-channel mode or two-channel mode, proceed as follows.

For a pattern in one-channel mode: press [1st Ch], turning it on.

For a pattern in two-channel mode: from the <Ch Select> group, select the corresponding channel. You can select more than one channel at the same time.

3 In the <Edge> group, select the edge type.

Border: border

Soft Border: soft border

4 Set the parameters according to the selection in step **3**.



- **When border is selected**

Knob	Parameter	Adjustment	Setting values
1	Width	Border width	0.00 to 100.00
3	Luminance	Luminance	0.00 to 100.00
4	Saturation	Saturation	0.00 to 100.00
5	Hue	Hue	359.99 to 0.00

- **When soft border is selected**

Knob	Parameter	Adjustment	Setting values
1	Width	Border width	0.00 to 100.00
2	Inner Soft	Border inner softness	0.00 to 100.00
3	Luminance	Luminance	0.00 to 100.00
4	Saturation	Saturation	0.00 to 100.00
5	Hue	Hue	359.99 to 0.00

Display indications when multiple channels are selected at the same time

The indications on the knobs show the settings of the lowest-numbered channel. When you turn the knobs to adjust the settings, this changes the settings on the other channels by the same amount.

Setting the DME wipe position (Positioner)

- 1** In the M/E-1 >DME Wipe menu, select HF5 'Modify.'

The Modify menu appears.

- 2** Depending on whether the DME wipe pattern is in one-channel mode or two-channel mode, proceed as follows.

For a pattern in one-channel mode: press [1st Ch], turning it on.

For a pattern in two-channel mode: from the <Ch Select> group, select the corresponding channel. You can select more than one channel at the same time.

- 3** In the <Position> group, press [Position], turning it on.

- 4** Set the following parameters.

Knob	Parameter	Adjustment	Setting values
1	H	Horizontal position	-200.00 to +200.00

Knob	Parameter	Adjustment	Setting values
2	V	Vertical position	-200.00 to +200.00

Display indications when multiple channels are selected at the same time

The indications on the knobs show the settings of the lowest-numbered channel. When you turn the knobs to adjust the settings, this changes the settings on the other channels by the same amount.

To return the DME wipe pattern position to the center of the screen

In the <Position> group, press [Center].

Displaying and moving the position of the DME wipe pattern (position select)

- 1 In the M/E-1 >DME Wipe menu, select HF5 'Modify.'
The Modify menu appears.
In the <Position Select> group, the one of the [Top Left], [Top Right], [Bottom Left], and [Bottom Right] buttons that is on indicates the current display position of the DME wipe pattern.
- 2 In the <Position> group, press [Position], turning it on.
- 3 Depending on whether the DME wipe pattern is in one-channel mode or two-channel mode, proceed as follows.
In one-channel mode: press [1st Ch], turning it on.
In two-channel mode: from the <Ch Select> group, select the corresponding channel. You can select more than one channel at the same time.
- 4 To move the position of the DME wipe pattern, press the button where you want to move to, turning it on.

The DME wipe pattern displayed on the screen moves to the position of the specified button.

Setting relative positions to move the DME wipe pattern

In two-channel mode, use the following procedure.

- 1 In the M/E-1 >DME Wipe menu, select HF5 'Modify.'
The Modify menu appears.



- 2 In the <Ch Select> group, select the target channels.
- 3 Press [Position] in the <Position> group, turning it on.
- 4 Set the following parameters.

Knob	Parameter	Adjustment	Setting values
4	Relative H	Relative movement in the horizontal direction	-400.00 to +400.00
5	Relative V	Relative movement in the vertical direction	-400.00 to +400.00

For details of the method of DME wipe pattern selection, see “DME Wipe Pattern Selection” (page 466).

Setting the DME wipe pattern size (Size)

- 1 In the M/E-1 >DME Wipe menu, select HF5 ‘Modify.’
The Modify menu appears.
- 2 Depending on whether the selected pattern is in one-channel mode or two-channel mode, proceed as follows.
For a pattern in one-channel mode: press [1st Ch], turning it on.
For a pattern in two-channel mode: from the <Ch Select> group, select the corresponding channel. You can select more than one channel at the same time.
- 3 Press [Size], turning it on.
- 4 Set the following parameters.

Knob	Parameter	Adjustment	Setting values
1	Size	Set size of effect	0.00 to 200.00 ^{a)}

a) The effect size when [Size] is off is taken as 100.00%.

Display indications when multiple channels are selected at the same time

The indications on the knobs show the settings of the lowest-numbered channel. When you turn the knobs to adjust the settings, this changes the settings on the other channels by the same amount.

Adjusting the DME wipe pattern cropping

Note

When pattern numbers 1701 and 1702 are selected, crop cannot be used.

- 1** In the M/E-1 >DME Wipe menu, select HF5 'Modify.'
The Modify menu appears.
- 2** Depending on whether the selected pattern is in one-channel mode or two-channel mode, proceed as follows.
For a pattern in one-channel mode: press [1st Ch], turning it on.
For a pattern in two-channel mode: from the <Ch Select> group, select the corresponding channel. You can select more than one channel at the same time. Some patterns need no selection which is fixed in the <Ch Select> group.
- 3** In the <Crop Mode> group, press [Crop], turning it on.
- 4** Set the following parameters.

Knob	Parameter	Adjustment	Setting values
1	Top	Crop the top of the image	-100.00 to +100.00
2	Left	Crop the left of the image	-100.00 to +100.00
3	Right	Crop the right of the image	-100.00 to +100.00
4	Bottom	Crop the bottom of the image	-100.00 to +100.00

Display indications when multiple channels are selected at the same time

The indications on the knobs show the settings of the lowest-numbered channel. When you turn the knobs to adjust the settings, this changes the settings on the other channels by the same amount.

In 16:9 mode, to crop to 4:3 aspect ratio

In the <Crop Mode> group, press [4:3], turning it on.

To set the action when a DME wipe crop transition is executed

- 1** In the M/E-1 >DME Wipe menu, select HF5 'Modify.'
The Modify menu appears.
- 2** Depending on whether the selected pattern is in one-channel mode or two-channel mode, proceed as follows.



For a pattern in one-channel mode: in the <Ch Select> group, press [1st Ch], turning it on.

For a pattern in two-channel mode: from the <Ch Select> group, select the corresponding channels. You can select more than one channel at the same time.

- 3** In the <Crop Mode> group, press [Crop] or [4:3 Crop] (to crop from 16:9 to 4:3 aspect ratio), turning it on.
- 4** In the <Crop Mode> group, press [Remove From Begin].
The Remove From Begin menu appears.
- 5** In the <Crop Transition> group, select the execution mode for the DME wipe crop transition.

Cut: Cut mode. The cropping does not change during the transition, but at the end point of the transition the cropping is removed (enlarges).

Last 5%: The cropping is maintained for the first 95% of the transition, and is progressively removed during the last 5% of the transition (enlarges).

Linear: The cropping is removed linearly through the whole course of the transition (enlarges).

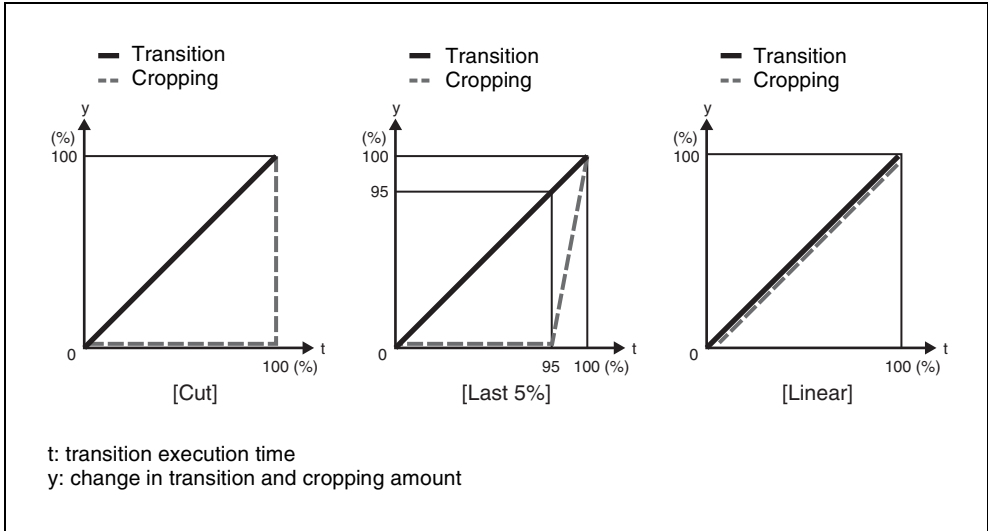

Setting the timing of transition completion

When the execution mode for a DME wipe crop transition is set to [Last 5%], you can select the timing of transition completion from 70% ([Last 30%]), 95% ([Last 5%]), and 100% ([Off]).

1 In the M/E 1 >DME Wipe menu, select HF5 'Modify'.

The Modify menu appears.

2 In the <Crop Mode> group select [Remove From Begin].

The Remove From Begin menu appears.

3 In the <Release Transition> group, select the timing of transition completion.

Last30%: The transition completes at the end of 70% of the transition execution time. The transition has a dead zone from 70% to 95% of the transition time.

Last5%: The transition completes at the end of 95% of the transition execution time. When the transition completes, the cropping is removed during the last 5%.

Off: The transition completes at the end of the transition execution time. During the last 5% of the transition, the transition and cropping removal proceed together.

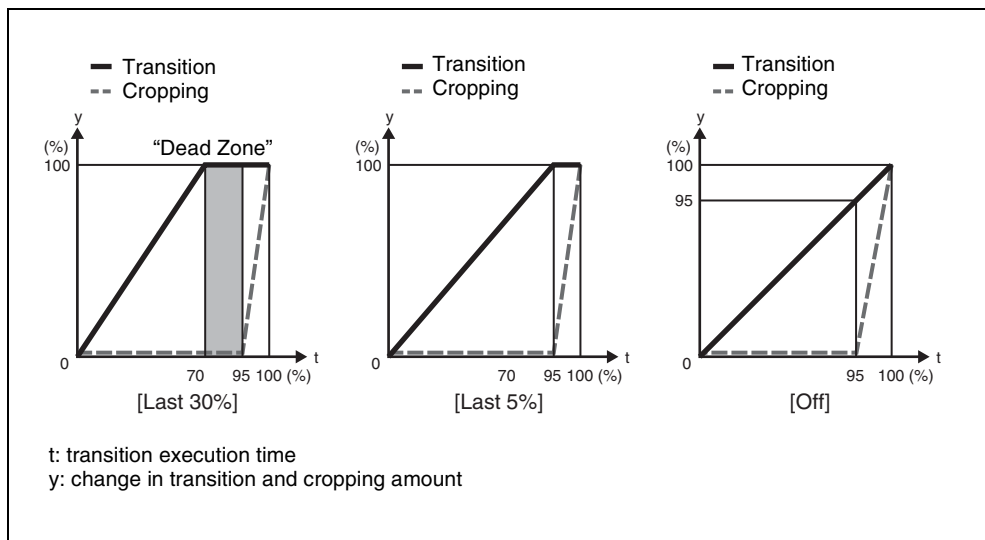

DME Wipe Modify Clear

Press [Default Recall] at the lower left of the menu display, turning it on, then press VF6 'DME Wipe' to return the DME wipe settings to their initial status.

For details of menu operations, see "Menu Operations" (page 323).

DME Wipe Settings for Independent Key Transitions

You carry out independent key transition DME wipe setting operations using the DME Wipe Adjust menu for each keyer.

For an overview of independent key transitions, see page 37.

This section describes the independent key transition DME wipe settings, taking the M/E-1 >Key1 >Transition >DME Wipe Adjust menu as an example.

Basic Procedure for Independent Key Transition DME Wipe Settings

Accessing the independent key transition DME wipe settings menu

As an example, to access the M/E-1 >Key1 >Transition >DME Wipe Adjust menu, carry out the following operation.

- In the menu control block, select the top menu selection button [M/E 1], and select VF1 'Key1' and HF6 'Transition' to display the Transition menu for key 1. Next, press [DME Wipe Adjust].
- Press the key delegation button [Key1] in the independent key transition control block of the M/E-1 bank, then press the independent key transition type [DME] twice in quick succession.

Carrying out the above operation displays the M/E-1 >Key1 >Transition >DME Wipe Adjust menu (which will be referred to below as simply the Key1 DME Wipe Adjust menu).

Selecting the independent key transition DME wipe pattern

You select the independent key DME wipe pattern from the list of patterns displayed in the menu.

To select a DME wipe pattern for independent key1 on the M/E-1 bank, use the following procedure.

- 1** In the <Pattern Select> group of the Key1 DME Wipe Adjust menu, press [1ch] for one-channel mode or [2ch] for two-channel mode.

The Pattern Select menu appears.



- 2 Select the desired DME wipe pattern group with one of the following buttons.

In two-channel mode, only Page Turn and Page Roll are selectable.

- **Slide/Squeeze:** slide and squeeze
- **Split/Door:** split and door
- **Mirror/Sphere:** mirror and sphere
- **Character Trail:** character trail
- **Wave/Ripple:** wave and ripple
- **Page Turn/Roll:** page turn and page roll
- **Frame I/O:** frame in/out
- **2D Trans/3D Trans:** 2D Trans and 3D Trans
- **Sparkle/Split Slide:** sparkle and split slide
- **User Program:** user programmable DME

For details of DME wipe patterns, see “Types of DME Wipe Pattern” (page 72) and “DME Wipe Pattern List” in Appendix (Volume 1) (page 566).

The patterns from the selected pattern group appear on the screen.

- 3 Press the button to select the desired pattern.

Setting Independent Key Transition DME Wipe Modifiers

You can add modifiers such as pattern position and size for an independent key transition DME wipe.

For introductory information, see “Positioner” (page 80) and “Size” (page 81).

Setting the DME wipe position (Positioner)

For applicable pattern numbers, *see page 80.*

- 1 In the <Position> group of the Key1 DME Wipe Adjust menu, press [Position], turning it on.

- 2 Set the following parameters.

Knob	Parameter	Adjustment	Setting values
1	H	Horizontal position	-200.00 to +200.00
2	V	Vertical position	-200.00 to +200.00

To return the DME wipe pattern position to the center of the screen
In the <Position> group, press [Center].

Setting the DME wipe pattern size (Size)

For applicable pattern numbers, *see page 81*.

- 1** In the Key 1 DME Wipe Adjust menu, press [Size], turning it on.
- 2** Set the following parameter.

Knob	Parameter	Adjustment	Setting values
1	Size	Set size of effect	0.00 to 200.00 ^{a)}

a) The effect size when [Size] is off is taken as 100.00%.

Cropping a key DME wipe

- 1** In the <Crop Mode> group of the Key1 DME Wipe Adjust menu, press [Crop], turning it on.
- 2** Set the following parameters.

Knob	Parameter	Adjustment	Setting values
1	Top	Cropping of the top of the image	-100.00 to +100.00
2	Left	Cropping of the left of the image	-100.00 to +100.00
3	Right	Cropping of the right of the image	-100.00 to +100.00
4	Bottom	Cropping of the bottom of the image	-100.00 to +100.00

To crop to 4:3 in 16:9 mode

In the <Crop Mode> group, press [4:3 Crop], turning it on.

To set the operation for DME wipe crop transition execution

- 1** In the <Crop Mode> group of the Key1 DME Wipe Adjust menu, press [Crop], turning it on.
- 2** In the <Crop Mode> group, press [Crop] or [4:3 Crop] (to crop to 4:3 in 16:9 mode), turning it on.
- 3** In the <Crop Mode> group, press [Remove From Begin].

The Remove From Begin menu appears.

For subsequent operations, see step 5 of “To set the action when a DME wipe crop transition is executed” (page 474).

To set the timing of transition completion

- 1** In the <Crop Mode> group of the Key1 DME Wipe Adjust menu, press [Crop], turning it on.
- 2** In the <Crop Mode> group, press [Remove From Begin]..

For subsequent operations, see “Setting the timing of transition completion” (page 475).

Applying a border to a key DME wipe

In the <Edge> group of the Key1 DME Wipe Adjust menu, press [Border], turning it on.

For subsequent operations, use the same process as in step 4 of “Modifying the DME wipe pattern edge” (page 470).



Resizer DME Wipe Setting

Notes

- This function is supported by the MVS-8000G.
- When the screen aspect ratio is 4:3 in HD format, when the resizer DME wipe is used to shrink a video image, this is applied to the 16:9 screen including the added video on the left and right sides. Use the crop function as required to extract the 4:3 image.

Relation between DME wipes and other effects

The following relations hold between a resizer DME wipe and other effects.

Relation to processed keys

It is not possible to select a resizer DME wipe for a key with processed key enabled.

Relation to resizer

It is not possible to use a resizer DME wipe for a key with resizer enabled. It is not possible to use a resizer DME wipe for a key forming a pair with a key with the dual resizer effect enabled. The key combinations forming pairs are keys 1 and 2, and keys 3 and 4. For example, when a dual resizer effect is enabled for key 1, it is not possible to use a resizer DME wipe on key 2.

Making resizer DME wipe settings

- 1** In the <Pattern Select> group of the Key1 DME Wipe Adjust menu, press [1ch], turning it on.

The 1ch Pattern Select menu appears.

- 2** Select [Resizer Slide/Squeeze] or [Resizer Frame I/O].

The patterns of the selected group appear.

The wipe patterns that can be used for a resizer DME wipe are as follows.

- **Slide** (pattern numbers: 7001 to 7008)
- **Squeeze** (pattern numbers: 7021 to 7031)
- **Frame in-out** (pattern numbers: 7201 to 7208, 7221 to 7224)

- 3** Press the desired pattern to select it.

For more about resizer DME wipe modifiers, see “*Setting Independent Key Transition DME Wipe Modifiers*” (page 478).

DME Wipe Snapshots

DME Wipe Snapshot Operations With the Flexi Pad

To carry out DME wipe snapshot operations, use the Flexi Pad control block. You can save, recall and delete DME wipe snapshots using the procedures similar to the procedures for wipe snapshot operations. In DME wipe snapshot operations, use the [DME] button instead of the [WIPE] button used in wipe snapshot operations.

Notes

- A button in the memory recall section in which a DME wipe snapshot is saved shows the pattern, and lights yellow. For a user-programmable DME, the register number (*see page 483*) appears. Depending on the setting of the Setup menu (*see “Operation Settings (Operation Menu)” in Chapter 16 (Volume 2)*), you can also display a register name.
- In a simple type Flexi Pad control block, it is not possible to delete a DME wipe snapshot.

For details of the operating procedures, see “Wipe Snapshots” (page 460).

DME Snapshot Operations With the Menus

In the same way as for wipe snapshots, you can save, recall, and delete DME snapshots.

For details of the operations, see “Wipe Snapshot Operations With the Menus” (page 463).

Creating User Programmable DME Patterns

With a user programmable DME, you can use DME effects created through the use of keyframes for a transition on the switcher system.

Note the following points when creating a keyframe effect for use as a user programmable DME pattern.

Register numbers and pattern numbers

When saving a keyframe effect as a user programmable DME pattern, specify the register number that corresponds to the pattern number as shown in the following table.

Execution mode	Register number	Pattern number
One-channel mode	101 to 199	1901 to 1999
Two-channel mode	201 to 299	2901 to 2999
Three-channel mode	301 to 399	3901 to 3999

For details of registers and keyframe effects, see “Registers” (page 166) and Chapter 13 “Keyframe Effects” (Volume 2), respectively.

Keyframe effects in the global channel

When the effect with the same number as the reference channel is present on the DME global (GLBL) channel, executing the user programmable DME will also execute the effect on the global channel simultaneously.

When executing a user programmable DME, take note of whether the effect is present on the global channel.

User Programmable DME Transition Mode

To create a user programmable DME, it is necessary to set the transition mode (the way in which the effect moves). To set the transition mode, use the Key Frame >DME User PGM menu.

For details of the operating procedures, see “Transition Mode Settings for User Programmable DME” in Chapter 13 (Volume 2).

The following transition modes are available.

Channels	Transition mode	Effect group
One-channel mode	Single transition mode	Slide, Split, Door, Page turn, Page roll, Squeeze, Mirror, Sphere, Character Trail, Wave, Ripple, 2D Trans, 3D Trans, Sparkle, Split Slide
	Flip Tumble	Flip Tumble, Mosaic, Defocus
	Frame in-out	Frame in-out
	Frame in-out H ^{a)}	Frame in-out
	Frame in-out V	Frame in-out
	Picture-in-picture ^{b)}	Picture-in-picture
	Compress ^{c)}	Picture-in-picture
Two-channel mode	Dual transition mode	Slide, Squeeze, 3D Trans
	Two-channel picture-in-picture	Picture-in-picture

a) Transition according to DME wipe patterns 1202, 1203, or 1204

b) Transition according to DME wipe pattern 1201

c) Transition according to DME wipe pattern 1251

For details, see “DME Wipes” (page 72).

Note

For the following group of effects available in two-channel mode, no user programmable DME wipe patterns can be created.

Page turn, Page roll, Frame in-out, Brick

Notes on creating keyframe effects

When creating a keyframe effect to be used as a user programmable DME pattern, note the following, depending on the transition mode used.

Notes on single transition mode (one-channel mode)

- Either create the first keyframe image outside the screen area, or set the image size to zero so that it cannot be seen within the screen.
- Create the last keyframe to be a full-size image.
- In the <Transition Mode> group of the Key Frame >DME User PGM menu, select [Single].

Notes on flip tumble (one-channel mode)

- Create the first keyframe image at full size. In the <Back> group of the DME >Input/Output >Video/Key menu, depending on the direction of the rotation you want during the transition, press [H Invert] or [V Invert], turning it on.



- Create the last keyframe with the image inverted so the back side is visible, and with the size at full size.
- In the <Transition Mode> group of the Key Frame >DME User PGM menu, select [Flip Tumble].

Notes on frame in-out (one-channel mode)

Create a minimum of three keyframes.

- Either create the first keyframe image outside the screen area, or set the image size to zero so that it cannot be seen within the screen.
- Create the first transition to end such that the image can be seen within the screen. At this point, press the [PAUSE] button in the keyframe control block, turning it on, to set a pause for the keyframe.
- Either create the last keyframe image outside the screen area, or set the image size to zero so that it cannot be seen within the screen.
- In the <Transition Mode> group of the Key Frame >DME User PGM menu, select [FRAME I/O].

Notes on Frame in-out H (one-channel mode)

Create a minimum of three keyframe points.

- Either create the first keyframe image outside the screen area, or set the image size to zero so that it cannot be seen within the screen.
- As the state after completion of the first transition, move the image horizontally to make it visible within the screen. At this time, press the [PAUSE] button in the keyframe control block, turning it on, to set a pause for the keyframe.
- For the last keyframe move the image horizontally to place it outside the screen area or set the image size to zero, so that the image is not visible within the screen.
- In the <Transition Mode> group of the Key Frame >DME User PGM menu, select [FRAME I/O H].

Notes on frame in-out V (one-channel mode)

Create a minimum of three keyframe points.

- Either create the first keyframe image outside the screen area, or set the image size to zero so that it cannot be seen within the screen.
- As the state after completion of the first transition, move the image vertically to make it visible within the screen. At this time, press the [PAUSE] button in the keyframe control block, turning it on, to set a pause for the keyframe.
- For the last keyframe move the image vertically to place it outside the screen area or set the image size to zero, so that the image is not visible within the screen.
- In the <Transition Mode> group of the Key Frame >DME User PGM menu, select [FRAME I/O V].

Notes on picture-in-picture (one-channel mode)

Create a minimum of three keyframes.



- Either create the first keyframe image outside the screen area, or set the image size to zero so that it cannot be seen within the screen.
- Create the first transition to end such that the image can be seen within the screen. At this point, press the [PAUSE] button in the keyframe control block, turning it on, to set a pause for the keyframe.
- Either create the last keyframe image outside the screen area, or set the image size to zero so that it cannot be seen within the screen.
- In the <Transition Mode> group of the Key Frame >DME User PGM menu, select [P In P].

Notes on compress (one-channel mode)

Create a minimum of three keyframe points.

- Create the first keyframe with the image at full size.
- In the state at completion of the first transition, create the image to be visible within the screen. At this time, press the [PAUSE] button in the keyframe control block, turning it on, to set a pause for the keyframe.
- For the last keyframe, once again set the image size to full size.
- In the <Transition Mode> group of the Key Frame >DME User PGM menu, select [Compress].

Notes on dual transition mode (two-channel mode)

- Create the first keyframe for each channel as follows.
Channel 1: create the image full-size.
Channel 2: either create the image outside the screen area, or set the image size to zero so that it cannot be seen within the screen.
- Create the last keyframe for each channel as follows.
Channel 1: either create the image outside the screen area, or set the image size to zero so that it cannot be seen within the screen.
Channel 2: create the image full-size.
- In the <Transition Mode> group of the Key Frame >DME User PGM menu, select [Dual].

Notes on picture-in-picture (two-channel mode)

Create a minimum of three keyframes.

- Create the first keyframe for each channel as follows.
Channel 1: create the image full-size.
Channel 2: since the priority is low, it will not be visible on the screen, so no particular restrictions apply.
In the Global Effect >Ch1 to Ch4 >Combiner menu, when setting the priority of channel 1 and channel 2, set the channel 1 priority higher.
- In the intermediate part of the transition, create the two images so that both are visible within the screen. In the Global Effect >Ch1 to Ch4 >Combiner menu, when setting the priority of channel 1 and channel 2, set the channel 2 priority higher.

Note

It is recommended to make the priority settings at a keyframe point at which the two images are not overlapping.

- During the course of a transition, there is a “dead zone” corresponding to the intermediate point of the whole effect (*see following figure*), during which the image does not change. Therefore, it is necessary to create the effect so that the image in the intermediate part of the transition is the keyframe for the mid-point of the whole effect. The range of this “dead zone” corresponds to the central one-third of the range of the transition indicator. This also applies to an auto transition.

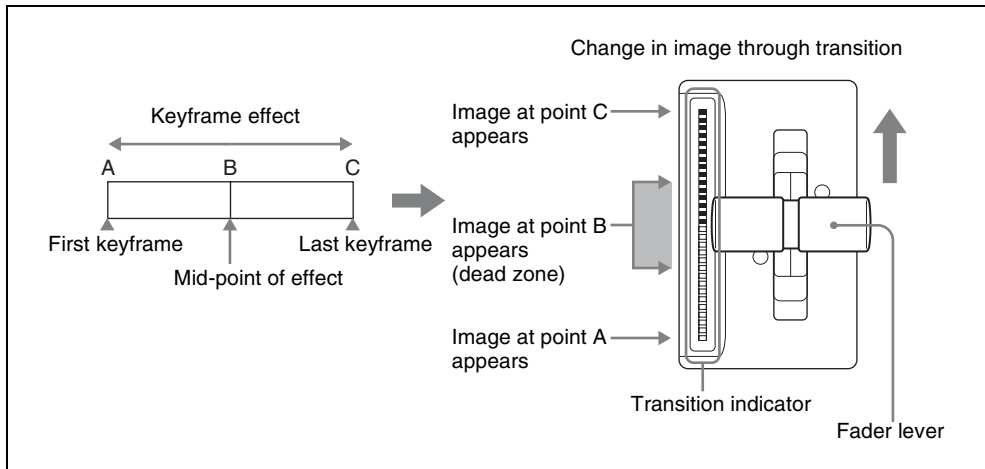

- Create the last keyframe for each channel as follows.
 - Channel 1:** since the priority is low, it will not be visible on the screen, so no particular restrictions apply.
 - Channel 2:** create the image full-size.
- In the <Transition Mode> group of the Key Frame >DME User PGM menu, select [P In P].



Chapter 7 Frame Memory

Still Image Operations	490
Preparations	490
Interpreting the Frame Memory Menu	490
Selecting an Input Image	494
Selecting Outputs and Target Frame Memory	495
Capturing an Input Image (Freeze)	496
Recalling Still Images	500
Inverting the Field Polarity of a Saved Still Image (Field Invert Function) 501	
Image Processing	502
Image Output	507
Continuously Capturing Still Images (Record)	508
Recalling a Continuous Sequence of Still Images (Animation)	509
Frame Memory Clip Operations	512
Preparations for Operation	512
Recalling Clips	512
Clip Playback	514
Clip Creation	518
Creating and Handling Frame Memory Folders	520
Clip Output	521
Recording and Playback of Ancillary Data	522
Clip Transition Operations	524
Image Data Management	527
Pair File Processing	527
Moving Files	528
Deleting Files	529
Renaming Files	530
File Backups	531
Restoring Files	531
External Hard Disk Drive Access	532
Hard Disk Formatting	533
Saving Files	533
Recalling Files	535

Still Image Operations

For an overview of frame memory concepts, see “Frame Memory” (page 85).

Notes

- During playback of a frame memory clip of the pair assigned to either of the target FM selection buttons (*see page 514*), frame memory operations may not be performed properly. Carry out frame memory operations after stopping clip playback.
- The following sections describe the operations available in the MVS-8000A system and MVS-8000G system.
The MVS-8000 system uses the same menus as those of Version 5.30. For its operating procedures, see the User’s Guide of Version 6.00 or earlier.

Preparations

Allocating the frame memory outputs (FM1 to FM8) to cross-point buttons

To output a frame memory image to a monitor, for example, the output signal from the frame memory (FM1 to FM8) must be allocated to a cross-point button. Carry out this allocation in the Setup menu.

Accessing the Frame Memory menu

Most frame memory operations are carried out using the Frame Memory menu. To access the Frame Memory menu, use either of the following procedures.

- In the menu control block, select the top menu selection button [FRAME MEM].
- Press the cross-point button to which the frame memory output is allocated twice in rapid succession.

Interpreting the Frame Memory Menu

The menu screen consists of the following principal parts.

The frame memory selection area display is the same for all except the Pattern Adjust/Pattern Select/Field Invert/File (excluding Pair Recombination menu)/Folder/External HDD menus.

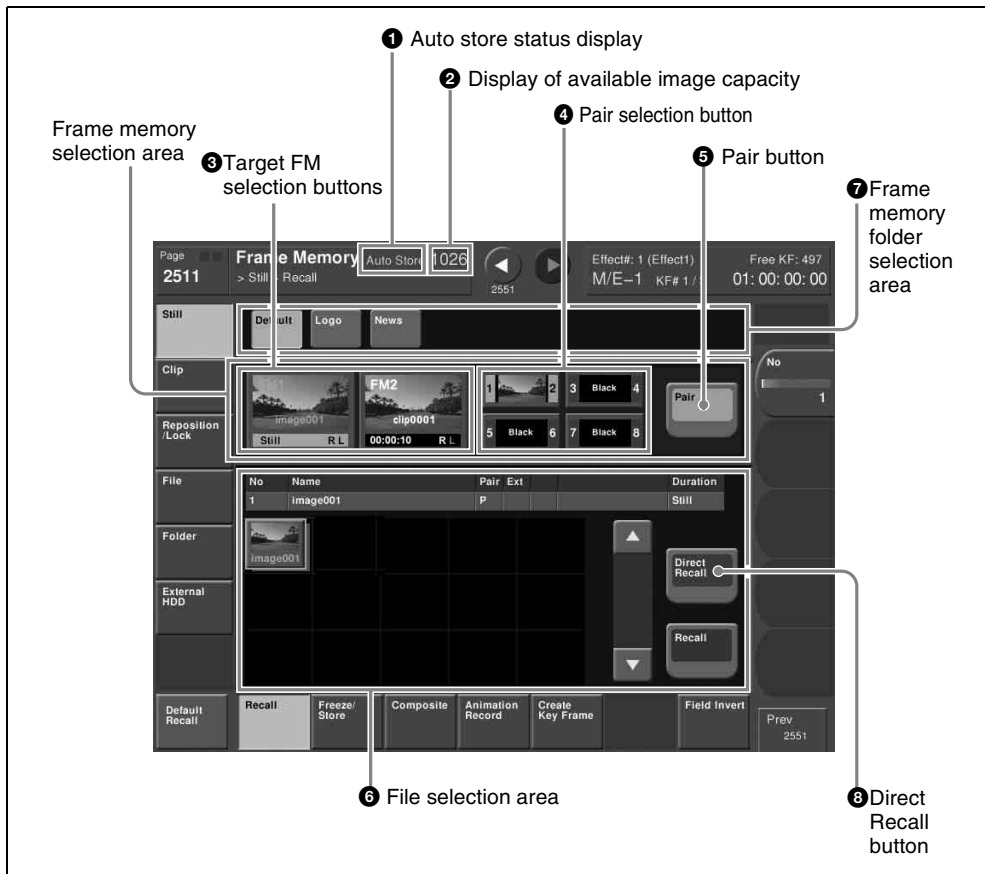

Frame Memory menu

1 Auto store status display

Depending on the setup settings, this appears when the auto store function is enabled.

2 Display of available image capacity

This shows the remaining number of frames. When no more frames can be stored, in pair mode “1” or “0” appears in red, and in single mode “0” appears in red.

The lower figure shows the remaining number of frames that can be used as extended clips.

3 Target FM selection buttons

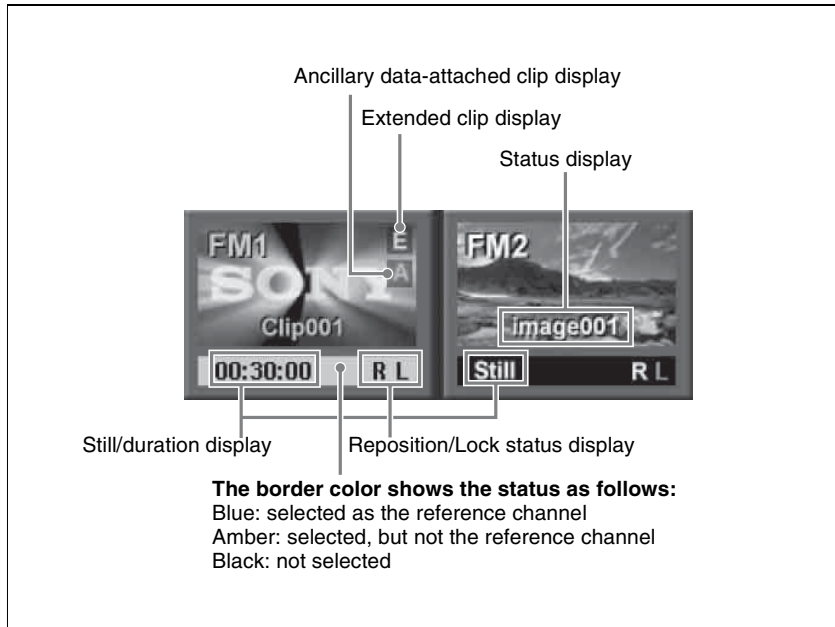

Press one of these to select which of the selected outputs (FM1 and FM2 in the example shown) the operation applies to.

The following information appears on the button.

Status display

File name (e.g. image001) and thumbnail: when a file is output

Black: when a black signal is output

Through: when the input image is output

Freeze: when a freeze is output

Composite: when a composite image is processed

Record: when continuously capturing images (record)

Still/duration display

When a still image is selected, "Still" is shown. When a clip is selected, a duration indication such as "00:00:10" is shown.

Reposition/Lock status display

This shows "R" when the reposition function (*see page 507*) is on, and shows "L" when the lock function (*see page 508*) is on.

Extended clip display

For an extended clip, an "E" appears.

Ancillary data-attached clip display

For an ancillary data attached clip, an “A” appears.

4 Pair selection button

Select the pair to be displayed in the target FM selection buttons.
(in the following figure, the pair of FM1 and FM2 is selected.)

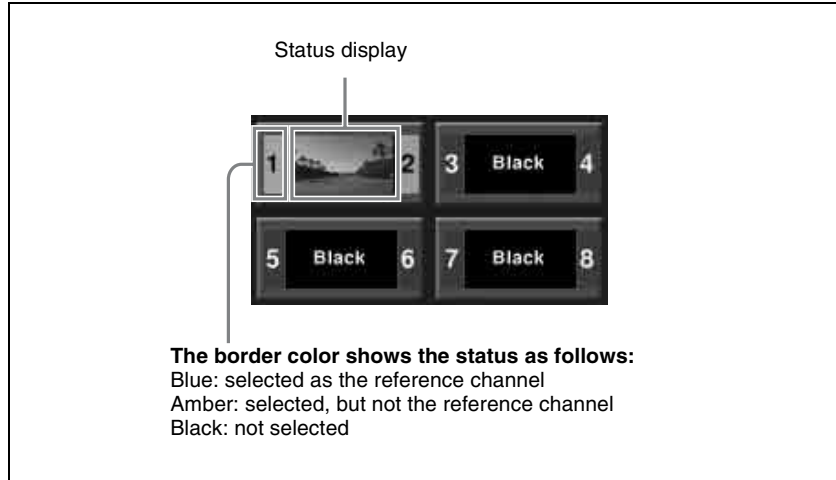

The following information appears on the button.

Status display

For a pair, shows the status for the reference.

Thumbnail: when a file is output

Black: when a black signal is output

Through: when the input image is output

Freeze: when a freeze is output

Compos: when a composite image is processed

Record: when continuously capturing images (record)

5 Pair button

Press this button, turning it on, to enable pair mode.

6 File selection area

You can select from the displayed still image files or clip files.

File information detail display



Selected file.
When a pair file is selected each press switches the front and the back.

Thumbnail indications

Still image files and clip files: Still image files are displayed as gray buttons and clip files are displayed as yellow buttons.

Single files and pair files: Single files are displayed with shadow and pair files are displayed with no shadow.

Selected file: Pale blue border. When more than one file is selected, only the first is pale blue, and the remainders are amber. If the pair file was selected, each press switches the front and the back.

File information detail display

For the selected file, this shows the file name, “P” if a pair file, “E” if an extended clip, “A” if an ancillary data attached clip, and the duration.

- 7 Frame memory folder selection area**
Select the frame memory folder to be displayed.
- 8 Direct Recall button**
Toggle on and off the direct recall mode in which pressing a thumbnail immediately recalls the file.

Selecting an Input Image

For the input image to frame memory, you can use either the signal selected on one of the two frame memory source buses or a dedicated color matte signal.

When using the signal on frame memory source bus 1 or 2 for the input image, select the signal as described below.

For the method of using a color matte signal, see “Freezing an image and writing it to memory” (page 496).

Selecting the signal on a frame memory source bus

As an example, to select a signal on frame memory source bus 1, use the following procedure.

- 1** In the auxiliary bus control block, press the AUX delegation button to which frame memory source bus 1 is allocated, turning it on.

For allocation of buses to the AUX delegation buttons, see “AUX Delegation Buttons Settings (Aux Assign Menu)” in Chapter 16 (Volume 2).

- 2** In the auxiliary bus control block cross-point buttons, select the signal to be used for the input image.

To select a signal with a key or DME effect applied on the frame memory source bus

In the key control block, press the [FM FEED] button, turning it on.

This automatically assigns the key fill and key source signals being keyed by the currently selected keyer to frame memory source buses 1 and 2.

When DME is selected on the keyer, the key fill and key source signals to which a DME effect is applied are assigned.

Selecting Outputs and Target Frame Memory

Selecting outputs (FM) and target frame memory

The following description applies to the case of settings for FM1&2, but the procedures are similar for the other cases.

- 1** In the Frame Memory menu, press one of VF1 to VF4, and select the required HF menu.

The current status of frame memory appears. (*See page 490*).

- 2** From the pair selection buttons, press the buttons corresponding to FM1 and FM2.

This assigns the signals to FM1 and FM2.

To the right of the target FM selection buttons, the FM1 and FM2 output status appears (*see page 492*).

3 If required, press [Pair], to select the FM operation mode (pair mode).

On: Operate on FM1(3, 5, 7) and FM2(4, 6, 8) as a pair.

Off: Operate on FM1(3, 5, 7) and FM2(4, 6, 8) individually.

For more details, see “Pair mode” (page 87).

Note

In the Pair Recombination menu, the [Pair] operation is not possible.

4 Press the target FM selection button [FM1] or [FM2] (*see page 492*) to select the FM operations apply to.

When [Pair] is On: Whichever of FM1 and FM2 you press, the pair is selected.

When [Pair] is Off: One of the targets must be selected. However, in the Clip >Play menu you can also select both FM1 and FM2.

Selecting a frame memory folder

Press a button in the frame memory folder selection area (*see page 494*).

By pressing [More] to switch the display, you can select from a maximum of 12 folders.

Thumbnails of the files within the selected folder appear.

Capturing an Input Image (Freeze)

Freezing an image and writing it to memory

To freeze the signal selected as input material, and write it to memory, use the following procedure.

1 In the Frame Memory menu, select VF1 ‘Still’ and HF2 ‘Freeze/Store.’

The Freeze/Store menu appears.

2 Select the target frame memory.

For the procedure, see “Selecting outputs (FM) and target frame memory” (page 495).

3 To enable V/K mode, press [V/K Mode] turning it on.



- 4 Press a button in the frame memory folder selection area, to select the folder to hold the freeze image.

For details of the selection method, see page 496.

Note

The folder selected here is the destination folder for writing the freeze image.

It is not possible to change the selection of this folder after the following step 5.

An orange bar appears on the selection button for the destination folder.

- 5 Press [Freeze Enable], turning it on.

The signals of frame memory source buses 1 and 2 are assigned to the pair of FMs selected in step 2, a freeze is now possible.

- 6 If necessary, make the video process settings (*see page 498*) or mask settings (*see page 499*) for application to the selected signal.

- 7 In the state in which you want to freeze, press one of the following in the <Freeze> group, to write the freeze image to temporary memory.

Frame: Freeze one frame.

Field: Freeze one field.

Off: Release the freeze, and delete the recorded freeze image.

After carrying out the freeze, to return to the state immediately before the freeze, press [Undo] in the <Freeze> group.

Notes

- All freeze images written to temporary memory are lost when the system is powered off.
- If you change the frame memory to use as in step 2 before saving the freeze images written to temporary memory, all the freeze images in temporary memory are lost, unless the auto store function has been enabled in setup. With the auto store function enabled, the freeze images written to temporary memory are saved automatically when the frame memory selection is changed.
- For the following signal formats, a field freeze is not possible.
1080PsF/23.976, 1080PsF/24, 1080PsF/25, 1080PsF/29.97, 720P/50, 720P/59.94

Saving a freeze image

To save a captured still image in a file, use the following procedure in the Still >Freeze/Store menu.

- 1** Press [Store].
The keyboard window (*see page 331*) appears.
- 2** In the keyboard window, enter the file name (maximum 8 characters).

Note

The following names cannot be used:

CON, PRN, AUX, CLOCK\$, NUL, COM0, COM1, COM2, COM3, COM4, COM5, COM6, COM7, COM8, COM9
LPT0, LPT1, LPT2, LPT3, LPT4, LPT5, LPT6, LPT7, LPT8, LPT9

- 3** In the keyboard window, press the [Enter] button.

This saves the still image file in memory.

The destination folder is the folder selected in step **4** of “Freezing an image and writing it to memory.”

If the entered folder name already exists, a message to confirm overwriting appears.

When the system is powered off, the file saved in memory is erased. However, you can recall a backed up file in the Frame Memory menu.

For details, see “File Backups” (page 531), and “Restoring backed up files” (page 531).

Carrying out a freeze and store simultaneously

Press [Freeze & Store], turning it on.

The system enters the freeze and store mode.

In this state, if you press [Frame] or [Field], this carries out a freeze, and simultaneously stores in a still image file.

Setting video processing

To set video processing for the signal selected on a frame memory source bus, use the following procedure in the Still >Freeze/Store menu.

- 1** In the <Video Process> group, press [Video Process], turning it on.
- 2** Use the knobs to adjust the following parameters.

Knob	Parameter	Adjustment	Setting values
1	Video Gain	Overall gain of the video signal	-200.00 to +200.00
2	Y Gain	Y signal gain	-200.00 to +200.00
3	C Gain	Chrominance signal gain	-200.00 to +200.00
4	Hue Delay	Hue delay	-180.00 to +180.00
5	Black Level	Y signal black level	-7.31 to +109.59

To return the settings to the default values, press [Unity] in the <Video Process> group.

Note

When a pair setting is active, it is coupled to the video process on/off setting, but the above parameter settings are only valid for frame memory source bus 1. The pair setting cannot be used to set the frame memory source bus 2. If you want to set video process for frame memory source bus 1 only with the pair setting when old settings for frame memory source bus 2 remain, return the frame memory source bus 2 settings to their default values. When setting video process for the frame memory source bus 2, disable the pair setting.

Setting a mask

Masks can be set separately for frame memory source buses 1 and 2. To apply a mask to the signal selected on frame memory source bus 1, for example, use the following procedure in the Still >Freeze/Store menu.

- 1** Press [Box Mask] turning it on.
- 2** Use the knobs to adjust the following parameters.

Knob	Parameter	Adjustment	Setting values
1	Top	Top position	-100.00 to +100.00
2	Left	Left position	-100.00 to +100.00
3	Right	Right position	-100.00 to +100.00
4	Bottom	Bottom position	-100.00 to +100.00

- 3** To link the masks on frame memory source buses 1 and 2, press [Mask Link], turning it on.

Recalling Still Images

Recalling a still image

To recall a still image file saved in memory using the thumbnails, and assign it to an FM output, use the following procedure.

- 1 In the Frame Memory menu, select VF1 'Still' and HF1 'Recall.'

The Recall menu appears.

- When [Pair] is on, only pair files (pairs of main file and sub file) are displayed.

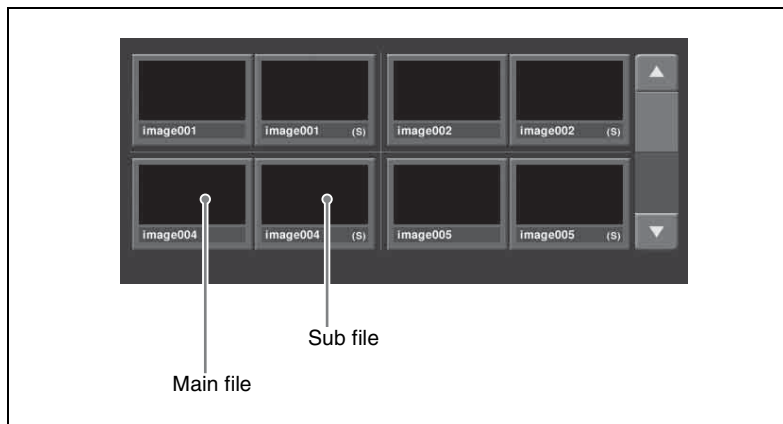

- When [Pair] is off, both single files and pair files appear.

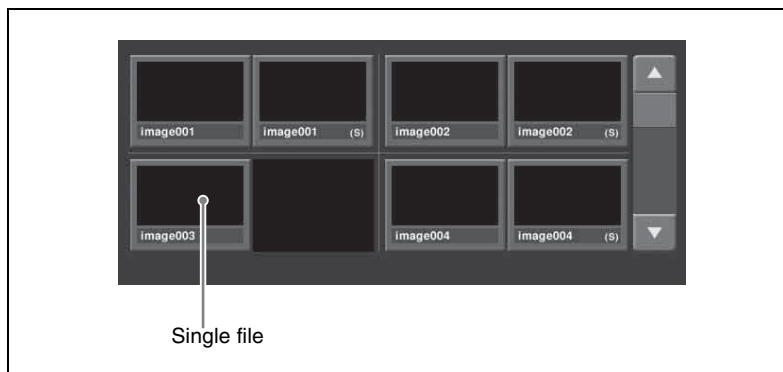

- 2 In the frame memory selection area, select the FM to be assigned. (See page 495.)

- 3 If [Direct Recall] is on, press and turn it off.
- 4 Select the desired folder in the folder selection area.
By pressing [More] to switch the display, you can select from a maximum of 12 folders.

Thumbnails of the files within the selected folder appear.

- 5 Using the arrow keys or turning the knob, scroll the file thumbnail display.

Knob	Parameter	Adjustment	Setting values
1	Scroll	Thumbnail display scrolling	1 and upwards

- 6 Press the thumbnail of the clip you want to recall.

- 7 Press [Recall].

This recalls the still image file, which is assigned to the FM you selected in step 2.

To recall in direct recall mode

Direct recall means that pressing a thumbnail immediately recalls the file. In this mode, only the front thumbnail file is recalled.

- 1 In step 7 above, instead of pressing [Recall], press [Direct Recall].
- 2 Press the thumbnail for the file you want to recall.

This immediately recalls the file.

To display the subsidiary file in front

With the direct recall mode on, press [Sub Display], turning it on.

Inverting the Field Polarity of a Saved Still Image (Field Invert Function)

Note

This function is valid when the signal format is HD (excluding 720P). However, it is not valid if the frame memory saving mode is set to “save with ancillary data.”



To invert the field polarity of a saved still image

- 1 In the Frame Memory >Still menu, press HF7 'Field Invert.'

The Field Invert menu appears.

This automatically switches pair mode off, and the status area shows thumbnails of all images currently saved in frame memory.

- 2 Press the arrow keys or turn the knob to scroll the thumbnail display.

Knob	Parameter	Adjustment	Setting values
1	Scroll	Scroll thumbnail display	1 and upwards

- 3 Select the thumbnail of the still image on which you want to carry out field inversion. You can also select more than one image.
To select all still images, press [Select All].

The file names for the selected still images appear in reverse video.

To cancel the selection, press once more, returning to the normal display.

The last still image selected is automatically recalled, and a pale blue border appears around the thumbnail.

You can now select thumbnails while checking the still images.

- 4 To carry out field inversion, press [Field Invert].

Field inversion starts, and a popup window shows the progress of the operation.

Note

When the system is powered off, files held in memory are lost, but backed-up files can be recalled in the Frame Memory menu.

For details, see "File Backups" on page 531 and "Restoring Files" on page 531.

Image Processing

Combining the background image and input signal

- 1 In the Frame Memory menu, select VF1 'Still' and HF3 'Composite.'

The Composite menu appears.

- 2 In the frame memory selection area, select the FM to be assigned. (*See page 495.*)
- 3 To select V/K mode, press [V/K Mode], turning it on.
- 4 Press a button in the frame memory folder selection area, to select the folder to hold the freeze image.

For details of the selection method, see page 496.

Note

The folder selected here is the destination folder for writing the freeze image.

It is not possible to change the selection of this folder after the following step 5.

An orange bar appears on the selection button for the destination folder.

- 5 Press [Edit Enable], turning it on.

The signals of frame memory source buses 1 and 2 are assigned to the pair of FMs selected in step 2, and the combining of the background signal (the signal providing the background for combination) and the input signal (the signal providing the foreground for combination) is now possible.

Note

The input signal is lowered by one line, but when you apply a freeze, the freeze image is returned to the correct position.

- 6 To use a color matte signal for the input signal, press [Frgd Color], turning it on.
Even when pair mode is enabled, you can make separate settings for each FM.
- 7 Turn the knobs to adjust the following parameters.

Knob	Parameter	Adjustment	Setting values
1	Luminance	Luminance	0.00 to 100.00
2	Saturation	Saturation	0.00 to 100.00
3	Hue	Hue	359.99 to 0.00

- 8 If you turned [Frgd Color] off in step 6, if required press [Input Adjust] to display the Input Adjust menu, and make the video process (*see page 498*) and mask (*see page 499*) settings for the input signal.

9 To set the background signal to black, press [Bkgd Black], turning it on.

Notes

- When the background signal is originally black, [Bkgd Black] remains on.
- When the background signal is a freeze image (an image frozen, but not saved), turning [Bkgd Black] on erases the unsaved freeze image and, as a result, [Bkgd Black] remains on.

10 In the <Type> group, set the type of combination (*see page 505*).

11 In the state in which you want to freeze, press one of the following in the <Freeze> group, to write the freeze image to temporary memory.

Frame: Freeze one frame.

Field: Freeze one field.

Off: Release the freeze, and delete the recorded freeze image.

After carrying out the freeze, to return to the state immediately before the freeze, press [Undo] in the <Freeze> group.

Notes

- All freeze images written to temporary memory are lost when the system is powered off.
- If you change the frame memory to use as in step **2** before saving the freeze images written to temporary memory, all the freeze images in temporary memory are lost, unless the auto store function has been enabled in setup. With the auto store function enabled, the freeze images written to temporary memory are saved automatically when the frame memory selection is changed.
- For the following signal formats, a field freeze is not possible.
1080PsF/23.976, 1080PsF/24, 1080PsF/25, 1080PsF/29.97, 720P/50, 720P/59.94

Saving a processed freeze image

To save a processed freeze image as a file, in the Still >Composite menu use the following procedure.

1 Press [Store].

The keyboard window appears.

2 In the keyboard window, enter the file name (maximum eight characters).

3 In the keyboard window press [Enter].



This saves the freeze image as a still image file in memory.
 The destination folder is the folder selected in step 4 of “Combining the background image and input signal” (page 502).
 If the entered folder name already exists, a message to confirm overwriting appears.

Selecting the way in which images are combined

To select the way in which the background image and input signal are combined (see page 90), use the following procedure.

- 1 In the <Type> group of the Still >Composite menu, select one of the following methods of combination.
 - **Pattern Key:** pattern key
 - **Ext Key:** external key
 (This can only be selected when the pair mode is enabled. The signal selected on the frame memory source 2 bus is used as the key signal.)
 - **Mix:** mix
 - **Nam:** non-additive mix
 If none of the above is selected, image combination is not carried out.

- 2 Depending on the selection in step 1, set the following parameters.

- When [Pattern Key] is selected

Knob	Parameter	Adjustment	Setting values
1	Size	Size of pattern	0.00 to 100.00
2	Soft	Edge softness of pattern	0.00 to 100.00
3	Pattern	Pattern number	1 to 24 ^{a)}

a) The patterns are the same as for a standard wipe. See “Wipe Pattern List” in Appendix (Volume 1) (page 560).

- When [Ext Key] is selected

Knob	Parameter	Adjustment	Setting values
1	Clip	Reference level for key signal generation	+109.59 to -7.31
2	Gain	Key sensitivity	-100.00 to +100.00

- When [Mix] is selected

Knob	Parameter	Adjustment	Setting values
1	Mix Rate	Mix proportion	0.00 to 100.00

3 When you selected a pattern key, press [Pattern Adjust].

The Pattern Adjust menu appears. In the menu, set the pattern modifiers as required.

• When turning [Position] on and setting the pattern position

Knob	Parameter	Adjustment	Setting values
1	Position H	Horizontal position	-100.00 to +100.00 ^{a)}
2	Position V	Vertical position	-100.00 to +100.00 ^{a)}

a) See page 65.

• When turning [Multi] on and replicating the pattern

Knob	Parameter	Adjustment	Setting values
1	H Multi	Number of repetitions of pattern horizontally	1 to 63
2	V Multi	Number of repetitions of pattern vertically	1 to 63
3	Invert Type	Replication layout	1 to 4 ^{a)}

a) See page 68.

• When turning [Aspect] on and setting the aspect ratio of the pattern

Knob	Parameter	Adjustment	Setting values
1	Aspect	Aspect ratio	-100.00 to +100.00 ^{a)}

a) See page 67.

• When turning [Rotation Angle] on and inclining the pattern

Knob	Parameter	Adjustment	Setting values
1	Angle	Angle of pattern rotation	-100.00 to +100.00 ^{a)}

a) See page 66.

To select the pattern, display the Pattern Select menu by pressing [Pattern Select] in the Pattern Adjust menu. You can change the pattern selected in step **2** here. After selecting one of the patterns (standard wipe patterns 1 to 24) displayed in the Pattern Select menu, you can adjust the following parameters.

Knob	Parameter	Adjustment	Setting values
1	Size	Pattern size	0.00 to 100.00
2	Soft	Edge softness	0.00 to 100.00



- 4 When you selected a pattern key or external key, if required press [Key Invert] in the Still >Composite menu to invert the key.

Image Output

There are two functions related to image output: the reposition function for moving the output image, and the lock function for fixing the output image.

For an overview of the image output, see page 90.

Moving the output image (reposition function)

- 1 In the Frame Memory menu, select VF3 'Reposition/Lock' and HF1 'Reposition.'
The Reposition menu appears. In this menu, you can also enable the V/K mode (*see page 496*).
- 2 In the frame memory selection area, select the FM output. (*See page 495*.)
- 3 In the <Reposition> group, select the movement mode (*see page 90*).
Normal: Move in normal mode.
Black&White: Move in black & white mode.
- 4 With the knobs, adjust the parameters to move the image.

Knob	Parameter	Adjustment	Setting values
1	Position H	Move in horizontal direction	-200.00 to +200.00 ^{a)}
2	Position V	Move in vertical direction	-200.00 to +200.00 ^{a)}

a) See page 65.

The surroundings of the moved image on the screen are filled with black.

- 5 To return the image moved by the reposition function to the center position, in the <Reposition> group press [Center].

Note

It is not possible to write the image moved by the reposition function directly to frame memory.

Fixing the output image selection (lock function)

- 1** In the Frame Memory menu, select VF3 ‘Reposition/Lock’ and HF2 ‘Lock.’
The Lock menu appears.
- 2** In the frame memory selection area, select the FM output. (*See page 495.*)
- 3** Press [Lock], turning it on.
This fixes the currently selected frame memory output image.
To release the lock, set [Lock] to off.

Continuously Capturing Still Images (Record)

Continuously freezing input images and writing to memory

- 1** In the Frame Memory menu, select VF1 ‘Still’ and HF4 ‘Animation Record.’
The Animation Record menu appears.
- 2** Select the desired frame memory.
For details of the operating procedures, see “Selecting outputs (FM) and target frame memory” (page 495).
- 3** To use V/K mode, press [V/K Mode], turning it on.
- 4** Press a button in the frame memory folder selection area, to select the folder to hold the freeze image.
For details of the selection method, see page 496.

Note

The folder selected here is the destination folder for writing the freeze image.
It is not possible to change the selection of this folder after the following step **5**.

An orange bar appears on the selection button for the destination folder.

- 5** Press [Record Enable], turning it on.

The signals of frame memory source buses 1 and 2 are assigned to the pair of FMs selected in step **2**, the recording function is now possible.

6 Input the file name if required.

Pressing [File Name] displays the keyboard window and you can enter the first character string (up to four characters) of the file name.

7 Set the recording time if required.

Pressing [Duration] displays the numeric keypad window, in which you can enter the recording time in the form of timecode.

If you set the recording time to zero, this uses all frame memory in which storing is possible for recording.

8 If required, set video processing for the selected signal.

For details of the operating procedures, see “Setting video processing” (page 498).

9 Press [Record], to start recording.

When the recording time is set, recording stops once the time has elapsed.

10 Press [Stop] to stop recording.

Even if the recording time is set, you can still stop recording before the set time has elapsed.

Recalling a Continuous Sequence of Still Images (Animation)

To recall a continuous sequence of still images, create an effect in the user region with the still image files as a keyframe, and run the created effect.

Note

With the 720P format, you can continuously recall images using the frame memory in units of two frames only.

Creating an effect with still image files as a keyframe

1 In the Frame Memory menu, select VF1 ‘Still’ and HF5 ‘Create Key Frame.’

The Create Key Frame menu appears.

- A thumbnail appears for each group of files having the same characters, except for the last three characters, in the file name.
- When [Pair] is on, only pair files (each pair comprising a main file and a sub file) appear.
- When [Pair] is off, both single files and pair files all appear.

2 In the frame memory selection area, select the frame memory to be assigned.

This creates the effect in the user region to which the selected frame memory is assigned.

For details of the operating procedures, see “Selecting outputs (FM) and target frame memory” (page 495).

3 Select the desired folder in the folder selection area.
By pressing [More] to switch the display, you can select from a maximum of 12 folders.

Thumbnails of the files within the selected folder appear.

4 Turn the knob to select the register number in the user region.

Knob	Parameter	Adjustment	Setting values
5	Register	Effect register number	1 to 99

Note

To search for an empty register in the user region, use the numeric keypad control block (*see step 3 of “Recalling a Register” in Chapter 13 (Volume 2)*).

5 Use the arrow keys or turn the knobs to scroll the thumbnail display of the files.

Knob	Parameter	Adjustment	Setting values
1	Scroll	Thumbnail display scrolling	1 and upwards

6 Select the thumbnail of the files to be used for the keyframe.

7 If necessary, turn the knob to check the animation effect in the thumbnail display.

Knob	Parameter	Adjustment	Setting values
3	Viewer	Animate thumbnail display of files	00:00:00 and upwards



8 Using the region selection buttons in the numeric keypad control block, select one of the regions (User1 to User8) to which the frame memory output signals have been assigned.

9 Carry out either of the following.

- To clear the effect register selected in step **4**, and create a new effect: press [Create Key Frame].
- To add to the end of the effect register selected in step **4**, press [Append Key Frame].

A confirmation message for creating the effect appears.

If there is an inappropriate condition for creating the effect, an error message appears.

For details of error messages, see “Error Messages” in the Appendix (Volume 2).

10 Press [OK].

This creates the effect in the selected user region register.

To cancel creating the effect

Press [Cancel].

Notes

- The effect is built with the selected files, in increasing order of the last three characters of the file name. If you do not want to include some of these files in the effect, first delete or rename them.
- A maximum of 99 keyframes can be included in a single effect.

Recalling a sequence of still images

Run the effect created by the foregoing procedure.

The procedure for doing this is the same as for any other effect.

For details, see “Executing Effects” in Chapter 13 (Volume 2).

Frame Memory Clip Operations

For an overview of frame memory clip concepts, see “Frame Memory Clip Function” (page 92).

Notes

- The frame memory clip function is supported on the MVS-8000A/8000G only.
- During playback of a frame memory clip of the pair assigned to either of the target FM selection buttons (*see page 514*), frame memory operations may not be performed properly. Carry out frame memory operations after stopping clip playback.

Preparations for Operation

The preparations for using a frame memory clip (hereafter, a “clip”) are the same as for a still image operation. *See “Preparations” (page 490) and “Selecting Outputs and Target Frame Memory” (page 495).*

Recalling Clips

Recalling a clip

You can recall a clip from each of frame memories 1 to 8.

- 1** In the Frame Memory menu, select VF2 ‘Clip’ and HF1 ‘Recall.’

The Recall menu appears. (*See following figure*)

- When [Pair] is set to On, only pair files (sets of main file and sub file) are shown.
- When [Pair] is set to Off, both of single files and pair files are shown.



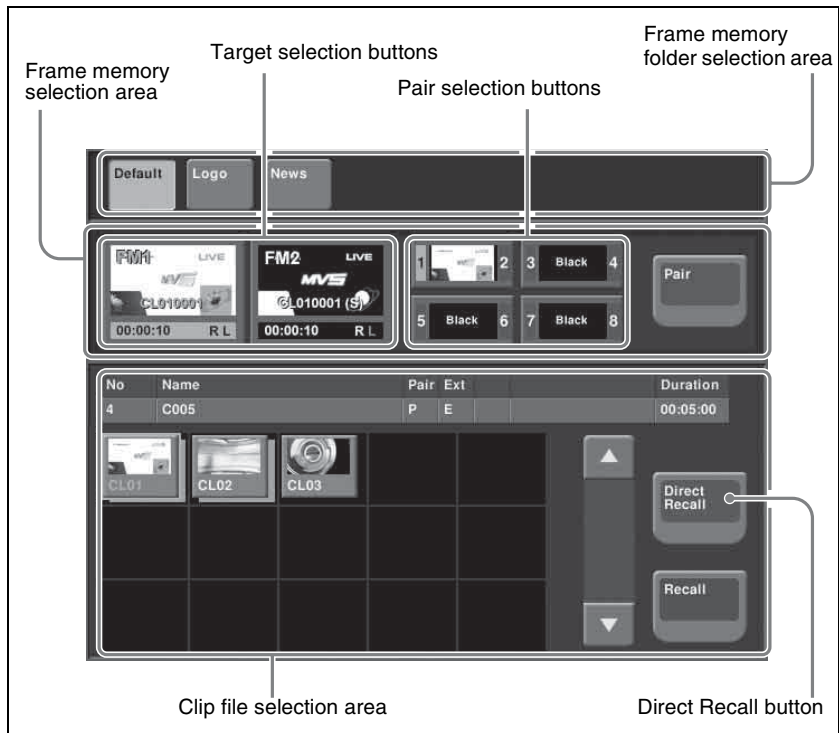

- 2 In the frame memory selection area, select an assigned target FM. (See page 495)

Note

For the MVS-8000A, if other than FM1 and FM2 is selected, extended clips are not displayed.

- 3 If [Direct Recall] is on, press the button, turning it off.
- 4 In the folder selection area, select the desired folder.

By pressing [More] to switch the displays, you can select from a maximum of 12 folders.

Thumbnails of the files within the selected folder appear.

- 5 Using the arrow keys or turning the knob, scroll the file thumbnail display.

Knob	Parameter	Adjustment	Setting values
1	Scroll	Thumbnail display scrolling	1 and upwards

6 Press the thumbnail of the clip you want to recall.

7 Press [Recall].

This recalls the clip file, which is assigned to the FM you selected in step **2**. In pair mode, if a clip is selected, the main file is output to FM1, and the sub file to FM2. In single mode, when only one of FM1 and FM2 is selected, the front file on the thumbnail is output.

To recall in direct recall mode

Direct recall means that pressing a thumbnail immediately recalls the file. In this mode, only the front thumbnail file is recalled.

1 In step **7** above, instead of pressing [Recall], press [Direct Recall].

2 Press the thumbnail for the file you want to recall.

This immediately recalls the file.

To display the subsidiary file in front

With the direct recall mode on, press [Sub Display], turning it on.

Clip Playback

You can play a recalled clip by a menu operation or by using the device control block.

Note

With a pair file recalled, it is possible to set [Pair] to Off and carry out a single file operation, but if you then set [Pair] to On again, the output of frame memory may be black. In such cases it is necessary to recall the pair file once more.

Playing a clip using the menu

1 In the Frame Memory menu, select VF2 'Clip' and HF2 'Play.'

The Play menu appears. The status of the clip shown in the current target FM selection buttons appears here.

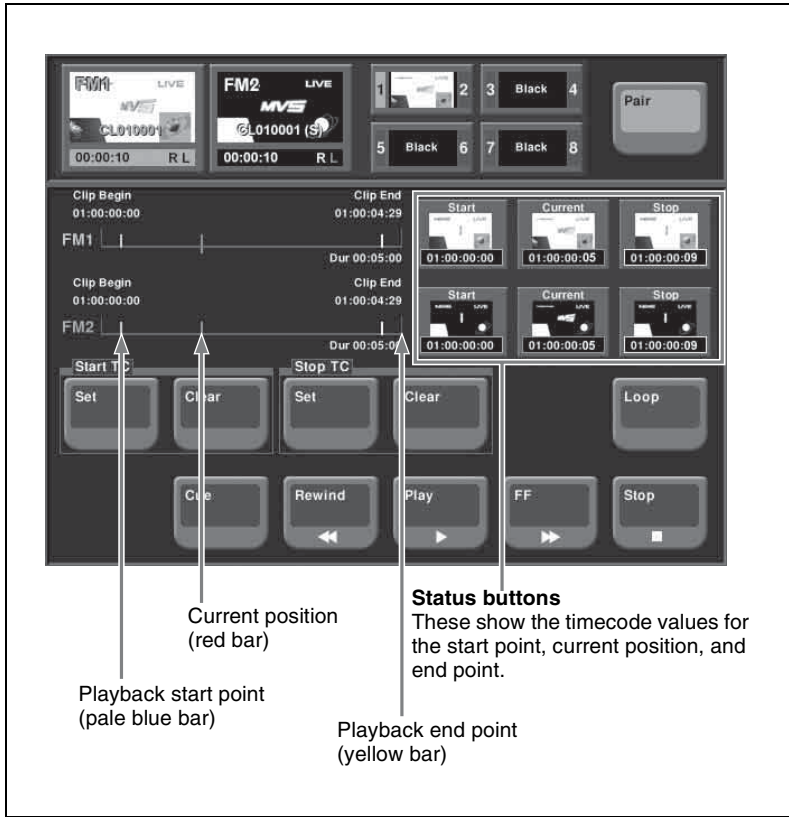

- 2** When [Pair] is Off, press a target FM selection button to select the target.
- 3** To set loop playback, press [Loop], turning it on.
- 4** To start playback, press [Play]. During playback, to stop, press [Stop].

To cue up

Press [Cue].

To play the image at the beginning of the clip (Clip Begin)

Press [Rewind].

To play the image at the end of the clip (Clip End)

Press [FF].

To specify the playback start point

To set the current position as the playback start point, in the <Start TC> group, press [Set]. To set a different position, press the [Start] status button, and enter a timecode value from the numeric keypad window.

To specify the playback stop point

Start playback, and at the desired position press the [STOP] button to stop playback, then in the <Stop TC> group, press [Set]. To set to any position, press the [Stop] status button, and enter a timecode value from the numeric keypad window.

To change the current position

To change the current position, press the [Current] status button, and enter a timecode value from the numeric keypad window.

Using the device control block (search dial) to play back clips

Carry out the following operation with the device control block (search dial).

Note

A frame memory clip must first be recalled with a menu operation.

- 1 With the device selection buttons, select the frame memory clip to be played (FM1 CLIP to FM8 CLIP).

If the pair mode is on, both main and subsidiary FMs light.

- 2 Press the [PLAY] button, turning it on.

To stop playback, press [STOP] or any of the [SHTL], [JOG], [CUE], [REW], [FF], and [ALL STOP] buttons.

For details of the buttons in the device control block (search dial), see “Device Control Block (Search Dial)” (page 278) in Chapter 2.

To specify the playback start point

To make the current position the playback start point, press the [START TC] button. To set a different position, press the [SET START TC] button, then enter the timecode from the numeric keypad control block.

To specify the duration

Press the [SET DUR] button, and enter a timecode from the numeric keypad control block. If the playback start point is already set, this automatically sets the playback stop point. If the playback stop point is already set, this automatically sets the playback start point. (The duration setting is not displayed in the device control block.)



To specify the playback stop point

Start playback, and at the desired position press the [STOP] button to stop playback, then press the [STOP TC] button. To set to any position, press the [SET STOP TC] button, and enter a timecode from the numeric keypad control block.

To carry out the variable speed playback

Use the search dial.

For details on using the search dial, see “Controlling the Tape/Disk Transport” in Chapter 12 (Volume 2).

To apply a loop to a frame memory clip

Press the [LOOP] button.

Using the device control block (trackball) or device control block (joystick) to play back clips

Carry out the following operation with the device control block (trackball) or device control block (joystick).

Note

A frame memory clip must first be recalled with a menu operation.

- 1 Press the [DEV] button in the region selection buttons, and select the frame memory clip for playback (FM1 CLIP to FM8 CLIP).

If the pair mode is on, both main and subsidiary FMs light.

- 2 Press the [PLAY] button, turning it on.

To stop playback, press [STOP] or any of the [SHTL], [JOG], [CUE], [REW], [FF], and [ALL STOP] buttons.

For details of the buttons in the device control block (trackball) or device control block (joystick), see “Device Control Block (Trackball)” (page 271) in Chapter 2.

For details of the playback start point, stop point, and duration settings, see the previous item, “Using the device control block (search dial) to play back clips” (page 516).

To carry out the variable speed playback

Press any of the [SHTL], [JOG], and [VAR] buttons, then turn the Z-ring or move the joystick. The image changes in the forward direction when you turn the Z-ring clockwise, and in the reverse direction when you turn it

counterclockwise. Move the joystick to the right for the forward direction and to the left for the reverse direction.

When you pressed the [JOG] button: Playback is at a speed corresponding to the turning speed of the Z-ring or the movement speed of the joystick.

When you pressed the [SHTL] button: Playback is at a speed corresponding to the rotation angle of the Z-ring or amount of movement of the joystick.

When you pressed the [VAR] button: Playback is at a speed corresponding to the rotation angle of the Z-ring or amount of movement of the joystick, in the range -1 to +3 times normal speed.

Clip Creation

You save a movie as a clip.

Note

If the number of frame memory clips exceed 100 single files (50 pair files), an error appears.

Using the menu to record clips

- 1 In the Frame Memory menu, select VF2 'Clip' and HF3 'Record.'
The Record menu appears.



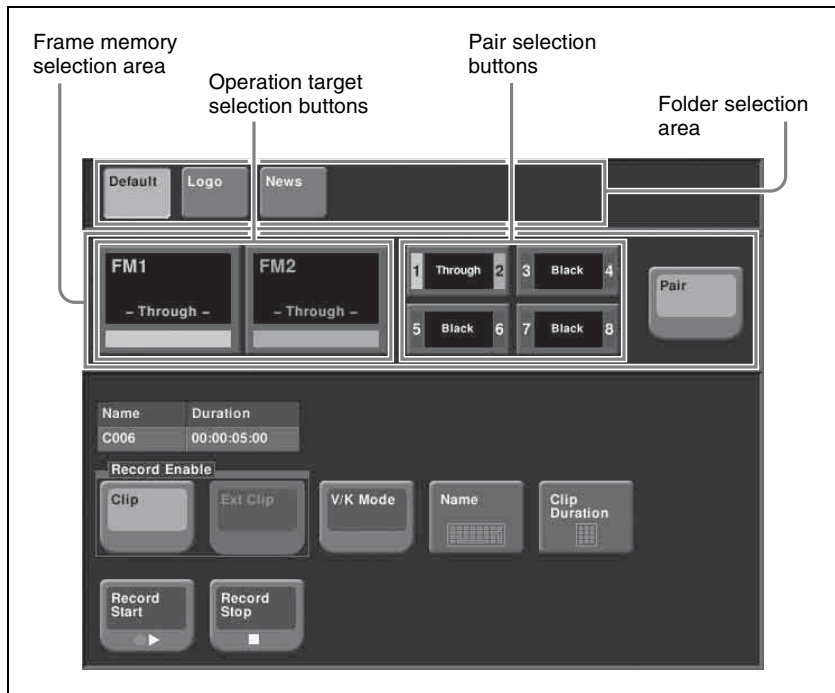

- 2** With [Pair] off, press the operation target selection button, to select the operation target.
- 3** In the folder selection area, select the folder containing the clip to be recorded.
- 4** In the <Record Enable> group, select the clip type.
 - To record a normal clip, press [Clip].
 - To record an extended clip, press [Ext Clip].
- 5** To set the clip name, press [Name].
A keyboard window appears.
- 6** Enter the clip name, and press Enter.
- 7** To start recording, press [Record Start].
- 8** To end recording, press [Record Stop].

To set the clip duration

- 1 Press [Clip Duration].
A numeric keypad window appears.
- 2 Enter a timecode value or number of frames, and press Enter.
This confirms the clip duration.

Creating and Handling Frame Memory Folders

You can create, rename, and delete frame memory folders.

Creating a new folder

- 1 In the Frame Memory menu, select VF5 'Folder.'
The Folder menu appears. The status area shows a list of the current folder settings.
- 2 Select [New].
A keyboard window appears.
- 3 Enter the folder name, and press Enter.
This confirms the folder name.

Changing the folder name

- 1 In the Frame Memory >Folder menu, select the folder with the arrow keys or by turning the knobs.

Knob	Parameter	Adjustment	Setting values
1	No.	Folder selection	1 to 12
2	Num	Number of files to select consecutively from selected file	1 to 12

- 2 Press [Rename].
A keyboard window appears.
- 3 Enter the new folder name, and press Enter.



Note

The following names cannot be used for folders:

Default, Flash1, Flash2

CON, PRN, AUX, CLOCK\$, NUL, COM0, COM1, COM2,

COM3, COM4, COM5, COM6, COM7, COM8, COM9

LPT0, LPT1, LPT2, LPT3, LPT4, LPT5, LPT6, LPT7, LPT8,

LPT9

This changes the folder name.

Deleting a folder

- 1 In the Frame Memory >Folder menu, select the folder with the arrow keys or by turning the knobs.

Knob	Parameter	Adjustment	Setting values
1	No.	Folder selection	1 to 12
2	Num	Number of files to select consecutively from selected file	1 to 12

To select all folders, select [All].

- 2 Press [Delete].
A confirmation message appears.
- 3 To carry out the deletion select [Yes], and to cancel the deletion select [No].

Note

It is not possible to delete the default folder (named “Default”).

Clip Output

As for still image operation, you can use the reposition and lock functions.

For details of the operation, see “Image Output” (page 507).

Recording and Playback of Ancillary Data

Preparations

To record ancillary data, it is first necessary in the Setup menu to select “save with ancillary data” as the frame memory saving mode (see “Saving a frame memory clip including ancillary data” in Chapter 16 (Volume 2).)

Recording ancillary data

To record ancillary data in a frame memory clip, use the Frame Memory >Clip >Record menu.

For details of the operating sequence, see “Clip Creation” (page 518).

To check ancillary data during recording

If the ancillary data to be recorded is embedded audio, by first setting the signal output to through mode, you can listen while recording.

For the method of setting the signal output to through mode, see “Signal Output Settings (Output Menu)” in Chapter 16 (Volume 2).

Note

For [Freeze Enable] or [Record Enable], in the <Record Enable> group, pressing [Clip] or [Ext Clip] to turn them on or off may result in noise. Also, with these buttons in the On state, selecting the signal on the frame memory source bus may result in noise.

Playing back ancillary data

You can play ancillary data recorded in a frame memory clip by normal playback or an auto transition of the clip transition.

To play the ancillary data, you must use the following procedure to enable playback of the ancillary data. For the subsequent playback operation, see “Clip Playback” (page 514).

Notes

- After recording a frame memory clip, the ancillary data state is enabled for playback.
- To play back the clip, set the signal output to through mode. For the method of setting through mode, see “Signal Output Settings (Output Menu)” in Chapter 16 (Volume 2).
- When the reposition function is on, ancillary data cannot be played back.
- Switching reposition function between on and off may cause noise.
- Only the AUX bus and edit preview bus can output ancillary data.



- On the MVS-8000A playing back ancillary data is only possible for FM1, FM3, FM5, and FM7. For FM2, FM4, FM6, and FM8, ancillary data cannot be played back. On the MVS-8000G there are no such restrictions.
- For loop playback of clips in the following video formats, the loop playback range must be at least 5 frames, and set to a multiple of 5 frames.
 - 480/59.94i
 - 720/59.94P
 - 1080/59.94i
 - 1080/29.97PsF
- Recalling operations of still images or clips can cause noise.
- Carrying out file operations on a frame memory clip may result in the ancillary data being discontinuous, or in noise occurring. However, if the first or last frame of the clip is deleted, noise will not occur.
- The audio sampling frequency is always 48 kHz.
- When you play back the recorded embedded audio, depending on the device to be used, noises are produced at the playback start point and end point. For details of devices that are used for playback, contact your Sony service or sales representative.

- 1** In the Frame Memory menu, select VF2 “Clip”, HF5 “Ancillary Enable.”
- 2** Select the frame memory folder and file to be played back.
- 3** Set the [Ancillary Enable] button to On.

Clip Transition Operations

For an overview of clip transitions, see “*Frame Memory Clip Function*” (page 92).

Notes

- The clip transition function is only supported by the MVS-8000A/8000G.
- When a clip transition is selected as the transition type, if one of the wipe direction selection buttons in the transition control block is lit, it indicates the direction of clip playback.

Setting a clip transition

The following example describes the case of a clip transition using FM 1&2 Clip on the M/E-1 bank.

Note

To use a clip transition effectively, the image from the frame memory clip being played back during the clip transition should be seen in the M/E-1 program output. For example, inserting a key using frame memory output 1 and frame memory output 2.

- 1** Display the M/E-1 >Misc >Transition menu, and in the <Transition Type> group select “FM1&2 Clip.”
- 2** Press [Clip Transition].

The Clip Transition menu appears.



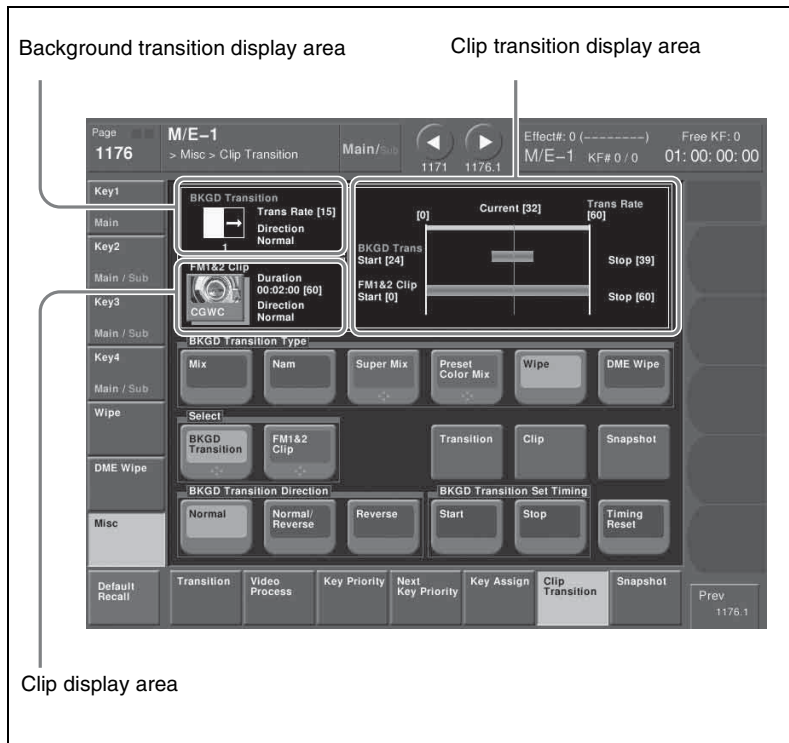

- 3 Press the [Clip] button.
The Clip menu appears, and the status area shows a list of clips.
- 4 Select the clip to use in the clip transition.
- 5 Return to the Clip Transition menu, and in the <BKGD Transition Type> group, select the background transition type.

Note

For details of the background transition selected here, see the various adjustments in the M/E-1 >Misc >Transition menu.

- 6 In the <Select> group, press [BKGD Transition].
- 7 Use either of the following methods to set the background transition start point independently of the clip playback timing.
 - Move the fader lever to the desired position, and in the <BKGD Transition Set Timing> group press [Start].

- Turn knob 1 to set the number of frames. (The left end of the reference axis (see following figure) is the position of frame 0.)

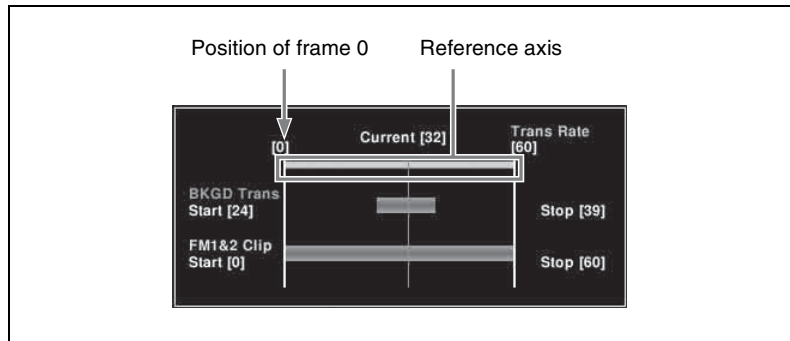

8 Using either of the following methods, set the end point of the background transition.

- Move the fader lever to the desired position, and in the <BKGD Transition Set Timing> group press [Stop].
- Turn knob 2 to set the number of frames.

9 If Wipe or DME Wipe is selected in the <BKGD Transition Type> group, in the <BKGD Transition Direction> group, select the background transition direction.

10 In the <Select> group, press [FM 1&2 Clip].

11 Using either of the following methods, set the start point of the clip.

- Move the fader lever to the desired position, and in the <Clip Transition SetTiming> group press [Start].
- Turn knob 1 to set the number of frames. (The left end of the reference axis (see following figure) is the position of frame 0.)

Note

It is not possible to set the end point.

12 In the <Clip Transition Direction> group, select the playback direction of the clip.

To reset the start point and end point

Press [Timing Reset].

The background transition start point and end point, and the clip start point are all reset.

- 3** In the Frame Memory menu, select VF4 'File' and HF1 'Pair Recombination.'

The Pair Recombination menu appears.

- 4** Press [Couple].

This converts the files output to FM1 and FM2 to a pair.

Splitting a pair file into two single files

Note

Carrying out the following operation automatically switches [Pair] to Off.

The following description applies to the case of FM1 and FM2, but the procedures are similar for the other cases.

- 1** In the Frame Memory >Still >Recall menu or Frame Memory >Clip >Recall menu, recall the pair file.

- 2** In the Frame Memory menu, select VF4 'File' and HF1 'Pair Recombination.'

The Pair Recombination menu appears.

- 3** Press [Separate].

The FM1 and FM2 pair file is split into separate single files.

Moving Files

Moving files

- 1** In the Frame Memory menu, select VF4 'File' and HF5 'Move.'

The Move menu appears. The status area shows files to be moved in the upper area, and destination files in the lower area.

- 2** Select the folder which contains the file to be moved.

- 3** Using any of the following methods, select the file to be moved.

- Press the arrow keys to scroll the display.
- Press directly on the thumbnail in the status area.
- Turn the knobs.



Knob	Parameter	Adjustment	Setting values
1	No	File selection	1 and upwards
2	Num	Selection of number of files in sequence	1 and upwards

- 4** Select the destination folder and file.
- 5** Press [Move].
A message for confirming the move appears.
- 6** To confirm the move press [Yes], and to cancel press [No].

Deleting Files

Deleting files

- 1** In the Frame Memory menu, select VF4 'File' and HF5 'Delete.'
The Delete menu appears. In the status area, whether pair mode is on or off, all of the saved files appear as thumbnails.
- 2** Select the folder which contains the file to be deleted.
- 3** Using either of the following methods, select the file to be deleted. If necessary, press the arrow keys to scroll the display.
 - Press directly on the thumbnail in the status area.
 - Turn the knobs.

Knob	Parameter	Adjustment	Setting values
1	No	File selection	1 and upwards
2	Num	Selection of number of files in sequence	1 and upwards

- To delete all files, press [Select All], turning it on.
- When a clip thumbnail is selected, the still image files making up the clip are also selected for deletion.

- 4** If necessary, turn the knob to check the contents of the frame memory clip through the thumbnail display.

Knob	Parameter	Adjustment	Setting values
3	Viewer	For a movie, the current frame position. For a still image, no effect.	00:00:00 and upwards

- 5** Press [Delete].
A message for confirming the deletion appears.

- 6** To confirm the deletion press [Yes], and to cancel press [No].

Renaming Files

Renaming a file

- 1** In the Frame Memory menu, select VF4 'File' and HF6 'Rename'

The Rename menu appears. In the status area, whether pair mode is on or off, all of the saved files appear as thumbnails.

- 2** Using either of the following methods, select the file to be renamed. If necessary, press the arrow keys to scroll the display.

- Press directly on the thumbnail in the status area.
- Turn the knobs.

Knob	Parameter	Adjustment	Setting values
1	No	File selection	1 and upwards

- 3** If necessary, turn the knob check the contents of the frame memory clip through the thumbnail display.

Knob	Parameter	Adjustment	Setting values
3	Viewer	For a movie, the current frame position. For a still image, no effect.	00:00:00 and upwards

- 4** Press [Rename].

A keyboard window appears.

- 5** Enter the new name, then press [Enter] in the keyboard window.

This renames the file.



Note

The following names cannot be used:
CON, PRN, AUX, CLOCK\$, NUL, COM0, COM1, COM2, COM3,
COM4, COM5, COM6, COM7, COM8, COM9
LPT0, LPT1, LPT2, LPT3, LPT4, LPT5, LPT6, LPT7, LPT8, LPT9

File Backups

To back up a file saved in memory to hard disk, use the following procedure.

- 1** In the Frame Memory menu, select VF4 'File' and HF7 'Backup/Restore.'
The Backup/Restore menu appears.
- 2** Press [Backup].
This backs up the saved file.

Restoring Files

Restoring backed up files

To recall files backed up on the hard disk, use the following procedure.

- 1** In the Frame Memory menu, select VF4 'File' and HF7 'Backup/Restore.'
The Backup/Restore menu appears.
- 2** Press [Restore].
This recalls the backed up file.



External Hard Disk Drive Access

In an MVS-8000A system and MVS-8000G system, you can connect a hard disk drive to the IEEE1394 port of the switcher processor, and save and recall image data from frame memory.

Since image data saved in memory is lost when the system is powered off, using an external hard disk drive allows required data to be preserved.

Notes

- This function is only available on an MVS-8000A/8000G system.
- Only one hard disk drive can be connected to a single switcher processor.
- While the hard disk is being accessed, frame memory operations are not possible.
- During playback of a frame memory clip of the pair assigned to either of the target FM selection buttons (*see page 514*), frame memory operations may not be performed properly. Carry out frame memory operations after stopping clip playback.

Consult your Sony service representative or sales representative about the hard disk drives that can be connected.

Selecting the switcher

When the system is operating in Dual Simul mode, select the switcher on which to carry out formatting, file saving, and file recall operations.

For details of Dual Simul mode, see “System configuration (System Config)” (page 187).

- 1** In the Frame Memory menu, select VF6 ‘External HDD’ and HF1 ‘Format’ or HF2 ‘Backup/Restore.’

The Format menu or Backup/Restore menu appears.

- 2** In the region selection area (*see page 323*), press [SWR].

A popup window for selecting the switcher appears.

- 3** Press [SWR1] or [SWR2] to select the switcher.

The button for the selected switcher lights.

You can select two switchers simultaneously. In this case, the last operated button lights green, and the other lights amber. The menu shows the information for the switcher lit green.

4 Press [OK].

Hard Disk Formatting

When you connect a hard disk drive for the first time, it is necessary to format the hard disk. This partitions the disk, creating five logical drives (FMHDD1 to FMHDD5).

1 In the Frame Memory menu, select VF6 'External HDD' and HF1 'Format.'

The Format menu appears.

If in Dual Simul mode, select the switcher to operate (*see page 532*).

To get the hard disk drive information

In the button area press [Refresh Status].

The Model Name item shows the product information for the hard disk drive.

2 Press [Format].

A popup window for confirming formatting appears.

Note

Carrying out formatting erases any existing data on the hard disk.

3 Press [Yes].

This starts the hard disk formatting. A progress bar and numerical indication appear to show the progress of the operation.

When the operation is completed, a popup window reading "Success!!" appears.

4 Press [OK].

Saving Files

You can save all of the files from frame memory to the external hard disk drive.

Note

Before carrying out this operation for the first time, it is necessary to format the hard disk (*see previous item, "Hard Disk Formatting"*).

- 1 In the Frame Memory menu, select VF6 ‘External HDD’ and HF2 ‘Backup/Restore.’

The Backup/Restore menu appears.

If in Dual Simul mode, select the switcher to operate (*see page 532*).

To get the hard disk drive information

Press [Refresh Status].

The Model Name item shows the product information for the hard disk drive, and the names of directories within the logical drives.

- 2 Using any of the following methods, select a logical drive (FMHDD1 to FMHDD5).

- Press directly on the list to select.
- Press a button in the <Partition> group.
- Turn the knob.

Knob	Parameter	Adjustment	Setting values
1	Partition	Logical drive selection	1 to 5

- 3 Press [Backup].

A popup window for confirming file saving appears.

Note

When you save the files, all of the saved files in the logical drive is erased immediately before the saving operations.

- 4 Press [Yes].

This starts the file saving operation. If there is no directory in the logical drive, a directory is automatically created, and the files are saved within it. A progress bar and numerical indication appear to show the progress of the operation.

When the operation is completed, a popup window reading “Completed.” appears.

- 5 Press [OK].

To rename a directory

Select a directory in the list, and in the button area press [Rename].

In the keyboard window that appears, enter the new directory name, and press [Enter]. The name of a directory is limited to eight characters.

Note

The following names cannot be used:



CON, PRN, AUX, CLOCK\$, NUL, COM0, COM1, COM2, COM3, COM4,
COM5, COM6, COM7, COM8, COM9
LPT0, LPT1, LPT2, LPT3, LPT4, LPT5, LPT6, LPT7, LPT8, LPT9

Recalling Files

You can recall all of the saved files on the hard disk drive into frame memory.

- 1** Carry out steps **1** and **2** of the procedure “*Saving Files*” (page 533).

Note

It is not possible to select a directory (logical drive) on which files are not saved.

- 2** Press [Restore].

A popup window for confirming file recall appears.

Note

When you recall the files, any existing data in frame memory is lost immediately before the recalling operations.

- 3** Press [Yes].

This starts the file recall operation. A progress bar and numerical indication appear to show the progress of the operation.

When the operation is completed, a popup window reading “Completed.” appears.

- 4** Press [OK].



Chapter 8 Color Backgrounds

- Color Background Setting Operations538**
 - Color Background Settings Menu538
 - Basic Color Background Setting Operations538

Color Background Setting Operations

You carry out color background settings in the Color Bkgd menu. This section describes the settings menu for color background 1 as an example.

For an overview of the color background, see page 97.

Color Background Settings Menu

Accessing the Color Bkgd1 menu

Use either of the following operations.

- In the menu control block, select the top menu selection button [COLOR BKGD], and press VF1 ‘Color Bkgd1.’
- Press a cross-point button assigned to color background 1 twice in rapid succession.

The above operation displays the Color Bkgd1 menu.

Basic Color Background Setting Operations

Making a single-color matte (Flat Color)

If you are not using the “color mix” function to combine two colors, use the following procedure.

- 1** In the <Matte> group of the Color Bkgd 1 menu, press [Flat Color], turning it on.

You can now adjust color 1.

- 2** Set the following parameters.

Knob	Parameter	Adjustment	Setting values
1	Luminance	Luminance	0.00 to 100.00
2	Saturation	Saturation	0.00 to 100.00
3	Hue	Hue	359.99 to 0.00



Making a color combination (color mix)

To combine color 1 and color 2, use the following procedure.

- 1 In the <Matte> group of the Color Bkgd1 menu, press [Mix Color], turning it on.
- 2 Set the following parameters as required.

Knob	Parameter	Adjustment	Setting values
1	Size	Pattern size	0.00 to 100.00
2	Soft	Degree of softening of edge	0.00 to 100.00
5	Pattern	Pattern number	1 to 24 ^{a)}

a) The patterns are the same as for a standard wipe. See "Wipe Pattern List" in Appendix (Volume 1) (page 560).

You can also carry out the pattern selection by pressing the [Mix Ptn Select] button, to display the Mix Ptn Select menu. Select any pattern appearing in the Mix Ptn Select menu (standard wipe patterns 1 to 24), and you can then adjust the following parameters.

Knob	Parameter	Adjustment	Setting values
1	Size	Pattern size	0.00 to 100.00
2	Soft	Edge softness	0.00 to 100.00

- 3 To adjust color 1, set [Color 1] on, and to adjust color 2 set [Color 2] on, then adjust the parameters.

Knob	Parameter	Adjustment	Setting values
1	Luminance	Luminance	0.00 to 100.00
2	Saturation	Saturation	0.00 to 100.00
3	Hue	Hue	359.99 to 0.00

- 4 If required, set the pattern modifiers.

- When turning [Position] on and setting the pattern position

Knob	Parameter	Adjustment	Setting values
1	Position H	Horizontal position	-200.00 to +200.00 ^{a)}
2	Position V	Vertical position	-200.00 to +200.00 ^{a)}

a) See page 65.

- When turning [Multi] on and using replications of the same pattern

Knob	Parameter	Adjustment	Setting values
1	H Multi	Number of repetitions of pattern horizontally	1 to 63
2	V Multi	Number of repetitions of pattern vertically	1 to 63
3	Invert Type	Replication layout	1 to 4 ^{a)}

a) See page 68.

- **When turning [Aspect] on and setting the aspect ratio of the pattern**

Knob	Parameter	Adjustment	Setting values
1	Aspect	Aspect ratio	-100.00 to +100.00 ^{a)}

a) See page 67.

- **When turning [Pairing] on and making a wipe pattern like a Venetian blind**

Knob	Parameter	Adjustment	Setting values
1	Width	Width of the slits	1 to 128 (integer)

- **When turning [Angle] on in the <Rotation> group and slanting the pattern**

Knob	Parameter	Adjustment	Setting values
1	Angle	Angle of pattern rotation	-100.00 to +100.00 ^{a)}

a) See page 66.

- **When turning [Speed] on in the <Rotation> group and rotating the pattern at a constant rate**

Knob	Parameter	Adjustment	Setting values
1	Speed	Rotation rate of pattern	-100.00 to +100.00 ^{a)}

a) See page 66.

- **When selecting H (horizontal) or V (vertical) in the <Modulation> group and applying waviness to the pattern**
(The modulation is always a sine wave.)

Note

When using 1080PsF mode in an HD system, the modulation function is not available.



Knob	Parameter	Adjustment	Setting values
1	Amplitude	Amplitude of modulation	0.00 to 100.00
2	Frequency	Frequency of modulation	0.00 to 100.00
3	Speed	Speed of waves	-100.00 to +100.00 ^{a)}

a) See page 70.

- 5** To interchange color 1 and color 2, press the [Color Invert] button, turning it on.





Chapter 9 Copy and Swap

Basic Copy and Swap Operations	544
Copy and Swap Menu Operations	544
Copy by Button Operation	545

Basic Copy and Swap Operations

Copy and Swap Menu Operations

There are two ways of carrying out a copy operation: by using the menus or by a simple button operation. Swap operations, and operations on DME data can only be done with a menu operation.

Accessing the Copy/Swap menu

In the menu operation section top menu selection buttons, press the [Copy/Swap] button, then press VF1 ‘Copy/Swap.’ The Copy/Swap menu appears. Here a copy/swap operation on wipe data is described by way of example, using the Copy/Swap >Wipe menu, but the same general procedure applies to all of the following menus.

- M/E: Copying and swapping M/E data
- Key: Copying and swapping key data
- Wipe: Copying and swapping wipe data
- DME Wipe: Copying and swapping DME wipe data
- Matte: Copying and swapping matte data
- Color: Copying and swapping color data
- DME: Copying and swapping data by DME channels
- Format Converter: Copying format converter data (for MVS-8000G only)

For details, see “Settings Relating to Signal Inputs (Input Menu)” in Chapter 16 (Volume 2).

*For an overview of the concepts involved, see “Copy and Swap” (page 98).
For details of color corrector copy and swap, see Chapter 19 “Color Corrector” (Volume 2).*

Copying and swapping wipe data

As an example, to copy or swap wipe data, use the following procedure.

- 1** In the Copy/Swap menu, select HF3 ‘Wipe.’

The Copy/Swap >Wipe menu appears.

The status area shows lists for the copy/swap source on the left, and the copy/swap destination on the right.

- 2** In the <Data Select> group, select either of the following.

Wipe: The operation applies to wipes in the transition control block.

Key Wipe: The operation applies to wipes in the independent key transition control block.

3 Using any of the following methods, select the data to be copied or swapped.

- Press directly on the list in the status area.
- Press the arrow keys to scroll the reverse video cursor.
- Turn the knobs to make the setting.

Knob	Parameter	Adjustment	Setting values
1	Left No	Select data for copy/swap source	1 to 4 ^{a)} 1 to 16 ^{b)}
2	Right No	Select data for copy/swap destination	1 to 4 ^{a)} 1 to 16 ^{b)}

a) Transition control block wipe data

b) Independent key transition control block wipe data

For details of the data affected, see “Copy and Swap” (page 98).

4 To copy, press [Copy], and to swap, press [Swap].

This carries out the copy or swap.

To undo a copy or swap

Press [Undo], to return to the state before the copy or swap was carried out.

Copy by Button Operation

You can carry out the following copy operations by a simple button operation.

- M/E copy
- Keyer copy
- Wipe copy
- DME wipe copy

For an overview of the copy function, see “Copy and Swap” (page 98).

Basic button operation

The basic button operation is to hold down the copy source button, then press the destination button.

You can undo the last operation using [Undo] in the menu (*see page 545*).



M/E copy button operation

In the Flexi Pad control block of each M/E bank, use the [SNAPSHOT] button.

To copy from M/E-1 to M/E-2

In the M/E-1 Flexi Pad control block, hold down the [SNAPSHOT] button, then press the [SNAPSHOT] button in the M/E-2 Flexi Pad control block.

Keyer copy button operation

To specify the copy source, use the key delegation buttons in the key control block, and to specify the copy destination, use the key delegation buttons in the independent key transition control block.

To copy from M/E-1 key 1 to M/E-2 key 2

In the key control block M/E delegation buttons, press [M/E1], turning it on, then hold down the [KEY1] button, and in the M/E-2 independent key transition control block, press the [KEY2] button.

Wipe copy button operation

Use the [WIPE] button in the Flexi Pad control block of each M/E bank.

To copy the M/E-1 wipe to the M/E-2 wipe

In the M/E-1 Flexi Pad control block, hold down the [WIPE] button, then press the [WIPE] button in the M/E-2 Flexi Pad control block.

DME wipe copy button operation

Use the [DME] button in the Flexi Pad control block of each M/E bank.

To copy the M/E-1 DME wipe to the M/E-2 DME wipe

In the M/E-1 Flexi Pad control block, hold down the [DME] button, then press the [DME] button in the M/E-2 Flexi Pad control block.

Chapter 10 Misc Menu, Etc.

Misc Menu Operations	548
Port Settings for Control From an External Device	548
Editing Keyboard Settings	549
Side Flag Settings	550
Safe Title Settings	552
Displaying a List of Transition Rates and Changing the Settings	553
AUX Menu Operations	555
AUX Bus Settings	555
Status Menu	556
Video Process Settings	557

Misc Menu Operations

In the Misc menu, you can carry out the following operations.

- Enabling and disabling operation from an external device, System Manager, or an editing keyboard.
- Enabling and disabling side flags on the background bus of each of the M/E-1 to M/E-3 and PGM/PST banks.
- Switching the safe title function on or off for each switcher output.
- Displaying the transition rate, independent key transition rate, and fade-to-black transition rate for each of the M/E and PGM/PST banks, and changing the settings.

Port Settings for Control From an External Device

Enabling or disabling control from an external device

- 1** In the menu control block, press the top menu selection button [MISC], then select VF1 'Enable' and HF1 'Port Enable.'

The Misc >Enable >Port Enable menu appears with the status area showing the settings of the following ports.

- Switcher Remote 1 to Remote 4 ports (RS-422A, D-sub 9-pin)
- Switcher GPI port (parallel, 25-pin)
- DME1/DME2 Editor ports (RS-422A, D-sub 9-pin)
- DME1/DME2 GPI ports (parallel, 25-pin)

- 2** In the <Switcher> or <DME> group, press on the name of the port for which you want to disable control from an external device, turning it off. To re-enable control for the port, press on its name once more.

Note

For the AUX bus operation from the Remote1 to Remote4 ports of the switcher, the setting (Enable/Disable/Manual) in the Setup menu takes precedence. Only when the setting is "Manual," the settings made in the Port Enable menu apply.

For details, see "Interfacing With External Devices (Device Interface Menu)" under "Setup Relating to Switcher Processor" in Chapter 16 (Volume 2).

DME override

- 1 In the menu control block, press the top menu selection button [MISC], then select VF1 'Enable' and HF1 'Port Enable.'

The Misc >Enable >Port Enable menu appears.

- 2 In the <DME Override> group, select the DME override mode.

DME Override: When a switcher snapshot or effect using a DME is recalled, forcibly select the DME that was used when saving.

On Air Protect: The operation is the same as the DME override function, except that a DME being used by an M/E bank or P/P bank that is on air will not be forcibly selected.

Note

If effects using the same DME channel are selected simultaneously in two or more regions, the DME is selected with the order of precedence P/P >M/E1 >M/E2 >M/E3.

Enabling or disabling control from System Manager

By installing the BZPS-8000 System Management Software (System Manager), you can use a computer connected on a network for management of some switcher data and control operations.

To enable or disable this function, use the following procedure.

- 1 In the menu control block, press the top menu selection button [MISC], then select VF1 'Enable' and HF1 'Port Enable.'

The Misc >Enable >Port Enable menu appears.

- 2 Press [System Manager].

Each time you press the button toggles between enable and disable.

Editing Keyboard Settings

Note

The following operations are only possible when a license for the BZS-8050 Editing Control Software is activated. *For details of license registration, see "Installation and Device Setup (Install/Unit Config Menu)" in Chapter 16 (Volume 2).*

Enabling or disabling control from the editing keyboard

- 1 In the menu control block, press the top menu selection button [MISC], then select VF1 'Enable' and HF2 'Plug-In Editor.'

The Misc >Enable >Plug-In Editor menu appears.

- 2 In the <Control From Plug-In Editor> group, press [Editor Enable].

Each time you press the button toggles between enable and disable.

To enable control of the preview bus only

When control from the editing keyboard is disabled (when [Editor Enable] is set to Disable), to enable control of the preview bus only, press [PVW Bus Enable] in the <Control From Plug-In Editor> group.

Side Flag Settings

Note

The side flag function is only supported on an MVS-8000A system and MVS-8000G system.

The term "side flags" refers to the areas to left and right of an image with aspect ratio 4:3 embedded within a 16:9 frame, when these areas are filled with a selected image from the utility 1 bus.

For details of the side flag function, see "Side Flags" on page 102.

Enabling and disabling side flags with a menu operation

You can enable or disable side flags for the backgrounds (A and B) of each of the M/E and PGM/PST banks.

As an example, to enable side flags for background B row on the M/E-1 bank, use the following procedure.

- 1 In the menu control block, press the top menu selection button [MISC], then select VF1 'Enable' and HF3 'Side Flags.'

The Misc >Enable >Side Flags menu appears.

The status area shows the buttons for Bkgd A and Bkgd B for each of the M/E-1 to M/E-3, and PGM/PST (P/P) banks.

- 2 In the <M/E-1 Side Flags> group, press [Bkgd B].

Each time you press the button toggles between Enable and Disable.

To display a menu for the aspect ratio 4:3, auto side flags, and auto crop settings

In the Misc >Enable >Side Flags menu, press [Setup >SWER >Side Flags].

To display a menu for assigning the side flags on/off function to a cross-point button

In the Misc >Enable >Side Flags menu, press [Side Flags Button Assign].

Enabling and disabling side flags with a button operation

For example, to enable side flags for the background B row of the M/E-1 bank, use the following procedure.

- 1 First, in the Setup menu assign the rightmost cross-point button to the [SIDE FLAG] button.

For details of the assignment operation, see “Cross-Point Settings (Xpt Assign Menu)” in Chapter 16 (Volume 2).

- 2 Press the [SIDE FLAG] button at the right end of the background B row of the M/E-1 bank.

The button you pressed lights amber, and this enables the side flags.

Notes

- The operations of enabling or disabling the side flags by menu operation and by control panel button operation are linked.
- When the auto side flags are on, selecting a 4:3 video material automatically lights the [SIDE FLAG] button, but if you press this button, turning it off, the side flags are temporarily disabled. However, when you select a different 4:3 video material, the [SIDE FLAG] button automatically lights once again, enabling the side flags.

Creating an image with side flags

For example, to create an image with side flags in the background B row of the M/E-1 bank, use the following procedure.

- 1 In the M/E-1 bank cross-point control block, hold down the [UTIL] button, and in the background A row select the signal (utility bus 1 signal) you want to insert in the side flag areas.
- 2 In the background B row, press the cross-point button corresponding to the 4:3 video material.

At this point, if auto side flags are on, this automatically adds side flags to the 4:3 video material. (See “Settings for Switcher Configuration (Config Menu)” in Chapter 16 (Volume 2).)

- 3 Use either of the following methods to turn the side flags on.
 - Use the Misc >Enable >Side Flags menu. (See page 550)
 - Use a cross-point button operation. (See previous item.)

This adds side flags to the 4:3 video material.

Safe Title Settings

Switching the safe title function on or off

- 1 In the menu control block, press the top menu selection button [MISC] and select VF2 ‘Safe Title.’

The Misc >Safe Title menu appears.
- 2 Using any of the following methods, select the signal to which the settings apply.
 - Directly press the list in the status area.
 - Press the arrow keys to scroll the reverse video cursor.
 - Turn the knob to make the setting.

Knob	Parameter	Adjustment	Setting values
1	Output	Signal to which the settings apply	1 to 48

Notes

- It is not possible to change the setting for the output for which the safe title is set off in a Setup menu.
- The safe title function cannot be used for output signals for which through mode is set to Enable in a Setup menu.

For more information about the Setup menu settings referred to above, see “Signal Input Settings (Input Menu)” and “Signal Output Settings (Output Menu)” in Chapter 16 (Volume 2).

- 3 Press [Safe Title] to set it on or off.

Displaying a List of Transition Rates and Changing the Settings

In the Transition menu, for each bank you can display a list of the M/E (or PGM/PST) transition rates and independent key (or DSK) transition rates, and change the settings.

These settings are linked to the other transition rate setting operations.

You can also display and set the fade-to-black transition rate.

Displaying the Transition menu

In the menu control block, press the top menu selection button [MISC], then select VF3 ‘Transition.’

The Misc >Transition menu appears.

About the Transition menu display

The display of the independent key transition rate in the Misc >Transition menu depends on the selection in the <Key Transition> group of the Engineering Setup >Switcher >Transition menu for each of the M/E and PGM/PST banks.

When [Same] (On direction and Off direction settings the same) is selected in the <Key Transition> group: Only “Key” (or “DSK” in the PGM/PST bank) appears.

When [Independ] (On direction and Off direction settings independent) is selected in the <Key Transition> group: “Key(On)” and “Key(Off)” each appear. In the case of the PGM/PST bank, “DSK(On)” and “DSK(Off)” appear.

For more details, see “Settings Relating to Video Switching (Transition Menu)” in Chapter 16 (Volume 2).

Setting the transition rate in the Transition menu

For example, to make the settings for the M/E-1 bank, use the following procedure.

To set the M/E transition rate

- 1** In the <M/E-1 Transition Rate> group of the Misc >Transition menu, press [Transition].
- 2** Turn the knob to set the number of frames.



Knob	Parameter	Adjustment	Setting values
1	Transition Rate	Transition rate	0 to 999 (frames)

Note

When a clip transition is selected as the transition type, it is not possible to change the transition rate in this menu.

To set the independent key transition rate

- 1** In the <M/E-1 Transition Rate> group of the Misc >Transition menu, press [Key].
To set the key On direction or Off direction independently, press Key(On) or Key(Off).
- 2** Turn the knobs to set the number of frames.

Knob	Parameter	Adjustment	Setting values
1	Key1 Trans Rate	Key 1 transition rate	0 to 999 (frames)
2	Key2 Trans Rate	Key 2 transition rate	0 to 999 (frames)
3	Key3 Trans Rate	Key 3 transition rate	0 to 999 (frames)
4	Key4 Trans Rate	Key 4 transition rate	0 to 999 (frames)

To set the fade-to-black transition rate in the Transition menu

- 1** In the Misc >Transition menu, press [FTB].
- 2** Turn the knob to set the number of frames.

Knob	Parameter	Adjustment	Setting values
1	Transition Rate	Transition rate	0 to 999 (frames)



AUX Menu Operations

AUX Bus Settings

Making video process settings for an AUX bus

Make the settings as follows.

- 1** In the Aux/Mon >Aux Bus menu, using any of the following methods, select the AUX bus to which the settings apply.
 - Directly press the list in the status area.
 - Press the arrow keys to scroll the reverse video cursor.
 - Turn the knob to make the setting.

Knob	Parameter	Adjustment	Setting values
1	AUX Bus	AUX bus selection	1 to 48

- 2** Press [Video Process], turning it on.
- 3** Adjust the following parameters.

Knob	Parameter	Adjustment	Setting values
1	Video Gain	Video signal gain	-200.00 to +200.00
2	Y Gain	Luminance signal gain	-200.00 to +200.00
3	C Gain	Chrominance signal gain	-200.00 to +200.00
4	Hue Delay	Hue delay	-180.00 to +180.00
5	Black Level	Black level	-7.31 to +109.59

To return adjustment values to their defaults

Press [Unity].

Status Menu

The Status menu shows the following information.

- Operating status of the DME

Viewing the DME operating status

To view the DME operating status, press the top menu selection button [STATS] in the menu control block.

This selects VF1 'DME Status' and the Status menu appears.

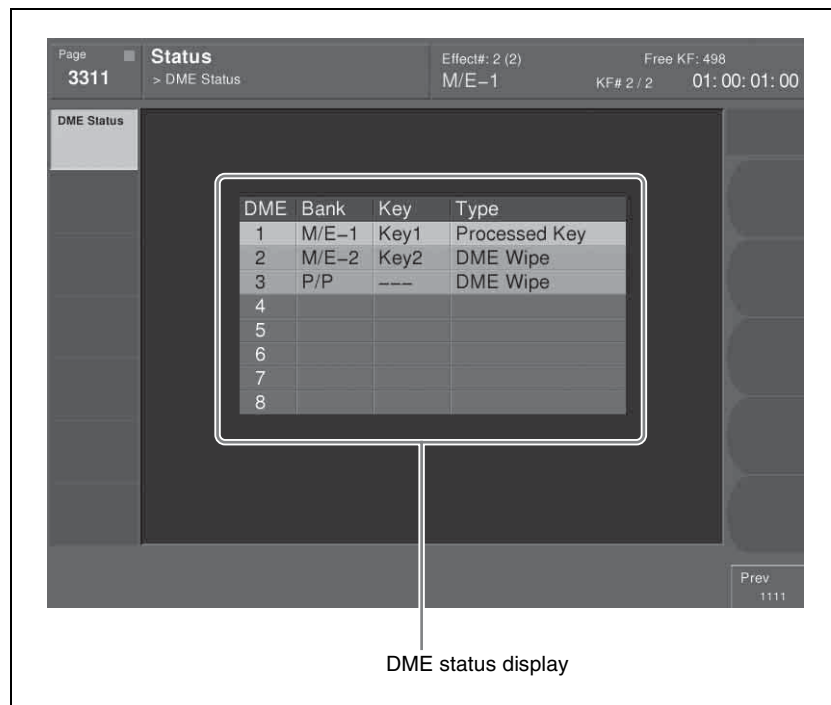

For each DME channel, you can see how the DME is being used in the corresponding operation block.

The display background color also indicates the following differences in the way in which a DME is being used.

Blue: The DME is currently being used in other than the final program output.

Red: The DME is currently being used in the final program output.

Video Process Settings

This section describes operations on the M/E-1 to M/E-3, and PGM/PST background A and B buses, and utility buses 1 and 2.

For these operations, use the Misc >Video Process menu in the respective operating bank.

For video process settings on other buses, see the following.

- *Settings for a particular input signal: “Signal input settings” in Chapter 16 (Volume 2)*
- *Key fill bus settings: “Video Processing” (page 405)*
- *Settings for frame memory source buses 1 and 2: “Setting video processing” (page 498)*
- *Settings for Aux 1 to 48 buses: “Making video process settings for an AUX bus” (page 555)*
- *Overview of video process: “Video Process” (page 107)*

This section describes an example on the background A bus of the M/E-1 bank. For the background B bus or utility bus 1 or 2, make the adjustment with a similar procedure.

Making video process settings for each bus

- 1** In the menu control block, press the top menu selection button [M/E1] and select VF7 ‘Misc’ and HF2 ‘Video Process.’
- 2** In the <Bkgd-A> group, press [Video Process], turning it on.
- 3** Adjust the following parameters.

Knob	Parameter	Adjustment	Setting values
1	Video Gain	Video signal gain	-200.00 to +200.00
2	Y Gain	Luminance signal gain	-200.00 to +200.00
3	C Gain	Chrominance signal gain	-200.00 to +200.00
4	Hue Delay	Hue delay	-180.00 to +180.00
5	Black Level	Black level	-7.31 to +109.59

To return the parameter settings to the defaults

Press [Unity] in the <Bkgd-A> group.











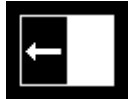













Appendix (Volume 1)









- Wipe Pattern List560**
 - Standard Wipes560
 - Enhanced Wipes561
 - Rotary Wipes562
 - Mosaic Wipes563
 - Random/Diamond Dust Wipes565
- DME Wipe Pattern List566**
 - DME Wipe Patterns Available in One-Channel Mode566
 - DME Wipe Patterns Available in Two-Channel Mode575
 - DME Wipe Patterns Available in Three-Channel Mode579
- Resizer DME Wipe Pattern List580**

Wipe Pattern List

Standard Wipes

1		2		3		4	
5		6		7		8	
9		10		11		12	
13		14		15		16	
17		18		19		20	
21		22		23		24	

Enhanced Wipes

26		27		29		49	
300		301		302		303	
304							



Rotary Wipes

100		101		102		103	
104		105		106		107	
150		151		156		158	
160		162		516		518	
604		606		624		661	







Mosaic Wipes

200		201		202		203	
206		207		208		209	
210		211		212		213	
220		221		222		223	
224		225		226		227	
228		229		230		231	
232		233		234		235	



236		237		238		239	
240		241		242		243	
244		245		246		247	
250		251		252		253	
254		255		256		257	
260		261		262		263	
264		265		266		267	
268		269					

Random/Diamond Dust Wipes







270		271		272		273	
274							



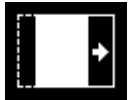
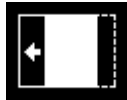

DME Wipe Pattern List

DME Wipe Patterns Available in One-Channel Mode

Slide



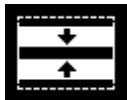







1001		1002		1003		1004	
1005		1006		1007		1008	

Split





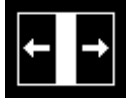



1011		1012		1013	
------	---	------	---	------	---



Squeeze

1021		1022		1023		1024	
1025		1026		1027		1028	
1029		1030		1031			

Door

1041		1042		1043		1044	
1045		1046		1047		1048	

2D trans

1051		1052		1053		1054	
1055		1056		1057		1058	
1061		1062		1063		1064	
1068							

3D trans

1071		1072		1074		1076	
1077		1088		1091		1092	
1093		1094					

Flip tumble

1101		1102		1103		1104	
1109		1110		1121		1122	
1124		1131		1132		1133	
1135							







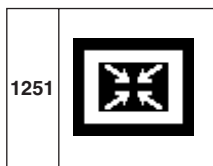





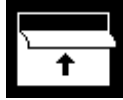
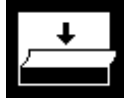







Frame in-out

1201		1202		1203		1204	
1205		1206		1207		1208	
1221		1222		1223		1224	

Picture-in-picture

























Page turn





1301		1302		1303		1304	
1305		1306		1307		1308	
1309		1310		1311		1312	
1313		1315		1316		1317	
1318		1341		1342		1343	
1344		1345					



Page roll

1321		1322		1323		1324	
1325		1326		1327		1328	
1329		1330		1331		1332	
1333		1335		1336		1337	
1338		1346		1347		1348	
1349		1350					

Mirror

1355		1356		1357		1358	
------	---	------	---	------	---	------	--

Sphere



Character trail

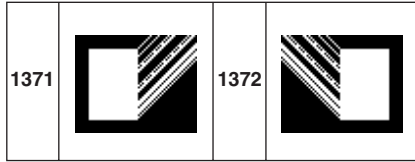



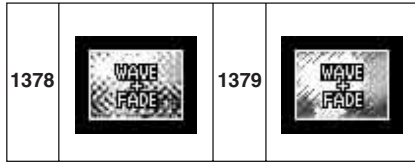

Wave





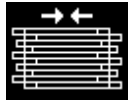
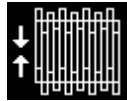

Ripple



Split slide

1384		1385		1386		1387	
1388		1389					

Sparkle

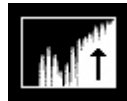
1391		1393		1394		1396	
1398		1399					

Mosaic

1701	
------	---

Defocus

1702	
------	---

User programmable DME

The illustrations for patterns 1901 to 1999 show an effect register number or register name.

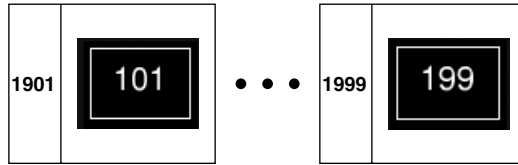

DME Wipe Patterns Available in Two-Channel Mode

Slide

2601		2602		2603		2604	
2605		2606		2607		2608	



Squeeze

2621		2622		2623		2624	
2625		2626		2627		2628	





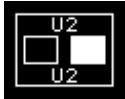

















3D trans

2631		2632		2633		2634	
2642		2644					

Picture-in-picture













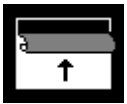









2651		2652	
------	---	------	---

Page turn









2701		2702		2703		2704	
2705		2706		2707		2708	
2709		2710		2711		2712	
2713		2715		2716		2717	
2718		2741		2742		2743	
2744		2745					











Page roll

2721		2722		2723		2724	
2725		2726		2727		2728	
2729		2730		2731		2732	
2733		2735		2736		2737	
2738		2746		2747		2748	
2749		2750					

Brick



2801		2802		2803		2804	
2811		2812		2813		2814	

Frame in-out

2851		2852		2853		2854	
2861		2862		2863		2864	

User programmable DME

The illustrations for patterns 2901 to 2999 show an effect register number or register name.

2901		• • •	2999	
------	---	-------	------	---

DME Wipe Patterns Available in Three-Channel Mode

Brick

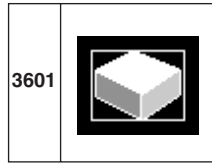



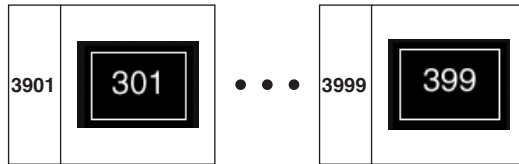

User programmable DME

The illustrations for patterns 3901 to 3999 show an effect register number or register name.



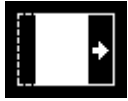

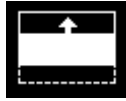
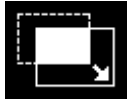

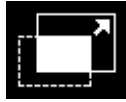

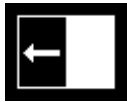

Resizer DME Wipe Pattern List

Slide



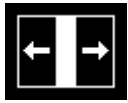
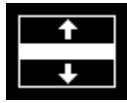









7001		7002		7003		7004	
7005		7006		7007		7008	

Squeeze

7021		7022		7023		7024	
7025		7026		7027		7028	
7029		7030		7031			

Appendix (Volume 1)

Frame in-out

7201		7202		7203		7204	
7205		7206		7207		7208	
7221		7222		7223		7224	



Index

A

Additive mix 49
Ancillary data 92, 522
Angle 66
Art Edge 124
Aspect ratio 67, 450, 458
Attributes 184
Audio mixer 33
Auto
 chroma key adjustments
 382
 transition 45, 183, 359
AUTO button 287
AUTO DELEG button 270
AUTO INS button 284
AUTO TRANS button 262,
 263, 311
Auto/manual transition
 combination 360
Autoload function 208
AUX
 bus settings 555
 delegation buttons 288
 menu operations 555
Auxiliary bus control block
 for AUX buses 288
 for router control 291
 settings 196
Axis location 118

B

Background 150
 A/B row 257
 changing 34
 mask 56
Bank selection buttons 298
Basic menu operations 313
Beveled edge 124
Blind 134
Blink 57
 function 404

Blur 124
Border 53, 123
 parameters 410
Brick 156
Broken glass 134
BS button 331
Bus fixed mode 45
 fader operation 361
 wipe direction 363
Bus selection 26
Button
 assignment settings 197
 numbers 30, 31

C

Caps Lock button 331
Channel ID 121
Character trail 139
Chroma key 49
 adjustments 382
 composition 381
 shadow 51
 shadow adjustment 386
 window 50
Circle 136
Clean mode 49
Clear button 330, 332
Clip function 92
Clip transition 44
 operations 524
Close button 330, 331
Color
 combination 97, 539
 matte settings 350
 vector key 48
Color background 97
 selection 97
 setting operations 538
 settings menu 538
Color cancel 50
 adjustments 383
Color corrector 223
Copy and swap 226
Input video processing
 223
Luminance processing
 224
Output video processing
 226
Primary color correction
 223
RGB clip 224
Secondary color correction
 224
Spot color adjustment 226
YUV clip 226
Color data
 copy 100
 swap 100
Color mix 97, 127, 539
 for edge fill matte 446
 for key fill 388
Color palette window 333
Combine Shadow 141
Combiner 152
Contrast 128
Control panel 251
 configuration 1 251
 configuration 2 252
 configuration 3 255
Coordinate axes 120
Copy 98, 544
Crop 123
Cross-point
 button numbers 257
 button settings 196
 buttons 256
 control block 256
 hold 183
Custom mode 192
Cut 44
CUT button 262, 312
Cylinder 138



D

Dead zone 487
Default recall button 323
Defocus 123
Del button 332
Delay setting 174
Delegation buttons 267
DEST button 289
Detents 115
Device
 management 193
DEVICE connectors 295
Device control block
 joystick 277
 search dial 278
 trackball 271
Device Interface 202
Digital multi effects 109
Dim and Fade 130
Direction 64, 444, 456, 470
Disk recorder control 161
Display 269, 286
DME 109, 261, 263, 311
 applying to a key 400, 415
 channel selection buttons 269
 setup 202
 special effects 122
DME channel
 copy 101
 swap 101
DME monitor 270, 287, 309
DME override 549
DME patterns
 user programmable 483
DME Wipe Modify Clear 83
DME wipe pattern 72
 edge modification 470
 groups 72
 selection 466
DME wipe pattern list
 for one-channel mode 566
 for two-channel mode 575
DME wipe settings 466

 for independent key transitions 477
DME wipes 72, 465
 copy 99, 100
 direction 470
 modifiers 469
 modify clear 476
 position 471, 478
 resizer 481
 snapshot 82, 482
 swap 99, 100
Door 567
Downstream key control block 306
Drop border 53
 parameters 411
dual resizer effects 432
Duration
 effect 171
 keyframe 171
 modes 170
 setting buttons 283
Dust mix 62, 443

E

Edge 65
 fill 55
 modifiers 52
EDIT ENBL button 282
Edit point specification buttons 282
Editing buttons 283
EFF LOOP button 284
Effect 168
 attributes 169
 dissolve 169, 183
 duration 171
 editing 169
 execution 180
 resizer 427
 saving/recalling 169
Effect execution direction selection buttons 284
Emboss 54
Enhanced wipes 561
Enter button 330, 332
Explosion 138

Extended VTR control 161
External
 key 90
 processed key 270, 403, 417
External devices 158
 connections 197
 disk recorder control 161
 Extended VTR control 161
 GPI device control 160
 P-Bus device control 159
 shared control functions 158
 VTR control 161
External hard disk drive 532

F

Fade to black 47, 369
 control block 287
 transition rate 369
Fader lever 261, 307, 311
Files 205
 autoload function 208
 backups 531
 deleting 529
 operations 205
 renaming 530
 restoring 531
Flag 132
Flex Shadow 125
Flexi Pad control block
 simple type 299
 standard type 264
Flip tumble 569
Flip-flop mode 45
Flying bar 134
Format converter 190
Frame
 in-out 569, 581
Frame input mode 352
Frame memory
 clip function 92
 continuously capturing still images (record) 91, 508
 feed 270, 403, 418

- overview 85
- pair file processing 527
- recalling a continuous
 - sequence of still images (animation) 91, 509
 - settings 200
- Frame memory operations 490
 - capturing an input image 496
 - clip 512
 - input image selection 494
 - menu display 490
 - preparations 490
 - selecting frame memory 495
 - selecting outputs 495
- Freeze 89, 131, 496
- Fringe 70
- FTB button 287
- FULL LINK 63
- Function
 - button area 322
 - selection buttons 286

G

- Global
 - coordinate space 111
 - effects 152
- Glow 130
- GPI Device control 160
- GPI output 183
- Graphics display 120
- Grid 121

H

- HF buttons 322

I

- Image
 - capturing 89
 - data management 94, 527
 - data transfer 94
 - output 90
 - processing 90
 - recalling 90

- saving 89
- Image file
 - deletion 529
 - renaming 530
- Independent key transition 37, 364
 - DME wipe settings 477
 - simple transitions 374
 - type 365
 - type selection buttons 263, 304, 306
 - wipe modifiers 456
 - wipe settings 455
- Independent key transition control block
 - simple type 304
 - standard type 364
- Independent key transition execution section 263, 305, 307, 312
- Independent key transition rate 366
 - display 368
 - setting by a menu operation 367
 - setting in the Flexi Pad control block 366
 - setting in the numeric keypad control block 367

Input

- signal settings 199, 202
- string 331
- value 330

- Installation 192

- Installation and device settings 192

- Interpolation 151

- Invert 151

- Item display 330, 331

J

- Joystick 277

K

- Kaleidoscope 136

Key 48

- 1/2 row 256
- bus selection buttons 258
- control block 267
- default 57
- delegation buttons 263, 306
- deleting 35
- density adjustment 152
- disable 183
- edge modifications 390, 410
- inserting 35
- mask 55
- memory 56
- modifier buttons 268
- modifiers 52
- modify clear 58, 404
- output destination 403
- output status display 346, 373
- settings 200
- signal adjustments 384
- source selection 152
- status display 263, 303, 312
- Key active 50
 - adjustment 383
- Key Border 124
- KEY button 289
- Key fill
 - selection 387
 - selection buttons 268
- Key priority 343
 - display 346, 373
 - selecting 36
 - setting by a menu operation 345
 - setting in the transition control block 343
- Key setting
 - using menus 378
- Key snapshot 433
 - buttons 264, 307
 - recalling 434, 436
 - saving 433, 435
 - setting buttons 264, 307



- using simple transition module 435
- Key source
 - name display 264, 307
 - selection 387
 - selection buttons 268
- Key transition
 - selection buttons 302
- Key type
 - selection buttons 268
 - setting 379
- Keyboard window 331
- Keyer
 - copy 99
 - swap 99
- Keyframe 168
 - control block 281
 - duration 171
 - effect registers 166
 - status 323
 - strobe 143
- KF button 263
- Knob 269, 294
 - parameter buttons 323
- K-SS button 305

L

- Left button 332
- Lens 136
- Level selection buttons 290
- Lighting 140
- Line feed button 332
- Linear key 48
- Local coordinate space 111
- Location
 - size 118
 - XYZ 116
- Lock function 508
- Luminance key 48

M

- M/E
 - bank display 259
 - copy 98
 - swap 98
- Macro 210
 - attachment 218
 - creating 213
 - editing 212, 214, 218
 - events 210
 - execution 215
 - menu macro 222
 - overview 210
 - registers 210
 - timeline 216
- Magnitude 66
- MAIN and SUB delegation
 - button 235
- Main mask 56
 - using 397, 414
- Main menu site 335
- Main/sub modifier link 63
- Maintenance 193
- Manual transition 45, 359
- Mask (DME) 130
- Masks 55, 397, 414
- Master
 - region 166
 - snapshot registers 167
 - timeline registers 167
 - timelines 181
- Matte data
 - copy 100
 - swap 100
- Max./min. value indication 330
- Melt 139
- Memory
 - card slot 295
 - initialization 192
 - recall buttons 298
- Memory card/USB adaptor
 - block 295
- “Memory Stick”/USB
 - connections block 296
- “Memory Sticks” 296
- Menu
 - accessing 314, 321
 - control block 294
 - display 294
 - operations 323
 - organization 313
 - page number button 322
 - screen 322

- shortcut menu 335
- shutting down 333
- switching between the
 - main menu sites 335
- title button 322
- top menu list 313
- MENU button 276
- Menu macros 222
- Metal 129
- Minus button 330
- Mirror 135
- Misc menu operations 548
- MIX 90, 261, 263, 311
- Mix 41, 61
- Mode selection buttons 265, 285, 303
- Modulation 69, 452
- Mono 127
- MORE button 269
- Morphing 61
- Mosaic 128
 - glass 132
 - wipes 563
- Motion decay 142
- Multi 67, 451, 459
 - mirror 135
 - move 127
- Multi Program 2 230
 - basic operation 232
 - restriction 243
- MVE-8000A 109
- MVE-9000 109

N

- NAM 42, 90, 261, 311
- Nega 128
- Negative NAM 61
- Network configuration 187
- Next transition 34
 - selecting 34
 - selection buttons 261, 310
- Non-additive mix 42, 261, 311
- Nonlinear effects 131
- Non-Sync state 360
- Normal
 - edge 413

mix 49
Numeric display 266, 303
Numeric keypad 286
 control block 284
 window 330

O

ON AIR indicators 270
One-stroke mode 42
One-time mode 42
Operation
 buttons 272
 modes 88
 settings 197
Outline 54
 parameters 412
Output
 destination specification
 buttons 270
 signal settings 200
OVERRIDE button 270

P

Page Roll 571
Page turn 137, 570
Pair file processing 94, 527
Pair mode 87
Pairing 68, 452
Panel setup 195
Panorama 137
Parameter group button 322
Paths 174
 DME 176
 switcher 174
 types 179
Pattern key 90
Pattern limit 46, 355
 buttons 262, 302
 setting by a menu
 operation 356
 setting with the fader lever
 356
 transition 357
Pattern mix 61, 441
 types 61
Pattern replication 67

P-Bus devices 158
 control 159
Perspective 119
Picture-in-picture 570, 576
Plane function 50
Positioner 65, 448, 456, 471,
 478
Positive NAM 61
Posterization 128
Preset color mix 42
Preview 46, 363
 selection buttons 287
Previous page button 323
PRIOR SET button 263, 312
PST COLOR MIX 261, 311

R

Random/diamond dust wipes
 565
Reentry buttons 26, 257
Reference region 166
Regions 165
 selection buttons 285
Registers 166
Related manuals 20
Replication 459
Resizer 58
Resizer DME wipe 481
Resizer DME wipe patterns
 580
Resume mode 192
Right button 332
Rings 133
Ripple 133
Roll 137
Rotary wipes 562
Rotation 65, 117, 450, 458
Router interface setup 203
RTR button 290

S

Screen saver 198
Search dial 278
Second (2ND) button 289
Selected
 bus display 289

 source name displays 289
SEMI LINK 63
Separate sides 150
Sepia 127
Setup 187
 DCU input/output 202
 overview 187
 panel 195
 router interface 203
 switcher 198
 system 187
Setup data saving/recalling
 194
Shadow 53, 157
 parameters 411
Shaped Video 150
SHIFT button 259
Shift button 332
Shortcut 335
Shotbox 186
SHOW KEY button 269
Show key function 418
Side flags
 DME wipe action 104
 MISC menu 550
 overview 102
 settings 102
 wipe action 103
Signal
 assignment to buttons 29
 name display 33
 selection 25
Simple
 transition 371
Simple P/P Software 227
Sketch 129
Skew 120
Slide 566, 575, 580
Snapshot 182
 attributes 183
 registers 167
Soft edge 54, 456
Softening
 edge 413
 wipe pattern edge 456
Solarization 128
Source
 coordinate space 110

- name displays 290
- Space button 332
- Speed 66
- Sphere 138
- Spin 117
- Spiral 71, 453
- Split 64, 135, 444, 566
 - fader 373
 - slide 135
- Spotlighting 143
- Spring 70, 453
- Squeeze 567, 575, 580
- Standard wipe patterns 60
- Standard wipes 560
- Start up state 192
- Status area 322
- Status menu 556
- STOP NEXT KF button 284
- Sub (subsidiary) mask 56
 - using 399, 414
- Subsidiary menu site 335
- SUPER MIX 261, 311
- Super mix 42
 - settings 349
- Swap 98, 544
- Swirl 139
- Switcher setup 198
- System
 - configuration 187
 - features 22
 - reset 192
 - setup 187

T

- Tally interface setup 203
- Target coordinate space 110
- TC button 330
- Temporary attributes 169, 184
- Three-dimensional
 - coordinate space 110
 - parameter display 122
 - parameters 112
 - transformations 110
- Time offset execution 39
- Timecode input mode 352
- Top menu list 313

- Top menu selection buttons 294
- Top menu window 332
- TRACE button 270
- Trail 142
- TRANS PVW button 262, 312
- Transformation operation
 - modes 116
- Transition
 - auto 45
 - execution 44, 351
 - indicator 307
 - manual 45
 - mode 171
 - next 34
 - operating procedure 340
 - preview 46, 363
- Transition control block
 - simple type 299
 - standard type 260
- Transition execution
 - section 261, 302, 311
 - with the fader lever 359
- Transition indicator 261, 311
 - function 351
- Transition rate 352
 - display 262, 311
 - setting by a menu
 - operation 355
 - setting in the Flexi Pad
 - control block 353
 - setting in the MISC menu
 - 553
 - setting in the numeric
 - keypad control block 354
- Transition type 41
 - selecting by a menu
 - operation 348
 - selection buttons 261, 301, 311
- Trim button 330
- Twist 133

U

- UNDO button 266, 303

- User preference button 294
- User programmable DME
 - 574, 578
 - Notes on keyframe
 - creation 484
 - patterns 483
 - transition mode 75, 483
- User regions 165
- User texture pattern 149
- UTIL button 258
- Utility 185
- Utility/shotbox control block 298

V

- V/K mode 88
- VF buttons 322
- Video
 - processing 24, 405
 - signal adjustment 51
 - switching 200
- Video process 107
 - memory 108
 - settings 557
- VTR control 161

W

- Wave 131
- Wind 143
- Window adjustment 51, 385
- WIPE 261, 263, 311
- Wipe 44, 60
 - copy 99
 - enhanced 60
 - modify clear 454
 - mosaic 60
 - pattern list 560
 - random/diamond dust 60
 - rotary 60
 - standard 60
 - swap 99
- Wipe crop 126
- Wipe direction 444, 456
 - selection buttons 262, 302, 312
- Wipe modifiers 443

Wipe Modify Clear 71
Wipe pattern
 aspect ratio 450, 458
 edge modification 445
 key 52
 modifiers 63
 modulation 452
 replication 451, 459
 rotation 450
 selection 438
 types 60
 variation 63
Wipe pattern/modifier
 combinations 454
Wipe position 448, 456
Wipe settings 200, 438
 for independent key
 transitions 455
Wipe snapshot 71, 460
 deleting 462
 recalling 462
 saving 461
Wire frames 120

X

XPT HOLD
 buttons 258, 289
 status display 303

Y

Y balance 51
 adjustment 385

Z

Zabton 54, 396, 413
Z-ring 275



The material contained in this manual consists of information that is the property of Sony Corporation and is intended solely for use by the purchasers of the equipment described in this manual.

Sony Corporation expressly prohibits the duplication of any portion of this manual or the use thereof for any purpose other than the operation or maintenance of the equipment described in this manual without the express written permission of Sony Corporation.

MVS-8000/8000SF
System (SY)
3-206-016-12 (1)

Sony Corporation

<http://www.sony.net/>

Printed on recycled paper

Printed in Japan
2008.05.13
©2001