

SERVICE MANUAL

BA-4D CHASSIS

<u>MODEL NAME</u>	<u>REMOTE COMMANDER</u>	<u>DESTINATION</u>	<u>CHASSIS NO.</u>
KV-20S90	RM-Y155	US	SCC-S27NA
KV-21SE43C	RM-Y155	E	SCC-S55BA



KV-20S90



RM-Y155

TRINITRON® COLOR TELEVISION

SONY®

TABLE OF CONTENTS

SECTION TITLE	PAGE
Specifications.....	3
Warnings and Cautions.....	4
Safety Check-out	5
Self-Diagnostic Function.....	6
1. Disassembly	
1-1. Rear Cover Removal.....	8
1-2. Chassis Assembly Removal.....	8
1-3. Service Position	8
1-4. Picture Tube Removal	9
Anode Cap Removal Procedure.....	9
2. Set-up Adjustments	
2-1. Beam Landing.....	10
2-2. Convergence.....	11
2-3. Focus	12
2-4. Screen (G2)	12
2-5. Method of Setting the Service Adjustment Mode.....	13
2-6. White Balance Adjustments	13
3. Safety Related Adjustments	
3-1.  R582 Confirmation Method (Hold Down Confirmation) and Readjustments	14
3-2. B+ Voltage Confirmation and Adjustment	14
4. Circuit Adjustments	
4-1. Setting the Service Adjustment Mode.....	16
4-2. Memory Write Confirmation Method	16
4-3. Remote Adjustment Buttons and Indicators	16
Adjustment Items.....	17
4-4. A Board Adjustments	18
5. Diagrams	
5-1. Circuit Boards Location.....	21
5-2. Printed Wiring Board and Schematic Diagram Information	21
5-3. Block Diagram and Schematics	22
Block Diagram	22
A Board Schematic Diagram	23
C Board Schematic Diagram.....	28
5-4. Semiconductors	30
6. Exploded Views	
6-1. Chassis	31
7. Electrical Parts List	32

SPECIFICATIONS

	KV-21SE43C	KV-20S90
Power requirements	220V 50Hz	120V 60Hz
Number of Inputs/Outputs		
Video ¹⁾	2	2
Audio Input ²⁾	2	2
Speaker output (W)	4W x 2	3W x 2
Power Consumption (W)		
In use (Max)	95W	90W
In Standby	1W	1W
Dimensions(W/H/D)		
mm	522 x 477 x 479 mm	522 x 477 x 479 mm
in	20 ⁵ / ₈ x 18 ¹³ / ₁₆ x 18 ⁷ / ₈ in.	20 ⁵ / ₈ x 18 ¹³ / ₁₆ x 18 ⁷ / ₈ in.
Mass		
kg	21.6 kg	21.6 kg
lbs	48 lbs	48 lbs

1) 1 Vp-p 75 ohms unbalanced, sync negative

2) 500 mVrms (100% modulation), Impedance: 47 kilohms

Television system

American TV Standard/NTSC

Channel coverage

VHF: 2-13/ UHF: 14-69/ CATV: 1-125

Picture tube

Flat Trinitron[®] tube

Visible screen size

20-inch picture measured diagonally

Actual screen size

21-inch measured diagonally

Antenna

75 ohm external terminal for VHF/UHF

Supplied Accessories

Remote Commander RM-Y155

Size AA (R6) batteries (2)

Telescopic Antenna (KV-21SE43C ONLY)

Optional Accessories

None

WARNINGS AND CAUTIONS

CAUTION

Short circuit the anode of the picture tube and the anode cap to the metal chassis, CRT shield, or carbon painted on the CRT, after removing the anode.

WARNING!!

An isolation transformer should be used during any service to avoid possible shock hazard, because of live chassis. The chassis of this receiver is directly connected to the AC power line.

SAFETY-RELATED COMPONENT WARNING!!

Components identified by shading and  mark on the schematic diagrams, exploded views, and in the parts list are critical for safe operation. Replace these components with Sony parts whose part numbers appear as shown in this manual or in supplements published by Sony. Circuit adjustments that are critical for safe operation are identified in this manual. Follow these procedures whenever critical components are replaced or improper operation is suspected.

ATTENTION!!

Après avoir déconnecté le cap de l'anode, court-circuiter l'anode du tube cathodique et celui de l'anode du cap au châssis métallique de l'appareil, ou la couche de carbone peinte sur le tube cathodique ou au blindage du tube cathodique.

Afin d'éviter tout risque d'électrocution provenant d'un châssis sous tension, un transformateur d'isolement doit être utilisé lors de tout dépannage. Le châssis de ce récepteur est directement raccordé à l'alimentation du secteur.

ATTENTION AUX COMPOSANTS RELATIFS A LA SECURITE!!

Les composants identifiés par une trame et par une marque  sur les schémas de principe, les vues explosées et les listes de pièces sont d'une importance critique pour la sécurité du fonctionnement. Ne les remplacer que par des composants Sony dont le numéro de pièce est indiqué dans le présent manuel ou dans des suppléments publiés par Sony. Les réglages de circuit dont l'importance est critique pour la sécurité du fonctionnement sont identifiés dans le présent manuel. Suivre ces procédures lors de chaque remplacement de composants critiques, ou lorsqu'un mauvais fonctionnement suspecte.

SAFETY CHECK-OUT

After correcting the original service problem, perform the following safety checks before releasing the set to the customer:

1. Check the area of your repair for unsoldered or poorly soldered connections. Check the entire board surface for solder splashes and bridges.
2. Check the interboard wiring to ensure that no wires are "pinched" or touching high-wattage resistors.
3. Check that all control knobs, shields, covers, ground straps, and mounting hardware have been replaced. Be absolutely certain that you have replaced all the insulators.
4. Look for unauthorized replacement parts, particularly transistors, that were installed during a previous repair. Point them out to the customer and recommend their replacement.
5. Look for parts which, though functioning, show obvious signs of deterioration. Point them out to the customer and recommend their replacement.
6. Check the line cords for cracks and abrasion. Recommend the replacement of any such line cord to the customer.
7. Check the B+ and HV to see if they are specified values. Make sure your instruments are accurate; be suspicious of your HV meter if sets always have low HV.
8. Check the antenna terminals, metal trim, "metallized" knobs, screws, and all other exposed metal parts for AC leakage. Check leakage as described below.

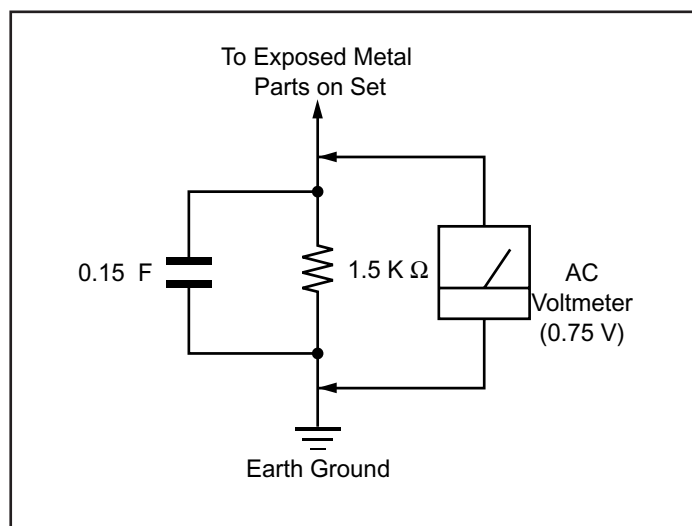

Figure A. Using an AC voltmeter to check AC leakage.

Leakage Test

The AC leakage from any exposed metal part to earth ground and from all exposed metal parts to any exposed metal part having a return to chassis, must not exceed 0.5 mA (500 microamperes). Leakage current can be measured by any one of three methods.

1. A commercial leakage tester, such as the Simpson 229 or RCA WT-540A. Follow the manufacturers' instructions to use these instructions.
2. A battery-operated AC milliampmeter. The Data Precision 245 digital multimeter is suitable for this job.
3. Measuring the voltage drop across a resistor by means of a VOM or battery-operated AC voltmeter. The "limit" indication is 0.75 V, so analog meters must have an accurate low voltage scale. The Simpson's 250 and Sanwa SH-63TRD are examples of passive VOMs that are suitable. Nearly all battery-operated digital multimeters that have a 2 VAC range are suitable (see Figure A).

How to Find a Good Earth Ground

A cold-water pipe is a guaranteed earth ground; the cover-plate retaining screw on most AC outlet boxes is also at earth ground. If the retaining screw is to be used as your earth ground, verify that it is at ground by measuring the resistance between it and a cold-water pipe with an ohmmeter. The reading should be zero ohms.

If a cold-water pipe is not accessible, connect a 60- to 100-watt trouble-light (not a neon lamp) between the hot side of the receptacle and the retaining screw. Try both slots, if necessary, to locate the hot side on the line; the lamp should light at normal brilliance if the screw is at ground potential (see Figure B).

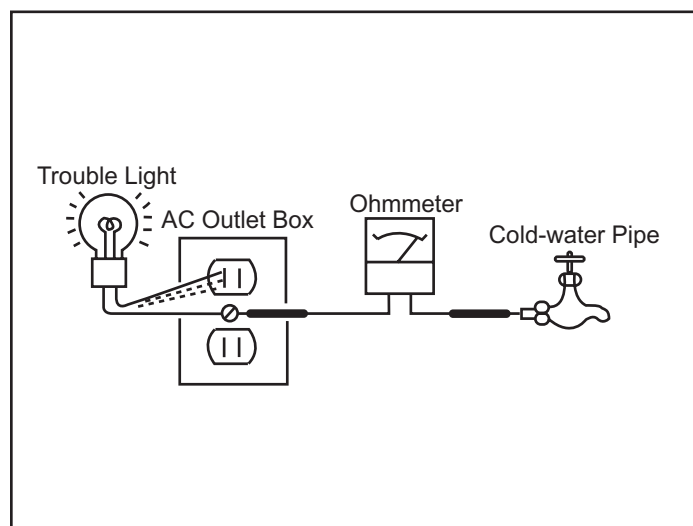

Figure B. Checking for earth ground.

SELF-DIAGNOSTIC FUNCTION

Self Diagnosis
Supported model

The units in this manual contain a self-diagnostic function. If an error occurs, the STANDBY/TIMER LED will automatically begin to flash. The number of times the LED flashes translates to a probable source of the problem. A definition of the STANDBY/TIMER LED flash indicators is listed in the instruction manual for the user's knowledge and reference. If an error symptom cannot be reproduced, the Remote Commander can be used to review the failure occurrence data stored in memory to reveal past problems and how often these problems occur.

Diagnostic Test Indicators

When an error occurs, the STANDBY/TIMER LED will flash a set number of times to indicate the possible cause of the problem. If there is more than one error, the LED will identify the first of the problem areas.

Results for all of the following diagnostic items are displayed on screen. No error has occurred if the screen displays a "0".

Diagnostic Item Description	No. of times STANDBY/ TIMER lamp flashes	Self-Diagnostic Display/ Diagnostic Result	Probable Cause Location	Detected Symptoms
Power does not turn on	Does not light	—————	<ul style="list-style-type: none"> Power cord is not plugged in. Fuse is burned out (F601). (A Board) 	<ul style="list-style-type: none"> Power does not come on. No power is supplied to the TV. AC Power supply is faulty.
+B overcurrent (OCP)*	2 times	2:0 or 2:1	<ul style="list-style-type: none"> H.OUT (Q502) is shorted.(A Board) IC1751 (C Board) is shorted. 	<ul style="list-style-type: none"> Power does not come on. Load on power line is shorted.
Vertical Deflection Stopped	4 times	4:0 or 4:1	<ul style="list-style-type: none"> +13V is not supplied. (A Board) IC541 is faulty. (A Board) 	<ul style="list-style-type: none"> Has entered standby state after horizontal raster. Vertical deflection pulse is stopped. Power line is shorted or power supply is stopped.
White Balance failure (not balanced)	5 times	5:0 or 5:1	<ul style="list-style-type: none"> Video OUT (Q392 to Q394) is faulty. (A Board) IC301 is faulty. (A Board) Screen (G2) is improperly 	<ul style="list-style-type: none"> No raster is generated. CRT Cathode current detection reference pulse output is small.

*If a +B overcurrent is detected, stoppage of the vertical deflection is detected simultaneously. The symptom that is diagnosed first by the microcontroller is displayed on the screen.

**Refer to Screen (G2) Adjustments in Section 2-4. of this manual.

Display of Standby/Timer LED Flash Count

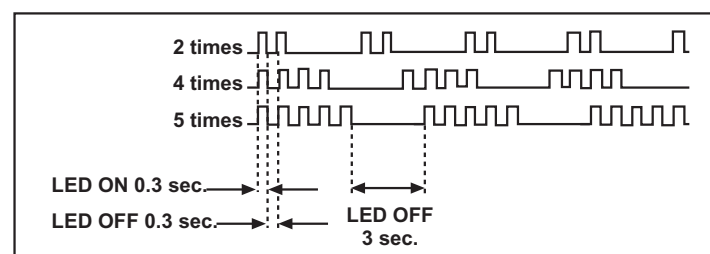

Diagnostic Item	Flash Count*
+B Overcurrent	2 times
Vertical Deflection Stopped	4 times
White Balance Failure	5 times

*One flash count is not used for self-diagnostic.

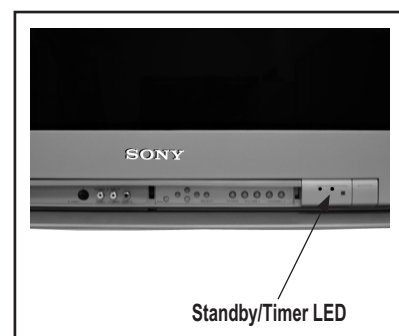

Stopping the Standby/Timer LED Flash

Turn off the power switch on the TV main unit or unplug the power cord from the outlet to stop the STANDBY/TIMER LAMP from flashing.

Self-Diagnostic Screen Display

For errors with symptoms such as “power sometimes shuts off” or “screen sometimes goes out” that cannot be confirmed, it is possible to bring up past occurrences of failure on the screen for confirmation.

To Bring Up Screen Test

In standby mode, press buttons on the Remote Commander sequentially, in rapid succession, as shown below:

Display Channel Sound Volume Power ON

Note that this differs from entering the Service Mode (Sound Volume).

Self-Diagnostic Screen Display

SELF DIAGNOSTIC
2: 000
3: N/A
4: 000
5: 001
101: N/A

Numeral “0” means that no fault was detected.
Numerical “1” means a fault was detected one time only.

Handling of Self-Diagnostic Screen Display

Since the diagnostic results displayed on the screen are not automatically cleared, always check the self-diagnostic screen during repairs. When you have completed the repairs, clear the result display to “0”.

Unless the result display is cleared to “0”, the self-diagnostic function will not be able to detect subsequent faults after completion of the repairs.

Clearing the Result Display

To clear the result display to “0”, press buttons on the Remote Commander sequentially when the diagnostic screen is displayed, as shown below:

Channel ENTER

Quitting the Self-Diagnostic Screen

To quit the entire self-diagnostic screen, turn off the power switch on the Remote Commander or the main unit.

Self-Diagnostic Circuit

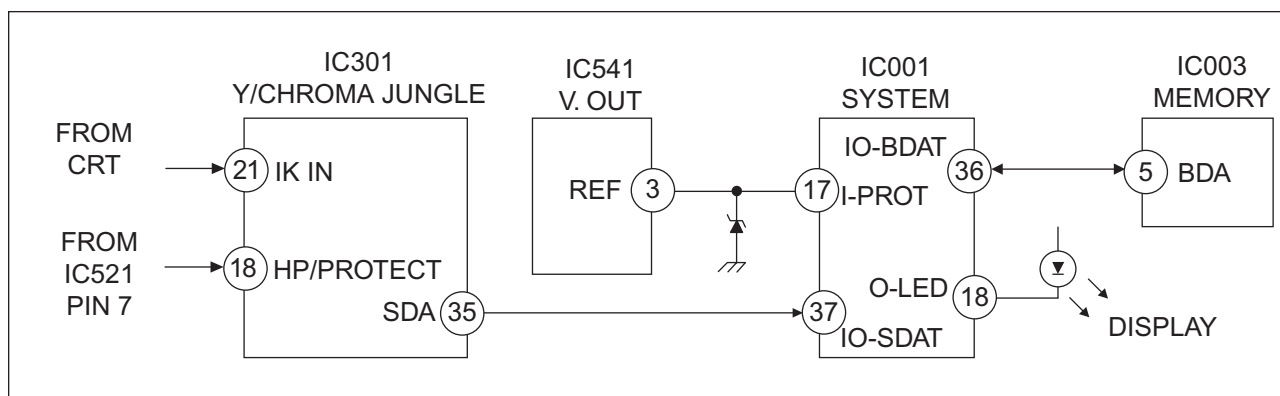

+B overcurrent (OCP)

Occurs when an overcurrent on the +B (115V) line is detected by pin 18 of IC301. If the voltage of pin 18 of IC301 is less than 1V when V.SYNC is more than seven verticals in a period, the unit will automatically turn off.

Vertical Deflection Stopped

Occurs when an absence of the vertical deflection pulse is detected by pin 17 of IC001. Power supply will shut down when waveform interval exceeds 2 seconds.

White Balance Failure

If the RGB levels* do not balance within 2 seconds after the power is turned on, this error will be detected by IC301. TV will stay on, but there will be no picture.

*(Refers to the RGB levels of the AKB detection Ref pulse that detects 1K).

SECTION 1: DISASSEMBLY

1-1. REAR COVER REMOVAL

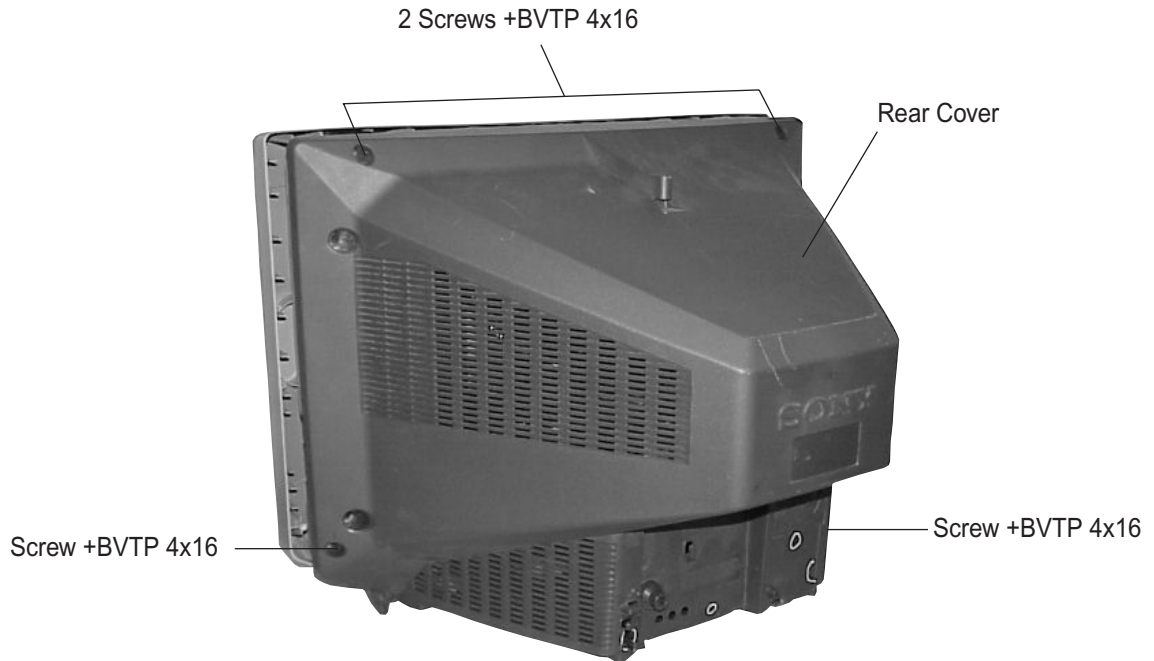

1-2. CHASSIS ASSEMBLY REMOVAL

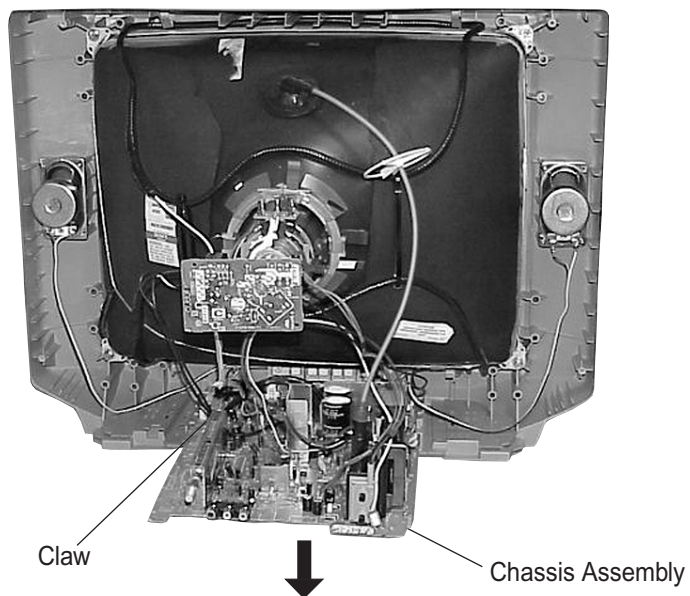

1-3. SERVICE POSITION

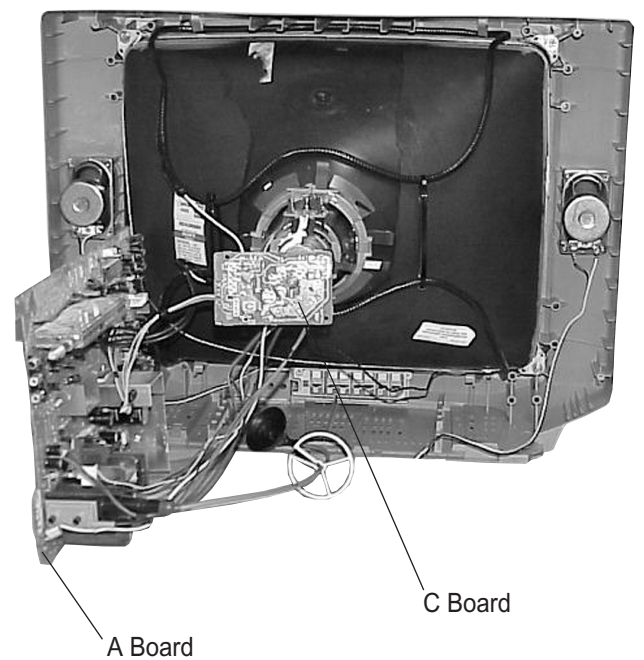

1-4. PICTURE TUBE REMOVAL

WARNING: BEFORE REMOVING THE ANODE CAP

High voltage remains in the CRT even after the power is disconnected. To avoid electric shock, discharge CRT before attempting to remove the anode cap. Short between anode and CRT coated earth ground strap.

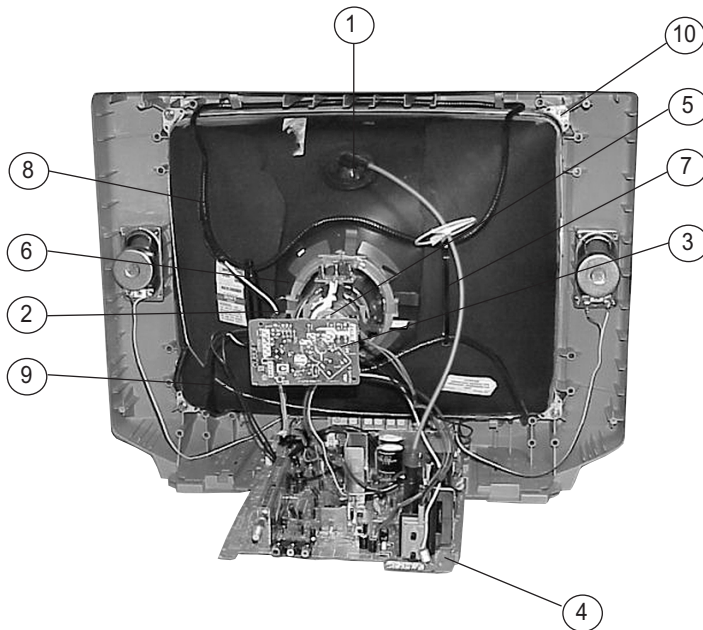
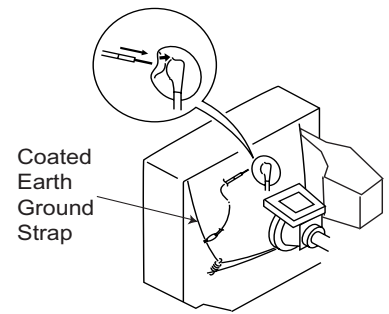

1. Discharge the anode of the CRT and remove the anode cap.
2. Unplug all interconnecting leads from the deflection yoke, neck assembly, degaussing coils and CRT grounding strap.
3. Remove the C Board from the CRT.
4. Remove the chassis assembly.
5. Loosen the neck assembly fixing screw and remove.
6. Loosen the deflection yoke fixing screw and remove.
7. Place the set with the CRT face down on a cushion and remove the degaussing coil holders.
8. Remove the degaussing coils.
9. Remove the CRT grounding strap and spring tension devices.
10. Unscrew the four CRT fixing screws [located on each CRT corner] and remove the CRT [Take care not to handle the CRT by the neck].

ANODE CAP REMOVAL PROCEDURE

WARNING: High voltage remains in the CRT even after the power is disconnected. To avoid electric shock, discharge CRT **before** attempting to remove the anode cap. Short between anode and coated earth ground strap of CRT.

NOTE: After removing the anode cap, short circuit the anode of the picture tube and the anode cap to either the metal chassis, CRT shield, or carbon painted on the CRT.

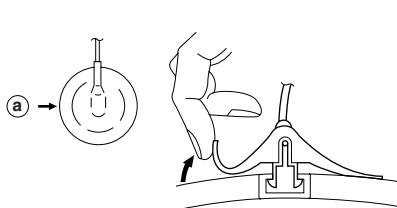

- ① Turn up one side of the rubber cap in the direction indicated by arrow (a) .

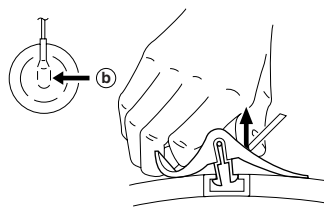

- ② Use your thumb to pull the rubber cap firmly in the direction indicated by arrow (b) .

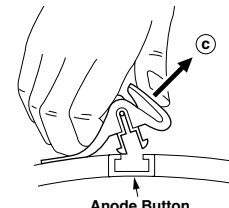

- ③ When one side of the rubber cap separates from the anode button, the anode cap can be removed by turning the rubber cap and pulling it in the direction of arrow (c) .

HOW TO HANDLE AN ANODE CAP

1. Do not use sharp objects which may cause damage to the surface of the anode cap.
2. To avoid damaging the anode cap, do not squeeze the rubber covering too hard. A material fitting called a shatter-hook terminal is built into the rubber.
3. Do not force turn the foot of the rubber cover. This may cause the shatter-hook terminal to protrude and damage the rubber.

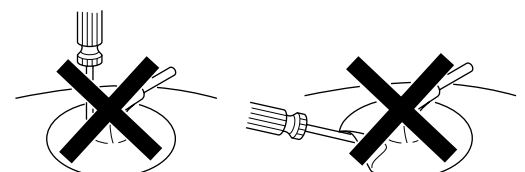

SECTION 2: SET-UP ADJUSTMENTS

The following adjustments should be made when a complete realignment is required or a new picture tube is installed.

These adjustments should be performed with rated power supply voltage unless otherwise noted.

Set the controls as follows unless otherwise noted:

VIDEO MODE: Standard

PICTURE CONTROL: Normal

BRIGHTNESS CONTROL: Normal

Perform the adjustments in order as follows:

1. Beam Landing
2. Convergence
3. Focus
4. Screen (G2)
5. White Balance

Note Test Equipment Required:

1. Color Bar Pattern Generator
2. Degausser
3. DC Power Supply
4. Digital Multimeter

2-1. BEAM LANDING

Before beginning adjustment procedure:

1. Degauss the entire screen.
2. Feed in the white pattern signal.

ADJUSTMENT PROCEDURE

1. Input a raster signal with the pattern generator.
2. Loosen the deflection yoke mounting screw, and set the purity control to the center as shown below:

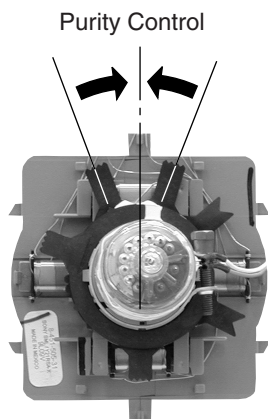

3. Turn the raster signal of the pattern generator to green.
4. Move the deflection yoke backward, and adjust with the purity control so that green is in the center and red and blue are even on both sides.

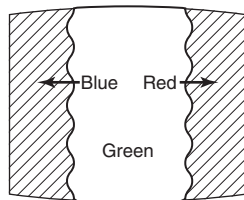

5. Move the deflection yoke forward, and adjust so that the entire screen becomes green.

6. Switch over the raster signal to red and blue and confirm the condition.
7. When the position of the deflection yoke is determined, tighten it with the deflection yoke mounting screw.
8. If landing at the corner is not right, adjust by using the disk magnets.

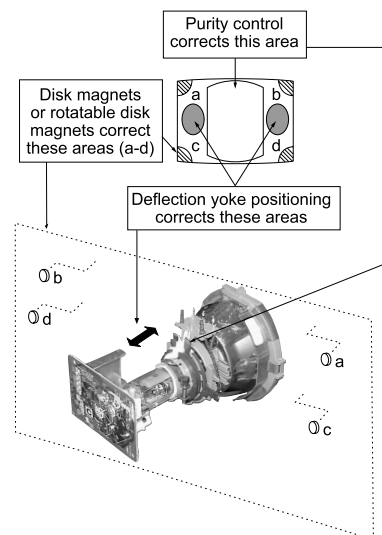
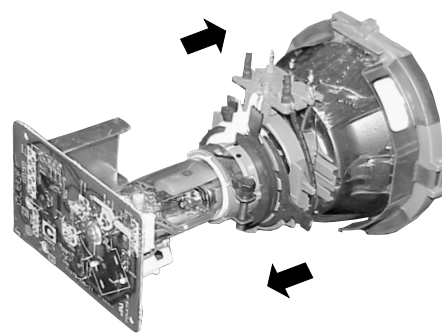

2-2. CONVERGENCE

Before starting convergence adjustments:

- 1 Perform FOCUS, VLIN and VSIZE adjustments.
2. Set BRIGHTNESS control to minimum.
3. Feed in dot pattern.

VERTICAL STATIC CONVERGENCE

1. Adjust V. STAT magnet to converge red, green and blue dots in the center of the screen (Vertical movement adjust V.STAT RV701 to converge).

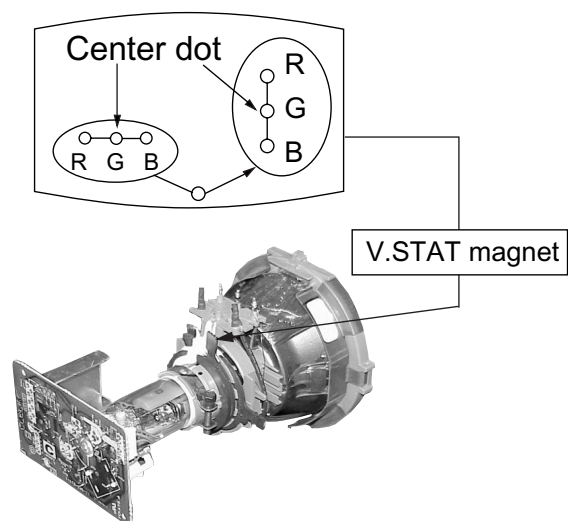

2. Tilt the V. STAT magnet and adjust static convergence to open or close the V. STAT magnet.

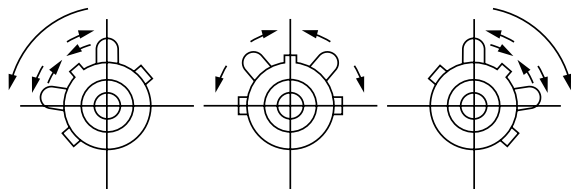

When the V. STAT magnet is moved in the direction of arrow a and b, red, green, and blue dots move as shown below:

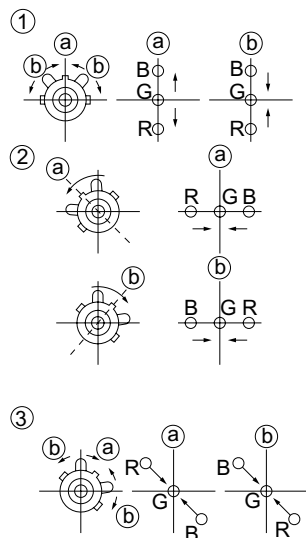

If the blue dot does not converge with the red and green dots, perform the following:

1. Move BMC magnet (a) to correct insufficient H.Static convergence.
2. Rotate BMC magnet (b) to correct insufficient V.Static convergence.
3. In either case, repeat Beam Landing Adjustment.

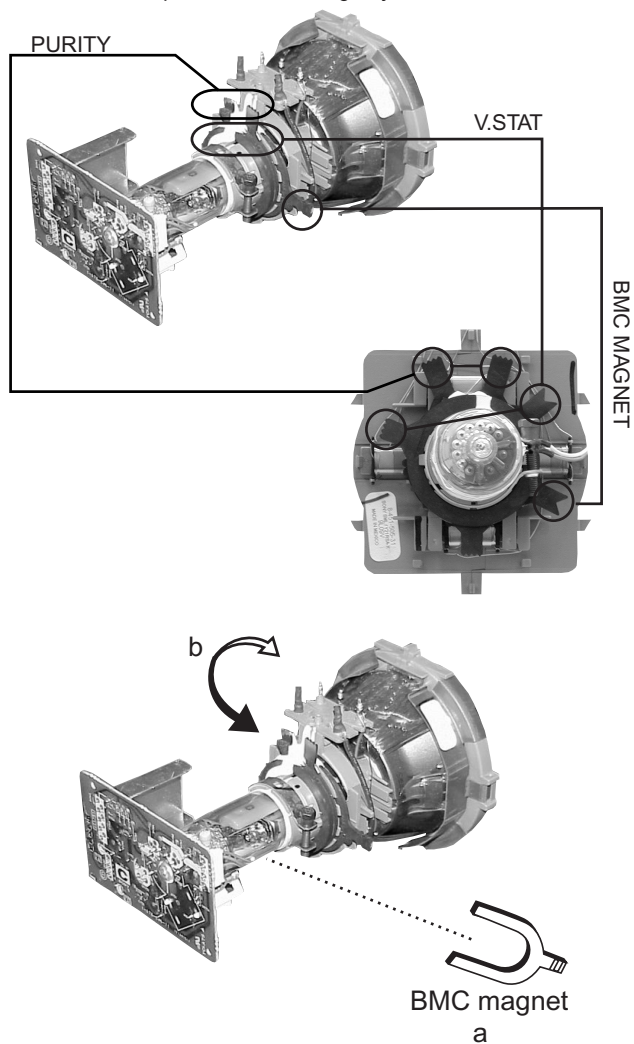

DYNAMIC CONVERGENCE ADJUSTMENT

Before performing this adjustment, perform Horizontal and Vertical Static Convergence Adjustment.

1. Slightly loosen deflection yoke screw.
2. Remove deflection yoke spacers.
3. Move the deflection yoke for best convergence as shown below:

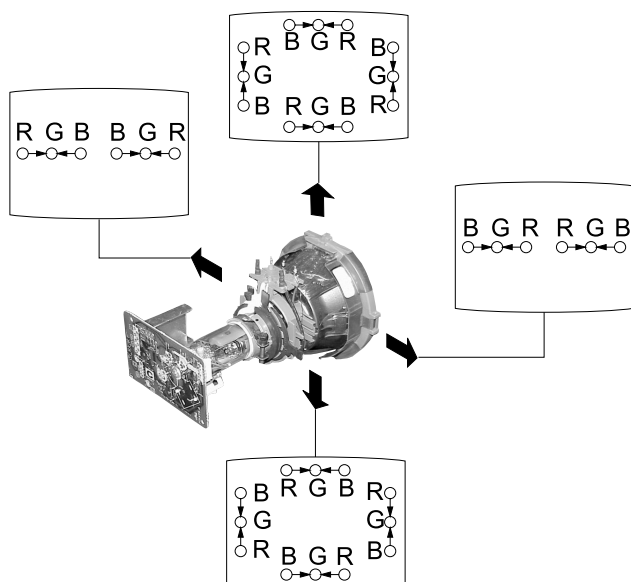

4. Tighten the deflection yoke screw.
5. Install the deflection yoke spacers.

SCREEN-CORNER CONVERGENCE

1. Affix a permalloy assembly corresponding to the misconverged areas:

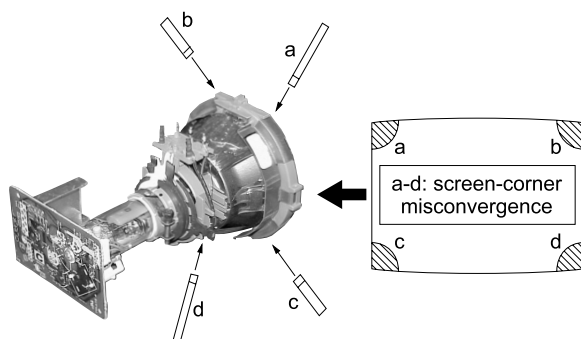

2-3. FOCUS

1. Adjust FOCUS control for best pictures.

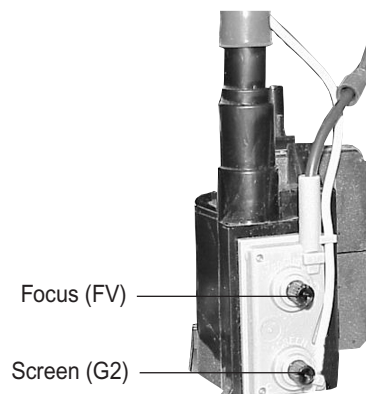

2-4. SCREEN (G2)

1. Input a dot pattern.
2. Set the PICTURE and BRIGHTNESS controls at minimum and COLOR control at normal.
3. Adjust SBRT, GCUT, BCUT in service mode with an oscilloscope as shown below so that voltages on the red, green, and blue cathodes are 170 ± 2 VDC.

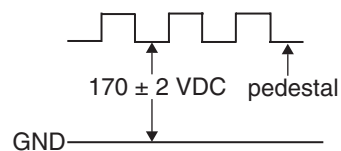

4. Observe the screen and adjust SCREEN (G2) VR to obtain the faintly visible background of dot signal.

2-5. METHOD OF SETTING THE SERVICE ADJUSTMENT MODE

SERVICE MODE PROCEDURE

1. Standby mode (power off).
2. Press **[Display]** → Channel **[5]** → Sound Volume **[+]** → Power on the Remote Commander (press each button within a second).

SERVICE ADJUSTMENT MODE IN

1. The CRT displays the time being adjusted.

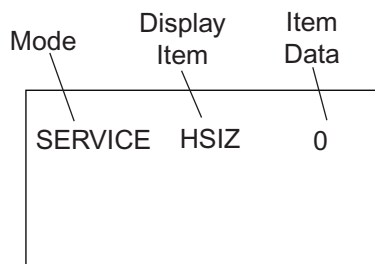

2. Press **[1]** or **[4]** on the Remote Commander to select the time.
3. Press **[3]** or **[6]** on the Remote Commander to change the data.
4. Press **[MUTING]** then **[ENTER]** to save into the memory.

SERVICE ADJUSTMENT MODE MEMORY

Turn the set off then on to exit Service Adjustment Mode.

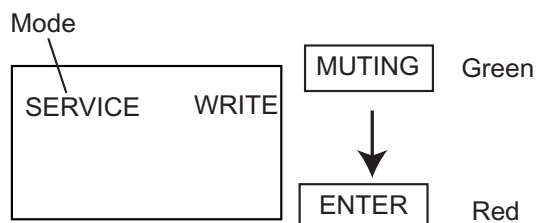



2-6. WHITE BALANCE ADJUSTMENTS

1. Input an entire white signal.
2. Set to Service Adjustment Mode.
3. Set DCOL to "0".
4. Set the PICTURE and BRIGHTNESS to minimum.
5. Adjust with SBRT if necessary.
6. Select GCUT and BCUT with **[1]** and **[4]**.
7. Adjust with **[3]** and **[6]** for the best white balance.
8. Set the PICTURE and BRIGHTNESS to maximum.
9. Select GDRV and BDRV with **[1]** and **[4]**.
10. Adjust with **[3]** and **[6]** for the best white balance.
11. Reset DCOL to "1".
12. To write into memory, press **[MUTING]** then **[ENTER]**.

SECTION 3: SAFETY RELATED ADJUSTMENTS

3-1. R582 CONFIRMATION METHOD (HOLD-DOWN CONFIRMATION) AND READJUSTMENTS

The following adjustments should always be performed when replacing the following components which are marked with  on the schematic diagram:

Part Replaced ()	Adjustment ()
DY, C511, C574, C575, D572, D573, D574, R582, R583, R584, R585, R586, R578, R625, R626, R640, R635, T504, IC301, IC521, IC602.....A Board	HV HOLD-DOWN R582

PREPARATION BEFORE CONFIRMATION

1. Turn the POWER switch ON. Input a white signal and set the PICTURE and BRIGHTNESS controls to maximum.
2. Confirm that the voltage between C574 (+) and ground is more than 99.8 VDC when set is operating normally with 120 +/- 2 VAC.

HOLD-DOWN OPERATION CONFIRMATION

1. Connect the current meter between Pin 11 of the FBT (T504) and the PWB land where Pin 11 would normally attach (See Figure 1 on the next page).
2. Input a dot signal and set PICTURE and BRIGHTNESS to minimum: IABL = 95 + 100/-95µA.
3. Confirm the voltage of A Board TP-600 is 117 ± 0.3 VDC.
4. Connect the digital voltmeter and the DC power supply via Diode 1SS119 to C574 (+) and ground (See Figure 1 on next page).
5. Increase the DC power voltage gradually until the picture blanks out.
6. Turn DC power source off immediately.
7. Read the digital voltmeter indication (standard: less than or equal to 127.3 VDC).
8. Input a white signal and set PICTURE and BRIGHTNESS to maximum: (standard: less than or equal to 127.3 VDC).
9. Repeat steps 4 to 7.

HOLD-DOWN READJUSTMENT



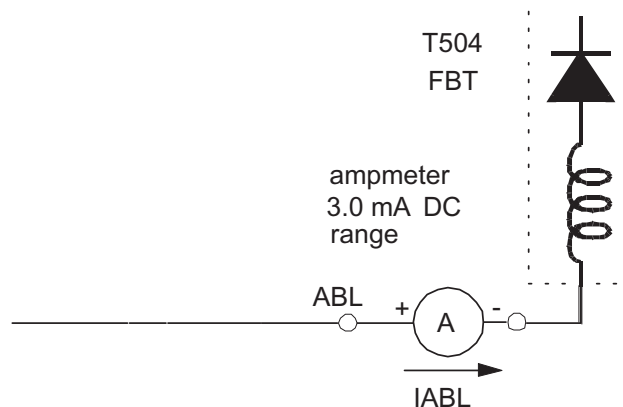



If the setting indicated in Step 2 of Hold-Down Operation Confirmation cannot be met, readjustment should be performed by altering the resistance value of R582 component marked with .



3-2. B+ VOLTAGE CONFIRMATION AND ADJUSTMENT

Note: The following adjustments should always be performed when replacing the following components, which are marked with  on the schematic diagram on the A Board:

A BOARD: IC001, IC602, R030, R625, R626, R632, R633, R635, R636, R637, R638, R639

1. Supply 130 +2.0 / -0.0V to the set with a variable auto transformer.
2. Input a dot signal.
3. Set the PICTURE and the BRIGHTNESS controls to minimum.
4. Set to Service Adjustment Mode.
5. Select PADJ with  and .
6. Adjust with  to the 0 level.
7. Confirm the voltage of A Board TP-600 is <125 VDC.
8. If step 7 is not satisfied, replace the components listed above, then repeat the above steps.
9. Supply 130 +2.0 / -0.0V to the set with a variable auto transformer.
10. Adjust with  and  for 117.0 ± 0.3 VDC.
11. Press  then  to save into the memory.

SECTION 4: CIRCUIT ADJUSTMENTS

ELECTRICAL ADJUSTMENTS BY REMOTE COMMANDER

Use the Remote Commander (RM-Y155) to perform the circuit adjustments in this section.

Test Equipment Required: 1. Pattern generator 2. Frequency counter 3. Digital multimeter 4. Audio oscillator

4-1. SETTING THE SERVICE ADJUSTMENT MODE

- Standby mode (Power off).
- Press the following buttons on the remote commander within a second of each other:

[Display] → Channel [5] → Sound Volume [+] → Power

SERVICE ADJUSTMENT MODE ON

- The CRT displays the item being adjusted.

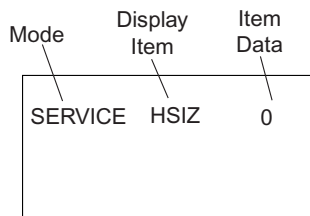

- Press [1] or [4] on the Remote Commander to select the item.
- Press [3] or [6] on the Remote Commander to change the data.
- Press [MUTING] then [ENTER] to write into memory.

SERVICE ADJUSTMENT MODE MEMORY

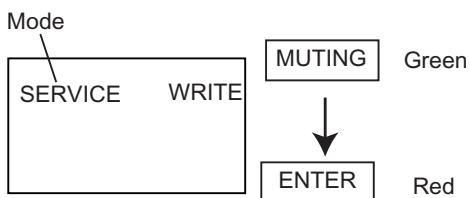

- Press [8] then [ENTER] on the Remote Commander to initialize.

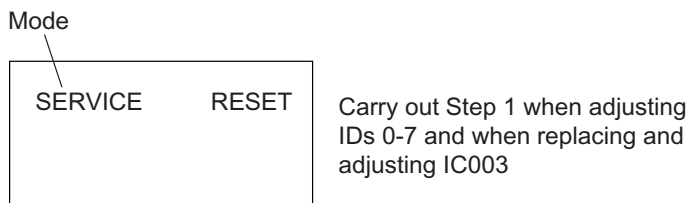

- Turn set off then on to exit service adjustment mode.

4-2. MEMORY WRITE CONFIRMATION METHOD

- After adjustment, pull out the plug from the AC outlet, then replace the plug in the AC outlet again.
- Turn the power switch ON and set to Service Mode.
- Call the adjusted items again to confirm they were adjusted.

4-3. REMOTE ADJUSTMENT BUTTONS AND INDICATORS

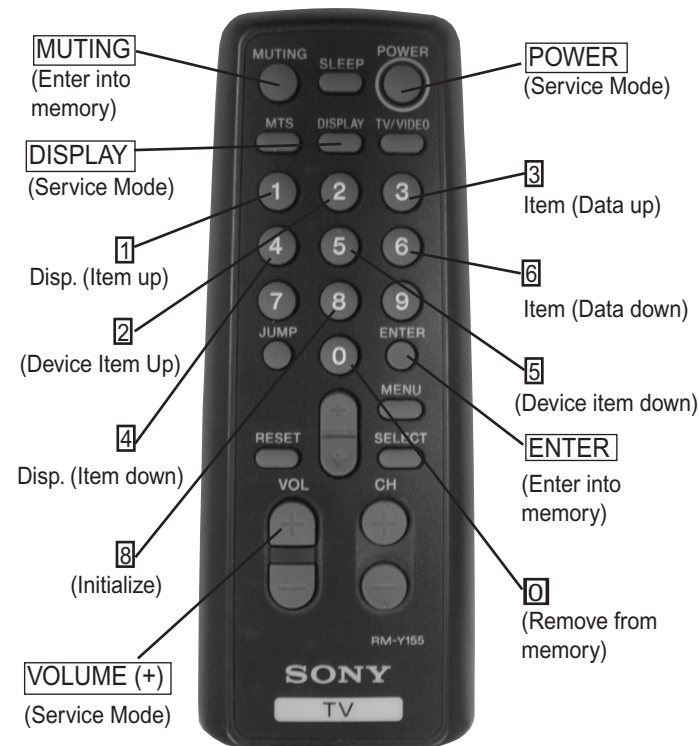

RM-Y155

ADJUSTMENT ITEMS (1 OF 2)

Reg #	ITEM	FUNCTION	DATA RANGE	INITIAL DATA	VIDEO	AVERAGE DATA
1	HSIZ	Horizontal Amp. Adjustment	0-31	31		31
2	HPOS	Horizontal Position Adjustment	0-31	21		20
3	VBOW	Vertical Line Bowing Adj.	0-15	6		6
4	VANG	Vertical line Bowing Slant Adj.	0-15	6		6
5	TRAP	Horizontal Trapezoid Adj.	0-15	15		15
6	PAMP	Horizontal PIN Distortion Adj.	0-31	31		31
7	CPIN	SAME AS PAMP-SCRN TP/BTM	0-31	31		31
8	VSIZ	Vertical Amp. Adjustment	0-31	43		37
9	VPOS	Vertical Position Adj.	0-31	35		38
10	VLIN	Vertical Linearity Adj.	0-15	7		7
11	SCOR	Vertical Amount Adj.	0-15	7		7
12	VZOM	Vertical Zooming	0,1	0		0
13	EHT	Vertical High-Voltage Correction	0-15	15		4
14	ASP	Aspect Ratio Control	0-63	47		47
15	SCRL	16:9 CRT Z Mode Trans. Scroll	0-31	31		31
16	HBLK	RGB Out Width Control	0,1	1		1
17	LBLK	Left Screen HBLK Control	0-15	15		15
18	RBLK	RGT Screen HBLK Control	0-15	3		3
19	VUSN	V Saw Waveform Compress	0,1	0		0
20	HDW	Horizontal Drive Pulse Width	0,1	1		0
21	EWDC	EW/ D.C. Adjustment	0,1	0		0
22	LVLN	Lower Screen BTM Vertical Line Adj.	0-15	0		0
23	UVLN	Upper Screen Top Vertical Line Adj.	0-15	0		0
24	RDRV	R Output Drive Control	0-31	30		27
25	GDRV	G Output Drive Control	0-31	24		22
26	BDRV	B Output Drive Control	0-31	21		22
27	RCUT	R Output Cutoff Control	0-15	10		9
28	GCUT	G Output Cutoff Control	0-15	7		4
29	BCUT	B Output Cutoff Control	0-15	7		4
30	DCOL	Dynamic Color On/Off	0,1	0		0
31	SHUE	Sub HUE	0-15	15		18
32	SCOL	Sub Color	0-15	14		18
33	SBRT	Sub BRIGHTNESS	0-15	7		10
34	RON	R Output On/Off	0,1	1		1
35	GON	G Output On/Off	0,1	1		1
36	BON	B Output On/Off	0,1	1		1
37	AXPL	Axis PAL	0,1	0		0
38	AXNT	Axis NTSC	6.00 ± 0.8	0		0
39	CBPF	Chroma BPF On/Off	0,1	1		1
40	CTRP	Y TRAP FILTER On/Off	6.00 ± 0.9	0		1
41	COFF	Color On/Off	0,1	0		0
42	KOFF	Set Color Killer	6.00 ± 0.8	0		0
43	SSHP	Sub SHARPNESS	0-15	9		6
44	SHPF	SHARPNESS Circuit Fo	0,1	1	1	*
45	PREL	Pre-Shoot / Over-Shoot Switching	0,1	1		1
46	Y-DC	Axis NTSC	0,1	1		1
47	GAMM	Chroma BPF On/Off	0,1	0		0
48	VTH	Color On/Off	0,1	1		1
49	ABLM	ABL Control Mode	0,1	1		1
50	YDEL	Set Color Killer	0,1	7		7
51	NCOL	Sub Sharpness	0-15	1		1

* = TV/VIDEO = 0

ADJUSTMENT ITEMS (2 OF 2)

Reg #	ITEM	FUNCTION	DATA RANGE	INITIAL DATA	VIDEO	AVERAGE DATA
52	FSC	G Output On/Off	0,1	0		1
53	K-ID	B Output On/Off	0,1	0		0
54	HOSC	Horizontal VCO Oscillation Freq.	0-15	10		7
55	VSS	Vertical Sync Slice Level	0,1	0		0
56	HSS	Horizontal Sync Slice Level	0,1	0		0
57	HMSK	HMASK On/Off	0,1	1		1
58	VTMS	Select Signal VTIM Pin	0-3	0		0
59	CDMD	Vertical Count Down Mode Switching	0-3	3	3	**
60	AFC	AFC Loop Gain Switching	0-3	0	0	*
61	FIFR	Field Frequency	0-3	3		3
62	SBAS	Sub Bass	0-15	8		8
63	STRE	Sub Treble	0-15	9		9
64	SBAL	Sub Balance	0-15	13		13
65	DISP	O.S.D Display Position	0-127	15		5
66	PADJ	POWER ADJUSTMENT	0-63	51		42
67	HCHM	H SYNCH SEP. LIMIT FOR TUNER	0-127	69		69
68	HCLM	H SYNCH SEP. LIMIT FOR TUNER	0-127	16		16
69	HCHS	H SYNCH SEP. LIMIT FOR VIDEO	0-127	69		69
70	HCLS	H SYNCH SEP. LIMIT FOR VIDEO	0-127	16		16
71	ID0		0-255			SEE ID MAP
72	ID1		0-255			SEE ID MAP
73	ID2		0-255			SEE ID MAP
74	ID3		0-255			SEE ID MAP
75	ID4		0-255			SEE ID MAP
76	ID5		0-255			SEE ID MAP
77	ID6		0-255			SEE ID MAP
78	ID7		0-255			SEE ID MAP

* = TV/VIDEO = 0

** = TV = 0, VIDEO = 1

Notes:

No. 1-78 show the order that each adjustment mode may be selected while in Service Mode.

Data Range shows the range of possible setting for each Adjustment Mode.

Initial Data shows the standard settings for each Adjustment Mode.

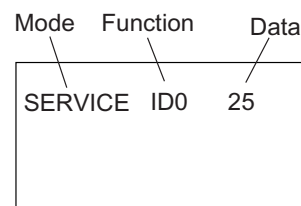

ID MAP

Model	Destination	ID-0	ID-1	ID-2	ID-3	ID-4	ID-5	ID-6	ID-7
KV-20S90	US	25	3	1	227	3	1	0	0
KV-21SE43C	E	17	3	1	195	115	1	0	0

4-4. A BOARD ADJUSTMENTS

H. FREQUENCY ADJUSTMENT

1. InputTV mode (RF) with no signal.
2. Set to Service Adjustment Mode.
3. Connect a frequency counter to base of Q501 (TP-500 H. DRIVE).
4. Check H. Frequency for 15735 ± 200 Hz.
5. Press **[MUTING]** then **[ENTER]** to save into the memory.

V. FREQUENCY CHECK

1. Select video 1 with no signal input.
2. Set the conditions for a standard setting.
3. Connect the frequency counter to TP-508 or CN501 pin ⑥ (V DY+) connector and ground.
4. Check that V. Frequency shows 60 ± 4 Hz.

SUB CONTRAST ADJUSTMENT (RDRV)

1. Input a color-bar signal.
2. Set the red color on (1).
3. Set in Service Adjustment Mode.
4. Select the item DCOL level to 0.
5. Set the conditions as follows:

PICTURE: MAX
 COLOR: MIN
 BRIGHT: CENTER
 R ON: ON (1)
 G ON: OFF (0)
 B ON: OFF (0)

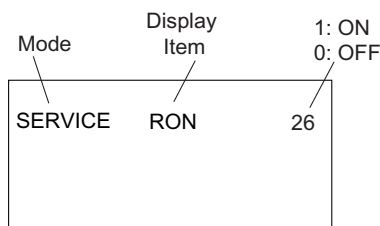

6. Connect an oscilloscope probe to CN301 pin ② (Red Out) and ground.
7. Select RDRV with **1** and **4**.
8. Adjust the value of RDRV with **3** and **6** for 1.50 ± 0.05 Vpp.

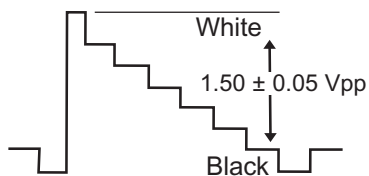

9. Reset the item DCOL to 1.
10. Press **MUTING** then **ENTER** to save into the memory.
11. Return the following back to normal after adjustment.

PICTURE: MAX
 COLOR: CENTER
 BRIGHT: CENTER
 R ON: ON (1)
 G ON: OFF (1)
 B ON: OFF (1)

DISPLAY POSITION ADJUSTMENT (DISP)

1. Input a color-bar signal.
2. Set to Service Adjustment Mode.
3. Select DISP with **1** and **4**.
4. Adjust values of DISP with **3** and **6** to adjust characters to the center.
5. Write to memory by pressing **MUTING** then **ENTER**.
6. Check to see if the text is displayed on the screen.

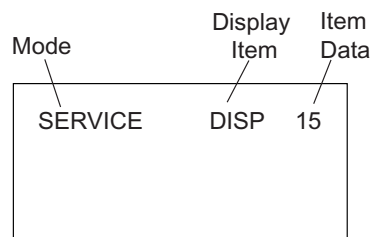

SUB BRIGHT ADJUSTMENT (SBRT)

1. Input a crosshatch signal.
2. Set to Service Adjustment Mode.
3. Set the PICTURE and BRIGHTNESS to minimum.
4. Select the SBRT item with **1** and **4**.
5. Adjust the values of SBRT with **3** and **6** to obtain a faintly visible crosshatch.
6. Press **MUTING** then **ENTER** to save into the memory.

SUB HUE, SUB COLOR ADJUSTMENT (SHUE, SCOL)

1. Input a color-bar signal.
2. Set to Service Adjustment Mode.
3. Connect a probe to TP47B B-OUT (C Board).
4. Measure white V1 and blue V4.
 - 4.1) Increase SCOL Register +1 setp.

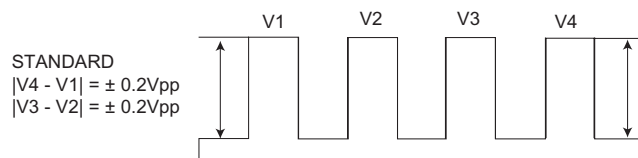

5. Press **MUTING** then **ENTER** to save into the memory.

V. SIZE ADJUSTMENT (VSIZ)

1. Input a crosshatch signal.
2. Activate the Service Adjustment Mode.
3. Select the VSIZ item with **1** and **4**.
4. Adjust value of VPOS with **1** and **4** for the best vertical center.
5. Press **MUTING** then **ENTER** to save into the memory.

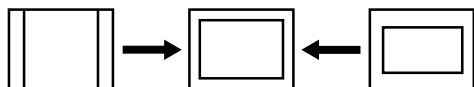

V. CENTER ADJUSTMENT (VPOS)

1. Input a crosshatch signal.
2. Set to Service Adjustment Mode.
3. Select the VPOS item with **1** and **4**.
4. Adjust value of VPOS with **3** and **6** for the best vertical center.
5. Press **MUTING** then **ENTER** to save into the memory.

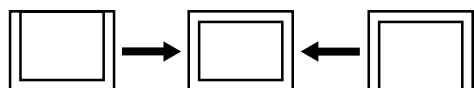

H. CENTER ADJUSTMENT (HPOS)

Perform this adjustment after performing H. Frequency.

1. Input a crosshatch signal.
2. Set to Service Adjustment Mode.
3. Select the HPOS item with **1** and **4**.
4. Adjust the value of HPOS with **3** and **6** for the best horizontal center.
5. Press **MUTING** then **ENTER** to save into the memory.

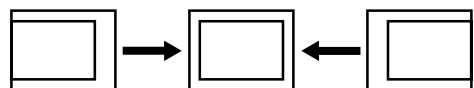

V. LINEARITY (VLIN), V. CORRECTION

1. Input a crosshatch signal.
2. V.Correction is automatically adjusted from the circuit and should satisfy the conditions below.

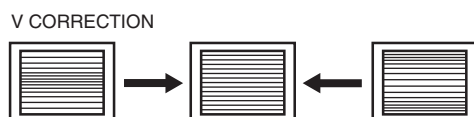
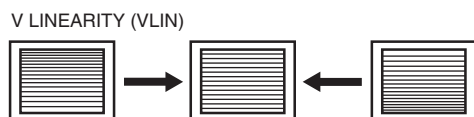

SERVICE ADJUSTMENT MODE MEMORY

1. Change the value of the DCOL item to 1.
2. After completing all adjustments, press **0** then **ENTER**.

Read From Memory

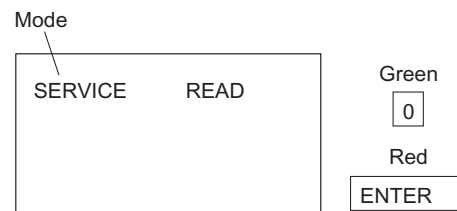

SECTION 5: DIAGRAMS

5-1. CIRCUIT BOARDS LOCATION

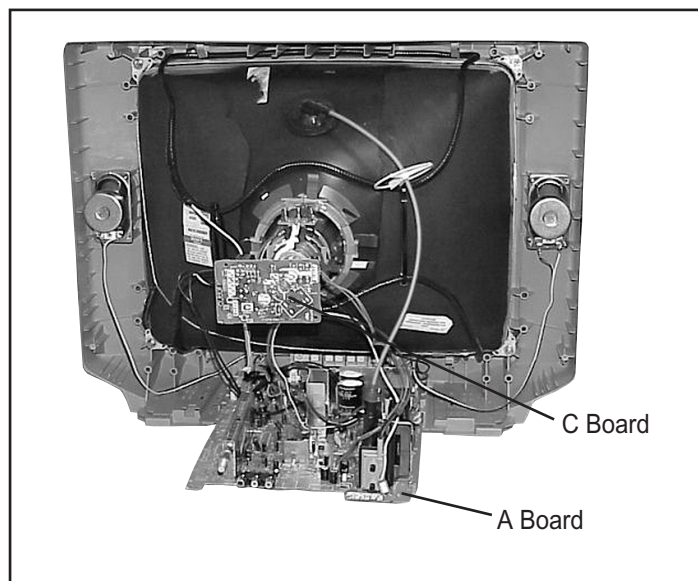

5-2. PRINTED WIRING BOARD AND SCHEMATIC DIAGRAM INFORMATION

All capacitors are in μF unless otherwise noted. pF : μF 50WV or less are not indicated except for electrolytics and tantalums.

All electrolytics are in 50V unless otherwise specified.

All resistors are in ohms. K=1000, M=1000k

Indication of resistance, which does not have one for rating electrical power, is as follows:

Pitch : 5mm

Rating electrical power : $\frac{1}{4}$ W

$\frac{1}{4}$ W in resistance, $\frac{1}{10}$ W and $\frac{1}{8}$ W in chip resistance.

: nonflammable resistor.

: fusible resistor.

: internal component.

: panel designation and adjustment for repair.

All variable and adjustable resistors have characteristic curve B, unless otherwise noted.

Readings are taken with a color-bar signal input.

Readings are taken with a 10M digital multimeter.

Voltages are DC with respect to ground unless otherwise noted.

Voltage variations may be noted due to normal production tolerances.

All voltages are in V.

S : Measurement impossibility.

: B+line.

B-line. (Actual measured value may be different).

: signal path. (RF)

Circled numbers are waveform references.

The components identified by in this basic schematic diagram have been carefully factory-selected for each set in order to satisfy regulations regarding X-ray radiation. Should replacement be necessary, replace only with the value originally used.

When replacing components identified by , make the necessary adjustments as indicated. If the results do not meet the specified value, change the component identified by and repeat the adjustment until the specified value is achieved. (Refer to Safety Related Adjustments on Page 14.)

When replacing the parts listed in the table below, it is important to perform the related adjustments.

Part Replaced ()	Adjustment ()
DY, C511, C574, C575, D572, D573, D574, R582, R583, R584, R585, R586, R578, R625, R626, R640, R635, T504, IC301, IC521, IC602.....A Board	HV HOLD-DOWN R582

REFERENCE INFORMATION

RESISTOR	: RN	METAL FILM
	: RC	SOLID
	: FPRD	NONFLAMMABLE CARBON
	: FUSE	NONFLAMMABLE FUSIBLE
	: RW	NONFLAMMABLE WIREWOUND
	: RS	NONFLAMMABLE METAL OXIDE
	: RB	NONFLAMMABLE CEMENT
	:	ADJUSTMENT RESISTOR
COIL	: LF-8L	MICRO INDUCTOR
CAPACITOR	: TA	TANTALUM
	: PS	STYROL
	: PP	POLYPROPYLENE
	: PT	MYLAR
	: MPS	METALIZED POLYESTER
	: MPP	METALIZED POLYPROPYLENE
	: ALB	BIPOLAR
	: ALT	HIGH TEMPERATURE
	: ALR	HIGH RIPPLE

The components identified by shading and symbol are critical for safety. Replace only with part number specified.

The symbol indicates a fast operating fuse and is displayed on the component side of the board. Replace only with fuse of the same rating as marked.

Les composants identifiés par un trame et une marque sont critiques pour la sécurité. Ne les remplacer que par une pièce portant le numéro spécifié.

Le symbole indique une fusible à action rapide. Doit être remplacé par une fusible de même valeur, comme marqué.

BLOCK DIAGRAM

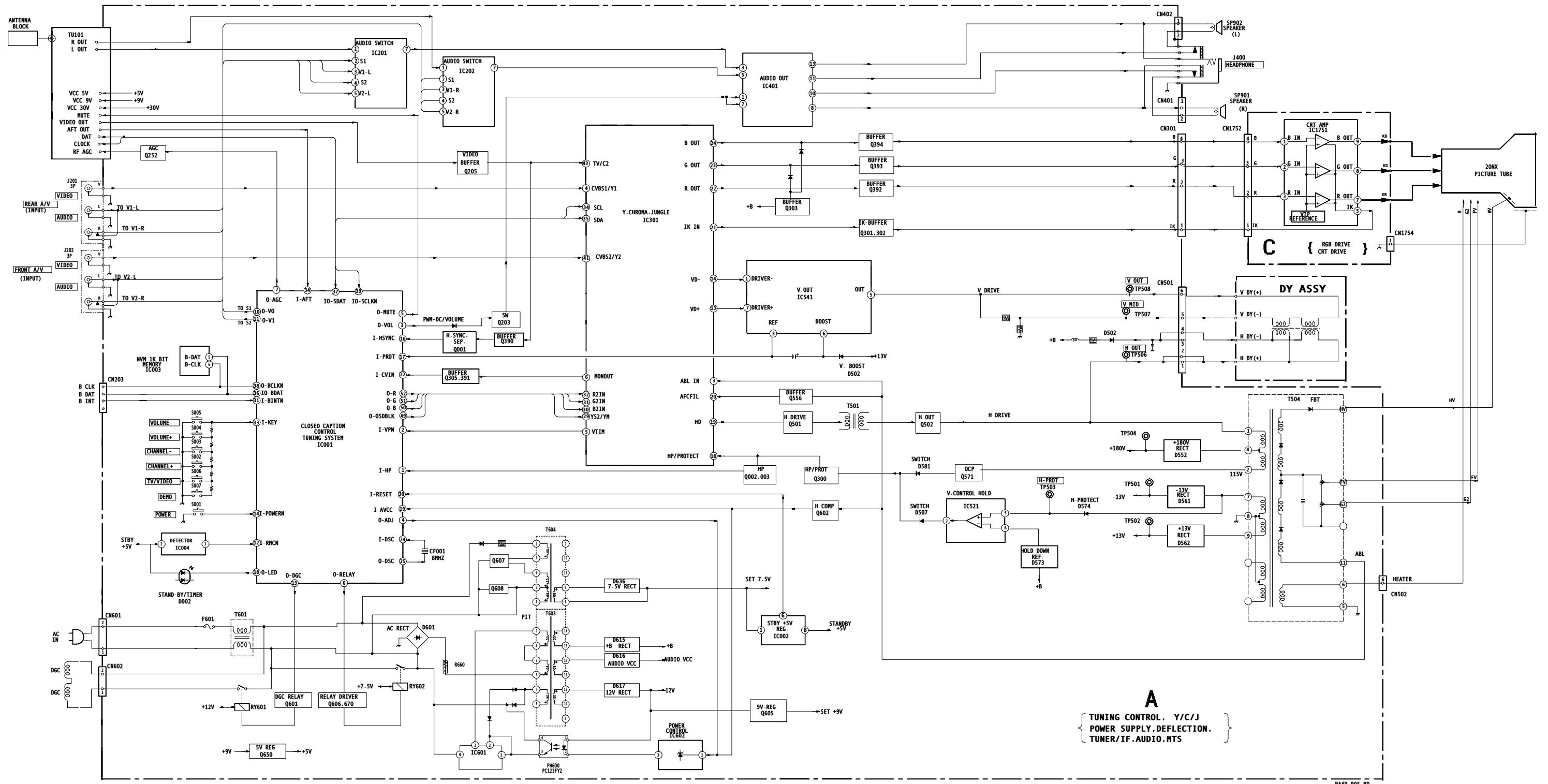

A BOARD SCHEMATIC DIAGRAM

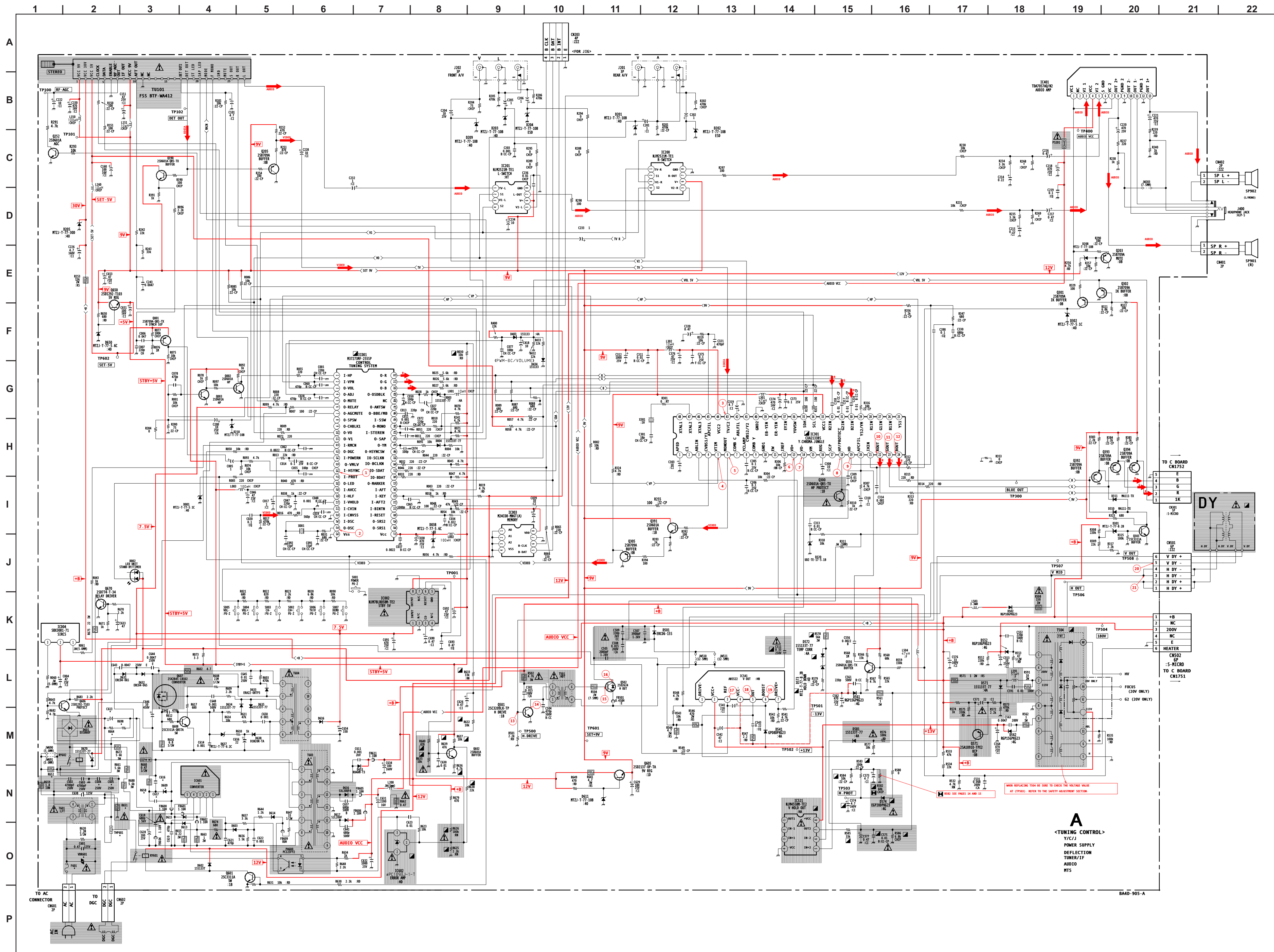

(*) A BOARD VARIANT MODEL LIST

REF. NO.	LOCATION	KV-20S90	KV-21SE43C
C604	N-2	4700pF 250V	2200pF 250V
C605	N-3	4700pF 250V	2200pF 250V
C613	M-2	470 μ F 250V	330 μ F 400V
C616	N-3	#	0.022 μ F 400V
C617	N-3	#	220PF 1KV
C638	N-1	0.47 μ F 125V	#
D609	N-3	#	RJ-1P
F601	O-1	1-533-795-11	1-532-506-51
IC601	N-3	STR-F6424	STR-F6454
R268	C-19	3.3K	4.7K
R269	D-19	3.3K	4.7K
R651	N-2	4.7M 1/2W	8.2M 1W
R652	N-1	#	1.8 10W
R658	N-3	#	100K 3W
R664	M-2	390K	270K
R698	M-2	#	270K
T603	M-5	1-433-816-11	1-433-817-11
THP601	O-2	1-810-597-11	1-809-827-11
VDR601	O-1	ENE271D-10A	ENE471D-14A

NOTE: # = Not Mounted

A BOARD WAVEFORMS

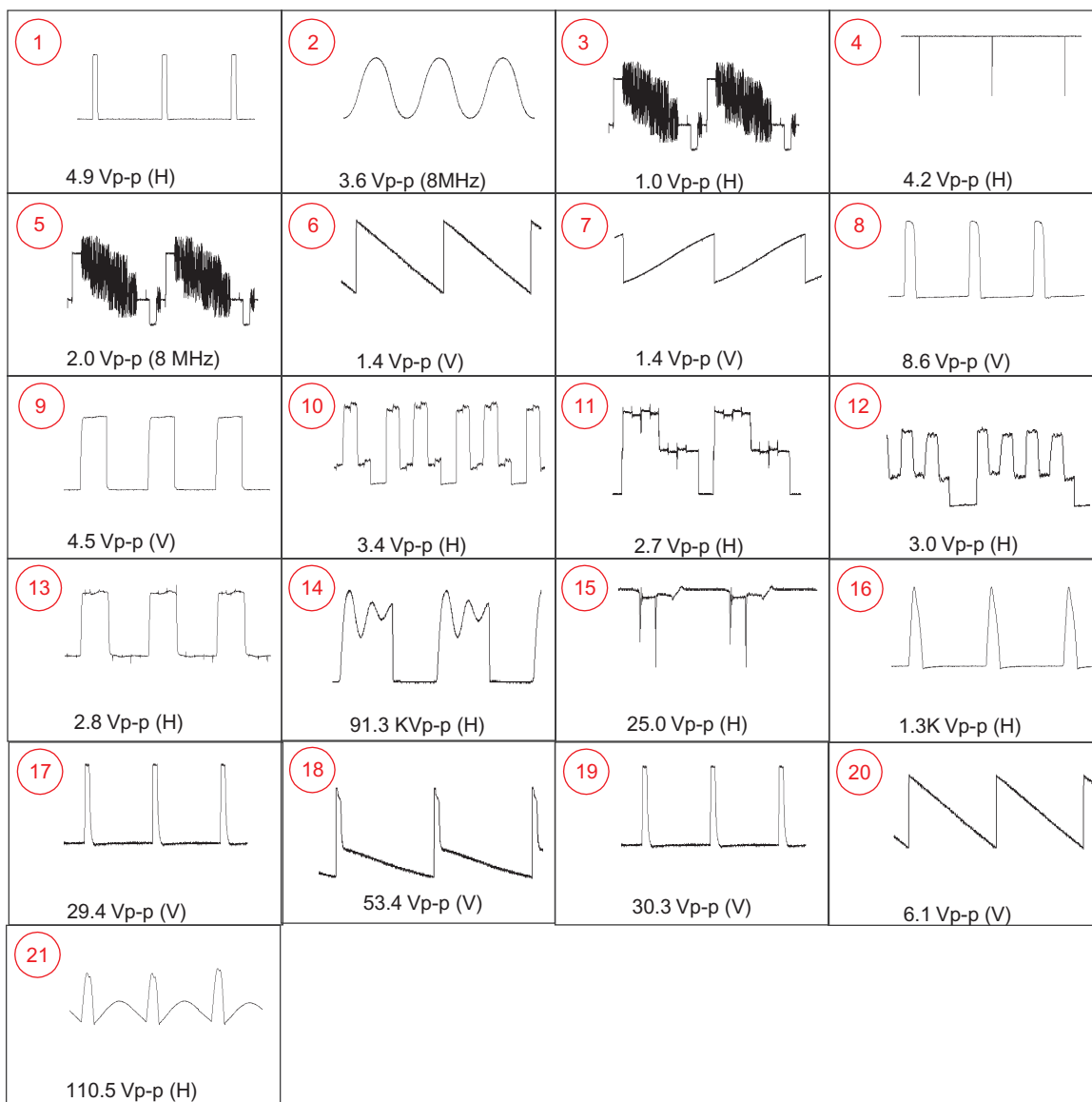

A BOARD IC VOLTAGE LIST

IC001		29	N/C	5	GND	IC201		19	3.0	IC401		4	-12.9
PIN	VOLT	30	4.9	6	4.9	PIN	VOLT	20	2.6	PIN	VOLT	5	0.0
1	0.9	31	4.9	7	GND	1	5.9	21	1.0	1	0.8	6	13.6
2	4.9	32	N/C	8	4.9	2	0.2	22	1.5	2	N/C	7	2.4
3	0.5	33	4.9	IC003		3	6.1	23	1.5	3	2.4	IC601	
4	2.0	34	2.6	PIN	VOLT	4	0.2	24	1.5	4	12.6	PIN	VOLT
5	0.0	35	N/C	1	GND	5	6.1	25	N/C	5	2.4	1	-55.3
6	0.1	36	4.9	2	GND	6	9.1	26	N/C	6	GND	2	-57.2
7	0.0	37	4.9	3	GND	7	5.3	27	N/C	7	0.8	3	94.8
8	N/C	38	4.9	4	GND	8	GND	28	N/C	8	6.5	4	-41.6
9	N/C	39	4.8	5	4.8	IC301		29	0.0	9	GND	5	-57.1
10	0.0	40	N/C	6	4.8	PIN	VOLT	30	4.6	10	6.5	IC602	
11	0.1	41	0.0	7	GND	1	3.4	31	4.6	11	6.5	PIN	VOLT
12	4.9	42	0.1	8	5.0	2	N/C	32	4.6	12	GND	1	2.5
13	0.0	43	4.9	IC004		3	1.3	33	9.0	13	6.5	2	GND
14	4.9	44	0.1	PIN	VOLT	4	5.3	34	4.9	IC521		3	10.9
15	N/C	45	N/C	1	4.9	5	4.9	35	4.9	PIN	VOLT	All Voltages are in V	
16	-0.1	46	4.9	2	4.9	6	4.5	36	N/C	1	N/C		
17	-0.3	47	N/C	3	GND	7	N/C	37	N/C	2	N/C		
18	4.9	48	N/C	IC200		8	5.1	38	N/C	3	N/C		
19	4.9	49	0.0	PIN	VOLT	9	N/C	39	N/C	4	GND		
20	1.8	50	4.6	1	5.9	10	GND	40	GND	5	8.6		
21	0.0	51	4.6	2	0.2	11	N/C	41	5.3	6	9.8		
22	2.2	52	4.6	3	6.1	12	2.4	42	7.2	7	1.3		
23	GND	IC002		4	0.2	13	3.5	43	5.5	8	12.9		
24	2.2	PIN	VOLT	5	6.1	14	3.5	44	9.1	IC541			
25	2.3	1	7.5	6	9.1	15	N/C	45	5.3	PIN	VOLT		
26	GND	2	GND	7	5.3	16	7.6	46	N/C	1	2.6		
27	4.9	3	5.4	8	GND	17	N/C	47	1.9	2	12.9		
28	N/C	4	GND			18	0.8	48	N/C	3	-11.1		

A BOARD IC BLOCK DIAGRAMS

IC521: NJM4558M-TE2

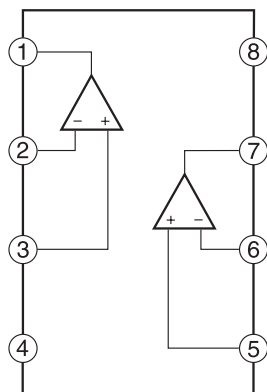

IC541: AN5522

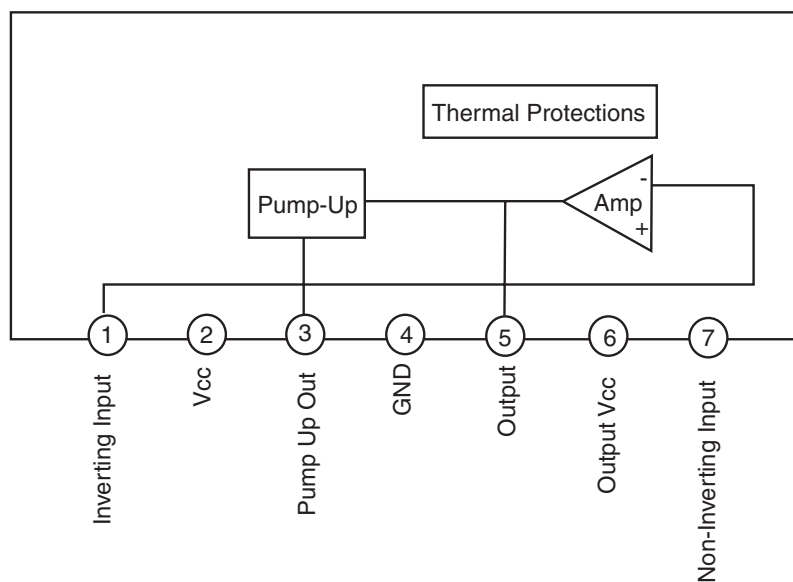

IC301: CXA2133BS

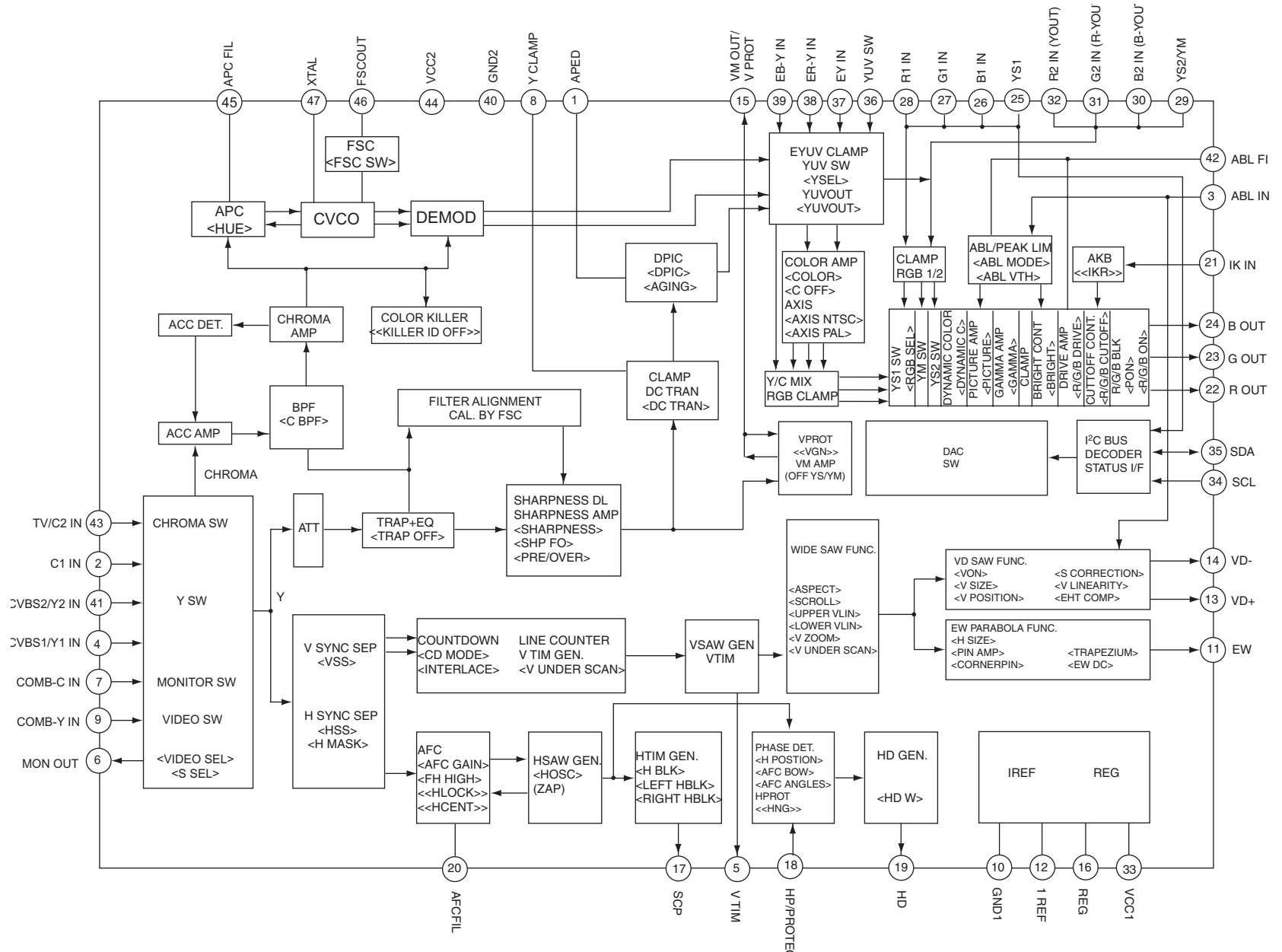

A [TUNING CONTROL, Y/C/J, POWER SUPPLY, DEFLECTION, TUNER/IF, AUDIO, MTS]

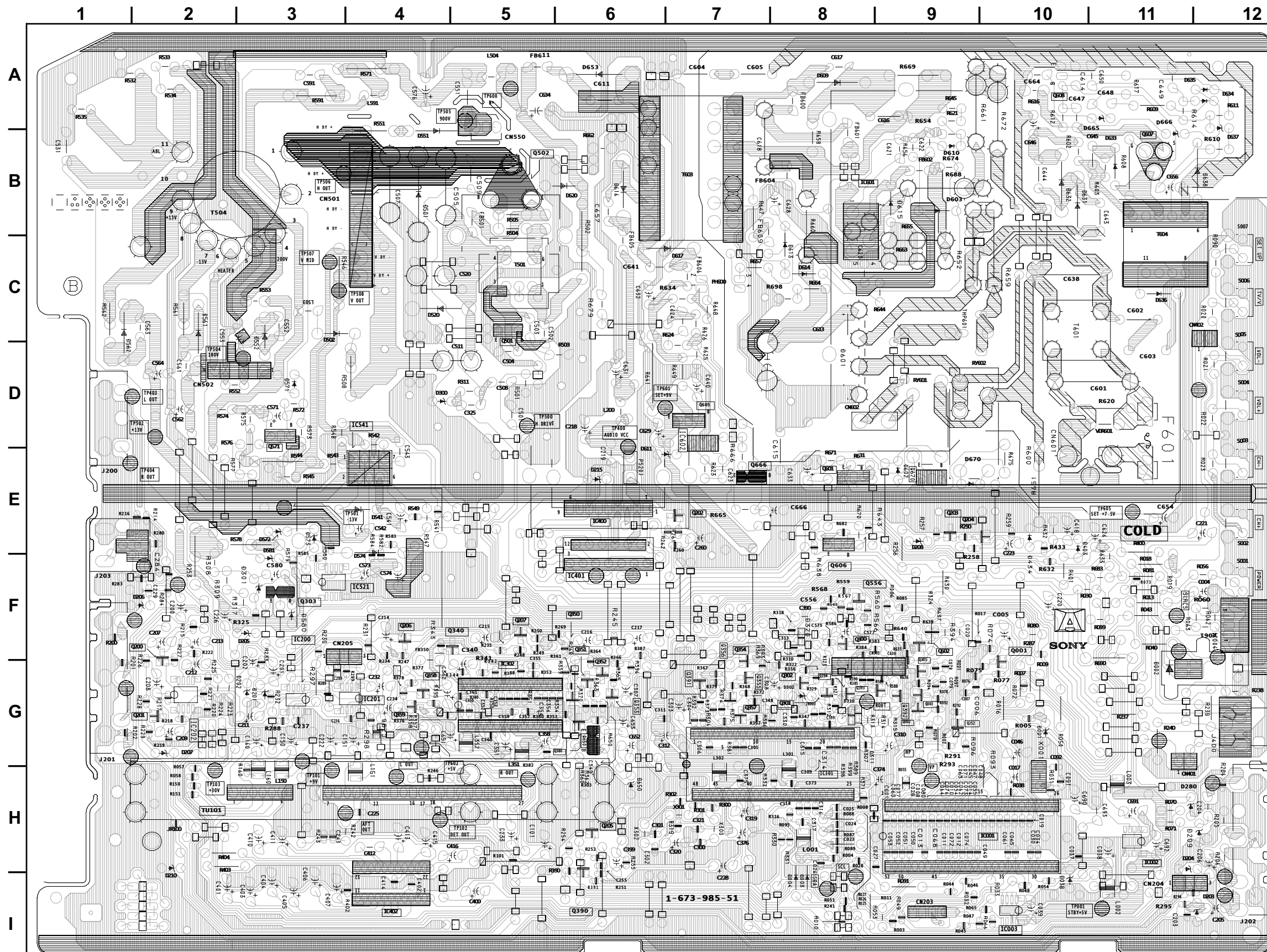

A BOARD LOCATOR LIST

DIODE		IC	
D001	G-10	IC001	H-9
D002	G-11	IC002	H-11
D003	H-8	IC003	I-10
D004	H-8	IC004	F-12
D038	H-10	IC200	F-3
D201	G-3	IC201	G-4
D203	I-11	IC301	G-7
D204	I-11	IC401	F-6
D205	F-3	IC521	F-4
D208	E-9	IC541	D-4
D209	H-11	IC601	B-8
D210	H-2	IC602	D-7
D215	E-6	TRANSISTOR	
D301	F-3	Q001	F-10
D302	G-8	Q002	G-9
D310	G-8	Q003	G-9
D311	G-8	Q202	E-7
D320	F-8	Q003	G-9
D403	E-10	Q202	E-7
D434	E-30	Q203	E-9
D501	B-4	Q205	H-6
D502	C-3	Q252	G-9
D541	E-4	Q300	F-8
D552	C-3	Q301	G-8
D561	C-2	Q302	G-7
D562	C-2	Q303	F-3
D571	D-3	Q305	F-9
D572	E-30	Q390	I-6
D573	E-30	Q391	G-7
D574	E-4	Q392	G-8
D581	E-30	Q393	G-8
D601	D-8	Q394	G-8
D602	E-9	Q501	D-5
D603	B-9	Q502	B-5
D609	A-8	Q556	F-8
D611	D-6	Q571	D-3
D613	C-8	Q601	E-8
D614	C-8	Q602	F-9
D615	B-9	Q605	D-7
D616	B-6	Q606	F-8
D617	B-7	Q607	B-11
D631	B-10	Q608	A-10
D632	B-10	Q650	G-6
D633	B-11	Q670	E-9
D634	A-12	CRYSTALS	
D635	A-11	X001	G-10
D636	C-11	X301	H-7
D637	B-12		
D638	B-12		
D650	G-6		
D653	A-9		
D670	E-9		

C BOARD SCHEMATIC DIAGRAM

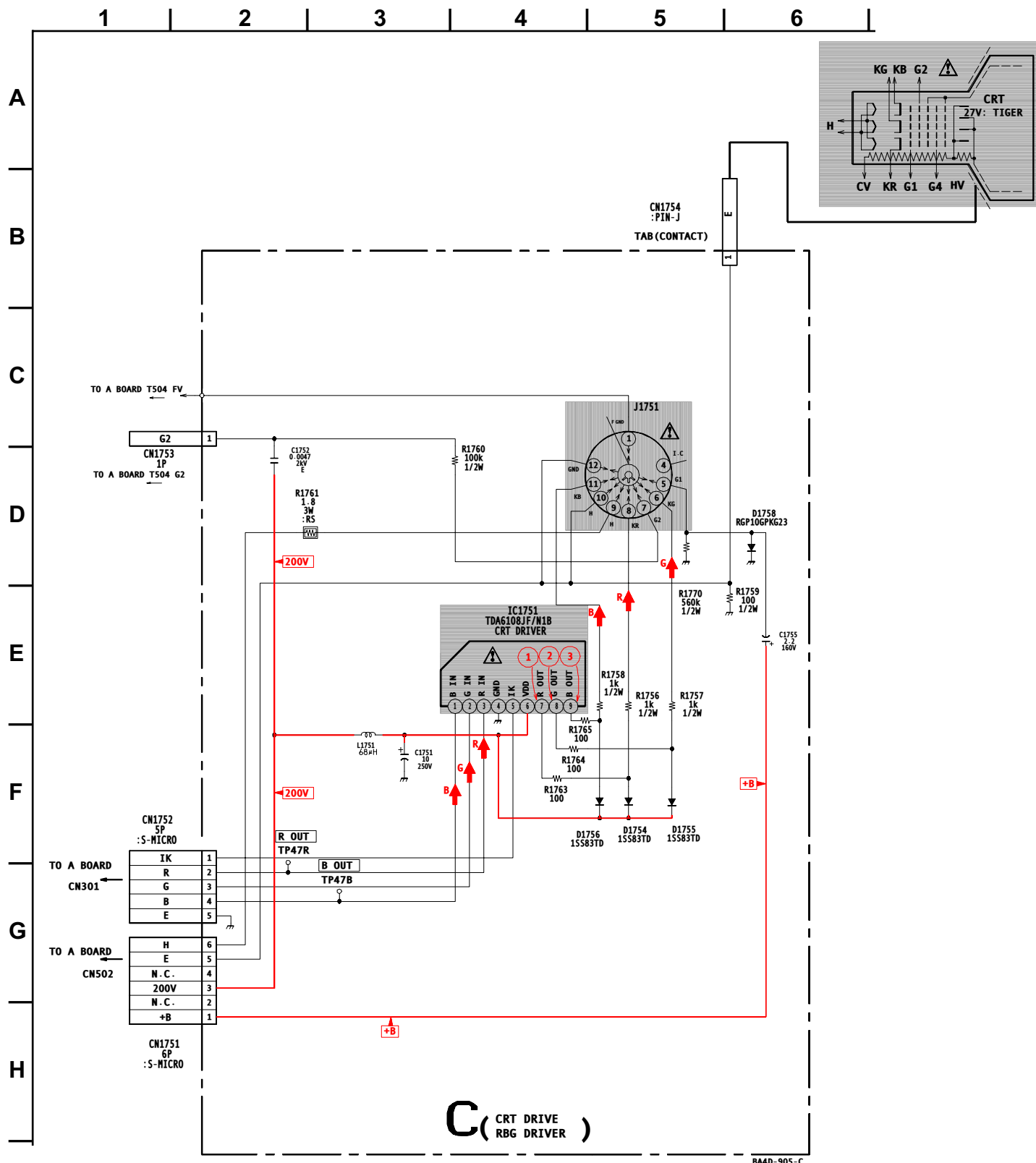

C [RGB DRIVE, CRT DRIVE]

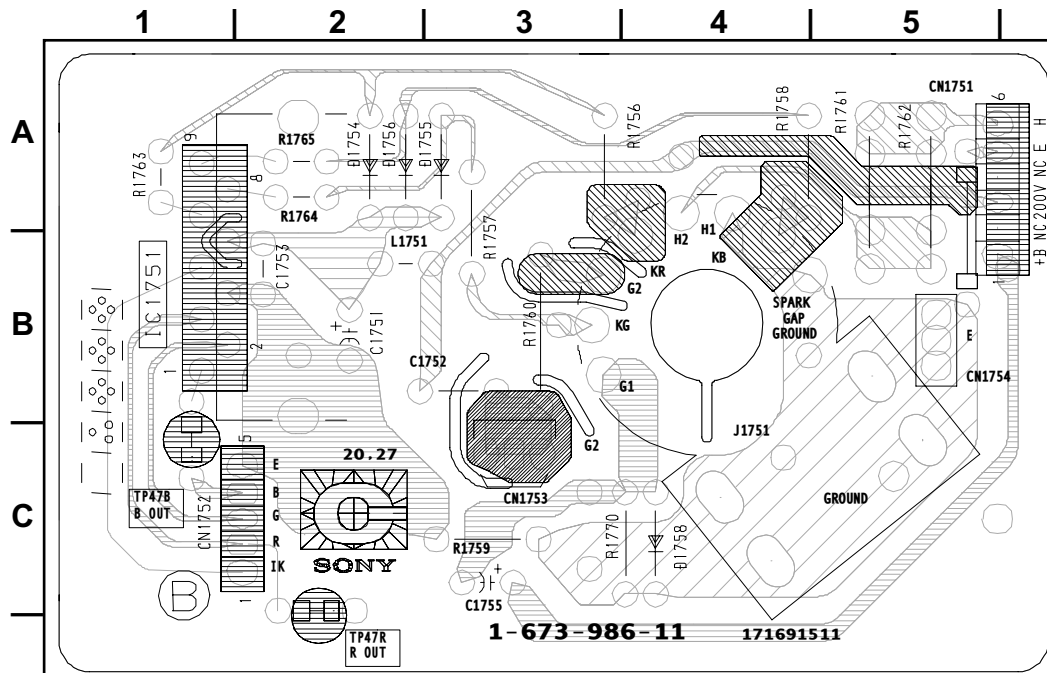

C BOARD WAVEFORMS

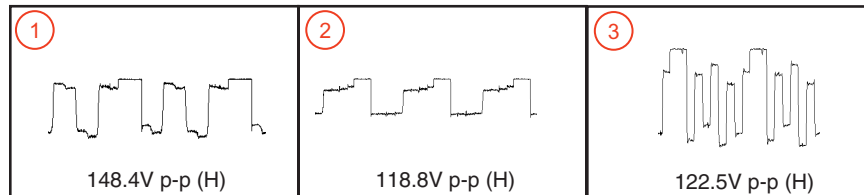

C BOARD IC VOLTAGE LIST

IC1751	
PIN	VOLT
1	2.1
2	2.2
3	2.1
4	GND
5	3.7
6	193.4
7	146.5
8	133.8
9	134.9

5-4. SEMICONDUCTORS

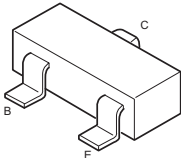
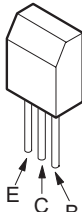
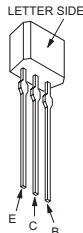
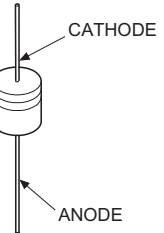
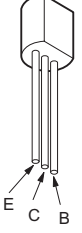
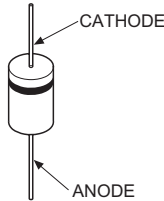
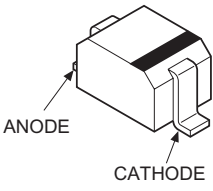
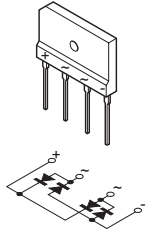
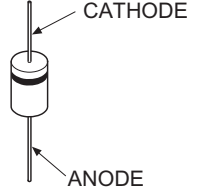
<p>2SB709A-QRS-TX 2SD601A-QRS-TX</p> 	<p>2SC3209LK-TP</p> 	<p>2SC3311A-QRSTA</p> 	<p>1SS133T-77 D1N20R-TA 11EQS04-NTA1B</p> 	<p>2SA10910-TPE2 2SD1292-T103</p> 
<p>1SS83TD GP08DPKG23 RU4AM-T3 RGP10GPKG23</p> 	<p>MA111-TX UDZ-TE-17.5.1B</p> 	<p>D3SB60F</p> 	<p>RU-1P ERC04-06S ERC06-15S EGP20DPKG23 MTZJ-T-77-5.1C MTZJ-T-77-5.6C MTZJ-T-77-10B MTZJ-T-77-30D MTZJ-T-77-8.2B RGP15GPKG23 S2L20UF S3L20UF4</p> 	

SECTION 6: EXPLODED VIEWS

Components not identified by a part number or description are not stocked because they are seldom required for routine service.

The component parts of an assembly are indicated by the reference numbers in the far right column of the parts list and within the dotted lines of the diagram.

* Items marked with an asterisk are not stocked since they are seldom required for routine service. Expect some delay when ordering these components.









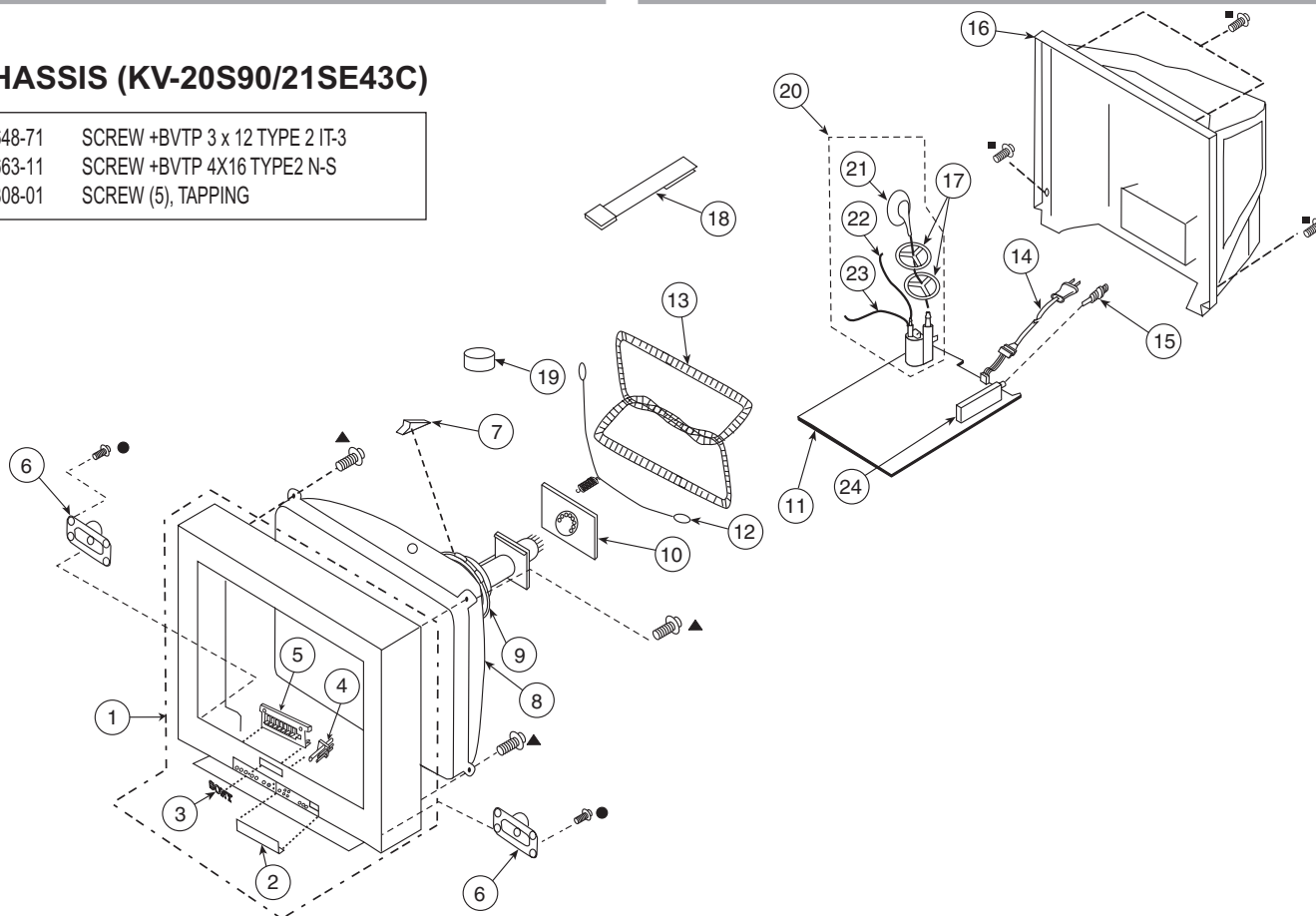



NOTE: The components identified by shading and  mark are critical for safety. Replace only with part number specified.

NOTE: Les composants identifiés par un trame et une marque  sont critiques pour la sécurité. Ne les remplacer que par une pièce portant le numéro spécifié.

6-1. CHASSIS (KV-20S90/21SE43C)

- 7-685-648-71 SCREW +BVTP 3 x 12 TYPE 2 IT-3
- 7-685-663-11 SCREW +BVTP 4X16 TYPE2 N-S
- ▲ 4-365-808-01 SCREW (5), TAPPING



REF. NO.	PART NO.	DESCRIPTION	[Assembly Includes]	REF. NO.	PART NO.	DESCRIPTION	[Assembly Includes]	
1	X-4038-954-1	BEZNET ASSY (KV-21SE43C ONLY)	[2-5]	*	12	4-375-394-01	SPRING, TENSION	
1	X-4038-691-1	BEZNET ASSY (KV-20S90 ONLY)	[2-5]	* 	13	1-416-571-11	COIL, DEMAGNETIC (KV-21SE43C ONLY)	
2	4-062-604-01	DOOR (KV-20S90 ONLY)		* 	13	1-416-572-21	COIL, DEMAGNETIC (KV-20S90 ONLY)	
2	4-062-604-21	DOOR (KV-21SE43C ONLY)			14	1-790-001-21	CORD, AC POWER (WITH CONNECTOR) (KV-20S90 ONLY)	
3	4-046-161-01	EMBLEM (NO.8), SONY			14	1-769-796-71	CORD, POWER (WITH CONNECTOR) (KV-21SE43C ONLY)	
4	4-062-607-01	GUIDE, LED		15	1-766-374-11	PLUG, F-PIN		
5	4-062-603-31	BUTTON, MULTI (KV-21SE43C ONLY)		16	4-081-410-01	COVER, REAR		
5	4-062-603-21	BUTTON, MULTI (KV-20S90 ONLY)		17	3-704-372-71	HOLDER, HV CABLE		
6	1-505-930-11	SPEAKER (9X5CM) (KV-21SE43C ONLY)		18	4-083-415-01	PIECE A(75), CONV. CORRECT		
6	1-505-831-11	SPEAKER (9X5CM) (KV-20S90 ONLY)		19	1-452-032-00	MAGNET, DISC		
7	4-053-005-01	SPACER, DY			20	1-453-283-21	FBT ASSY NX-1744/X4E4	[21-23]
	8	8-738-843-05	CRT 21NXT (FOR SOUTH) (KV-21SE43C ONLY)		21	1-251-643-41	HV CAP ASSY	
	8	8-738-842-05	CRT 21NXT (KV-20S90 ONLY)		22	1-900-800-65	FOCUS LEAD	
	9	8-451-440-21	DY Y21NXA-X		23	1-900-803-22	G2 LEAD	
*	10	A-1331-917-A	C MOUNTED PC BOARD		24	8-598-542-20	TUNER FSS BTF-WA412	
*	11	A-1299-480-A	A COMPLETE PC BOARD (KV-21SE43C ONLY)					
*	11	A-1299-466-A	A COMPLETE PC BOARD (KV-20S90 ONLY)					

The high-voltage leads associated with the FBT on this board are not included and must be ordered separately (See 21-23).

NOTE: The components identified by shading and \triangle mark are critical for safety. Replace only with part number specified.

NOTE: Les composants identifiés par un trame et une marque \triangle sont critiques pour la sécurité. Ne les remplacer que par une pièce portant le numéro spécifique.



REF. NO.	PART NO.	DESCRIPTION	VALUES			REF. NO.	PART NO.	DESCRIPTION	VALUES		
C305	1-164-004-11	CERAMIC CHIP	0.1 μ F	10%	25V	\triangle C602	1-119-907-51	CERAMIC	4700pF	20%	250V
C306	1-164-004-11	CERAMIC CHIP	0.1 μ F	10%	25V	\triangle C603	1-119-907-51	CERAMIC	4700pF	20%	250V
C308	1-126-964-11	ELECT	10 μ F	20%	50V	\triangle C604	1-119-913-51	CERAMIC	2200pF	20%	250V
C309	1-163-021-91	CERAMIC CHIP	0.01 μ F	10%	50V			(KV-21SE43C ONLY)			
C310	1-126-960-11	ELECT	1 μ F	20%	50V	\triangle C604	1-119-907-51	CERAMIC	4700pF	20%	250V
C311	1-163-021-91	CERAMIC CHIP	0.01 μ F	10%	50V			(KV-20S90 ONLY)			
C312	1-126-942-61	ELECT	1000 μ F	20%	25V	\triangle C605	1-119-913-51	CERAMIC	2200pF	20%	250V
C313	1-163-021-91	CERAMIC CHIP	0.01 μ F	10%	50V	\triangle C605	1-119-907-51	CERAMIC	4700pF	20%	250V
C314	1-163-009-11	CERAMIC CHIP	0.001 μ F	10%	50V			(KV-20S90 ONLY)			
C316	1-163-021-91	CERAMIC CHIP	0.01 μ F	10%	50V	C611	1-117-214-11	CERAMIC	0.001 μ F	10%	2KV
C317	1-163-021-91	CERAMIC CHIP	0.01 μ F	10%	50V	C613	1-128-714-11	ELECT	330 μ F	20%	400V
C318	1-163-021-91	CERAMIC CHIP	0.01 μ F	10%	50V			(KV-21SE43C ONLY)			
C319	1-126-963-11	ELECT	4.7 μ F	20%	50V	C613	1-117-893-11	ELECT	470 μ F	20%	250V
C320	1-126-959-11	ELECT	0.47 μ F	20%	50V			(KV-20S90 ONLY)			
C321	1-163-133-00	CERAMIC CHIP	470pF	5%	50V	C614	1-130-471-00	MYLAR	0.001 μ F	5%	50V
C330	1-163-007-11	CERAMIC CHIP	680pF	10%	50V	C616	1-130-202-00	FILM	0.022 μ F	10%	400V
C373	1-163-038-11	CERAMIC CHIP	0.1 μ F		25V			(KV-21SE43C ONLY)			
C374	1-126-935-11	ELECT	470 μ F	20%	16V	C617	1-107-824-11	CERAMIC	220pF	5%	1KV
C375	1-163-038-11	CERAMIC CHIP	0.1 μ F		25V			(KV-21SE43C ONLY)			
C376	1-104-664-11	ELECT	47 μ F	20%	25V	\triangle C618	1-125-893-11	FILM	680pF	3%	1.5KV
C390	1-130-495-00	MYLAR	0.1 μ F	5%	50V	C620	1-102-114-00	CERAMIC	470pF	10%	50V
C418	1-126-964-11	ELECT	10 μ F	20%	50V						
C502	1-106-371-00	MYLAR	0.015 μ F	20%	200V	C621	1-136-356-11	MYLAR	470pF	5%	50V
C504	1-102-228-00	CERAMIC	470pF	10%	500V	C622	1-136-479-11	FILM	0.001 μ F	5%	50V
\triangle C505	1-117-626-11	FILM	2000pF	3%	1.2KV	C623	1-136-153-00	FILM	0.01 μ F	5%	50V
\triangle C507	1-117-633-11	FILM	3900pF	3%	1.2KV	C626	1-126-959-11	ELECT	0.47 μ F	20%	50V
\triangle C508	1-106-371-00	MYLAR	0.015 μ F	20%	200V	C628	1-104-665-11	ELECT	100 μ F	20%	25V
\triangle C509	1-162-115-00	CERAMIC	330pF	10%	2KV						
\triangle C511	1-117-665-11	FILM	0.33 μ F	5%	250V	C629	1-104-665-11	ELECT	100 μ F	20%	25V
C531	1-106-387-00	MYLAR	0.068 μ F	10%	200V	C630	1-163-021-91	CERAMIC CHIP	0.01 μ F	10%	50V
C541	1-126-969-11	ELECT	220 μ F	20%	50V	C631	1-126-768-11	ELECT	2200 μ F	20%	16V
C542	1-126-967-11	ELECT	47 μ F	20%	50V	C632	1-126-942-61	ELECT	1000 μ F	20%	25V
C543	1-136-169-00	FILM	0.22 μ F	5%	50V	C633	1-126-967-11	ELECT	47 μ F	20%	50V
C552	1-102-244-00	CERAMIC	220pF	10%	500V						
C553	1-107-652-11	ELECT	10 μ F	20%	250V	C634	1-131-867-51	ELECT	100 μ F		160V
C556	1-164-161-11	CERAMIC CHIP	0.0022 μ F	10%	50V	C638	1-136-311-11	MYLAR	0.47 μ F	20%	125V
C561	1-102-244-00	CERAMIC	220pF	10%	500V			(KV-20S90 ONLY)			
C562	1-126-941-11	ELECT	470 μ F	20%	25V	C641	1-102-002-00	CERAMIC	680pF	10%	500V
C563	1-137-417-11	MYLAR	0.0047 μ F	10%	200V	C643	1-113-924-11	CERAMIC	0.0047 μ F	20%	250V
C564	1-126-941-11	ELECT	470 μ F	20%	25V	C644	1-113-924-11	CERAMIC	0.0047 μ F	20%	250V
\triangle C571	1-126-965-11	ELECT	22 μ F	20%	50V						
C573	1-126-963-11	ELECT	4.7 μ F	20%	50V	C645	1-137-605-11	MYLAR	0.01 μ F	10%	250V
C574	1-107-635-11	ELECT	4.7 μ F	20%	160V	C646	1-107-679-91	ELECT	10 μ F	20%	450V
\triangle C575	1-163-021-91	CERAMIC CHIP	0.01 μ F	10%	50V	C647	1-130-467-00	MYLAR	470pF	5%	50V
C576	1-123-024-21	ELECT	33 μ F		160V	C648	1-162-318-11	CERAMIC	0.001 μ F	10%	500V
\triangle C577	1-126-959-11	ELECT	0.47 μ F	20%	50V	C650	1-130-471-00	MYLAR	0.001 μ F	5%	50V
\triangle C591	1-137-150-11	MYLAR	0.01 μ F	10%	100V						
\triangle C601	1-136-311-11	MYLAR	0.47 μ F	20%	300V	C651	1-126-382-11	ELECT	100 μ F	20%	16V
						C653	1-104-664-11	ELECT	47 μ F	20%	25V
						C654	1-126-970-11	ELECT	330 μ F	20%	50V
						C656	1-126-965-11	ELECT	22 μ F	20%	50V
						C657	1-102-002-00	CERAMIC	680pF	10%	500V
						C690	1-126-959-11	ELECT	0.47 μ F	20%	50V
						C691	1-126-941-11	ELECT	470 μ F	20%	25V

NOTE: The components identified by shading and \triangle mark are critical for safety. Replace only with part number specified.

NOTE: Les composants identifiés par un trame et une marque \triangle sont critiques pour la sécurité. Ne les remplacer que par une pièce portant le numéro spécifique.



REF. NO.	PART NO.	DESCRIPTION	VALUES	REF. NO.	PART NO.	DESCRIPTION	VALUES
C692	1-104-664-11	ELECT	47 μ F 20% 25V	D609	8-719-311-31	DIODE RU-1P (KV-21SE43C ONLY)	
C693	1-137-194-81	FILM	0.47 μ F 5% 50V	D611	8-719-110-17	DIODE MTZJ-T-77-10B	
CONNECTOR				D613	8-719-046-74	DIODE 10ELS2N-TA1B2	
*	CN203	1-560-124-00	PLUG,CONNECTOR (2.5MM) 4P	D614	8-719-046-74	DIODE 10ELS2N-TA1B2	
*	CN301	1-564-508-11	PLUG,CONNECTOR 5P	D615	8-719-210-21	DIODE 11EQS04-NTA1B	
	CN401	1-564-505-11	PLUG,CONNECTOR 2P	\triangle D616	8-719-510-73	DIODE S3L20 μ F4	
	CN402	1-564-505-11	PLUG,CONNECTOR 2P	D617	8-719-027-43	DIODE S2L20 μ F	
*	CN501	1-580-798-11	CONNECTOR PIN (DY) 6P	D631	8-719-911-55	DIODE ERC04-06S	
				D632	8-719-911-55	DIODE ERC04-06S	
*	CN502	1-564-509-11	PLUG,CONNECTOR 6P	D633	8-719-081-70	DIODE BA159DGPPKG3	
	CN601	1-580-843-11	PIN,CONNECTOR (POWER)	D634	8-719-991-33	DIODE 1SS133T-77	
*	CN602	1-508-786-00	PIN,CONNECTOR (5MM PITCH) 2P	D635	8-719-991-33	DIODE 1SS133T-77	
DIODE				D636	8-719-046-74	DIODE 10ELS2N-TA1B2	
D001	8-719-921-44	DIODE MTZJ-T-77-5.1C		D637	8-719-109-93	DIODE MTZJ-T-77-6.2C	
D002	1-810-039-21	LED UNIT		D638	8-719-510-48	DIODE D1N20R-TA	
D003	8-719-991-33	DIODE 1SS133T-77		D650	8-719-109-89	DIODE MTZJ-T-77-5.6C	
D004	8-719-991-33	DIODE 1SS133T-77		D653	8-719-312-10	DIODE RU4AM-T3	
D038	8-719-109-89	DIODE MTZJ-T-77-5.6C		D670	8-719-991-33	DIODE 1SS133T-77	
D201	8-719-110-17	DIODE MTZJ-T-77-10B		FUSE			
D202	8-719-110-17	DIODE MTZJ-T-77-10B		\triangle F601	1-532-506-51	FUSE 6.3A/250V (KV-21SE43C ONLY)	
D203	8-719-110-17	DIODE MTZJ-T-77-10B		\triangle F601	1-533-795-11	LINK, FUSE (KV-20S90 ONLY)	
D204	8-719-110-17	DIODE MTZJ-T-77-10B		FERRITE BEAD			
D205	8-719-982-22	DIODE MTZJ-T-77-30D		FB501	1-410-396-41	FERRITE	0.45 μ H
D208	8-719-110-17	DIODE MTZJ-T-77-10B		FB600	1-410-397-21	FERRITE	1.1 μ H
D209	8-719-110-17	DIODE MTZJ-T-77-10B		FB601	1-410-397-21	FERRITE	1.1 μ H
D210	8-719-110-17	DIODE MTZJ-T-77-10B		FB602	1-410-397-21	FERRITE	1.1 μ H
D301	8-719-110-08	DIODE MTZJ-T-77-8.2B		FB604	1-410-397-21	FERRITE	1.1 μ H
D302	8-719-921-44	DIODE MTZJ-T-77-5.1C		FB605	1-410-397-21	FERRITE	1.1 μ H
D310	8-719-073-01	DIODE MA111-TX		FB606	1-410-397-21	FERRITE	1.1 μ H
D311	8-719-073-01	DIODE MA111-TX		FB609	1-412-911-11	FERRITE	0 μ H
D320	8-719-976-99	DIODE UDZ-TE-17-5.1B		FB611	1-410-397-21	FERRITE	1.1 μ H
D403	8-719-991-33	DIODE 1SS133T-77		IC			
D434	8-719-991-33	DIODE 1SS133T-77		IC001	8-759-639-83	IC M37273MF-255SP	
D501	8-719-945-80	DIODE ERC06-15S		\triangle IC002	8-759-575-47	IC NJM78LR05BM-TE2	
D502	8-719-302-43	DIODE RGP10GPKG23		IC003	8-759-675-64	IC M24C08-MN6T (A)	
D541	8-719-908-03	DIODE GP08DPKG23		IC004	8-742-212-20	HYB IC SBX3081-71	
D552	8-719-302-43	DIODE RGP10GPKG23		IC200	8-759-450-93	IC NJM2521M-TE1	
D561	8-719-979-85	DIODE RGP15GPKG23		IC201	8-759-450-93	IC NJM2521M-TE1	
D562	8-719-979-85	DIODE RGP15GPKG23		IC301	8-752-098-78	IC CXA2133BS	
\triangle D571	8-719-991-33	DIODE 1SS133T-77		IC401	8-759-490-17	IC TDA7057AQ/N2	
D572	8-719-991-33	DIODE 1SS133T-77		\triangle IC521	8-759-100-96	IC NJM4558M-TE2	
D573	8-719-110-08	DIODE MTZJ-T-77-8.2B		IC541	8-759-835-98	IC AN5522	
\triangle D574	8-719-979-84	DIODE EGP20DPKG23		\triangle IC601	8-749-018-39	IC STR-F6454 (KV-21SE43C ONLY)	
\triangle D581	8-719-991-33	DIODE 1SS133T-77					
\triangle D601	8-719-510-51	DIODE D3SB60F					
D602	8-719-991-33	DIODE 1SS133T-77					
D603	8-719-046-74	DIODE 10ELS2N-TA1B2					

NOTE: The components identified by shading and \triangle mark are critical for safety. Replace only with part number specified.

NOTE: Les composants identifiés par un trame et une marque \triangle sont critiques pour la sécurité. Ne les remplacer que par une pièce portant le numéro spécifique.



REF. NO.	PART NO.	DESCRIPTION	VALUES	REF. NO.	PART NO.	DESCRIPTION	VALUES
\triangle IC601	8-749-018-45	IC STR-F6424 (KV-20S90 ONLY)		\triangle Q571	8-729-200-17	TRANSISTOR 2SA10910-TPE2	
\triangle IC602	8-759-198-31	IC UPC1093J-1-T		Q601	8-729-423-33	TRANSISTOR 2SC3311A-QRSTA	
JACK				Q602	8-729-422-27	TRANSISTOR 2SD601A-QRS-TX	
J201	1-580-443-11	JACK, PIN 3P		Q605	8-729-423-99	TRANSISTOR 2SD2137-OP-TA	
J202	1-691-110-11	JACK, PIN 3P		Q606	8-729-111-55	TRANSISTOR 2SD1292-T103	
J400	1-568-267-21	JACK		\triangle Q607	8-729-044-30	TRANSISTOR 2SK2845-LB102	
CHIP CONDUCTOR				Q608	8-729-423-33	TRANSISTOR 2SC3311A-QRSTA	
JR003	1-216-295-11	SHORT		Q650	8-729-111-55	TRANSISTOR 2SD1292-T103	
COIL				Q670	8-729-140-96	TRANSISTOR 2SD774-T-34	
L001	1-412-029-11	INDUCTOR	10 μ H	RESISTOR			
L002	1-412-032-11	INDUCTOR	100 μ H	R001	1-216-073-00	RES-CHIP	10K 5% 1/10W
L003	1-412-032-11	INDUCTOR	100 μ H	R002	1-249-429-11	CARBON	10K 5% 1/4W
L150	1-412-032-11	INDUCTOR	100 μ H	R003	1-216-033-00	RES-CHIP	220 5% 1/10W
L151	1-412-029-11	INDUCTOR	10 μ H	R004	1-216-073-00	RES-CHIP	10K 5% 1/10W
L160	1-412-029-11	INDUCTOR	10 μ H	R005	1-216-033-00	RES-CHIP	220 5% 1/10W
L301	1-412-031-11	INDUCTOR	47 μ H	R007	1-216-025-11	RES-CHIP	100 5% 1/10W
L302	1-412-029-11	INDUCTOR	10 μ H	R008	1-216-033-00	RES-CHIP	220 5% 1/10W
L503	1-412-553-11	INDUCTOR	3.3mH	R009	1-249-409-11	CARBON	220 5% 1/4W
L504	1-412-533-21	INDUCTOR	47 μ H	R010	1-216-033-00	RES-CHIP	220 5% 1/10W
\triangle L591	1-412-531-31	INDUCTOR	33 μ H	R011	1-249-409-11	CARBON	220 5% 1/4W
PHOTO COUPLER				R013	1-249-433-11	CARBON	22K 5% 1/4W
\triangle PH600	8-749-010-64	PHOTO COUPLER PC123FY2		R016	1-249-413-11	CARBON	470 5% 1/4W
IC LINK				R017	1-216-113-00	RES-CHIP	470K 5% 1/10W
\triangle PS201	1-532-984-11	LINK, IC 2A/90V		R018	1-249-417-11	CARBON	1K 5% 1/4W
TRANSISTOR				R019	1-249-425-11	CARBON	4.7K 5% 1/4W
Q001	8-729-216-22	TRANSISTOR 2SB709A-QRS-TX		R020	1-249-427-11	CARBON	6.8K 5% 1/4W
Q002	8-729-422-27	TRANSISTOR 2SD601A-QRS-TX		R021	1-249-415-11	CARBON	680 5% 1/4W
Q003	8-729-422-27	TRANSISTOR 2SD601A-QRS-TX		R022	1-249-416-11	CARBON	820 5% 1/4W
Q203	8-729-216-22	TRANSISTOR 2SB709A-QRS-TX		R023	1-249-421-11	CARBON	2.2K 5% 1/4W
Q205	8-729-216-22	TRANSISTOR 2SB709A-QRS-TX		R025	1-249-426-11	CARBON	5.6K 5% 1/4W
Q252	8-729-422-27	TRANSISTOR 2SD601A-QRS-TX		R026	1-249-426-11	CARBON	5.6K 5% 1/4W
\triangle Q300	8-729-422-27	TRANSISTOR 2SD601A-QRS-TX		R027	1-249-426-11	CARBON	5.6K 5% 1/4W
Q301	8-729-216-22	TRANSISTOR 2SB709A-QRS-TX		R028	1-216-049-11	RES-CHIP	1K 5% 1/10W
Q302	8-729-216-22	TRANSISTOR 2SB709A-QRS-TX		R030	1-249-429-11	CARBON	10K 5% 1/4W
Q303	8-729-423-33	TRANSISTOR 2SC3311A-QRSTA		R031	1-216-045-00	RES-CHIP	680 5% 1/10W
Q305	8-729-216-22	TRANSISTOR 2SB709A-QRS-TX		R032	1-216-033-00	RES-CHIP	220 5% 1/10W
Q390	8-729-422-27	TRANSISTOR 2SD601A-QRS-TX		R033	1-249-409-11	CARBON	220 5% 1/4W
Q391	8-729-422-27	TRANSISTOR 2SD601A-QRS-TX		R038	1-216-049-11	RES-CHIP	1K 5% 1/10W
Q392	8-729-216-22	TRANSISTOR 2SB709A-QRS-TX		R040	1-249-413-11	CARBON	470 5% 1/4W
Q393	8-729-216-22	TRANSISTOR 2SB709A-QRS-TX		R043	1-249-417-11	CARBON	1K 5% 1/4W
Q394	8-729-216-22	TRANSISTOR 2SB709A-QRS-TX		R044	1-216-033-00	RES-CHIP	220 5% 1/10W
Q501	8-729-140-50	TRANSISTOR 2SC3209LK-TP		R045	1-216-065-91	RES-CHIP	4.7K 5% 1/10W
Q502	8-729-051-69	TRANSISTOR 2SD2624		R046	1-216-033-00	RES-CHIP	220 5% 1/10W
Q556	8-729-422-27	TRANSISTOR 2SD601A-QRS-TX		R047	1-216-065-91	RES-CHIP	4.7K 5% 1/10W
				R048	1-216-025-11	RES-CHIP	100 5% 1/10W
				R049	1-216-089-11	RES-CHIP	47K 5% 1/10W
				R050	1-249-429-11	CARBON	10K 5% 1/4W
				R051	1-216-033-00	RES-CHIP	220 5% 1/10W



REF. NO.	PART NO.	DESCRIPTION	VALUES			REF. NO.	PART NO.	DESCRIPTION	VALUES		
R054	1-216-073-00	RES-CHIP	10K	5%	1/10W	R252	1-216-041-00	RES-CHIP	470	5%	1/10W
R055	1-216-033-00	RES-CHIP	220	5%	1/10W	R253	1-215-899-11	METAL OXIDE	15K	5%	2W
R056	1-249-425-11	CARBON	4.7K	5%	1/4W	R254	1-216-025-11	RES-CHIP	100	5%	1/10W
R057	1-216-065-91	RES-CHIP	4.7K	5%	1/10W	R255	1-216-025-11	RES-CHIP	100	5%	1/10W
R058	1-216-065-91	RES-CHIP	4.7K	5%	1/10W	R256	1-249-425-11	CARBON	4.7K	5%	1/4W
R065	1-216-033-00	RES-CHIP	220	5%	1/10W	R257	1-216-073-00	RES-CHIP	10K	5%	1/10W
R066	1-216-033-00	RES-CHIP	220	5%	1/10W	R268	1-216-065-91	RES-CHIP	4.7K	5%	1/10W
R070	1-249-425-11	CARBON	4.7K	5%	1/4W			(KV-21SE43C ONLY)			
R071	1-249-425-11	CARBON	4.7K	5%	1/4W	R268	1-208-794-11	METAL CHIP	3.3K	0.50%	1/10W
R072	1-249-409-11	CARBON	220	5%	1/4W			(KV-20S90 ONLY)			
R073	1-216-304-11	RES-CHIP	3.3	5%	1/10W	R269	1-216-065-91	RES-CHIP	4.7K	5%	1/10W
R074	1-216-073-00	RES-CHIP	10K	5%	1/10W			(KV-21SE43C ONLY)			
R075	1-216-073-00	RES-CHIP	10K	5%	1/10W	R269	1-208-794-11	METAL CHIP	3.3K	0.50%	1/10W
R076	1-216-121-11	RES-CHIP	1M	5%	1/10W			(KV-20S90 ONLY)			
R077	1-216-097-11	RES-CHIP	100K	5%	1/10W	R280	1-216-022-00	RES-CHIP	75	5%	1/10W
R078	1-216-049-11	RES-CHIP	1K	5%	1/10W	R284	1-216-295-11	SHORT			
R085	1-216-073-00	RES-CHIP	10K	5%	1/10W	R288	1-216-295-11	SHORT			
R086	1-216-073-00	RES-CHIP	10K	5%	1/10W	R289	1-216-295-11	SHORT			
R087	1-216-045-00	RES-CHIP	680	5%	1/10W	R290	1-216-025-11	RES-CHIP	100	5%	1/10W
R088	1-216-045-00	RES-CHIP	680	5%	1/10W	R291	1-216-065-91	RES-CHIP	4.7K	5%	1/10W
R089	1-216-045-00	RES-CHIP	680	5%	1/10W	R293	1-249-429-11	CARBON	10K	5%	1/4W
R090	1-249-429-11	CARBON	10K	5%	1/4W	R294	1-216-295-11	SHORT			
R091	1-249-429-11	CARBON	10K	5%	1/4W	R295	1-216-295-11	SHORT			
R092	1-216-049-11	RES-CHIP	1K	5%	1/10W	R297	1-247-807-31	CARBON	100	5%	1/4W
R093	1-249-425-11	CARBON	4.7K	5%	1/4W	R298	1-216-025-11	RES-CHIP	100	5%	1/10W
R096	1-216-057-00	RES-CHIP	2.2K	5%	1/10W	R301	1-216-295-11	SHORT			
R097	1-216-073-00	RES-CHIP	10K	5%	1/10W	R304	1-216-073-00	RES-CHIP	10K	5%	1/10W
R099	1-249-425-11	CARBON	4.7K	5%	1/4W	R306	1-216-675-91	METAL CHIP	10K	0.50%	1/10W
R101	1-216-073-00	RES-CHIP	10K	5%	1/10W	R307	1-216-065-91	RES-CHIP	4.7K	5%	1/10W
R150	1-216-025-11	RES-CHIP	100	5%	1/10W	R308	1-247-887-00	CARBON	220K	5%	1/4W
R151	1-216-025-11	RES-CHIP	100	5%	1/10W	R309	1-249-433-11	CARBON	22K	5%	1/4W
R201	1-216-113-00	RES-CHIP	470K	5%	1/10W	R310	1-216-049-11	RES-CHIP	1K	5%	1/10W
R202	1-216-113-00	RES-CHIP	470K	5%	1/10W	R312	1-216-033-00	RES-CHIP	220	5%	1/10W
R204	1-216-022-00	RES-CHIP	75	5%	1/10W	R313	1-249-409-11	CARBON	220	5%	1/4W
R205	1-247-895-91	CARBON	470K	5%	1/4W	R314	1-249-409-11	CARBON	220	5%	1/4W
R206	1-247-895-91	CARBON	470K	5%	1/4W	R315	1-249-409-11	CARBON	220	5%	1/4W
R230	1-216-073-00	RES-CHIP	10K	5%	1/10W	R316	1-216-025-11	RES-CHIP	100	5%	1/10W
R231	1-216-073-00	RES-CHIP	10K	5%	1/10W	R317	1-249-421-11	CARBON	2.2K	5%	1/4W
R234	1-208-794-11	METAL CHIP	3.3K	0.50%	1/10W	R318	1-216-073-00	RES-CHIP	10K	5%	1/10W
R235	1-208-794-11	METAL CHIP	3.3K	0.50%	1/10W	R319	1-216-073-00	RES-CHIP	10K	5%	1/10W
R237	1-249-409-11	CARBON	220	5%	1/4W	R321	1-216-069-00	RES-CHIP	6.8K	5%	1/10W
R238	1-249-417-11	CARBON	1K	5%	1/4W	R322	1-216-073-00	RES-CHIP	10K	5%	1/10W
R239	1-249-409-11	CARBON	220	5%	1/4W	R323	1-249-415-11	CARBON	680	5%	1/4W
R240	1-249-417-11	CARBON	1K	5%	1/4W	R324	1-249-425-11	CARBON	4.7K	5%	1/4W
R241	1-216-065-91	RES-CHIP	4.7K	5%	1/10W	R325	1-216-097-11	RES-CHIP	100K	5%	1/10W
R242	1-249-433-11	CARBON	22K	5%	1/4W	R329	1-216-025-11	RES-CHIP	100	5%	1/10W
R243	1-216-085-00	RES-CHIP	33K	5%	1/10W	R330	1-216-025-11	RES-CHIP	100	5%	1/10W
R251	1-216-041-00	RES-CHIP	470	5%	1/10W	R331	1-216-025-11	RES-CHIP	100	5%	1/10W
						R347	1-216-045-00	RES-CHIP	680	5%	1/10W

NOTE: The components identified by shading and \triangle mark are critical for safety. Replace only with part number specified.

A component identified by this \boxtimes symbol indicates that it has been carefully factory-selected to satisfy regulations regarding X-ray radiation. Should replacement be required, replace only with the value originally used.



REF. NO.	PART NO.	DESCRIPTION	VALUES			REF. NO.	PART NO.	DESCRIPTION	VALUES		
R353	1-216-295-11	SHORT				R583	1-208-830-11	METAL CHIP	100K	0.50%	1/10W
R356	1-216-057-00	RES-CHIP	2.2K	5%	1/10W	R584	1-208-806-11	METAL CHIP	10K	0.50%	1/10W
R383	1-216-057-00	RES-CHIP	2.2K	5%	1/10W	R585	1-216-085-00	RES-CHIP	33K	5%	1/10W
R384	1-216-057-00	RES-CHIP	2.2K	5%	1/10W	\triangle R586	1-216-069-00	RES-CHIP	6.8K	5%	1/10W
R385	1-216-057-00	RES-CHIP	2.2K	5%	1/10W						
R390	1-216-025-11	RES-CHIP	100	5%	1/10W	R591	1-215-880-00	METAL OXIDE	10	5%	2W
R391	1-216-049-11	RES-CHIP	1K	5%	1/10W	\triangle R602	1-249-389-11	CARBON	4.7	5%	1/4W
R392	1-216-025-11	RES-CHIP	100	5%	1/10W	R603	1-247-895-91	CARBON	470K	5%	1/4W
R393	1-216-049-11	RES-CHIP	1K	5%	1/10W	R608	1-240-205-91	CARBON	22M	5%	1/2W
R394	1-247-807-31	CARBON	100	5%	1/4W	R609	1-249-421-11	CARBON	2.2K	5%	1/4W
R400	1-249-433-11	CARBON	22K	5%	1/4W	R610	1-249-417-11	CARBON	1K	5%	1/4W
R432	1-249-430-11	CARBON	12K	5%	1/4W	R611	1-249-437-11	CARBON	47K	5%	1/4W
R433	1-216-075-00	RES-CHIP	12K	5%	1/10W	R612	1-249-415-11	CARBON	680	5%	1/4W
R501	1-249-421-11	CARBON	2.2K	5%	1/4W	R614	1-249-429-11	CARBON	10K	5%	1/4W
\triangle R502	1-215-921-11	METAL OXIDE	4.7K	5%	3W	R616	1-260-302-51	CARBON	6.8	5%	1/2W
\triangle R508	1-215-864-00	METAL OXIDE	150	5%	1W						
R532	1-215-437-00	METAL	4.7K	1%	1/4W	R617	1-249-415-11	CARBON	680	5%	1/4W
R533	1-215-461-00	METAL	47K	1%	1/4W	R620	1-219-512-11	CARBON	2.2M	5%	1/2W
R534	1-215-453-00	METAL	22K	1%	1/4W	R623	1-249-429-11	CARBON	10K	5%	1/4W
R535	1-249-441-11	CARBON	100K	5%	1/4W	\triangle R625	1-215-429-00	METAL	2.2K	1%	1/4W
R541	1-216-065-91	RES-CHIP	4.7K	5%	1/10W	\triangle R626	1-215-469-00	METAL	100K	1%	1/4W
R542	1-249-429-11	CARBON	10K	5%	1/4W						
R543	1-249-429-11	CARBON	10K	5%	1/4W	R630	1-249-421-11	CARBON	2.2K	5%	1/4W
R544	1-216-377-11	METAL OXIDE	4.7	5%	2W	R631	1-249-429-11	CARBON	10K	5%	1/4W
R546	1-215-890-11	METAL OXIDE	470	5%	2W	R632	1-208-806-11	METAL CHIP	10K	0.50%	1/10W
R547	1-249-385-11	CARBON	2.2	5%	1/4W	R633	1-215-457-00	METAL	33K	1%	1/4W
R548	1-249-425-11	CARBON	4.7K	5%	1/4W	R634	1-249-417-11	CARBON	1K	5%	1/4W
R549	1-216-073-00	RES-CHIP	10K	5%	1/10W	\triangle R635	1-216-073-00	RES-CHIP	10K	5%	1/10W
R552	1-247-887-00	CARBON	220K	5%	1/4W	R636	1-208-798-11	METAL CHIP	4.7K	0.50%	1/10W
R553	1-260-312-11	CARBON	47	5%	1/2W	R637	1-208-806-11	METAL CHIP	10K	0.50%	1/10W
R559	1-216-101-00	RES-CHIP	150K	5%	1/10W	R638	1-208-814-91	METAL CHIP	22K	0.50%	1/10W
R560	1-216-093-91	RES-CHIP	68K	5%	1/10W	R639	1-216-089-11	RES-CHIP	47K	5%	1/10W
R561	1-216-349-00	METAL OXIDE	1	5%	1W	\triangle R640	1-216-089-11	RES-CHIP	47K	5%	1/10W
R562	1-216-349-00	METAL OXIDE	1	5%	1W	R641	1-216-397-11	METAL OXIDE	4.7	5%	3W
R565	1-216-081-00	RES-CHIP	22K	5%	1/10W	R643	1-216-065-91	RES-CHIP	4.7K	5%	1/10W
R566	1-216-077-91	RES-CHIP	15K	5%	1/10W	R644	1-249-418-11	CARBON	1.2K	5%	1/4W
R567	1-216-065-91	RES-CHIP	4.7K	5%	1/10W	R647	1-260-081-11	CARBON	33	5%	1/2W
R568	1-216-121-11	RES-CHIP	1M	5%	1/10W						
\triangle R571	1-216-369-00	METAL OXIDE	1	5%	2W	R648	1-249-421-11	CARBON	2.2K	5%	1/4W
\triangle R572	1-249-421-11	CARBON	2.2K	5%	1/4W	R649	1-249-413-11	CARBON	470	5%	1/4W
\triangle R573	1-247-895-91	CARBON	470K	5%	1/4W	R650	1-249-415-11	CARBON	680	5%	1/4W
\triangle R574	1-249-417-11	CARBON	1K	5%	1/4W	\triangle R651	1-247-289-00	CARBON (KV-21SE43C ONLY)	8.2M	5%	1W
\triangle R575	1-247-891-00	CARBON	330K	5%	1/4W	\triangle R651	1-219-513-11	CARBON (KV-20S90 ONLY)	4.7M	5%	1/2W
\triangle R576	1-249-441-11	CARBON	100K	5%	1/4W						
R577	1-249-432-11	CARBON	18K	5%	1/4W	R652	1-202-961-11	CEMENTED (KV-21SE43C ONLY)	1.8	5%	10W
R578	1-216-467-11	METAL OXIDE	56K	5%	2W	R655	1-216-361-00	METAL OXIDE	0.22	5%	2W
R579	1-216-646-11	METAL CHIP	620	0.50%	1/10W	R656	1-249-419-11	CARBON	1.5K	5%	1/4W
R580	1-216-295-11	SHORT				R657	1-247-843-11	CARBON	3.3K	5%	1/4W
\triangle \boxtimes R582	1-208-826-11	METAL CHIP	68K	0.50%	1/10W	R658	1-215-929-11	METAL OXIDE (KV-21SE43C ONLY)	100K	5%	3W
						\triangle R659	1-202-961-11	CEMENTED	1.8	5%	10W



NOTE: The components identified by shading and \triangle mark are critical for safety. Replace only with part number specified.

NOTE: Les composants identifiés par un trame et une marque \triangle sont critiques pour la sécurité. Ne les remplacer que par une pièce portant le numéro spécifique.

REF. NO.	PART NO.	DESCRIPTION	VALUES			REF. NO.	PART NO.	DESCRIPTION	VALUES		
\triangle R660	1-220-926-11	FUSIBLE	0.47	10%	1/2W	VARISTOR					
R661	1-216-485-11	METAL OXIDE	5.6K	5%	3W	\triangle VDR601	1-803-587-11	VARISTOR ENE471D-14A (KV-21SE43C ONLY)			
\triangle R662	1-249-377-11	CARBON	0.47	5%	1/4W	\triangle VDR601	1-803-585-11	VARISTOR ENE271D-10A (KV-20S90 ONLY)			
R663	1-216-369-00	METAL OXIDE	1	5%	2W	CRYSTAL					
R664	1-215-479-00	METAL (KV-21SE43C ONLY)	270K	1%	1/4W	X001	1-767-487-11	VIBRATOR, CRYSTAL			
R664	1-215-483-00	METAL (KV-20S90 ONLY)	390K	1%	1/4W	X301	1-567-505-11	OSCILLATOR, CRYSTAL			
R670	1-249-421-11	CARBON	2.2K	5%	1/4W	C					
R671	1-249-417-11	CARBON	1K	5%	1/4W	* A-1331-917-A	C MOUNTED PC BOARD				
R672	1-216-485-11	METAL OXIDE	5.6K	5%	3W	4-382-854-11	SCREW (M3X10), P, SW (+)				
\triangle R674	1-249-415-11	CARBON	680	5%	1/4W	CAPACITOR					
R675	1-215-859-00	METAL OXIDE	22	5%	1W	C1751	1-107-652-11	ELECT	10 μ F	20%	250V
R679	1-249-413-11	CARBON	470	5%	1/4W	C1752	1-162-114-00	CERAMIC	0.0047 μ F		2KV
R682	1-216-065-91	RES-CHIP	4.7K	5%	1/10W	C1755	1-107-667-11	ELECT	2.2 μ F	20%	160V
R683	1-249-421-11	CARBON	2.2K	5%	1/4W	CONNECTOR					
R688	1-216-485-11	METAL OXIDE	5.6K	5%	3W	CN1751	1-564-509-11	PLUG,CONNECTOR 6P			
R698	1-215-479-00	METAL (KV-21SE43C ONLY)	270K	1%	1/4W	* CN1752	1-564-508-11	PLUG,CONNECTOR 5P			
RELAY						CN1753	1-785-879-11	CONNECTOR, ONE TOUCH			
\triangle RY601	1-755-198-11	RELAY				CN1754	1-695-915-11	TAB (CONTACT)			
\triangle RY602	1-755-266-11	RELAY, AC POWER				DIODE					
SWITCH						D1754	8-719-901-83	DIODE 1SS83TD			
S001	1-692-431-21	SWITCH TACTILE				D1755	8-719-901-83	DIODE 1SS83TD			
S002	1-692-431-21	SWITCH TACTILE				D1756	8-719-901-83	DIODE 1SS83TD			
S003	1-692-431-21	SWITCH TACTILE				D1758	8-719-302-43	DIODE RGP10GPKG23			
S004	1-692-431-21	SWITCH TACTILE				IC					
S005	1-692-431-21	SWITCH TACTILE				\triangle IC1751	8-759-562-43	IC TDA6108JF/N1B			
S006	1-692-431-21	SWITCH TACTILE				JACK					
S007	1-692-431-21	SWITCH TACTILE				\triangle J1751	1-251-688-11	SOCKET, CRT			
TRANSFORMER						COIL					
\triangle T501	1-437-210-11	TRANSFORMER, HORIZONTAL DRIVE				L1751	1-408-613-31	INDUCTOR	68 μ H		
\triangle T504	1-453-283-21	FBT ASSY NX-1744//X4E4				RESISTOR					
\triangle T601	1-423-895-11	TRANSFORMER, LINE FILTER (LFT)				R1756	1-260-328-11	CARBON	1K	5%	1/2W
\triangle T603	1-433-817-11	TRANSFORMER, REGULATOR (KV-21SE43C ONLY)				R1757	1-260-328-11	CARBON	1K	5%	1/2W
\triangle T603	1-433-816-11	TRANSFORMER, REGULATOR (KV-20S90 ONLY)				R1758	1-260-328-11	CARBON	1K	5%	1/2W
\triangle T604	1-431-852-11	TRANSFORMER, CONVERTER (SRT)				R1759	1-260-087-11	CARBON	100	5%	1/2W
THERMISTOR						R1760	1-260-123-11	CARBON	100K	5%	1/2W
THP601	1-809-827-11	THERMISTOR, POSITIVE (KV-21SE43C ONLY)				R1761	1-216-392-11	METAL OXIDE	1.8	5%	3W
THP601	1-810-597-11	THERMISTOR, POSITIVE (KV-20S90 ONLY)				R1763	1-247-807-31	CARBON	100	5%	1/4W
TUNER						R1764	1-247-807-31	CARBON	100	5%	1/4W
\triangle TU101	8-598-542-20	TUNER, FSS BTF-WA412									



REF. NO.	PART NO.	DESCRIPTION	VALUES			REF. NO.	PART NO.	DESCRIPTION	VALUES
R1765	1-247-807-31	CARBON	100	5%	1/4W				
R1770	1-260-132-11	CARBON	560K	5%	1/2W				

ACCESSORIES AND PACKAGING

	1-501-730-41	ANTENNA, TELESCOPIC (KV-21SE43C ONLY)
	4-041-254-01	BAG, PROTECTION
*	4-081-771-01	CARTON, INDIVIDUAL (KV-21SE43C ONLY)
*	4-081-458-01	CARTON, INDIVIDUAL (KV-20S90 ONLY)
	1-417-182-11	CONVERTER (KV-21SE43C ONLY)
*	4-061-391-01	CUSHION, LOWER ASSY
*	4-061-392-01	CUSHION, UPPER ASSY
	4-081-454-41	MANUAL, INSTRUCTION (KV-21SE43C ONLY)
	4-081-454-21	MANUAL, INSTRUCTION (KV-20S90 ONLY)

REMOTE COMMANDER

	1-475-635-11	REMOTE COMMANDER (RM-Y155)
	9-939-830-01	BATTERY COVER FOR (RM-Y155)

13 | 14 | 15 | 16 | 17 | 18 | 19 | 20 | 21 | 22

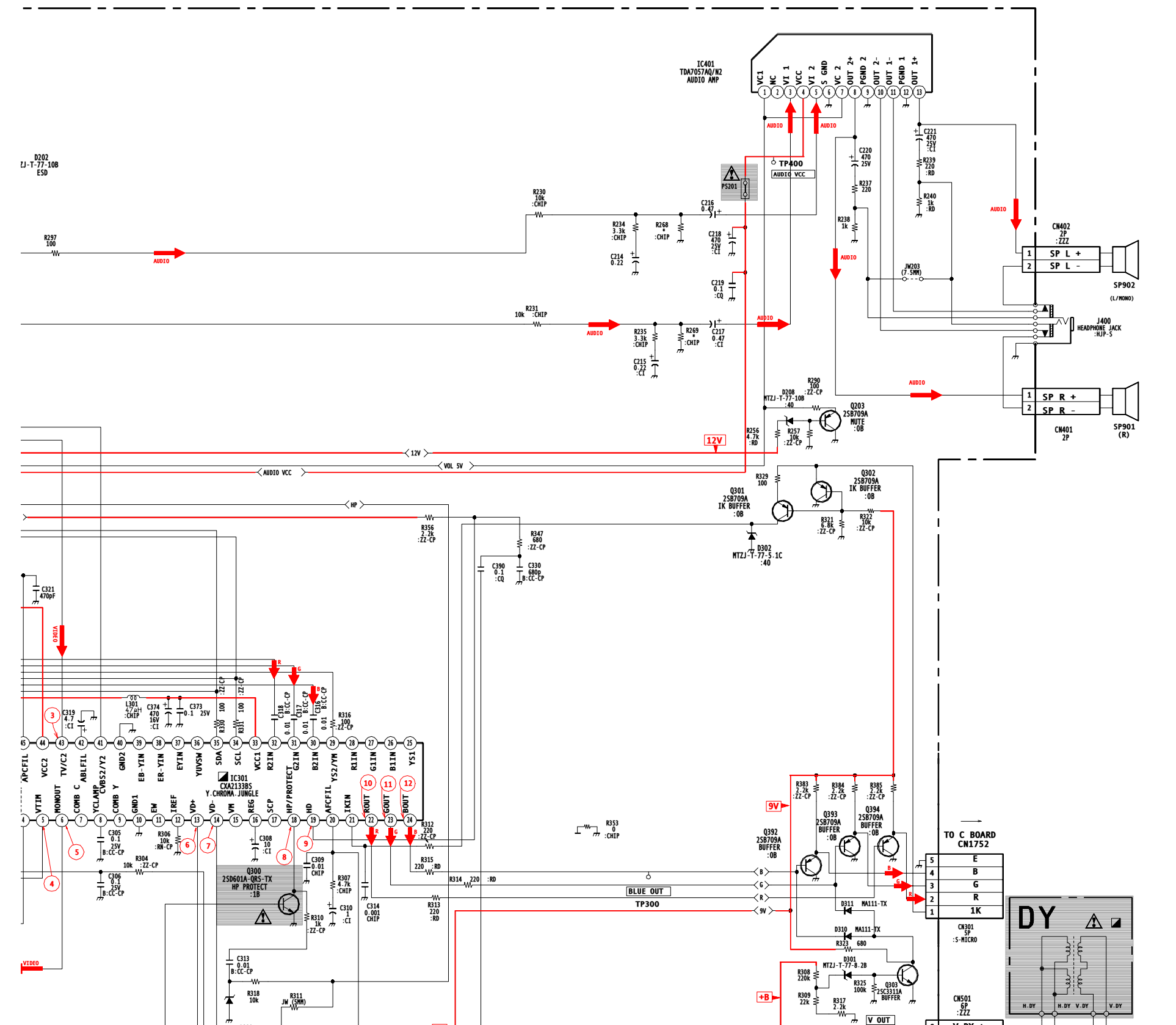

J
K
L
M
N
O
P

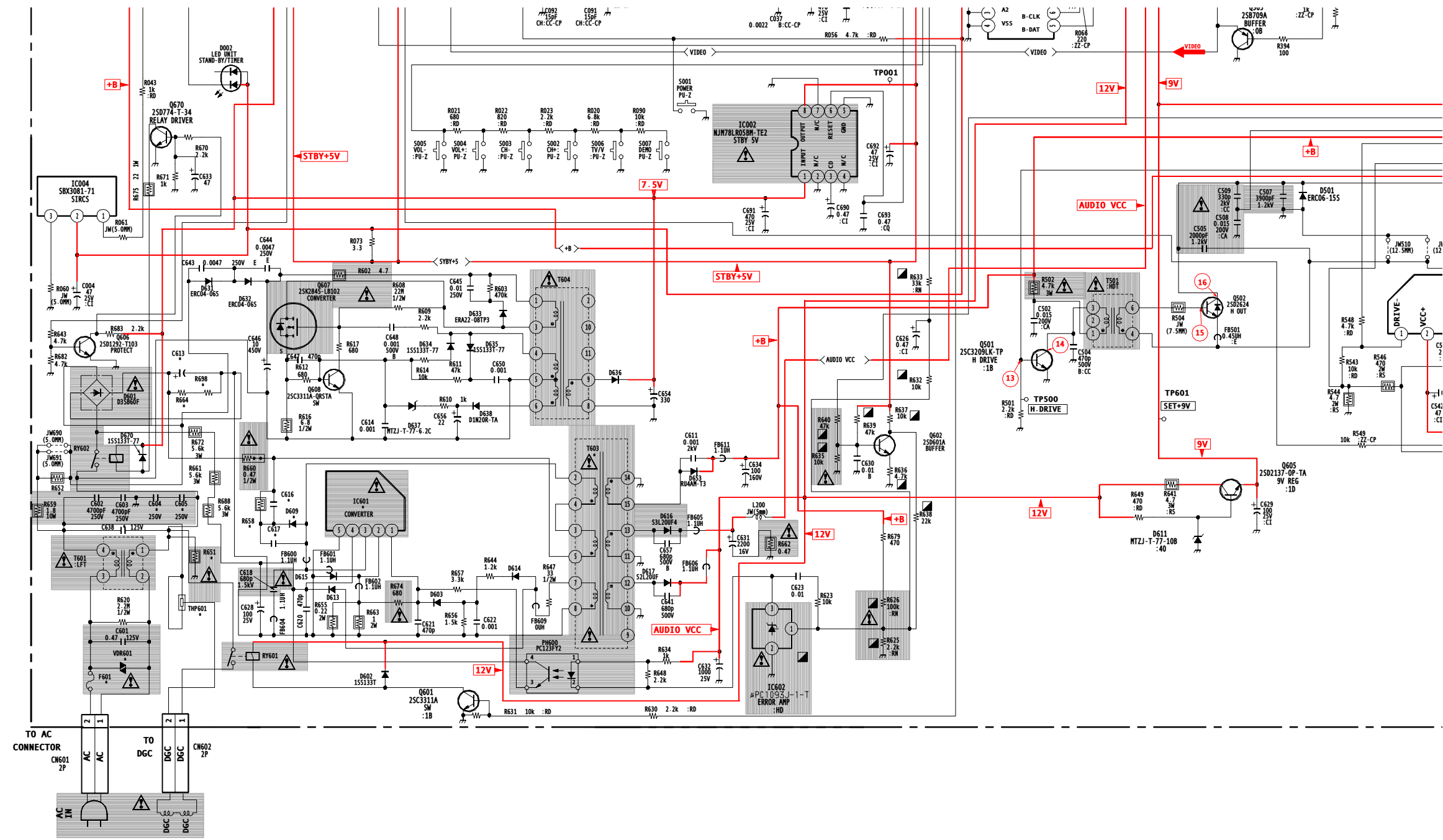

Trinitron[®]
Color TV

Operating Instructions

KV-13M42
KV-20M42
KV-20S90



WARNING

To reduce the risk of fire or electric shock, do not expose the TV to rain or moisture.



This symbol is intended to alert the user to the presence of uninsulated “dangerous voltage” within the product’s enclosure that may be of sufficient magnitude to constitute a risk of electric shock to persons.



This symbol is intended to alert the user to the presence of important operating and maintenance (servicing) instructions in the literature accompanying the appliance.

Note to the CATV Installer

This reminder is provided to call the CATV system installer’s attention to Article 820-40 of the NEC that provides guidelines for proper grounding and, in particular, specifies that the cable ground shall be connected to the grounding system of the building as close to the point of cable entry as practical.

SAFETY PRECAUTIONS

- Operate the TV only on 120 V AC.
- One blade of the power plug is wider than the other for safety purposes and will fit into the power outlet only one way. If you are unable to insert the plug fully into the outlet, contact your dealer.
- If any liquid or solid object falls into the TV, unplug it and have it checked by qualified personnel before operating it further.

CAUTION

When using TV games, computers, and similar products with your TV, keep the brightness and contrast functions at low settings. If a fixed (non-moving) pattern is left on the screen for long periods of time at a high brightness or contrast setting, the image can be permanently imprinted onto the screen. Continuously watching the same channel can cause the imprint of station logos onto the TV screen. These types of imprints are not covered by your warranty because they are the results of misuse.



To reduce the risk of electric shock, do not use this polarized plug with an extension cord, receptacle, or other outlet unless the blades can be fully inserted to prevent blade exposure.

 You are cautioned that any changes or modifications not expressly approved in this manual could void your authority to operate this equipment.

NOTIFICATION

This equipment has been tested and found to comply with the limits for a Class B digital device pursuant to Part 15 of the FCC Rules. These limits are designed to provide reasonable protection against harmful interference in a residential installation. This equipment generates, uses, and can radiate radio frequency energy and, if not installed and used in accordance with the instructions, may cause harmful interference with radio communications. However, there is no guarantee that interference will not occur in a particular installation. If this equipment does cause harmful interference to radio or television reception, which can be determined by turning the equipment off and on, the user is encouraged to try to correct the interference by one or more of the following measures:

- Reorient or relocate the receiving antennas.
- Increase the separation between the equipment and receiver.
- Connect the equipment into an outlet on a circuit different from that to which the receiver is connected.
- Consult the dealer or an experienced radio/TV technician for help.

Protecting the TV

- To prevent internal heat build-up, do not block the ventilation openings.
- Do not install the TV in a hot or humid place, or in a place subject to excessive dust or mechanical vibration.

Note on Caption Vision

This television receiver provides display of television closed captioning in accordance with § 15.119 of the FCC rules.

Use of this television for other than private viewing of programs broadcast on UHF or VHF or transmitted by cable companies for the use of the general public may require authorization from the broadcaster-cable company and/or program owner.

Owner's Record

The model and serial numbers are located on the front cover of this manual and the rear of your TV.

Trademarks and Copyrights

ENERGY STAR® is a registered mark.



As an ENERGY STAR® Partner, Sony has determined that this product or product model meets the ENERGY STAR® guidelines for energy efficiency.

Important Safeguards

For your protection, please read these instructions completely, and keep this manual for future reference. Carefully observe and comply with all warnings, cautions and instructions placed on the set, or described in the operating instructions or service manual.

WARNING

To guard against injury, the following basic safety precautions should be observed in the installation, use, and servicing of the set.

Use

Power Sources

This set should be operated only from the type of power source indicated on the serial/model plate. If you are not sure of the type of electrical power supplied to your home, consult your dealer or local power company. For those sets designed to operate from battery power, refer to the operating instructions.



Grounding or Polarization

This set is equipped with a polarized AC power cord plug (a plug having one blade wider than the other), or with a three-wire grounding type plug (a plug having a third pin for grounding).

Follow the instructions below:

For the set with a polarized AC power cord plug

This plug will fit into the power outlet only one way. This is a safety feature. If you are unable to insert the plug fully into the outlet, try reversing the plug. If the plug should still fail to fit, contact your electrician to have a suitable outlet installed. Do not defeat the safety purpose of the polarized plug by forcing it in.

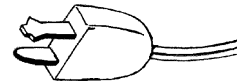

Alternate Warning

For the set with a three-wire grounding type AC plug

This plug will only fit into a grounding-type power outlet. This is a safety feature. If you are unable to insert the plug into the outlet, contact your electrician to have a suitable outlet installed. Do not defeat the safety purpose of the grounding plug.

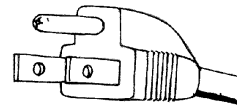

Overloading

Do not overload wall outlets, extension cords or convenience receptacles beyond their capacity, since this can result in fire or electric shock. Always turn the set off when it is not to be used. When the set is left unattended and unused for long periods of time, unplug it from the wall outlet as a precaution against the possibility of an internal malfunction that could create a fire hazard.

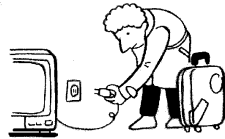
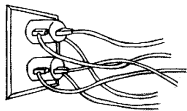

Object and Liquid Entry

Never push objects of any kind into the set through the cabinet slots as they may touch dangerous voltage points or short out parts that could result in a fire or electric shock. Never spill liquid of any kind on the set.



Attachments

Do not use attachments not recommended by the manufacturer, as they may cause hazards.

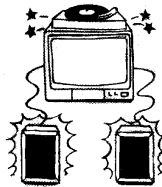

Cleaning

Unplug the set from the wall outlet before cleaning or polishing it. Do not use liquid cleaners or aerosol cleaners. Use a cloth lightly dampened with water for cleaning the exterior of the set.

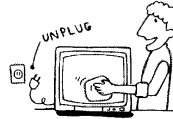

If a snapping or popping sound from a TV set is continuous or frequent while the TV is operating, unplug the TV and consult your dealer or service technician. It is normal for some TV sets to make occasional snapping or popping sounds, particularly when being turned on or off.

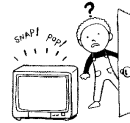

Installation

Water and Moisture

Do not use power-line operated sets near water — for example, near a bathtub, washbowl, kitchen sink, or laundry tub, in a wet basement, or near a swimming pool, etc.

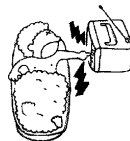

Accessories

Do not place the set on an unstable cart, stand, tripod, bracket, table, or shelf. The set may fall, causing serious injury to a child or an adult, and serious damage to the set. Use only a cart or stand recommended by the manufacturer for the specific model of TV. Any mounting of the product should follow the manufacturer's instructions, and should use a mounting accessory recommended by the manufacturer. An appliance and cart combination should be moved with care. Quick stops, excessive force, and uneven surfaces may cause the appliance and cart combination to overturn.



Ventilation

The slots and openings in the cabinet and in the back or bottom are provided for necessary ventilation. To ensure reliable operation of the set, and to protect it from overheating, these slots and openings must never be blocked or covered.

- **Never cover the slots and openings with a cloth or other materials.**

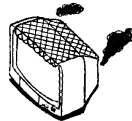

- **Never block the slots and openings by placing the set on a bed, sofa, rug or other similar surface.**

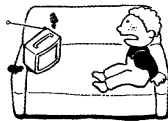

- **Never place the set in a confined space, such as a bookcase, or built-in cabinet, unless proper ventilation is provided.**

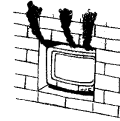

- **Do not place the set near or over a radiator or heat register, or where it is exposed to direct sunlight.**



Power-Cord Protection

Do not allow anything to rest on or roll over the power cord, and do not place the set where the power cord is subject to wear or abuse.



Grounding or Polarization

This set may be equipped with a polarized alternating current line plug (a plug having one blade wider than other). This plug will fit into the power outlet only one way. This is a safety feature. If you are unable to insert the plug fully into the outlet, try reversing the plug. If the plug should still fail to fit, contact you electrician to replace your obsolete outlet. Do not defeat the safety purpose of the polarized plug.

Antennas

Outdoor Antenna Grounding

If an outdoor antenna is installed, follow the precautions below. An outdoor antenna system should not be located in the vicinity of overhead power lines or other electric light or power circuits, or where it can come in contact with such power lines or circuits.

WHEN INSTALLING AN OUTDOOR ANTENNA SYSTEM, EXTREME CARE SHOULD BE TAKEN TO KEEP FROM CONTACTING SUCH POWER LINES OR CIRCUITS AS CONTACT WITH THEM IS ALMOST INVARIABLY FATAL.

Be sure the antenna system is grounded so as to provide some protection against voltage surges and built-up static charges. Section 810 of the National Electrical Code (NEC) in USA and Section 54 of the Canadian Electrical Code in Canada provides information with respect to proper grounding of the mast and supporting structure, grounding of the lead-in wire to an antenna discharge unit, size of grounding conductors, location of antenna discharge unit, connection to grounding electrodes, and requirements for the grounding electrode.

Antenna Grounding According to the NEC

Refer to section 54-300 of Canadian Electrical Code for Antenna Grounding.

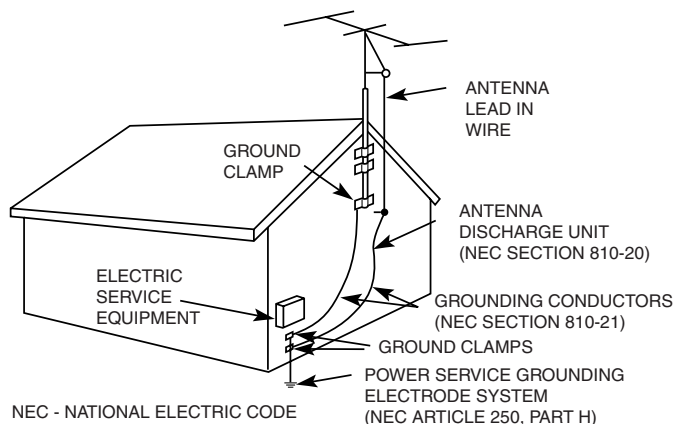

Lightning

For added protection for this television receiver during a lightning storm, or when it is left unattended and unused for long periods of time, unplug it from the wall outlet and disconnect the antenna. This will prevent damage to the receiver due to lightning and power-line surges.

Service

Damage Requiring Service

Unplug the set from the wall outlet and refer servicing to qualified service personnel under the following conditions:

- **When the power cord or plug is damaged or frayed.**

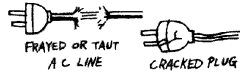

- **If liquid has been spilled into the set or objects have fallen into the product.**

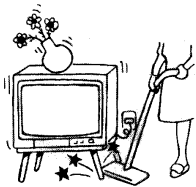

- **If the set has been exposed to rain or water.**



- **If the set has been subject to excessive shock by being dropped, or the cabinet has been damaged.**

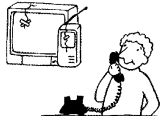

- **If the set does not operate normally when following the operating instructions. Adjust only those controls that are specified in the operating instructions. Improper adjustment of other controls may result in damage and will often require extensive work by a qualified technician to restore the set to normal operation.**

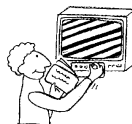

- **When the set exhibits a distinct change in performance — this indicates a need for service.**

Servicing

Do not attempt to service the set yourself since opening the cabinet may expose you to dangerous voltage or other hazards. Refer all servicing to qualified service personnel.



Replacement Parts

When replacement parts are required, be sure the service technician certifies in writing that he has used replacement parts specified by the manufacturer that have the same characteristics as the original parts. Unauthorized substitutions may result in fire, electric shock, or other hazards.



Safety Check

Upon completion of any service or repairs to the set, ask the service technician to perform routine safety checks (as specified by the manufacturer) to determine that the set is in safe operating condition, and to so certify. When the set reaches the end of its useful life, improper disposal could result in a picture tube implosion. Ask a qualified service technician to dispose of the set.



Contents

Introduction

Trinitron® Color TV Features	1
Batteries for the Remote Control.....	2
About this Manual	2





Connecting Your TV

Basic Connections.....	3
Connecting Additional Equipment	4

Using the Remote Control and Basic Functions

Using the Remote Control.....	9
Setting Up the TV Automatically.....	11
Quick Start to the Menus.....	12

Using the Menus

Using the VIDEO  menu	13
Using the AUDIO  menu	14
Using the TIMER  menu	15
Using the SET UP  menu.....	16
CHANNEL SET UP menu	17
Using PARENTAL CONTROL	18

Other Information

Troubleshooting	25
Specifications.....	27

Index	29
--------------------	----

Introduction

Congratulations on your purchase of the Sony Trinitron® Color TV. Before you begin using this manual, please check the model number located on the rear of your TV or on the front cover of this manual.

The menu and illustrations used in these instructions are for KV-20S90 to show the maximum number of features available. Differences in operation or features will be indicated in the text, for example, “KV-20S90 only.”

Trinitron® Color TV Features

Depending on your TV, some of the features you will enjoy include:

- ❑ **PARENTAL CONTROL** — A tool for parents to help monitor what their children watch on TV by establishing rating limits.
- ❑ **FAVORITE CHANNEL** — Instant access to your favorite channels with the touch of a button.
- ❑ **Energy Star** — A recognized symbol of energy efficiency.
- ❑ **Direct MTS** — Allows direct access to changing your Multi-Channel TV Sound: STEREO, SAP (Second Audio Programming), or MONO, with the touch of a button (KV-20S90 only).
- ❑ **ON/OFF TIMER** — Program your TV for scheduled viewing, (except KV-13M42).
- ❑ **Trilingual Menus** — Choose between English, French, or Spanish menus (KV-20S90 only).
- ❑ **Front Panel Controls** — Allows access to the on-screen menus without the use of a remote control.
- ❑ **Front A/V inputs** — A quick connection for video games, camcorders, or stereo/mono equipment (except KV-13M42).

Batteries for the Remote Control

Insert two AA (R6) batteries (supplied) into the remote control using the following illustration as a guide.

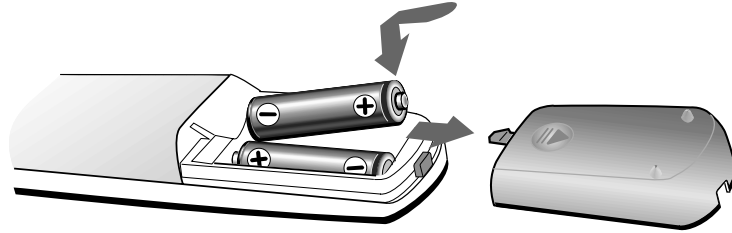

 Under normal conditions, batteries will last up to six months. If the remote control does not operate properly, the batteries might be worn out.

 Remove the batteries to avoid possible damage from battery leakage if you will not be using the remote control for an extended period of time.

About this Manual

This manual provides instructions to help you enjoy your new TV. It shows you how to connect to an antenna or cable, cable box, VCR or camcorder. Once you're connected, follow the instructions to learn how to use the remote control to access the on-screen menus.

Connecting Your TV

Read this chapter before setting up your TV for the first time. This section covers basic connections in addition to any optional equipment you may be connecting.

Basic Connections

TV with indoor or outdoor antenna, or CATV cable

Depending on the cable available in your home, choose one of the connections below:

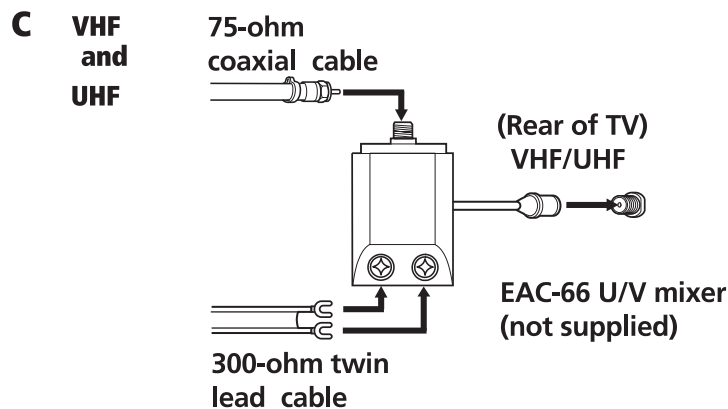
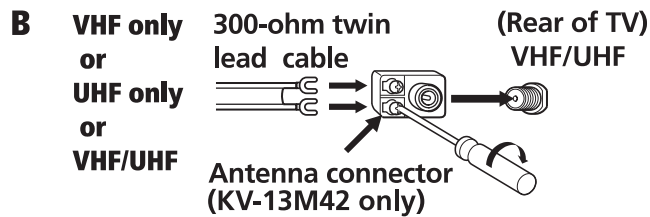
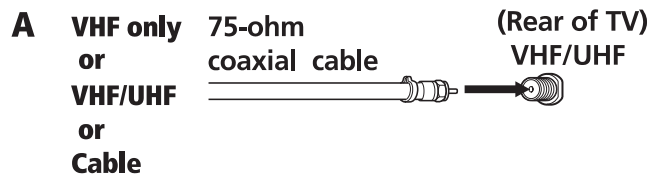

 If you are connecting to an indoor or outdoor antenna, it will be necessary to adjust the orientation of the antenna for best reception.

Connecting Additional Equipment

TV and VCR

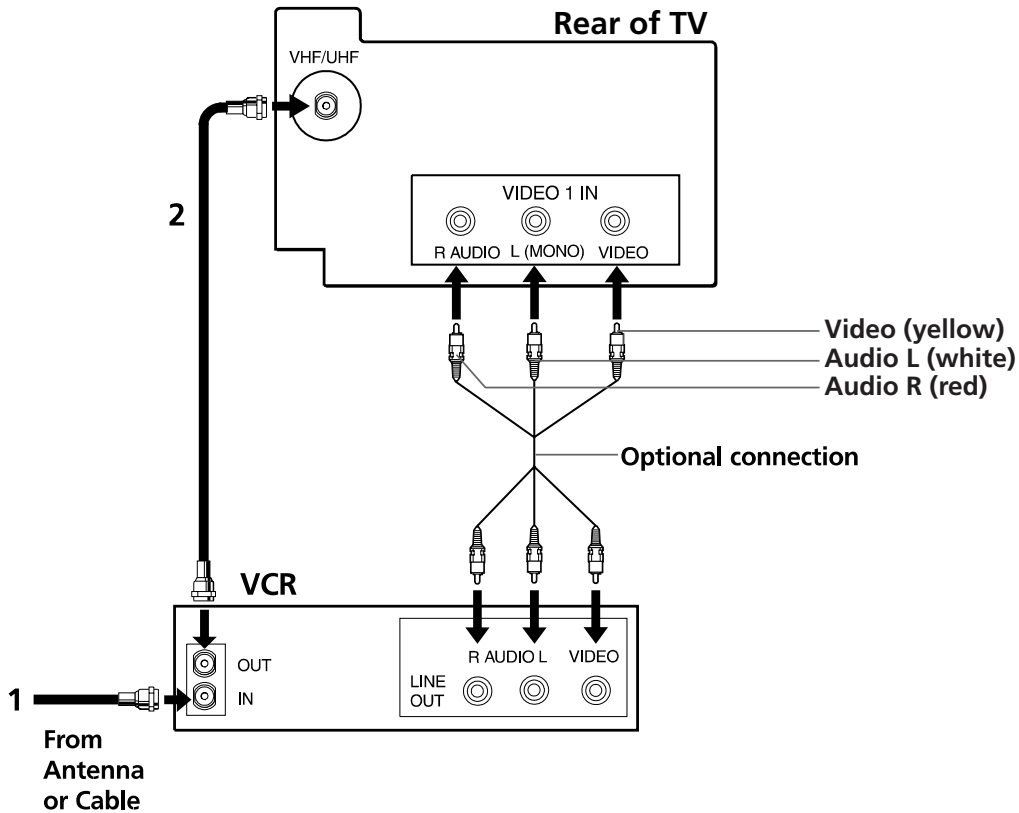

- 1** Connect the coaxial cable from your TV antenna or cable service to the IN jack on your VCR.
- 2** Connect a coaxial cable (not supplied) from the OUT jack on your VCR to the VHF/UHF IN jack on the TV.

To watch video programs from your VCR, tune your TV to channel 3 or 4 (as set on the rear of your VCR).

Optional Connection

If your VCR is equipped with video outputs, you can get better picture quality by connecting Audio/Video cables (not supplied) from AUDIO and VIDEO OUT on your VCR to AUDIO/VIDEO IN on your TV.

You can use the button to switch between the VHF/UHF and VIDEO inputs.

TV and Cable Box

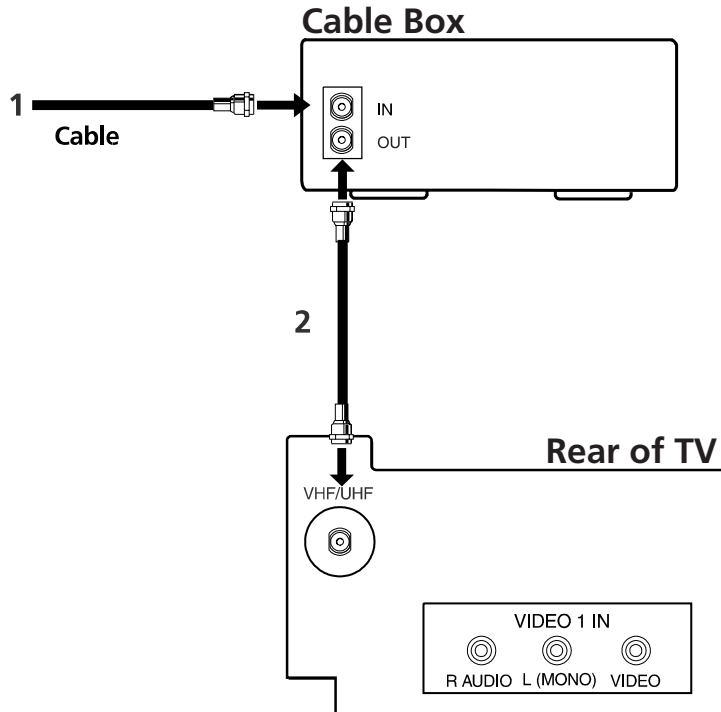

- 1** Connect the coaxial cable from your cable service to the IN jack on your cable box.
- 2** Connect a coaxial cable (not supplied) from the OUT jack on your cable box to the VHF/UHF IN jack on the TV.

 To view channels from your cable box, tune your TV to channel 3 or 4 (as set on the rear panel of your cable box) and use the cable box's remote control to change channels.

 If you will be controlling all channel selection through your cable box, you should consider using the CHANNEL FIX feature by setting your TV to channel 3 or 4, (see page 17).

TV, VCR, and Cable box

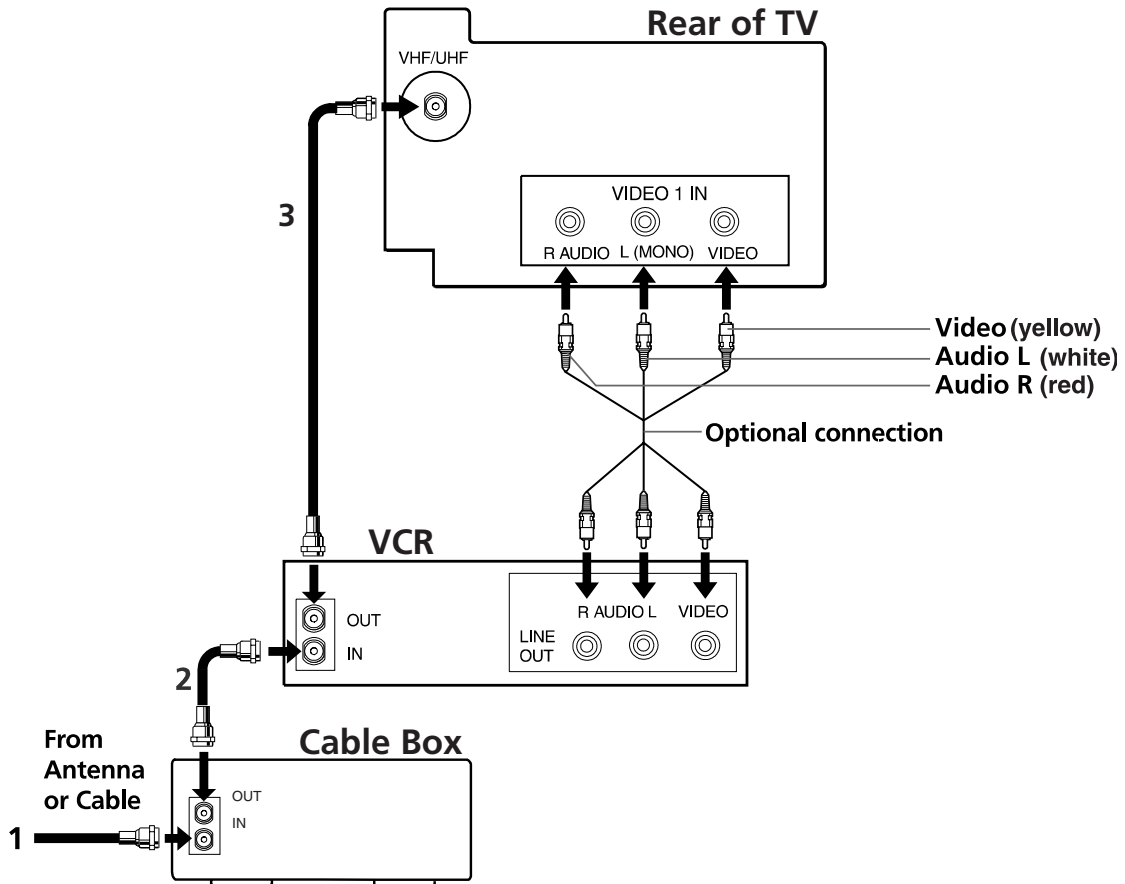

- 1** Connect the coaxial cable from your cable service to the IN jack on your cable box.
- 2** Connect a coaxial cable (not supplied) from the OUT jack on your cable box to the IN jack on your VCR.
- 3** Connect a coaxial cable (not supplied) from OUT on your VCR to VHF/UHF jack on your TV.

If you will be controlling all channel selection through your cable box, you should consider using the CHANNEL FIX feature by setting your TV to channel 3 or 4, (see page 17).

Optional Connection

If your VCR is equipped with video outputs, you can get better picture quality by connecting Audio/Video cables (not supplied) from AUDIO and VIDEO OUT on your VCR to AUDIO/VIDEO IN on your TV.

You can use the button to switch between the VHF/UHF and VIDEO inputs.

Connecting a Camcorder

Using Audio/Video cables (not supplied), connect AUDIO and VIDEO OUT on your camcorder to AUDIO and VIDEO IN on your TV.

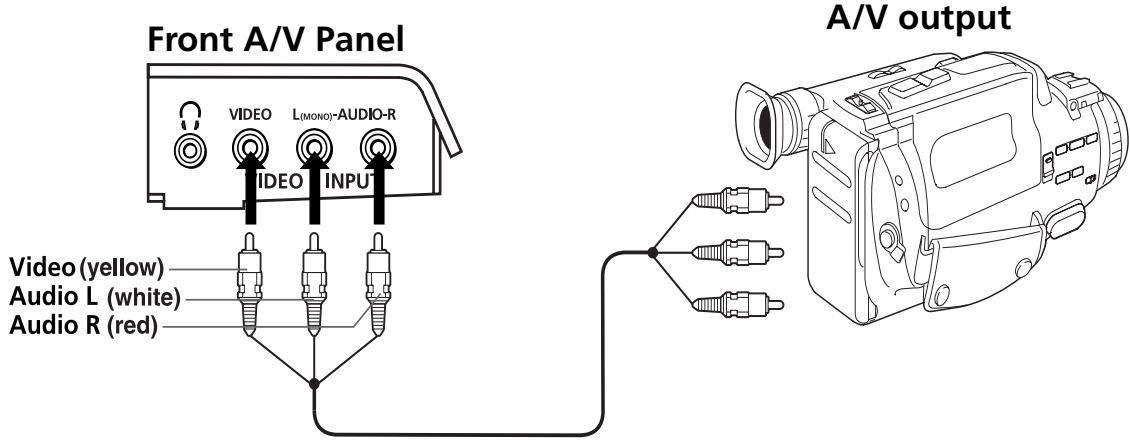

 For model KV-13M42, this connection can be made to the Audio/Video input located on the rear of the TV.





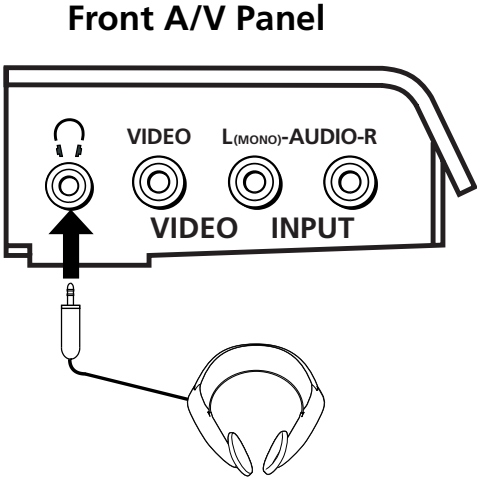









Connecting Headphones

Connect your headphones to the  jack on the front of your TV.



Using the Remote Control and Basic Functions

This section shows you how to use more advanced buttons on the remote control and how to use the on-screen menus..

Button	Description
	Press when you want to turn the TV on and off.
	Turns the TV off automatically in approximately 30, 60 or 90 minutes. Cancel by pressing until SLEEP OFF appears.
	Instantly turns off the sound. Press again or press  to restore sound.
	Cycles through the available video inputs.
	Press once to show current time, (if set) and channel number. Press again to activate CAPTION VISION settings, if available. To cancel, press again until DISPLAY OFF appears.
	Cycles through the Multi-Channel TV Sound (MTS) options: STEREO, SAP (Second Audio Programming) and MONO, (KV-20S90 only).
	Press for channel selection, the channel will change after 2 seconds.
	Press after selecting a channel using the  buttons to immediately activate selection.
	Alternates back and forth between the last two channels selected with the  buttons.
	Displays the on-screen menu. Press again to exit the menu at any time.
	Activates highlighted selections in the on-screen menu.

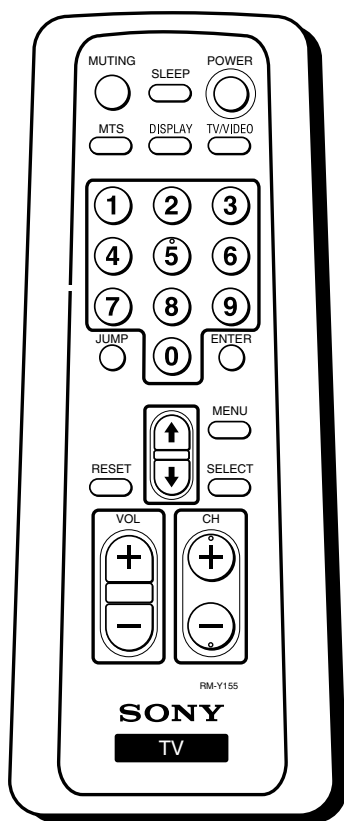

 The remote control shown (RM-Y155) is for KV-20S90. For KV-13M42 and KV-20M42 models, your remote control does not have the MTS button.

Operating Instructions



Moves the cursor in the on-screen menu.



Press to restore factory settings while in the on-screen menu.



Press when you want to change channels.



Press when you want to adjust the volume.

 If you lost your remote control, see page 26

Setting Up the TV Automatically

After you have finished connecting your TV, you will want to run AUTO PROGRAM to set up your channels, (KV-13M42, see page 17 for information on AUTO PROGRAM).

For models KV-20M42, KV-20S90 only

- 1** Press  to turn on the TV, the Initial setup screen appears.

(U.S. models only)

ENGLISH:	[CH+]
ESPAÑOL:	[CH-]
AUTO SET UP:	[VOL+]
DEMO:	[VOL-]
MENU:	[TV/VIDEO]
First please connect cable/antenna Press [SET UP] to exit	

(Canadian models only)



ENGLISH:	[CH+]
ESPAÑOL:	[CH-]
FRANÇAIS:	[VOL+]
AUTO SET UP:	[VOL-]
DEMO:	[TV/VIDEO]
First please connect cable/antenna Press [SET UP] to exit	



- 2** Make your language selection, the on-screen menus will change to reflect your choice.
- 3** Follow the on-screen instructions to continue AUTO SET UP or for a DEMO of the menus.

For U.S. models only

- 4** Press  to operate the on-screen menus without the remote control. Follow the on-screen instructions to make adjustments to your TV settings.



To perform Auto Setup again

- Press the  and  buttons on the front panel of the TV and follow steps 2-4.

 To reset your TV to factory settings, turn the TV on. Then, while pressing the  button on the remote control, press POWER on the TV. The TV will turn itself off, then back on, the original settings will be restored.

Quick Start to the Menus

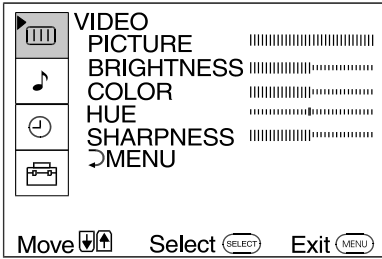
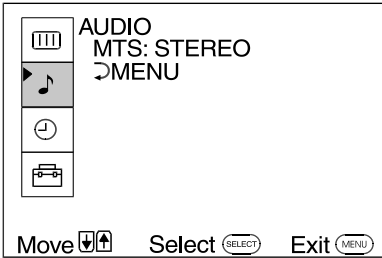
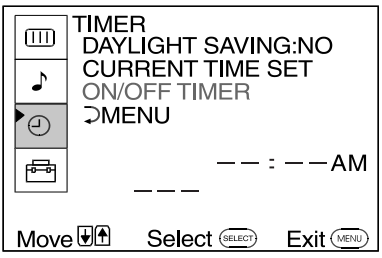
The following settings are available in your on-screen menus:

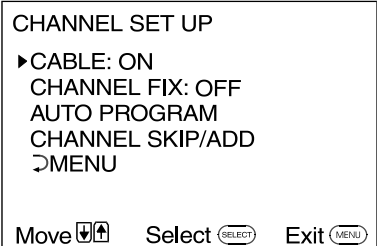
Menu	Allows you to
	Make adjustments to your picture settings.
	Choose from available audio features, such as Multi-Channel Sound, (KV-20S90 only).
	Set the clock on your TV (CURRENT TIME SET) and program scheduled viewing (ON/OFF TIMER) (Except KV-13M42).
	

Program your channels, set TV rating, or select menu language.









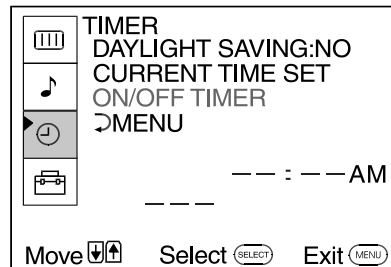

















The CHANNEL SET UP menu is a sub-menu that provides further options for setting up your channels.

 The menus shown are for KV-20S90. Your menus may not look like those illustrated.

Using the **TIMER** menu

Except KV-13M42







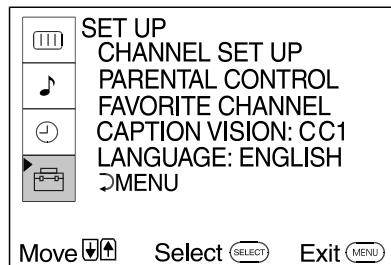



DAYLIGHT SAVING	YES: Select in spring to compensate for Daylight Savings. NO: Select in fall at the end of Daylight Savings.
CURRENT TIME SET	With the menu open: <ol style="list-style-type: none"> 1 Press . 2 Press  or  to cycle through the days, then press . 3 Press  or  until the current hour is displayed, then press . 4 Press  or  until the current minute is displayed, then press .
ON/OFF TIMER <i>Scheduled viewing</i>	CURRENT TIME SET must be programmed before the ON/OFF TIMER is available. With the menu open: <ol style="list-style-type: none"> 1 Press . 2 Press  or  until the desired day or range of days is displayed, then press . 3 Indicate the time that you want the TV to turn on by pressing  or  and the , (for hour and minutes). 4 Press  or  to set the duration, up to 6 hours, then press . 5 Press  or  to set the channel and press .
	When you perform AUTO PROGRAM, all ON/OFF TIMER settings will be cleared.
	Any loss of power will cause the ON/OFF TIMER settings to be cleared.
	When the ON/OFF TIMER is programmed, the light on the front of your TV will be turned on.



Using the SET UP menu





PARENTAL CONTROL The PARENTAL CONTROL feature provides parents several options for programming the TV to block shows based on their rating, (see page 18).

FAVORITE CHANNEL With the FAVORITE CHANNEL menu open:





- 1 Press .
- 2 Use the  or  buttons to select AUTO or MANUAL, (selecting AUTO will display the last five channels accessed by the - buttons).
- 3 Select the position (1-5) where you want to program a channel. Then press .
- 4 Using the  or  buttons, select the desired channel.
- 5 Press , the TV will change to the channel entered.

 To use FAVORITE CHANNEL, exit all menus and press . A window picture will display your favorite channel numbers. Move the cursor to a channel number and press  to view.

CAPTION VISION **CC1, 2, 3, 4:** Displays printed dialogue and sound effects of a program.
Closed-captioning **TEXT1, 2, 3, 4:** Displays network/station information.
XDS (Extended Data Services): Displays information about the network and current program, if available.

 Press the  button to activate your CAPTION VISION setting.

LANGUAGE Display all menus in your language of choice.

- 1 Point cursor at LANGUAGE and press .
- 2 Using the  or  buttons, highlight the desired language and press .

CHANNEL SET UP menu



CABLE **ON:** Select if you are receiving cable channels with a CATV cable.
OFF: Select if you are using an antenna.

After changing your CABLE settings, you will need to run AUTO PROGRAM.

CHANNEL FIX **2-6:** Select when you want to control all channel selection through a cable box. Select the appropriate channel (usually 3 or 4) and use the cable box's remote control for channel selection.
VIDEO: Select from available inputs when you have connected video equipment (e.g. satellite receiver) and you want your TV fixed to it.

FAVORITE CHANNEL cannot be used when CHANNEL FIX is set.

AUTO PROGRAM Run AUTO PROGRAM whenever setting up your TV. It will cycle through all available channels and program any receivable channels.

CHANNEL SKIP/ADD Use this feature after you run AUTO PROGRAM to skip unwanted channels or add new ones.
1 Use the **0-9** or CH +/- buttons to access the desired channel.
2 Press **SELECT** to SKIP or ADD (only one option will be available).

Using PARENTAL CONTROL

The PARENTAL CONTROL feature is designed to help parents monitor what their children watch on television. This section shows you the different rating systems available and how to set your TV's rating.

Overview of the Ratings

Once you have become familiar with these rating systems, you should be ready to set your TV's rating.

TV RATINGS

The TV ratings are divided into two groups: age-based and content-based.

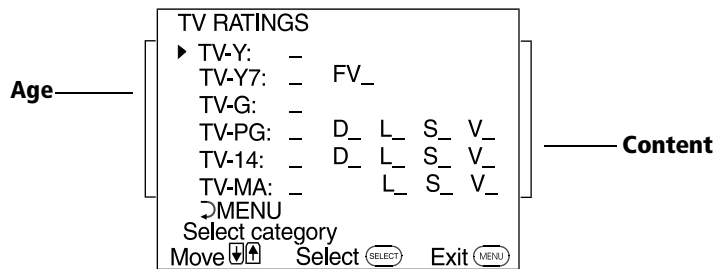

Age	Defined as
TV-Y	All children
TV-Y7	Directed to older children
TV-G	General audience
TV-PG	Parental Guidance suggested
TV-14	Parents Strongly cautioned
TV-MA	Mature Audience only

Contents	Defined as
FV	Fantasy Violence
D	Suggestive dialogue
L	Strong language
S	Sexual situations
V	Violence

The content ratings will increase depending on the level of the age-based rating. For example, a program with a TV-PG V (Violence) rating may contain moderate violence, while a TV-14 V (Violence) rating may contain more intense violence.

MOVIE RATINGS

(U.S. models only)

This system defines the rating levels of movies shown on the big screen and those on prime cable channels.

Rating	Defined as
G	General audience
PG	Parental Guidance suggested
PG-13	Parents Strongly cautioned
R	Restricted
NC-17	No one 17 and under admitted
X	Adult audience only

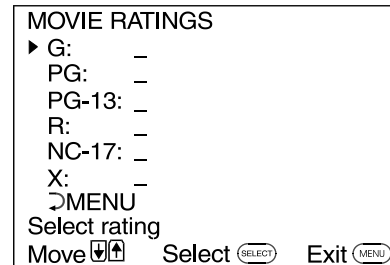



UNRATED

(U.S. models only)

You have the option of blocking TV programs or movies that are not rated.

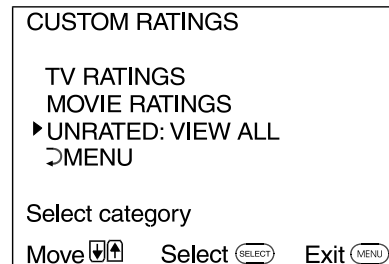
Rating	Defined as
VIEW ALL	No block
BLOCK TV	Block all unrated TV programs
BLOCK MOVIE	Block all unrated movies
BLOCK ALL	Block all unrated programming



 If you choose to block unrated TV programs, please be aware the following programs may be blocked: emergency broadcasts, political programs, sports, news, public service announcements, religious programs and weather.

ENGLISH RATINGS

(Canadian models only)

These ratings are for Canadian programs that are broadcast in English.

Rating	Defined as
C	Children
C8+	Children 8 years and older
G	General programming
PG	Parental Guidance
14+	Viewers 14 and older
18+	Adult programming

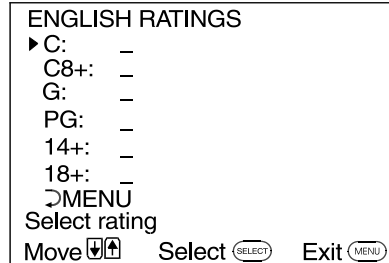

FRENCH RATINGS

(Canadian models only)

These ratings are for Canadian programs that are broadcast in French.

Rating	Defined as
G	General
8 ans+	Not recommended for younger children
13 ans+	Not recommended for children under age 13
16 ans+	Not recommended for ages under 16
18 ans+	This program is restricted to adults

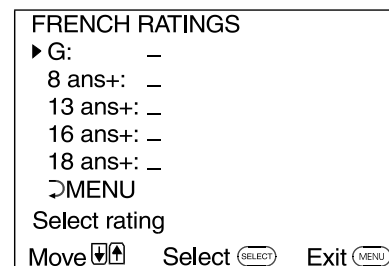





U.S.A. RATINGS

(Canadian models only)

For programs from the United States. Please see, "TV RATINGS" on page 18 for information on U.S.A. RATINGS.

Initial access into PARENTAL CONTROL

- 1 In the SET UP  menu, point the cursor to PARENTAL CONTROL and press , (you will be asked to set 4-digit password for any future access into PARENTAL CONTROL).
- 2 Press , then use the  buttons to enter a 4-digit password.

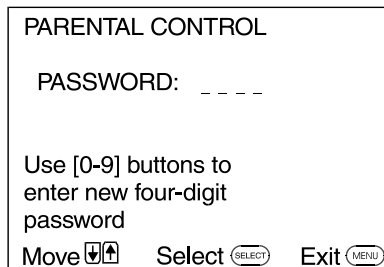

 Keep this instruction manual in a safe place. In the event that you forget your password, please see page 26.





- 3 Confirm your password by entering it again.

Once your password is set correctly, you will be taken into the PARENTAL CONTROL menu.

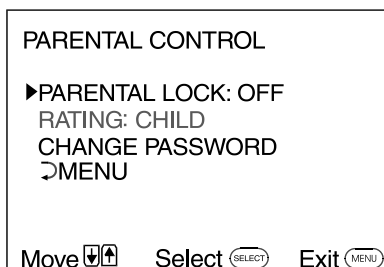
Activating PARENTAL LOCK





In order to change the RATING, you will need to set PARENTAL LOCK to ON.



- 1 Point the cursor to PARENTAL LOCK and press .
- 2 Using the  or  buttons, highlight ON and press  to activate.

Setting the RATING

If you are not familiar with the Parental Guidelines rating system, you should use one of the following preselected categories: CHILD, YOUTH or YOUNG ADULT.



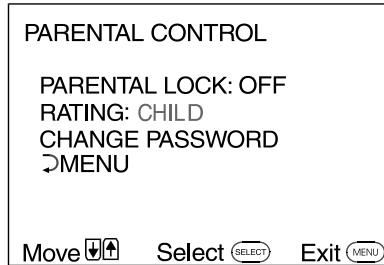











- 1 Point the cursor to RATING and press .
- 2 Using the  or  buttons, select the desired rating and press .



Rating	TV will allow a maximum rating of:
CHILD	TV-Y, TV-G, G (U.S. models only), G (Canadian models only)
YOUTH	TV-PG, PG (U.S. models only), PG (Canadian models only)
YOUNG ADULT	TV-14, PG-13 (U.S. models only), 14+ (Canadian models only)
CUSTOM	Select to set more restrictive ratings, (see next section).

Using the CUSTOM menu

You should be familiar with the rating systems before attempting to set CUSTOM ratings. Refer to pages 18-20, "Overview of the Ratings," for a description of the available rating systems.

- 1 In the RATING option, use  or  to highlight CUSTOM and press .
- 2 Using the  or  buttons, select the desired rating category and press .
- 3 Use  or  to select the maximum rating or content and press .
- 4 Press  or  to block () or unblock () the rating or content and press .

 Once you have blocked a rating or content, all higher ratings or contents will be automatically blocked.

Resetting your password

- 1 Use the \uparrow or \downarrow buttons to move the cursor to CHANGE PASSWORD and press .
- 2 Follow the directions for, "Initial Access into Parental Control," on page 21, for information on changing your password.

Information for Parents

To view a program that exceeds the TV rating

- Press  on the remote control, then use the $\textcircled{0}$ - $\textcircled{9}$ buttons to enter your password.

 Entering your password to view a blocked program will temporarily turn PARENTAL LOCK to OFF. To reactivate your PARENTAL LOCK settings, turn the TV off then back on; the TV will return to the settings that you have selected.

Other Information

Troubleshooting

If you are having a problem with your TV, try the suggestions below. If the problem persists, contact your nearest Sony dealer.

No picture, no sound	<ul style="list-style-type: none"><input type="checkbox"/> Make sure the power cord is plugged in.<input type="checkbox"/> If a red light is flashing on the front of your TV for more than a few minutes, disconnect and reconnect the power cord to restore the TV. If the problem continues, call your local service center.<input type="checkbox"/> Check the TV/VIDEO settings: when watching TV, set to TV; when watching video equipment, set to VIDEO (page 9).<input type="checkbox"/> Check your PARENTAL CONTROL settings, (see pages 21-23).<input type="checkbox"/> Make sure the batteries have been inserted correctly into the remote control.<input type="checkbox"/> Try another channel, it could be station trouble.
Poor or no picture, good sound	<ul style="list-style-type: none"><input type="checkbox"/> Adjust PICTURE in the VIDEO menu (page 13).<input type="checkbox"/> Adjust BRIGHTNESS in the VIDEO menu (page 13).<input type="checkbox"/> Check the antenna and/or cable connections (page 3).
Good picture, no sound	<ul style="list-style-type: none"><input type="checkbox"/> Press  so that MUTING disappears from the screen (page 9).<input type="checkbox"/> Check your AUDIO settings. Your TV may be set to SAP (page 14).
No color	<ul style="list-style-type: none"><input type="checkbox"/> Adjust COLOR in the VIDEO menu (page 13).
Only snow appears on the screen	<ul style="list-style-type: none"><input type="checkbox"/> Check the CABLE setting in the CHANNEL SET UP menu (page 17).<input type="checkbox"/> Check the antenna and/or cable connections (page 3).<input type="checkbox"/> Make sure the channel selected is currently broadcasting.
Dotted lines or stripes	<ul style="list-style-type: none"><input type="checkbox"/> Adjust the antenna.<input type="checkbox"/> Move the TV away from other electronic equipment. Some electronic equipment can create electrical noise, which can interfere with TV reception.
Double images or ghosts	<ul style="list-style-type: none"><input type="checkbox"/> Check your outdoor antenna or call your cable service.

Cannot receive higher number channels (UHF) when using an antenna	<ul style="list-style-type: none"><input type="checkbox"/> Make sure CABLE is set to OFF in the CHANNEL SET UP menu (page 17).<input type="checkbox"/> Use AUTO PROGRAM to add channels that are not presently in the memory (page 17).
Cable stations don't seem to work	<ul style="list-style-type: none"><input type="checkbox"/> Make sure CABLE is set to ON in the CHANNEL SET UP menu (page 17).<input type="checkbox"/> Use AUTO PROGRAM to add channels that are not presently in the memory (page 17).
Remote control does not operate	<ul style="list-style-type: none"><input type="checkbox"/> Batteries could be weak. Replace them (page 2).<input type="checkbox"/> Move the TV 3-4 feet away from fluorescent lights.
The TV needs to be cleaned	<ul style="list-style-type: none"><input type="checkbox"/> Clean the TV with a soft dry cloth. Never use strong solvents such as thinner or benzine, which might damage the finish of the cabinet.
Lost password for PARENTAL CONTROL	<ul style="list-style-type: none"><input type="checkbox"/> In the password screen, enter the following master password: 4357. After using the master password, you must create a new password, it cannot be used to unlock currently blocked programs.
You lost your remote control	<ul style="list-style-type: none"><input type="checkbox"/> You can use the control buttons on the front panel of your TV. Follow the instructions on the screen. Contact your nearest Sony dealer to order a replacement.

If, after reading these operating instructions, you have additional questions related to the use of your Sony television, please call our Direct Response Center at 1-800-222-SONY (7669) (U.S. customers only) or (416) 499-SONY (7669) (Canadian customers only).

Specifications

For all models (except as noted)

Television system	American TV standard/NTSC
Channel coverage	VHF: 2-13/UHF: 14-69/CATV: 1-125
Antenna	75-ohm external antenna terminal for VHF/UHF
Picture tube	Trinitron® tube
Power requirements	120 V, 60 Hz
Supplied Accessories	Size AA (R6) batteries (2) Antenna connector (KV-13M42 only) Remote Control RM-Y156 (1) (KV-13M42, KV-20M42) RM-Y155 (1) (KV-20S90) Antenna dipole (KV-13M42 only)

KV-13M42

Screen size	Visible screen size: 13 inches (341 mm) measured diagonally Actual screen size: 14 inches (356 mm) measured diagonally
Inputs/outputs	1 video, 1 audio 1 headphone jack
Speaker output	3 W
Power Consumption	75 W when in use 1 W in standby
Dimensions (W/H/D)	358 x 355 x 401.4 mm (14 ¹ / ₈ x 14 x 15 ⁷ / ₈ in.)
Mass	10 kg (22 lbs.)

KV-20M42, KV-20S90

Screen size	Visible screen size: 20 inches (507 mm) measured diagonally Actual screen size: 21 inches (533 mm) measured diagonally
Inputs/outputs	2 video, 2 audio 1 headphone jack
Speaker output	3 W (KV-20M42) 3W x 2 (KV-20S90)
Power Consumption	80 W when in use (KV-20M42) 90 W when in use (KV-20S90) 1 W in standby
Dimensions (W/H/D)	522 x 477 x 479 mm (KV-20M42) (20 ⁵ / ₈ x 18 ¹³ / ₁₆ x 18 ⁷ / ₈ inch) 609.2 x 464.5 x 469.5 mm (KV-20S90) (24 x 18 ³ / ₈ x 18 ¹ / ₂ inch)
Mass	21.6 kg (48 lbs.) (KV-20M42) 21 kg (46.2 lbs.) (KV-20S90)

Design and specifications are subject to change without notice.

Index

A

AUDIO 🎵 menu 14
AUTO PROGRAM 17

B

Battery Installation 2
BRIGHTNESS 13

C

CAPTION VISION 16
CHANNEL FIX 17
CHANGE PASSWORD 23
CHANNEL SET UP 17
COLOR 13
Connections
 Antenna/Cable 3
 TV and Cable Box 5
 TV and VCR 4
 TV, VCR, and Cable box 6
 Connecting a Camcorder 7
 Connecting Headphones 7
CURRENT TIME SET 15

D

DAYLIGHT SAVING 15
DISPLAY 9

E

ENGLISH RATINGS 20

F

FAVORITE CHANNEL 1, 16
FRENCH RATINGS 20

H

HUE 13

L

LANGUAGE 16

M

Menus
 AUDIO 🎵 14
 CHANNEL SET UP 17
 SET UP 📺 16
 TIMER ⏴ 15
 VIDEO 📺 13
MOVIE RATING 19
MTS 14
 MONO 14
 SAP 14
 STEREO 14

O

ON/OFF TIMER 1, 15

P

PARENTAL CONTROL 1, 18
Password 21
 Entering 21
 Lost 26
PICTURE 13

R

RATINGS 18
 ENGLISH 20
 FRENCH 20
 MOVIE 19
 TV 18
 UNRATED 19
Remote Control 9

S

SET UP 📺 menu 16
SHARPNESS 13
SLEEP 9
Specifications 27

T

TIMER  menu 15
Troubleshooting 25
TV Features 1
TV RATING 18

U

U.S.A. RATINGS 20
UNRATED 19

V

VIDEO  menu 13

PRINTING THE SERVICE MANUAL

The PDF of this service manual is not designed to be printed from cover to cover. The pages vary in size, and must therefore be printed in sections based on page dimensions.

NON-SCHEMATIC PAGES

Data that does NOT INCLUDE schematic diagrams are formatted to 8.5 x 11 inches and can be printed on standard letter-size and/or A4-sized paper.

SCHEMATIC DIAGRAMS

The schematic diagram pages are provided in two ways, full size and tiled. The full-sized schematic diagrams are formatted on paper sizes between 8.5" x 11" and 18" x 30" depending upon each individual diagram size. Those diagrams that are LARGER than 11" x 17" in full-size mode have been tiled for your convenience and can be printed on standard 11" x 17" (tabloid-size) paper, and reassembled.

TO PRINT FULL SIZE SCHEMATIC DIAGRAMS

If you have access to a large paper plotter or printer capable of outputting the full-sized diagrams, output as follows:

- 1) Note the page size(s) of the schematics you want to output as indicated in the middle window at the bottom of the viewing screen.
- 2) Go to the File menu and select Print Set-up. Choose the printer name and driver for your large format printer. Confirm that the printer settings are set to output the indicated page size or larger.
- 3) Close the Print Set Up screen and return to the File menu. Select "Print..." Input the page number of the schematic(s) you want to print in the print range window. Choose OK.

TO PRINT TILED VERSION OF SCHEMATICS



Schematic pages that are larger than 11" x 17" full-size are provided in a 11" x 17" printable tiled format near the end of the document. These can be printed to tabloid-sized paper and assembled to full-size for easy viewing.

If you have access to a printer capable of outputting the tabloid size (11" x 17") paper, then output the tiled version of the diagram as follows:

- 1) Note the page number(s) of the schematics you want to output as indicated in the middle window at the bottom of the viewing screen.
- 2) Go to the File menu and select Print Set-up. Choose the printer name and driver for your printer. Confirm that the plotter settings are set to output 11" x 17", or tabloid size paper in landscape () mode.
- 3) Close the Print Set Up screen and return to the File menu. Select "Print..." Input the page number of the schematic(s) you want to print in the print range window. Choose OK.

TO PRINT SPECIFIC SECTIONS OF A SCHEMATIC

To print just a particular section of a PDF, rather than a full page, access the Graphics Select tool in the Acrobat Reader tool bar.

- 1) To view the Graphics Select Tool, press and HOLD the mouse button over the Text Select Tool which looks like: . This tool will expand to reveal to additional tools. Choose the Graphics Select tool by placing the cursor over the button on of the far right that looks like: .
- 2) After selecting the Graphics Select Tool, place your cursor in the document window and the cursor will change to a plus (+) symbol. Click and drag the cursor over the area you want to print. When you release the mouse button, a marquee (or dotted lined box) will be displayed outlining the area you selected.
- 3) With the marquee in place, go to the file menu and select the "Print..." option. When the print window appears, choose the option under the section called "Print Range" which says "Selected Graphic".

Select OK and the output will print only the area that you outlined with the marquee. 

(continued >)

ON-SCREEN SEARCH OPTION

All of the text within the service manual PDF is content searchable. This means that you can enter any text, word, phrase or reference number that appears in the manual, and the PDF software will search, find and move the cursor to the location where you requested text first appears. This feature can be particularly useful in locating components on a specific schematic or printed wire circuit board (PWB) diagrams.

Follow these steps to effectively locate a component on a schematic diagram:

- 1) Locate the schematic you want to search by clicking on the corresponding bookmark on the left side of the screen. The view on the right of the screen will then jump to the desired schematic page.
- 2) Magnify the diagram to at least 400% before conducting a component search. This will enable you to easily view the reference number when it is highlighted on screen. To do this, click on the magnifying glass button on the tool bar at the top of the screen. Move the cursor over the diagram and RIGHT click you mouse. Select the 400% magnification option on the pop-up menu. Click on the button with the icon of the open hand to deactivate the magnification tool
- 3) Search the diagram (or the entire manual) by clicking on the binocular button tool at the top of the screen. The "Find" window will appear and allow you to type in your desired text. Type in a reference designator, such as R502, and click on the "Find" button. If the component is not on the diagram, but is listed anywhere else in the manual, the cursor will jump to the first location the text is found in the file. To find another instance of that same text, click on the binocular button again and select "Find Again."

HISTORY INFORMATION FOR THE FOLLOWING MANUAL:

BA-4D CHASSIS

<i>MODEL NAME</i>	<i>REMOTE COMMANDER</i>	<i>DESTINATION</i>	<i>CHASSIS NO.</i>
KV-20S90	RM-Y155	US	SCC-S27NA
KV-21SE43C	RM-Y155	E	SCC-S55BA

ORIGINAL MANUAL ISSUE DATE: 4/2001

ANY REVISIONS AND UPDATES TO THE ORIGINAL MANUAL ARE APPENDED TO THE END OF THE PDF FILE.

<u>REVISION DATE</u>	<u>REVISION TYPE</u>	<u>SUBJECT</u>
4/2001	No revisions or updates applicable at this time	

TRINITRON® COLOR TELEVISION
SONY®