

SONY[®]

Startup guide

Xperia™ Tablet Z
SGP521

XPERIA

Sony Mobile Communications AB
SE-221 88 Lund, Sweden
www.sonymobile.com

Welcome

Important Information

Before you use your device, please read the *Important Information* provided in your device regarding warranty, safety and handling information.

Protecting your device from water and dust

Your device has IP (Ingress Protection) ratings of IP55 and IP58. These ratings mean that your device is dust resistant and is protected against low pressure water stream as well as against the effects of submersion for 30 minutes in fresh (non-saline) water up to 1.5 metres deep.

Always firmly attach all covers to ensure the water and dust resistance of the device. If liquid is detected inside the device, for example, underneath one of the covers, your warranty will be void.

Before using your device in water and in dusty conditions, refer to the relevant section of the User guide for your device for more detailed information. An online User guide as well as a downloadable version is available at www.sonymobile.com/support.

Assembly

To insert a memory card

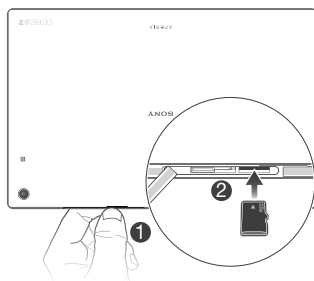

To insert the micro SIM card

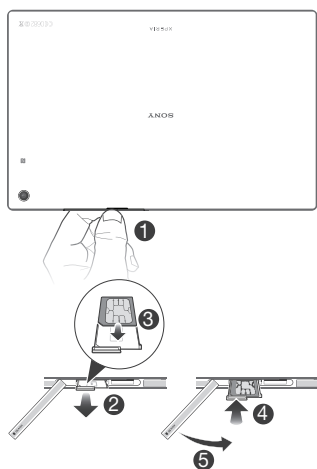

Overview

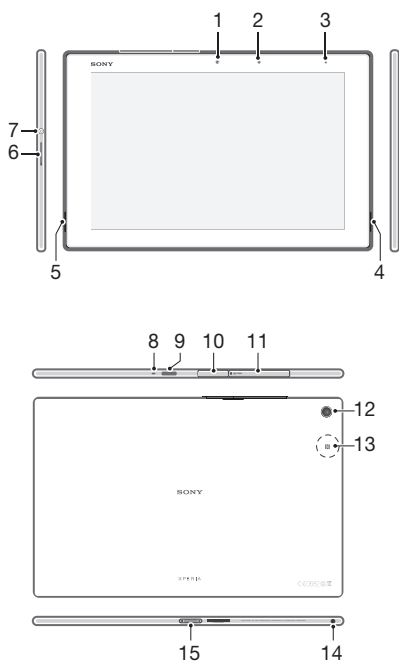



1. Front camera
2. Light sensor
3. Charging light/Notification light
4. Speaker A
5. Speaker B
6. Volume key
7. Power key
8. Microphone
9. Infrared sensor
10. Charger/USB port cover
11. Cover for memory card slot and micro SIM slot
12. Main camera
13. NFC™ detection area
14. Headset jack
15. Charging dock connector

Turning on the device

If it is the first time you turn on your device, make sure that the battery is charged for at least 30 minutes before you turn on the device for the first time.

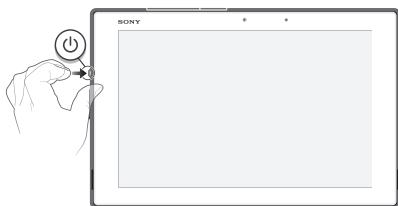
To turn on the device



- 1 Press and hold down the power key  until the device vibrates.
- 2 Wait a while for the device to start.

To force the device to shut down

- 1 Press and hold down both the volume up key and the power key  for 10 seconds.
- 2 After your device vibrates three times, release the keys. The device turns off automatically.

Finding your way

Waking up the screen

To activate the screen

- Briefly press the power key (⏻).
 - If Tap to wake up mode is enabled, double-tap the screen.
- 💡 To enable Tap to wake up mode, go to the Home screen, then tap  > **Settings** > **Display** > **Tap to wake up**.

To unlock the screen

- Place a finger on the right part of the screen and swipe in any direction.

Using the keys



Back

- Go back to the previous screen
- Close the on-screen keypad, a dialog box, an options menu, the Notification panel, or an application



Home

- Go to the Home screen



Task

- Tap to open a window showing your most recently used applications and a small apps bar

Home screen

You can customise your Home screen with widgets, shortcuts, folders, themes, wallpaper and other items. You can also add more panes to it. You can view content in other panes of the Home screen by flicking left or right.

- 💡 The items in the bar at the top of the screen are always available for quick access.

To go to the Home screen

- Press .

To browse the Home screen

- Flick right or left.

To add a widget to the Home screen

- 1 Touch and hold an empty area on your Home screen until the device vibrates, then tap **Widgets**.
- 2 Find and tap the widget that you want to add.

Application screen

The Application screen, which you open from your Home screen, contains the applications that come pre-

installed on your device as well as the applications you download.

The Application screen extends beyond the regular screen width, so you need to flick left and right to view all content.

To open the Application screen



- From your Home screen, tap 

Status and notifications

The status bar at the top of your screen shows what's going on in your device. For example, new message and calendar notifications appear here.





To open the Notification panel

- Drag the left side of the status bar downwards.

More basics

Calling

To make a call by dialling

- 1 From your Home screen, tap .
- 2 Find and tap **Phone**.
- 3 Enter the number of the recipient and tap .

To end a call

- Tap .







To answer a call



- Drag  to the right across the screen.

Multimedia and text messaging



To create and send a message

- 1 From your Home screen, tap , then find and tap .
- 2 Tap .
- 3 Tap , then tap **Add recipient** and select a contact from the Contacts list. If the recipient is not listed as a contact, enter the recipient's number manually and tap .
- 4 When you are finished adding recipients, tap **Done**.
- 5 Tap **Write message** and enter your message text.
- 6 If you want to add a media file, tap  and select an option.
- 7 To send the message, tap **Send**.

About Email

You can handle several email accounts at the same time using the Email application, including corporate Microsoft Exchange Active Sync accounts. Emails you receive to your Gmail™ account can be accessed on your device from both the Email and the Gmail™ applications.

To set up an email account

- 1 From your Home screen, tap .
 - 2 Find and tap Email.
 - 3 Follow the instructions that appear on the screen to complete the setup.
-  For some email services, you may need to contact your email service provider for information on detailed settings for the email account.

Accessing settings

View and change settings for your device from the Settings menu. The Settings menu is accessible from both the Notification panel and the Application screen.

To access your device settings

- 1 From your Home screen, tap .
- 2 Find and tap **Settings**.

Setting up your device

Google™ account

With a Google™ account, you can use Gmail™ to send emails, Hangouts™ to chat with friends, and Google Play™ to download applications and games, music, movies and books.

To set up a Google™ account on your device

- 1 From your Home screen, tap .
- 2 Find and tap **Settings** > **Add account** > **Google**.
- 3 Follow the registration wizard to create a Google™ account, or sign in if you already have an account.

- You can also sign in to or create a Google™ account from the setup guide the first time you start your device. Or you can go online and create an account at www.google.com/accounts.

Basic settings

The first time you start your device, a setup guide explains basic device functions and helps you enter essential settings. You can also access the setup guide later.

To access the setup guide manually

- 1 From the Home screen, tap .
- 2 Tap **Settings** > **Setup guide**.

Legal information

To view the CE mark

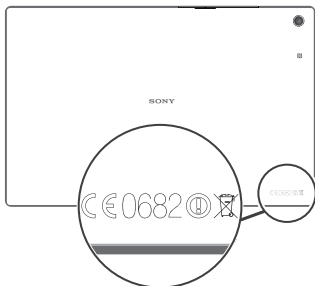

SonySGP521

Google Play™ is not available in all countries. Some of the services and features described in this Startup guide are not supported in all countries/regions or by all networks and/or service providers in all areas. Without limitation, this applies to the GSM International Emergency Number 112. Please contact your network operator or service provider to determine availability of any specific service or feature and whether additional access or usage fees apply.

This Startup guide is published by Sony Mobile Communications AB or its local affiliated company, without any warranty. Improvements and changes to this Startup guide necessitated by typographical errors, inaccuracies of current information, or improvements to programs and/or equipment, may be made by Sony Mobile Communications AB at any time and without notice. Such changes will, however, be incorporated into new editions of this Startup guide.

© 2013 Sony Mobile Communications AB. All rights reserved.

Your device has the capability to download, store and forward additional content, e.g. ringtones. The use of such content may be restricted or prohibited by rights of third parties, including but not limited to restriction under applicable copyright laws. You, and not Sony, are entirely responsible for additional content that you download to or forward from your device. Prior to your use of any additional content, please verify that your intended use is properly licensed or is otherwise authorized. Sony does not guarantee the accuracy, integrity or quality of any additional content or any other third party content. Under no circumstances will Sony be liable in any way for your improper use of additional content or other third party content.

This Startup guide may reference services or applications provided by third parties. Use of such programming or services may require separate registration with the third party provider and may be subject to additional terms of use. For applications accessed on or through a third-party website, please review such websites' terms of use and applicable privacy policy in advance. Sony does not warrant or guarantee the availability or performance of any third-party websites or offered services.

See regulatory information such as the CE mark in the label tray of the device.

All product and company names mentioned herein are the trademarks or registered trademarks of their respective owners. Any rights not expressly granted herein are reserved. All other trademarks are property of their respective owners.

Visit www.sonymobile.com for more information.

All illustrations are for illustration only and may not accurately depict the actual device.

This product is protected by certain intellectual property rights of Microsoft. Use or distribution of such technology outside of this product is prohibited without a license from Microsoft.

Product compliance: This product has been manufactured by or on behalf of Sony Mobile Communications, Mobilvägen, SE-221 88 Lund, Sweden.

Inquiries related to product compliance based on national legislation shall be addressed to Sony Mobile Quality Officer, Sony Mobile Communications AB, Mobilvägen, SE-221 88 Lund, Sweden. For any service or guarantee matters, please refer to the contact details provided in the separate service or guarantee documents.

Our support to you – Xperia™ Care



User guide



A User guide for your device is available at
www.sonymobile.com/support.



Support in your device

Get user support directly in your device using the Help application.

To access the Support application

- 1 From your Home screen, tap .
- 2 Find and tap .



Support on the web

Visit www.sonymobile.com/support to access a range of support and get the most from your device.



Customer support

Customer support – if all else fails. Access the relevant support number at www.sonymobile.com by clicking the Contact us link at the bottom of the page.

Learn more

Learn more about how we can support you with Xperia™ Care at www.sonymobile.com/support.