

SONY[®]

Startup guide

Xperia™ Tablet Z
SGP311/SGP312

Sony Mobile Communications AB
SE-221 88 Lund, Sweden
www.sonymobile.com

1270-4718.2

Welcome

Important Information

Before you use your device, please read the *Important Information* provided in your device or in the box.

Water and dust resistance

Your device has IP (Ingress Protection) ratings of IP5X, IPX5 and IPX7. This means that your device is dust protected and protected against the effects of immersion in water in depths of between 0 to 100 cm for up to 30 minutes, and is also protected against the effects of a low pressure water stream.

The covers for the micro USB port, the micro SD card and the headset connector must be firmly closed in order for the device to meet the stated IP rating.

More information about IP codes and important details about your device's resistance to water can be found in the User guide for your device and on the Sony Mobile support website.

www.sonymobile.com/support

Assembly

To insert the memory card

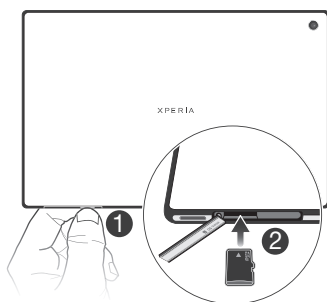

- 1 Insert a fingernail into the gap between the memory card cover and the bottom side of the device, then detach the memory card cover.
- 2 Place the memory card in the memory card slot, with the gold-coloured contacts facing down, then push the memory card all the way into the slot until you hear a locking sound.
- 3 Reattach the memory card cover.

! The memory card may not be included at purchase in all markets.

Device overview

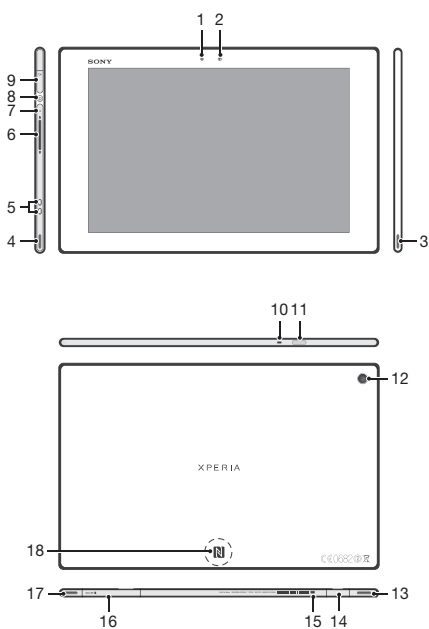

- | | |
|----------------------------|---|
| 1. Light sensor | 11. Infrared sensor |
| 2. Front camera | 12. Main camera |
| 3. Speaker A | 13. Speaker B (same as 4) |
| 4. Speaker B | 14. Port for charger/USB cable |
| 5. Charging dock connector | 15. Hole for attaching the charger port cover |
| 6. Volume key | 16. Memory card slot |
| 7. Notification light | 17. Speaker A (same as 3) |
| 8. Power key | 18. NFC™ detection area |
| 9. Headset jack | |
| 10. Microphone | |

! Use the accessories provided with your device, or other compatible accessories, for optimal performance.

Turning on the device

To turn on the device

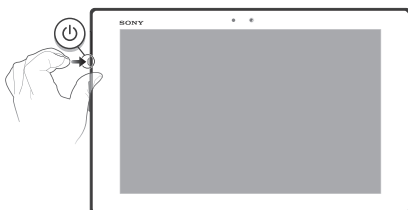

- ! Make sure that the battery is charged for at least 30 minutes before you turn on the device for the first time.



- 1 Press and hold down the power key  until the notification light flashes once.
- 2 Wait a while for the device to start.



Waking up the screen

To activate the screen

- Briefly press the power key .
 - If Tap to wake up mode is enabled, double-tap the screen.
- 💡 To enable Tap to wake up mode, go to the Home screen, then tap  > **Settings** > **Display** > **Tap to wake up**.

To unlock the screen



- Drag  up or drag  down.

Basic settings

The first time you start your device, a setup guide explains basic device functions and helps you enter essential settings. You can also access the setup guide later.







To access the setup guide manually

- 1 From the **Home** screen, tap .
- 2 Tap **Settings** > **Setup guide**.

Finding your way

Using the keys



-  **Back**
 - Go back to the previous screen.
 - Close the on-screen keypad, a dialog box, an options menu, or the Notification panel.
-  **Home**
 - Go to the **Home screen**.
-  **Task**
 - Tap to open a window showing your most recently used applications.
-  **Small apps launcher**
 - Tap to open a list of all small apps.
-  **Small app shortcut**
 - Tap to launch a pre-selected small app.
-  You can create a shortcut for any small app by touching and holding a small app icon in the small apps launcher.

Home screen

You can customise your **Home screen** with widgets, shortcuts, folders, themes, wallpaper and other items. You can also add more extensions to it.

You can view content in other extensions of the Home screen by flicking left or right.

-  The items in the bar at the top of the screen are always available for quick access.

To go to the Home screen

- Press .

To browse the Home screen

- Flick right or left.

To add a widget to the Home screen

- 1 Touch and hold an empty area on your **Home screen**, then tap **Widgets**.
- 2 Find and tap the widget that you want to add.

Application screen

The Application screen, which you open from your **Home screen**, contains the applications that come pre-installed on your device as well as the applications you download. The Application screen extends beyond the regular screen width, so you need to flick left and right to view all content.

To open the Application screen



- From your Home screen, tap .

Status and notifications

The status bar at the lower right corner of your screen shows what's going on in your device. For example, new message and calendar notifications appear here.



To open the Notification panel

- Tap the status bar.



Set up your device

Settings menu

View and change settings for your device from the Settings menu.

To access your device settings

- 1 From your **Home** screen, tap .
- 2 Find and tap **Settings**.

 You can also tap the status bar on the Home screen and then tap  >  to access your device settings.

Connecting to wireless networks

You can access the Internet wirelessly from your device using **Wi-Fi®** technology. This way you can browse the web and access cheaper call and data rates. You can also share media files over the same **Wi-Fi®** network with other DLNA Certified™ devices, for example, TVs, computers and tablets.





If your company or organisation has a virtual private network (VPN), you can connect to this network using your device. You can use a VPN to access intranets and other internal services at your company.

To turn on Wi-Fi®

- 1 From your **Home** screen, tap .
- 2 Find and tap **Settings**.
- 3 Drag the slider beside **Wi-Fi®** to the right to turn on the **Wi-Fi®** function.

 It may take a few seconds before **Wi-Fi®** is enabled.

To connect to a Wi-Fi® network

- 1 From the **Home** screen, tap .
- 2 Find and tap **Settings**.
- 3 Make sure that the **Wi-Fi®** function is on. Tap **Wi-Fi**.
- 4 Available **Wi-Fi®** networks are displayed. The available networks may be open or secured. Open networks are indicated by  and secured networks are indicated by  next to the **Wi-Fi®** network name.
- 5 Tap a **Wi-Fi®** network to connect to it. If you are trying to connect to a secure network, you are asked to enter a password.  is displayed in the status bar once you are connected.



 The **Wi-Fi®** network name may be indicated as SSID, ESSID or Access Point.

 To display the password as you input it, tap **Show password**.

Google™ account

With a Google™ account, you can use **Gmail™** to send emails, **Google Talk™** to chat with friends, and **Google Play™** to download applications and games, music, movies and books.

To set up a Google™ account on your device

- 1 From your **Home** screen, tap .
 - 2 Find and tap **Settings** > **Add account** > **Google**.
 - 3 Follow the registration wizard to create a Google™ account, or sign in if you already have an account.
-  You can also sign in to or create a Google™ account from the setup guide the first time you start your device. Or you can go online and create an account at www.google.com/accounts.

Downloading from Google Play™

You can download all kinds of applications from Google Play™, including free applications.

To open Google Play™

- 1 From the **Home** screen, tap .
- 2 Find and tap **Play Store** .



To download a free application

- 1 In Google Play™, find an item you wish to download by browsing categories, or by using the search function.
- 2 Tap the item to view its details, and follow the instructions to complete the installation.

Email

You can handle several email accounts at the same time using the Email application, including corporate Microsoft Exchange Active Sync accounts. Emails you receive to your Gmail™ account can be accessed on your device from both the Email and the Gmail™ applications.

To set up an email account on your device

- 1 From your **Home** screen, tap .
 - 2 Find and tap **Email**.
 - 3 Follow the instructions that appear on the screen to complete the setup.
-  For some email services, you may need to contact your email service provider for information on detailed settings for the email account.

Troubleshooting

My device is not responding

If your device hangs, or if you cannot restart it normally, you can force the device to restart.

To force the device to restart



- 1 Press and hold down both the volume up key and the power key  for five seconds.
- 2 After the notification light flashes once, release the keys. The device restarts automatically.

Legal information

To view the CE mark

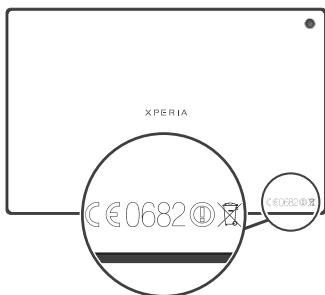

Sony SGP311/SGP312

Google Play™ is not available in all countries. Some of the services and features described in this User guide are not supported in all countries/regions or by all networks and/or service providers. Additional access or usage fees may apply.

This Startup guide is published by Sony Mobile Communications AB or its local affiliated company, without any warranty. Improvements and changes to this Startup guide necessitated by typographical errors, inaccuracies of current information, or improvements to programs and/or equipment, may be made by Sony Mobile Communications AB at any time and without notice. Such changes will, however, be incorporated into new editions of this Startup guide.

© 2013 Sony Mobile Communications AB. All rights reserved.

Publication number: 1270-4718.2

Your device has the capability to download, store and forward additional content, e.g. ringtones. The use of such content may be restricted or prohibited by rights of third parties, including but not limited to restriction under applicable copyright laws. You, and not Sony, are entirely responsible for additional content that you download to or forward from your device. Prior to your use of any additional content, please verify that your intended use is properly licensed or is otherwise authorized. Sony does not guarantee the accuracy, integrity or quality of any additional content or any other third party content. Under no circumstances will Sony be liable in any way for your improper use of additional content or other third party content.

This Startup guide may reference services or applications provided by third parties. Use of such programming or services may require separate registration with the third party provider and may be subject to additional terms of use. For applications accessed on or through a third-party website, please review such websites' terms of use and applicable privacy policy in advance. Sony does not warrant or guarantee the availability or performance of any third-party websites or offered services.

See regulatory information such as the CE mark on the back of the device.

All product and company names mentioned herein are the trademarks or registered trademarks of their respective owners. Any rights not expressly granted herein are reserved. All other trademarks are property of their respective owners.

Visit www.sonymobile.com for more information.

All illustrations are for illustration only and may not accurately depict the actual device.

This product is protected by certain intellectual property rights of Microsoft. Use or distribution of such technology outside of this product is prohibited without a license from Microsoft.

Product compliance: This product has been manufactured by or on behalf of Sony Mobile Communications, Mobilvägen, SE-221 88 Lund, Sweden. Inquiries related to product compliance based on national legislation shall be addressed to Sony Mobile Quality Officer, Sony Mobile Communications AB, Mobilvägen, SE-221 88 Lund, Sweden. For any service or guarantee matters, please refer to the contact details provided in the separate service or guarantee documents.

Our support to you – Xperia™ Care



User guide

A User guide is available at www.sonymobile.com.



Support in your device

Get user support directly in your device using the Support application.

To access the support application

- 1 From your Application screen, find and tap .
- 2 Find and tap the required support item.



Support on the web

Visit www.sonymobile.com to access a range of support and get the most from your device.



Customer support

Customer support – if all else fails. Access the relevant support number at www.sonymobile.com by clicking the **Contact us** link at the bottom of the page.

Learn more

Learn more about how we can support you with Xperia™ Care at www.sonymobile.com/support.

www.sonymobile.com

