

SONY

Television

Getting Started [1]

- [Using the Help Guide \[2\]](#)
- [Introducing Android TV \[3\]](#)
- [Downloading apps from the Google Play \[4\]](#)
- [Moving apps to a USB memory device \[5\]](#)
- [Viewing Internet media \[6\]](#)
- [Enjoying content from your mobile device on the TV with Google Cast \[7\]](#)
- [Enjoying safe apps and video streaming services \(Security & restrictions\) \[8\]](#)
- [Searching by using your voice \[9\]](#)
- [Basic Operations \[10\]](#)
- [Using the remote control \[11\]](#)
- [Home menu \[12\]](#)
- [Using the DISCOVER button \[13\]](#)
- [Using the Action Menu \[14\]](#)
- [Selecting devices that are connected to the TV \[15\]](#)
- [Identifying the status of the TV through illumination \[16\]](#)
- [Illumination LED \[17\]](#)
- [Illumination at the bottom of the screen \[18\]](#)
- [Support Site \[19\]](#)

Watching TV [20]

- [Watching TV programs \[21\]](#)
- [Using the program guide \[22\]](#)
- [Using interactive broadcast TV services \[23\]](#)
- [Watching in 3D \(3D models only\) \[24\]](#)
- [Understanding the basics of 3D TV \(3D models only\) \[25\]](#)
- [Preparing your 3D glasses \(3D models only\) \[26\]](#)
- [Watching TV in 3D \(3D models only\) \[27\]](#)
- [Enjoying social networking services while watching TV \[28\]](#)

Using the TV with Other Devices [29]

- [USB devices \[30\]](#)
- [Playing content stored on a USB device \[31\]](#)
- [Information about USB devices used for storing photos and music \[32\]](#)
- [Supported files and formats \[33\]](#)
- [Photos \[34\]](#)
- [Music \[35\]](#)
- [Videos \[36\]](#)
- [Audio sampling rates \(for videos\) \[37\]](#)
- [External subtitles \[38\]](#)
- [Blu-ray and DVD players \[39\]](#)
- [Connecting a Blu-ray or DVD player \[40\]](#)
- [Watching Blu-ray and DVD discs \[41\]](#)
- [Smartphones and tablets \[42\]](#)
- [Displaying the screen of a smartphone/tablet on the TV using the Screen mirroring function \[43\]](#)
- [Sharing photos/music/videos \[44\]](#)
- [Using the “Video & TV SideView” app with your smartphone/tablet \[45\]](#)
- [Computers, cameras, and camcorders \[46\]](#)
- [Connecting a computer and viewing stored content \[47\]](#)
- [Connecting a camera or camcorder and viewing stored content \[48\]](#)
- [Computer video signal specifications \[49\]](#)
- [Audio system \[50\]](#)
- [Connecting an audio system \[51\]](#)
- [Adjusting audio system-related settings \[52\]](#)
- [Bluetooth devices \[53\]](#)
- [Connecting a Bluetooth device \[54\]](#)
- [Supported Bluetooth profiles \[55\]](#)
- [Sony wireless subwoofer \(optional\) \(Sony wireless subwoofer supported models only\) \[56\]](#)
- [Connecting a wireless subwoofer \(optional\) \[57\]](#)
- [Adjusting wireless subwoofer-related settings \(optional\) \[58\]](#)
- [BRAVIA Sync-compatible devices \[59\]](#)
- [BRAVIA Sync overview \[60\]](#)
- [Using features available for BRAVIA Sync-compatible devices \[61\]](#)
- [Adjusting BRAVIA Sync settings \[62\]](#)

[Connecting an IR Blaster \(IR Blaster compatible models only\)](#) [63]

- [Viewing pictures in 4K from compatible devices](#) [64]
- [Viewing pictures in 4K resolution](#) [65]
- [Settings for viewing pictures in 4K resolution with higher quality](#) [66]

[Connecting to a Network](#) [67]

- [Connecting to a network using a LAN cable](#) [68]
- [Connecting to a network using a wireless connection](#) [69]
- [Using Wi-Fi to connect the TV to your network](#) [70]
- [Using Wi-Fi Direct to connect to the TV \(no wireless router required\)](#) [71]
- [Home network features](#) [72]
- [Adjusting home network settings](#) [73]
- [Playing content from a computer](#) [74]
- [Playing content from a media server](#) [75]
- [RVU statement \(RVU compliant models only\)](#) [76]

[Settings](#) [77]

- [Configuring the TV](#) [78]
- [\[TV\]](#) [79]
- [\[Network & Accessories\]](#) [80]
- [\[System Preferences\]](#) [81]
- [\[Personal\]](#) [82]
- [\[Expert panel settings\]\(only models equipped with an OLED panel\)](#) [83]
- [Setting a timer](#) [84]

[Troubleshooting](#) [85]

- [Start here](#) [86]
- [Self diagnostics](#) [87]
- [Software updates](#) [88]
- [If a full reset \(restart\) of the TV is required](#) [89]
- [Picture \(quality\)/screen](#) [90]
- [Picture quality is not as good as viewed at the store.](#) [91]
- [Distorted picture.](#) [92]
- [The screen flickers.](#) [93]
- [No color/Dark picture/Color is not correct/Picture is too bright.](#) [94]
- [Dark screen. How to brighten the screen.](#) [95]

- [Color is not correct. How to adjust the color tone.](#) [96]
- [Screen format/wide mode changes automatically.](#) [97]
- [Suddenly the picture becomes small.](#) [98]
- [Black bands appear at the edges of the screen.](#) [99]
- [A black box appears on the screen.](#) [100]
- [There are banners/tickers at the top or bottom of the screen.](#) [101]
- [3D pictures are not displayed. The 3D effect is weak. \(3D models only\)](#) [102]
- [Black bars appear on both sides of the screen when watching 3D pictures. \(3D models only\)](#) [103]
- [You cannot turn off 3D display while watching 3D content. \(3D models only\)](#) [104]
- [The message \[3D signal has been detected.\] automatically appears when 3D signal is detected. \(3D models only\)](#) [105]
- [A message about an app asking for permission to access a TV function is displayed.](#) [106]
- [The screen becomes darker after a certain period of time. \(only models equipped with an OLED panel\)](#) [107]
- [The message \[Panel refresh did not finish\] is displayed. \(only models equipped with an OLED panel\)](#) [108]
- [You are concerned about an image retention. \(only models equipped with an OLED panel\)](#) [109]
- [A white line appears on the screen. \(only models equipped with an OLED panel\)](#) [110]
- [Panel refresh does not complete. \(only models equipped with an OLED panel\)](#) [111]
- [Keyboard](#) [112]
- [Broadcast reception](#) [113]
- [Check these things first to troubleshoot your TV reception.](#) [114]
- [Block noise or an error message appears and you cannot watch broadcasts.](#) [115]
- [Ghosting or double images appear.](#) [116]
- [Only snow noise or a black picture appears on the screen.](#) [117]
- [There is picture or sound noise when viewing an analog TV channel.](#) [118]
- [Some channels are blank.](#) [119]
- [Poor reception or poor picture quality with digital broadcasts.](#) [120]
- [You cannot view digital channels.](#) [121]
- [You cannot receive or select channels.](#) [122]
- [Some digital cable channels are not displayed.](#) [123]
- [Broadcast HD formats have poor quality.](#) [124]
- [Sound](#) [125]
- [No sound but good picture.](#) [126]

- [Audio noise.](#) [127]
- [No audio or low audio with a home theater system.](#) [128]
- [Distorted sound.](#) [129]
- [Headphone volume cannot be adjusted.](#) [130]
- [Network \(Internet/home\)/apps](#) [131]
- [The network name \(SSID\) of the wireless router \(access point\) to which you want to connect is not displayed.](#) [132]
- [Sometimes video streaming quality is poor.](#) [133]
- [Wi-Fi connection is lost or intermittent.](#) [134]
- [Certain Internet video content displays a loss of detail.](#) [135]
- [Good picture quality but no sound on Internet video content.](#) [136]
- [Apps are inaccessible.](#) [137]
- [The TV cannot access the Internet when IPv6 is set.](#) [138]
- [Your TV cannot connect to the server.](#) [139]
- [A message appears stating that the TV cannot connect to your network.](#) [140]
- [You can connect to the Internet, but not to Google services.](#) [141]
- [You cannot add a Google account.](#) [142]
- [Remote control/accessories](#) [143]
- [The remote control does not operate.](#) [144]
- [You cannot turn the Active 3D Glasses on. \(3D models only\)](#) [145]
- [The LED indicator on the Active 3D Glasses blinks. \(3D models only\)](#) [146]
- [Power](#) [147]
- [The TV turns off automatically.](#) [148]
- [The TV turns on automatically.](#) [149]
- [After unplugging the TV and plugging it in again, the TV does not turn on even if you press the power button on the remote control or the TV.](#) [150]
- [Connected devices](#) [151]
- [No picture from a connected device.](#) [152]
- [You cannot select a connected device in the Home Menu.](#) [153]
- [Certain programs on digital sources display a loss of detail.](#) [154]
- [Photo images or folders take time to display.](#) [155]
- [You cannot find a connected BRAVIA Sync HDMI device.](#) [156]
- [You cannot control a second AV receiver.](#) [157]
- [An external device \(such as a set-top box or AV receiver\) cannot be controlled via the IR Blaster. \(IR Blaster compatible models only\)](#) [158]

- [Some media files in the USB device or server are not displayed.](#) [159]
- [The TV cannot be found by a Wi-Fi Direct device.](#) [160]
- [Operation cuts out, or a device does not work.](#) [161]
- [What kind of devices can be connected using the Screen mirroring function?](#) [162]
- [The TV cannot connect to a Miracast device or Screen mirroring compatible device.](#) [163]
- [Video or sound sometimes cuts out.](#) [164]
- [Some paid content cannot be played.](#) [165]
- [The TV cannot be turned on and controlled by using the “Video & TV SideView” app when \[Remote start\] is enabled.](#) [166]
- [The TV does not appear on or cannot be registered with the “Video & TV SideView” app.](#) [167]
- [Illumination LED](#) [168]
- [The illumination LED or bottom of the screen sometimes lights up.](#) [169]
- [You want to disable the illumination LED so that it does not light up or blink.](#) [170]

[Index](#) [171]

[1]

Getting Started

[Using the Help Guide](#)

[Introducing Android TV](#)

[Basic Operations](#)

[Support Site](#)

[2] Getting Started

Using the Help Guide

This Help Guide explains how to use this TV. Additionally, you can also refer to the Setup Guide for descriptions about TV installation, and the Reference Guide for parts descriptions and specifications of this TV.

In this Help Guide, you can read the desired information in order or search for it directly. To search,

Table Of Contents

Sony Television Help Guide.....	i
Getting Started.....	vi
Using the Help Guide.....	vi
Introducing Android TV.....	2
Downloading apps from the Google Play.....	2
Moving apps to a USB memory device.....	3
Viewing Internet media.....	4
Enjoying content from your mobile device on the TV with Google Cast.....	5
Enjoying safe apps and video streaming services (Security & Restrictions).....	6
Searching by using your voice.....	6
Basic Operations.....	6
Using the remote control.....	7
Home Menu.....	8
Using the Discover button.....	10
Using the Action Menu.....	11
Selecting devices that are connected to the TV.....	12
Identifying the status of the TV through illumination.....	12
Illumination LED.....	12
Illumination at the bottom of the screen.....	13
Support Site.....	14
Watching TV.....	14
Watching TV Programs.....	15
Using the program guide.....	15
Using interactive broadcast TV services.....	15
Watching in 3D (3D models only).....	16
Understanding the basics of 3D TV (3D models only).....	16
Preparing your 3D glasses (3D models only).....	18
Watching TV in 3D (3D models only).....	20
Enjoying social networking services while watching TV.....	21
Using the TV With Other Devices.....	22
USB Devices.....	22
Playing content stored on a USB device.....	23
Information about USB devices used for storing photos and music.....	24
Supported files and formats.....	24
Photos.....	25
Videos.....	26
Audio sampling rates (for videos).....	31
External subtitles.....	32

Blu-ray and DVD players.....	32
Connecting a Blu-ray or DVD player.....	33
Watching Blu-ray and DVD discs.....	35
Smartphones and tablets.....	36
Displaying the screen of a smartphone/tablet on theTV using the Screen mirroring function.....	36
Sharing photos/music/videos.....	37
Using the “Video & TV SideView” app with yoursmartphone/tablet	38
Computers, cameras, and camcorders.....	40
Connecting a computer and viewing stored content.....	40
Connecting a camera or camcorder and viewing.....	41
Computer video signal specifications.....	43
Audio system.....	43
Connecting an audio system.....	44
Adjusting audio system-related settings.....	46
Bluetooth devices.....	47
Connecting a Bluetooth device.....	47
Supported Bluetooth profiles.....	48
Sony wireless subwoofer (optional) (Sony wireless subwoofer supported models only).....	48
Connecting a wireless subwoofer (optional).....	48
Adjusting wireless subwoofer-related settings(optional).....	49
BRAVIA Sync-compatible devices.....	50
BRAVIA Sync overview.....	51
Using features available for BRAVIA Synccompatibledevices.....	51
Adjusting BRAVIA Sync settings.....	52
Connecting an IR Blaster (IR Blaster compatiblemodels only).....	54
Viewing pictures in 4K from compatible devices.....	55
Viewing pictures in 4K resolution.....	55
Settings for viewing pictures in 4K resolution withhigher quality.....	57
Connecting to a Network.....	57
Connecting to a network using a LAN cable.....	58
Connecting to a network using a wirelessconnection.....	59
Using Wi-Fi to connect the TV to your network.....	59
Using Wi-Fi Direct to connect to the TV (nowireless router required).....	60
Home network features.....	63
Adjusting home network settings.....	63
Playing content from a computer.....	64
Playing content from a media server.....	65
RVU statement (RVU compliant models only).....	65

Settings.....	66
Configuring the TV.....	66
[TV].....	66
[Network & Accessories].....	67
[System Preferences].....	68
[Personal].....	68
[Expert panel settings](only models equipped withan OLED panel).....	69
Setting a timer.....	70
Troubleshooting.....	70
Self diagnostics.....	71
Software updates.....	71
If a full reset (restart) of the TV is required.....	72
Picture (quality)/screen.....	72
Picture quality is not as good as viewed at thestore.....	73
Distorted picture.....	74
The screen flickers.....	74
No color/Dark picture/Color is not correct/Picture is too bright.....	74
Dark screen. How to brighten the screen.....	75
Color is not correct. How to adjust the color tone.....	75
Screen format/wide mode changes automatically.....	76
Black bands appear at the edges of the screen.....	76
A black box appears on the screen.....	77
There are banners/tickers at the top or bottom ofthe screen.....	77
3D pictures are not displayed. The 3D effect isweak. (3D models only).....	77
Black bars appear on both sides of the screenwhen watching 3D pictures. (3D models only).....	78
You cannot turn off 3D display while watching 3Dcontent. (3D models only).....	79
The message [3D signal has been detected.]automatically appears when 3D signal is detected.(3D models only).....	79
A message about an app asking for permission toaccess a TV function is displayed.....	79
The screen becomes darker after a certain periodof time. (only models equipped with an OLEDpanel).....	79
The message [Panel refresh did not finish] isdisplayed. (only models equipped with an OLEDpanel).....	80
You are concerned about an image retention. (onlymodels equipped with an OLED panel).....	80
A white line appears on the screen. (only modelsequipped with an OLED panel).....	81
Panel refresh does not complete. (only modelsequipped with an OLED panel).....	81
Keyboard.....	81

Broadcast reception.....	81
Check these things first to troubleshoot your TVreception.....	82
Block noise or an error message appears and youcannot watch broadcasts.....	82
Ghosting or double images appear.....	82
Only snow noise or a black picture appears on thescreen.....	83
There is picture or sound noise when viewing ananalog TV channel.....	83
Some channels are blank.....	84
Poor reception or poor picture quality with digitalbroadcasts.....	84
You cannot view digital channels.....	84
You cannot receive or select channels.....	85
Some digital cable channels are not displayed.....	85
Broadcast HD formats have poor quality.....	86
Sound.....	86
No sound but good picture.....	86
Audio noise.....	87
No audio or low audio with a home theater system.....	87
Distorted sound.....	88
Headphone volume cannot be adjusted.....	88
Network (Internet/home)/apps.....	88
The network name (SSID) of the wireless router(access point) to which you want to connect is notdisplayed.....	89
Sometimes video streaming quality is poor.....	89
Wi-Fi connection is lost or intermittent.....	89
Certain Internet video content displays a loss ofdetail.....	90
Good picture quality but no sound on Internet videocontent.....	90
Apps are inaccessible.....	91
The TV cannot access the Internet when IPv6 isset.....	91
Your TV cannot connect to the server.....	91
A message appears stating that the TV cannotconnect to your network.....	92
You can connect to the Internet, but not to Googleservices.....	92
You cannot add a Google account.....	92
Remote control/accessories.....	93
The remote control does not operate.....	93
You cannot turn the Active 3D Glasses on. (3Dmodels only).....	94
The LED indicator on the Active 3D Glasses blinks.(3D models only).....	95
Power.....	95
The TV turns off automatically.....	96
The TV turns on automatically.....	96
After unplugging the TV and plugging it in again,the TV does not turn on even if you press thepower button on the remote control or the TV.....	96

Connected devices.....	97
No picture from a connected device.....	97
You cannot select a connected device in the HomeMenu.....	98
Certain programs on digital sources display a loss of detail.....	98
Photo images or folders take time to display.....	98
You cannot find a connected BRAVIA Sync HDMI device.....	99
You cannot control a second AV receiver.....	99
An external device (such as a set-top box or AV receiver) cannot be controlled via the IR Blaster.(IR Blaster compatible models only).....	99
Some media files in the USB device or server are not displayed.....	100
The TV cannot be found by a Wi-Fi Direct device.....	100
Operation cuts out, or a device does not work.....	100
What kind of devices can be connected using the Screen mirroring function?.....	101
The TV cannot connect to a Miracast device or Screen mirroring compatible device.....	101
Video or sound sometimes cuts out.....	102
Some paid content cannot be played.....	102
The TV cannot be turned on and controlled by using the "Video & TV SideView app when remote start is enabled.....	102
The TV does not appear on or cannot be registered with the "Video & TV SideView" app.	103
Illumination LED.....	104
The illumination LED or bottom of the screen sometimes lights up.....	104
You want to disable the illumination LED so that it does not light up or blink.....	104
Index.....	105

select  at the top of the screen.

Help Guide versions

There are two versions of the Help Guide for your TV: the Built-in Help Guide and the Online Help Guide. To view the Online Help Guide, your TV must be connected to the Internet. To switch between the Built-in and Online versions, use the switch button (A) at the top of the screen. You can check which Help Guide is currently displayed by looking at the title at the top of the screen.



- 1 Connect the TV to the Internet.
- 2 Select (A) to switch the Help Guide version.

Note

- To use the latest features described in the Help Guide, you may need to update the TV's software. For details about software updates, see the [Software updates](#) page.
- The images and illustrations used in the Help Guide may differ depending on your TV model.
- Design and specifications are subject to change without notice.

Hint

- You can also use the “Video & TV SideView” app to view the Online Help Guide.
- To see if your TV is equipped with one of the functions described in the Help Guide, refer to the paper manual or a Sony product catalog.
- This Help Guide is written for all regions/countries. Some descriptions contained in this Help Guide do not apply to some regions and countries.

Related topics

- [Connecting to a network using a LAN cable](#)
- [Using Wi-Fi to connect the TV to your network](#)
- [Using the “Video & TV SideView” app with your smartphone/tablet](#)

Introducing Android TV

[Downloading apps from the Google Play](#)

[Moving apps to a USB memory device](#)

[Viewing Internet media](#)

[Enjoying content from your mobile device on the TV with Google Cast](#)

[Enjoying safe apps and video streaming services \(Security & restrictions\)](#)

[Searching by using your voice](#)

Downloading apps from the Google Play

You can download apps from the Google Play to the TV, just like you do with smartphones and tablets.

Note

- You can only download apps that are compatible with TVs. They may differ from apps for smartphones/tablets.
- An Internet connection and Google account are required to download apps from the Google Play.

Hint

- If you do not have a Google account or want to create a shared account, create a new account by accessing the following website.
<https://accounts.google.com/signup>
The website above may vary depending on your region/country. It is also subject to change without notice. For details, refer to the Google homepage.
- We recommend that you create a Google account on a computer or mobile device.

- 1** Press the HOME button, then select [Google Play Store] under [Apps].
- 2** To install an app, select an app you want to download. The app will start downloading.

After downloading, the app is automatically installed and added. Its icon appears in the Home Menu, allowing you to launch it.

About paid apps

There are free apps and paid apps in the Google Play. To purchase a paid app, a prepaid Google Play gift card code or credit card information is required. You can purchase a Google Play gift card from various retailers.

To delete an app

- 1 Press the HOME button, select [Google Play Store] under [Apps], and then select [My Apps].
- 2 Select an app to be deleted, and then uninstall the app.

Related topics

- [Connecting to a network using a LAN cable](#)
- [Using Wi-Fi to connect the TV to your network](#)
- [Moving apps to a USB memory device](#)

[5] Getting Started | Introducing Android TV

Moving apps to a USB memory device

You can move downloaded apps to a USB memory device to increase the space available in the TV.

Note

- When you format a USB memory device, all data saved in the USB memory device will be deleted. Back up your important data before formatting.
- Performing this procedure formats the USB memory device for exclusive use with the TV. Therefore, you may be unable to use the USB memory device with a computer, etc.
- Some apps cannot be moved to a USB memory device.

- 1 Connect a USB memory device to the TV.
- 2 Press the HOME button, select [Settings] — [Storage & reset] — the desired USB memory device.



- 3 Format it as an internal storage device.
- 4 When formatting is finished, press the HOME button, then select [Settings] — [Apps].
- 5 Select the app that you want to move to the USB memory device.
- 6 Select the USB memory device from the used storage. The app is moved to the USB memory device.

Hint

- Repeat steps 4 to 6 to move additional apps to the USB memory device.

To remove a USB memory device

- 1 Press the HOME button, select [Settings] — [Storage & reset] — the desired USB memory device, and then select the option to remove it.

Note

- The USB memory device is used only for saving apps. To use the USB memory device for other purposes, you must format it again.
- If you delete an app in the USB memory device using a computer, you will be unable to launch it from the TV.
- If you remove a USB memory device from the TV, you will be unable to use the apps that were moved to the USB memory device.
- You cannot specify a USB memory device as the installation location of an app. First install the app on the TV as normal, and then move it to the USB memory device.

[6] Getting Started | Introducing Android TV

Viewing Internet media

You can use video streaming services such as YouTube and Netflix to watch Internet content. The available services vary depending on your country and region. You can launch these services by selecting their tiles in the Home Menu.

Note

- An Internet connection is required to watch Internet content.

Related topics

- [Enjoying safe apps and video streaming services \(Security & restrictions\)](#)
- [Connecting to a network using a LAN cable](#)
- [Using Wi-Fi to connect the TV to your network](#)

[7] Getting Started | Introducing Android TV

Enjoying content from your mobile device on the TV with Google Cast

Google Cast allows you to wirelessly cast content from your favorite websites and apps to your TV, directly from your computer or mobile device.

- 1** Connect a mobile device such as a smartphone or tablet to the same home network that the TV is connected to.
- 2** Launch a Google Cast supported app on the mobile device.
- 3** Select the  (cast) icon in the app.
The screen of the mobile device is displayed on the TV.

Note

- An Internet connection is required to use Google Cast.

Related topics

- [Connecting to a network using a LAN cable](#)
- [Using Wi-Fi to connect the TV to your network](#)

[8] Getting Started | Introducing Android TV

Enjoying safe apps and video streaming services

(Security & restrictions)

You can ensure safe use of the TV by setting installation restrictions on apps that are downloaded from unknown sources, or age restrictions on programs and videos.

- 1 Press the HOME button, then select [Settings] — then options such as [Security & restrictions] or [Parental lock (Broadcast)].

Note

- If you change the [Security & restrictions] settings, your device and personal data are more vulnerable to attack by unknown apps from sources other than Play Store. You agree that you are solely responsible for any damage to your device or loss of data that may result from using these apps.

Hint

- Other separate restrictions may be available depending on the app. For details, refer to the app's help guide.

[9] Getting Started | Introducing Android TV

Searching by using your voice

The TV includes a Voice search feature that enables you to search the Internet for content you're looking for with your voice. Voice search allows you to quickly input search queries without the use of the on-screen keyboard.

To search, simply press the  button and speak into the microphone built into your remote control.

For details, please refer to [Using the remote control](#).

[10] Getting Started

Basic Operations

[Using the remote control](#)

[Home menu](#)

[Using the DISCOVER button](#)





[Using the Action Menu](#)

[Selecting devices that are connected to the TV](#)

[Identifying the status of the TV through illumination](#)

[11] Getting Started | Basic Operations

Using the remote control

You can operate many of the TV's features by using the  /  /  /  and  buttons.

For descriptions of the remote control buttons, refer to the Reference Guide.

- 1 Use the , ,  and  buttons to "focus" on the desired item.

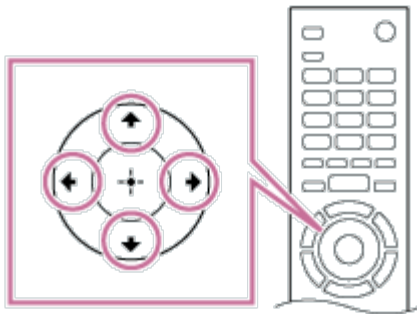

- 2 Press the center of the  button to select the item currently in focus.

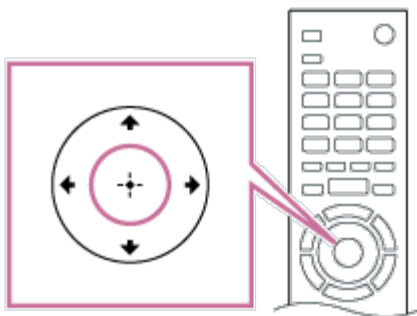

To return to the previous screen

Press the BACK button.



Using Voice search (Voice search supported models only)

For Voice search supported models, the remote control has a built-in microphone. By speaking into the microphone, you can search for content on the Internet.



- 1 Press the  button. You will then be taken directly to the Voice search screen.
- 2 The LED on the remote control will light up indicating that the Voice search function has been activated; then speak into the built-in microphone.

When your voice is not being recognized

When your voice is not being recognized, make sure to activate the  button on the remote control with the , or register the remote control with the  button to your TV.

To confirm these settings, press the HOME button, then select [Settings] — [Voice Remote Control].

Note

- An Internet connection is required to use Voice search.
- The type of remote control supplied with the TV, and the availability of a remote control with a built-in microphone varies depending on your model/region/country. An optional remote control is available in some models/regions/countries.

Related topics

- [The remote control does not operate.](#)
- [Connecting to a Network](#)

[12] Getting Started | Basic Operations

Home menu

The Home Menu allows you to search for content, provides content recommendations, and provides access to apps and settings. Available items vary depending on your region/country and the current screen.



Searching

You can search for various content by entering a search keyword using the on-screen keyboard or by voice. The availability of the remote control with a built-in microphone depends on your model/region/country.

- 1 Press the HOME button.
- 2 Select the microphone icon at the top of the screen.
- 3 Enter a search keyword by speaking into the microphone on the remote control, or by pressing the  button and then using the on-screen keyboard.

Browsing for content, apps, or other items

- 1 Press the HOME button.
- 2 Select the desired item from the desired category.

Category list

Recommendations

This category shows content based on your history.

[Featured apps], [Apps] and [Games]

These categories provide access to apps (such as Video, Album, Music, Photo Sharing Plus, and Screen mirroring) and games.

[Inputs]

You can select the input source from the list of connected devices and jacks (sockets), such as HDMI.

[Settings]

This category includes [Settings], [Network Settings], [Timers], and [Help].

Hint

- By connecting the TV to the Internet, you can access various network services and features.

Related topics

- [Connecting to a network using a LAN cable](#)
- [Using Wi-Fi to connect the TV to your network](#)

Using the DISCOVER button

You can use the DISCOVER button to search for content (such as TV programs and Internet content). The content that displays when pressing the DISCOVER button varies depending on your model/region/country.



- 1 Press the DISCOVER button.
- 2 Move the focus up or down to select the desired category.
- 3 Move the focus left or right to select the desired item.
- 4 Press the  button to launch the selected item.

To change the settings of this function

- 1 Press the DISCOVER button.
- 2 Move the focus down to the [Settings] category.
- 3 Select the desired item to change the settings.

Available options

[Show/Hide categories]

Select content categories to be shown in DISCOVER. You cannot hide [Settings].

You can hide [Top Picks] depending on your TV model.

[Reorder categories]

Select a content category to reorder.

[Add channels to Favorites]

Add your favorite channels to DISCOVER.

[Add keyword categories]

Add keywords to create your own custom content category.

[Display size]

Select the display size of the menu.

[Sort TV channels]

Select the type of TV program sorting.

Note

- Some options may not be available depending on your model/region/country.

[14] Getting Started | Basic Operations

Using the Action Menu

By pressing the ACTION MENU button, a menu appears and provides quick access to the functions that are available for the currently displayed screen, such as picture adjustments, sound adjustments, volume adjustment for a connected device (such as headphones), and display/audio settings. The items in the menu differ depending on the selected screen.



- 1 Press the ACTION MENU button.
- 2 Move the focus left or right to select the desired category.
- 3 Move the focus up or down to select the desired item.
- 4 Press the  button to launch the selected item.

Selecting devices that are connected to the TV

To use devices that are connected to the TV such as a Blu-ray/DVD player, or to watch TV programs after using such devices, you must switch the input.

- 1 Press the INPUT button repeatedly to select the connected device.

Hint

- You can switch to TV broadcasting by simply pressing the TV button on the remote control.

Switching from the Home Menu

- 1 Press the HOME button, then select the input source from [Inputs].



Identifying the status of the TV through illumination

Illumination LED

Illumination at the bottom of the screen

Illumination LED

You can identify the status of the TV by looking at how the illumination LED lights up.

 White "on" or "blinking"	<ul style="list-style-type: none">• When the screen is off• When the TV is turning on• When receiving signals from the remote control• When updating the software etc.
	<ul style="list-style-type: none">• When a mobile device (smartphone, tablet, etc.) is connecting to the TV on the



Cyan “blinking”	<p>home network</p> <ul style="list-style-type: none"> • When “Video & TV SideView” is launched on the home network etc.
 Amber “on”	<ul style="list-style-type: none"> • When the on timer is set • When the sleep timer is set

Related topics
<ul style="list-style-type: none"> • Home network features • Using the “Video & TV SideView” app with your smartphone/tablet • Software updates • Setting a timer

[18] Getting Started | Basic Operations | Identifying the status of the TV through illumination

Illumination at the bottom of the screen

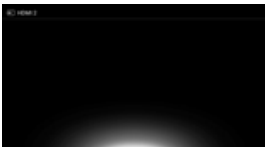
You can identify the status of the TV by looking at how the bottom of the screen lights up.

 Lights up in white	<ul style="list-style-type: none"> • When picture off mode is set
 Lights up in cyan	<ul style="list-style-type: none"> • When a mobile device (smartphone, tablet, etc.) is connecting to the TV on the home network • When “Video & TV SideView” is launched on the home network etc.
 Lights up in amber	<ul style="list-style-type: none"> • When a timer is set

Related topics
<ul style="list-style-type: none"> • Home network features • Using the “Video & TV SideView” app with your smartphone/tablet • Setting a timer

[19] Getting Started

Support Site

For the latest information and Online Help Guide, please visit the Sony support website:

- USA:

<http://www.sony.com/tvsupport>



- Canada:

<http://www.sony.ca/support>



- Brazil:

<http://esupport.sony.com/BR/>



- Latin America:

<http://esupport.sony.com/ES/LA/>



[20]

Watching TV

[Watching TV programs](#)

[Watching in 3D \(3D models only\)](#)

[Enjoying social networking services while watching TV](#)

[21] Watching TV

Watching TV programs

[Using the program guide](#)

[Using interactive broadcast TV services](#)

[22] Watching TV | Watching TV programs

Using the program guide

You can quickly find your preferred programs.

(This function is available only for digital broadcasts and depends on your region/country/settings.)

- 1 Press the **GUIDE** button to display the digital program guide.**
- 2 Select a program to watch.**
The details of the program are displayed.
- 3 Select **[View]** to watch the program.**

To use optional functions

- 1 While the program guide is displayed, press the **ACTION MENU** button and then select the desired item.**

[23] Watching TV | Watching TV programs

Using interactive broadcast TV services

To use Ginga service (Ginga models only)

Ginga models have [Channel setup & Ginga] in [Settings] — [Channels].

Ginga (also known as DTVi) Interactivity provides extended programming content information such as sports statistics, soap opera chapters and characters, publicity, merchandising, weather information

and news, through high-quality digital text and graphics, along with advanced options.

If available in your home, Ginga Interactivity also allows you to communicate with the broadcaster through the return channel, in scenarios such as polls, quizzes and games. These services are provided by broadcasters.

(This function is only available for digital broadcasts and may not be available in your region/country.)

1 Select a digital channel that provides Ginga features.



Java is a trademark of Oracle and/or its affiliates.

Note

- Java technology is supported by Ginga models only.

[24] Watching TV

Watching in 3D (3D models only)

[Understanding the basics of 3D TV \(3D models only\)](#)

[Preparing your 3D glasses \(3D models only\)](#)

[Watching TV in 3D \(3D models only\)](#)

[25] Watching TV | Watching in 3D (3D models only)

Understanding the basics of 3D TV (3D models only)

3D models have [3D settings] in [Settings] — [Picture & Display].

Recommended viewing distance for a 3D image

If the viewing distance is not appropriate, a double image may appear. Sit at a distance of at least 3 times the height of the screen away from the TV. For the best viewing experience, we recommend that you sit directly in front of the TV.

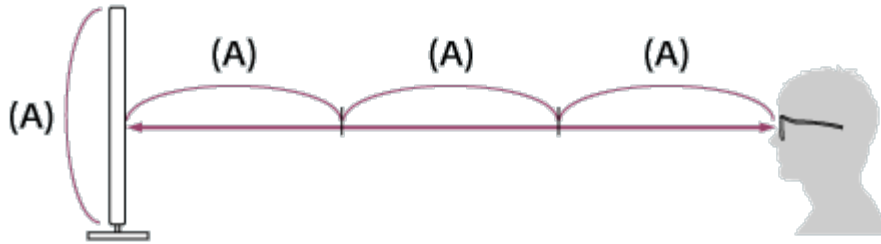

Hint

- There are two types of 3D Glasses: Passive and Active. Refer to the specifications in the Reference Guide to see which type of 3D Glasses the TV supports.

TV and Active 3D Glasses communication range

Active 3D glasses communicate with the TV to show you images in 3D.

Your viewing position needs to be within the proper range. See the following diagrams. The working distance depends on obstacles (people, metal, walls, etc.) and/or electromagnetic interference.

- Overhead view

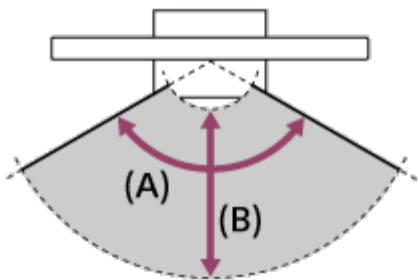

(A) 120°

(B) 1-6 m (3-20 ft.)

- Side view

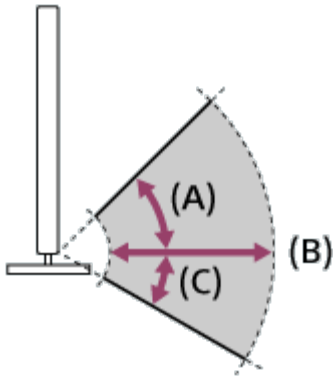

(A) 45°

(B) 1-6 m (3-20 ft.)

(C) 30°

Note

- Recommended viewing angle and distance may vary depending on the TV's location and room conditions.

Caring for your glasses

- Wipe the glasses gently with a soft cloth.
- Stubborn stains may be removed with a cloth slightly moistened with a solution of mild soap and warm water.
- If using a chemically pretreated cloth, be sure to follow the instructions provided on the package.
- Never use strong solvents such as a thinner, alcohol, or benzene for cleaning.

Related topics

- [Preparing your 3D glasses \(3D models only\)](#)
- [Watching TV in 3D \(3D models only\)](#)

[26] Watching TV | Watching in 3D (3D models only)

Preparing your 3D glasses (3D models only)

3D models have [3D settings] in [Settings] — [Picture & Display].

There are two types of 3D Glasses: Passive and Active. Refer to the specifications in the Reference Guide to see which type of 3D Glasses the TV supports.

For Passive 3D Glasses

If Passive 3D Glasses are supplied with your TV, use them. If no glasses are supplied, purchase a pair of Passive 3D Glasses, model TDG-500P. You can watch in 3D by just putting the Passive 3D Glasses on.

For Active 3D Glasses

If Active 3D Glasses are supplied with your TV, use them. If no glasses are supplied, purchase a pair of Active 3D Glasses, model TDG-BT500A. Before using the Active 3D Glasses for the first time, you need to register them to your TV. Follow the steps below.

- 1 Remove the battery's insulation sheet.

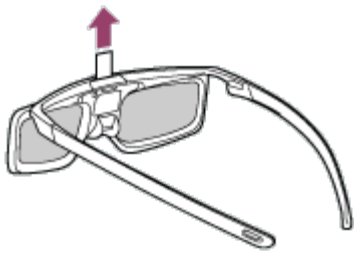

- 2 Turn the TV on, then hold the glasses within 50 cm (1.6 ft.) of the TV.

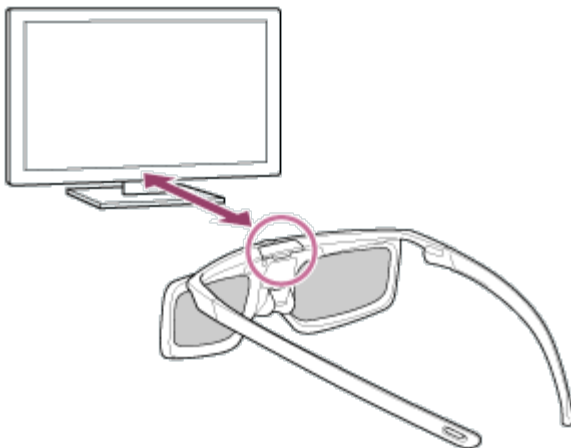

- 3 Press and hold the  (Power) button/indicator on the glasses for 2 seconds.



The Active 3D Glasses turn on and registration starts (the  (Power) button/indicator blinks green and yellow). When registration is finished, a message appears in the TV screen for 5 seconds, and the indicator lights up in green for 3 seconds.

If registration fails, the Active 3D Glasses will turn off automatically. In this case, repeat the procedure above.

- 4 Put the Active 3D Glasses on.

From the next time, you can use the Active 3D Glasses by just turning them on. To turn them off, press and hold the  (Power) button/indicator on the glasses for 2 seconds. To turn them on again, press the  (Power) button/indicator.

Hint

- To use the Active 3D Glasses with another TV, you need to register the glasses to that TV. Perform the procedure above from Step 2.

Related topics

- [Understanding the basics of 3D TV \(3D models only\)](#)
- [Watching TV in 3D \(3D models only\)](#)
- [Remote control/accessories](#)

[27] Watching TV | Watching in 3D (3D models only)

Watching TV in 3D (3D models only)

3D models have [3D settings] in [Settings] — [Picture & Display].

You can experience powerful 3D entertainment, such as stereoscopic 3D games and 3D Blu-ray Discs.

To watch in 3D, connect a 3D-compatible device directly to the TV via an authorized HIGH SPEED HDMI cable bearing the HDMI logo.



- 1** Prepare the 3D Glasses.
- 2** Display the 3D content on the TV screen.
- 3** Put the 3D Glasses on.

You should now be able to watch 3D images. If no 3D effect is achieved, perform the following steps.

4 Press the **ACTION MENU** button, then select **[3D]**.

5 Select the **[3D display]** mode to suit the displayed content. Depending on the input signal or format, **[3D (Side by Side)]/[3D (Over-Under)]** may not be selectable.

Hint

- In addition to the **[3D display]** mode, you can use various 3D options in **[3D settings]**. Press the HOME button, then select **[Settings] — [Picture & Display] — [3D settings]**.

Note

- The 3D effect may be less pronounced if the ambient temperature is low.
- If **[Motionflow]** in **[Picture adjustments]** is set to something other than **[Off]**, the process to minimize screen flicker may affect the smooth movement of the picture. In this case, press the **ACTION MENU** button, then select **[Picture adjustments] — [Advanced settings] — [Motionflow] — [Off]**. (For **[Motionflow]** compatible models only.)
[Motionflow] compatible models have **[Motionflow]** in **[Settings] — [Picture & Display] — [Picture adjustments] — [Advanced settings] — [Motion]**.

Related topics

- [Preparing your 3D glasses \(3D models only\)](#)
- [Remote control/accessories](#)

[28] Watching TV

Enjoying social networking services while watching TV

You can view tweets that mention the programs you are watching.

1 Connect to a broadband Internet connection.

2 While watching a programs, press the **ACTION MENU** button, then select a tweet.
The **Social Viewing** screen appears.

To change the scroll direction between horizontal and vertical

- 1 While displaying the Social Viewing screen, press the ACTION MENU button, select [Preferences] — [Change view], then select the desired setting.

Related topics

- [Connecting to a network using a LAN cable](#)
- [Using Wi-Fi to connect the TV to your network](#)

[29]

Using the TV with Other Devices

[USB devices](#)

[Blu-ray and DVD players](#)

[Smartphones and tablets](#)

[Computers, cameras, and camcorders](#)

[Audio system](#)

[Bluetooth devices](#)

[Sony wireless subwoofer \(optional\) \(Sony wireless subwoofer supported models only\)](#)

[BRAVIA Sync-compatible devices](#)

[Connecting an IR Blaster \(IR Blaster compatible models only\)](#)

[Viewing pictures in 4K from compatible devices](#)

[30] Using the TV with Other Devices

USB devices

[Playing content stored on a USB device](#)

[Information about USB devices used for storing photos and music](#)

[Supported files and formats](#)

[31] Using the TV with Other Devices | USB devices

Playing content stored on a USB device

Connecting a USB device

Connect a USB storage device to the USB port of the TV to enjoy photo, music, and video files stored on the device.

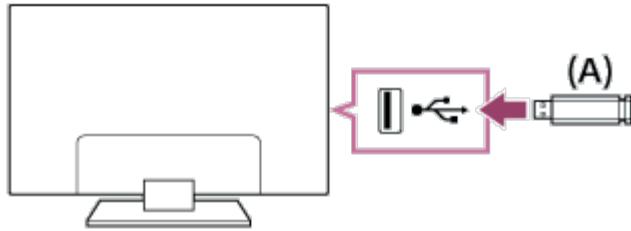

(A) USB storage device

Enjoy photos/music/movies stored on a USB device

You can enjoy photos/music/movies stored on a USB device on the TV screen.

- 1** If the USB device connected to the TV has a power switch, turn it on.
- 2** Press the HOME button, then select the desired item.
Select [Album] to view photos, [Music] to play music, and [Video] to play movies.
- 3** Press the  button and select [Folders] from the menu that is displayed.
- 4** Browse the list of folders and files and select the desired file.
Playback starts.

To check the supported file formats

- [Supported files and formats](#)

Note

- All USB ports on the TV support Hi-Speed USB. The blue USB port supports SuperSpeed (USB 3.0). USB hubs are not supported.
- While accessing the USB device, do not turn off the TV or USB device, do not disconnect the USB cable, and do not remove or insert recording media. Otherwise, data stored on the USB device may be corrupted.
- Depending on the file, playback may not be possible, even when using the supported formats.

Related topics

- [Information about USB devices used for storing photos and music](#)

[32] Using the TV with Other Devices | USB devices

Information about USB devices used for storing photos and music

- The USB ports on the TV support FAT16, FAT32, exFAT, and NTFS file systems.
- When connecting a Sony digital still camera to the TV with a USB cable, USB connection settings on your camera need to be set to “Auto” or “Mass Storage” mode.
- If your digital still camera does not work with your TV, try the following:
 - Set the USB connection settings on your camera to “Mass Storage”.
 - Copy the files from the camera to a USB flash drive, then connect the drive to the TV.
- Some photos and movies may be magnified, resulting in low picture quality. Depending on the size and aspect ratio, images may not be displayed in full screen.
- It may take a long time to display a photo, depending on the file or settings.
- In no event shall Sony be liable for recording failure or any damage or loss of recorded contents caused or associated with the TV’s malfunction, the USB device’s malfunction, or any other problem.

Related topics

- [Supported files and formats](#)

[33] Using the TV with Other Devices | USB devices

Supported files and formats

[Photos](#)

[Music](#)

[Videos](#)

[Audio sampling rates \(for videos\)](#)

[External subtitles](#)

Photos

Use case : USB / Home Network

File Format	Extension
JPEG	*.jpg / *.jpe / *.jpeg

Other supported files and formats

- [Music](#)
- [Videos](#)
- [Audio sampling rates \(for videos\)](#)
- [External subtitles](#)

Music

Use case : USB / Home Network

mp4

Extension	Description	Sampling Rate
*.mp4 / *.m4a	AAC-LC	16k / 22.05k / 24k / 32k / 44.1k / 48k
	HE-AAC v1 / v2	24k / 32k / 44.1k / 48k

3gpp

Extension	Description	Sampling Rate
*.3gp / *.3g2	AAC-LC	16k / 22.05k / 24k / 32k / 44.1k / 48k
	HE-AAC v1 / v2	24k / 32k / 44.1k / 48k

Asf

Extension	Description	Sampling Rate
*.wma	WMA9 Standard	8k / 11.025k / 16k / 22.05k / 32k / 44.1k / 48k

Other

Extension	Description	Sampling Rate
-	LPCM * ¹	32k / 44.1k / 48k
*.mp3	MP1L1 / MP1L2 / MP1L3 / MP2L1 / MP2L2	
	MP2L3	16k / 22.05k / 24k
	MP2.5L3	8k / 11.025k / 12k
*.wav	WAV * ²	32k / 44.1k / 48k / 88.2k / 96k / 176.4k / 192k
*.flac	FLAC	16k / 22.05k / 32k / 44.1k / 48k / 88.2k / 96k / 176.4k / 192k

*¹ The use case of LPCM is Home Network only.

*² The use case of WAV is 2ch only.

Other supported files and formats

- [Photos](#)
- [Videos](#)
- [Audio sampling rates \(for videos\)](#)
- [External subtitles](#)

[36] Using the TV with Other Devices | USB devices | Supported files and formats

Videos

Use case : USB / Home Network

MPEG1 (*.mpg / *.mpe / *.mpeg)

Subtitle Type : External

- **Video Codec (Profile@Level):** MPEG1

- **Audio Codec:** MPEG1L2
- **Max. / Min. Resolution:** 1920x1080 / QCIF (176x144)
- **Max. Frame Rate:** 1920x1080@30fps / 1280x720@60fps

MPEG2PS (*.mpg / *.mpe / *.mpeg)

Subtitle Type : External

- **Video Codec (Profile@Level):** MPEG2 MP@HL, MP@H14L, MP@ML
- **Audio Codec:** MPEG1L1 / MPEG1L2 / LPCM / AC3
- **Max. / Min. Resolution:** 1920x1080 / QCIF (176x144)
- **Max. Frame Rate:** 1920x1080@30fps / 1280x720@60fps

MPEG2TS

Extension : *.m2t

Subtitle Type : Internal (Except for Brazilian models) / - (For Brazilian models only)

- **Video Codec (Profile@Level):** MPEG2 MP@HL, MP@H14L, MP@ML
- **Audio Codec:** MPEG1L1 / MPEG1L2 / AAC-LC / HE-AAC v1 / HE-AAC v2 / AC3 / E-AC3
- **Max. / Min. Resolution:** 1920x1080 / QCIF (176x144)
- **Max. Frame Rate:** 1920x1080@30fps / 1280x720@60fps

Extension : *.m2ts / *.mts

Subtitle Type : -

- **Video Codec (Profile@Level):** AVC / H.264 BP@L3, MP@L4.2, HP@L4.2
- **Audio Codec:** MPEG1L1 / MPEG1L2 / AAC-LC / HE-AAC v1 / HE-AAC v2 / AC3 / E-AC3
- **Max. / Min. Resolution:** 1920x1080 / QCIF (176x144)
- **Max. Frame Rate:** 1920x1080@60fps

MP4 (*.mp4)

Subtitle Type : External

- **Video Codec (Profile@Level):** AVC / H.264 BP@L3, MP@L4.2, HP@L4.2
- **Audio Codec:** AAC-LC / HE-AAC v1 / HE-AAC v2 / AC3 / E-AC3 / MPEG1L1 / MPEG1L2
- **Max. / Min. Resolution:** 1920x1080 / QCIF (176x144)

Max. Frame Rate: 1920x1080@120fps

- **Video Codec (Profile@Level):** MPEG4 SP@L6, ASP@L5, ACEP@L4
- **Audio Codec:** AAC-LC / HE-AAC v1 / HE-AAC v2 / AC3 / E-AC3 / MPEG1L1 / MPEG1L2
- **Max. / Min. Resolution:** 1920x1080 / QCIF (176x144)
- **Max. Frame Rate:** 1920x1080@30fps / 1280x720@60fps

- **Video Codec (Profile@Level):** AVC / H.264 BP@L5.2, MP@L5.2, HP@L5.2 ^{*1}
- **Audio Codec:** AAC-LC / HE-AAC v1 / HE-AAC v2 / AC3 / E-AC3 / LPCM
- **Max. / Min. Resolution:** 3840x2160 / QCIF (176x144)
- **Max. Frame Rate:** 3840x2160@60p / 1920x1080@120fps

- **Video Codec (Profile@Level):** HEVC / H.265 MP@L5.1, Main10@L5.1
- **Audio Codec:** AAC-LC / HE-AAC v1 / HE-AAC v2 / AC3 / E-AC3
- **Max. / Min. Resolution:** 3840x2160 / QCIF (176x144)
- **Max. Frame Rate:** 3840x2160@60p

^{*1} This line includes the XAVC S format use case. The maximum supported bitrate for XAVC S is 100 Mbps.

avi (*.avi)

Subtitle Type : External

- **Video Codec (Profile@Level):** Xvid
- **Audio Codec:** MPEG1L1 / MPEG1L2 / MPEG1L3 / AC3 / E-AC3
- **Max. / Min. Resolution:** 1920x1080 / QCIF (176x144)
- **Max. Frame Rate:** 1920x1080@30fps / 1280x720@60fps

- **Video Codec (Profile@Level):** Motion JPEG
- **Audio Codec:** μ -LAW / PCM (U8) / PCM (S16LE)
- **Max. / Min. Resolution:** 1280x720 / QCIF (176x144)
- **Max. Frame Rate:** 1280x720@30fps

Asf (*.asf / *.wmv)

Subtitle Type : External

- **Video Codec (Profile@Level):** VC1 AP@L3, MP@HL, SP@ML
- **Audio Codec:** WMA9 Standard

- **Max. / Min. Resolution:** 1920x1080 / QCIF (176x144)
- **Max. Frame Rate:** 1920x1080@30fps / 1280x720@60fps

MKV (*.mkv)

Subtitle Type : Internal / External

- **Video Codec (Profile@Level):** Xvid
 - **Audio Codec:** DTS core / AC3 / AAC-LC / E-AC3 / HE-AAC v1 / HE-AAC v2 / MPEG1L1 / MPEG1L2 / Vorbis
 - **Max. / Min. Resolution:** 1920x1080 / QCIF (176x144)
 - **Max. Frame Rate:** 1920x1080@30fps / 1280x720@60fps
-
- **Video Codec (Profile@Level):** AVC / H.264 BP@L3, MP@L4.2, HP@L4.2
 - **Audio Codec:** DTS core / AC3 / AAC-LC / E-AC3 / HE-AAC v1 / HE-AAC v2 / MPEG1L1 / MPEG1L2 / Vorbis
 - **Max. / Min. Resolution:** 1920x1080 / QCIF (176x144)
 - **Max. Frame Rate:** 1920x1080@60fps
-
- **Video Codec (Profile@Level):** MPEG4 SP@L6, ASP@L5, ACEP@L4
 - **Audio Codec:** DTS core / AC3 / AAC-LC / E-AC3 / HE-AAC v1 / HE-AAC v2 / MPEG1L1 / MPEG1L2 / Vorbis
 - **Max. / Min. Resolution:** 1920x1080 / QCIF (176x144)
 - **Max. Frame Rate:** 1920x1080@30fps / 1280x720@60fps
-
- **Video Codec (Profile@Level):** VP8
 - **Audio Codec:** DTS core / AC3 / AAC-LC / E-AC3 / HE-AAC v1 / HE-AAC v2 / MPEG1L1 / MPEG1L2 / Vorbis
 - **Max. / Min. Resolution:** 1920x1080 / QCIF (176x144)
 - **Max. Frame Rate:** 1920x1080@30fps / 1280x720@60fps
-
- **Video Codec (Profile@Level):** AVC / H.264 BP@L5.2, MP@L5.2, HP@L5.2
 - **Audio Codec:** DTS core / AC3 / AAC-LC / E-AC3 / HE-AAC v1 / HE-AAC v2
 - **Max. / Min. Resolution:** 3840x2160 / QCIF (176x144)
 - **Max. Frame Rate:** 3840x2160@60p
-
- **Video Codec (Profile@Level):** HEVC / H.265 MP@L5.1, Main10@L5.1
 - **Audio Codec:** DTS core / AC3 / AAC-LC / E-AC3 / HE-AAC v1 / HE-AAC v2
 - **Max. / Min. Resolution:** 3840x2160 / QCIF (176x144)

- **Max. Frame Rate:** 3840x2160@60p

3gpp (*.3gp / *.3g2)

Subtitle Type : External

- **Video Codec (Profile@Level):** MPEG4 SP@L6, ASP@L5, ACEP@L4
- **Audio Codec:** AAC-LC / HE-AAC v1 / HE-AAC v2 / AC3 / E-AC3 / MPEG1L1 / MPEG1L2
- **Max. / Min. Resolution:** 1920x1080 / QCIF (176x144)
- **Max. Frame Rate:** 1920x1080@30fps / 1280x720@60fps
- **Video Codec (Profile@Level):** AVC / H.264 BP@L3, MP@L4.2, HP@L4.2
- **Audio Codec:** AAC-LC / HE-AAC v1 / HE-AAC v2 / AC3 / E-AC3 / MPEG1L1 / MPEG1L2
- **Max. / Min. Resolution:** 1920x1080 / QCIF (176x144)
- **Max. Frame Rate:** 1920x1080@60fps

MOV (*.mov)

Subtitle Type : External

- **Video Codec (Profile@Level):** AVC / H.264 BP@L3, MP@L4.2, HP@L4.2
- **Audio Codec:** AAC-LC / HE-AAC v1 / HE-AAC v2 / AC3 / E-AC3 / MPEG1L1 / MPEG1L2 / μ -LAW / PCM (U8) / PCM (S16BE) / PCM (S16LE)
- **Max. / Min. Resolution:** 1920x1080 / QCIF (176x144)
- **Max. Frame Rate:** 1920x1080@60fps
- **Video Codec (Profile@Level):** MPEG4 SP@L6, ASP@L5, ACEP@L4
- **Audio Codec:** AAC-LC / HE-AAC v1 / HE-AAC v2 / AC3 / E-AC3 / MPEG1L1 / MPEG1L2 / μ -LAW / PCM (U8) / PCM (S16BE) / PCM (S16LE)
- **Max. / Min. Resolution:** 1920x1080 / QCIF (176x144)
- **Max. Frame Rate:** 1920x1080@30fps / 1280x720@60fps
- **Video Codec (Profile@Level):** Motion JPEG
- **Audio Codec:** AAC-LC / HE-AAC v1 / HE-AAC v2 / AC3 / E-AC3 / MPEG1L1 / MPEG1L2 / μ -LAW / PCM (U8) / PCM (S16BE) / PCM (S16LE)
- **Max. / Min. Resolution:** 1280x720 / QCIF (176x144)
- **Max. Frame Rate:** 1280x720@30fps

WebM (*.webm)

Subtitle Type : Internal / External

- **Video Codec (Profile@Level):** VP8
- **Audio Codec:** Vorbis
- **Max. / Min. Resolution:** 1920x1080 / QCIF (176x144)
- **Max. Frame Rate:** 1920x1080@30fps / 1280x720@60fps

Other supported files and formats

- [Photos](#)
- [Music](#)
- [Audio sampling rates \(for videos\)](#)
- [External subtitles](#)

[37] Using the TV with Other Devices | USB devices | Supported files and formats

Audio sampling rates (for videos)

Audio Codec	Sampling Rate
LPCM	44.1k / 48k
MPEG1L1 / MPEG1L2	32k / 44.1k / 48k
MPEG1L3	
AAC-LC	16k / 22.05k / 24k / 32k / 44.1k / 48k
HE-AAC v1 / v2	24k / 32k / 44.1k / 48k
AC3	32k / 44.1k / 48k
E-AC3	
Vorbis	8k / 11.025k / 16k / 22.05k / 32k / 44.1k / 48k
WMA9	
DTS core	32k / 44.1k / 48k
μ-LAW	8k
PCM (U8)	8k
PCM (S16LE)	11.025k / 16k / 44.1k

Other supported files and formats

- [Photos](#)
- [Music](#)
- [Videos](#)
- [External subtitles](#)

[38] Using the TV with Other Devices | USB devices | Supported files and formats

External subtitles

Use case : USB

File Format	Extension
SubStation Alpha	*.ass / *.ssa
SubRip	*.srt
MicroDVD	*.sub / *.txt
SubViewer	*.sub
SAMI	*.smi

Other supported files and formats

- [Photos](#)
- [Music](#)
- [Videos](#)
- [Audio sampling rates \(for videos\)](#)

[39] Using the TV with Other Devices

Blu-ray and DVD players

[Connecting a Blu-ray or DVD player](#)

[Watching Blu-ray and DVD discs](#)

Connecting a Blu-ray or DVD player

Connect a Blu-ray/DVD player to the TV.

HDMI connection

For optimum picture quality, we recommend connecting your player to the TV using an HDMI cable. If your Blu-ray/DVD player has an HDMI jack (socket), connect it using an HDMI cable.

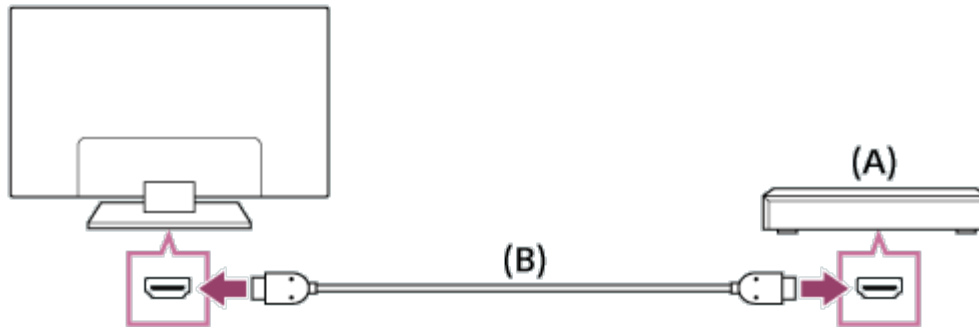

(A) Blu-ray/DVD player

(B) HDMI cable (not supplied)*

* Be sure to use an authorized HIGH SPEED HDMI cable bearing the HDMI logo.

- If the device has a DVI jack (socket), connect it to the HDMI (with AUDIO IN) port through a DVI - HDMI adaptor interface (not supplied), and connect the device's audio out jacks (sockets) to HDMI 3 AUDIO IN / HDMI 1 AUDIO IN.

Availability depends on your model/region/country. Refer to the Reference Guide to check if your TV supports HDMI 3 AUDIO IN / HDMI 1 AUDIO IN.

Component video connection

Availability depends on your model/region/country.

If your Blu-ray/DVD player has component video jacks (sockets), connect them to the TV using a component video cable and an audio cable.

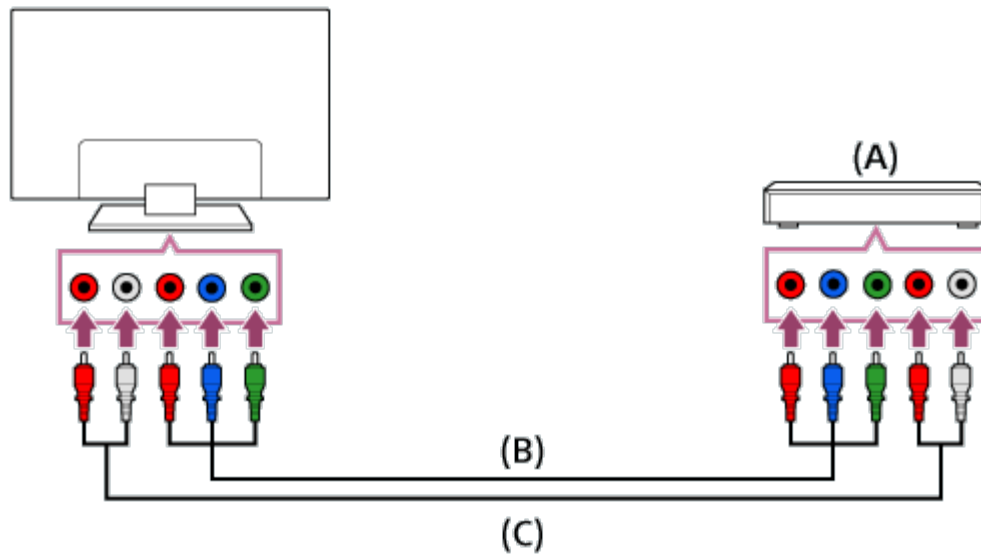

(A) Blu-ray/DVD player

(B) Component video cable (not supplied)

(C) Audio cable (not supplied)

Composite connection

Availability depends on your model/region/country.

If your Blu-ray/DVD player has composite jacks (sockets), connect them using a composite video/audio cable.

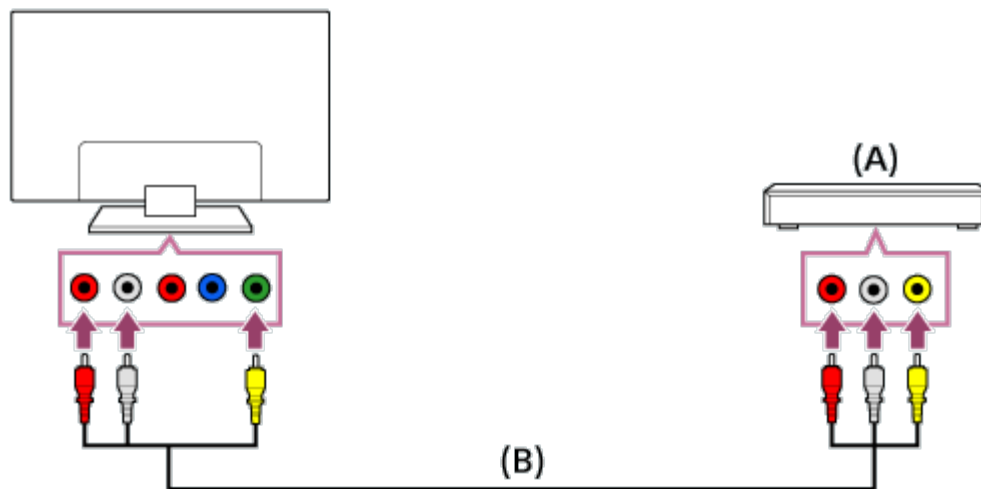

(A) Blu-ray/DVD player

(B) Composite video/audio cable (not supplied)

If using an Analog Extension cable

Availability depends on your model/region/country.

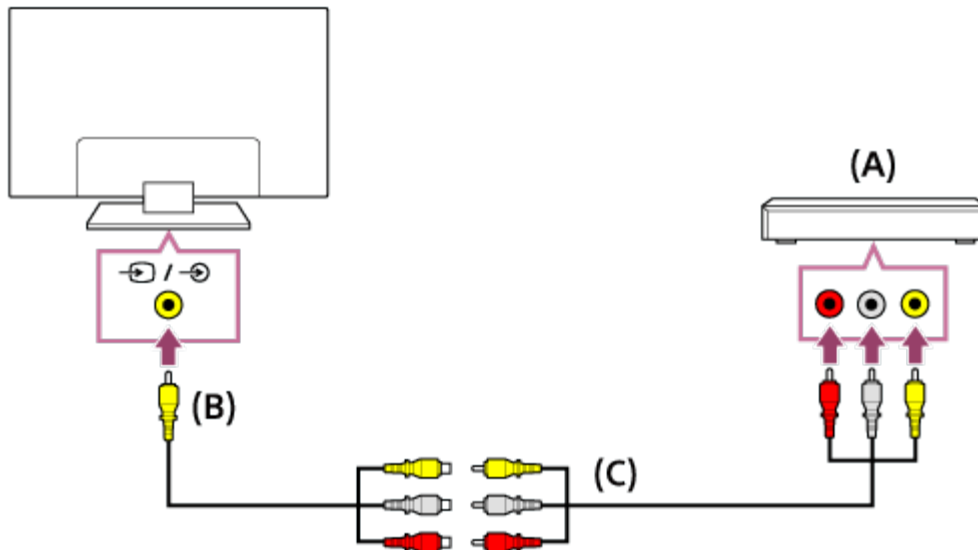

(A) Blu-ray/DVD player

(B) Analog Extension cable (supplied)*

(C) RCA Cable (not supplied)

* Whether the Analog Extension cable is supplied depends on your model/region/country.

Related topics

- [Watching Blu-ray and DVD discs](#)

[41] Using the TV with Other Devices | Blu-ray and DVD players

Watching Blu-ray and DVD discs

You can watch content from Blu-ray/DVD discs or other content supported by your player on the TV.

- 1 Turn on the connected Blu-ray/DVD player.
- 2 Press the INPUT button repeatedly to select the connected Blu-ray/DVD player.
- 3 Start playback on the connected Blu-ray/DVD player.

Hint

- If you connect a BRAVIA Sync-compatible device with HDMI connection, you can operate it by simply using the TV's remote control.

Related topics

- [Connecting a Blu-ray or DVD player](#)
- [BRAVIA Sync-compatible devices](#)

[42] Using the TV with Other Devices

Smartphones and tablets

[Displaying the screen of a smartphone/tablet on the TV using the Screen mirroring function](#)

[Sharing photos/music/videos](#)

[Using the “Video & TV SideView” app with your smartphone/tablet](#)

[43] Using the TV with Other Devices | Smartphones and tablets

Displaying the screen of a smartphone/tablet on the TV using the Screen mirroring function

You can display the screen of a mobile device on the TV to view photos, videos or websites.

The “Screen mirroring” feature uses Miracast technology to display the screen of a compatible device on the TV. A wireless router (access point) is not necessary to use this function.



(A) Smartphone

(B) Tablet

(C) Computer

- 1** Press the **INPUT** button, then select **[Screen mirroring]**.
- 2** Operate your **Screen mirroring compatible device to connect to the TV.**

When the device is connected to the TV, the screen displayed on the device will also be displayed on the TV.

For details, refer to the instruction manual of your device.

Note

- While the standby screen for the Screen mirroring is displayed, the wireless connection between the TV and your wireless router (access point) is disconnected, therefore communication via the Internet is stopped.

Hint

- You can configure the advanced settings of Screen mirroring by pressing the HOME button, then selecting [Settings] — [Network] — [Wi-Fi Direct] — [Advanced settings].

Related topics

- [Using Wi-Fi Direct to connect to the TV \(no wireless router required\)](#)
- [Connected devices](#)
- [What kind of devices can be connected using the Screen mirroring function?](#)

[44] Using the TV with Other Devices | Smartphones and tablets

Sharing photos/music/videos

Gather around the TV with your family or friends, connect your mobile devices to the TV and view your favorite photos/videos on the large screen TV, or play your favorite tracks through the TV speakers.



- 1** Press the HOME button, then select [Photo Sharing Plus].
- 2** Follow the on-screen instructions to connect each mobile device to the TV.
- 3** Open the web browser on your mobile device and follow the on-screen instructions to

access the URL shown on the TV screen.

- 4 Follow the on-screen instructions on your mobile device to view photos or play music/videos on the TV, or save photos/videos displayed on the TV.

Note

- If the TV uses the 5GHz band to connect to a wireless router (or access point), the connection is disconnected when this function is started.
- Up to 10 mobile devices can be connected to the TV at the same time. To connect another device when 10 devices are already connected, disconnect an unnecessary device, then connect the other device.
- The default browser for Android 2.3 or later is supported.
- The default browser for iOS is supported, however, some functions cannot be used depending on the version of your iOS.
- iOS devices cannot upload music to the TV.

Related topics

- [Using Wi-Fi Direct to connect to the TV \(no wireless router required\)](#)

[45] Using the TV with Other Devices | Smartphones and tablets

Using the “Video & TV SideView” app with your smartphone/tablet

You can install the “Video & TV SideView” app in your mobile device and use the mobile device to control the TV. To use your mobile device as a TV remote control, register it to the TV as a remote device. (Registration is required only for the first time.)

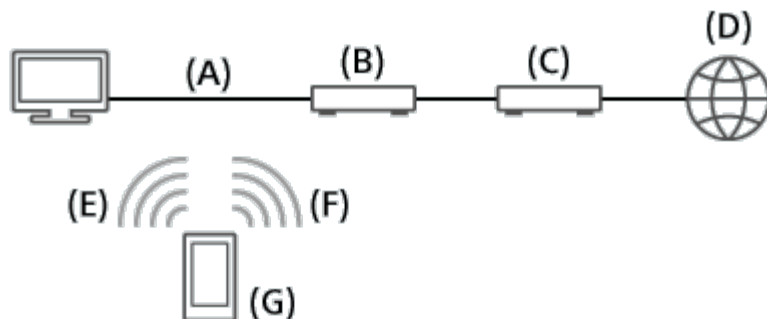

(A) Wi-Fi or Ethernet

- (B) Router
- (C) Modem
- (D) Internet
- (E) Wi-Fi Direct
- (F) Wi-Fi
- (G) Mobile device

Available operations when using the “Video & TV SideView” app

- Powering on and controlling the TV as a remote control
- Entering text using the mobile device’s keyboard

For comprehensive information about the “Video & TV SideView” app, refer to the following website:

<http://info.tvsideview.sony.net>

For details on how to use the “Video & TV SideView” app, refer to the app’s help guide.

Hint

- You can search and download the “Video & TV SideView” app from here:
 - Google Play (for Android OS)
 - App Store (for iOS)

Registering a mobile device to the TV

Mutual registration (the following steps) is required only for the first time.

- 1** Connect the TV to your home network.
- 2** Connect the mobile device to the home network that the TV is connected to or search for the TV from the list of available Wi-Fi Direct devices.
- 3** Launch the “Video & TV SideView” app on the mobile device.
- 4** Select the TV from the detected device list, then perform the required operation on your device.

Hint

- You can also connect the “Video & TV SideView” app to the TV using Wi-Fi Direct. Press the

HOME button, enable the TV's Wi-Fi Direct function by selecting [Settings] — [Network] — [Wi-Fi Direct] — [Wi-Fi Direct].

Then, navigate to the [Wi-Fi Direct settings] page by selecting [Settings] — [Network] — [Wi-Fi Direct] — [Wi-Fi Direct settings].

To turn on the TV from “Video & TV SideView” on your mobile device

- 1 To enable [Remote start], press the HOME button, then select [Settings] — [Network] — [Remote start].

Standby power consumption increases if this option is enabled.

Note

- Make sure that [Remote device/Renderer] is enabled. To confirm the setting, press the HOME button, then select [Settings] — [Network] — [Home network] — [Remote device/Renderer] — [Remote device/Renderer].
- The name and available functions of “Video & TV SideView” are subject to change.

Related topics

- [Using Wi-Fi Direct to connect to the TV \(no wireless router required\)](#)
- [Connected devices](#)

[46] Using the TV with Other Devices

Computers, cameras, and camcorders

[Connecting a computer and viewing stored content](#)

[Connecting a camera or camcorder and viewing stored content](#)

[Computer video signal specifications](#)

[47] Using the TV with Other Devices | Computers, cameras, and camcorders

Connecting a computer and viewing stored content

To connect a computer

Use an HDMI cable to connect your computer to the TV.

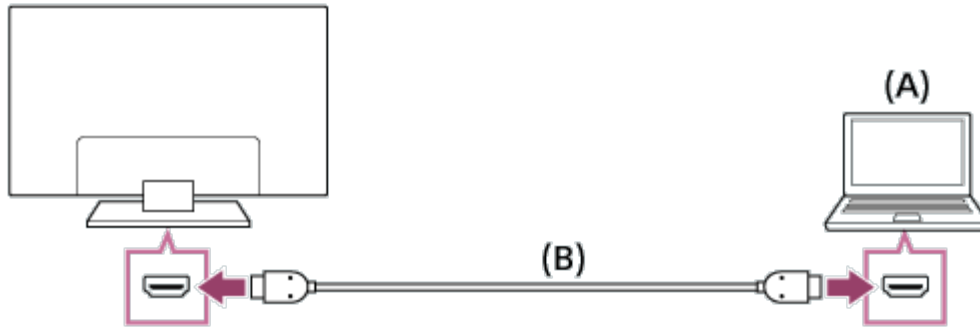

(A) Computer

(B) HDMI cable (not supplied) *

* Be sure to use an authorized HIGH SPEED HDMI cable bearing the HDMI logo.

To check the video signal specifications

- [Computer video signal specifications](#)

To view content stored on a computer

After connecting the computer, press the HOME button, then select the input the computer is connected to.

To check the supported file formats

- [Supported files and formats](#)

Note

- For optimum picture quality, we recommend that you set your computer to output video signals according to one of the settings listed in “Computer video signal specifications”.
- Depending on the connection status, the image may be blurred or smeared. In this case, change the computer’s settings and select another input signal from the “Computer video signal specifications” list.

[48] Using the TV with Other Devices | Computers, cameras, and camcorders

Connecting a camera or camcorder and viewing

stored content

To connect a camera or camcorder

Connect your Sony digital still camera or camcorder using an HDMI cable. Use a cable that has an HDMI mini jack (socket) for the digital still camera/camcorder end, and a standard HDMI jack (socket) for the TV end.



- (A) Digital still camera
- (B) Camcorder
- (C) HDMI cable (not supplied)*

* Be sure to use an authorized HIGH SPEED HDMI cable bearing the HDMI logo.

To view content stored on a digital still camera/camcorder

- 1** After connecting the digital still camera/camcorder, turn it on.
- 2** Press the INPUT button repeatedly to select the connected digital still camera/camcorder.
- 3** Start playback on the connected digital still camera/camcorder.

To check the supported file formats

- [Supported files and formats](#)

Hint

- If you connect a BRAVIA Sync-compatible device, you can operate it by simply using the TV's remote control. Make sure that the device is BRAVIA Sync-compatible. Some devices may not be compatible with BRAVIA Sync even though they have an HDMI jack (socket).

Related topics

- [BRAVIA Sync-compatible devices](#)

[49] Using the TV with Other Devices | Computers, cameras, and camcorders

Computer video signal specifications

(Resolution, Horizontal frequency/Vertical frequency)

- 640 x 480, 31.5 kHz/60 Hz
- 800 x 600, 37.9 kHz/60 Hz
- 1024 x 768, 48.4 kHz/60 Hz
- 1152 x 864, 67.5 kHz/75 Hz
- 1280 x 1024, 64.0 kHz/60 Hz
- 1600 x 900, 56.0 kHz/60 Hz
- 1680 x 1050, 65.3 kHz/60 Hz
- 1920 x 1080, 67.5 kHz/60 Hz *

* 1080p timing, when applied to the HDMI input, will be treated as video timing and not computer timing. This will affect the [Screen] settings in [Picture & Display]. To view computer content, set [Wide mode] to [Full], and [Display area] to [+1]. ([Display area] is configurable only when [Auto display area] is disabled.)

Note

- This TV does not support interlaced computer signals.
- 1920 x 1080/60 Hz output may not be available, depending on your computer. Even if 1920 x 1080/60 Hz output is selected, the actual output signal may differ. In this case, change the computer's settings, then set your computer to use a different video signal.

[50] Using the TV with Other Devices

Audio system

[Connecting an audio system](#)

[Adjusting audio system-related settings](#)

Connecting an audio system

See the illustrations below to connect an audio system such as an AV receiver or sound bar. After finishing the connection, configure the audio settings to play TV sound through the audio system (refer to the related topic link at the bottom of this page).

To connect an ARC capable audio system using an HDMI cable

If your audio system features HDMI output jacks (sockets), you can connect the TV to your audio system using an HDMI cable.

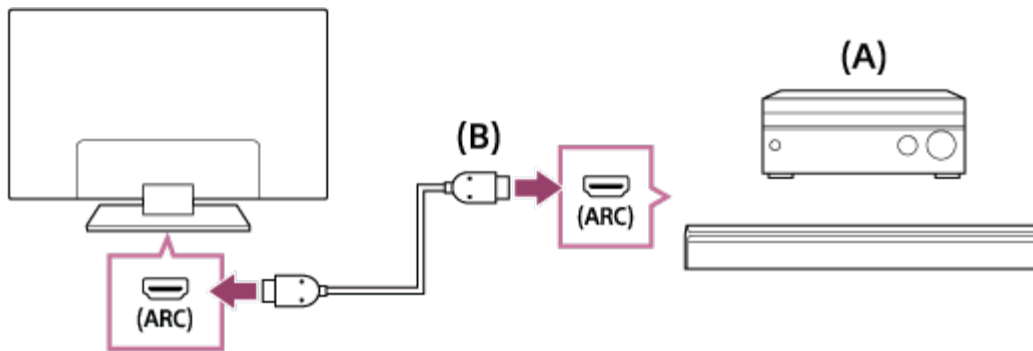

(A) AV receiver or sound bar

(B) HDMI cable (not supplied)*

* Be sure to use an authorized HIGH SPEED HDMI cable bearing the HDMI logo.

Hint

- When connecting a BRAVIA Sync-compatible digital audio system with Audio Return Channel (ARC) technology, connect it to the HDMI IN jack (socket) labeled with the “ARC” mark with an HDMI cable. However, if connecting a system that is not BRAVIA Sync-compatible or Audio Return Channel capable, you must also connect the TV to the audio system using the DIGITAL AUDIO OUT (OPTICAL) jack (socket).
- See the instruction manual of the audio system for details on connecting other devices and for set-up.

Note

- The location of the HDMI port that supports ARC varies depending on your model. Refer to the Reference Guide.

To connect an audio system that is not ARC capable using an optical audio cable

You can connect the TV's audio output to an audio system using an optical audio cable.

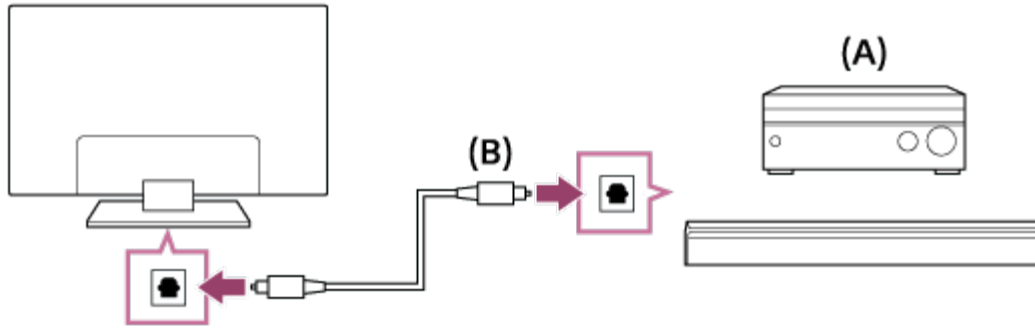

(A) AV receiver or Sound bar

(B) Optical audio cable (not supplied)

Hint

- See the instruction manual of the audio system for details on connecting other devices and for set-up.

To connect an audio system using an audio cable

You can connect the TV's audio output to an audio system using a stereo to RCA analog audio cable.

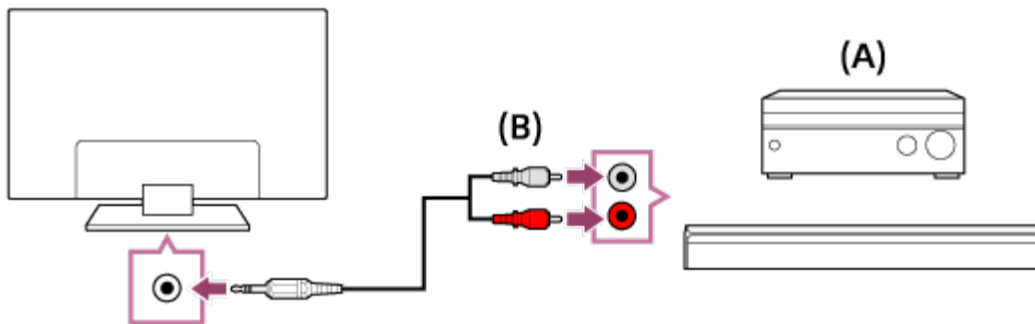

(A) AV receiver or Sound bar

(B) Audio cable (not supplied)

Hint

- See the instruction manual of the audio system for details on connecting other devices and for the set-up.

Related topics

- [Adjusting audio system-related settings](#)

[52] Using the TV with Other Devices | Audio system

Adjusting audio system-related settings

When using the HDMI connection or optical audio connection

- 1** After connecting the TV to your audio system, press the ACTION MENU button, then select [Speakers] — [Audio system].
- 2** Turn on the connected audio system, then adjust the volume.
If you connect a BRAVIA Sync-compatible device with an HDMI connection, you can operate it by simply using the TV's remote control.

Note

- You need to configure the [Digital audio out] settings according to your audio system. Press the HOME button, then select [Settings] — [Sound] — [Digital audio out].

When using the audio cable connection

- 1** After connecting the TV to your audio system, press the HOME button, then select [Settings] — [Sound] — [Headphone/Audio out] — [Audio out (Fixed)].
- 2** Turn on the connected audio system, then adjust the volume.

Hint

- When using an external audio system, the audio out of the TV can be operated using the TV's remote control if [Headphone/Audio out] is set to [Audio out (Variable)]. Press the HOME button, then select [Settings] — [Sound] — [Headphone/Audio out] — [Audio out (Variable)].
- When connecting a subwoofer, press the HOME button, then select [Settings] — [Sound] — [Headphone/Audio out] — [Subwoofer].

Related topics

- [Connecting an audio system](#)
- [No sound but good picture.](#)
- [No audio or low audio with a home theater system.](#)

[53] Using the TV with Other Devices

Bluetooth devices

[Connecting a Bluetooth device](#)

[Supported Bluetooth profiles](#)

[54] Using the TV with Other Devices | Bluetooth devices

Connecting a Bluetooth device

To pair the TV with a Bluetooth device

- 1** Turn the Bluetooth device on and put it in pairing mode.
To put your Bluetooth device in pairing mode, refer to the instruction manual of the device.
- 2** Press the HOME button, then select [Settings] — [Bluetooth settings] — [Device list] — [Add accessory] to put the TV in pairing mode.
A list of available Bluetooth devices will be displayed.
- 3** Select the desired device from the list, then follow the on-screen instructions.
If you are prompted to enter a passcode, refer to the instruction manual of the device.
After pairing is completed, the device connects to the TV.

Related topics

- [Supported Bluetooth profiles](#)
 - [Operation cuts out, or a device does not work.](#)
-

Supported Bluetooth profiles

The TV supports the following profiles:

- HID (Human Interface Device Profile)
- HOGP (HID over GATT Profile)
- 3DSP (3D Synchronization Profile)*
- SPP (Serial Port Profile)

* Available depending on your model/region/country.

Related topics

- [Connecting a Bluetooth device](#)

Sony wireless subwoofer (optional) (Sony wireless subwoofer supported models only)

[Connecting a wireless subwoofer \(optional\)](#)

[Adjusting wireless subwoofer-related settings \(optional\)](#)

Connecting a wireless subwoofer (optional)

You can use the optional Wireless Subwoofer SWF-BR100 to extend the bass response of the TV's sound.

The availability of this feature depends on your model/region/country.

TVs that support the Wireless Subwoofer indicate "SWF-BR100" in the specifications section of the Reference Guide.

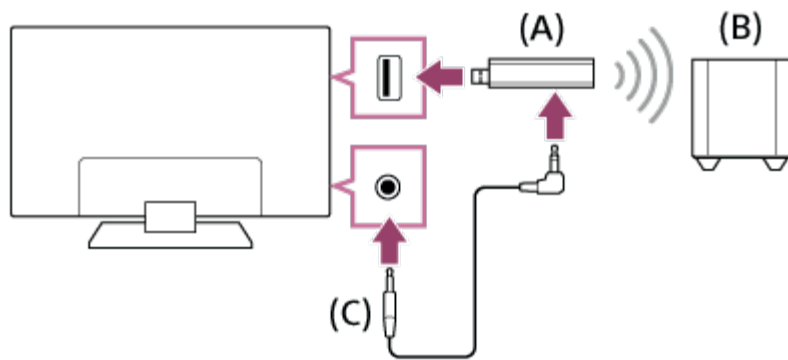

(A) Wireless Transceiver

(B) Wireless Subwoofer SWF-BR100

(C) Audio cable

- 1 Connect the audio cable (supplied) to the Wireless Transceiver.
- 2 Connect the other end of the audio cable to the AUDIO OUT /  jack (socket) of the TV.
[Headphone/Audio out] is automatically set to [Subwoofer].
- 3 Connect the Wireless Transceiver to the USB port of the TV.
[Headphone/Audio out] is automatically set to [Subwoofer].
- 4 Position the Wireless Subwoofer and connect it to the AC power.
We recommend that the Wireless Subwoofer be placed as close as possible to the TV.

Hint

- When the Wireless Transceiver is disconnected, [Headphone/Audio out] is automatically restored to its original setting.
- For details on how to set up the Wireless Subwoofer, refer to the instruction manual supplied with the Wireless Subwoofer.

Related topics

- [Adjusting wireless subwoofer-related settings \(optional\)](#)

[58] Using the TV with Other Devices | Sony wireless subwoofer (optional) (Sony wireless subwoofer supported models only)

Adjusting wireless subwoofer-related settings (optional)

Sony wireless subwoofer supported models have [Wireless Subwoofer power] in [Settings] — [Sound] — [Sound adjustments].

The sound settings of the Wireless Subwoofer have already been set to the recommended values for your TV. Follow the instructions below to change the settings to suit your preferences.

- 1 Press the HOME button, then select [Settings] — [Sound] — [Sound adjustments] — [Advanced settings] — [Sound mode related] — [Wireless Subwoofer].

Available Options

[Wireless Subwoofer level]

Adjusts the volume level of the Wireless Subwoofer.

[Cut off frequency (50-200Hz)]

Adjusts the cutoff frequency of the Wireless Subwoofer. All frequencies below the cutoff frequency are output to the Wireless Subwoofer.

[Phase]

Sets the phase polarity. Select the setting to suit your preference.

[Wireless Subwoofer sync]

Adjusts the time lag of the Wireless Subwoofer sound. If the sound produced by the Wireless Subwoofer is too late, use [+]; if it is too early, use [-].

[Reset Wireless Subwoofer settings]

Resets the Wireless Subwoofer settings to their initial values.

To set the power control method of the Wireless Subwoofer

- 1 Press the HOME button, then select [Settings] — [Sound] — [Sound adjustments] — [Wireless Subwoofer power].

Related topics

- [Connecting a wireless subwoofer \(optional\)](#)

[59] Using the TV with Other Devices

BRAVIA Sync-compatible devices

[BRAVIA Sync overview](#)

[60] Using the TV with Other Devices | BRAVIA Sync-compatible devices

BRAVIA Sync overview

If a BRAVIA Sync-compatible device (e.g., BD player, AV amplifier) is connected with an HDMI cable, you can operate the device with the TV's remote control.

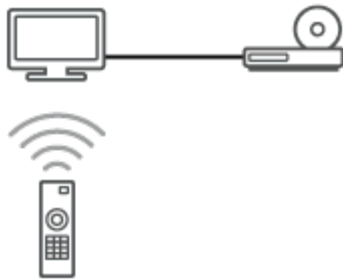

Related topics

- [Using features available for BRAVIA Sync-compatible devices](#)
- [Adjusting BRAVIA Sync settings](#)

[61] Using the TV with Other Devices | BRAVIA Sync-compatible devices

Using features available for BRAVIA Sync-compatible devices

The [Sync Menu] is primarily used to operate BRAVIA Sync-compatible devices from the TV.



Press the ACTION MENU button, and select [Sync Menu].

Blu-ray/DVD player





- Automatically turns the Blu-ray/DVD player on and switches the input to the Blu-ray/DVD player when you select it from the Home Menu or Sync Menu.
- Automatically turns the TV on and switches the input to the connected Blu-ray/DVD player when the Blu-ray/DVD player starts to play.
- Automatically turns the connected Blu-ray/DVD player off when you turn the TV off.

Controls menu operation ( /  /  /  buttons), playback (e.g.,  button), and channel selection of the connected Blu-ray/DVD player through the TV's remote control.

AV amplifier

- Automatically turns the connected AV amplifier on and switches the sound output from the TV speaker to the audio system when you turn the TV on. This function is only available if you have previously used the AV amplifier to output the TV's sound.
- Automatically switches the sound output to the AV amplifier by turning the AV amplifier on when the TV is turned on.
- Automatically turns the connected AV amplifier off when you turn the TV off.
- Adjusts the volume ( +/- buttons) and mutes the sound ( button) of the connected AV amplifier through the TV's remote control.

Video camera

- Automatically turns the TV on and switches the input to the connected video camera when the camera is turned on.
- Automatically turns the connected video camera off when you turn the TV off.
- Controls menu operation ( /  /  /  buttons), playback (e.g.,  button) of the connected video camera through the TV's remote control.

Note

- “BRAVIA Sync control” (BRAVIA Sync) is only available for connected BRAVIA Sync-compatible devices that have the BRAVIA Sync logo.

Related topics

- [BRAVIA Sync overview](#)
- [Adjusting BRAVIA Sync settings](#)

[62] Using the TV with Other Devices | BRAVIA Sync-compatible devices

Adjusting BRAVIA Sync settings

- 1 Turn on the connected device.

2 To enable [BRAVIA Sync control], press the HOME button, then select [Settings] — [External inputs] — [BRAVIA Sync settings] — [BRAVIA Sync control].

3 Activate BRAVIA Sync on the connected device.

When a specific Sony BRAVIA Sync-compatible device is connected and powered on and [BRAVIA Sync control] is enabled, BRAVIA Sync is automatically activated on that device. For details, refer to the instruction manual of the connected device.

Available options

Available options are shown below. (Options vary depending on your model/region/country.)

[Device auto power off]

If disabled, the connected device does not turn off automatically when the TV is turned off.

[TV auto power on]

If disabled, the TV does not turn on automatically when the connected device is turned on.

[BRAVIA Sync device list]

Displays the BRAVIA Sync device list.

[Device control keys]

Allows you to set buttons to control an HDMI connected device.

To use the Sync Menu

1 Press the SYNC MENU button, then select the desired item in the Sync Menu.

Hint

- If you press the SYNC MENU button, the promotion screen is displayed in the following situations:
 - An HDMI device is not connected.
 - [BRAVIA Sync control] is disabled.

Related topics

- [BRAVIA Sync overview](#)
- [Using features available for BRAVIA Sync-compatible devices](#)

Connecting an IR Blaster (IR Blaster compatible models only)

IR Blaster compatible models have [IR Blaster setup] in [Settings] — [External inputs].

The IR Blaster allows you to operate a set-top box or AV Receiver that is connected to the TV, with the TV's remote control.

(IR Blaster compatible models may not be available depending on your model/country.)

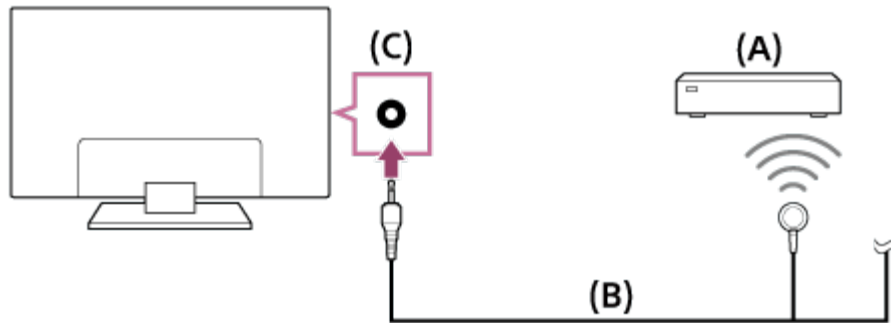

(A) Set-top box or AV Receiver

(B) IR Blaster cable

(C) IR Blaster jack (socket)

To set up the IR Blaster

- 1 Press the HOME button, then select [Settings] — [External inputs] — [IR Blaster setup].
- 2 Select the desired device from the list, then follow the on-screen instructions.

Hint

- The IR Blaster can operate an AV receiver. To set up an AV receiver, press the HOME button, then select [Settings] — [External inputs] — [IR Blaster setup] — [AV receiver control setup].
- If the AV receiver is a BRAVIA Sync-compatible device, an IR Blaster is not needed.

Note

- Some external devices may not respond to some items in the “Action Menu”.
- If you press and hold a button on the remote control, the operation may not be transmitted. Instead, press the button repeatedly.
- Make sure that the IR Blaster is correctly set up and the IR transmitter is located near the IR receiver of the external device.

- Make sure that your TV supports the external device.

Related topics

- [An external device \(such as a set-top box or AV receiver\) cannot be controlled via the IR Blaster. \(IR Blaster compatible models only\)](#)

[64] Using the TV with Other Devices

Viewing pictures in 4K from compatible devices

[Viewing pictures in 4K resolution](#)

[Settings for viewing pictures in 4K resolution with higher quality](#)

[65] Using the TV with Other Devices | Viewing pictures in 4K from compatible devices

Viewing pictures in 4K resolution

A picture with a 4K or higher resolution can be displayed in 4K resolution (3840x2160). You can connect a digital still camera/camcorder that supports HDMI 4K output to HDMI IN of the TV to display high resolution photos stored on the camera. You can also display high resolution photos stored in connected USB devices or your home network.

The availability of this function depends on your region/country.

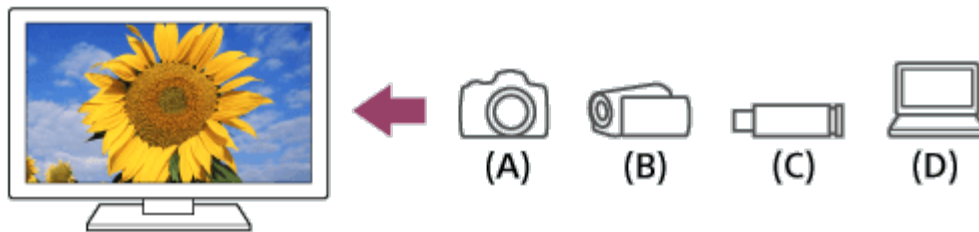

- (A) Digital still camera
- (B) Camcorder
- (C) USB device
- (D) Network device

To view pictures stored on a USB device or network device in 4K resolution

- 1 Connect the USB device or network device to the TV.

- 2 Press the HOME button, then select [Album] — the USB device, server, or preset folder containing the file to play — the folder or file from the list.

If you select a folder, select the file.

To view pictures stored on a digital still camera/camcorder

- 1 Connect a digital still camera or camcorder that supports HDMI output to the HDMI IN jack (socket) of the TV, using an HDMI cable.
- 2 Press the INPUT button repeatedly to select the connected device.
- 3 Set the connected device to 4K output.
- 4 Start playback on the connected device.

To check the supported file formats

- [Supported files and formats](#)

To view pictures in 4K resolution with higher quality

You can set the HDMI signal format to [Enhanced format] to view pictures in 4K resolution with higher quality.

For information about Enhanced format or changing the settings, refer to the [Settings for viewing pictures in 4K resolution with higher quality](#) page.

Note

- A 3D picture cannot be displayed.
- If you change the picture by pressing the ◀ / ▶ buttons, it may take time to display.

Related topics

- [Computers, cameras, and camcorders](#)
- [USB devices](#)
- [Connecting to a Network](#)

Settings for viewing pictures in 4K resolution with higher quality

When you display the High-Quality 4K format with the HDMI input, set [HDMI signal format] in [External inputs].

HDMI signal format

To change the HDMI signal format setting, press the HOME button, then select [Settings] — [External inputs] — [HDMI signal format].

Standard format

Standard HDMI format^{*1} for normal use.

Enhanced format

High-Quality HDMI format^{*1*2}. Set only when using capable devices.

^{*1} HDR included (HDR models only). HDR models have [HDR mode] in [Settings] — [Picture & Display] — [Picture adjustments] — [Advanced settings] — [Video options].

^{*2} 4K 60p 4:2:0 10bit, 4:4:4:, 4:2:2 etc.

Note

- When using [Enhanced format], picture and sound may not be output correctly. In this case, connect the device to an HDMI IN that is in [Standard format], or change the HDMI signal format of HDMI IN to [Standard format].
- Set to [Enhanced format] only when using compatible devices.
- When you watch 4K picture with High-Quality, use a Premium High Speed HDMI Cable(s) that supports speeds of 18 Gbps. For details on a Premium High Speed HDMI Cable(s) that supports 18 Gbps, refer to the cable specifications.
- In some models, the HDMI signal format of HDMI IN 2 and 3 changes at the same time.

Related topics

- [Viewing pictures in 4K resolution](#)

[67]

Connecting to a Network

[Connecting to a network using a LAN cable](#)

[Connecting to a network using a wireless connection](#)

[Home network features](#)

[68] Connecting to a Network

Connecting to a network using a LAN cable

Connecting to a network using a LAN cable

A wired LAN connection allows you to access the Internet and your home network. Connect a LAN cable to your TV.

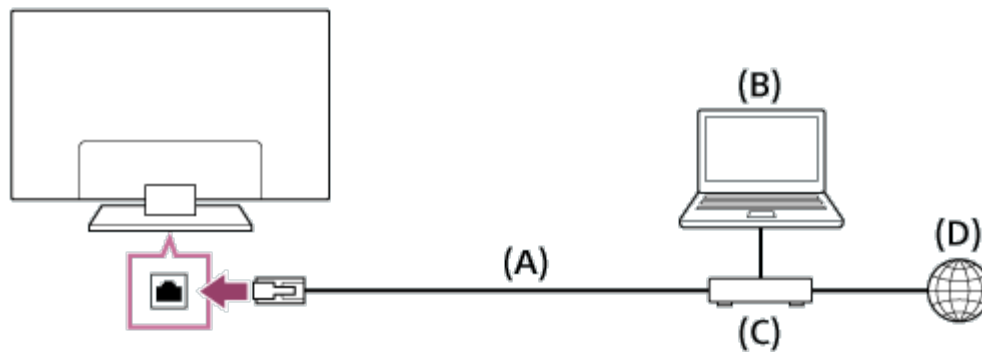

(A) LAN cable

(B) Computer

(C) Modem with router functions

(D) Internet

1 Set up your LAN router.

For details, refer to the instruction manual of your LAN router, or contact the person who set up the network (network administrator).

2 Press the HOME button, then select [Settings] — [Network] — [Network setup] — [Easy].

3 Follow the on-screen instructions to complete the set-up.

Note

- The network-related settings that are required may vary depending on the Internet service provider or router. For details, refer to the instruction manuals provided by the Internet service provider or those supplied with the router. You can also contact the person who set up the

network (network administrator).

[69] Connecting to a Network

Connecting to a network using a wireless connection

[Using Wi-Fi to connect the TV to your network](#)

[Using Wi-Fi Direct to connect to the TV \(no wireless router required\)](#)

[70] Connecting to a Network | Connecting to a network using a wireless connection

Using Wi-Fi to connect the TV to your network

The built-in wireless LAN device allows you to access the Internet and enjoy the benefits of networking in a cable-free environment.

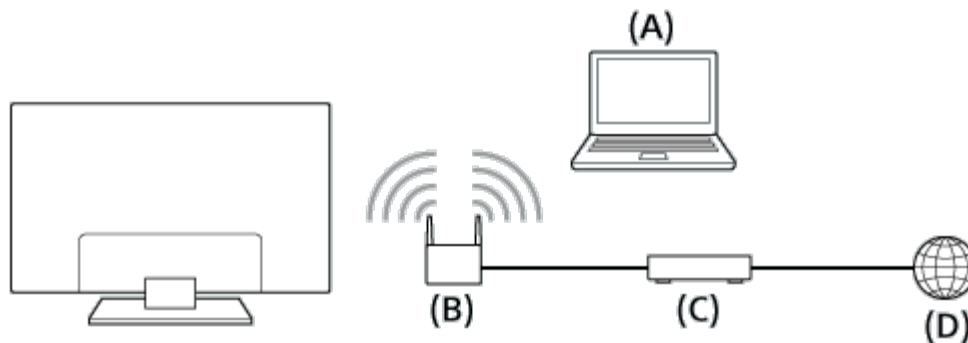

(A) Computer

(B) Wireless router (access point)

(C) Modem

(D) Internet

1 Set up your wireless router (or access point).

For details, refer to the instruction manual of your wireless router (or access point), or contact the person who set up the network (network administrator).

2 Press the HOME button, then select [Settings] — [Network] — [Network setup] — [Easy].

3 Follow the on-screen instructions to complete the set-up.

To turn off the built-in wireless LAN

To disable [Built-in Wi-Fi], press the HOME button, then select [Settings] — [Network] — [Advanced settings] — [Built-in Wi-Fi].

Hint

- For smooth video streaming:
 - Change the setting of your wireless router (or access point) to a high-speed networking standard such as 802.11n if possible.
For details on how to change the setting, refer to the instruction manual of your wireless router (or access point), or contact the person who set up the network (network administrator).
 - If the above procedure does not deliver any improvement, change the setting of your wireless router (or access point) to 5GHz, which may help improve the video streaming quality.
 - The 5GHz band may not be supported depending on your region/country. If the 5GHz band is not supported, the TV can only connect to a wireless router (access point) using the 2.4GHz band.
- To use WEP security with a wireless router (or access point), select [Settings] — [Network] — [Network setup] — [Easy] — [Wi-Fi] — [Connect by scan list].

Note

- The network-related settings that are required may vary depending on the Internet service provider or router. For details, refer to the instruction manuals provided by the Internet service provider or those supplied with the router. You can also contact the person who set up the network (network administrator).
- If you select the [Show password] option in the password entry screen, the exposed password may be seen by other individuals.

Related topics

- [Network \(Internet/home\)/apps](#)

[71] Connecting to a Network | Connecting to a network using a wireless connection

Using Wi-Fi Direct to connect to the TV (no wireless router required)

You can connect a device to the TV wirelessly, without using a wireless router, and then stream videos, photos, and music that is stored on your device directly to the TV.



- 1** To enable [Wi-Fi Direct], press the HOME button, then select [Settings] — [Network] — [Wi-Fi Direct] — [Wi-Fi Direct].
- 2** Select [Wi-Fi Direct settings].
- 3** Select the TV name displayed on the TV screen with the Wi-Fi Direct device.
If the device does not support Wi-Fi Direct, select the [Show Network (SSID)/Password].
- 4** Operate the Wi-Fi Direct/Wi-Fi device to connect with the TV.
- 5** Send content from the Wi-Fi Direct/Wi-Fi device to the TV.
For details, refer to the instruction manual of the device.

If the connection does not succeed

When the standby screen for the Wi-Fi Direct setting is displayed, select [Show Network (SSID)/Password] and follow the on-screen instructions to complete the set-up.

To connect another device

Follow the steps above to connect devices. Up to 10 devices can be connected at the same time. To connect another device when 10 devices are already connected, disconnect an unnecessary device, then connect the other device.

To change the name of the TV shown on the connected device

Press the HOME button, then select [Settings] — [About] — [Device name].

To list connected devices/deregister devices

Press the HOME button, then select [Settings] — [Network] — [Wi-Fi Direct] — [Advanced settings] — [Show device list/Delete].

To deregister a device, select the device in the list to delete, then press the  button. Then, select [Yes] in the confirmation display.

To deregister all devices, select [Delete all] in the list, then [Yes] in the confirmation display.

To change the band setting (for experts)

When your TV is not connected wirelessly to a router, you can select the wireless band for the Wi-Fi Direct function. Press the HOME button, then select [Settings] — [Network] — [Wi-Fi Direct] — [Advanced settings] — [Band setting].

[Auto]

Normally use this option. It automatically selects an appropriate band for the Wi-Fi Direct function.

[Auto (2.4GHz band)]

Use this option when connecting with devices that support 2.4GHz only. This option may support more devices than other options.

[Auto (5GHz band)]

Use this option when connecting with devices that support 5GHz. This option may improve video streaming quality.

Note that when you select this option, the TV cannot connect with devices that support 2.4GHz only.

[Manual]

Use this option to select a specific wireless channel.

Hint

- For information about the supported wireless band of your device, refer to the instruction manual of your device.
- The 5GHz band may not be supported depending on your region/country. If the 5GHz band is not supported, you can only use [Auto] and [Manual].

Note

- If the TV is connected to a wireless router (or access point) at 5GHz:
 - The 5GHz wireless connection will be disconnected when [Wi-Fi Direct settings] is selected. While the connection is disconnected, communication via Internet is stopped.

- The connection will resume automatically after exiting from [Wi-Fi Direct settings].
- The 5GHz band may not be supported depending on your region/country.

Related topics

- [The TV cannot be found by a Wi-Fi Direct device.](#)

[72] Connecting to a Network

Home network features

[Adjusting home network settings](#)

[Playing content from a computer](#)

[Playing content from a media server](#)

[RVU statement \(RVU compliant models only\)](#)

[73] Connecting to a Network | Home network features

Adjusting home network settings

You can adjust the following home network settings.

To check the server connection

Press the HOME button, then select [Settings] — [Network] — [Home network] — [Server diagnostics] — follow the on-screen instructions to perform diagnostics.

To use the remote device/renderer function

Press the HOME button, then select [Settings] — [Network] — [Home network] — [Remote device/Renderer] — the desired option.

[Remote device/Renderer]

Enable the renderer function.

You can play photo/music/video files in a controller (e.g., digital still camera) on the TV screen by operating the device directly. You can also use a mobile device as a TV remote control over your home network.

[Remote devices]

Edit the list of mobile devices registered to use as a TV remote control.

[Renderer access control]

- Select [Auto access permission] to access the TV automatically when a controller accesses the TV for the first time.
- Select [Custom settings] to change the access permission settings of each controller.

Related topics

- [Using the “Video & TV SideView” app with your smartphone/tablet](#)

[74] Connecting to a Network | Home network features

Playing content from a computer

You can play photo/music/video files stored on a server (e.g., computer) that is connected to the same home network that the TV is connected to.

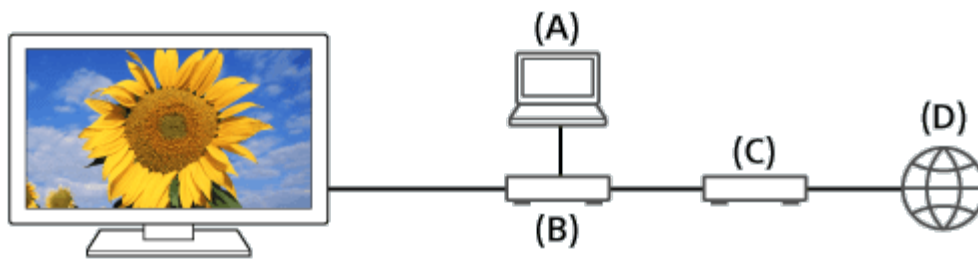

(A) Computer (Server)

(B) Router

(C) Modem

(D) Internet

- 1** Connect the TV to your home network.
- 2** Press the HOME button, then select [Album], [Video], or [Music] — the server containing the file to play — the folder or file from the list.
If you select a folder, select the desired file.
Playback starts.

To check the supported file formats

- [Supported files and formats](#)

Note

- Depending on the file, playback may not be possible even when using the supported formats.

Related topics

- [Adjusting home network settings](#)

[75] Connecting to a Network | Home network features

Playing content from a media server

You can play photo/music/video files in a controller (e.g., digital still camera) on the TV screen by operating the controller directly. The controller should also be renderer-compatible.

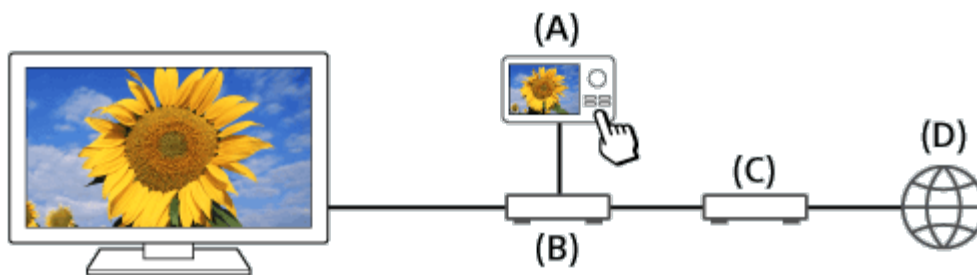

- (A) Digital still camera (Controller)
- (B) Router
- (C) Modem
- (D) Internet

- 1 Connect the TV to your home network.
- 2 Operate the controller to start playing the content on the TV screen.

Related topics

- [Adjusting home network settings](#)

[76] Connecting to a Network | Home network features

RVU statement (RVU compliant models only)

RVU compliant models have [RVU] in [Settings] — [External inputs] — [Manage inputs].

Your TV is equipped with RVU technology which may allow it to connect to compatible satellite receivers over your home network without the need for a dedicated box. Contact your satellite provider for additional information.

[77]

Settings

[Configuring the TV](#)

[Setting a timer](#)

[78] Settings

Configuring the TV

[TV]

[\[Network & Accessories\]](#)

[\[System Preferences\]](#)

[\[Personal\]](#)

[\[Expert panel settings\]\(only models equipped with an OLED panel\)](#)

[79] Settings | Configuring the TV

[TV]

Press the HOME button, then select [Settings] — [TV] — the desired option.

Available options

[Channels]

Configures the settings related to receiving broadcast programming.

[External inputs]

Configures the settings of the external inputs and BRAVIA Sync.

[Picture & Display]

Adjusts the picture and screen display settings such as screen brightness.

[Sound]

Adjusts the sound settings and speaker-related options.

[Illumination LED]

Customizes the Illumination LED.

(The availability of this function depends on your model.)

[Power]

Changes the settings related to power consumption.

[Apps]

Changes the settings related to apps.

[Daydream]

Configures the settings of the screen saver.

[Storage & reset]

Changes the settings related to data storage.

[About]

Displays the information about the TV.

[80] Settings | Configuring the TV

[Network & Accessories]

Press the HOME button, then select [Settings] — [Network & Accessories] — the desired option.

Available options

[Network]

Sets up and checks the network and server connections.

[Google Cast]

Displays information about the Google Cast feature.

[Bluetooth settings]

Setup for registering/deregistering Bluetooth devices.

[Voice Remote Control]

Setup for pairing the Voice Remote Control.

[System Preferences]

Press the HOME button, then select [Settings] — [System Preferences] — the desired option.

Available options

[Date & time]

Adjusts the current time.

[Language]

Selects the menu language.

[Keyboard]

Configures the settings of the on-screen keyboard.

[Search]

Configures the settings of the search function.

[Speech]

Configures the settings of speech-recognition feature.

[Accessibility]

Configures the settings of accessibility features and services for helping users navigate their devices more easily.

[Region]

Sets your location to receive region-specific information.

(This option may not be available depending on your region/country.)

[Retail mode settings]

Enriches the display for shop front use by setting [Demo mode], etc.

[Picture adjustments lock]

Locks the picture adjustments to prevent them from being changed.

(This option may not be available depending on your region/country.)

[Personal]

Press the HOME button, then select [Settings] — [Personal] — the desired option.

Available options

[Location]

Configures the location settings to acquire the user location.

[Security & restrictions]

Configures the security settings such as passwords.

[Parental lock (Broadcast)]

Configures the parental lock settings for broadcasts and other items.

[Parental lock (Streaming channels)]

Configures the parental lock settings for streaming channels.

[Add account]

Adds various service accounts such as Google accounts and Sony Entertainment Network (SEN) accounts.

[83] Settings | Configuring the TV

[Expert panel settings](only models equipped with an OLED panel)

These options are available for models equipped with an OLED panel and are used to prevent image retention.

If the same image is displayed repeatedly or for long periods of time, image retention may occur.

The TV has two functions, [Pixel shift] and [Panel refresh], that are designed to reduce image retention.

Press the HOME button, then select [Settings] — [Picture & Display] — [Expert panel settings] — the desired option.

Available options

[Pixel shift]

Moves the displayed image at regular intervals to prevent image retention. Under normal circumstances, use the TV with this option enabled.

[Panel refresh]

Manually perform a panel refresh only when image retention is particularly noticeable.

Note

- Perform panel refresh only when image retention is particularly noticeable. As a reference, perform it only once a year. Avoid performing it more than once a year because it may affect the usable life of the panel.
- Panel refresh takes about one hour to complete. A white line may be displayed on the screen during the panel refresh. This is not a malfunction of the TV.
- Perform adjustments when the room temperature is between 10°C (50°F) and 40°C (104°F). If the room temperature is outside this range, the panel refresh may not complete.

[84] Settings

Setting a timer

To set the on timer

On timer automatically turns on the TV at a specific time, such as when a program that you want to watch comes on. It also allows you to use the TV as an alarm clock.

- 1 Press the HOME button, then select [Timers] — [Timer] — the desired option.

To set the sleep timer

Sleep timer automatically turns off the TV after a preset time.

- 1 Press the HOME button, then select [Timers] — [Sleep timer] — the desired option.

Note

- When you turn off the TV and turn it on again, [Sleep timer] is reset to [Off].

[85]

Troubleshooting

Start here [Experiencing trouble? Start here.](#)

[Picture \(quality\)/screen](#)

[Keyboard](#)

[Broadcast reception](#)

[Sound](#)

[Network \(Internet/home\)/apps](#)

[Remote control/accessories](#)

[Power](#)

[Connected devices](#)

[Illumination LED](#)

[86] Troubleshooting

Start here

[Self diagnostics](#)

[Software updates](#)

[If a full reset \(restart\) of the TV is required](#)

[87] Troubleshooting | Start here

Self diagnostics

How to check if the TV is working properly.

- Press the HOME button, then select [Self diagnostics] under [Help].

[88] Troubleshooting | Start here

Software updates

Sony will provide software updates from time to time in order to enhance functionality and provide users with the latest TV experience. The easiest way to receive software updates is via an internet connection to the TV.

To turn on automatic software download

To enable [Automatic software download], press the HOME button, then select [Help] — [System

software update] — [Automatic software download].

Hint

- To update the software manually, select [Check for a system software update] in the [System software update] screen.
- If you do not wish to update the software automatically, disable [Automatic software download].

Updating software via USB storage device

If you do not have a network connection, you can also update the software by using a USB storage device. Use your computer to download the latest software from the Sony support website onto a USB storage device. Insert the USB storage device to a USB port on the TV and the software update will start automatically.

If you will update the TV software by using a USB storage device, you should read the cautions for update by USB storage device on the website.

For more about the support site, please see the [Support Site](#) page.

Related topics

- [Connecting to a Network](#)

[89] Troubleshooting | Start here

If a full reset (restart) of the TV is required

If you have trouble such as the picture not displaying on the screen or the remote control not working, try the following procedure.

Press and hold the power button on the remote control for about 5 seconds. The TV will turn off and then restart automatically after a short time. Your personal settings and data will not be lost after the TV restarts (it is the same as unplugging the AC power cord (mains lead)).

[90] Troubleshooting

Picture (quality)/screen

Picture quality is not as good as viewed at the store.

Distorted picture.

The screen flickers.

No color/Dark picture/Color is not correct/Picture is too bright.

Dark screen. How to brighten the screen.

Color is not correct. How to adjust the color tone.

Screen format/wide mode changes automatically.

Suddenly the picture becomes small.

Black bands appear at the edges of the screen.

A black box appears on the screen.

There are banners/tickers at the top or bottom of the screen.

3D pictures are not displayed. The 3D effect is weak. (3D models only)

Black bars appear on both sides of the screen when watching 3D pictures. (3D models only)

You cannot turn off 3D display while watching 3D content. (3D models only)

The message [3D signal has been detected.] automatically appears when 3D signal is detected. (3D models only)

A message about an app asking for permission to access a TV function is displayed.

The screen becomes darker after a certain period of time. (only models equipped with an OLED panel)

The message [Panel refresh did not finish] is displayed. (only models equipped with an OLED panel)

You are concerned about an image retention. (only models equipped with an OLED panel)

A white line appears on the screen. (only models equipped with an OLED panel)

Panel refresh does not complete. (only models equipped with an OLED panel)

[91] Troubleshooting | Picture (quality)/screen

Picture quality is not as good as viewed at the store.

- Picture quality depends on the signal content.
- The picture quality may improve if you change it in [Picture & Display] under [Settings].

Related topics

- [\[TV\]](#)

Distorted picture.

- Check the antenna/cable connection.
- Keep the antenna/cable away from other connecting cables.
- When installing an optional device, leave some space between the device and the TV.
- Press the ACTION MENU button, then select [Picture adjustments] — [Advanced settings] — [Motion] — [Motionflow] — [Standard] or [Off]. (For [Motionflow] compatible models only)
[Motionflow] compatible models have [Motionflow] in [Settings] — [Picture & Display] — [Picture adjustments] — [Advanced settings] — [Motion].
- Change the current setting of [CineMotion] to another setting.
Press the ACTION MENU button, then select [Picture adjustments] — [Advanced settings] — [Motion] — [CineMotion].
- Make sure that the antenna is connected using a high quality 75-ohm coaxial cable.

Related topics

- [Ghosting or double images appear.](#)
- [The screen flickers.](#)

The screen flickers.

- Press the ACTION MENU button, then select [Picture adjustments] — [Advanced settings] — [Motion] — [Motionflow] — [Standard]. (For [Motionflow] compatible models only)

[Motionflow] compatible models have [Motionflow] in [Settings] — [Picture & Display] — [Picture adjustments] — [Advanced settings] — [Motion].

Related topics

- [Distorted picture.](#)

No color/Dark picture/Color is not correct/Picture is

too bright.

- Press the ACTION MENU button, then select [Picture adjustments] to make adjustments.
- Press the ACTION MENU button, then select [Picture adjustments] — [Advanced settings] — [Reset].
- If you set [Power saving] to [Low] or [High], the black level will be enhanced. Press the HOME button, then select [Settings] — [Power] — [Eco] — [Power saving].

Related topics

- [Dark screen. How to brighten the screen.](#)
- [Color is not correct. How to adjust the color tone.](#)

[95] Troubleshooting | Picture (quality)/screen

Dark screen. How to brighten the screen.

- Press the ACTION MENU button, select [Picture adjustments] — [Advanced settings], and adjust [Brightness] or [Contrast].
- Check the [Power saving] option setting in [Eco]. If it is [Low] or [High], the screen darkens. Select [Power] — [Eco], and set [Power saving] to [Off] to brighten the screen.

Related topics

- [No color/Dark picture/Color is not correct/Picture is too bright.](#)

[96] Troubleshooting | Picture (quality)/screen

Color is not correct. How to adjust the color tone.

- Press the ACTION MENU button, select [Picture adjustments] — [Advanced settings], and adjust [Hue] or [Color temperature].
- To deepen the color tone, adjust [Color] or [Live Color]. Press the ACTION MENU button, and then select [Picture adjustments] — [Advanced settings].

Related topics

- [No color/Dark picture/Color is not correct/Picture is too bright.](#)

[97] Troubleshooting | Picture (quality)/screen

Screen format/wide mode changes automatically.

- When changing the channel or video input, if [Auto wide] in [Screen] is enabled, the current [Wide mode] setting is automatically changed according to the input signal. To lock the [Wide mode] setting, disable [Auto wide].

Related topics

- [Suddenly the picture becomes small.](#)

[98] Troubleshooting | Picture (quality)/screen

Suddenly the picture becomes small.

- The picture becomes smaller during commercials due to the method used by the provider to broadcast content. When HD content channels switch to SD content (commercials), the picture may become small with a black border.
- [Auto wide] in [Screen] will not expand the picture while the content switches since the content information is regulated by the channel signal provider. You can manually change the [Wide mode] setting if desired, which will remain in effect until you change the channel/input or manually change the [Wide mode] setting again.

Related topics

- [Screen format/wide mode changes automatically.](#)

[99] Troubleshooting | Picture (quality)/screen

Black bands appear at the edges of the screen.

- Some wide screen programs are filmed in aspect ratios that are greater than 16:9 (this is especially common with theatrical releases). Your TV will show these programs with black bands at the top

and bottom of the screen. For more details, check the documentation that came with your DVD (or contact your program provider).

- Programs in 4:3 aspect ratio will have bands on the left and right sides of the screen.
- Programs broadcasted in HD formats (720p and 1080i) with 4:3 content will commonly have black bands on the left and right sides of the screen which are added by the broadcaster.
- [Auto wide] in [Screen] will not expand the picture when the black bands on the sides of the screen are added by the broadcaster. You can manually set [Wide mode] to [Wide zoom] or [Zoom], which will remain in effect until you change the channel/input or manually change the [Wide mode] setting again.
- Some cable and satellite set-top boxes can also control the size of the picture. If you are using a set-top box, refer to the manufacturer of the set-top box for more information.

[100] Troubleshooting | Picture (quality)/screen

A black box appears on the screen.

- A text option is selected although no text is available. Check the [Captions]/[Broadcast closed captions] settings in [Accessibility]. (Option name differs depending on your region/country.) You can select a different option from the current option.

[101] Troubleshooting | Picture (quality)/screen

There are banners/tickers at the top or bottom of the screen.

In this case, the TV might be in demo mode. Try exiting demo mode.

- Press the ACTION MENU button on the remote control and select [Suspend Demo]. Then, press the HOME button on the remote control and select [Settings] — [Retail mode settings]. Disable [Demo mode] and [Picture reset mode].

[102] Troubleshooting | Picture (quality)/screen

3D pictures are not displayed. The 3D effect is weak. (3D models only)

3D models have [3D settings] in [Settings] — [Picture & Display].

- If two pictures are displayed side-by-side, press the ACTION MENU button, then select [3D] — [3D display] — [3D (Side by Side)].
If two pictures are displayed one above the other, press the ACTION MENU button, then select [3D] — [3D display] — [3D (Over-Under)].
- If the [3D display] screen appears and 3D pictures are not displayed, turn off the device that plays 3D content and turn it on again.
- Perceived 3D effect may vary from person to person.
- 3D signal of 4K cannot be displayed.
- For Passive 3D Glasses models, view the TV from the front on. The 3D effect may be less pronounced depending on the viewing position. Adjust the viewing angle to the screen.

For Active 3D Glasses models

- Be sure that there are no obstacles between the TV and the Active 3D Glasses.
- Replace the battery in the Active 3D Glasses.
- Be sure that the Active 3D Glasses are powered on.
- It is necessary to register your Active 3D Glasses to the TV before use. To use the glasses with another TV, it is necessary to re-register. Turn off the glasses before re-registering.
- Wireless devices or microwave ovens may affect the communication between the 3D Glasses and the TV as the TV uses the 2.4GHz band. In this case, try to register again.
- If a device that is not 3D-compatible (such as a home theater system) is connected between the TV and a 3D-compatible device, the TV will not display 3D pictures. Connect the 3D-compatible device directly to the TV via an authorized HIGH SPEED HDMI cable bearing the HDMI logo.

Related topics

- [Understanding the basics of 3D TV \(3D models only\)](#)

[103] Troubleshooting | Picture (quality)/screen

Black bars appear on both sides of the screen when watching 3D pictures. (3D models only)

3D models have [3D settings] in [Settings] — [Picture & Display].

- Black bars appear on both sides of the screen in order to process 3D signals when adjusting the depth of 3D pictures in [Settings] — [Picture & Display] — [3D settings] — [3D depth adjustment].

[104] Troubleshooting | Picture (quality)/screen

You cannot turn off 3D display while watching 3D content. (3D models only)

3D models have [3D settings] in [Settings] — [Picture & Display].

- For 3D content displayed with the 3D signal, 3D display cannot be turned off on your TV. Turn 3D settings off on the connected device (such as a Blu-ray player).

[105] Troubleshooting | Picture (quality)/screen

The message [3D signal has been detected.] automatically appears when 3D signal is detected. (3D models only)

3D models have [3D settings] in [Settings] — [Picture & Display].

- Deactivate the [3D signal notification] setting. Press the HOME button, then select [Settings] — [Picture & Display] — [3D settings] — [3D signal notification] — [Off].

[106] Troubleshooting | Picture (quality)/screen

A message about an app asking for permission to access a TV function is displayed.

- Select whether to allow or deny the app access to the displayed function.
- You can check the list of app permissions categorized by TV function and change permission settings for each app. Press the HOME button, select [Settings] — [Apps] — [App permissions] — the desired TV function.

[107] Troubleshooting | Picture (quality)/screen

The screen becomes darker after a certain period of time. (only models equipped with an OLED panel)

- If the whole image or part of the image remains still, the screen will gradually become darker to reduce image retention. This is a feature to protect the panel, and is not a malfunction.

[108] Troubleshooting | Picture (quality)/screen

The message [Panel refresh did not finish] is displayed. (only models equipped with an OLED panel)

Panel refresh automatically runs after the TV has been used for a long period of time to reduce image retention. If the TV is turned on, the AC power cord (mains lead) is unplugged, or the ambient temperature falls outside of the range between 10°C (50°F) and 40°C (104°F) during the panel refresh, the process will not complete and this message will appear.

- If panel refresh started automatically, it will restart when you turn off the TV with the remote control.
- If panel refresh was initiated manually, you must select it again.

[109] Troubleshooting | Picture (quality)/screen

You are concerned about an image retention. (only models equipped with an OLED panel)

If the same image is displayed repeatedly or for long periods of time, image retention may occur.

You can manually perform a panel refresh to reduce image retention.

Note

- Perform panel refresh only when image retention is particularly noticeable. As a reference, perform it only once a year. Avoid performing it more than once a year because it may affect the usable life of the panel.
- Images that include clocks and bright colors easily cause image retention. Avoid displaying these types of images for long periods of time, otherwise image retention may occur.

Related topics

- [\[Expert panel settings\]\(only models equipped with an OLED panel\)](#)

[110] Troubleshooting | Picture (quality)/screen

A white line appears on the screen. (only models equipped with an OLED panel)

- Panel refresh automatically runs after the TV has been used for a long period of time to reduce image retention. Panel refresh starts after the TV is turned off and takes about one hour to complete. A white line may be displayed on the screen during the panel refresh. This is not a malfunction of the TV.

[111] Troubleshooting | Picture (quality)/screen

Panel refresh does not complete. (only models equipped with an OLED panel)

- Panel refresh works when the room temperature is between 10°C (50°F) and 40°C (104°F). If the room temperature falls outside of this range during the panel refresh, the process does not finish and a message is displayed. If the message is displayed, check the temperature of the room.

[112] Troubleshooting

Keyboard

You cannot operate the current screen after the on-screen keyboard is displayed.

- To return to operation of the screen behind the on-screen keyboard, press the BACK button on the remote control.

[113] Troubleshooting

Broadcast reception

Check these things first to troubleshoot your TV reception.

Block noise or an error message appears and you cannot watch broadcasts.

Ghosting or double images appear.

Only snow noise or a black picture appears on the screen.

There is picture or sound noise when viewing an analog TV channel.

Some channels are blank.

Poor reception or poor picture quality with digital broadcasts.

You cannot view digital channels.

You cannot receive or select channels.

Some digital cable channels are not displayed.

Broadcast HD formats have poor quality.

[114] Troubleshooting | Broadcast reception

Check these things first to troubleshoot your TV reception.

- Make sure that the antenna cable is firmly connected to the TV.
 - Make sure that the antenna cable is not loose or disconnected.
 - Make sure that the cable or cable connector of antenna is not damaged.
-

[115] Troubleshooting | Broadcast reception

Block noise or an error message appears and you cannot watch broadcasts.

- Make sure that the antenna cable is connected to the correct ports (at the TV/connected devices/wall).
 - Make sure that the cable is not old or that the inside of the connector is not short-circuited.
-

[116] Troubleshooting | Broadcast reception

Ghosting or double images appear.

- Check cable or antenna connections.
- Check the antenna location and direction.
- Press the ACTION MENU button, then select [Picture adjustments] — [Advanced settings] — [Motion] — [Motionflow] — [Standard] or [Off].
(For [Motionflow] compatible models only)

[Motionflow] compatible models have [Motionflow] in [Settings] — [Picture & Display] — [Picture adjustments] — [Advanced settings] — [Motion].

Related topics

- [Distorted picture.](#)
- [Check these things first to troubleshoot your TV reception.](#)

[117] Troubleshooting | Broadcast reception

Only snow noise or a black picture appears on the screen.

- Check if auto tuning is performed.
- Check if the antenna is broken or bent.
- Check if the antenna has reached the end of its serviceable life (3-5 years for normal use, 1-2 years at a seaside location).

Related topics

- [Check these things first to troubleshoot your TV reception.](#)

[118] Troubleshooting | Broadcast reception

There is picture or sound noise when viewing an analog TV channel.

- Check the [Analog channel adjustment] settings.

Press the HOME button, then select [Settings] — [Channels] — [Channel setup] — [Cable/Antenna] — [Analog channel adjustment].

- Perform [Fine tune] to obtain better picture and sound reception. (Option name differs depending on your region/country.)
- Set [Audio filter] to [Off], [Low] or [High] to improve sound for analog reception.
- Make sure that the antenna is connected using a high quality 75-ohm coaxial cable.
- Keep the antenna cable away from other connecting cables.

Related topics

- [Check these things first to troubleshoot your TV reception.](#)

[119] Troubleshooting | Broadcast reception

Some channels are blank.

- The channel is for scrambled/subscription service only. Subscribe to a pay TV service.
- The channel is used only for data (no picture or sound).
- Contact the broadcaster for transmission details.

Related topics

- [Check these things first to troubleshoot your TV reception.](#)

[120] Troubleshooting | Broadcast reception

Poor reception or poor picture quality with digital broadcasts.

- Change the position, direction and angle of the terrestrial television antenna to maximize the antenna signal level. Make sure that the direction of the antenna is not changed unintentionally (such as by wind).
- If you are using a TV signal booster, adjust its signal gain.
- If equipment (such as a TV signal distributor) is connected between the antenna and the TV, it may affect the TV reception. Directly connect the antenna and the TV to check if the reception is improved.

Related topics

- [Check these things first to troubleshoot your TV reception.](#)

[121] Troubleshooting | Broadcast reception

You cannot view digital channels.

- Ask a local installer if digital transmissions are provided in your area.
- Upgrade to a higher gain antenna.

Related topics

- [Check these things first to troubleshoot your TV reception.](#)
- [You cannot receive or select channels.](#)
- [Some digital cable channels are not displayed.](#)

[122] Troubleshooting | Broadcast reception

You cannot receive or select channels.

- Perform [Auto program] to add receivable channels that are not present in the TV memory.
Press the HOME button, then select [Settings] — [Channels] — [Channel setup] — [Cable/Antenna] — [Auto program].
- Check that [Signal type] is set correctly.
Press the HOME button, then select [Settings] — [Channels] — [Channel setup] — [Cable/Antenna] — [Signal type].

[Cable]

Set to receive and select cable channels.

[Antenna]

Set to receive and select antenna channels.

Related topics

- [Some channels are blank.](#)
- [You cannot view digital channels.](#)
- [Some digital cable channels are not displayed.](#)

[123] Troubleshooting | Broadcast reception

Some digital cable channels are not displayed.

- Certain cable companies have limitations on the broadcast of digital cable channels. Check with

your cable company for more information.

- The digital cable channel may be set to [Hidden] in [Show/Hide channels].

Related topics

- [Check these things first to troubleshoot your TV reception.](#)
- [You cannot view digital channels.](#)

[124] Troubleshooting | Broadcast reception

Broadcast HD formats have poor quality.

- Content and signal quality are regulated by the signal provider. Many HD channels and content are actually upscaled versions of standard-definition broadcasts. The picture is affected by the quality of the signal received, which varies between channel and program.

Related topics

- [Check these things first to troubleshoot your TV reception.](#)

[125] Troubleshooting

Sound

[No sound but good picture.](#)

[Audio noise.](#)

[No audio or low audio with a home theater system.](#)

[Distorted sound.](#)

[Headphone volume cannot be adjusted.](#)

[126] Troubleshooting | Sound

No sound but good picture.

- Check the volume control.
- Press MUTING or VOL + button to cancel muting.

Press the ACTION MENU button, then select [Speakers] — [TV speakers].

If it is set to [Audio system], the TV speakers only output key tones or system sounds.

Related topics

- [No audio or low audio with a home theater system.](#)

[127] Troubleshooting | Sound

Audio noise.

- Make sure that the antenna is connected using a high quality 75-ohm coaxial cable.
- Keep the antenna cable away from other connecting cables.
- To avoid TV interference, make sure to use an undamaged antenna cable.

Related topics

- [Distorted sound.](#)

[128] Troubleshooting | Sound

No audio or low audio with a home theater system.

- Press the ACTION MENU button, then select [Speakers] — [Audio system].
- Set [Headphone/Audio out] to [Audio out (Fixed)] in the [Sound] setting.
- Depending on your model, if [Speakers] is set to [TV speakers] and [Hi Res upscaling (DSEE HX)] is set to [Auto], DIGITAL AUDIO OUT (OPTICAL) is muted.
- Set [Digital audio out volume] to Max in the [Sound] setting.
- When using HDMI input with Super Audio CD or DVD-Audio, DIGITAL AUDIO OUT (OPTICAL) may not provide an audio signal.

Related topics

- [Audio noise.](#)
- [Connecting an audio system](#)

Distorted sound.

- Check the antenna/cable connection.
- Keep the antenna/cable away from other connecting cables.
- Keep the TV away from electrical noise sources such as cars, hair-dryers, Wi-Fi units, mobile phones, or optical devices.
- When installing an optional device, leave some space between the device and TV.
- Set [Audio filter] to [Low] or [High] to improve sound for analog reception. ([Audio filter] may not be available depending on your region/country.)

Related topics

- [Audio noise.](#)

Headphone volume cannot be adjusted.

- If you cannot adjust the headphone volume with the VOL +/- buttons, press the ACTION MENU button and select [Headphone volume]

Network (Internet/home)/apps

The network name (SSID) of the wireless router (access point) to which you want to connect is not displayed.

Sometimes video streaming quality is poor.

Wi-Fi connection is lost or intermittent.

Certain Internet video content displays a loss of detail.

Good picture quality but no sound on Internet video content.

Apps are inaccessible.

The TV cannot access the Internet when IPv6 is set.

Your TV cannot connect to the server.

A message appears stating that the TV cannot connect to your network.

You can connect to the Internet, but not to Google services.

You cannot add a Google account.

[132] Troubleshooting | Network (Internet/home)/apps

The network name (SSID) of the wireless router (access point) to which you want to connect is not displayed.

- Reset the wireless router.
- Select **[[Manual entry]]** to enter a network name (SSID).

[133] Troubleshooting | Network (Internet/home)/apps

Sometimes video streaming quality is poor.

- Quality depends on the original video provided by the video content provider and your connection bandwidth.
- The wireless network connection quality varies depending on the distance or obstacles (e.g., wall) between the TV and the wireless router (access point), environmental interference, and the quality of the wireless router (access point). In this case, use a wired connection for the Internet, or try the 5GHz band.
- The 5GHz band may not be supported depending on your region/country. If the 5GHz band is not supported, the TV can only connect to a wireless router (access point) using the 2.4GHz band.

Related topics

- [Connecting to a network using a LAN cable](#)
- [Using Wi-Fi to connect the TV to your network](#)

[134] Troubleshooting | Network (Internet/home)/apps

Wi-Fi connection is lost or intermittent.

- Check the installation location of the TV and wireless router (access point). Signal condition may be affected by the following :

- Other wireless devices, microwaves, fluorescent lights, etc., are placed nearby.
- There are floors or walls between the wireless router (access point) and TV.

If the problem persists even after checking the above, try using a wired LAN connection.

Related topics

- [Using Wi-Fi to connect the TV to your network](#)

[135] Troubleshooting | Network (Internet/home)/apps

Certain Internet video content displays a loss of detail.

- Video quality and picture size depend on broadband speed and delivery by video content providers.

Related topics

- [Connecting to a network using a LAN cable](#)
- [Using Wi-Fi to connect the TV to your network](#)
- [Sometimes video streaming quality is poor.](#)

[136] Troubleshooting | Network (Internet/home)/apps

Good picture quality but no sound on Internet video content.

- Quality depends on the original content provided by the video content provider and your connection bandwidth.
- Due to the nature of Internet video, not all videos will contain sound.

Related topics

- [Connecting to a network using a LAN cable](#)
- [Using Wi-Fi to connect the TV to your network](#)

[137] Troubleshooting | Network (Internet/home)/apps

Apps are inaccessible.

- Check that the LAN cable or AC power cord (mains lead) of the router/modem * has been connected properly.

* Your router/modem must be set in advance to connect to the Internet. Contact your Internet service provider for router/modem settings.

- Try using apps later. The app content provider's server may be out of service.

Related topics

- [Connecting to a network using a LAN cable](#)
- [Using Wi-Fi to connect the TV to your network](#)

[138] Troubleshooting | Network (Internet/home)/apps

The TV cannot access the Internet when IPv6 is set.

- IPv6 may not be supported, in which case set IPv6 to off.
 - Press the HOME button, then select [Settings] — [Network] — [Advanced settings] — [IPv6 setup] — [No].

[139] Troubleshooting | Network (Internet/home)/apps

Your TV cannot connect to the server.

- Check the LAN cable or wireless connection to your server and your TV.
- Check if your network is properly configured on your TV.
- Check your LAN cable/wireless connection or your server. The TV may have lost connection with the server.
- Perform [Server diagnostics] to check if your media server is properly communicating with the TV. Press the HOME button, then select [Settings] — [Network] — [Home network] — [Server diagnostics].

Related topics

- [Home network features](#)

- [A message appears stating that the TV cannot connect to your network.](#)

[140] Troubleshooting | Network (Internet/home)/apps

A message appears stating that the TV cannot connect to your network.

- Check the current network settings and perform [Check Connection].
Press the HOME button, then select [Settings] — [Network] — [Advanced settings] — [Network status] — [Check Connection].
Check your network connections and/or server's instruction manual for connection information, or contact the person who set up the network (network administrator).
- Reconfigure your network settings by pressing the HOME button, then select [Settings] — [Network] — [Network setup].
- If the LAN cable is connected to an active server and the TV has acquired an IP address, check your server's connections and configurations. Press the HOME button, then select [Settings] — [Network] — [Advanced settings] — [Network status].

Related topics

- [Your TV cannot connect to the server.](#)

[141] Troubleshooting | Network (Internet/home)/apps

You can connect to the Internet, but not to Google services.

- The date and time settings of this TV may be incorrect. Depending on the app such as Google Play or YouTube, you may not be able to connect to Google services if the time is incorrect.
Press the HOME button, then select [Settings] — [Date & time] — [Automatic date & time] — [Use network time] to automatically adjust the time through the network.

[142] Troubleshooting | Network (Internet/home)/apps

You cannot add a Google account.

Only one Google account can be registered at a time. To log in with another Google account, you must remove the registered account.

To log in with another account

- 1 Press the HOME button, then select [Settings] — [Google] — [Remove account].
- 2 Remove the current Google account and then add another account.

[143] Troubleshooting

Remote control/accessories

The remote control does not operate.

You cannot turn the Active 3D Glasses on. (3D models only)

The LED indicator on the Active 3D Glasses blinks. (3D models only)

[144] Troubleshooting | Remote control/accessories

The remote control does not operate.



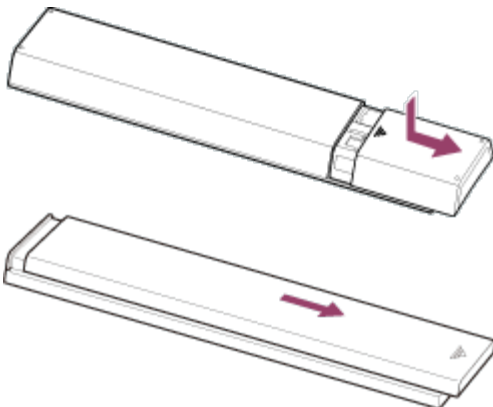

- Press a button on the TV to determine if the problem is with the remote control or not.
- Check that the orientation of each battery matches the positive (+) and negative (-) symbols in the battery compartment.
- Battery power may be low. Remove the remote control cover and replace the batteries with new ones.

– **Sliding type**

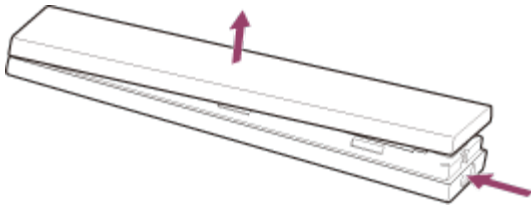

– **Push-release type**



- There may be poor contact between the battery and the remote control. Remove the batteries, then insert them again.
- Point the remote control at the remote control sensor located at the front of the TV.
- Keep the remote control sensor area clear from obstacles.
- Fluorescent light can interfere with remote control operation; try turning off any fluorescent light.
- When you unplug the TV and plug it in again, the TV may not be able to turn on for a while, even if you press the power button on the remote control or the TV. This is because it takes time to initialize the system. Wait for about 10 to 20 seconds, then try again.
- When your voice is not being recognized, make sure to activate the  button on the remote control with the  button, or register the remote control with the  button to your TV. To confirm these settings, press the HOME button, then select [Settings] — [Voice Remote Control]. The  button may not be available depending on your supplied remote control.

[145] Troubleshooting | Remote control/accessories

You cannot turn the Active 3D Glasses on. (3D models only)

- Replace the battery. (Applies only to TDG-BT400A/BT500A.)

1 Press the unlock button with the tip of a pen, etc., and take out the battery case.

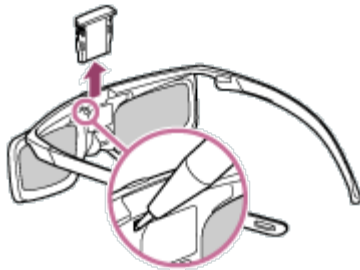

2 Replace the battery with a new one. After that, be sure to insert the battery case until it locks in place again.

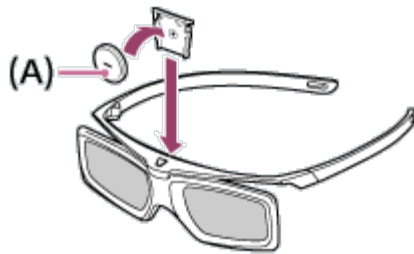

(A) CR2025 (-) side

[146] Troubleshooting | Remote control/accessories

The LED indicator on the Active 3D Glasses blinks. (3D models only)

- Lights up for 3 seconds: Indicates when turning on the glasses.



- Blinks every 2 seconds: Indicates the glasses are powered on.
- Blinks 3 times: Indicates the glasses have been powered off.
- Blinks green and yellow alternately: Indicates the glasses have started the registration process.
- Blinks 3 times every 2 seconds: Indicates the battery capacity is almost running out. Replace the battery.

Related topics

- [You cannot turn the Active 3D Glasses on. \(3D models only\)](#)

[147] Troubleshooting

Power

The TV turns off automatically.

The TV turns on automatically.

After unplugging the TV and plugging it in again, the TV does not turn on even if you press the power button on the remote control or the TV.

The TV turns off automatically.

- The screen may have been turned off due to [Sleep timer] settings.
- Check the [Duration] setting of [Timer].
- Check if [Idle TV standby] in [Eco] is activated.
- The screen may have been turned off due to [Daydream] settings.
- (Except for Brazilian models) Check if [Auto shut-off] in [Eco] is activated.

Related topics

- [Setting a timer](#)

The TV turns on automatically.

- Check if [Timer] is activated.
- Disable the [TV auto power on] setting in [BRAVIA Sync settings].

Related topics

- [BRAVIA Sync-compatible devices](#)
- [Setting a timer](#)

After unplugging the TV and plugging it in again, the TV does not turn on even if you press the power button on the remote control or the TV.

- When you unplug the TV and plug it in again, the TV may not be able to turn on for a while, even if you press the power button on the remote control or the TV. This is because it takes time to initialize the system. Wait for about 10 to 20 seconds, then try again.

Connected devices

No picture from a connected device.

You cannot select a connected device in the Home Menu.

Certain programs on digital sources display a loss of detail.

Photo images or folders take time to display.

You cannot find a connected BRAVIA Sync HDMI device.

You cannot control a second AV receiver.

An external device (such as a set-top box or AV receiver) cannot be controlled via the IR Blaster. (IR Blaster compatible models only)

Some media files in the USB device or server are not displayed.

The TV cannot be found by a Wi-Fi Direct device.

Operation cuts out, or a device does not work.

What kind of devices can be connected using the Screen mirroring function?

The TV cannot connect to a Miracast device or Screen mirroring compatible device.

Video or sound sometimes cuts out.

Some paid content cannot be played.

The TV cannot be turned on and controlled by using the “Video & TV SideView” app when [Remote start] is enabled.

The TV does not appear on or cannot be registered with the “Video & TV SideView” app.

No picture from a connected device.

- Turn the connected device on.
- Check the cable connection between the device and TV.
- Press the INPUT button to display the list of inputs, then select the desired input
- Correctly insert the USB device.
- Make sure that the USB device has been properly formatted.
- Operation is not guaranteed for all USB devices. Also, operations differ depending on the USB device features or the video files being played.
- If the connected device is connected to HDMI IN 2 or 3, connect it to HDMI IN 1 or 4.

- Change the HDMI signal format of the HDMI input that does not display a picture to standard format. Press the HOME button, then select [Settings] — [External inputs] — [HDMI signal format].

Related topics

- [Using the TV with Other Devices](#)

[153] Troubleshooting | Connected devices

You cannot select a connected device in the Home Menu.

- Check the cable connection.

Related topics

- [Using the TV with Other Devices](#)

[154] Troubleshooting | Connected devices

Certain programs on digital sources display a loss of detail.

- Less detail than usual or artifacts (small blocks, dots or pixelation) may appear on the screen, due to the digital compression of the source content used by certain digital broadcasts and DVDs. The degree of visible artifacts depends on the clarity and resolution of the TV.

[155] Troubleshooting | Connected devices

Photo images or folders take time to display.

- Depending on the image dimension, file size, and number of files in a folder, some photo images or folders take time to display.
- Each time a USB device is connected to the TV, it may take up to a couple of minutes for the photos to display.

Related topics

- [No picture from a connected device.](#)

[156] Troubleshooting | Connected devices

You cannot find a connected BRAVIA Sync HDMI device.

- Check that your device is BRAVIA Sync-compatible.
- Make sure that [Control for HDMI] is set up on the BRAVIA Sync-compatible device and [BRAVIA Sync settings] — [BRAVIA Sync control] is set up on the TV.

Related topics

- [BRAVIA Sync-compatible devices](#)

[157] Troubleshooting | Connected devices

You cannot control a second AV receiver.

- Only one BRAVIA Sync-compatible AV receiver can be used.

Related topics

- [BRAVIA Sync-compatible devices](#)

[158] Troubleshooting | Connected devices

An external device (such as a set-top box or AV receiver) cannot be controlled via the IR Blaster. (IR Blaster compatible models only)

IR Blaster compatible models have [IR Blaster setup] in [Settings] — [External inputs].

- Make sure that the IR Blaster is correctly set up and the IR transmitter is located near the IR receiver of the external device.

- Make sure that your TV supports the external device.
- If you press and hold a button on the remote control, the operation may not be transmitted. Instead, press the button repeatedly.
- Some external devices may not respond to some buttons on the “Action Menu”.
- (Except for Brazilian models) The IR Blaster may not be set properly. To set the IR Blaster, press the HOME button, then select [Settings] — [External inputs] — [IR Blaster setup].

Related topics

- [Connecting an IR Blaster \(IR Blaster compatible models only\)](#)

[159] Troubleshooting | Connected devices

Some media files in the USB device or server are not displayed.

- Unsupported files may not be displayed.
- All the folders/files may not be displayed depending on the system status.

Related topics

- [Supported files and formats](#)

[160] Troubleshooting | Connected devices

The TV cannot be found by a Wi-Fi Direct device.

- Enable [Wi-Fi Direct]. Press the HOME button, then select [Settings] — [Network] — [Wi-Fi Direct] — [Wi-Fi Direct].
- If the TV cannot be found even though [Wi-Fi Direct] is enabled, set [Band setting] to [Auto (2.4GHz band)]. Press the HOME button, then select [Settings] — [Network] — [Wi-Fi Direct] — [Advanced settings] — [Band setting] — [Auto (2.4GHz band)].

[161] Troubleshooting | Connected devices

Operation cuts out, or a device does not work.

- Check if the device is turned on.
- Replace the batteries of the device.
- Re-register the device.
- Bluetooth devices use the 2.4GHz band, therefore communication speed may deteriorate or cut out occasionally due to wireless LAN interference.

If household electric appliances (e.g., microwaves or mobile devices) are placed nearby, radio wave interference is more likely to happen.

- The TV or device may not work on a metal rack due to wireless communication interference.
- For usable communication distances between the TV and other devices, refer to the instruction manuals of the devices.
- When multiple Bluetooth devices are connected to the TV, the quality of Bluetooth communication may deteriorate.

Related topics

- [Bluetooth devices](#)

[162] Troubleshooting | Connected devices

What kind of devices can be connected using the Screen mirroring function?

- Wi-Fi enabled devices, such as smartphones and tablets, that support Miracast can be used to enjoy Screen mirroring on your BRAVIA TV. Refer to the instruction manual of your Wi-Fi device to find out if it supports Miracast. BRAVIA TV complies with the Miracast specification, but does not guarantee a successful connection with all devices.

[163] Troubleshooting | Connected devices

The TV cannot connect to a Miracast device or Screen mirroring compatible device.

- If connecting a Miracast device (e.g., laptop) fails, press the HOME button, then select [Screen mirroring] to show the standby screen for the Screen mirroring function and try to connect again.
- If you are using Screen mirroring with another device, turn off Screen mirroring first and try again.
- If your device does not support 5GHz and you set the [Band setting] option to [Auto (5GHz band)],

try changing it to [Auto].

Related topics

- [Displaying the screen of a smartphone/tablet on the TV using the Screen mirroring function](#)
- [What kind of devices can be connected using the Screen mirroring function?](#)

[164] Troubleshooting | Connected devices

Video or sound sometimes cuts out.

- Devices emitting radio waves, such as other wireless LAN devices or microwave ovens, may interfere with the Screen mirroring function using wireless LAN. Keep the TV or Sony Screen mirroring compatible devices (e.g., some models of Xperia) away from such devices, or turn them off if possible.
- Communication speed may change according to the distance or obstacles between devices, device configuration, radio wave condition, line congestion or the device you use. Communication may cut out due to the radio wave condition.

Related topics

- [Displaying the screen of a smartphone/tablet on the TV using the Screen mirroring function](#)
- [Using Wi-Fi to connect the TV to your network](#)

[165] Troubleshooting | Connected devices

Some paid content cannot be played.

- The source device needs to meet HDCP (High-bandwidth Digital Content Protection) 2.0/2.1/2.2 standards.
Some pay contents may not be displayed via a source device which does not meet HDCP 2.0/2.1/2.2 standards.

[166] Troubleshooting | Connected devices

The TV cannot be turned on and controlled by

using the “Video & TV SideView” app when [Remote start] is enabled.

- When devices that cause radio wave interference (microwave ovens, cordless phones, etc.) are placed nearby, the “Video & TV SideView” function may not work. In this case, keep such devices away from the wireless router (access point) or TV, or turn them off.
- In the following cases, the “Video & TV SideView” function may not work. Turn on the TV and re-connect to the wireless router (access point).
 - Turn on/off the wireless router (access point) power during TV standby mode
 - Reset the wireless router (access point) during TV standby mode
 - Change the wireless router (access point) channel during TV standby mode
- The “Video & TV SideView” function may not work with business-use wireless routers (access points) that require reconnection periodically.
- The “Video & TV SideView” function may not work depending on the settings of the wireless router (access point) (e.g., Multi SSID and Power saving mode).
- If Wi-Fi Direct is used to connect the “Video & TV SideView” app to the TV, the TV may not be turned on from standby mode depending on your mobile device.
- The TV should be in the power-on or standby mode. Do not turn off the TV by disconnecting its AC power cord (mains lead).
- Check that the following has been set for your TV.

When the wireless router (access point) and TV are connected with wireless LAN

 - Built-in wireless LAN model TV is used
 - [Built-in Wi-Fi] under [Settings] — [Network] — [Advanced settings] is enabled
 - [Remote start] under [Settings] — [Network] is enabled
 - TV is connected to the wireless router (access point)

When the wireless router (access point) and TV are connected with wired LAN

 - [Remote start] under [Settings] — [Network] is enabled

Related topics

- [Using the “Video & TV SideView” app with your smartphone/tablet](#)

[167] Troubleshooting | Connected devices

The TV does not appear on or cannot be registered with the “Video & TV SideView” app.

- Make sure that the TV is turned on.
- Make sure that the TV and your mobile device have joined the same home network.
(However, when connecting via Wi-Fi Direct, a home network connection is not necessary.)
- The maximum number of registration devices may have been reached. Delete unnecessary registrations from [Remote devices] before registering another mobile device. Press the HOME button, then select [Settings] — [Network] — [Home network] — [Remote device/Renderer] — [Remote devices].
- For detailed information, refer to the following website:
<http://info.tvsideview.sony.net/faq/>

Related topics

- [Using the “Video & TV SideView” app with your smartphone/tablet](#)

[168] Troubleshooting

Illumination LED

The illumination LED or bottom of the screen sometimes lights up.

You want to disable the illumination LED so that it does not light up or blink.

[169] Troubleshooting | Illumination LED

The illumination LED or bottom of the screen sometimes lights up.

The illumination LED or the bottom of the screen lights up at various times such as during software updates or when a smartphone is detected on a home network. It does not mean that the TV is malfunctioning or defective.

Refer to [Identifying the status of the TV through illumination](#) for details.

[170] Troubleshooting | Illumination LED

You want to disable the illumination LED so that it does not light up or blink.

You can turn it off. Press the HOME button, then select [Settings] — [Illumination LED] — [Off].

Note

- We recommend that you do not change this setting under normal circumstances because you will be unable to identify whether the TV is on or off, or a timer is set.

[171]

Index

TV programs

- [DISCOVER](#)
- [GUIDE](#)
- [Interactive broadcasts](#)
- [Channels](#)
- [Parental lock](#)

Picture/display

- [3D](#)
- [4K pictures](#)
- [HOME](#)
- [Picture & Display](#)
- [Date & time](#)
- [Language](#)
- [Expert panel settings](#)
- [Pixel shift](#)
- [Panel refresh](#)

Sound/voice

- [Voice search, using](#)
- [Sound](#)
- [Speech recognition](#)

Remote control

- [Remote control, using](#)
- [Voice search](#)
- [HOME](#)
- [DISCOVER](#)
- [ACTION MENU](#)
- [Inputs](#)
- [SYNC MENU](#)

Connections

- [Google Cast](#)
- [Miracast](#)
- [Screen mirroring](#)
- [Wi-Fi Direct](#)
- [Bluetooth](#)
- [BRAVIA Sync](#)
- [Internet](#)

External devices

- [Blu-ray/DVD players, connecting](#)
- [USB memory devices, etc.](#)
- [Smartphones/tablets](#)
- [Computers](#)
- [Digital cameras, camcorders](#)
- [Audio systems](#)
- [Wireless subwoofer](#)

Apps

- [Video & TV SideView](#)
- [Google Play Store](#)
- [YouTube](#)
- [Moving to USB memory devices](#)
- [Netflix](#)

File playback

- [Computers](#)
- [Digital cameras, camcorders](#)
- [Supported files and formats](#)

Other

- [SNS](#)
 - [Restart](#)
 - [System software update](#)
-