

Area	JAPAN	NORTH AMERICA	LATIN AMERICA	EUROPE	GENERAL AREA	CHINA
Model Name	KDL-55HX950	XBR-55HX950	XBR-55HX950	KDL-55HX950	KDL-55HX955	KDL-55HX950
SV No.	SV-22819(J1)	SV-22809(U2)	SV-22809(LA1)	SV-22828(EEN)	SV-22823(AFI)	SV-22817(CN8)
TV only (WxHxD)	128.0x77.3x4.9(4.7)cm	1280x773x49(47) mm/50 1/2x30 1/2x1 5/16(1 7/8) inch	1280x773x49(47) mm	Approx. 128.0x77.3x4.9(4.7)cm	Approx. 1280x773x49(47) mm	Approx. 1280x773x49(47) mm
TV with Stand (WxHxD)	128.0x82.9x36.9 cm	1280x829x369 mm/50 1/2x32 3/4x14 5/8 inch	1280x829x369 mm	Approx. 128.0x82.9x36.9 cm	Approx. 1280x829x369 mm	Approx. 1280x829x369 mm
Media Receiver (WxHxD)						
Monitor only (WxHxD)						
Monitor with Stand (WxHxD)						
Media Receiver with Stand (WxHxD)						
Satellite Speaker (WxHxD)						
Stand Width	49.0 cm	490 mm / 19 3/8 inch	490 mm	Approx. 49.0 cm	Approx. 490 mm	Approx. 490 mm
VESA Hole Pitch	30.0x30.0 cm	300x300 mm /11 7/8x11 7/8 inch	300x300 mm	30.0x30.0 cm	Approx. 300x300 mm	Approx. 300x300 mm
TV Only	26.7Kg	26.7kg / 58.9lb.	26.7Kg	Approx. 26.7Kg	Approx. 26.7Kg	Approx. 26.7Kg
TV With Stand	29.6Kg	29.6Kg / 65.2lb.	29.6Kg	Approx. 29.6Kg	Approx. 29.6Kg	Approx. 29.6Kg
Media Receiver						
Monitor Only						
Monitor With Stand						
Media Receiver with Stand						
Satellite Speaker						
Remarks						

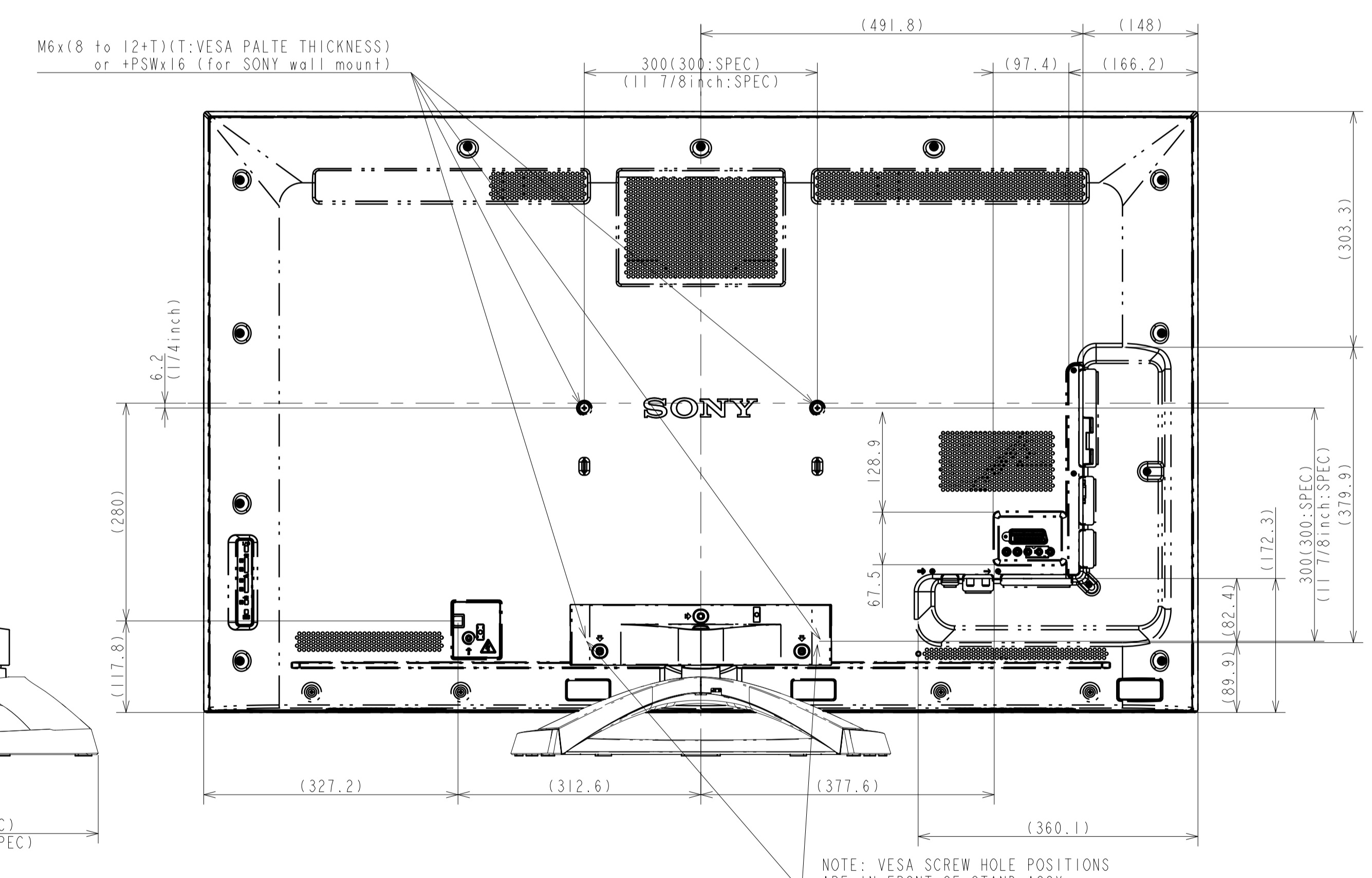

NOTE: VESA SCREW HOLE POSITIONS ARE IN FRONT OF STAND ASSY

UNIT	mm	TOLERANCE	USED ON	RANK
ANGLE				FAMILY
SCALE	1:5			ORIGINAL MODEL
				FINISH/COLOR
FILE/DESCRIPTION				
2b-1W 55 Exterior View				
HISTORY SHEET		ECS-NO.		REVISION
NO.	DATE	BY	CHKD BY	NO.
DESIGN BY	PLANNED BY	CHECKED BY	APPROVED BY	MODEL
				PART NO.
				SHEET
				1/2

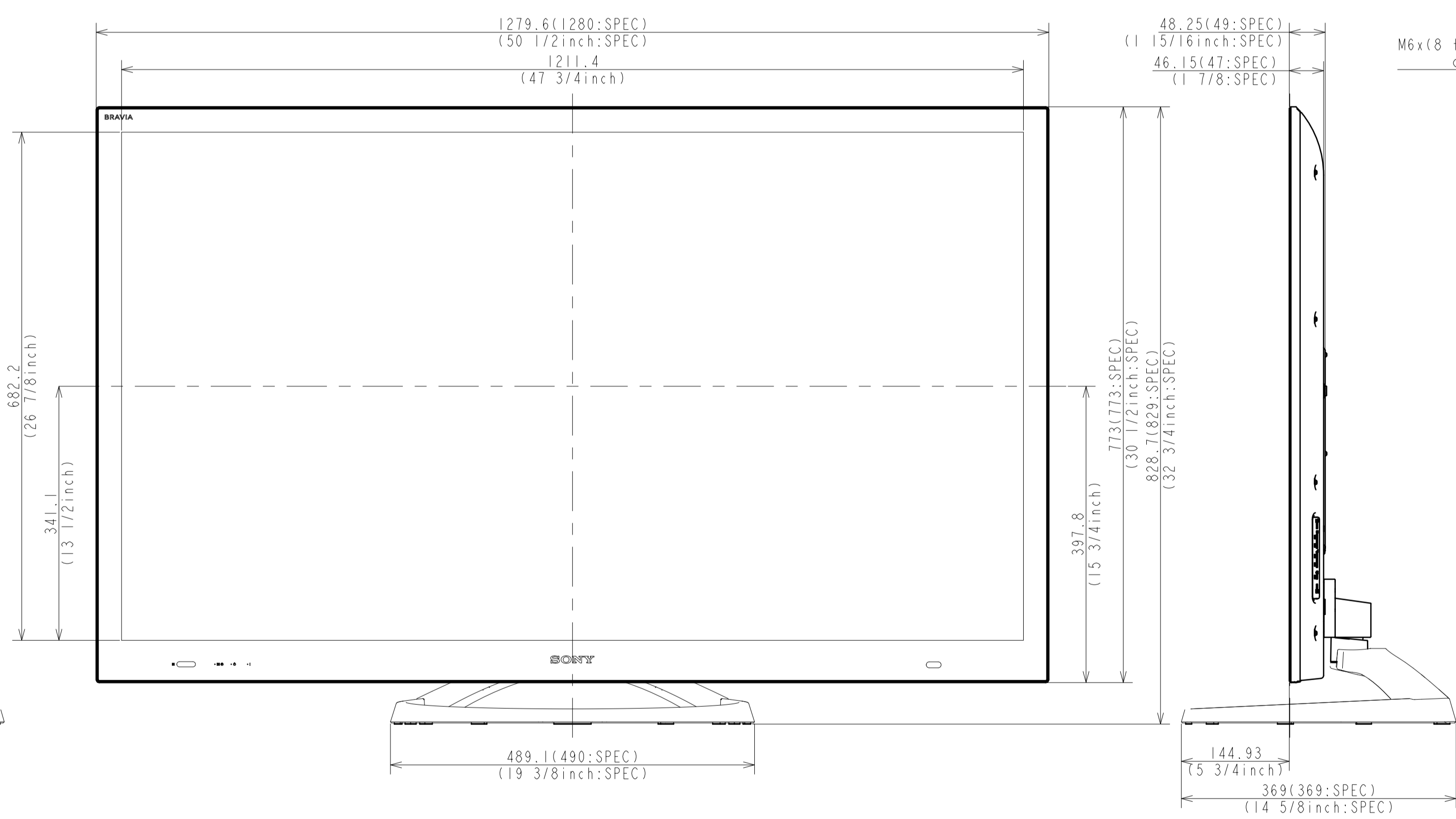
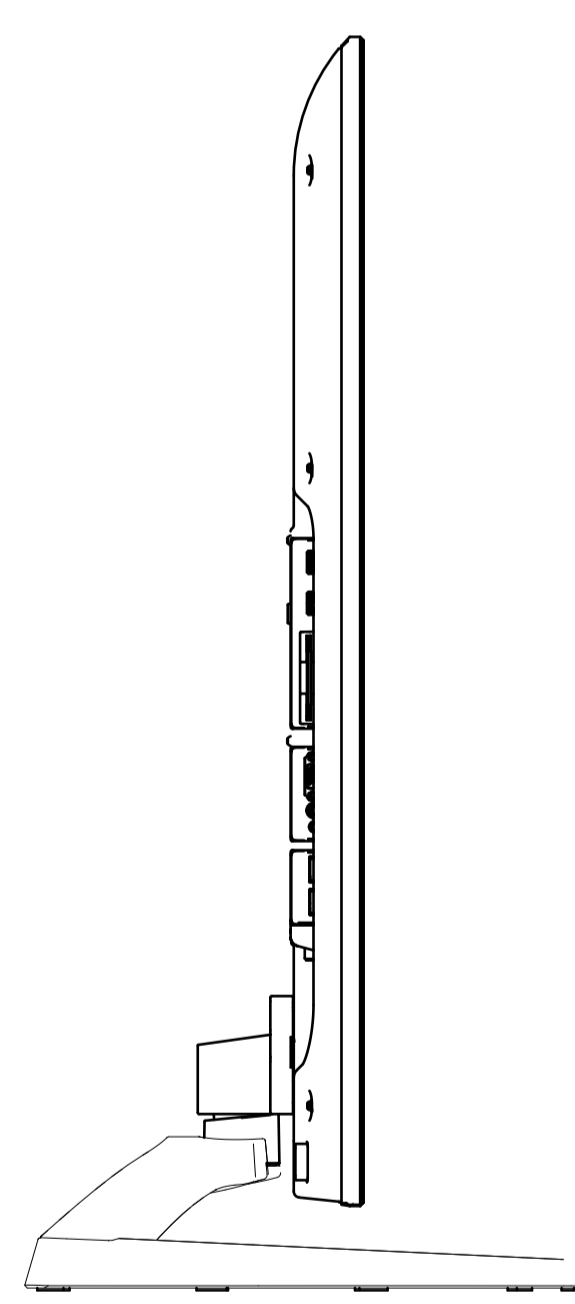
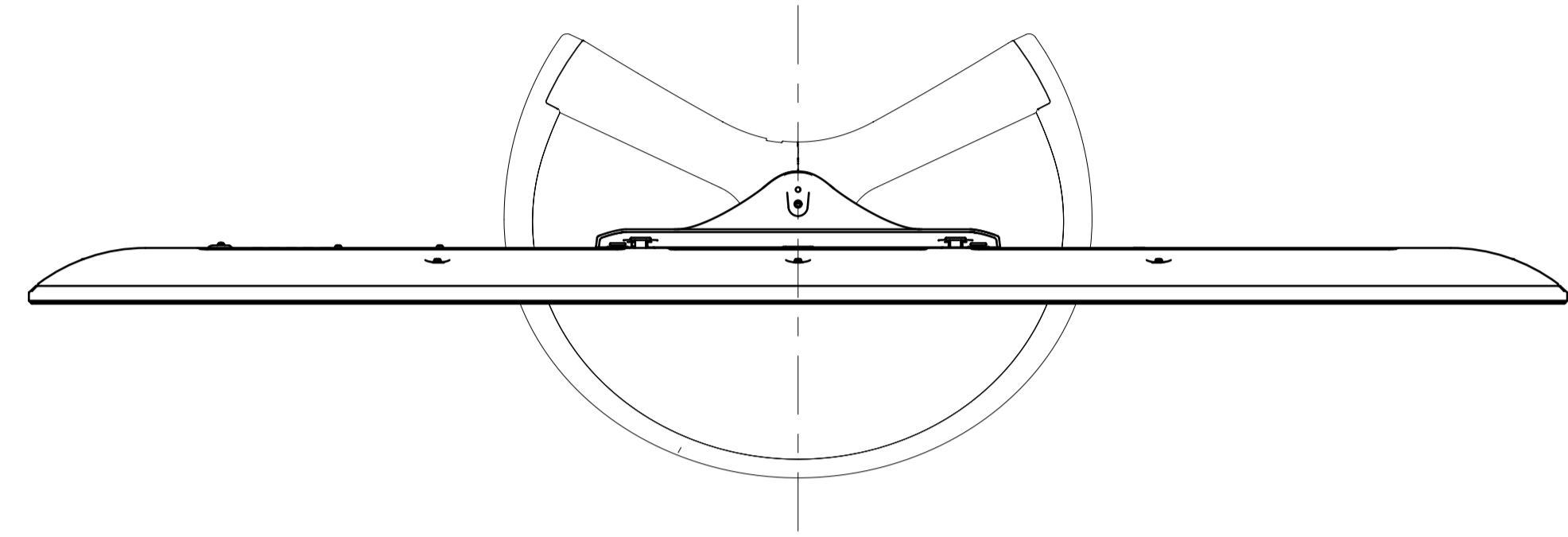
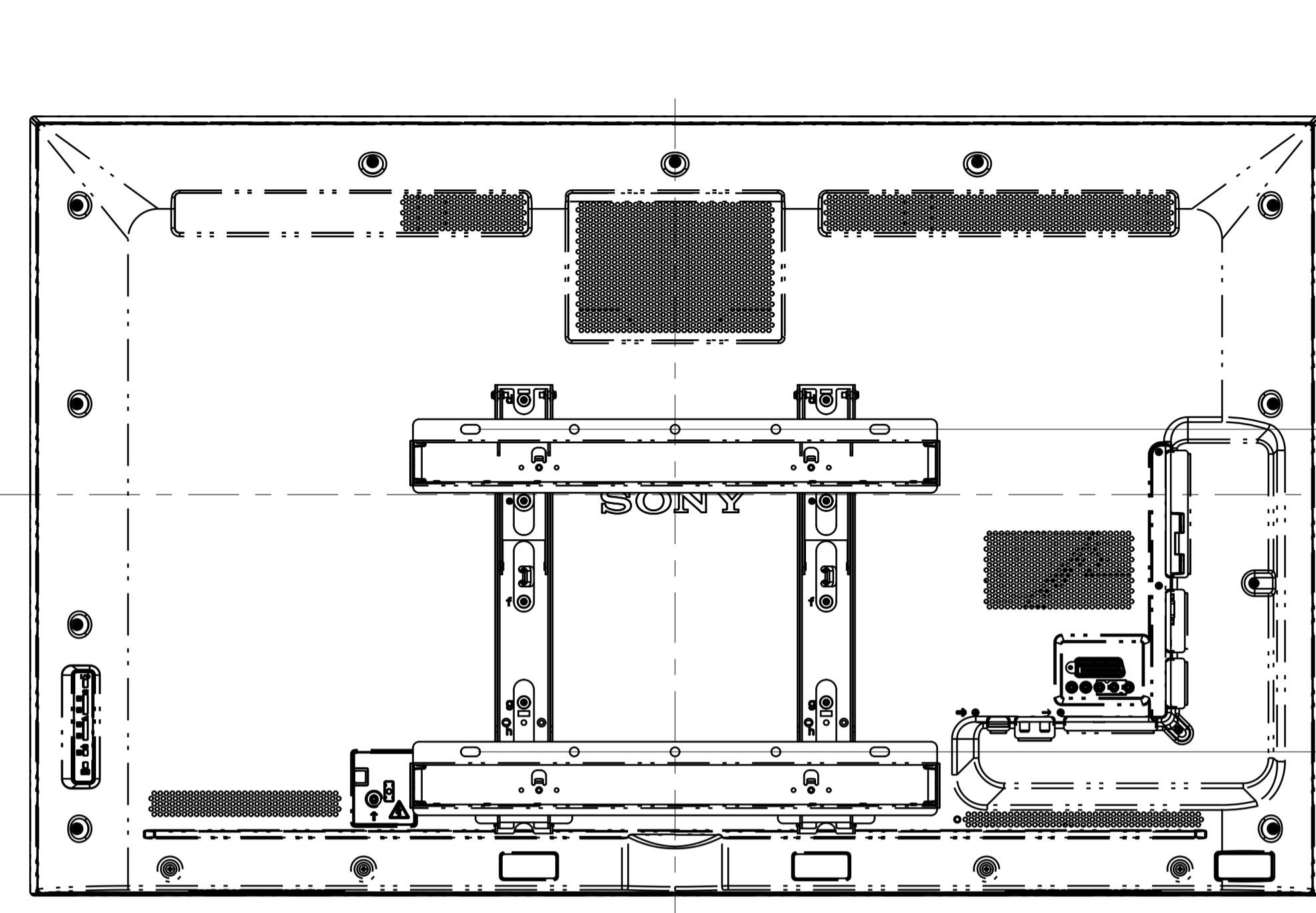

WL-500

106.45(107:SPEC)  
(4 1/4inch:SPEC)

64.8(65:SPEC)  
(2 5/8inch:SPEC)

320(320:SPEC)  
(12 5/8inch:SPEC)

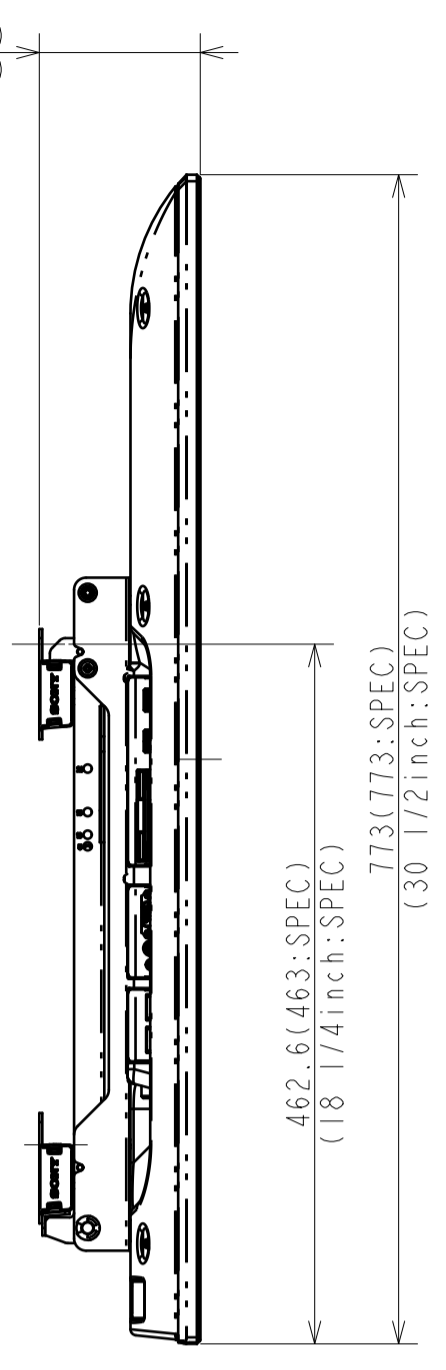

0°

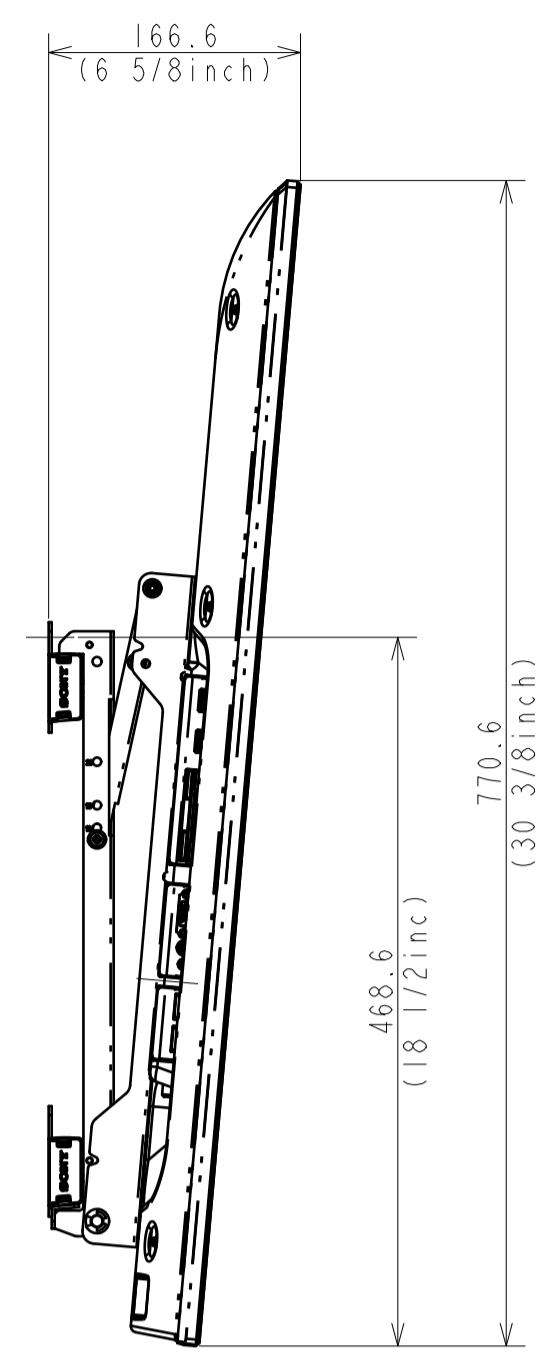

5°

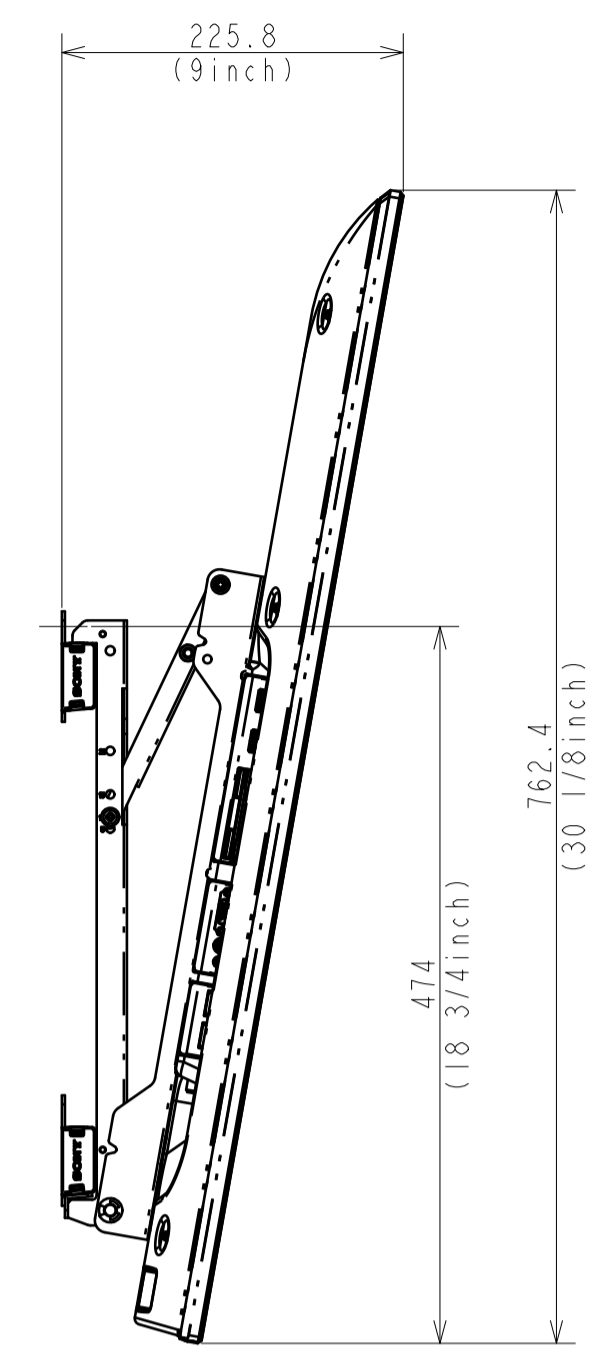

10°

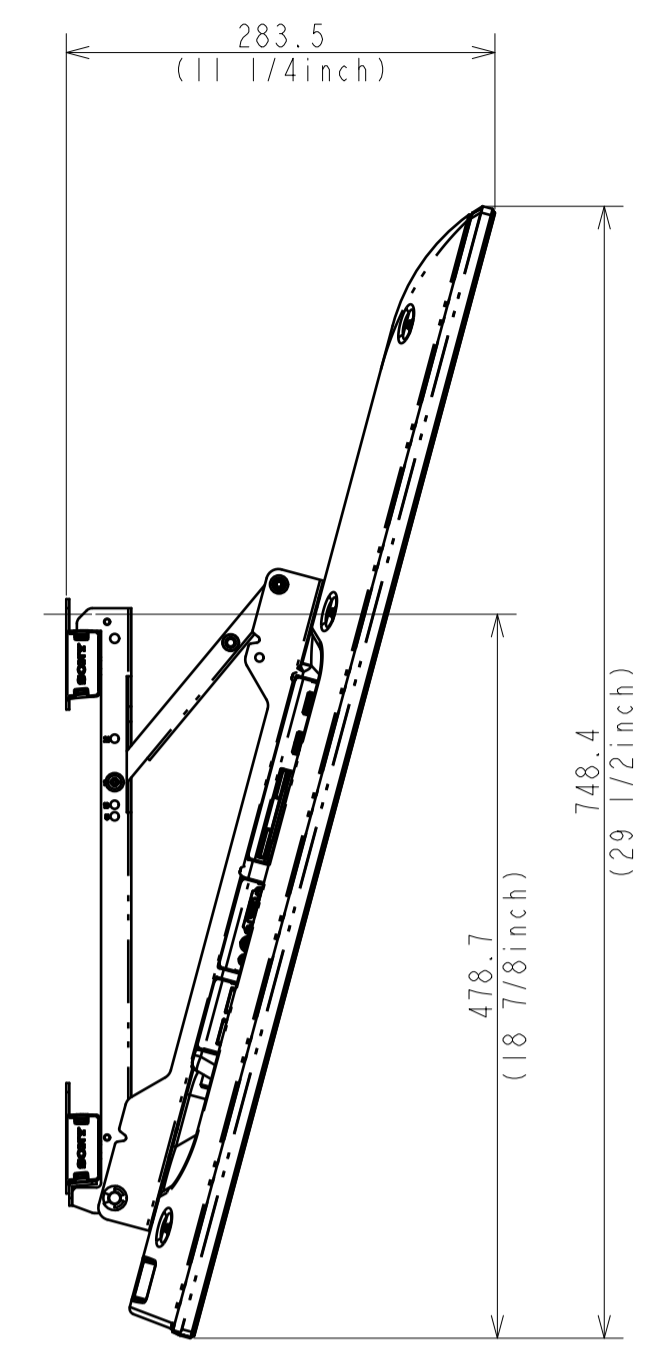

15°

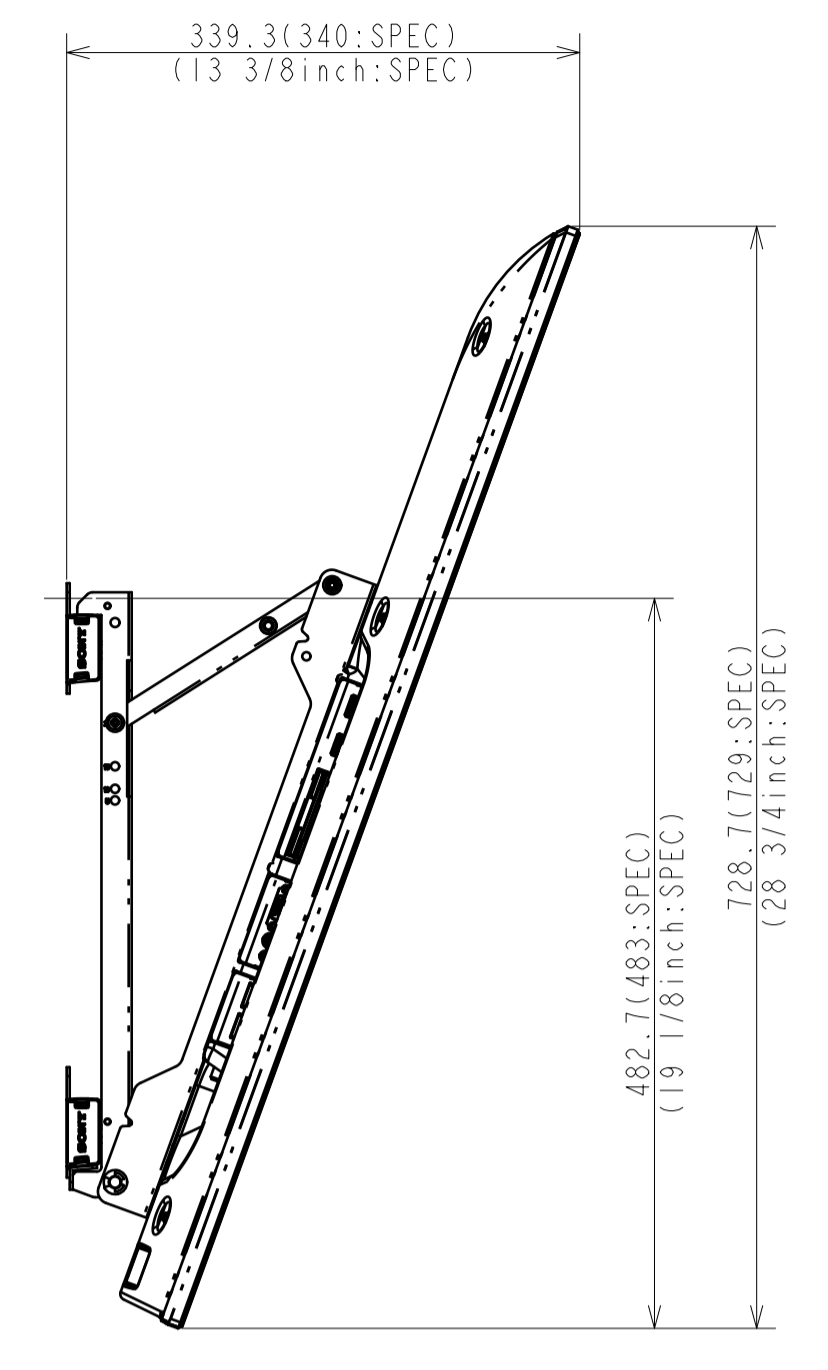

20°

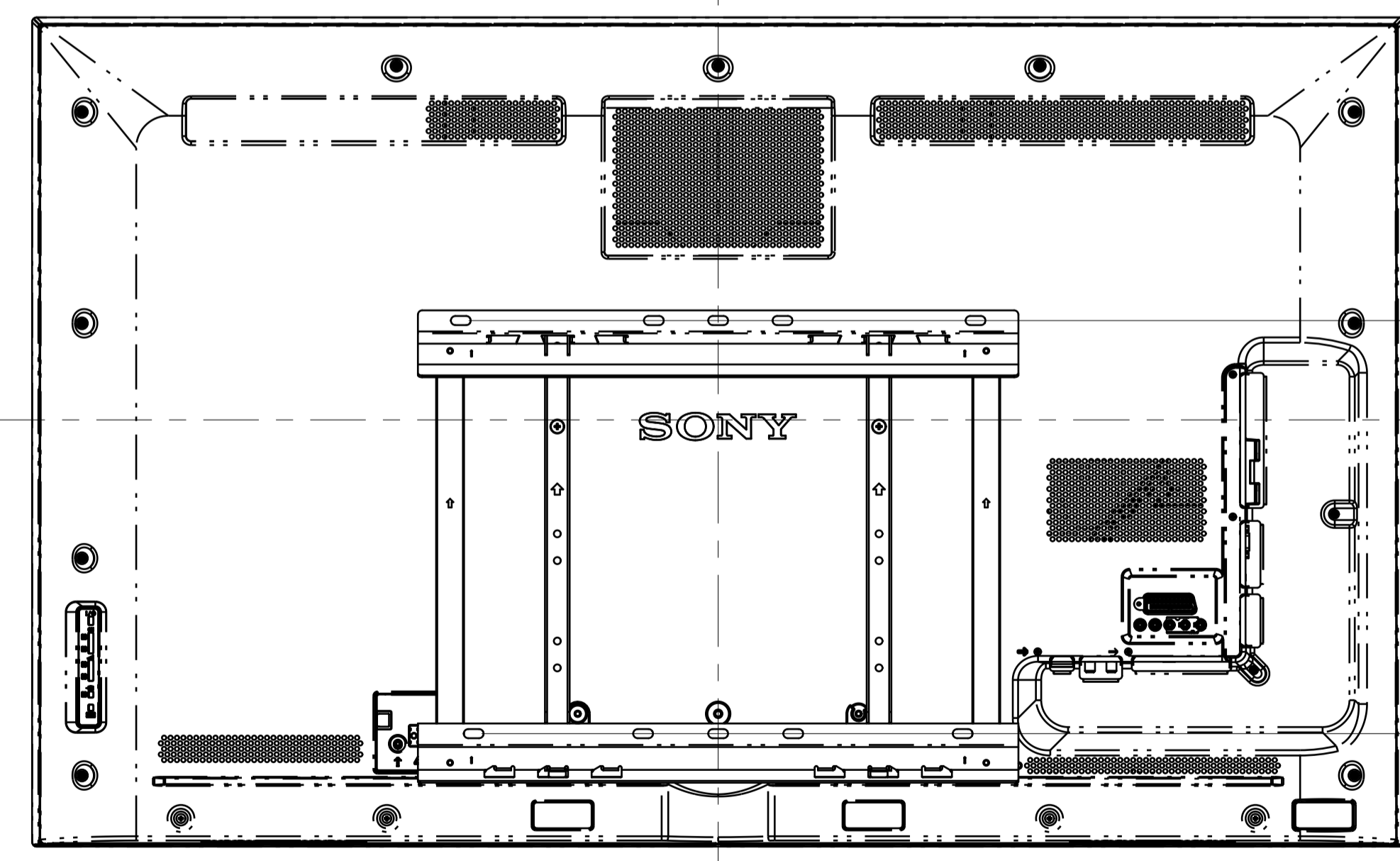

WL-50B

107.4(108:SPEC)  
(4 3/8inch:SPEC)

92.6(93:SPEC)  
(3 3/4inch:SPEC)

385.1(386:SPEC)  
(15 1/4inch:SPEC)

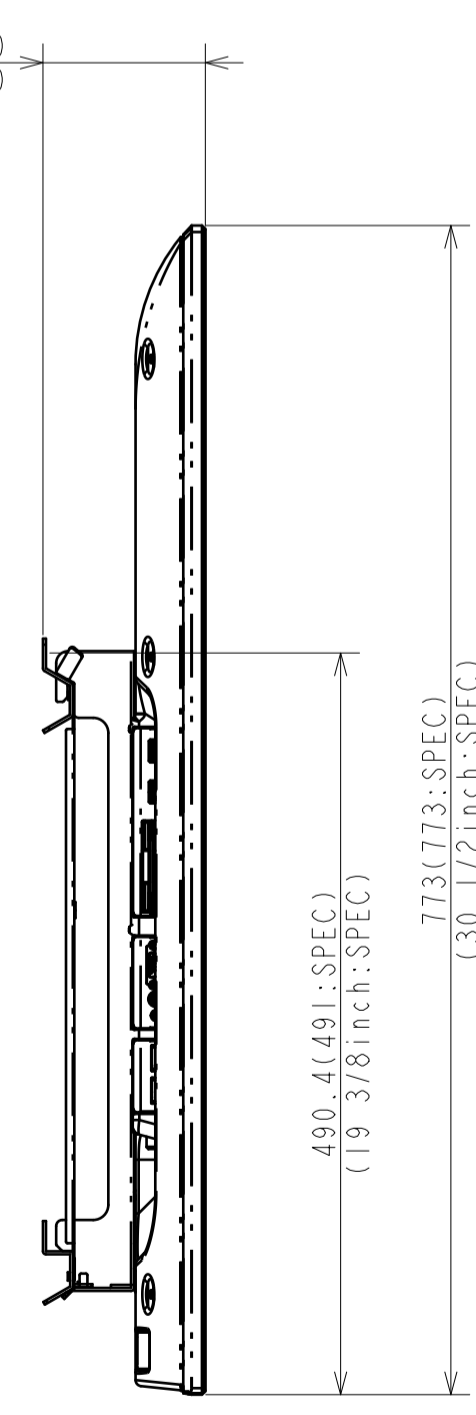

0°