

# Setup Guide

**BRAVIA**

XBR-75X940D / 65X937D / 65X935D / 65X930D / 55X930D

US	Setup Guide
FR	Manuel de configuration
ES	Guía de configuración
PT	Guia de Configuração

**Sony Customer Support**  
 U.S.A.: <http://www.sony.com/tvsupport>  
 Canada: <http://www.sony.ca/support>  
 United States 1.800.222.SONY Canada 1.877.899.SONY  
 Please Do Not Return the Product to the Store

**Service à la clientèle Sony**

Canada : <http://support.sony.ca/fr>  
 États-Unis : <http://www.sony.com/tvsupport>  
 Canada États-Unis  
 1.877.899.SONY 1.800.222.SONY  
 Ne retournez pas le produit au magasin



Lea este manual antes de usar el producto

**Centro de Asistencia de Sony**  
<http://esupport.sony.com/ES/LA/>  
 Llame al número telefónico que aparece en su póliza de garantía.  
 Por favor no devuelva el producto a la tienda donde adquirió el producto.

**Suporte ao Cliente Sony**

<http://esupport.sony.com/BR/>  
 Não devolva o produto à loja

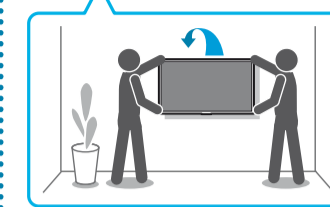

Reference Guide / Manuel de référence /  
 Guía de referencia / Manual de Instruções

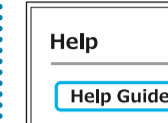

Help Guide /  
 Manuel d'aide /  
 Guía de ayuda /  
 Guia de Ajuda

For Customers other than in Columbia / Pour les clients hors Colombie /  
 Para clientes fuera de Columbia / Para Clientes que não sejam da Colômbia



[http://rd1.sony.net/help/tv/cusltn1/h\\_us/](http://rd1.sony.net/help/tv/cusltn1/h_us/)

For Customers in Columbia / Pour les clients en Colombie /  
 Para clientes en Columbia / Para Clientes na Colômbia



[http://rd1.sony.net/help/tv/ccol1/h\\_co/](http://rd1.sony.net/help/tv/ccol1/h_co/)

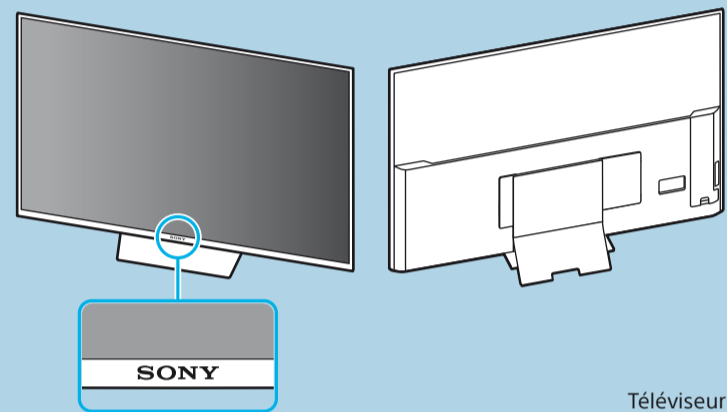

Téléviseur  
 Televisor digital a color con  
 pantalla de cristal líquido  
 Televisor

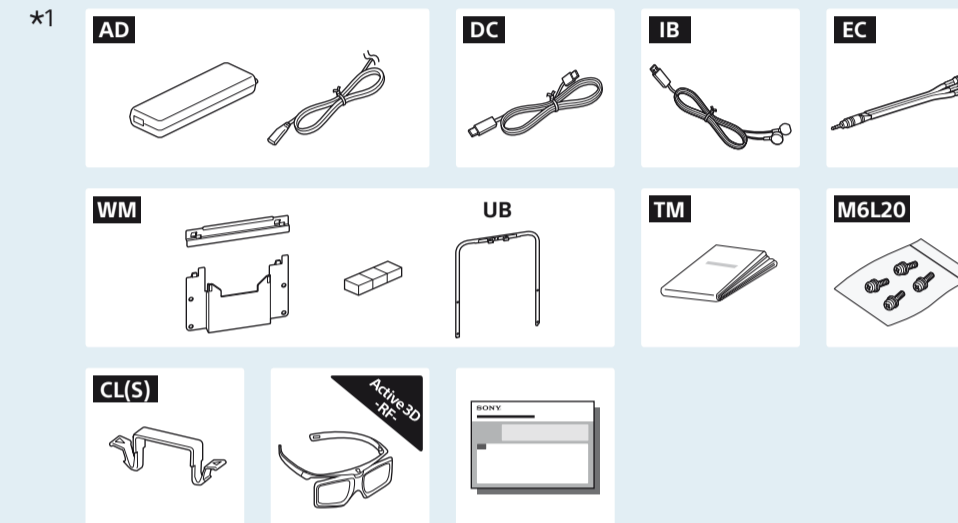
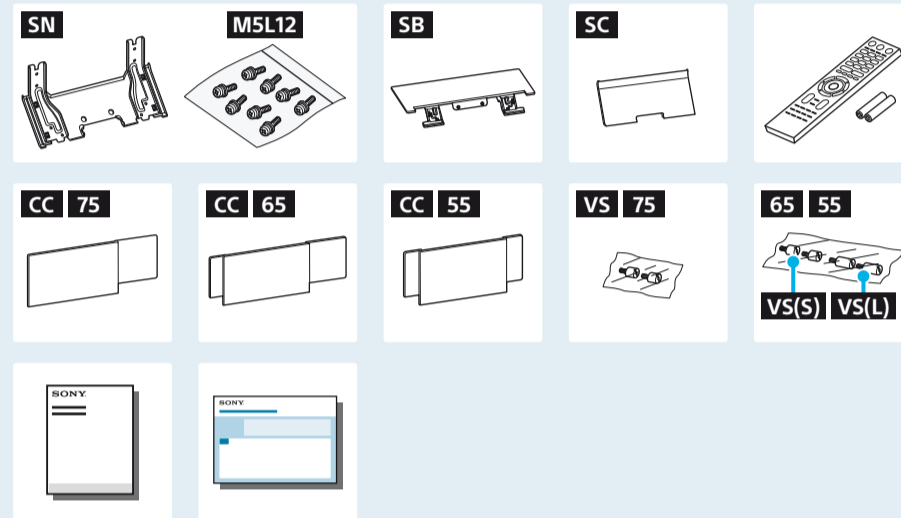

\*1  
 Only on limited region/country/TV model.  
 Uniquement pour des régions/pays/modèles de téléviseurs.  
 Solo en regiones/países limitados/Modelo de TV.  
 Somente para determinadas regiões/países/modelos de TV.

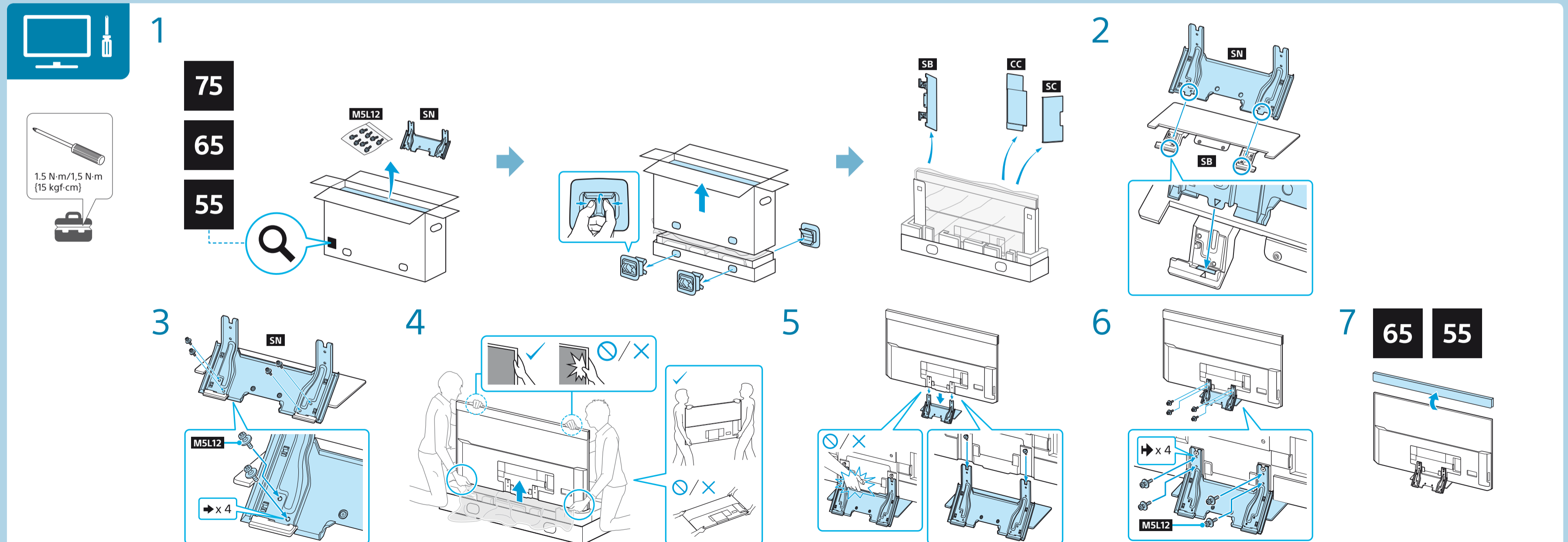

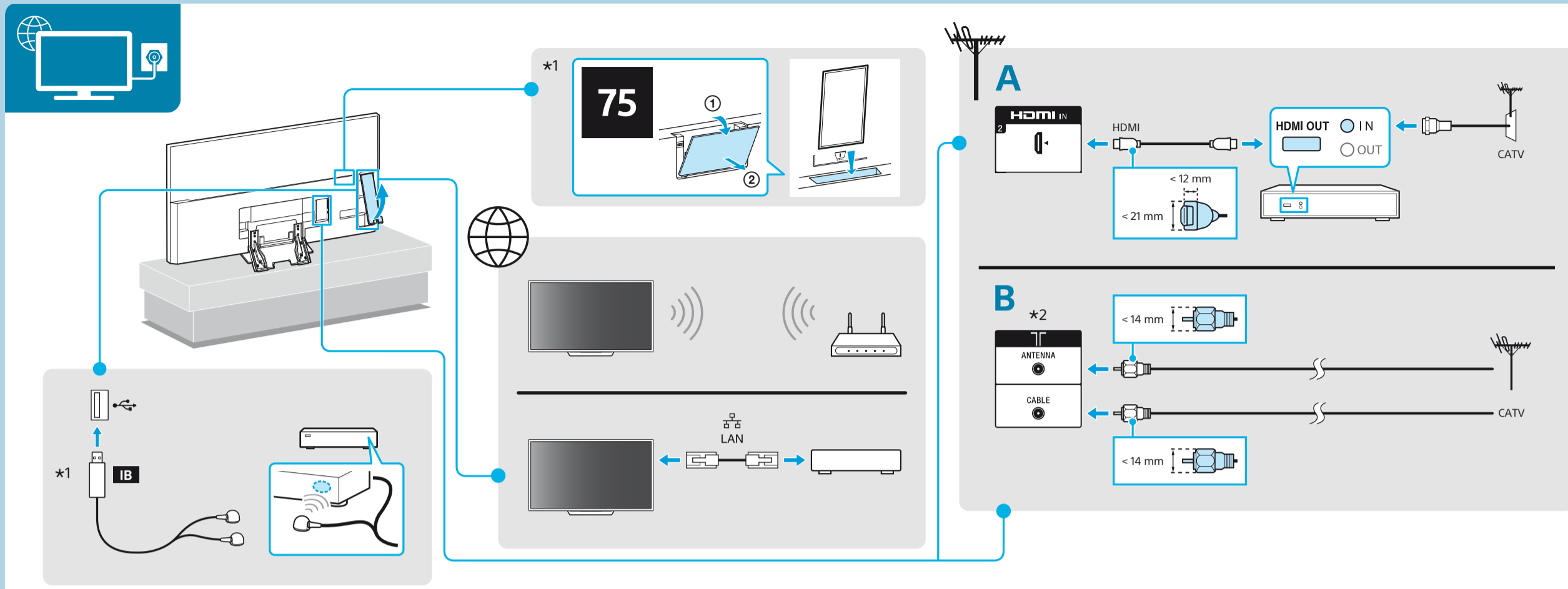

**Connections** Refer to "Connection Diagram" in the Reference Guide for additional connection information.

**Raccordements** Reportez-vous au « Schéma de connexion » dans le Manuel de référence pour des informations de raccordement supplémentaires.

**Connexions** Consulte la "Diagrama de conexión" en la Guía de referencia para obtener más información sobre la conexión.

**Conexões** Consulte "Diagrama de Conexão" no Manual de Instruções para mais informações sobre conexão.



Terminals and labels may vary depending on TV model.  
 Les bornes et étiquettes peuvent varier selon le modèle de téléviseur.  
 Los terminales y las etiquetas pueden variar según el modelo de TV.  
 Terminais e etiquetas podem variar dependendo do modelo de televisor.

