

SOPHOS

Security made simple.

Operating Instructions

Sophos Access Points



Foreword

We are pleased to welcome you as a new Sophos Access Point customer.

These operating instructions will help you install and configure the access point and provide technical specifications of all Sophos access point models. In addition, please also see the following documents that contain useful information on safety, regulatory compliance, and configuration options:

- Sophos Access Points Safety Instructions and Regulatory Information
- Sophos UTM Administration Guide: Configuring the UTM hardware and software appliance

The instructions must be read carefully prior to using the device and should be kept in a safe place. You may download all user manuals and additional documentation from the Sophos Knowledgebase at <http://www.sophos.com/en-us/support/knowledgebase.aspx>.

Introduction

UTM Wireless Protection simplifies the operation of secure and reliable wireless networks. It combines affordable and configuration-less access points through a built-in wireless controller in the in Sophos UTM. The wireless controller itself centrally manages all wireless access points; all you need to do is plug in the device anywhere in your network. The access point will find the controller, fetch its configuration and become operable within seconds. In addition, it easily provides wireless guest Internet access during the initial setup, unless you explicitly deny automatic configuration.

Installation

Preliminary steps

Please update your UTM appliance to the latest version available. Note that you also need a valid UTM Wireless Protection subscription to operate the Sophos Access Points.

Connect the access point to the internal network

Decide where you would prefer to place the access point, and put the access point in that location. For mounting instructions, see below. Now connect the access point to your internal network by plugging in the network cable to the access point's RJ45 or LAN (PoE) Ethernet interface, respectively.

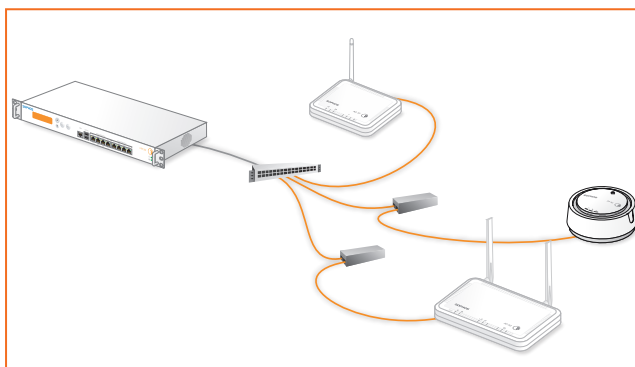

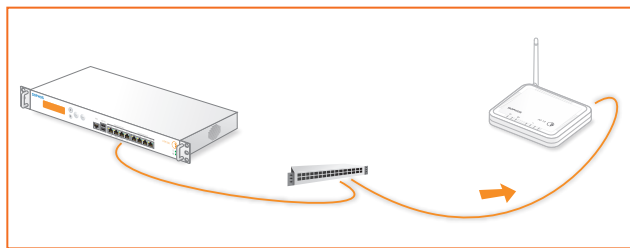
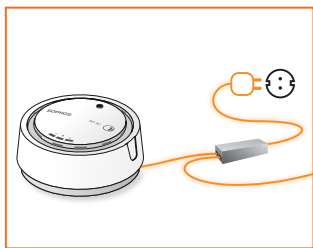
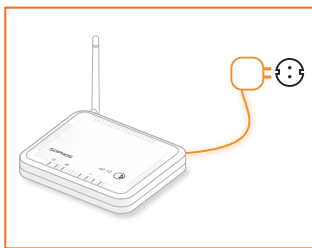

Connect the access point to the power supply

The AAP 30, AP 50, AP 55, AP 55C, AP 100, AP 100C, and AP 100X can be powered directly through the Power-over-Ethernet-injector. Note that it is also possible to power them by a PoE-compliant switch. For more information on PoE-injectors, see below.

Connect the AP 10 and AP 15 to the power supply. Please use the power supply from the scope of supply. Note that the AP 15 can also be operated through a PoE-injector or PoE-compliant switch.

Start the communication between the access point and the UTM appliance

When connected to the network, the access point will try to receive an IP address via DHCP. Therefore, you need either the UTM appliance (with a DHCP server enabled and listening on the interface the access point is connected to) or any other DHCP server to provide an IP address for the access point.

After successfully receiving an IP address, the access point will communicate with the UTM appliance. For this to happen, the UTM appliance needs to be put in the upstream of the access points, either being the default gateway of the access points (which was provided by the DHCP service) or on the default route (most likely your route to the Internet).

Please note that the actual Internet access is not necessary to use UTM Wireless Protection. While waiting for DHCP and searching for the UTM appliance, the access point's power LED will blink slowly.

Enable UTM Wireless Protection on the UTM appliance

In WebAdmin, navigate to the Wireless Protection menu entry. On the Global Settings tab, click the Enable button. When enabling Wireless Protection for the first time, the Initial Setup frame will appear. It shows the configuration which will be created: A separate Wireless "Guest" network using WPA2 personal with DHCP for wireless clients, which will be allowed to use DNS on the UTM appliance and the "Web Surfing" service.

The pre-shared key is auto-generated and will only be shown in this section. This configuration is intended as a template, you can edit the settings at any time on the Wireless Protection > Wireless Networks tab. You can also skip the initial setup by ticking the checkbox on the bottom of the section.

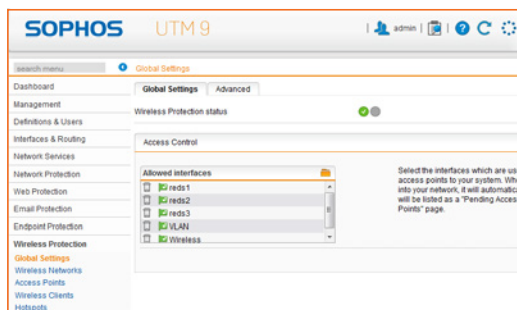

Accepting the access point

The UTM appliance will start to communicate with the access point and they will show up as "Pending" on the Wireless Protection > Access Points tab in WebAdmin. The ID of the Access Points, shown in square brackets, is also printed on the bottom of the device. It can be used to distinguish the access point. By clicking the Accept button, you are given the option to select the channel this access point will transmit on. When leaving the channel setting on "Auto", the access point will use the least used channel.

We also suggest to give the access point a meaningful location (e.g., "Meeting Room") as this will ease handling multiple access points. After clicking the Save button, the access points will reboot. Upon reconnect, the access point will check if a more recent firmware is available. If so, they will automatically perform a firmware update. During the firmware update, the access point's power LED will blink rapidly.



Important note: Do not unplug the power while the firmware is updating. Otherwise the access point will be rendered inoperable and must be returned to the reseller.

The access point will then reboot to complete the firmware update. If no new firmware is available, the access point is operational and appears as "Active" in WebAdmin.

Country code selection usage (WLAN devices)

Note: According to FCC regulations, all WLAN devices marketed and sold in the U.S. must be restricted to U.S. channels only. Therefore, the country code selection is applicable to non-U.S. models only. So changing the country setting of any Sophos AP sold in the U.S. will not modify authorized parameters such as RF channels, which means that the Access Point will always operate in U.S. authorized channels.

AP 10

Scope of supply



Sophos AP 10



Security Notes



Power supply



Detachable dipole antenna



Ethernet cable

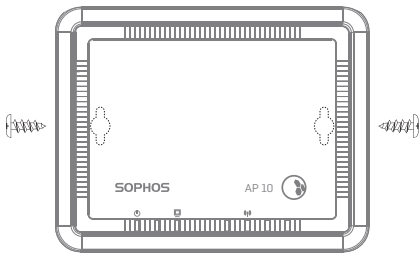

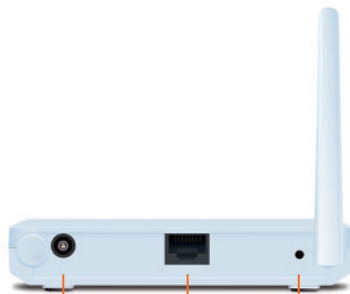

Mounting instructions

The Sophos AP 10 can be mounted on the wall. Screws are not included in delivery. Only use screws whose dimensions correspond with the mounting holes on the back side.



Power 10/100 Base-TX Reset

Controls

 Power (LED display)	
Off	Power off
On continuously	Power on
Blinking rapidly	Firmware update
Blinking slowly	No connection to the Sophos UTM
 LAN connection (LED display)	
On continuously	Network connection, no activity
Blinking	Network activity
 WLAN access (LED display)	
On continuously	Network connection, no activity
Blinking	Network activity
Interfaces and buttons	
DC-IN	Power
RJ45	10/100 Base-TX interface
Reset	Currently not supported

Technical specifications

Sophos AP 10				
Chassis	Plastic housing, white			
Maximum throughput	150 Mbit/s			
LAN interfaces	1 x 10/100 Base-TX			
Supported WLAN standards	802.11 b/g/n 2.4 GHz			
Antenna	1 x detachable dipole antenna (2 dBi)	Connector type: RP-SMA		
Frequencies / channels	2.412–2.462 GHz	Channels 1-11		
Power supply	100-240 VAC, 50/60 Hz, max. 0.3 A			
Power consumption	8 W (max.)			
Power-over-Ethernet	No			
Dimensions W x H x D	124 x 25 x 96 mm			
Weight	130 g			
Temperature range	Operating: 0°C to 45°C	Storage: -20°C to 70°C		
Humidity (non-condensing)	5% to 95%			
Mounting	Desktop / wall			
Supported security standards	WPA/WPA2, WEP, 802.1X (RADIUS)			
Number of supported SSIDs	8			
Regulatory compliance		CE	FCC	MIC/VCCI (Japan)
	Radio:	EN 300328	CFR 47, Part 15 Subpart C	Certification ID: 201 WW 11215237
	EMC:	EN 301489-1, EN 301489-17	CFR 47, Part 15 Subpart B	V-3/2011.04 V-4/2010.04
	EMF:	EN 50385	FCC 1.1310, IEEE C95.1	N/a
	Safety:	EN 60950-1	N/a	N/a

AP 10 Mounting template

Do not shrink to fit when printing

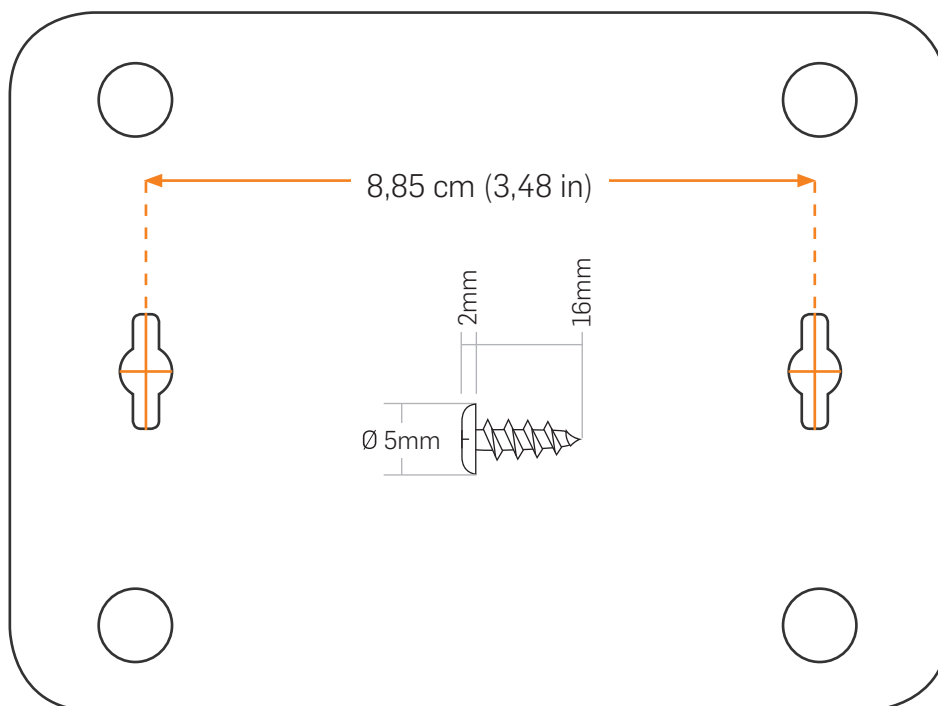

AP 15

Scope of supply



Sophos AP 15



Security Notes



Power supply



2 Detachable dipole antenna



2 screws and dowels



Ethernet cable



Important note: Sophos AP 15 requires Sophos UTM V 9.207 to be installed.

Mounting instructions

The Sophos AP 15 can be mounted on the wall. Screws are included in delivery.

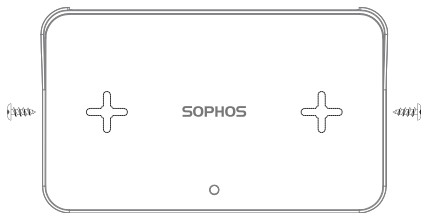

Controls



LED	
Green - blinking slowly	AP is booting
Green - blinking rapidly	Network connectivity
Orange - blinking slowly	No connection to the Sophos UTM
Orange - blinking rapidly	Firmware update

Interfaces and buttons

12V DC-IN	Power
LAN (PoE)	10/100/1000 Base-TX interface



10/100/1000 Base-TX

Power

Technical specifications

Sophos AP 15			
Chassis	Plastic housing, white		
Maximum throughput	300 Mbit/s		
LAN interfaces	1 x 10/100/1000 Base-TX		
Supported WLAN standards	802.11 b/g/n 2.4 GHz		
Antenna	2 x detachable dipole antenna (2 dBi)	Connector type: RP-SMA	
Frequencies / channels	ETSI	FCC	
	2.412-2.472 GHz (Channels 1-13)	2.412-2.462 GHz (channels 1-11)	
Power supply	12 Vdc / 1 A		
Power consumption	2.5 W (max.)		
Power-over-Ethernet	802.3af		
Dimensions W x H x D	194 x 32 x 115 mm		
Weight	260 g		
Temperature range	Operating: 0°C to 45°C	Storage: -20°C to 60°C	
Humidity (non-condensing)	0% to 90%		
Mounting	Desktop / wall		
Supported security standards	WPA/WPA2, WEP, 802.1X (RADIUS)		
Number of supported SSIDs	8		
Regulatory compliance		CE	FCC
	Radio:	EN 300328	CFR 47, Part 15 Subpart C
	EMC:	EN 301489-1, EN 301489-17	CFR 47, Part 15 Subpart B
	EMF:	EN 50385	FCC 1.1310, IEEE C95.1
	Safety:	EN 60950-1	N/a

AP 15 Mounting template

Do not shrink to fit when printing

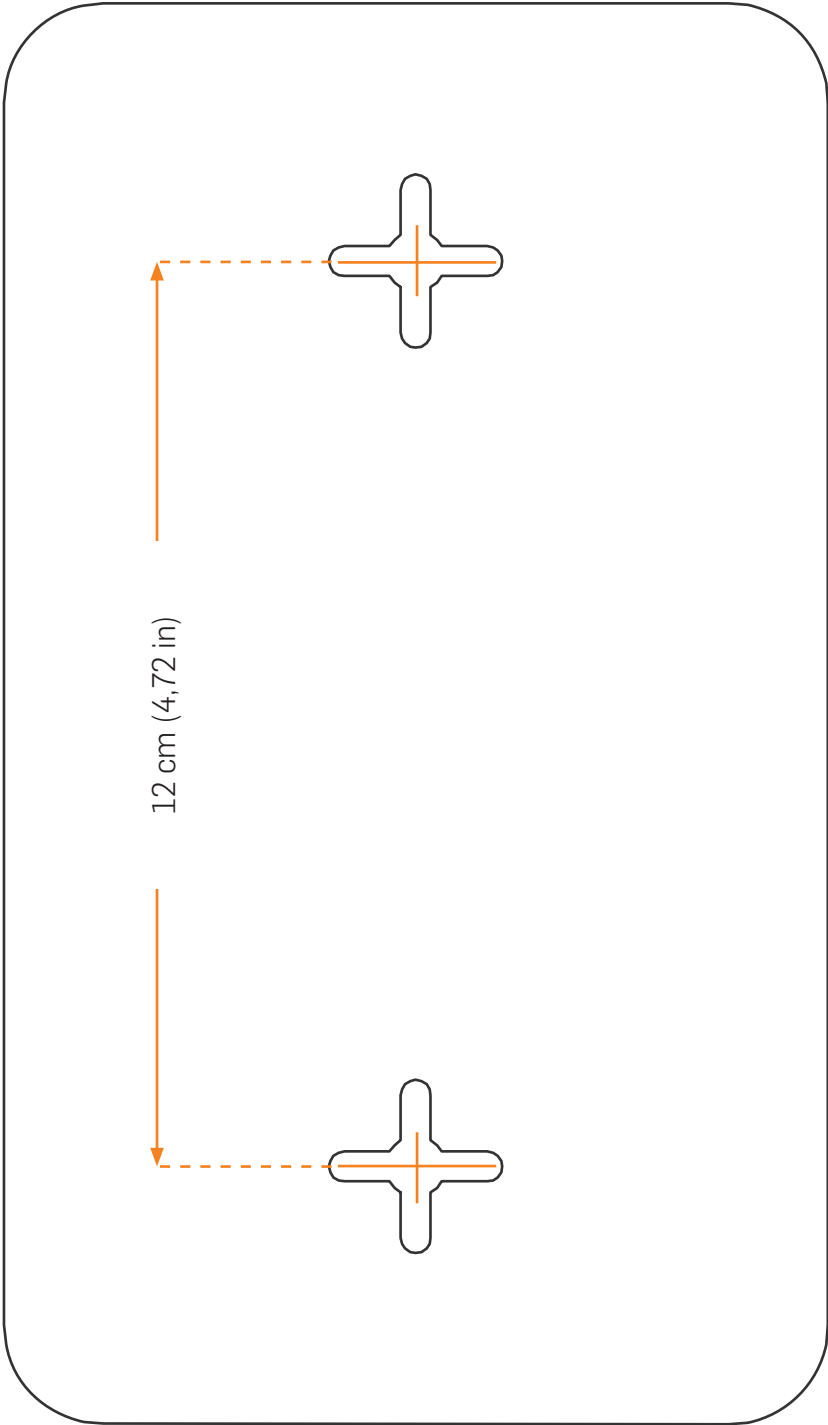



Sophos AP 30



Security Notes

AP 30

Scope of supply



Power-over-Ethernet (PoE) injector + power cord



2 Detachable dipole antenna



2 screws and dowels



Ethernet cable



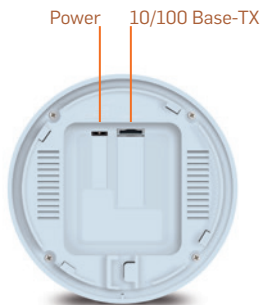
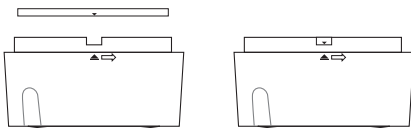
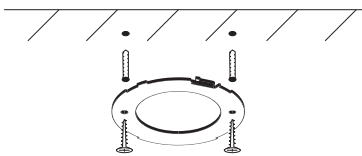
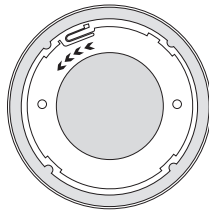

Mounting instructions

The Sophos AP 30 can be mounted on the ceiling. Screws are included in delivery. Use the screws from the scope of supply or screws whose dimensions correspond with the mounting holes in the bracket.

1. Remove the bracket from the housing
Unlock the bracket on the backside by turning it (approx. 5°) counter-clockwise. Then you can take off the bracket.
2. Mount the bracket on the ceiling
Use the screws and anchors from the scope of supply.
3. Place the access point on the bracket
Place the housing on the bracket and lock it by turning clockwise until stop.



Controls

 Power (LED display)	
Off	Power off
On continuously	Power on
Blinking rapidly	Firmware update
Blinking slowly	No connection to the Sophos UTM
 LAN connection (LED display)	
On continuously	Network connection, no activity
Blinking	Network activity
 WLAN access (LED display)	
On continuously	Network connection, no activity
Blinking	Network activity
Interfaces and buttons	
 Reset	Currently not supported
Ethernet	10/100 Base-TX interface
12 V DC IN	Power

Technical specifications

Sophos AP 30				
Chassis	Plastic housing, white (smoke detector design)			
Maximum throughput	300 Mbit/s			
LAN interfaces	1 x 10/100 Base-TX			
Supported WLAN standards	802.11 b/g/n 2.4 GHz			
Antennas	2 x directional internal antennas (4 dBi)			
Frequencies / channels	2.412–2.462 GHz	Channels 1-11		
Power supply	100-240 VAC, 50/60 Hz, max. 0.5 A			
Power consumption	8 W (max.)			
Power-over-Ethernet	802.3af			
Dimensions	ø 120 mm, height 50 mm			
Weight	230 g			
Temperature range	Operating: 0°C to 45°C	Storage: -20°C to 70°C		
Humidity (non-condensing)	5% to 95%			
Mounting	Desktop / ceiling			
Supported security standards	WPA/WPA2, WEP, 802.1X (RADIUS)			
Number of supported SSIDs	8			
Regulatory compliance		CE	FCC	MIC/VCCI (Japan)
	Radio:	EN 300328	CFR 47, Part 15 Subpart C	Certification ID: 201 WW 11215238
	EMC:	EN 301489-1, EN 301489-17	CFR 47, Part 15 Subpart B	V-3/2011.04 V-4/2010.04
	EMF:	EN 50385	FCC 1.1310, IEEE C95.1	N/a
	Safety:	EN 60950-1	N/a	N/a

AP 50

Scope of supply



Sophos AP 50



Security Notes



Power-over-Ethernet (PoE) injector + power cord



2 Detachable dipole antenna



Ethernet cable

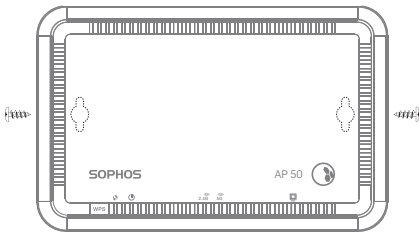

Mounting instructions

The Sophos AP 50 can be mounted on the wall. Screws are not included in delivery. Only use screws whose dimensions correspond with the mounting holes on the back side.



10/100/1000 Base-TX
Reset
Power
Power on/off switch

Controls

🔌 Power (LED display)	
Off	Power off
On continuously	Power on
Blinking rapidly	Firmware update
Blinking slowly	No connection to the Sophos UTM
🌐 LAN connection (LED display)	
On continuously	Network connection, no activity
Blinking	Network activity
📶 2.4G Wireless LAN access with 2.4 GHz (LED display)	
On continuously	Network connection, no activity
Blinking	Network activity
📶 5G Wireless LAN access with 5 GHz (LED display)	
On continuously	Network connection, no activity
Blinking	Network activity
📶 5G Interfaces and buttons	
WPS button	Currently not supported
OI	Power on/off switch
DC 12V IN	Power
Reset	Currently not supported
PoE/LAN	10/100/1000 Base-TX interface

Technical specifications

Sophos AP 50				
Chassis	Plastic housing, white			
Maximum theoretical throughput	300 Mbit/s			
LAN interfaces	1 x 10/100/1000 Base-TX			
Supported WLAN standards	802.11 a/b/g/n 2.4 GHz / 5 GHz			
Antennas	2 x 2.4G/5G (3dBi/5dBi) dual-band antenna			
Frequencies / channels	Radio I: 11b/g/n: 2.412-2.472 GHz (ETSI)	Channels 1-11		
	2.412-2.462 (FCC)	Channels 1-11 (FCC)		
	Radio II: 11a/n: 5.180-5.240 GHz (ETSI / FCC)	Channels 36, 40, 44, 48 (ETSI / FCC)		
	5.745-5.825 GHz (FCC)	Channels 149, 153, 157, 161, 165 (FCC)		
Power supply	100-240 VAC, 50/60 Hz, max. 0.3 A			
Power consumption	9,6 W (800 mA/12 V)			
Power-over-Ethernet	802.3at			
Dimensions	217 x 139 x 28 mm			
Weight	390 g			
Temperature range	Operating: 0°C to 45°C	Storage: -10°C to 70°C		
Humidity (non-condensing)	15% to 95%			
Mounting	Desktop / wall			
Supported security standards	WPA/WPA2, WEP, 802.1X (RADIUS)			
Number of supported SSIDs	8			
Regulatory compliance		CE	FCC	MIC/VCCI (Japan)
	Radio:	EN 300328, EN 301893	CFR 47, Part 15 Subpart C, E	Certification ID: 201-140005
	EMC:	EN 301489-1, EN 301489-17 EN 60601-1-2 (medical electrical equipment)	CFR 47, Part 15 Subpart B	V-3/2013.04 V-4/2012.04
	EMF:	EN 50385	FCC 1.1310, IEEE C95.1	N/a
	Safety:	EN 60950-1	N/a	N/a

AP 50 Mounting template

Do not shrink to fit when printing

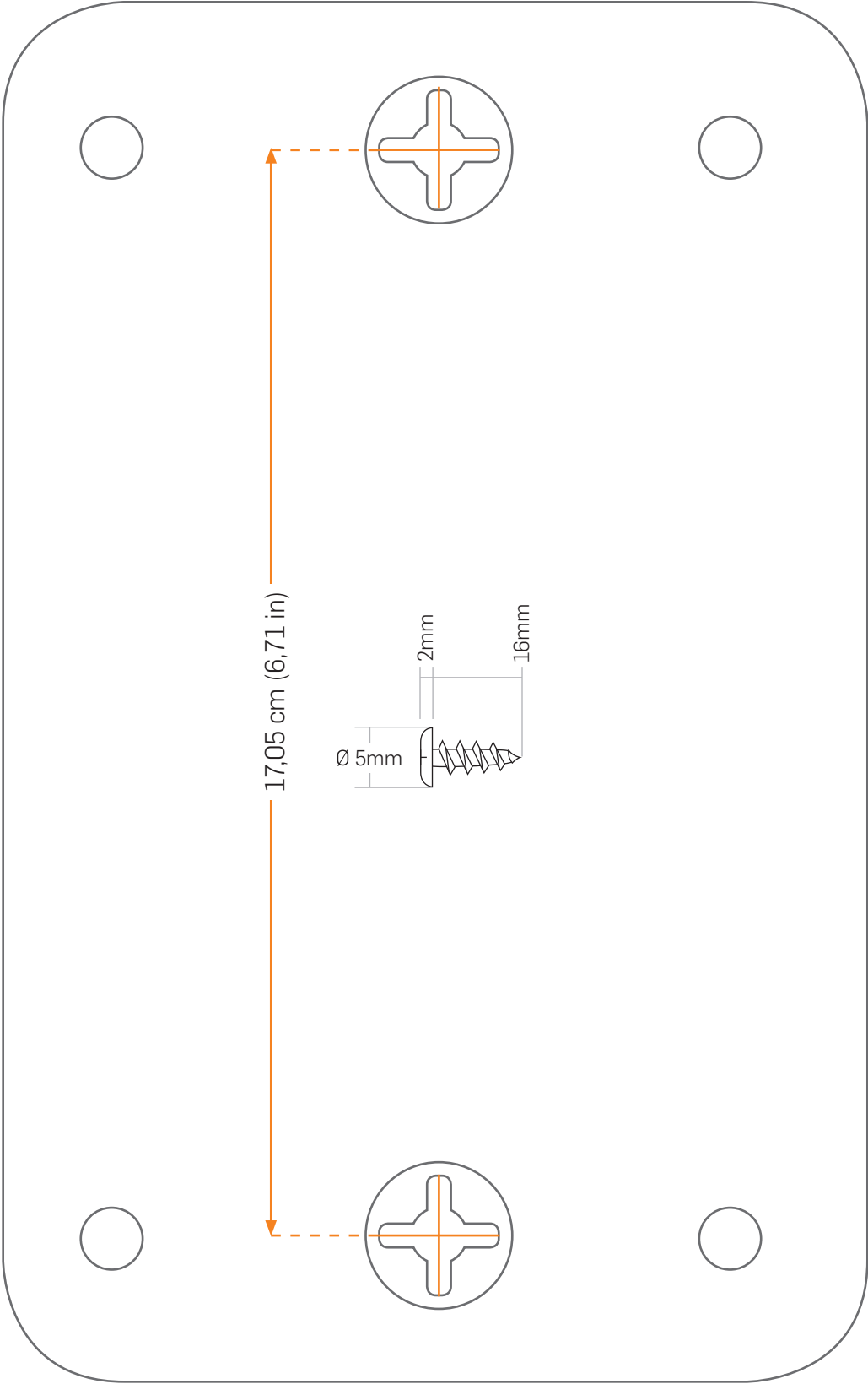

AP 55

Scope of supply



Sophos AP 55



Security Notes



2 Detachable dipole antenna

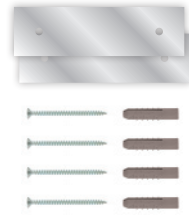

4 screws, dowels and metal plates



Ethernet cable

Important note: Sophos AP 55 requires Sophos UTM V 9.308 to be installed.



Mounting instructions

The Sophos AP 55 can be mounted on the wall. A mounting kit is included in delivery.

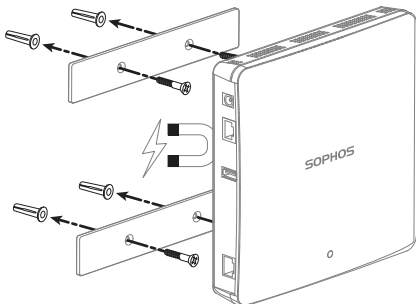

Controls



Green - blinking slowly	AP is booting
Green - blinking rapidly	Network connectivity
Orange - blinking slowly	No connection to the Sophos UTM
Orange - blinking rapidly	Firmware update

Interfaces and buttons

12V DC-IN	Power
LAN (PoE)	10/100/1000 Base-TX interface
Console	Console access for debugging purposes
USB	Currently not used; reserved for future use

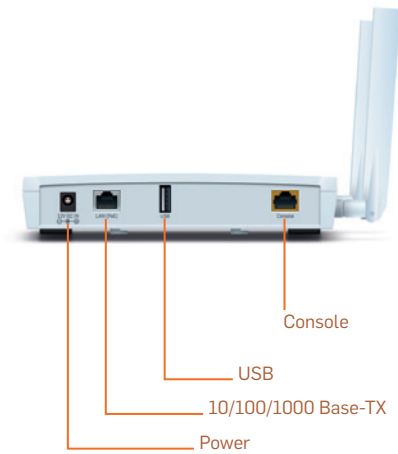

Technical specifications

Sophos AP 55			
Chassis	Plastic housing, white		
Physical security	Kensington lock		
Maximum theoretical throughput	867 Mbps (5GHz / 802.11ac) + 300 Mbps (2.4GHz / 802.11n)		
LAN interfaces	1 x 10/100/1000 Base-TX		
Supported WLAN standards	802.11a/b/g/n/ac		
Antenna	2 x detachable dipole antenna (2 dBi)	Connector type: RP-SMA	
Frequencies / channels	ETSI		
	2.412-2.472 GHz (Channels 1-13)	RLAN sub-band 1: 5.180-5.320GHz (channels 36-64) RLAN sub-band 2: 5.500-5.580GHz (channels 100-116) 5.660-5.700GHz (channels 132-140)	
	FCC		
	2.412-2.462GHz (channels 1-11)	U-NII-1: 5.180-5.240GHz (channels 36-48) U-NII-3: 5.745-5.825GHz (channels 149-165)	
Power supply	12 Vdc / 4 A		
Power consumption	11 W (max.)		
Power-over-Ethernet	802.3at		
Dimensions W x H x D	183 x 36 x 183 mm		
Weight	500 g		
Temperature range	Operating: 0°C to 50°C		
Humidity (non-condensing)	0% to 90%		
Mounting	Desktop / wall		
Supported security standards	WPA/WPA2, WEP, 802.1X (RADIUS)		
Number of supported SSIDs	8 per radio (16 in total)		
Regulatory compliance		CE	FCC
	Radio:	EN 300 328, EN 301 893	CFR 47, Part 15 Subpart C, E
	EMC:	EN 301 489-1, EN 301 489-17	CFR 47, Part 15 Subpart B
	EMF:	EN 50385	FCC 1.1310, IEEE C95.1
	Safety:	EN 60950-1	N/a

AP 55C

Scope of supply



Sophos AP 55C



Security Notes



Mounting bracket



Screws and T-rail clips



Ethernet cable

Important note: Sophos AP 55C requires Sophos UTM V 9.308 to be installed.



Mounting instructions

The Sophos AP 55C can be mounted on the ceiling. Screws are included in delivery. Use the screws from the scope of supply or screws whose dimensions correspond with the mounting holes in the bracket.

1. Mount the bracket on the ceiling
Use the screws and anchors from the scope of supply.
2. Place the access point on the bracket
Place the housing on the bracket and lock it by turning clockwise until stop.



1 x 10/100/1000 Base-TX Power

Controls

LED	
Green - blinking slowly	AP is booting
Green - blinking rapidly	Network connectivity
Orange - blinking slowly	No connection to the Sophos UTM
Orange - blinking rapidly	Firmware update
Interfaces and buttons	
12V DC-IN	Power
LAN (PoE)	10/100/1000 Base-TX interface

Technical specifications

Sophos AP 55C			
Chassis	Top enclosure: plastic, white; bottom enclosure: metal, white		
Physical security	Kensington lock		
Maximum theoretical throughput	867 Mbps (5GHz / 802.11ac) + 300 Mbps (2.4GHz / 802.11n)		
LAN interfaces	1 x 10/100/1000 Base-TX		
Supported WLAN standards	802.11a/b/g/n/ac		
Antenna	4 x internal antennas		
Frequencies / channels	ETSI		
	2.412-2.472 GHz (Channels 1-13)	RLAN sub-band 1: 5.180-5.320GHz (channels 36-64) RLAN sub-band 2: 5.500-5.580GHz (channels 100-116) 5.660-5.700GHz (channels 132-140)	
	FCC		
	2.412-2.462GHz (channels 1-11)	U-NII-1: 5.180-5.240GHz (channels 36-48) U-NII-2: 5.260-5.320GHz (channels 52-64) U-NII-2e: 5.500-5.580GHz (channels 100-116) 5.660-5.700GHz (channels 132-140) U-NII-3: 5.745-5.825GHz (channels 149-165)	
Power supply	12V DC-IN		
Power consumption	???		
Power-over-Ethernet	802.3at		
Diameter x H	200 x 37mm		
Weight	630 g		
Temperature range	Operating: 0°C to 50°C		
Humidity (non-condensing)	0% to 90%		
Mounting	Ceiling		
Supported security standards	WPA/WPA2, WEP, 802.1X (RADIUS)		
Number of supported SSIDs	8 per radio (16 in total)		
Regulatory compliance		CE	FCC
	Radio:	EN 300 328, EN 301 893	CFR 47, Part 15 Subpart C, E
	EMC:	EN 301 489-1, EN 301 489-17	CFR 47, Part 15 Subpart B
	EMF:	EN 50385	FCC 1.1310, IEEE C95.1
	Safety:	EN 60950-1	UL-60950-1, UL-2043 (plenum rated)

AP 100

Scope of supply



Sophos AP 100



Security Notes



3 Detachable dipole antenna

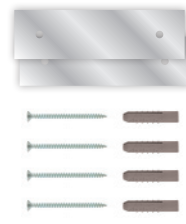

4 screws, dowels and metal plates



Ethernet cable



Important note: Sophos AP 100 requires Sophos UTM V 9.207 to be installed.

Mounting instructions

The Sophos AP 100 can be mounted on the wall. A mounting kit is included in delivery.

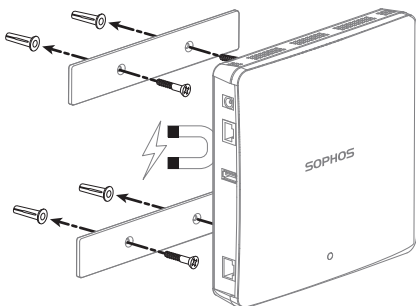

Controls



LED	
Green - blinking slowly	AP is booting
Green - blinking rapidly	Network connectivity
Orange - blinking slowly	No connection to the Sophos UTM
Orange - blinking rapidly	Firmware update

Interfaces and buttons

12V DC-IN	Power
LAN (PoE)	10/100/1000 Base-TX interface
Console	Console access for debugging purposes
USB	Currently not used; reserved for future use

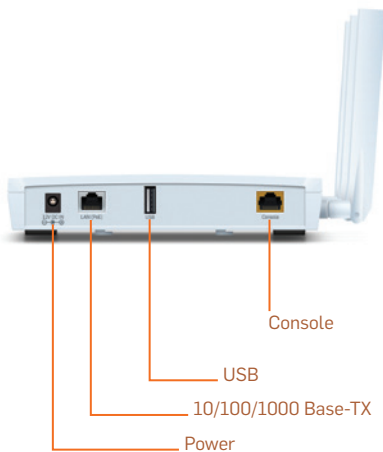

Technical specifications

Sophos AP 100			
Chassis	Plastic housing, white		
Physical security	Kensington lock		
Maximum theoretical throughput	1.3 Gbps (5GHz / 802.11ac) + 450 Mbps (2.4GHz / 802.11n)		
LAN interfaces	1 x 10/100/1000 Base-TX		
Supported WLAN standards	802.11a/b/g/n/ac		
Antenna	3 x detachable dipole antenna (2 dBi)	Connector type: RP-SMA	
Frequencies / channels	ETSI		
	2.412-2.472 GHz (Channels 1-13)	RLAN sub-band 1: 5.180-5.320GHz (channels 36-64) RLAN sub-band 2: 5.500-5.580GHz (channels 100-116) 5.660-5.700GHz (channels 132-140)	
Frequencies / channels	FCC		
	2.412-2.462GHz (channels 1-11)	U-NII-1: 5.180-5.240GHz (channels 36-48) U-NII-2: 5.260-5.320GHz (channels 52-64) U-NII-2e: 5.500-5.580GHz (channels 100-116) 5.660-5.700GHz (channels 132-140) U-NII-3: 5.745-5.825GHz (channels 149-165)	
Power supply	12 Vdc / 4 A		
Power consumption	13 W (max.)		
Power-over-Ethernet	802.3at		
Dimensions W x H x D	183 x 36 x 183 mm		
Weight	505 g		
Temperature range	Operating: 0°C to 50°C		
Humidity (non-condensing)	0% to 90%		
Mounting	Desktop / wall		
Supported security standards	WPA/WPA2, WEP, 802.1X (RADIUS)		
Number of supported SSIDs	8 per radio (16 in total)		
Regulatory compliance		CE	FCC
	Radio:	EN 300 328, EN 301 893	CFR 47, Part 15 Subpart C, E
	EMC:	EN 301 489-1, EN 301 489-17	CFR 47, Part 15 Subpart B
	EMF:	EN 50385	FCC 1.1310, IEEE C95.1
	Safety:	EN 60950-1	N/a

AP 100C

Scope of supply



Sophos AP 100C



Security Notes



Mounting bracket



Screws and
T-rail clips



Ethernet cable

Important note: Sophos AP 100C requires Sophos UTM V 9.308 to be installed.



Mounting instructions

The Sophos AP 100C can be mounted on the ceiling. Screws are included in delivery. Use the screws from the scope of supply or screws whose dimensions correspond with the mounting holes in the bracket.

1. Mount the bracket on the ceiling
Use the screws and anchors from the scope of supply.
2. Place the access point on the bracket
Place the housing on the bracket and lock it by turning clockwise until stop.



1 x 10/100/1000 Base-TX Power

Controls

LED	
Green - blinking slowly	AP is booting
Green - blinking rapidly	Network connectivity
Orange - blinking slowly	No connection to the Sophos UTM
Orange - blinking rapidly	Firmware update
Interfaces and buttons	
12V DC-IN	Power
LAN (PoE)	10/100/1000 Base-TX interface

Technical specifications

Sophos AP 100C			
Chassis	Top enclosure: plastic, white; bottom enclosure: metal, white		
Physical security	Kensington lock		
Maximum theoretical throughput	1.3 Gbps (5GHz / 802.11ac) + 450 Mbps (2.4GHz / 802.11n)		
LAN interfaces	1 x 10/100/1000 Base-TX		
Supported WLAN standards	802.11a/b/g/n/ac		
Antenna	6 x internal antennas		
Frequencies / channels	ETSI		
	2.412-2.472 GHz (Channels 1-13)	RLAN sub-band 1 5.180-5.320GHz (channels 36-64) RLAN sub-band 2: 5.500-5.580GHz (channels 100-116) 5.660-5.700GHz (channels 132-140)	
	FCC		
	2.412-2.462GHz (channels 1-11)	U-NII-1: 5.180-5.240GHz (channels 36-48) U-NII-2: 5.260-5.320GHz (channels 52-64) U-NII-2e: 5.500-5.580GHz (channels 100-116) 5.660-5.700GHz (channels 132-140) U-NII-3: 5.745-5.825GHz (channels 149-165)	
Power supply	12V DC-IN		
Power consumption	???		
Power-over-Ethernet	802.3at		
Diameter x H	200 x 37mm		
Weight	630 g		
Temperature range	Operating: 0°C to 50°C		
Humidity (non-condensing)	0% to 90%		
Mounting	Ceiling		
Supported security standards	WPA/WPA2, WEP, 802.1X (RADIUS)		
Number of supported SSIDs	8 per radio (16 in total)		
Regulatory compliance		CE	FCC
	Radio:	EN 300 328, EN 301 893	CFR 47, Part 15 Subpart C, E
	EMC:	EN 301 489-1, EN 301 489-17	CFR 47, Part 15 Subpart B
	EMF:	EN 50385	FCC 1.1310, IEEE C95.1
	Safety:	EN 60950-1	UL-60950-1, UL-2043 (plenum rated)

AP 100X



Sophos AP 100X



Security Notes



6 antenna



4 wood screws and wood/gyprock plug, 4 M6 screws and washers



1 wall mount plate



2 metal straps



1 M25 cable gland



Ethernet cable



Grounding wire

Installation

Important note: Sophos AP 100X requires Sophos UTM V 9.308 to be installed.



Mounting instructions

The Sophos AP 100X can be mounted on a pole. A mounting kit is included in delivery.

Warning: The equipment has a separate protective earthing terminal on the chassis that must be permanently connected to earth ground to adequately ground the chassis and protect the operator from electrical hazards.

Caution: Before equipment installation begins, ensure that a service personnel has attached an appropriate grounding lug to the grounding cable that you supply.

Power installation must be performed with qualified electrician and followed with National Electrical Code, ANSI/NFPA 70 and Canadian Electrical Code, Part I, CSA C22.1.

To connect earth ground to Unit:

- Connect one end of the grounding cable to a proper earth ground.
- Place the grounding lug attached to the grounding cable over the protective earthing terminal.
- Secure the grounding lug to the protective earthing terminal with the washers and screws.
- Dress the grounding cable and ensure that it does not touch or block access to other components.

Warning: At first before powered on, connect the frame of the unit to earth. For earthing wire, green-and-yellow insulation is required and the cross-sectional area of the conductor must be more than 0.75mm² or 18 AWG.

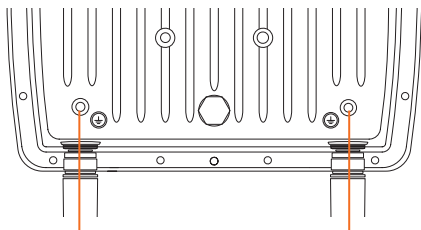

Connect a ground cable from the outdoor unit to an appropriate grounding point.



10/100/1000 Base-TX

Controls

LED	
Power (Green) - continuously on	Power on
WLAN (Green) - blinking rapidly	WLAN activity
WLAN (Green) - blinking regularly	Firmware update
LAN (Green) - blinking rapidly	Network connectivity
Interfaces and buttons	
LAN (PoE)	10/100/1000 Base-TX interface
Reset	Currently not supported

Technical specifications

Sophos AP 100X				
Mounting	Wall / Pole			
Chassis	Metal housing, white			
IP Code	67			
Maximum throughput	1.3 Gbps (5GHz / 802.11ac) + 450 Mbps (2.4GHz / 802.11n)			
Multiple SSIDs	8 per radio, 16 in total			
Number of radios	2			
MIMO capabilities	3x3:3			
LAN interfaces	1 x 10/100/1000 Base-TX			
Antenna	6 x external dipole antenna	Connector type: N-Type		
Antenna gain	4 dBi @ 2.4GHz, 6 dBi @5GHz			
Supported WLAN standards	802.11a/b/g/n/ac			
Frequencies / channels	ETSI			
	2.412-2.472GHz (channels 1-13)	RLAN sub-band 2: 5.500-5.580GHz (channels 100-116) 5.660-5.700GHz (channels 132-140)		
Frequencies / channels	FCC			
	2.412-2.462GHz (channels 1-11)	U-NII-1: 5.180-5.240GHz (channels 36-48) U-NII-2: 5.260-5.320GHz (channels 52-64) U-NII-2e: 5.500-5.580GHz (channels 100-116) 5.660-5.700GHz (channels 132-140) U-NII-3: 5.745-5.825GHz (channels 149-165)		
Dimensions W x H x D	255 x 225 x 90 mm			
Weight	2.5 kg			
Power supply	PoE only			
Power consumption	15 W (max.)			
Power-over-Ethernet	802.3at			
Temperature range	Operation: -20°C to 60°C		Storage: -30°C to 60°C	
Humidity (non-condensing)	Operation: 0% to 90%		Storage: 0% to 95%	
Regulatory compliance		CE	FCC	UL
	Radio:	EN 300 328, EN 301 893	CFR 47, Part 15 Subpart C Section 15.247 and Subpart E Section 15.407	N/a
	EMC:	EN 301489-1, EN 301489-17	CFR 47, Part 15 Subpart B	N/a
	EMF:	EN 62311	CFR 47, Part 2 (Section 2.1091)	N/a
	Safety:	EN 60950-22	N/a	UL 60950-22

Power-over-Ethernet injector

Optionally included with AP 30, AP 50, AP 100 and AP 100X

The PoE injector converts alternating current (AC) to direct current (DC), which is then provided over the Ethernet cable to power the Sophos Access Points AP 30, AP 50, AP 100 and AP 100X.

Installation



Warning: Do not use crossover cable between the PoE injector's output port and the access point.

Before placing the PoE injector, please pay attention to the following safety instructions:

- Do not cover the PoE injector or block the airflow to the PoE with any foreign objects. Keep the PoE away from excessive heat and humidity and free from vibration and dust.
- Ensure that the cable length from Ethernet network source to the access point does not exceed 100 m (330 ft). The PoE is not a repeater and does not amplify the Ethernet data signal.

To install the PoE injector, proceed as follows:

1. Connect an Ethernet cable to the Data & Power Out interface.
2. Connect the other end of this Ethernet cable to the Ethernet interface of the access point.
3. Connect an Ethernet cable to the Data In interface.
4. Connect the other end of this Ethernet cable to your network switch.
5. Connect the AC power cord from the scope of supply to the PoE injector.
6. Connect the AC power cable to an AC outlet (100-240 VAC).

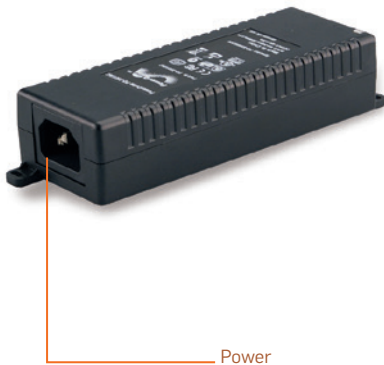
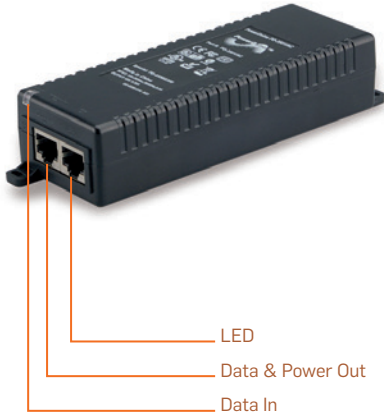

Controls

	PoE injector PD-3501/AC (AP 30)	PoE injector PD-9001GR/AC (AP 50/AP 55/AP 55C/ AP 100/ AP 100C/AP 100X)
LED display		
Off	Power off	
Yellow continuously	Power on	
Green continuously	A remote terminal is connected	A remote terminal is connected
Green blinking	Overload state or short-circuit	Overload state or short-circuit
Interfaces		
Input (Data In)	1 x 10/100 Base-TX	1 x 10/100/1000 Base-TX
Output (Data & Power Out)	1 x 10/100 Base-TX, plus 50 VDC	1 x 10/100/1000 Base TX, plus 55 VDC

Technical specifications

	PoE injector PD-3501/AC (AP 30)	PoE injector PD-9001GR/AC (AP 50/AP 55/AP 55C/AP 100/AP 100C/AP 100X)
Chassis	Plastic housing	Plastic housing
Input power	AC input voltage: 90-264 VAC	AC Input Voltage: 100 to 240 VAC
	AC input current: 0.5 A, 100-240 VAC	AC Input Current: 0.8A @ 100-240 VAC
	AC frequency: 47/63 Hz	AC Frequency: 50 to 60 Hz
Power-over-Ethernet output (max.)	Output power voltage: 50 VDC	Output power voltage: 55 VDC
	Output power: 15.4 W	Output power: 30 W
Supported PoE standard	802.3af compliant	802.3at compliant
Weight	200 g	200 g
Dimensions W x H x D	53 x 33 x 140 mm	1 x 10/100/1000 Base TX, plus 55 VDC
Mounting	Desktop / wall	Desktop / wall
Temperature	0°C to 40°C (operating)	0°C to 40°C (operating)
	-20°C to 70°C (storage)	-20°C to 70°C (storage)
Humidity (non-condensing)	10% to 90%	10% to 90%
Regulatory compliance	CE, FCC, VCCI, UL, GS, RoHS, WEEE	CE, FCC, VCCI, UL, GS, RoHS, WEEE

United Kingdom and Worldwide Sales
 Tel: +44 (0)8447 671131
 Email: sales@sophos.com

North American Sales
 Toll Free: 1-866-866-2802
 Email: nasales@sophos.com

Australia and New Zealand Sales
 Tel: +61 2 9409 9100
 Email: sales@sophos.com.au

Asia Sales
 Tel: +65 62244168
 Email: salesasia@sophos.com