

SOURCE PRO

IMPORTANT

Please note when you open the carton carefully check the unit and make sure there is no damage. If you have any problem with assembling the unit, with how the various functions work or with damage or missing parts. Please call# +1-844-455-4621 (9:00AM - 5:00PM EST) or email: serviceprokonian@jakeglobal.com immediately for service before return the unit to the store where it was purchased.

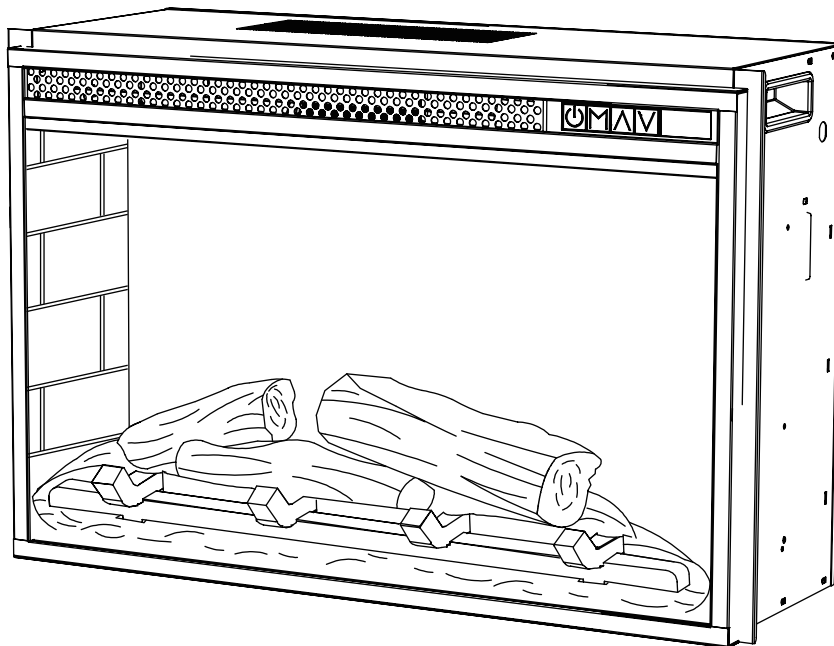

Insert Model:
SP2618-HE-FGPBBT

INSTRUCTION MANUAL ENCLOSED

ELECTRIC FIREPLACE HEATER

HOME OWNER'S INSTRUCTION MANUAL

Model: SP2618-HE-FGPBBT

ATTENTION

FIND A LOCATION FOR THE FIREPLACE HEATER THAT IS PROTECTED FROM DIRECT SUNLIGHT.

FAILURE TO READ ALL INSTRUCTIONS MAY RESULT IN A POSSIBLE ELECTRIC SHOCK, FIRE HAZARD AND / OR INJURY WILL VOID THE WARRANTY

CONSUMER SAFETY INFORMATION

PLEASE READ THIS MANUAL BEFORE INSTALLING AND OPERATING THIS APPLIANCE

WARNING

IF THE INFORMATION IN THIS MANUAL IS NOT FOLLOWED EXACTLY AN ELECTRIC SHOCK OR FIRE MAY RESULT CAUSING PROPERTY DAMAGE, PERSONAL INJURY OR LOSS OF LIFE.

DO NOT STORE OR USE GASOLINE OR OTHER FLAMMABLE VAPORS AND LIQUIDS IN THE VICINITY OF THIS OR ANY OTHER APPLIANCE.

Thank you and congratulations on your purchase of a Source Pro fireplace. Please read the installation & operating instructions before using this appliance.

ATTENTION

Also Requires-
Wood Fireplace Mantel

SAFETY INFORMATION

Please read and understand this entire manual before attempting to assemble, operate or install the product.

This equipment has been tested and found to comply with the limits for a Class B digital device, pursuant to Part 15 of the FCC Rules. These limits are designed to provide reasonable protection against harmful interference in a residential installation. This equipment generates, uses and can radiate radio frequency energy and, if not installed and used in accordance with the instructions, may cause harmful interference to radio communications.

However, there is no guarantee that interference will not occur in a particular installation. If this equipment does cause harmful interference to radio or television reception, which can be determined by turning the equipment off and on, the user is encouraged to try to correct the interference by one or more of the following measures:

- Reorient or relocate the receiving antenna
- Increase the separation between the equipment and the receiver
- Connect the equipment into an outlet on a circuit different from that to which the receiver is connected.
- Consult the dealer or an experienced radio/TV technician for help.

This device complies with Industry Canada Licence-exempt RSS-210. Operation is subject to the following two conditions:

- (1) this device may not cause interference, and
- (2) this device must accept any interference, including interference that may cause undesired operation of the device.

CAUTION: To maintain compliance with the RF exposure guidelines, place the base unit at least 20cm from nearby persons.

WARNING: Changes or modifications to this unit not expressly approved by party responsible for compliance could void the user's authority to operate the equipment.

IMPORTANT INSTRUCTIONS

When using electrical appliances, basic precautions should always be followed to reduce the risk of fire, electric shock and injury to persons, including the following:

Read all instructions before installing or using the heater.

 **DANGER:** If the information in this manual is not followed exactly, an electric shock or fire may result causing property damage, personal injury or loss of life.

 **WARNING:** This appliance is hot when in use. To avoid burns, DO NOT let bare skin touch hot surfaces. Keep combustible material, such as furniture, pillows, bedding, papers, clothes and curtains, at least 3 feet from the front of the heater and keep them away from the side and rear.

 **WARNING:** Extreme caution is necessary when any heater is used by or near children or individuals with disabilities and whenever the fireplace is left operating and unattended.

 **WARNING:** DO NOT run cord under carpeting. DO NOT cover cord with throw rugs, runners, or similar covering. Do not route cord under furniture or appliances. Arrange cord away from traffic areas and where it will not be tripped over.

 **WARNING:** Do NOT insert or allow foreign objects to enter any ventilation or exhaust opening as this may cause an electric shock or fire, or damage the appliance.

 **WARNING:** This appliance has hot and arcing or sparking parts inside. DO NOT use it in areas where gasoline, paint or flammable vapors or liquids are used or stored. This fireplace should not be used as a drying rack for clothing. Christmas stockings or decorations should not be hung in the area of it.

SAFETY INFORMATION

Use this appliance only as described in the manual. Any other use is NOT recommended by the manufacturer and may cause fire, electric shock or injury to persons.

CAUTION

- If possible, ALWAYS unplug this appliance when not in use.
- DO NOT operate any heater with a damaged cord or plug or after the heater malfunctions.
- DO NOT operate any heater if it has been dropped or damaged in any manner. Disconnect power at service panel and have heater inspected by a reputable electrician before reusing.
- Any repairs to this fireplace should be carried out by a qualified service person.
- Under no circumstances should this fireplace be modified. Parts having to be removed for servicing must be replaced prior to operating this fireplace again.
- DO NOT use outdoors.
- This heater is not intended for use in bathrooms, laundry areas and similar indoor locations. NEVER place heater where it may fall into a bathtub or other water container.
- To disconnect this appliance, turn controls to the off position, then remove plug from outlet.
- ONLY connect to properly grounded outlets.
- This appliance, when installed, must be electrically grounded in accordance with local codes, with the current CSA C22.1 Canadian Electrical Code or follow the National Electrical Code, ANSI/NFPA NO.70.
- To prevent a possible fire, DO NOT block air intakes or exhaust in any manner. DO NOT use on soft surfaces, like a bed, where opening may become blocked.
- The heaters MUST NOT be located immediately below a socket-outlet.
- ALWAYS plug heaters directly into a wall outlet/receptacle. NEVER use with an extension cord or relocatable power tap (outlet/power strip).
- There is a thermostat protective device provide inside of unit. If the inner temperature overheats or abnormal heating occurs, the thermostat protective device will cut off power supply to prevent damage or risk of fire.
- DO NOT slide insert on top of wood to avoid scratching wood surface.
- DO NOT place any objects on top of insert and top air intake vents as this will cause unit to overheat and can cause a fire.

Electrical Connection

- A 15-amp, 120-volt, 60 Hz circuit with a properly grounded outlet is required. Preferably, the fireplace will be on a dedicated circuit as other appliances on the same circuit may cause the circuit breaker to trip or the fuse to blow when the heater is in operation. The unit comes standard with 6-ft. three-wire cord, exiting from the rear of the fireplace. DO NOT exceed the current rating of the current tap. ALWAYS plug heaters directly into a wall outlet/receptacle. NEVER use with an extension cord or relocatable power tap (outlet/power strip).
- This heater is for use on 120 volts. The cord has a plug as shown below. See illustration for grounding instruction. An adapter as shown at C is available for connecting three-blade grounding type plugs to two-slot receptacles. The green grounding lug extending from the adapter must be connected to a permanent ground such as a properly grounded outlet box. The adapter should not be used if a three-slot grounded receptacle is available.

ELECTRICAL SPECIFICATIONS

Voltage: 120 VAC, 60 Hz
Amps: 11.7 Amps
Watts: 1400 Watts

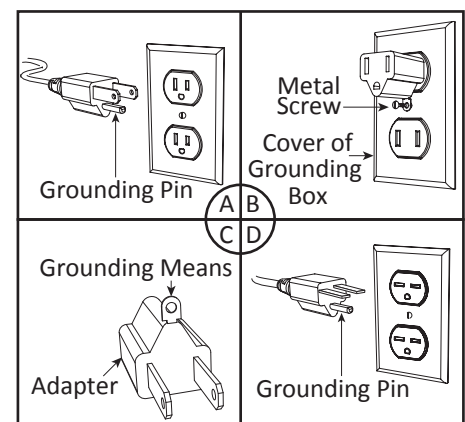

SAVE THESE INSTRUCTIONS

INSTALLATION INSTRUCTION

1. Position your completed mantel close to its final location. Make sure you can access the back of the mantel as your electric fireplace insert will be install from the back.
2. Place a piece of cardboard or protective sheet on the floor in order to avoid scratching the decorative surface of your mantel during assembly. Please DO NOT fully tighten the KD screws until all panels are assembled.
3. The fireplace insert can be installed after the mantel has been fully assembled.

WARNING: Make sure the fireplace insert controls are in the OFF position and the unit is NOT plugged in.

CAUTION - High temperature, risk of fire, keep electrical cords, drapery, furnishings, and other combustibles at least 3 feet (0.9 m) from the front of the heater and away from the side and rear.

To reduce the risk of fire, do not store or use gasoline or other flammable vapors and liquids in the vicinity of the heater.

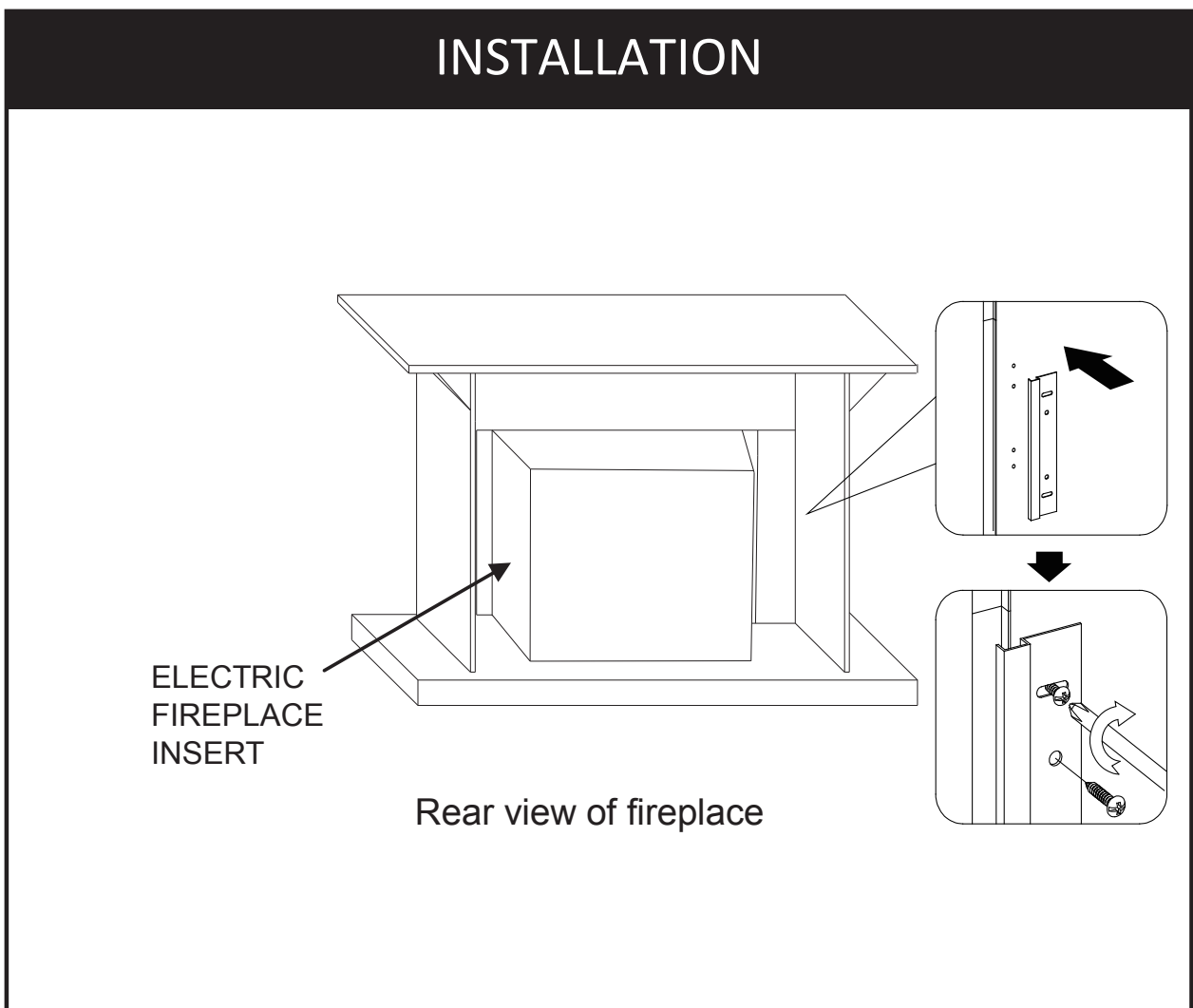

OPERATING INSTRUCTIONS

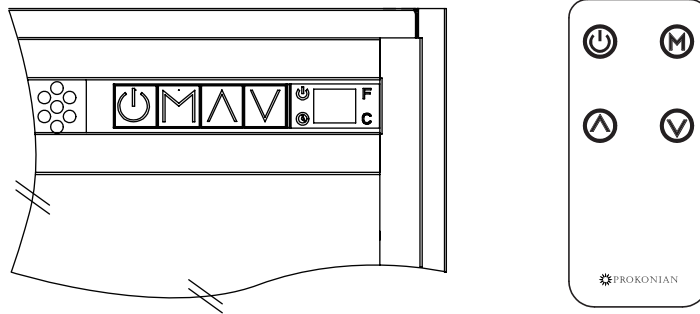

Note: Heater must be properly installed before it is used.



Power Button

- Pressing the power button will turn ON or OFF the unit.
- When the unit is in ON mode, the power icon indicator light will be shown green.
- When the unit is in OFF mode, the power icon indicator light will be shown red. When power OFF, unit will be stopped, if heater is working before power OFF the unit, fan will have 20 seconds delay to ensure heat will not be trapped inside the unit.

Note: When plug the unit each time, 5 seconds fan and heater will turn on for internal check program.

Note: The unit has a memory function with last settings for heating level and flame brightness effect, unless the main power to the unit has been interrupted.



Mode Button

- Press the mode button to cycle through the different functions. Each time the mode button is pressed, the mode will enter the next function - Temperature, Timer or Flame Brightness.

Temperature Setting

- The temperature mode controls the heater's thermostat setting.
- Press UP Arrow Button or Down Arrow Button to scroll through the pre-set temperature range from 59°F (15°C) to 86°F (30°C), ON & OF (OFF).

- Hold the mode button for 3s, this allows the temperature unit changing from °C to °F or °F to °C. The unit default is °F.

Note: This function is only available if using the control panel.

- When the ambient temperature is higher than the set temperature, heater will turn off automatically.

Timer Setting

- The timer setting should be used to set the countdown for the unit's main power.
- Press Up Arrow Button or Down Arrow Button to adjust the timer setting from 0 hour (OFF) to 9 hours with 0.5 hour interval.

Flame Brightness Setting

- The flame brightness mode should be used to set the flame brightness.
- Use Up arrow button or Down arrow button to scroll through the flame brightness settings: F0 (Flame OFF, only lowest brightest on ember bed), F1, F2, F3, F4, F5 (brightest).

OPERATING INSTRUCTIONS

Flame Color Setting

- The flame brightness mode should be used to set the flame brightness.
- Use Up arrow button or Down arrow button to scroll through the flame brightness settings: C1, C2, C3, C4

Setting	Color
C1	Yellow
C2	Blue

Setting	Color
C3	Yellow + Blue
C4	Auto Change (Fade In / Fade Out)



UP Arrow Button

- Use up arrow button to increase the setting of the selected function.



Down Arrow Button

- Use down arrow button to decrease the setting of the selected function.

Child Lock

Activate Child Lock

When the unit is ON, holding the POWER button for 10 seconds to activate the Child Lock function. E3 will be displayed and "Beep Sound" for 3 times that indicate the Child Lock function activate. All function keys are locked. When pressing any button, E3 will be displayed that indicate the Child Lock function activate.

Inactivate Child Lock

To inactivate the Child Lock function, holding the POWER button for 10 seconds.

Note: Child lock function is only available if using the control panel.

Manually Reset

Unplug unit, wait 5-10 minutes, then the sensor will reset itself.

FIREPLACE REMOTE APP

DOWNLOAD THE FIREPLACE MOBILE APP



Bold Flame Fireplace Remote

Free Fireplace remote App gives you full access and control of your fireplace



QR Code for download - FREE



1. Go to Apple Store or Google Play Store
2. Type "Fireplace remote" on the search bar
3. Click "download"
4. Enter your account and password if necessary
5. Installation will be completed automatically

FIREPLACE REMOTE APP

CONNECT YOUR FIREPLACE WITH FIREPLACE REMOTE

1. Turn on the fireplace
2. Switch on Bluetooth on your mobile devices
3. Tap the side menu button (Fig. 1)

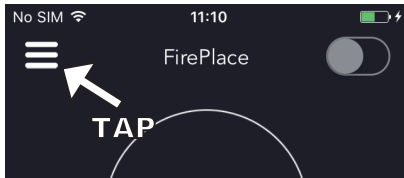

Fig. 1 Tap the side menu button (Top left)

4. Press "Add" (Fig. 2) button and start searching (Fig. 3) the Fireplace nearby

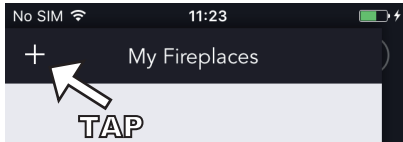

Fig. 2 Tap the "+" button (Top left)

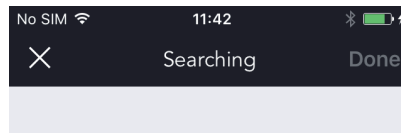

Fig. 3 Searching Fireplace

5. Enter a name for the fireplace (Fig. 4)
6. (Fig. 6) Blue light represents the Fireplace is connected properly and ready to use

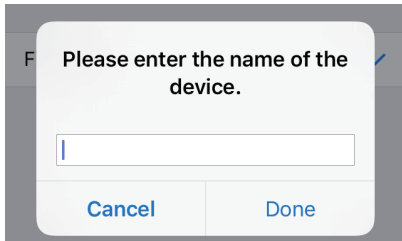

Fig. 4 Enter a name for the Fireplace

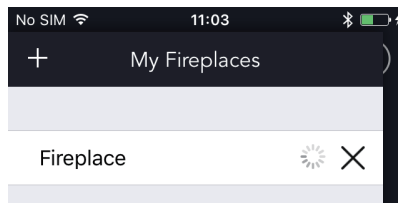

Fig. 5 Connecting Fireplace

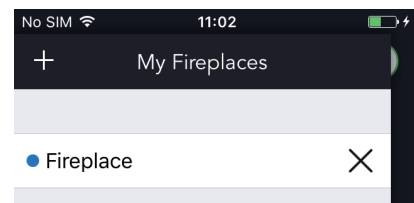

Fig. 6 Fireplace Connected

7. Return to main page by clicking the side menu button
8. Make sure the right corner button is "ON" (Fig.7)
9. Adjust the color, brightness and the temperature with the Bluetooth remote

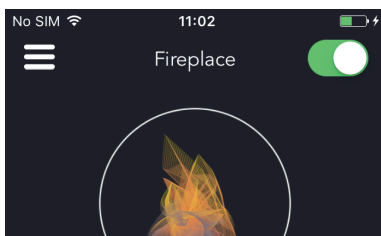

Fig. 7 Connected to Fireplace and ready to use

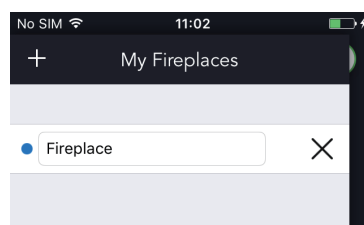

Fig. 8 Long press the name to enter edit mode

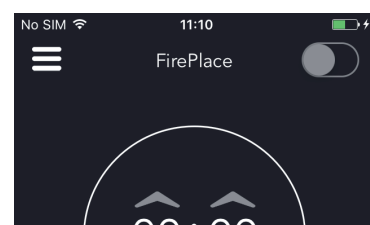

Fig. 9 Switch off the connection by pressing the toggle (top right)

CARE AND MAINTENANCE



WARNING: Make sure the power is turned off before proceeding. Any electrical repairs or rewiring of this unit should be carried out by a licensed electrician in accordance with national and local codes.



If repairing or replacing an electrical component or wiring, the original wire routing, color coding and securing locations must be followed.

WARNING: Electrical outlet wiring must comply with local building codes and other applicable regulations to reduce the risk of fire, electrical shock and injury to persons.



WARNING: Do not use this fireplace if any part of it has been under water. Immediately call a qualified service technician to inspect the fireplace and replace any part of the electrical system.



WARNING: Disconnect power before attempting any maintenance or cleaning to reduce the risk of fire, electrical shock or personal injury.

WARNING: During any service of this appliance, the power to the unit must be turned off. First turn the main power switch to the "OFF" position. Then remove the electrical plug from the wall outlet.

- Make sure the unit is turned OFF, unplugged and the heating elements of heater are cool whenever you are cleaning the heater.
- Clean the heater when the heater is not in use.
- For heavy or continuous use, periodic cleaning must be done more frequently.
- Clean the metal trim using a water-dampened soft, clean cloth. DO NOT use brass polish or household cleaners as these products will damage the metal trim.
- The motors used on the fan and the flame generator assembly are pre-lubricated for extended bearing life and require no further lubrication. However, periodic cleaning/vacuuming of the fan/heater and air intake/output vents is recommended.
- Any other servicing should be performed by an authorized service representative.
- When the heater is not in use, the heater should be stored in a dry location, away from possible damage. The power cord should be stored properly to avoid contact with hot or sharp objects.

CARE AND MAINTENANCE

Replacing the Remote Control Battery

When the remote control stops operating or its range seems reduced, it is time to replace the batteries.

Note: The batteries should be removed if the product is to be left unused for a long time.

Caution: Non-rechargeable battery is not to be recharged. Exhausted battery is to be removed from the product.

1. The battery compartment is located on the back end of the remote control.
2. Press the small tab inward as you slide the battery door open and remove the old battery.
3. Insert a new CR2025 lithium battery (not included), ensuring the polarities of the battery match the inside of the battery compartment.
4. Re-insert the battery door.

Disposal of Used Battery

A battery may contain hazardous substances that could be endangering to environment and human health.

- This symbol marked on the battery and/or packaging indicates that used battery shall not be treated as municipal waste. Instead it shall be left at the appropriate collection point for recycling.
- By ensuring the used battery is disposed of correctly, you will help prevent potential negative consequences for the environment and human health. The recycling of materials will help to conserve natural resources.



For more information about collection and recycling of used batteries, please contact your local municipality, your waste disposal service or the point of sale where you purchased this item.

TROUBLE SHOOTING GUIDE

PROBLEM	POSSIBLE CAUSE	SOLUTION
1. No power, logs do not glow.	1. The unit does not have power.	1. Check that unit is plugged into a standard 120 volt outlet. Then make sure power is set at "ON" position.
2. E1 displayed on control panel.	2. The overheat protection device has been engaged.	2. Unplug unit, wait 5-10 minutes, then the sensor will reset itself. Plug the unit back in and turn on the heater. If the problem persists, call customer service.
3. E2 displayed on control panel.	3. The ambient temperature sensor is broken or not working correctly.	3. Unplug unit, wait 5-10 minutes, then the sensor will reset itself. Plug the unit back in and turn on the heater. If the problem persists, call customer service.
4. E3 displayed on control panel.	4. Child lock function activate.	4. To inactivate the Child Lock function, holding the POWER button for 10 seconds.
5. Fan motor continues to blow after unit is powered off.	5. Normal operation.	5. This is a standard feature; the blower runs for an additional 20 seconds to ensure heat will not be trapped inside the unit.
6. Power cord gets warm to the touch.	6. Normal operation.	6. This is normal for a heater appliance as it requires more current to operate. Check the connections of the appliance cord and the outlet. Make sure the plug fits tightly into the outlet. During use, check the plug and outlet frequently to determine if it is HOT; if so, discontinue use of the appliance and consult with a qualified electrician to check or change the overheating outlet(s).

1 YEAR LIMITED WARRANTY

SOURCE PRO ELECTRIC FIREPLACE MODEL

BASIC WARRANTY

Source Pro Industries Ltd. (hereinafter referred to collectively as the (“company”) warrants that your new Prokonian Electric Fireplace is free from manufacturing and materials defects for a period of one year from date of purchase. Subject to following conditions and limitations.

1. The electric fireplace must be installed and operated at all times in accordance with the installation and operating instruction furnished with the product. Any unauthorized repair, alteration, willful abuse, accident, or misuse of the product shall nullify this warranty.
2. This warranty is non-transferable, and is made to the original owner, provided that the purchase was made through an authorized supplier of the company.
3. The warranty is limited to the repair or replacement of part(s) found to be defective in material or workmanship, provided that such part(s) have been subjected to normal conditions of use and service, after said defect is confirmed by the company’s inspection.
4. This warranty does not cover the LED light bar included with the Prokonian Electric Fireplace.
5. The Company may, at its discretion, fully discharge all obligations with respect to this warranty by refunding the wholesale price of the defective part(s).
6. Any installation, labor construction, transportation, or other related costs/expenses arising from defective part(s), repair, replacement, or otherwise of same , will not be covered by this warranty, nor shall the Company assume responsibility for same.
7. The owner/user assumes all other risks. If any including the risk of any direct, indirect or consequential loss or damage arising out of the use. Or inability to use the product, except as provided by law.
8. All other warranties – expressed or implied – with respect to the product, its components and accessories, or any obligations / liabilities on the part of the Company are hereby expressly excluded.
9. The Company neither assumes, nor authorizes any third party to assume, on it behalf, any other liabilities with respect to the sale of the Prokonian product.
10. The warranties as outlined within this document do not apply to non Prokonian accessories used in conjunction with the installation of this product.
11. This warranty gives you specific legal rights, and you may also have other right which vary from state to state. This warranty is void if:
 - a. The fireplace is subjected to prolonged periods of dampness or condensation.
 - b. Any unauthorized alteration, willful abuse, accident, or misuse of the product.
 - c. You do not have the original receipt of purchase.

IF WARRANTY SERVICE IS NEEDED

Contact the company, at serviceprokonian@jakeglobal.com or call +1-844-455-4621 have your warranty, your sales receipt, location of purchase and the model / serial number of your Source Pro products.

CUSTOMER SERVICE

Email: serviceprokonian@jakeglobal.com
Call: +1-844-455-4621

Please refer to part code when reordering
For questions or comments about product:
Email: serviceprokonian@jakeglobal.com or Call: +1-844-455-4621

Crafted in China
Distributed by Source Pro Industries Ltd.