



M19GS

*19" TFT
LCD MONITOR*



Getting Start

Before You Start.....	2
Unpacking	3
Hardware Installation	3
Precaution.....	4
Troubleshooting	4
Warning	4
Cleaning Notices	4
Menu control button.....	5
OSD (On-Screen Display) Menu Mode.....	5-7
Display Mode	8
Specification	8
Dimensional Drawings.....	9

All Information in this manual may change from time to time without prior notice.

Before you start

1.

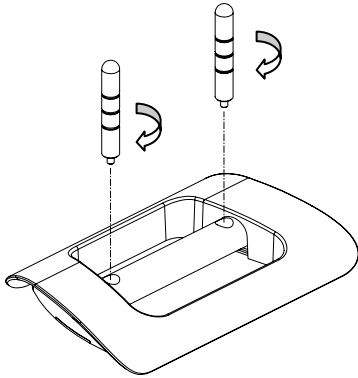

Load the two holders and the stand together, and make sure they are secure and tie



2.

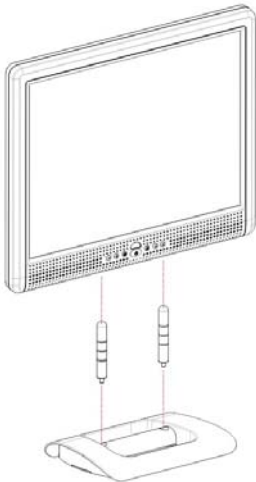

Put the LCD panel set into the stand, and make sure they are secure and tie



3.

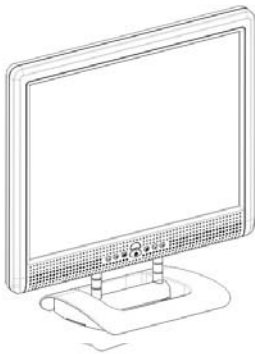





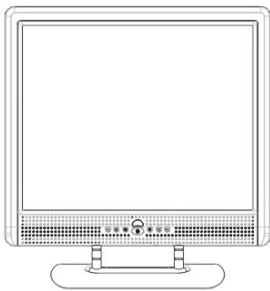

LCD monitor can be lay back 0° ~ 2° (positive and negative 2°).

Thank you for your purchase of our LCD product. To ensure safety operation of this product, Please read the following menu carefully before using this product.

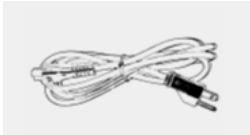
Unpacking

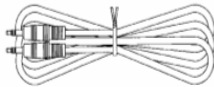
Our 19" LCD monitor shall be content with these following items. Make sure you get all these set ready, otherwise contact to your dealer or store which you purchased it. At last, feel free to contact us.

<p>19" TFT LCD Monitor</p>			
<p>External Univ15 pin D-sub (RGB Analog) input signal cable</p>		<p>Power Cord</p>	
<p>ADAPTER TECH. External Universal AC Adaptor STD-1203 (100-240V, 50/60Hz)</p>		<p>Audio connector : stereo Phone Jack</p>	
<p>CD User's manual</p>		<p>Quick Start Guide</p>	

* (DPF Card Reader and TV module is optional)

Hardware Installation

Be carefully to your LCD monitor, it's very exquisite but easy to broken. Turn off LCD's and PC's power before you set it up. Follow our installation step by step.

Input

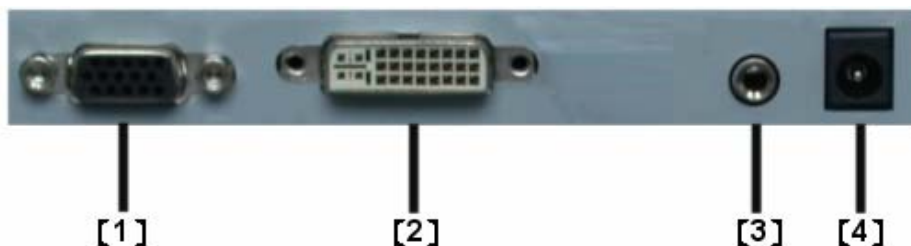
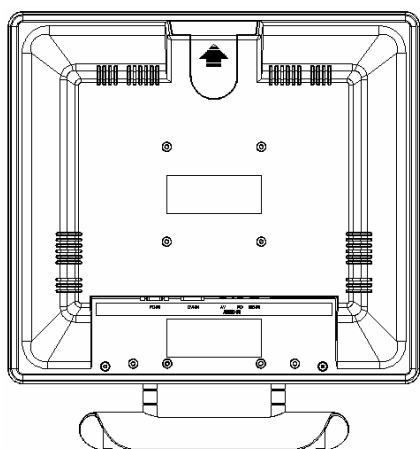

[1] PC In : This can be connected with the D-Sub 15 pin signal Cable.

[2] DVI port : This can be connected with the DVI signal Cable.

*(select option)

[3] PC Audio-In port : This can be connected to PC Line out signal Cable.

[4] DC port : This is for connecting the power cable.

Precaution

1. Do not expose the monitor to direct sunlight or heat.
2. Do not spill liquid on the monitor.
3. Do not attempt to open the monitor. You may be hurt by electric shock. For service, call your place of purchase.
4. Do not use your monitor when magnets or electronic products are operating nearby.
5. Do not use harsh chemicals or strong cleaning solvents to clean the monitor screen. Wipe it with clean, soft clothes applied with mild solution.
6. Do not place anything on your monitor. Bad ventilation may elevate temperature in the monitor.
7. Don't use your fingers to touch the LCD Screen, directly. Fingerprint that contains oil and may be difficult to clear.

Troubleshooting

Make sure that your monitor is properly installed if you have encountered any trouble using this product.

- There is no picture on the screen.

Check:

1. Power saving mode. Press any key and move the mouse to deactivate the mode.
2. Signal cable connector pins. If there are bent or missing pins, consult your place of purchase.

• Characters look too dark or too light

Check:

1. Using OSD Menu to adjust the Brightness.

• When your monitor shall be adjusted?

Check:

1. If the resolution or refresh rate is being changed.

• The Text appears on the screen are unclear.

Check

1. Make sure the resolution or refresh rate match with the Display Mode.

Warning

1. Make sure that the system power is turned off.
2. Plug the signal cable to the signal connector at the rear of PC.
3. Plug adapter output cable to the jack at the rear of LCD monitor and the power cord to the adapter.
4. Connect the power cord to power source.
5. Turn on the computer and the monitor.
6. For the best quality of the performance, we suggest you to set resolution as page 8 (Display Mode).
7. The lock (on the stand) must be locking in while using it.

Cleaning Notice

1. Unplug the power cord from the AC outlet before clean the product.
2. Never, ever, using any kind of corrosiveness chemical dissolvent to clean the screen, it may hurt your screen surface.
3. We suggest that using a clean camel hair brush or a soft, clean, lint-free cloth to wipe the screen.
4. Don't give any pressure directly to the LCD

Monitor Adjusting



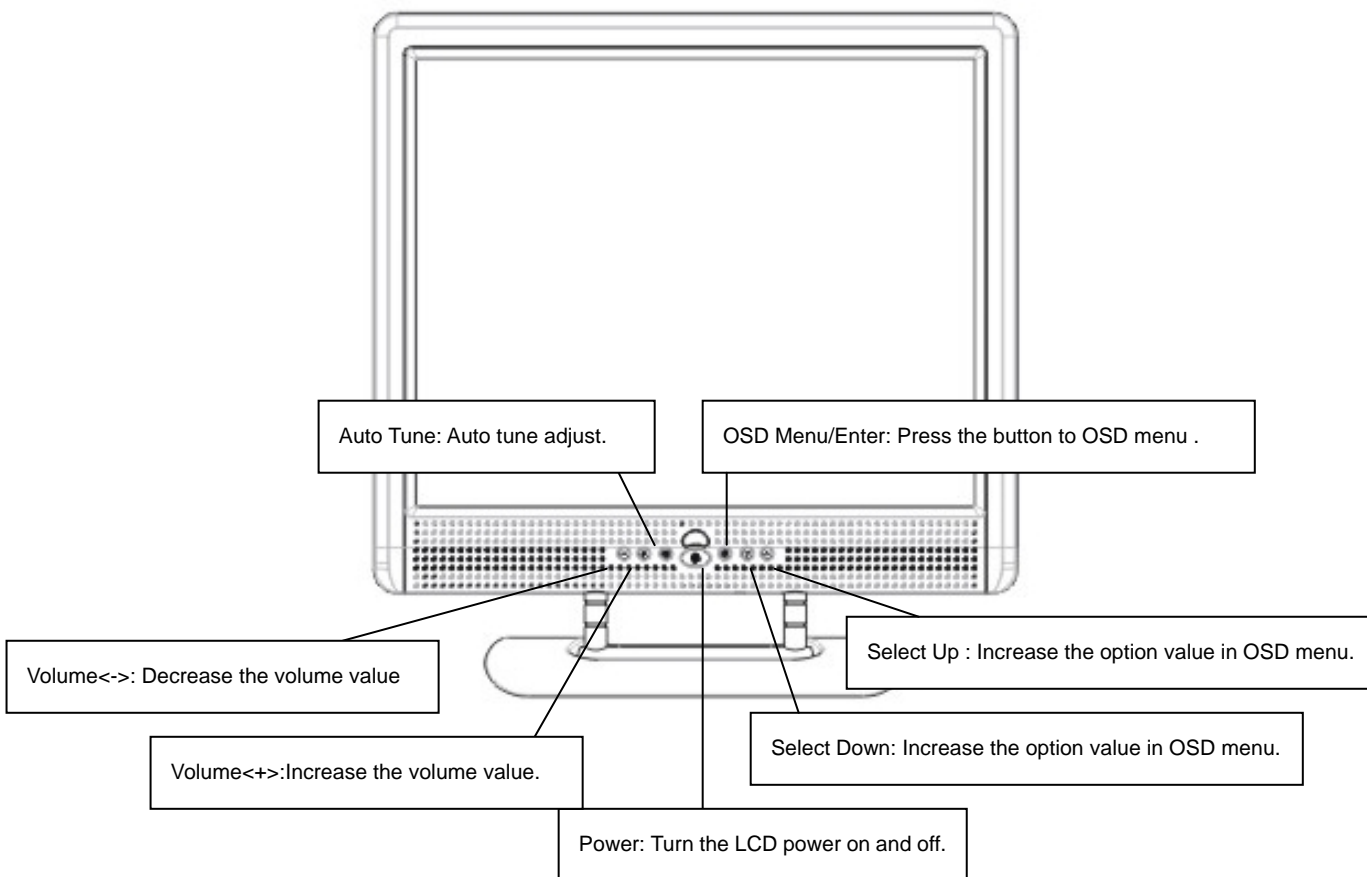





Menu control button







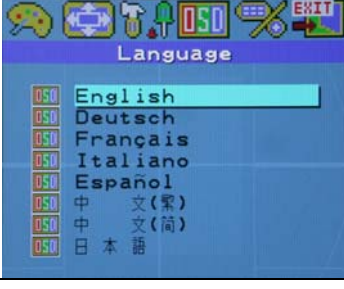



OSD (On-Screen Display) Menu Mode

<p>Colour</p> <ul style="list-style-type: none"> Brightness Contrast Gamma Correct. Color Temp. Color Adjust Exit <p>54</p>	<p>Brightness : Adjust the brightness of the display.</p>	<p>Colour</p> <ul style="list-style-type: none"> Brightness Contrast Gamma Correct. Color Temp. Color Adjust Exit <p>51</p>	<p>Contrast : Adjust the difference between light and dark area.</p>
<p>Colour</p> <ul style="list-style-type: none"> Brightness Contrast Gamma Correct. Color Temp. Color Adjust Exit <p>00 01 02 03</p>	<p>Gamma Correct : Adjust the gamma Curve.</p>	<p>Colour</p> <ul style="list-style-type: none"> Brightness Contrast Gamma Correct. Color Temp. Color Adjust Exit <p>9300 6500 5800 USER</p>	<p>Color Temp : Adjust the temp of the pixel color.</p>

OSD (On-Screen Display) Menu Mode (Continue)

 <p>Colour</p> <ul style="list-style-type: none"> Brightness Contrast Gamma Correct. Color Temp. Color Adjust Exit <p>1024X768 60HZ</p>	<p>Color Adjust : Adjust the RGB color.</p>	 <p>Colour Adjust</p> <ul style="list-style-type: none"> Red Green Blue Exit <p>1280X1024 75HZ</p>	<p>Red : Adjust the pixel of red pixel.</p> <p>Green : Adjust the pixel of green pixel.</p> <p>Blue : Adjust the pixel of blue pixel.</p>
 <p>Picture</p> <ul style="list-style-type: none"> H.Position V.Position Sharpness Phase Clock Exit <p>51</p>	<p>H. Position : Adjust the horizontal position of the display.</p>	 <p>Picture</p> <ul style="list-style-type: none"> H.Position V.Position Sharpness Phase Clock Exit <p>51</p>	<p>V. Position : Adjust the vertical position of the display.</p>
 <p>Picture</p> <ul style="list-style-type: none"> H.Position V.Position Sharpness Phase Clock Exit <p>c1 c2 c3 c4 c5</p>	<p>Sharpness : Adjust the sharpness of display.</p>	 <p>Picture</p> <ul style="list-style-type: none"> H.Position V.Position Sharpness Phase Clock Exit <p>23</p>	<p>Phase : Adjust the phase of PLL clock.</p>
 <p>Picture</p> <ul style="list-style-type: none"> H.Position V.Position Sharpness Phase Clock Exit <p>100</p>	<p>Clock : Adjust the frequency of the PLL colck.</p>	 <p>Function</p> <ul style="list-style-type: none"> Auto Adjust Auto Color Exit <p>1024X768 75HZ</p>	<p>Auto Adjust : Auto Tune.</p> <p>Auto Color : Gray Scale auto tune</p>
 <p>OSD Menu</p> <ul style="list-style-type: none"> Language OSD H.Position OSD V.Position OSD Timer Translucent Exit <p>1024X768 60HZ</p>	<p>Language : Select the display language of the OSD.</p>	 <p>Language</p> <ul style="list-style-type: none"> English Deutsch Français Italiano Español 中文(繁) 中文(简) 日本語 	<p>English : English</p> <p>Deutsch : German</p> <p>Français : French</p> <p>Italiano : Italian</p> <p>Español : Spanish</p> <p>中文(繁) : Traditional Chinese</p> <p>中文(简) : Simply Chinese</p> <p>日本語 : Japanese</p>
 <p>OSD Menu</p> <ul style="list-style-type: none"> Language OSD H.Position OSD V.Position OSD Timer Translucent Exit <p>80</p>	<p>OSD H. Position : Adjust the horizontal position of the OSD.</p>	 <p>OSD Menu</p> <ul style="list-style-type: none"> Language OSD H.Position OSD V.Position OSD Timer Translucent Exit <p>90</p>	<p>OSD V. Position : Adjust the vertical position of OSD.</p>

OSD (On-Screen Display) Menu Mode (Continue)

 <p>OSD Menu</p> <ul style="list-style-type: none"> Language OSD H.Position OSD V.Position OSD Timer Translucent Exit 	<p>OSD Timer : Adjust the timeout of OSD.</p>	 <p>OSD Menu</p> <ul style="list-style-type: none"> Language OSD H.Position OSD V.Position OSD Timer Translucent Exit <p>On Off</p>	<p>Translucent : Adjust diaphaneity of the OSD.</p>
 <p>Miscellaneous</p> <ul style="list-style-type: none"> Signal Source Mode Select Reset Volume Exit <p>1024X768 60HZ</p>	<p>Signal Source : Switch input signal source.</p>	 <p>Signal Source</p> <ul style="list-style-type: none"> D-SUB DVI 	<p>D-SUB : Analogy RGB signal.</p> <p>DVI : Digital RGB signal.</p>
 <p>Miscellaneous</p> <ul style="list-style-type: none"> Signal Source Mode Select Reset Volume Exit <p>640X400 720X400</p>	<p>Mode Select : Switch the display size in DOS mode.</p>	 <p>Miscellaneous</p> <ul style="list-style-type: none"> Signal Source Mode Select Reset Volume Exit <p>1280X1024 75HZ</p>	<p>Reset : Recall the default setting.</p>
 <p>Miscellaneous</p> <ul style="list-style-type: none"> Signal Source Mode Select Reset Volume Exit 	<p>Volume : Increase or decrease the sound volume.</p>	 <p>Exit</p> <p>1280X1024 75HZ</p>	<p>Exit : Exit and saving the setting.</p>

DISPLAY MODE

Resolution	Incoming Display Mode	
	Horizontal Frequency (KHz)	Vertical Frequency (Hz)
640X350	31.475	70.100
640X480	31.469	59.940
640X480	37.500	75.000
720X400	31.469	70.087
800X600	37.879	60.317
800X600	46.875	75.000
1024X768	48.363	60.004
1024X768	60.023	75.029
1280X1024	63.981	60.020
1280X1024	79.976	75.024

1. We offer you 10 available modes compatible with Windows.
2. If any interference occurs on your screen while you modulating your PC or OSD. It is normal.
3. To have Best quality present on the PC, remember to upgrade your video card Driver. We strongly recommend you to choose a Mode listed in the table.
4. The other Modes may not be supported that are not list on the table above
5. You may use the power management on your computer. It's good for last service life of the product.

Specification

LCD Panel	Type Viewing Angle Contrast Ratio Brightness Response Time Display Colors Max Resolution Pixel Pitch	19.0" TFT Active Matrix LCD Display H:170° , V:170° 600 : 1 (Typical) 250 (Typical) (15+10) 25 ms 16.7M colors 1280X1024(SXGA) 0.294mm(H)x0.294mm(V)
Input Signals	RGB Analog Video In* DVI* ANT*	Video Level:0.7Vp-p(75Ω) Sync TTL with 75Ω internal pull-up resistors Frequency FH:30~79KHz FV:56~75Hz Auto Detect NTSC/PAL interlaced video with input format of Composite video(AV) and S-video Support digital RGB signal with TMDS signaling type NTSC or PAL- ^B / _G , ^D / _K , I, ^L / _L
Compatibility	PC	Up to 1280X1024@75Hz(Non-interlaced)
Connector	RGB Analog DVI Video In* Audio Power ANT* DPF Card**	D-sub 15-pins DVI-D S-Video, RCA jack* Stereo Phone Jack, RCA-Jack(L/R) 12V/DC Power Jack RF Tuner PH Type terminal CF/Micro-drive/SM/SD/MMC/MS/MS PRO
Power	Voltage Consumption Power saving mode	100-240V, 50/60Hz(universal) via external AC Adapter Active < 48Watt Max Standby < 3Watt
Internal Speaker		2Wx2(Stereo)
User Interface	LED Indicator	Active - Green Off - Turn off Standby - Orange
Operating Condition	Temperature Air Humidity	5°C~40°C 20% ~ 80% R.H.
Dimensions	Physical	463mm(H) x 436mm(W) x 64mm(D)
Net Weight		6.6 Kg
DDC		DDC1/DDC2B Compliant
Power Management		VESA DPMS, EPA Energy Star
Regulation (Certifications)		CE, FCC, VCCI, BSMI, UL/CUL

*Video In and DVI functions are optional.

** DPF (Digital Photo Frame) is select option.

Dimensional Drawings

