



Wireless Service Manual



vieworks



Revision History

| Revision | Date | Descriptions |
|----------|------------|-----------------|
| 1.0 | 2012-06-08 | Initial Release |



Contents

- Safety and Regulatory 6**
 - Safety Notice..... 6
 - Safety Information 7
 - Battery Pack and Battery Charger Safety Information 9
 - General Hazards 11
 - Owner’s Responsibility..... 11
 - Notes for Using the Equipment..... 12
 - Regulatory 15
 - Medical Equipment Classifications..... 15
 - Equipment Standards 15
 - Guidance and Manufacturer’s Declaration for EMC Directive 16
 - Label and Symbols..... 19
- 1. Overview 22**
 - 1.1 Features..... 22
 - 1.2 Intended Use 22
 - 1.3 Standard Configuration..... 23
- 2. Product Description 24**
 - 2.1 Product Components 24
 - 2.2 Detector 26
 - 2.2.1 Detector Specifications 26
 - 2.2.2 Detector Components 27
 - 2.2.3 Detector Dimension 28
 - 2.3 System Control Unit 29
 - 2.3.1 System Control Unit Specifications 29
 - 2.3.2 System Control Unit Components 30
 - 2.3.3 SCU Dimension 32
 - 2.3.4 Fuse..... 33
 - 2.4 Battery Charger and Battery Pack 34
 - 2.4.1 Battery Charger Specifications 34
 - 2.4.2 Battery Charger Components..... 34
 - 2.4.3 Battery Charger Dimension 35
 - 2.5 Battery Pack 36
 - 2.5.1 Battery Pack Specifications 36
 - 2.5.2 Battery Pack Dimension 36
 - 2.5.3 Charging Battery Pack 37



- 2.6 X-ray Generator Interface 38**
 - 2.6.1 X-ray Exposure Mode..... 38
 - 2.6.2 Timing of Signals (DR Trigger Mode)..... 40
 - 2.6.3 EXT_INF Port Pin Assignment 40
 - 2.6.4 Input and Output Circuits..... 43
- 3. Packaging and Contents 44**
- 4. How to Install 45**
 - 4.1 Hardware Installation 45**
 - 4.1.1 FXRD-1417WA (B) 45
 - 4.2 Software Installation..... 49**
 - 4.2.1 Intel Gigabit Controller Driver Installation and Setting 49
 - 4.2.2 Gigabit Controller Setting on Windows XP..... 53
 - 4.2.3 Gigabit Controller Setting on Windows 7 59
 - 4.2.4 VXvue Installation..... 64
 - 4.2.5 Allowing VXvue to communicate through Windows Firewall on Windows XP 72
 - 4.2.6 Allowing VXvue to communicate through Windows Firewall on Windows 7..... 75
- 5. Prerequisite for Operation 77**
 - 5.1 Preparing the SCU 77**
 - 5.2 Generator Configuration 78**
 - 5.3 Detector Configuration 79**
 - 5.3.1 Detector Setting..... 80
 - 5.3.2 Configuring Devices 82
 - 5.4 Detector Calibration 87**
 - 5.4.1 Configuring the Detector 87
 - 5.4.2 Offset Calibration..... 91
 - 5.4.3 Defect Correction 93
 - 5.4.4 Gain Pixel Correction 100
 - 5.4.5 Detector Preference 101
 - 5.5 Diagnosis Mode 102**
- 6. Operation 104**
- 7. Maintenance..... 105**
 - 7.1 Function Test 105**
 - 7.2 Maintenance Guidelines for Users and Test Forms..... 106**





| | |
|---|------------|
| 8. Troubleshooting | 122 |
| 8.1 Failure Case | 122 |
| 8.1.1 Repairing SCU..... | 122 |
| 8.1.2 Repairing Power Failure..... | 122 |
| 8.1.3 Configuration Failure | 122 |
| 8.1.4 Repairing Communication Failure | 122 |
| 9. Warranty | 123 |



Safety and Regulatory

Safety Notice











The following safety notices are used to emphasize certain safety instructions. Follow the safety instructions in this manual along with warnings and cautions symbols. Ignoring such warnings or cautions while handling the product may result in serious injury or accident. It is important for you to read and understand the contents of this manual before attempting to use the product.

| Symbols | Descriptions |
|---|--|
|  | Indicates a potentially hazardous situation which will cause death, severe personal injury or substantial property damage if the instructions are ignored. |
|  | Indicates a potentially hazardous situation which may cause minor personal injury or property damage if the instructions are ignored. |
|  | Provides additional information that is helpful to you. It may emphasize certain information regarding special tools or items to check before operating the product. |



Safety Information

This product is designed and manufactured to ensure maximum safety of operation and to meet all the safety requirements applicable to electronic medical equipment. However, anyone attempting to operate the system must be fully aware of potential safety hazards. It should be operated and maintained in strict compliance with the following safety precautions and operating instruments contained herein:











| | |
|--|---|
|  CAUTION | Caution: Federal law restricts this device to sale by or on the order of a physician or a licensed practitioner. |
|  WARNING | Always be alert when operating this device. If a malfunction occurs, do not use this device until qualified personnel correct the problems. |
|  WARNING | The product should be installed, maintained and serviced according to Vieworks maintenance procedures and by Vieworks personnel or other qualified maintenance personnel approved in writing by Vieworks. Operation and maintenance should be done in strict compliance with the operation instructions contained in the manuals. |
|  WARNING | The system, in whole or in part, cannot be modified in any way without written approval from Vieworks. |
|  CAUTION | Before authorizing any person to operate the system, verify that the person has read and fully understand the Service Manual. The owner should make certain that only properly trained and fully qualified personnel are authorized to operate the equipment. An authorized operators list should be maintained. |
|  WARNING | Prevent unauthorized personnel from access to the system. |
|  CAUTION | It is important that this Service Manual be kept at hand, studied carefully and reviewed periodically by the authorized operators. |
|  CAUTION | The owner should ensure continuous power supply to the system, with voltage and current according to the product specifications. If power failures are frequent, an Uninterrupted Power Supply (UPS) should be installed to avoid loss of data. |
|  CAUTION | If the product does not operate properly or if it fails to respond to the controls described in this manual, the operator should immediately contact Vieworks field service representative. |
|  CAUTION | User must not contact a fuse holder or contacts of connector (ex: Inlet connector) with a patient simultaneously during operating the equipment and not allow patient to touch the fuse holder or contacts of connector. |

| | |
|--|--|
| | <p>The images and calculations provided by this system are intended to be used as tools for the competent user. They are explicitly not to be regarded as a sole incontrovertible basis for clinical diagnosis. Users are encouraged to study the literature and reach their own professional conclusions regarding the clinical utility of the system.</p> |
| | <p>The user should be aware of the product specifications and of the system's accuracy and stability limitations. These limitations must be considered before making any decision based on quantitative values, in case of doubt, please consult a Vieworks representative.</p> |
| | <p>Do not install the equipment in a location with the conditions listed below. Otherwise, it may result in failure or malfunction, fall or cause fire or injury.</p> <ul style="list-style-type: none"> • Close to facilities where water is used. • Locations exposed to direct sunlight. • Close to air-conditioner or ventilation equipment. • Close to heat source such as a heater. • Prone to vibration. • Insecure place. • Dusty environment. • Saline or sulfurous environment. • High humidity. • Ambient temperature is higher than the operating temperature stated in this Service Manual. |
| | <p>Occasionally, this product may have defect pixels caused by TFT characteristics. When the defect pixels are found, perform the Defect detection. For details about how to correct defect pixels, refer to 5.4.3 Defect Correction.</p> |
| | <p>Do not inflict excessive shock and mechanical vibration. Otherwise, it may result in poor image quality caused by noise.</p> |
| | <p>Do not unscrew or loosen the screws on the detector surface since all the screws are secured properly at the time of shipment. Otherwise, it may result in poor image quality or damage to equipment.</p> |
| | <p>This product may malfunction due to electromagnetic interference (EMI) caused by telecommunication devices, transceivers, electronic devices, etc. To prevent the electromagnetic wave from badly influencing the product, be sure to avoid placing it in close proximity to the product. Or, change direction or position of the product or move into the shielded place to reduce electromagnetic interference.</p> |
| | <p>To reduce the risk of electric shock, do not remove cover. No user-serviceable part inside. Refer servicing to qualified service personnel.</p> |

Battery Pack and Battery Charger Safety Information

Before using the battery pack and battery charger dedicated to ViVIX-S Wireless, read all applicable warnings and cautions.

Not following these instructions could result in electrical shock, fire, explosion or other conditions which may cause death, injury or property damages.

| | |
|---|--|
|  WARNING | <p>Do not use the battery pack as a power source for equipment other than ViVIX-S Wireless detectors. Be sure to use only the dedicated battery pack for the ViVIX-S Wireless detector.</p> |
|  WARNING | <p>The battery charger is designed for the dedicated battery pack. Do not use the battery charger other than the dedicated one. Otherwise, a battery explosion or a battery leak may occur, resulting in fire or electrical shock.</p> |
|  WARNING | <p>Do not operate the battery charger using any type of power supply other than the one indicated on the rating label.</p> |
|  WARNING | <p>Do not handle the product with wet hands.</p> |
|  WARNING | <p>Do not place heavy objects such as medical equipment on cables and cords, or do not pull, bend, bundle, or step on them to prevent their sheath from being damaged.</p> |
|  WARNING | <p>Do not attempt to disassemble, alter, or apply heat to the product.</p> |
|  WARNING | <p>Avoid dropping or subjecting the product to severe impacts. To avoid the risk of injury, do not touch the internal parts of the battery if it has been cracked or otherwise damaged.</p> |
|  WARNING | <p>Stop using the battery pack immediately if it emits smoke, a strange smell, or otherwise behaves abnormally.</p> |
|  WARNING | <p>Do not let the battery pack and battery charger come into contact with water or other liquids and do not allow them to get wet.</p> |
|  WARNING | <p>Do not clean with substances containing organic solvents such as alcohol, benzene, thinner, or other chemicals. Otherwise, fire or electrical shock may result.</p> |

| | |
|--|--|
| | <p>Do not allow dirt or metal objects (such as hair pins, clips, staples or keys) to contact the terminals. Otherwise, battery explosion or leakage of electrolyte may occur, resulting in fire, injury or pollution of surrounding area. If the battery leaks and the electrolytes come into contact with your eyes, mouth, skin or clothing, immediately wash it away with running water and seek medical attention.</p> |
| | <p>Do not leave, store, or place the product in a location near heat sources, or in a place subject to direct sunlight, high temperature, high humidity, excessive dust, or mechanical shock. Otherwise, battery leakage, overheating or damage to the product may occur, resulting in electrical shock, burns, injury or fire.</p> |
| | <p>Do not attempt to use a battery pack that has deteriorated. Using a battery pack that has exceeded its life cycle may lead to overheating, fire or explosion.</p> |
| | <p>The Lithium ion/polymer battery is recyclable.</p> <p>Battery slowly discharges even if not in use. The battery pack may have expired if it discharges immediately after being fully charged. You can purchase an optional battery pack to replace an exhausted one.</p> <p>The battery pack is a consumable item. If a fully charged battery is consumed quickly, use a new and fully charged battery pack.</p> |
| | <p>Be sure to charge the battery periodically (once a year) if it is not used for an extended period of time. The battery pack cannot be charged if it has been over discharged.</p> |
| | <p>Before discarding the battery pack, cover the terminals with adhesive tape or other insulators. Contact with other metal materials may cause fire or explosion.</p> |

General Hazards

Radiation Hazards

This system can be connected to x-ray generating equipment. Be certain to follow the safety instructions and specifications for wearing proper lead apron when x-ray exposures are planned or possible.

All personnel should wear protective equipment including dosimeters during all phases of installation, operation and maintenance of the system.

Electric Shock Hazards

To reduce the electric shock hazard, the system must be connected to an electrical ground. A three conductor AC power cable is supplied with this system to provide the proper electrical grounding. The power cable must be plugged into an UL-approved three-contact electrical outlet.

Do not disassemble or modify the product as it may result in fire or electric shock. There are no operator serviceable parts or adjustments inside the systems. Only trained and qualified personnel should be permitted access to the internal parts of the system.

Explosion Hazards

Do not operate the equipment in the presence of flammable or explosive liquids, vapors or gases. Do not plug in or turn on the system where hazardous substances are detected.

If flammable substances are detected after the system has been turned on, do not attempt to turn off the system or unplug it. Evacuate and ventilate the area before turning the system off.

Implosion Hazards

Do not hit or drop the equipment. The equipment may be damaged if it receives a strong jolt, which may result in fire or electric shock if the equipment is used without it being repaired.

Owner's Responsibility

The owner is responsible for ensuring that anyone using the system reads and understands the Service Manual and other relevant literature, and fully understands them. Vieworks makes no representation, however, that the act of reading this manual renders the reader qualified to operate, test and calibrate the system.



Do not use the system if unsafe conditions are known to exist. In case of hardware failure that could cause hazardous conditions (smoke, fire and etc), turn the power OFF and unplug the power cords of all sub-systems.

Notes for Using the Equipment

System Diagnostic

The **VXSetup** software runs a system diagnostic. Run **VXSetup** software after installing the system and at least once a year. If an error occurs, report the detailed error information to Vieworks local dealer or distributor.



The owner is responsible for ensuring that the system diagnostic is performed every year. Do not try to use the system if the system diagnostic is failed.

Calibration

To ensure optimal performance of the system, it is important to verify that the system is calibrated.



The owner is responsible for ensuring that the system calibration is performed after the system installation is completed or the system is repaired. Do not try to use the system if system calibration is not performed.

Distances measurements

Distances measurements in millimeters are possible only after distance calibration has been performed using a reference object (refer to VXvue User Manual).



The operator is responsible for performing distance calibration with a reference object and verifying the results of the distance calibration before taking any distance measurements on an image.

Left/Right Marker

The operator is responsible for the correct and clear marking on the left or right side of the image to eliminate possible errors.

The software includes an option to mark the image with L (left) or R (right) indicator from acquisition phase through printing and archiving. If the operator chose, for any reason, not to use L/R markers, he must use an alternative way to eliminate any possible mistake.



Image Backup

To avoid missing images which might result in patient being exposed to additional doses of radiation, it is important to backup the images by filming or by using a CD or DVD option. This should be done as a routine operation for every patient.

If the hard disk of your workstation is about to full, the operator should backup images and delete the images to make room on the hard disk for new patient.

User Limitations

The VXvue software has the technician mode which could only be operated with the inputting PASSWORD. The technician mode should be operated by the personnel who are qualified by Vieworks.

Cleaning the System

Use a dry cloth to clean surfaces of the system. Do not use detergents or organic solvents to clean the system. Strong detergent, and organic cleaners may damage the finish and cause structural weakening. Do not clean the system with turning the power on.

Disposal

Disposal of this product in an unlawful manner may have negative effects on health and on the environment. When disposing of this product, therefore, be absolutely sure to follow the procedure which is in conformity with the laws and regulations applicable in your area.



The expected life span of ViVIX-S Wireless system is about 3 years.

Overheating

Do not block the ventilation ports of the detector to prevent overheating of the detector. Overheating can cause system malfunction and damages.

Electrical fire

- This equipment is not suitable for use in the presence of a flammable anesthetic mixture with air or with oxygen or nitrous oxide.
- Conductive fluids that drain into the active circuit components of the system may cause short circuits that can result in electrical fire. Therefore, do not place fluids or food on any part of the system.
- To avoid electric shocks and burns caused by use of the wrong type of fire extinguisher, make sure that the fire extinguisher at the site has been approved for use on electrical fires.



Handling the Equipment

The Equipment must be handled with care to avoid personal injury damage to the internal image sensor.



- Do not put pressure on the detector locally since it will cause permanent damage to the internal image sensor.
- Excessive weight on the equipment may damage the internal image sensor.
- It is recommended to use the case, in case if a patient should be positioned to put pressure on the detector while acquiring images.

| Load Limit | Specifications |
|--------------|--|
| Uniform Load | 150 kg over the whole area of the detector surface |
| Local Load | 100 kg on an area 40 mm in diameter |

Pediatric Application

- Every request should be reviewed by the pediatric radiologist prior to beginning the examination to insure correct study is being performed.
- If the technologist notices an unusual request, they should contact the pediatric radiologist. An example should be from pediatric clinic where they order a Full Cervical, Thoracic, and Lumbar Spine series. The pediatric radiologist should contact ordering physician and decide which study is the best for this pediatric patient.
- The technologist should use the proper technique for the patient's size to decrease the radiation dose when the technologist acquires diagnostic images.
- ALL Pediatric patients shall be shielded for their x-ray examinations, except for when the shield will obscure the region of interest, as in a pelvic or SI joint xray for trauma or arthritis, or when it is physically or clinically unreasonable to shield the patient. For routine Hip X-Rays, ALL male children shall have their scrotum shielded using the small gonadal shield, females may not be shielded as this would obscure the hips.
- To minimize motion in infants and young children, swaddle the infant. Use distraction tools to improve cooperation and projectors with child-friendly themes, music, toys with flashing lights or music, child-friendly images on the ceiling or walls, singing, counting, and a parent reading and talking to the child through the console all can help reduce anxiety and comfort the child.
- A Scoliosis series will consist of a single frontal standing view of the spine. No lateral view or supine view is needed, unless specifically asked for by the Orthopedist or Radiologist. If the female's breasts can be shielded without obscuring the spine, breast shields should be used.



Regulatory

Medical Equipment Classifications

| | |
|---|--|
| Type of protection against electrical shock | Class I equipment |
| Degree of protection against ingress of water | IPX0 |
| Mode of operation | Continuous operation |
| Flammable anesthetics | NOT suitable for use in the presence of a flammable anesthetic mixture with air or with oxygen or nitrous oxide. |

Equipment Standards

| | |
|----------------------------|--|
| IEC/EN/UL 60601-1 | Medical electrical equipment |
| CSA C22.2 No. 601.1 | Part 1: General requirements for safety |
| IEC/EN 60601-1-2 | Medical electrical equipment Part 2: Electromagnetic compatibility—requirements and tests |
| IEEE 802.11a/b/g/n | Wireless Communications |



Guidance and Manufacturer’s Declaration for EMC Directive

This device has been tested for EMI/EMC compliance, but interference can still occur in an electromagnetically noisy location. Attempt to maintain a suitable distance between electrical devices to prevent malfunction.

Electromagnetic Emissions

The Equipment Under Test (EUT) is intended for use in the electromagnetic environment specified below. The customer or user of the EUT should assure that it is used in such an environment.

| Immunity Test | Compliance | Electromagnetic Environment – Guidance |
|---|------------|---|
| RF Emissions CISPR 11 | Group 1 | The EUT uses RF energy only for its internal function. Therefore, its RF emissions are very low and are not likely to cause any interference in nearby electronic equipment. |
| RF Emissions CISPR 11 | Class A | The EUT is suitable for use in all establishments other than domestic and those directly connected to the public low-voltage power supply network that supplies buildings used for domestic purposes. |
| Harmonic emissions IEC 61000-3-2 | Class A | |
| Voltage fluctuations/ Flicker emissions IEC 61000-3-3 | Complies | |



Electromagnetic Immunity

The EUT is intended for use in the electromagnetic environment specified below.

The customer or user of the EUT should assure that it is used in such an environment.

| Immunity Test | IEC 60601 Test Level | Compliance Level | Electromagnetic Environment – Guidance |
|--|---|---|--|
| Electrostatic discharge (ESD) IEC 61000-4-2 | ±6 kV contact ±8 kV air | ±6 kV contact ±8 kV air | Floors should be wood, concrete or ceramic tile. If floors are covered with synthetic material, the relative humidity should be at least 30%. |
| Electrical fast transient/burst IEC 61000-4-4 | ±2 kV for power supply lines ± 1 kV for input/output lines | ±2 kV for power supply lines ± 1 kV for input/output lines | Mains power quality should be that of a typical commercial or hospital environment. |
| Surge IEC 61000-4-5 | ±1 kV differential mode ±2 kV common mode | ±1 kV differential mode ±2 kV common mode | Mains power quality should be that of a typical commercial or hospital environment. |
| Voltage dips, short interruptions and voltage variations on power supply input lines IEC 61000-4-11 | <5% U_T (>95% dip in U_T) for 0.5 cycle. 40% U_T (60% dip in U_T) for 5 cycles. 70% U_T (30% dip in U_T) for 25 cycles. <5% U_T (<95% dip in U_T) for 5 sec. | <5% U_T (>95% dip in U_T) for 0.5 cycle. 40% U_T (60% dip in U_T) for 5 cycles. 70% U_T (30% dip in U_T) for 25 cycles. <5% U_T (<95% dip in U_T) for 5 sec. | Mains power quality should be that of a typical commercial or hospital environment. If the user of the EUT image intensifier requires continued operation during power mains interruptions, it is recommended that the EUT image intensifier be powered from an uninterruptible power supply or a battery. |
| Power frequency (50/60 Hz) magnetic field IEC 61000-4-8 | 3 A/m | 3 A/m | Power frequency magnetic fields should be at levels characteristic of a typical location in a typical commercial or hospital environment. |

NOTE: U_T is the a.c. mains voltage prior to application of the test level.

| Immunity Test | IEC 60601 Test Level | Compliance Level | Electromagnetic Environment – Guidance |
|-------------------------------|--------------------------|--------------------------|---|
| Conducted RF IEC 61000-4-6 | 3 Vrms 150 kHz to 80 MHz | 3 Vrms 150 kHz to 80 MHz | Portable and mobile RF communications equipment should be used no closer to any part of the EUT, including cables, than the recommended separation distance calculated from the equation applicable to the frequency of the transmitter. |
| Radiated RF IEC 61000-4-3 | 3 V/m 80 MHz to 2.5 GHz | 3 V/m 80 MHz to 2.5 GHz | <p>Recommended separation distance</p> $d = \left[\frac{3.5}{V_1} \right] \sqrt{P}$ $d = \left[\frac{3.5}{V_1} \right] \sqrt{P} \text{ 80 MHz to 800 MHz}$ $d = \left[\frac{7}{E_1} \right] \sqrt{P} \text{ 80 MHz to 800 MHz}$ <p>Where P is the maximum output power rating of the transmitter in watts (W) according to the transmitter manufacturer and d is the recommended separation distance in meters (m).</p> <p>Field strengths from fixed RF transmitters, as determined by an electromagnetic site survey^a, should be less than the compliance level in each frequency range.^b</p> <p>Interference may occur in the vicinity of equipment marked with the following symbol:</p>  |

NOTE 1: At 80 MHz and 800 MHz, the higher frequency range applies.

NOTE 2: These guidelines may not apply in all situations. Electromagnetic propagation is affected by absorption and reflection from structures, objects and people.

^a Field strengths from fixed transmitters, such as base stations for radio (cellular/cordless) telephones and land mobile radios, amateur radio, AM and FM radio broadcast and TV broadcast cannot be predicted theoretically with accuracy. To assess the electromagnetic environment due to fixed RF transmitters, an electromagnetic site survey should be considered. If the measured field strength in the location in which the EUT is used exceeds the applicable RF compliance level above, the EUT should be observed to verify normal operation. If abnormal performance is observed, additional measures may be necessary, such as reorienting or relocating the EUT.

^b Over the frequency range 150 kHz to 80 MHz, field strengths should be less than [V₁] V/m.



Label and Symbols

Detectors

FXRD-1417WA

Vieworks
Digital Imaging Systems **CE 0434**

ViVIX-S

Part No.: FXRD-1417WA Flat Panel Detector

SN:  VPO9P112001

Rating: 4,000mAh / 24V---Max. 0.5A

 2012.03
Date of manufacture: March

 UL 60601-1/CAM/CAS
C22.2 No. 601.1
47CE

Caution: Federal law restricts this device to sale by or on the order of a physician or a licensed practitioner.

CAUTION: To reduce the risk of electric shock, do not remove cover. No user-serviceable part inside. Refer servicing to qualified service personnel.

 **Manufacturer: Vieworks Co., Ltd.**
#107-108, 601-610
Suntechoity Il 52, Sagimakgol-ro,
Jungseo-gu, Seongnam-si, Gyeonggi-do, 462-808
South Korea **MADE IN KOREA**

FXRD-1417WB

Vieworks
Digital Imaging Systems **CE 0434**

ViVIX-S

Part No.: FXRD-1417WB Flat Panel Detector

SN:  VPO9P112001

Rating: 4,000mAh / 24V---Max. 0.5A

 2012.03
Date of manufacture: March

 UL 60601-1/CAM/CAS
C22.2 No. 601.1
47CE

Caution: Federal law restricts this device to sale by or on the order of a physician or a licensed practitioner.

CAUTION: To reduce the risk of electric shock, do not remove cover. No user-serviceable part inside. Refer servicing to qualified service personnel.

 **Manufacturer: Vieworks Co., Ltd.**
#107-108, 601-610
Suntechoity Il 52, Sagimakgol-ro,
Jungseo-gu, Seongnam-si, Gyeonggi-do, 462-808
South Korea **MADE IN KOREA**



System Control Unit

Vieworks
Digital Imaging Systems CE 0434

ViVIX-S

Part No.: FXRS-03A System Control Unit

SN:  
Follow instructions for use

VP09P112001

Rating: AC 100V - 240V, 50/60Hz, Max. 200VA
(Use Only 120V in the U.S.)

 2012.03
Date of manufacture: March

 **CLASSIFIED**
UL 60601-1/CAN/CSA
C22.2 No. 601.1
47CE

Caution: Federal law restricts this device to sale by or on the order of a physician or a licensed practitioner.

CAUTION:  To reduce the risk of electric shock, do not remove cover. No user-serviceable part inside. Refer servicing to qualified service personnel.

 **Manufacturer: Vieworks Co., Ltd.**
#107-108, 601-610 Suntechcityll, 52, Sagimakgol-ro, Jungwon-gu, Seongnam-si, Gyeonggi-do, 462-808 South Korea **MADE IN KOREA**

Battery Charger

Vieworks

Battery Charger CE

Part No.: FXRC-01A 

SN:  VP09P112001

Rating: 24V  Max. 2.7A

Date of manufacture: March. 2012

 **CAUTION:**
To reduce the risk of electric shock, do not remove cover. No user-serviceable part inside. Refer servicing to qualified service personnel.

Electric Shock

 **Manufacturer: Vieworks Co., Ltd.**
#107-108, 601-610 Suntechcityll, 52, Sagimakgol-ro, Jungwon-gu, Seongnam-si, Gyeonggi-do 462-736, South Korea **MADE IN KOREA**

Symbols

| Symbol | Description |
|--------|---|
| | Direct Current |
| | Alternating Current |
| | Protective Earth (Ground) |
| | Equipotentiality |
| | Power Off |
| | Attention, consult accompanying documents |
| | Power On |
| | Medical Equipment With Respect to electric shock, fire, and mechanical hazards only In accordance with UL60601-1 and CAN/CSA C22.2 No. 601.1. |
| | This mark shows compliance of the equipment with Directive 93/42/EEC. |
| | Read and understand all instructions and warning labels in the product documentation before using the equipment. Keep manual for future reference. |



1. Overview

The **ViVIX-S Wireless** is advanced wireless flat panel X-ray imaging system designed for digital radiography. The lightweight wireless digital radiography is designed to be compatible with conventional X-ray film cassettes so that the users who are not familiar with Digital Radiography (DR) can easily understand and use the **ViVIX-S** system. In addition, the wireless communication (IEEE 802.11a/b/g/n) feature improves the operability and high-speed processing.

1.1 Features

- Wireless LAN communication (IEEE 802.11a/b/g/n) feature
- Supporting Conventional 35 × 43 X-ray film cassette
- Compatible with not only new X-ray generators based on DR interface but also conventional X-ray generators
- Designed with simple wiring and lightweight for portable applications
- Image digitization, image inversion, image processing, zooming, panning, window level adjustment, contrast adjustment, and various features enable the operator to see diagnostic details that is difficult to see by using conventional non-digital techniques.
- Depending on the operating environment, the Ether Con Cable (optional) enables the device to be used through expansion to a wired connection.

1.2 Intended Use

The **ViVIX-S** Digital X-ray detector is indicated for digital imaging solution designed for providing general radiographic diagnosis of human anatomy. This device is intended to replace film or screen based radiographic systems in all general purpose diagnostic procedures. This device is not intended for mammography applications.

1.3 Standard Configuration

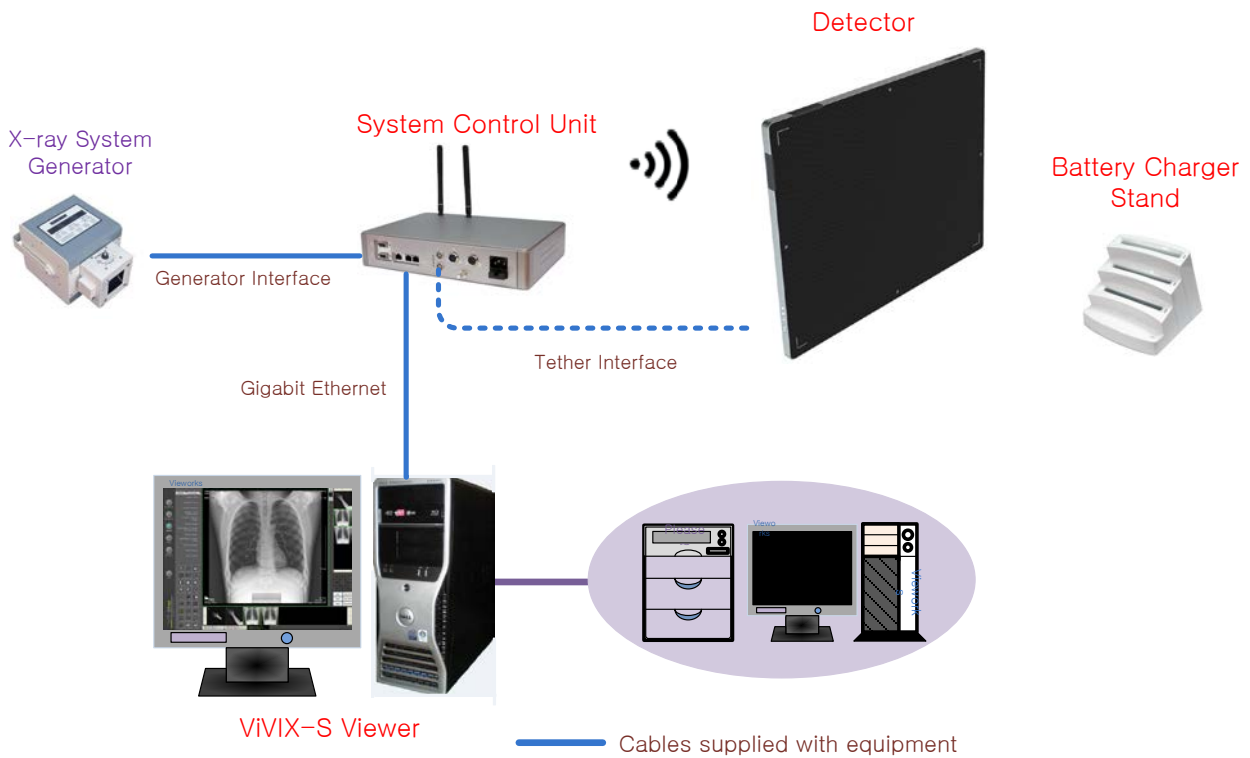

Figure 1.1 ViVIX-S Wireless System Configuration

Wireless communication is established between the ViVIX-S Wireless detector and System Control Unit. The ViVIX-S system is compliant with IEEE 802.11a/b/g/n (2.4 GHz / 5 GHz). The available frequency band may vary depending on local radio laws and system requirements. Consult your local dealer for the frequency available in your area.

| | |
|--|--|
| | <p>Use of multiple WLAN devices within the same frequency band may interfere with each wireless communication and cause a decline in transmission speed.</p> |
| | <p>Do not cover or block the wireless module of the detector. Otherwise, the transmission speed or operable distance may be reduced.</p> |
| | <p>Recommended maximum operating distance of wireless communication between the detector and System Control Unit is 8 meters.</p> |



2. Product Description

ViVIX-S Wireless system consists of detector, system control unit (SCU), battery charger, battery pack, software and its accessories.

2.1 Product Components

Detector

- FXRD-1417WA (scintillator: Csl (TI))
- FXRD-1417WB (scintillator: Gadox)

System Control Unit (SCU)

- FXRS-03A

Battery Charger and Battery Pack

- FXRC-01A
- FXRB-01A

Software

- Viewer: VXvue
- Calibration and Diagnostic: VXSetup

Accessories (Cables)

- AC Power Cable (2M)
- Generator Interface Cable (15M)
- Direct LAN Cable 15M (1000BASE-T)
- Tether Interface Cable (3M)



The use of accessories and cables other than those specified, with the exception of **ViVIX-S Wireless** accessories and cables sold by Vieworks Co., LTD. as replacement parts for internal components, may result in increased emissions or decreased immunity of the equipment.

Accessory equipment connected to the analog and digital interfaces must be certified according to the respective IEC standards. All combinations of equipment must be in compliance with IEC 60601-1-1 system requirements. Any person who connects additional equipment to the signal input or signal output ports configures a medical system, and is therefore responsible for ensuring that the system complies with the requirements of the system standard IEC 60601-1. If in doubt, consult Vieworks technical support representative.

Workstation (Recommended but NOT included)

- Operating System Microsoft Windows XP 32 bit SP3 (Professional Edition), Windows 7 32 bit SP1 (Professional Edition or higher) or Windows 7 64 bit SP1 (Professional Edition or higher)
- CPU Intel Core i5 2600 or higher (or equivalent AMD chips)
- Memory 2 GB or higher
- Hard Disk 1 TB or higher
- Ethernet (NIC) Intel® PRO 1000 Series (PT, CT, etc)
Min. Requirements: 1Gbps, Jumbo Frames - 9K, Receive Descriptors - 2K
- Monitor 1280 × 800 or higher
- CD-Rom CD or DVD R/W or blu-ray



2.2 Detector

2.2.1 Detector Specifications

| Item | Description |
|---|---|
| Model | FXRD-1417WA(B) |
| Purpose | General radiography |
| Image Matrix Size | 2560 × 3072 pixels |
| Pixel Pitch | 140 μm |
| Effective Imaging Area | 358 mm × 430 mm |
| Grayscale | 14 bit, 16,384 grayscale |
| Scintillator | CsI (Cesium Iodide) or Gadox (Gadolinium Oxysulfide) |
| Image Acquire and Transfer Time | Preview: 2 s, Image Processing: 6.5 s (2 s when using Tether Interface) |
| Spatial Resolution | Min. 3.5 line pair/mm |
| Rated Power Supply | DC +24 V, Max. 0.5 A |
| <ul style="list-style-type: none"> Wireless Wired | <ul style="list-style-type: none"> Powered by the battery pack (4,000 mA h) Powered by the SCU using tether interface |
| Power Consumption | Max. 12 W |
| Wireless Communications | IEEE 802.11a/b/g/n (2.4 GHz / 5 GHz) |
| [†] Tether Interface (Optional) | Gigabit Ethernet (1000BASE-T) via [‡] PoE |
| Imaging Plate | Carbon Fiber Plate |
| Cooling | Air cooling |
| Dimensions (H × W × D) | 384 mm × 460 mm × 15 mm |
| Weight | 3.0 kg (including battery pack) |
| Environmental Requirements | |
| Operation | Temperature: +10 ~ +35 °C Humidity: 30 ~ 85% (Non-Condensing) Atmospheric pressure: 70 ~ 106 kPa Altitude: Maximum 2000 meters |
| Storage and transportation | Temperature: -15 ~ +55 °C Humidity: 10 ~ 90% (Non-Condensing) Atmospheric pressure: 50 ~ 106 kPa Altitude: Maximum 2000 meters |

Table 2.1 Detector Specifications

[†]**Tether Interface:** Allows the detector to communicate with SCU via Ethernet cabling when wireless communications is not available or higher speed data transfer is necessary.

[‡]**PoE (Power over Ethernet):** Delivers electrical power over LAN cabling to the networked device.

2.2.2 Detector Components



Figure 2.1 Detector Components

| No. | Name | Description |
|-----|---------------------------------------|---|
| 1 | Status Indicators Power button | A: Data LED, Indicates communication and transmission status. - Blue B: Active LED, Indicates the detector is ready to work. - Orange C: Power LED, Indicates power on/off status. - Green D: Power button, Press to power on or off the detector. |
| 2 | Wireless Module | Transmits data with wireless communications (IEEE 802.11a/b/g/n). |
| 3 | Tether Interface | Allows the detector to communicate with SCU via PoE cabling (Gigabit Ethernet 1000BASE-T) |
| 4 | Battery Pack | Supplies electrical power to the detector while communicating wirelessly. |

Table 2.2 Detector Components Description



2.2.3 Detector Dimension

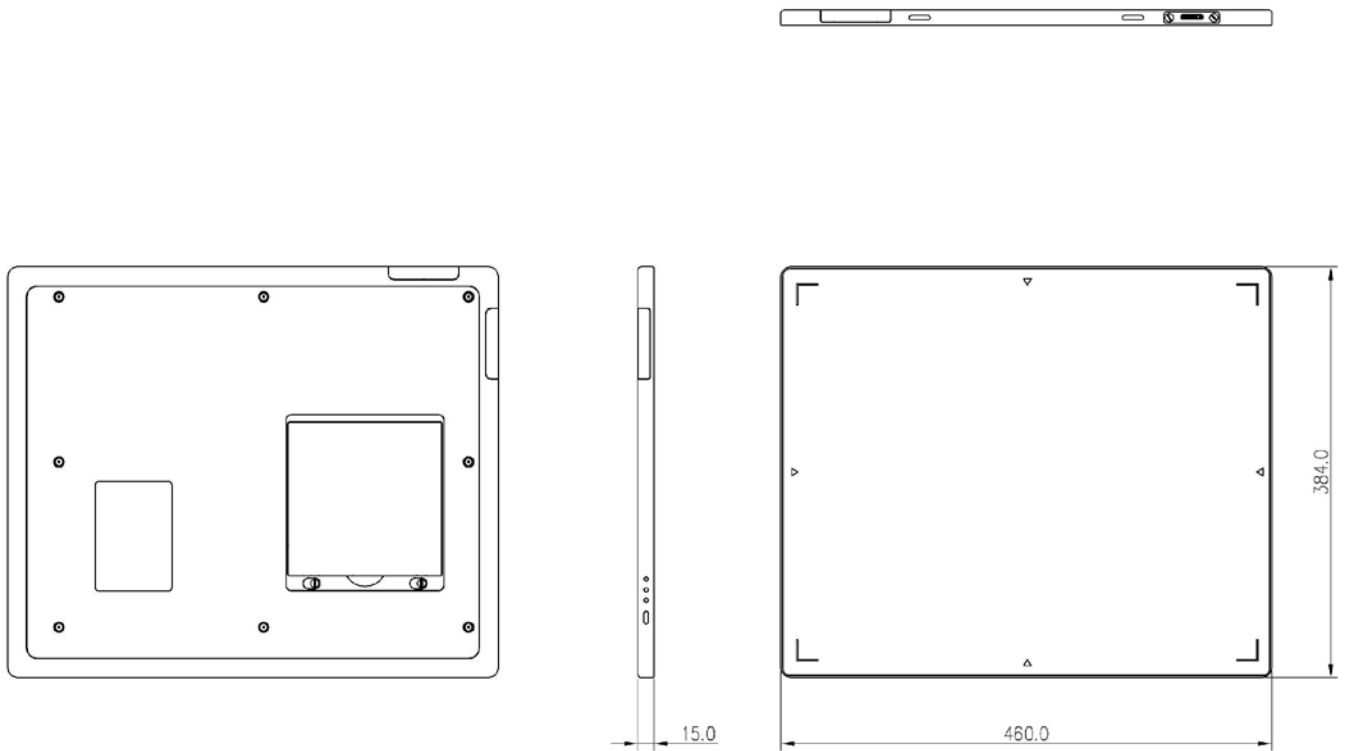

Figure 2.2 Detector Dimension



2.3 System Control Unit

2.3.1 System Control Unit Specifications

| Item | Description |
|----------------------------|--|
| Model | FXRS-03A |
| Power Supply | Input: AC100 to 240V, 50/60 Hz, Max. 200VA Output: DC +24V 3.3A, 80W |
| Cabling Ports | Gigabit Ethernet Ports – 3EA Power over Ethernet Ports – 2EA (Only for FXRD-1417) |
| Wireless Communications | IEEE 802.11a/b/g/n (2.4 GHz / 5 GHz) |
| Dimensions (W × H × D) | 300 mm × 235.8 mm × 58 mm, Antenna Height – 105 mm |
| Weight | 2.5 kg |
| Environmental Requirements | |
| Operation | Temperature: +10 ~ +35°C Humidity: 30 ~ 85% (Non-Condensing) Atmospheric pressure: 70 ~ 106 kPa Altitude: Maximum 2000 meters |
| Storage and transportation | Temperature: -15 ~ +55°C Humidity: 10 ~ 90% (Non-Condensing) Atmospheric pressure: 50 ~ 106 kPa Altitude: Maximum 2000 meters |

Table 2.3 System Control Unit Specifications

2.3.2 System Control Unit Components

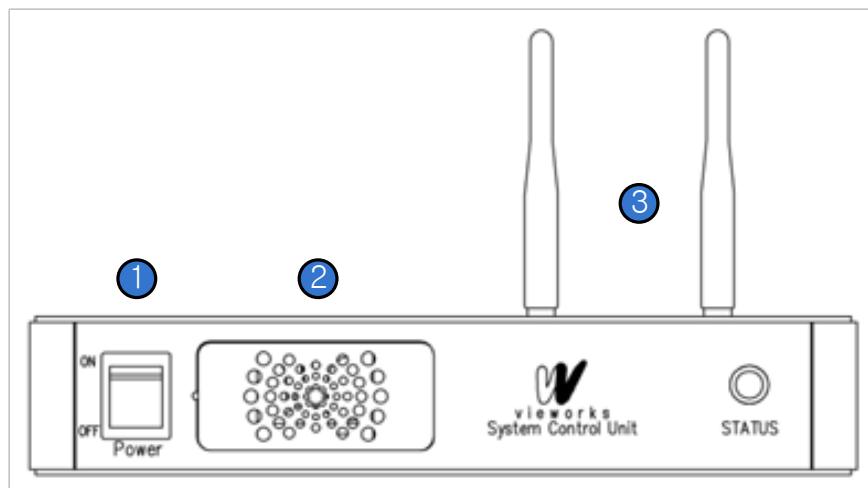

Figure 2.3 System Control Unit (Front)

| No. | Name | Description |
|-----|--------------|---|
| 1 | Power Switch | Turns on or off the SCU. |
| 2 | Fan | Expels heated air inside of the SCU. |
| 3 | Antenna | Assists communications between the detector and SCU. |
| 4 | Status LED | Indicates status of SCU operation and connection. <ul style="list-style-type: none"> Blinking Green: Startup in progress Blue: Connected to Wi-Fi network |

Table 2.4 System Control Unit Components (Front)

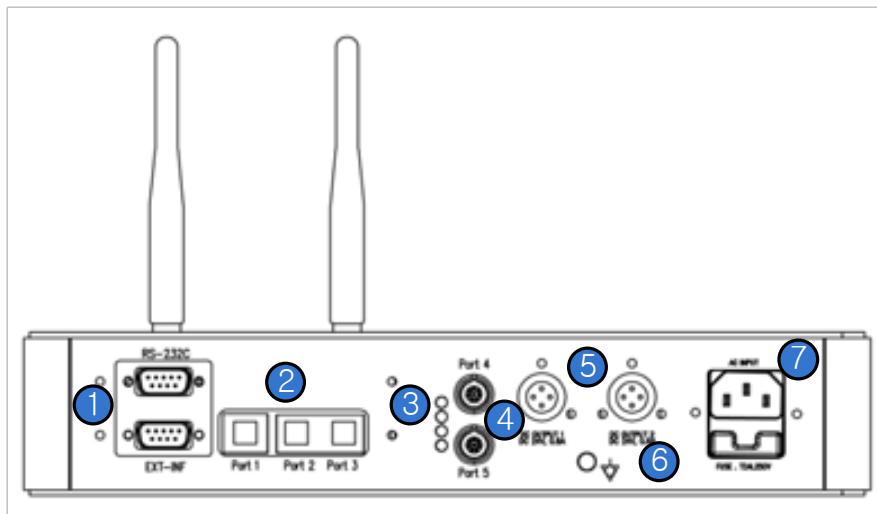

Figure 2.4 System Control Unit (Back)

| No. | Name | Description |
|-----|----------------|---|
| 1 | EXT_INF | <ul style="list-style-type: none"> Provides connection to the X-ray generator. |
| 2 | Port 1 | <ul style="list-style-type: none"> Provides Gigabit Ethernet (1000BASE – T) communication between the workstation and SCU. Gigabit Ethernet (1000BASE – T) Port |
| | Port 2, Port 3 | <ul style="list-style-type: none"> Provides communication between FXRD-1717 and SCU when configuring multiple detectors. Gigabit Ethernet (1000BASE – T) Port |
| 3 | Status LED | <ul style="list-style-type: none"> Indicates Port 4 and Port 5 status (Green: 1Gbps, Orange: 100Mbps) |
| 4 | Port 4, Port 5 | <ul style="list-style-type: none"> Connection interface to communicate with the detector and to supply electrical power to the detector (Only for FXRD-1417). Power over Ethernet Port (1000BASE-T) |
| 5 | Power Supply | <ul style="list-style-type: none"> Connection interface to supply power to a FXRD-1717 detector. Max. DC +24V/24W (×2 ports) |
| 6 | P.E | <ul style="list-style-type: none"> Provides connection to equipotential ground. |
| 7 | AC Input | <ul style="list-style-type: none"> Connect the power cable to the power socket. 100 ~ 240V, 50/60 Hz, T2AL250V Fuse (2 EA) |

Table 2.5 System Control Unit Components (Back)



P.E (Potential Equalization) of SCU is used to keep equipotential between SCU and an equipment to be used with Vivix-S Wireless. To connect to P.E of equipment, use a ground cable.



2.3.3 SCU Dimension

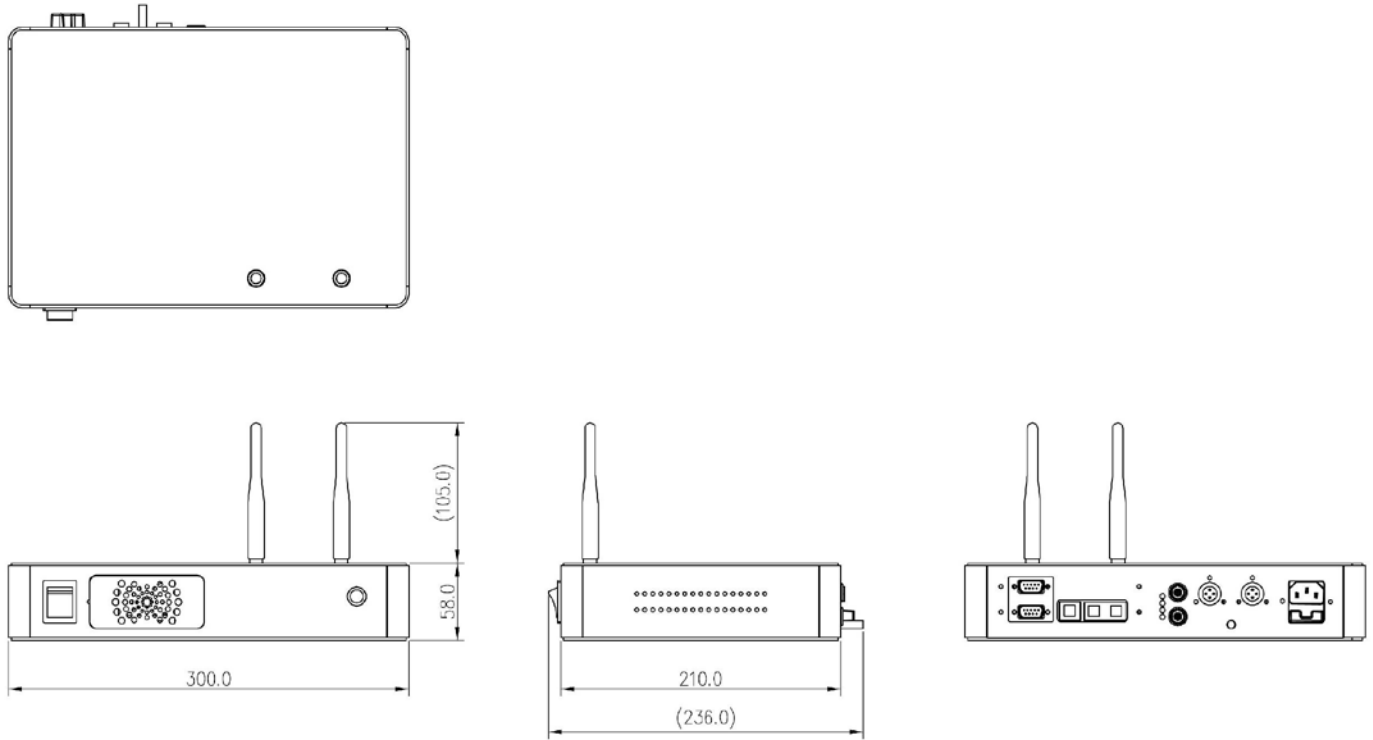

Figure 2.5 SCU Dimension

2.3.4 Fuse

Two fuses are installed inside of SCU to prevent electrical accidents due to an error such as overcurrent occurred in the AC Input. Stop immediately using SCU when fuses break.

| Item | Description |
|----------------|---------------------------|
| Model | Littlefuse® 218002 (2 EA) |
| Type | Time Lag Cartridge Fuse |
| Amp Rating | 2 A |
| Voltage Rating | 250 V |

Replacing Fuses



- Turn off SCU and its peripheral equipment, and pull the plug out of the power socket before replacing fuses.
- When fuses break, resolve the cause of overcurrent first, and then replace the fuses with extra fuses (optional items, one set of two) or equivalent rating fuses.
- User must not contact a fuse holder with a patient simultaneously during operating the equipment and not allow patient to touch the fuse holder.

1. Pull the fuse holder out from its receptacle under AC Input on the back panel of SCU.



2. Check the fuse(s) and replace it if necessary, using the fuse type and rating specified above.



3. Push the fuse holder back.

2.4 Battery Charger and Battery Pack

2.4.1 Battery Charger Specifications

| Item | Description |
|-----------------------|--------------------------------|
| Model | FXRC-01A |
| Simultaneous Charging | Battery Pack 3 EA |
| Charging Time | 2 hours |
| Rated Power Supply | DC +24V, 2.7 A Max. |
| Dimension (W × H × D) | 192.0 mm × 167.5 mm × 223.4 mm |
| Weight | 1.2 kg |

Table 2.6 Battery Charger Specifications

2.4.2 Battery Charger Components



Figure 2.6 Battery Charger

| No. | Name | Description |
|-----|---------------------|--|
| 1 | Battery Compartment | Insert the battery pack to charge. |
| 2 | Charging Indicator | Indicates the charging status. (Orange: Charging, Green: Fully Charged) |
| 3 | Power Indicator | Indicates the power on/off status. |
| 4 | DC Input | Connect the DC adapter to supply electrical power to the battery charger. |

Table 2.7 Battery Charger Components



2.4.3 Battery Charger Dimension

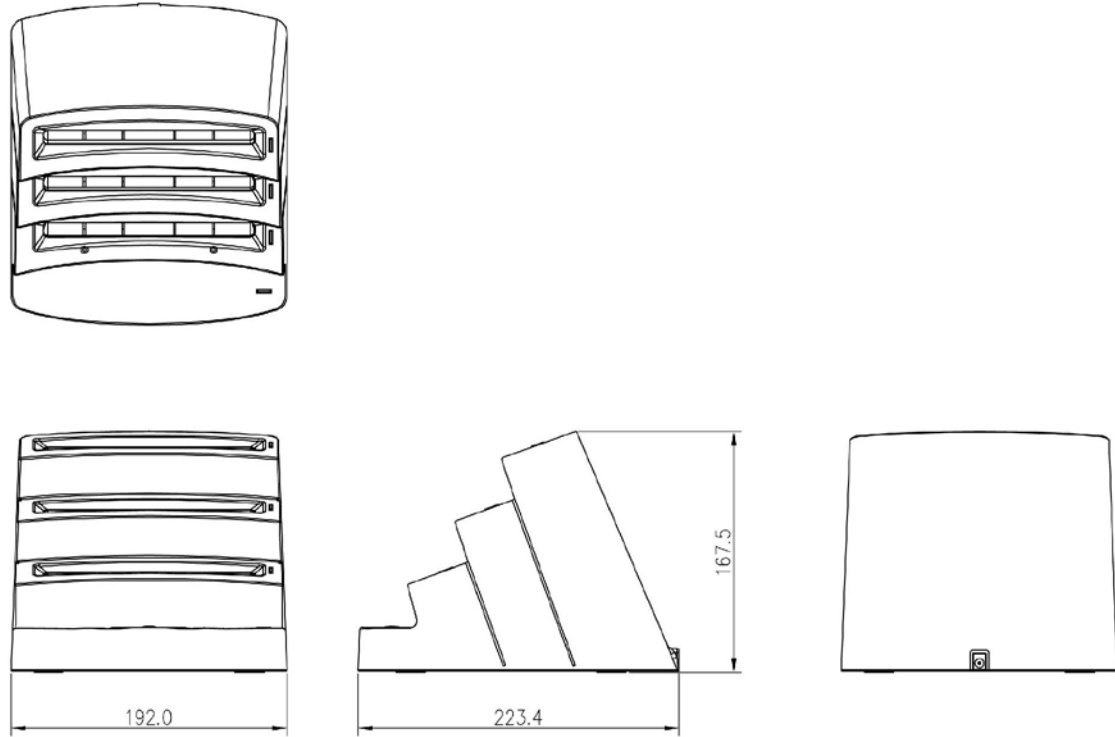

Figure 2.7 Battery Charger Dimension

2.5 Battery Pack

2.5.1 Battery Pack Specifications

| Item | Description |
|-----------------------|------------------------------|
| Model | FXRB-01A |
| Type | Lithium Polymer |
| Rated Power Supply | Output: DC +7.4V |
| Capacity | 4000 mA h |
| Number of Cell | 2S1P (2 Series 1 Parallel) |
| Dimension (W × H × D) | 144.4 mm × 143.4 mm × 7.0 mm |
| Weight | 220 g |

Table 2.8 Battery Pack Specifications

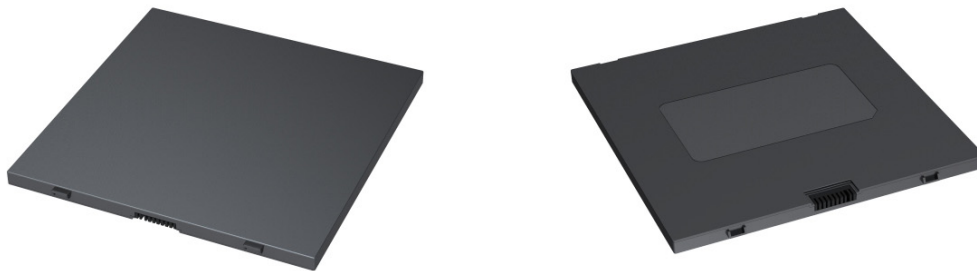

Figure 2.8 Battery Pack

2.5.2 Battery Pack Dimension

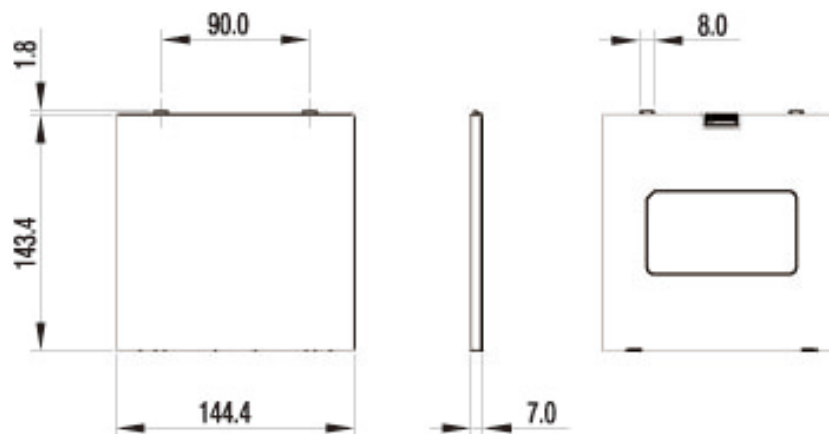







Figure 2.9 Battery Pack Dimension

2.5.3 Charging Battery Pack

The battery pack supplies power to the detector during wireless connection. Be sure to use only the dedicated battery pack and fully charge it before use.

- 1 Connect the power cable (adapter not included) to the DC Input port of the battery charger and the power cord to the power source to supply power. The power LED lights in green indicating the presence of direct current (DC) power.
- 2 Insert the battery pack into the battery charger. Charging starts automatically. The charge LED lights orange when the battery pack is being charged. After the battery pack is charged completely, the charge LED lights in green.
- 3 Gently pull the charged battery pack to remove from the battery charger.

| | |
|---|---|
|  WARNING | Securely plug the power cord into the power source. If contact failure occurs, or if dust or metal objects come into contact with the exposed metal prongs of the plug, fire or electrical shock may occur. |
|  CAUTION | Be sure to stop charging the battery pack when the charge LED lights in green beyond the specified charging time. Not doing so may result in battery pack overheating or smoking or in explosion or fire. |
|  CAUTION | You must use the power adaptor that is certified with IEC 60950 or IEC 60601-1. |
|  | Three batteries can be charged at the same time. |
|  | It takes approximately two hours to fully charge a battery pack. The required charging time may vary depending on the temperature and remaining battery level. |

2.6 X-ray Generator Interface

2.6.1 X-ray Exposure Mode

| Mode | Description |
|-----------------|---|
| DR Trigger Mode | <ol style="list-style-type: none"> 1 The detector receives EXP_REQ signal that X-ray generator is prepared to generate X-rays. 2 The detector prepares image acquiring and then responds EXP_OK signal to the X-ray generator. 3 The X-ray generator confirms EXP_OK signal and generates X-rays, then the detector performs image acquiring according to Image Acquisition Time and transmits the image data. <ul style="list-style-type: none"> • EXP_REQ (Generator → Detector), EXP_OK (Detector → Generator) |
| AED Mode | <ul style="list-style-type: none"> • The detector detects actual amount of X-rays without any connection to the X-ray generator, and then performs image acquiring according to Image Acquisition Time and transmits the image data. • No signal used (No need to connect Generator Interface Cable.) |

Table 2.9 Exposure Mode

2.6.1.1 DR Trigger Mode

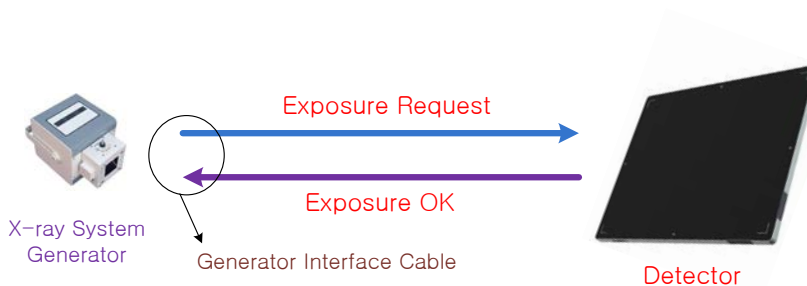

Figure 2.10 DR Trigger Mode Configuration

- DR Trigger is the most common and recommended exposure mode. User can achieve the best quality images with DR Trigger Mode.

2.6.1.2 AED Mode



Figure 2.11 AED Configuration

- AED is available for acquiring images without any connection to X-ray generator. Generator interface cable is not required.



- Make sure to follow operating environmental requirements (Temp: +10°C ~ +35°C).
- If you use AED Mode out of operating environmental requirements, unwanted image can be acquired without X-ray image acquiring.
- Do not hit or drop the equipment. Unwanted images may be acquired in the AED Mode if it receives strong jolt.
- If you use a Grid under general imaging condition (Dose) or image a thick object in the AED Mode, the efficiency of X-ray transformation may be reduced about 0% ~ 2% compared to the DR Trigger Mode according to the thickness of the target.
- If you image a thick object in the AED Mode with low X-ray tube voltage, an image may not be acquired or horizontal line noise may occur.

2.6.2 Timing of Signals (DR Trigger Mode)

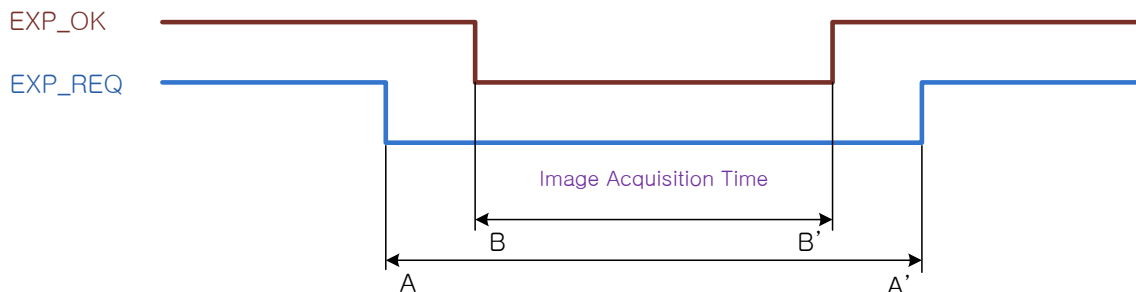

Figure 2.12 Timing of Exposure signal

- Image Acquisition Time+
 - Exposure request signal A (EXP_REQ) should be applied first, then exposure respond signal B (EXP_OK).
 - Image Acquisition Time can be set from 40 ms to 4,000 ms with 1 ms increment when default value is 500 ms.

2.6.3 EXT_INF Port Pin Assignment

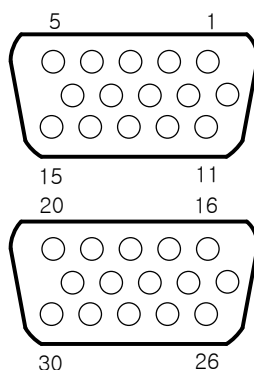

Figure 2.13 EXT_INF port pin assignments



| No. | Signal Name | I/O | Color | Description |
|-----|----------------|--------|-------------|--|
| 1 | EXP_REQ+_A | Input | Red | <ul style="list-style-type: none"> Detector receives signal that X-ray generator is prepared to generate X-rays. Contact Type – On: Closed, Off: Open For the 1st DR Interface of Generator |
| 2 | EXP_REQ-_A | Input | Black | Return signal from EXP_REQ+_A. |
| 3 | EXP_REQ_TTL_A | Input | Orange | <ul style="list-style-type: none"> Detector receives signal that X-ray generator is prepared to generate X-rays. TTL (Voltage) Type – On: VCC, Off: GND Current (5 mA ~ 10 mA), Voltage (12 V ~ 24 V) For the 1st DR Interface of Generator |
| 4 | EXP_REQ_GND_A | Input | Gray | Return signal from EXP_REQ_TTL_A |
| 5 | EXP_OK_POWER_A | Input | Yellow | <ul style="list-style-type: none"> Power of TTL signal coming from X-ray generator This is for the 1st DR Interface of Generator, but it can be shared with the 2nd DR Interface. |
| 6 | EXP_OK+_A | Output | Green | <ul style="list-style-type: none"> Detector responds to X-ray generator about X-ray generation. The X-ray generator generates X-rays according to this signal and then the detector performs X-ray image acquiring. For the 1st DR Interface of Generator |
| 7 | EXP_OK-_A | Output | Brown | Return signal from EXP_OK+_A |
| 8 | EXP_OK+_B | Output | Blue | Same as “EXP_OK+_A” for the 2nd DR Interface of Generator. |
| 9 | EXP_OK-_B | Output | Pink | Same as “EXP_OK-_A” for the 2nd DR Interface of Generator. |
| 10 | Reserved | - | - | Do not connect. Reserved for testing. |
| 11 | EXP_REQ+_B | Input | White | Same as “EXP_REQ+_A” for the 2nd DR Interface of Generator. |
| 12 | EXP_REQ-_B | Input | Purple | Same as “EXP_REQ-_A” for the 2nd DR Interface of Generator. |
| 13 | EXP_REQ_TTL_B | Input | White/Red | Same as “EXP_REQ_TTL_A” for the 2nd DR Interface of Generator. |
| 14 | EXP_REQ_GND_B | Input | White/Black | Same as “EXP_REQ_GND_A” for the 2nd DR Interface of Generator. |
| 15 | Reserved | - | - | Do not connect. Reserved for testing. |

Table 2.10 EXT_INF1 port pin description (1 ~ 15)



| No. | Signal Name | I/O | Color | Description |
|-----|----------------|--------|--------|---|
| 16 | EXP_REQ+_C | Input | Red | Same as "EXP_REQ+_A" for the 3rd DR Interface of Generator. |
| 17 | EXP_REQ-_C | Input | Black | Same as "EXP_REQ-_A" for the 3rd DR Interface of Generator. |
| 18 | EXP_REQ_TTL_C | Input | Orange | Same as "EXP_REQ_TTL_A" for the 3rd DR Interface of Generator. |
| 19 | EXP_REQ_GND_C | Input | Gray | Same as "EXP_REQ_GND_A" for the 3rd DR Interface of Generator. |
| 20 | EXP_OK_POWER_C | Input | Yellow | Same as "EXP_OK_POWER_A" for the 3rd DR Interface of Generator. |
| 21 | EXP_OK+_C | Output | Green | Same as "EXP_OK+_A" for the 3rd DR Interface of Generator. |
| 22 | EXP_OK-_C | Output | Brown | Same as "EXP_OK-_A" for the 3rd DR Interface of Generator. |
| 23 | EXT_A+ | Input | - | <ul style="list-style-type: none"> Detector receives the 1st status signal that it is equipped on/in the table or in the wall stand. Contact Type – On: Closed, Off: Open |
| 24 | EXT_A- | Input | - | Return signal from EXT_A+ |
| 25 | EXT_B+ | Input | - | Same as "EXT_A+" for the 2nd status signal |
| 26 | EXT_B- | Input | - | Same as "EXT_A-" for the 2nd status signal |
| 27 | EXT_C+ | Input | - | Same as "EXT_A+" for the 3rd status signal |
| 28 | EXT_C- | Input | - | Same as "EXT_A-" for the 3rd status signal |
| 29 | EXT_D+ | Input | - | Same as "EXT_A+" for the 4th status signal |
| 30 | EXT_D- | Input | - | Same as "EXT_A-" for the 4th status signal |

Table 2.11 EXT_INF2 port pin description (16 ~ 30)

2.6.4 Input and Output Circuits

The following diagrams describe exposure request and exposure OK circuits.

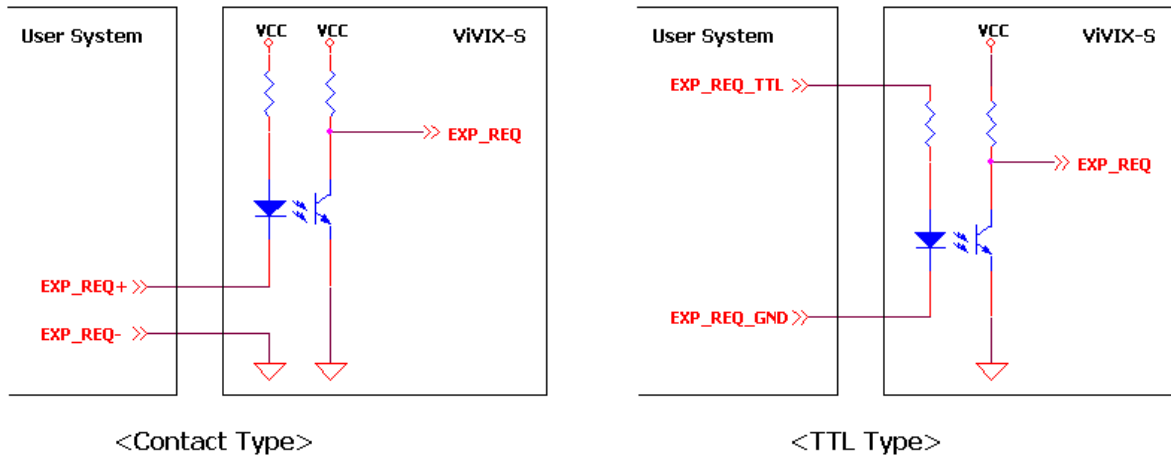

Figure 2.14 Exposure Request Input Circuit

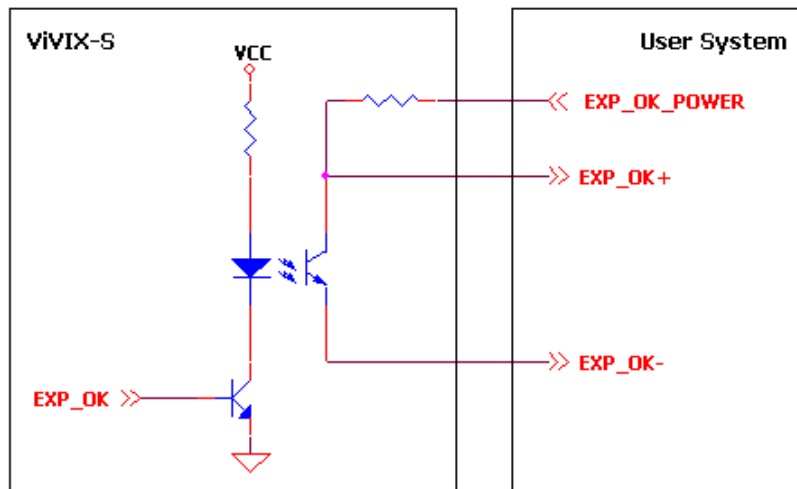

Figure 2.15 Exposure Respond Output Circuit

3. Packaging and Contents









| | |
|---|---|
| <p>Detector (FXRD-1417WAB)</p> | <p>System Control Unit (FXRS-03A)</p> |
|  |  |
| <p>Battery Charger</p> | <p>Battery Pack</p> |
|  |  |
| <p>Generator Interface Cable (15M)</p> | <p>LAN Cable (Gigabit LAN, 15M)</p> |
|  |  |
| <p>AC Power Cable</p> | <p>Tether Interface</p> |
|  |  |
| <p>Installation Software CD</p> | |
| <p>Viewer:</p> | <p>VXvue</p> |
| <p>Calibration SW:</p> | <p>VXSetup</p> |
| <p>Calibration Data</p> | |

Table 3.1 ViVIX-S Wireless Packaging

4. How to Install

4.1 Hardware Installation

This section describes how to connect the flat panel imaging system (detector) whose model name is FXRD-1417WA(B).



Installation of this equipment should be made by licensed and authorized personnel.

4.1.1 FXRD-1417WA (B)

- 1 Connect the one end of the generator interface cable to the EXT_INF port of SCU, and the other to the port of the X-ray generator.



- 2 Connect the one end of the LAN cable to Port 1 of SCU, and the other to the LAN Card Connector of workstation assigned for the Data Transfer.



- 3 Make an antenna of SCU stand upright.



- 4 To transmit image data using Tether Interface, connect the one end of the Tether Interface cable to Port 4 or Port 5 of SCU.



- 5 Connect the power cable to the AC port of the SCU to supply power.



This equipment must only be connected to a supply mains with protective earth.



- 6 Turn on the power switch in front of the SCU.



- 7 Attach a fully charged battery pack to the detector. To attach the battery pack, slide the battery pack into the battery compartment of the detector. Make sure that the claws on the battery pack are aligned with the groove on the battery compartment. Slide the battery lock lever until it clicks into place.



- 8 Press and hold the power button of the detector for 3 seconds to turn on the detector.



- 9 When you have finished using the detector, press and hold the power button for 3 seconds to turn off the detector. Remove the battery pack if the detector will not be used for some time. To remove the battery pack, slide the battery lock lever to release it, put your fingers on the battery compartment groove that lifts up, and then pull out the battery pack.



When the detector is not be used for some time, remove the battery pack. Otherwise, over discharge may occur, resulting in shortened battery life.

4.2 Software Installation

4.2.1 Intel Gigabit Controller Driver Installation and Setting



Before installing Intel Gigabit Controller Driver, make sure your Ethernet Card is properly installed on the workstation.

The recommended Ethernet Card is Intel® Gigabit CT or later. And also, Ethernet Card supporting 1 Gbps or above is available.

Gigabit LAN card must support the following requirements.

[Jumbo Frames: 9014 Byte], [Receive Descriptors: 2048]



This is not a component of ViViX-S but recommend component. So, you have to use installation package designed for your Gigabit Controller.

1~8 steps may differ according to Gigabit Controller to use.

Following procedures are provided as an example to refer to.

- 1 Click **PROXP.exe** to start InstallShield Wizard, and then click the **Run** button.





- 2 Click the **Next** button.



- 3 Accept the license agreement and click the **Next** button.

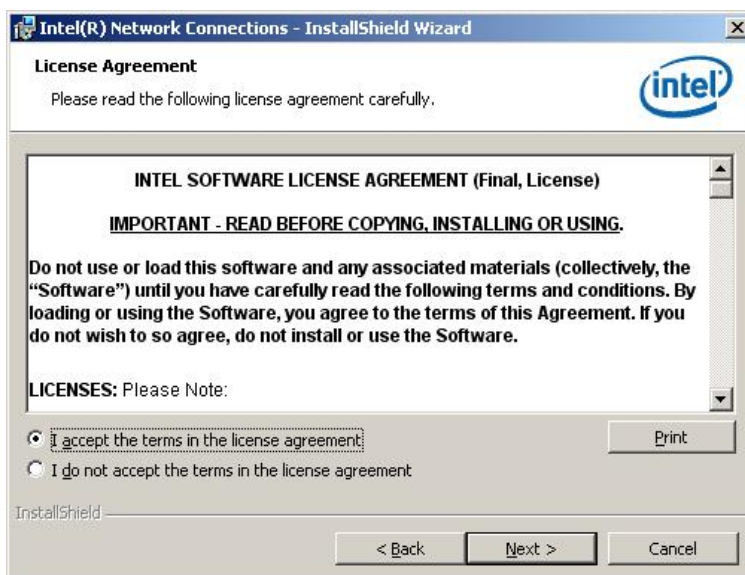



- 4 Select the components to install and click the **Next** button.

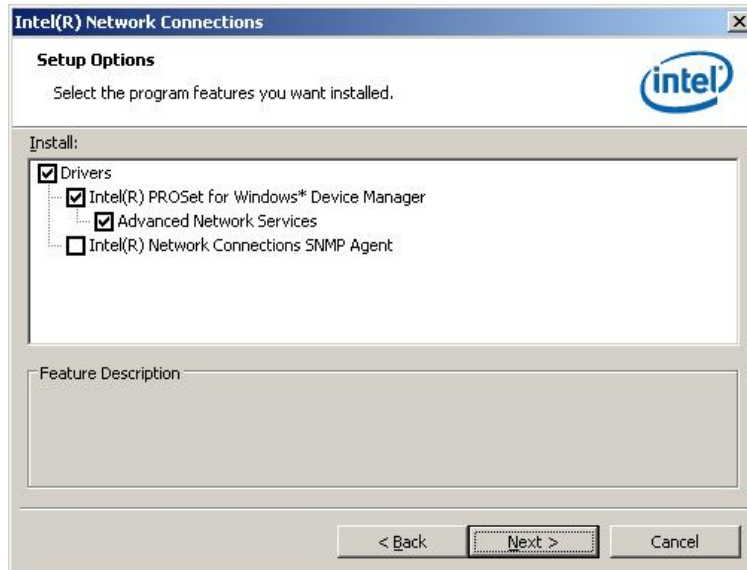

- 5 Click the **Install** button.

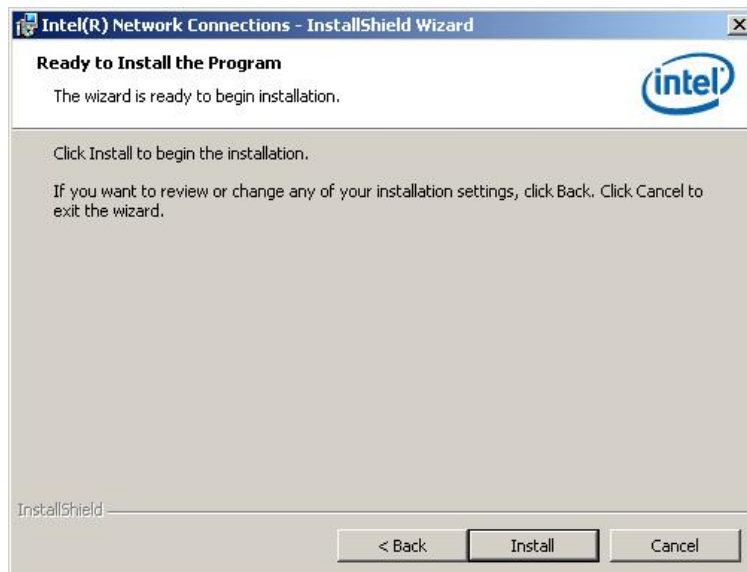

- When the following message appears, click the **Continue Anyway** button.



- Installation status bar appears in Installing **Intel® Network Connections** dialog box.

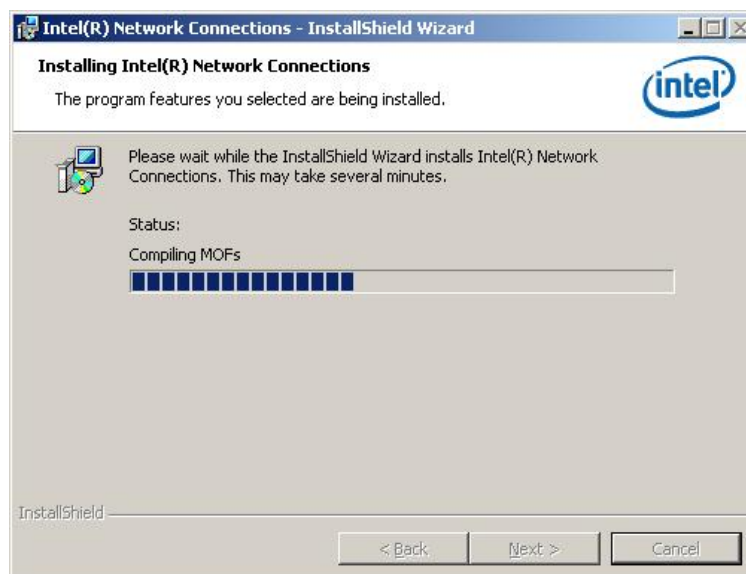

- 8 Click the **Finish** button.



4.2.2 Gigabit Controller Setting on Windows XP

- 1 Click **Start > Setting > Control Panel > Network Connections** to open the **Network Connections** dialog box, and then rename **Local Area Connection** with **GigE**.

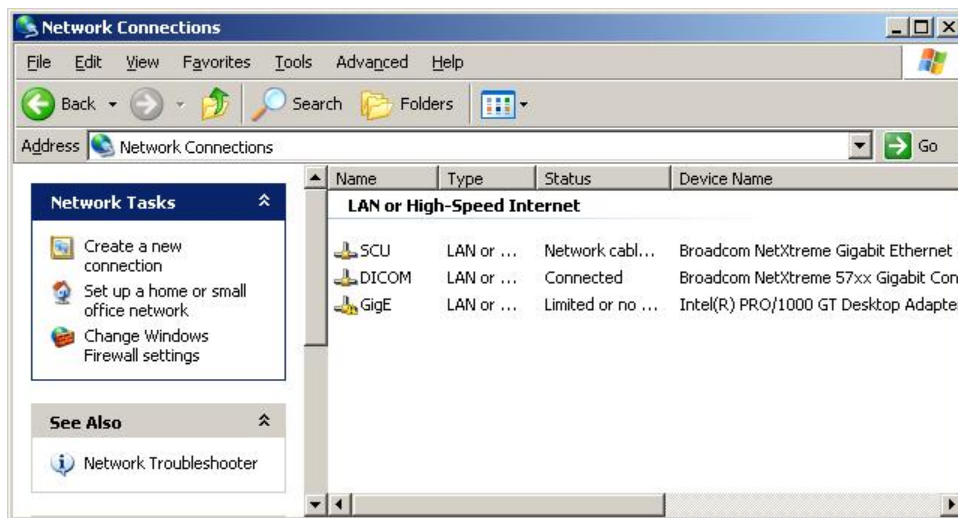

It is not necessary to change name with GigE. It just distinguishes between that connection and other connections.

- 2 Right-click the **GigE** and then click the **Properties**.

- Uncheck all checkboxes except **Vieworks Image Filter Driver** or **GigaLinx Image Filter Driver** and **Internet Protocol [TCP/IP]**.

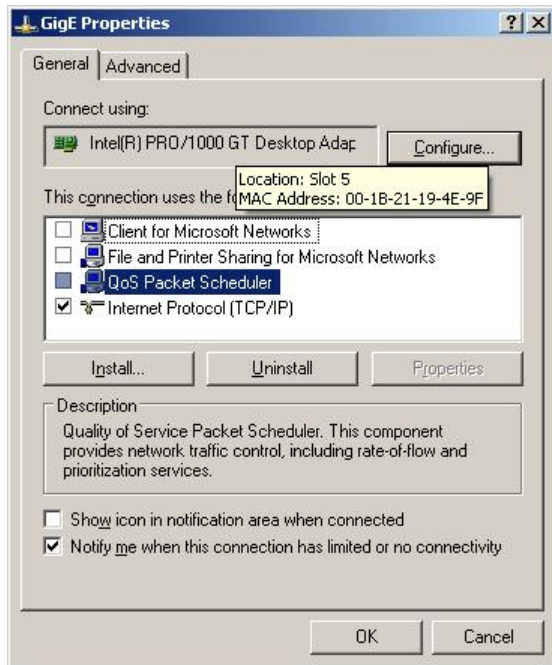

- Click the **Internet Protocol [TCP/IP]** and set the IP as shown below, and then click the **Advanced** button.

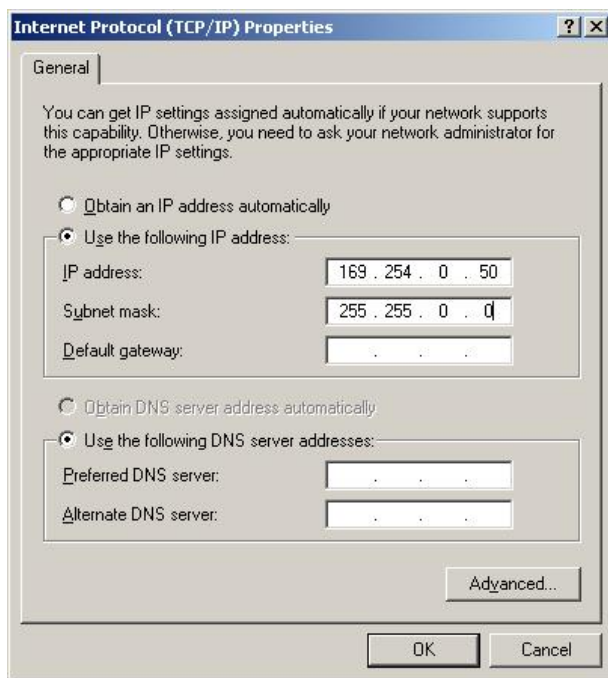

- 5 Click the **OK** button to close the dialog box.

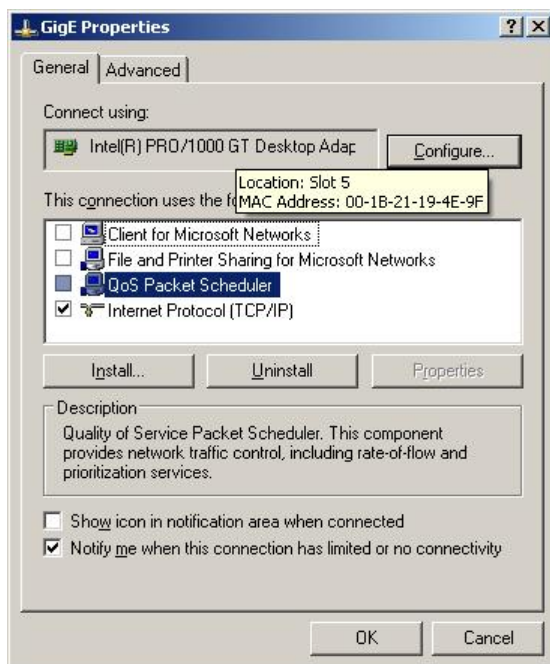

- 6 Click **Start > Setting > Control Panel > Network Connections** to open the **Network Connections** dialog box, and right-click **GigE**, and then click **Properties** to open the **GigE Properties** dialog box. Click the **Configure** button to open the following dialog box, and then go to the **Advanced** tab.

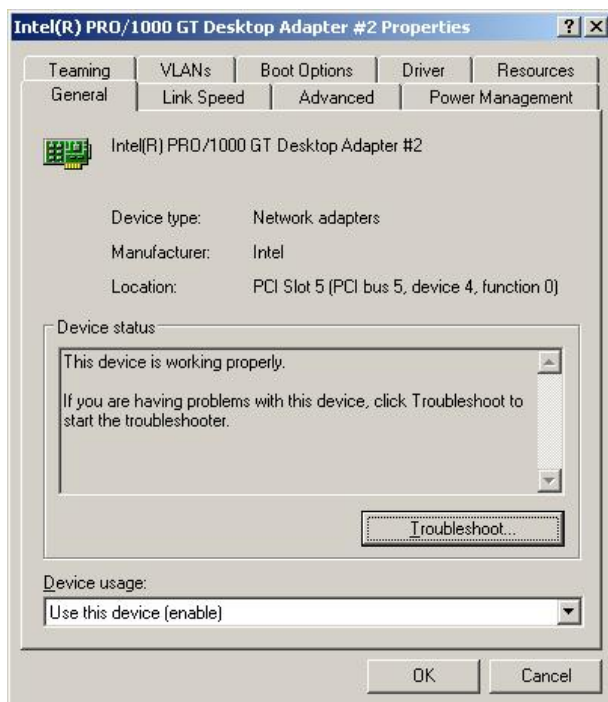



7 Set the **Jumbo Frames** to the maximum value.

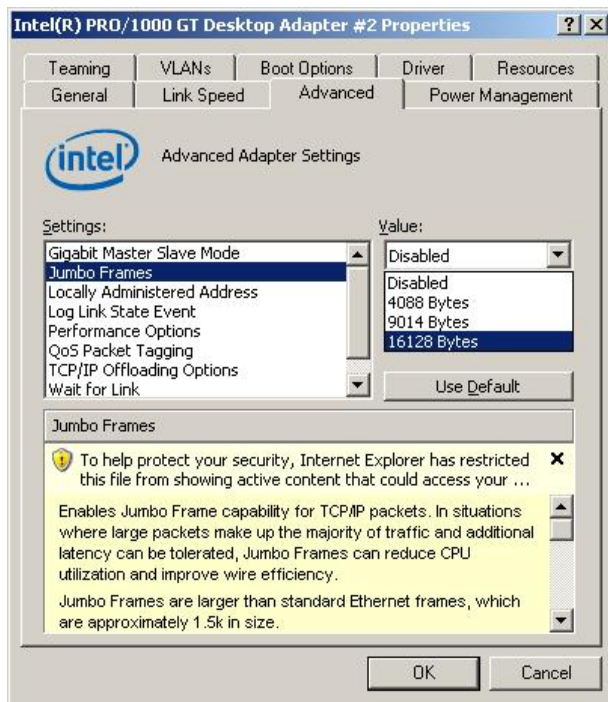

8 Choose **Performance Options** in the list of Settings and click the **Properties** button on the right.



- 9 Choose **Flow Control** in the list of Settings and **Generate & Respond** in the list of Value as shown below.

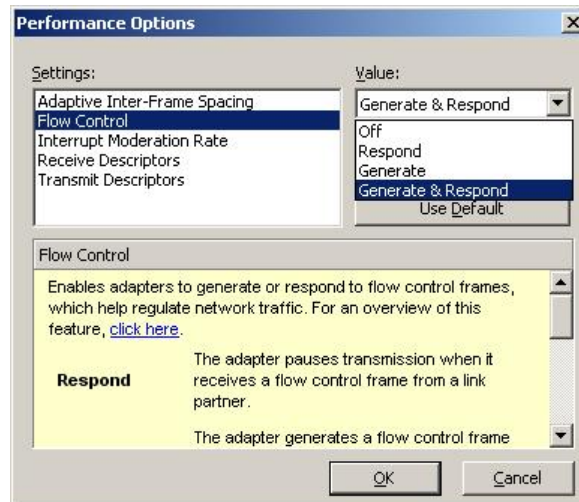

- 10 Choose **Interrupt Moderation Rate** in the list of Settings and **Extreme** in the list of Value as shown below.

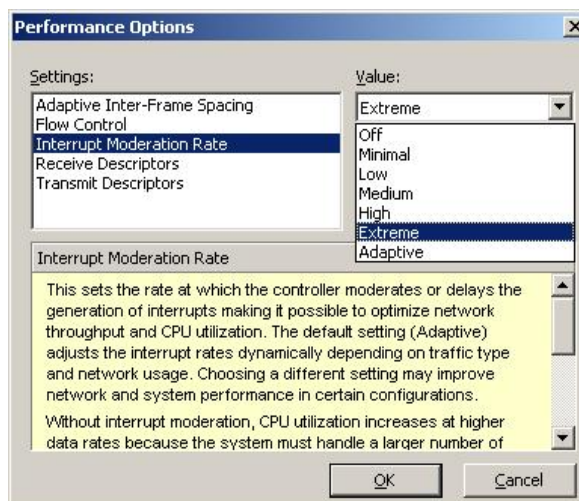

- 11 Choose **Receive Descriptors** and set to the maximum value.

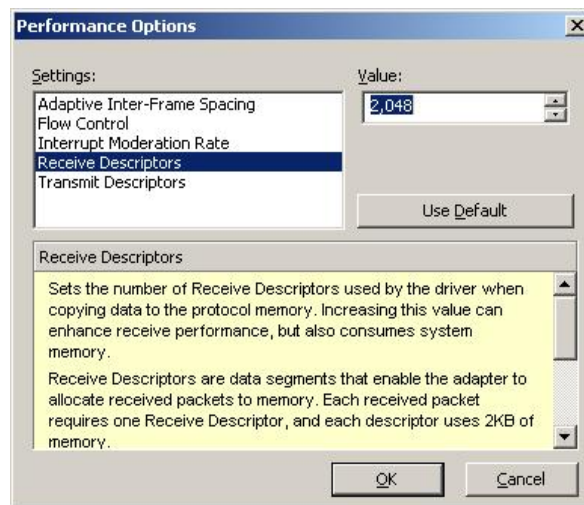

- 12 Click the **OK** button.

4.2.3 Gigabit Controller Setting on Windows 7

- 1 Click **Start > Control Panel > Network and Internet > Network and Sharing Center > Change Adapter Setting** and then rename **Local Area Connection** with **GigE**.

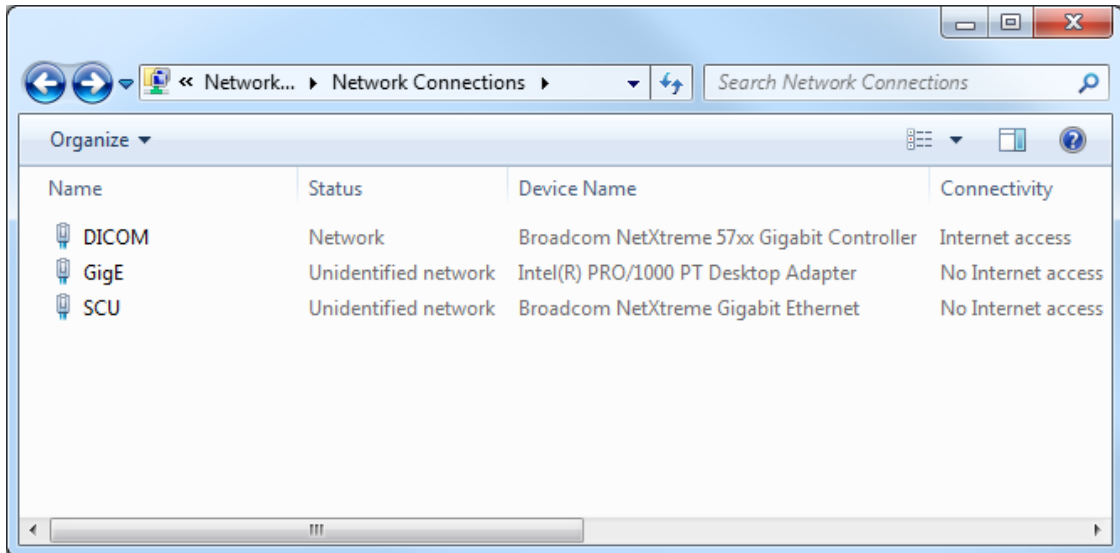

It is not necessary to change name with GigE. It just distinguishes between that connection and other connections.

- 2 Right-click the **GigE** and then click the **Properties**.

- Uncheck all checkboxes except **Vieworks Image Filter Driver** or **GigaLinx Image Filter Driver** and **Internet Protocol [TCP/IP]**.

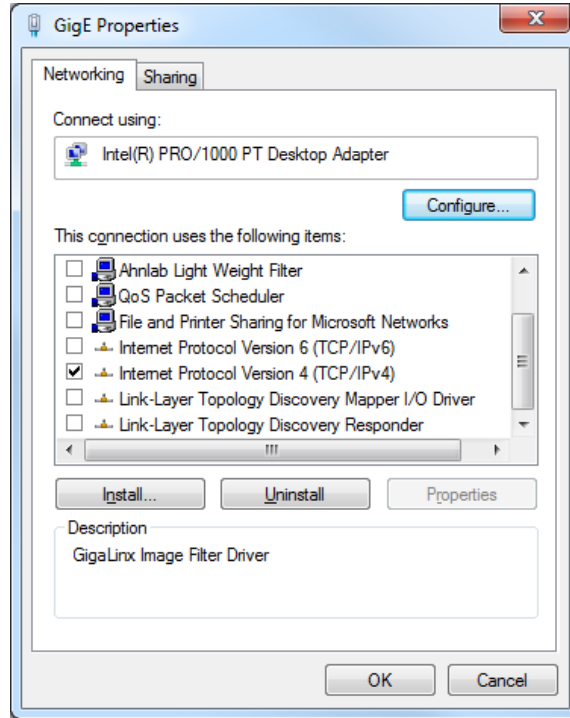

- Click the **Internet Protocol [TCP/IP]** and set the IP as shown below, and then click the **Advanced** button.

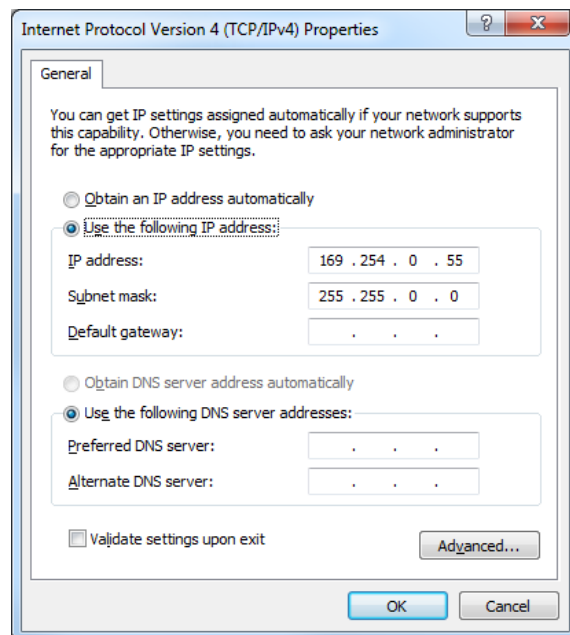

- 5 Click **Start > Control Panel > Network and Internet > Network and Sharing Center > Change Adapter Setting**, right-click **GigE**, and then click **Properties** to open the **GigE Properties** dialog box. Click the **Configure** button to open the following dialog box, and then go to the **Advanced** tab.

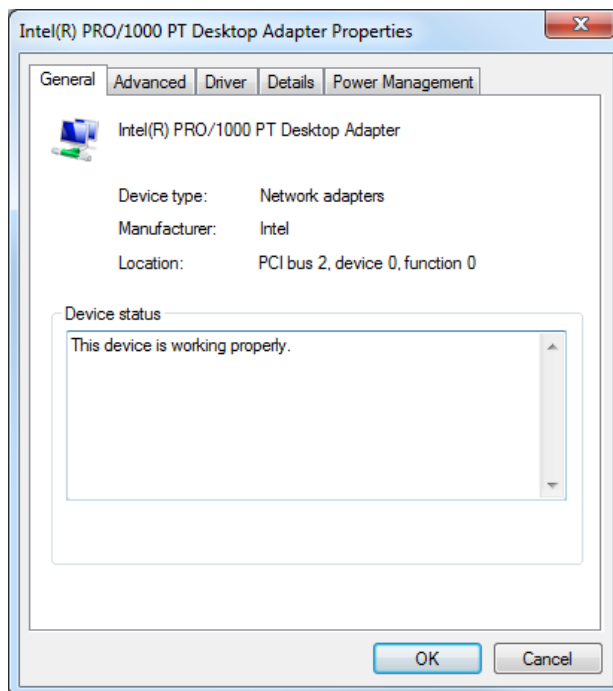

- 6 Set the **Jumbo Packet** to the maximum value.

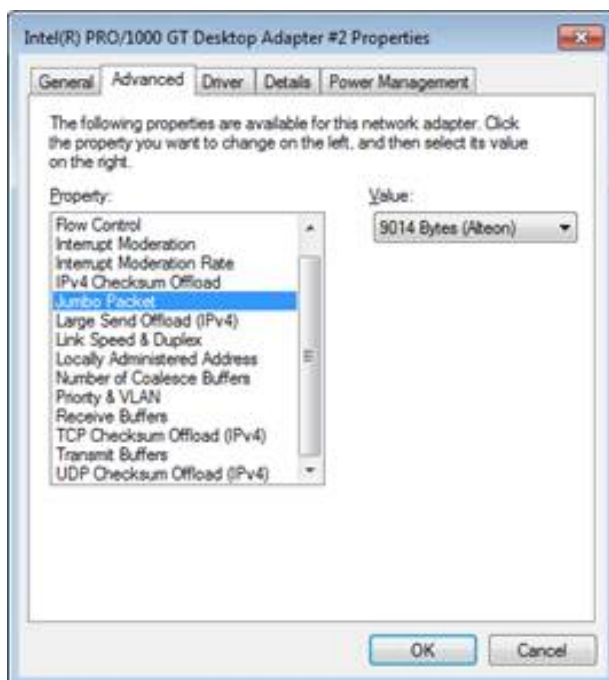

- 7 Choose **Flow Control** in the list of **Property** and select **Rx & Tx Enabled** in the list of **Value** as shown below.

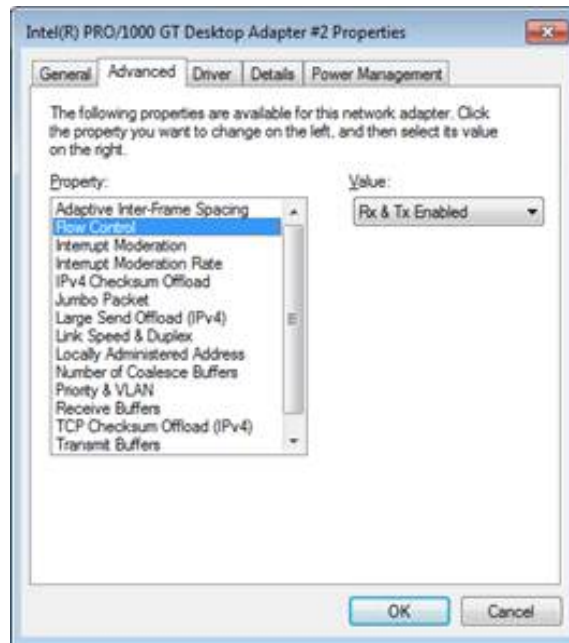

- 8 Choose **Interrupt Moderation Rate** in the list of **Property** and **Extreme** in the list of **Value** as shown below.

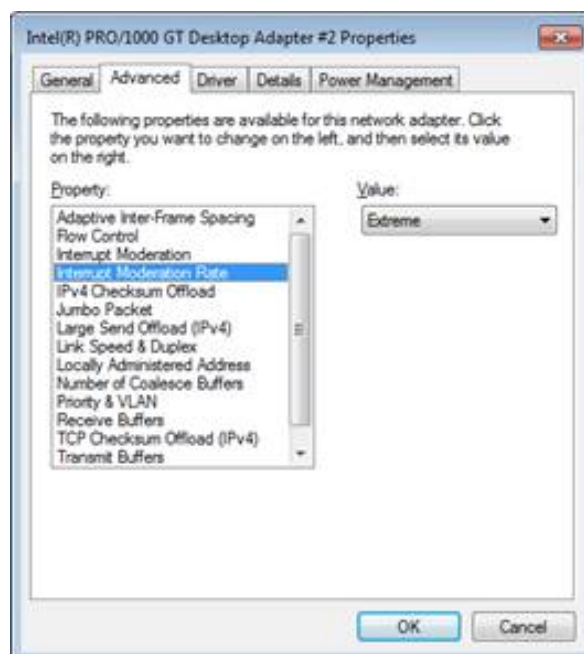



- 9 Choose **Receive Buffers** and set to the maximum value.

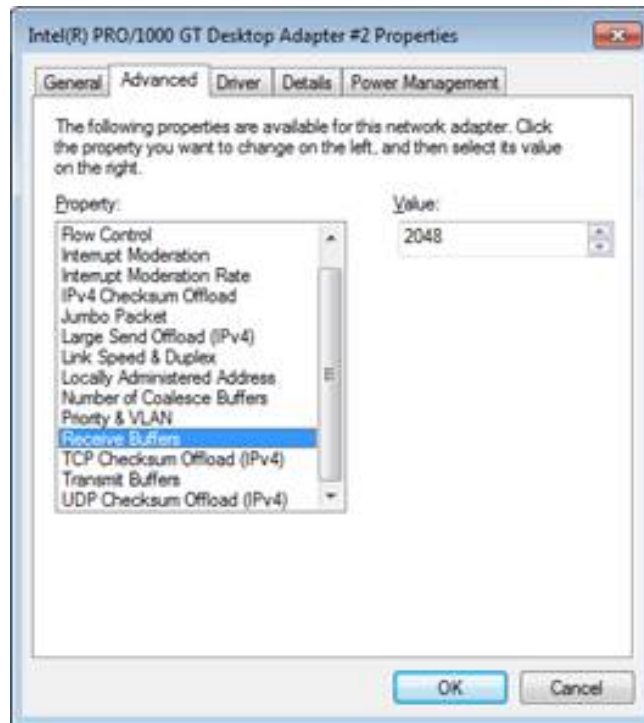

- 10 Click the **OK** button.

4.2.4 VXvue Installation



User must follow instructions below to protect against cyber security threats such as virus and worms.

- Prior to installing and using VXvue, scan the computer system with anti-virus software to make sure the system is virus free.
- Install, setup and enable adequate anti-virus software.
- The operating system should be updated frequently to protect VXvue against harmful activities.
- If you have a cyber security problem, contact the manufacturer on the phone or by e-mail referring to the contact information in this manual.

- 1 Insert the CD/DVD into the CD Drive.
- 2 Run **Setup.exe**.
- 3 Click the **Yes** button when the following dialog appears. The dialog may not appear depending on your Windows settings.

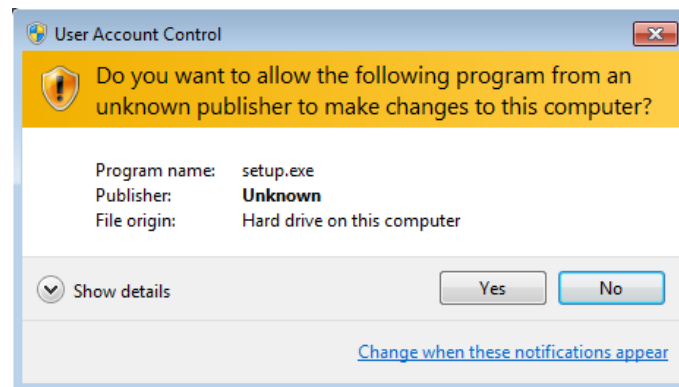

- 4 The prerequisites for VXvue installation are displayed in the **VXvue – InstallShield Wizard** dialog, then click the **Install** button. The installation may take several minutes depending on your system environment.

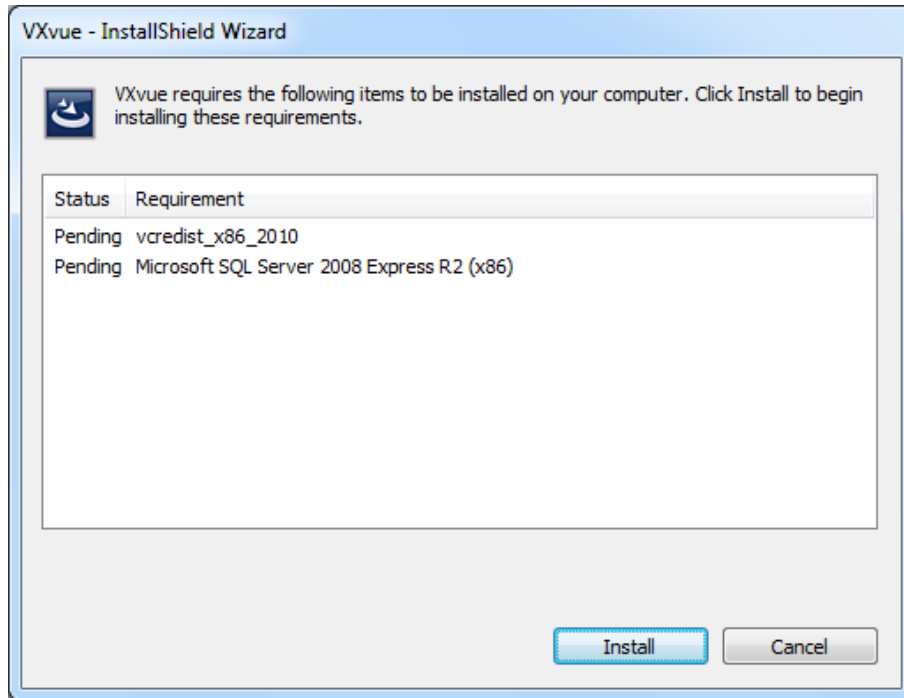

The items listed under the **Requirement** may vary from the above figure depending on your system environment.

- 5 When the prerequisites for VXvue installation have been installed, click the **Next** button.

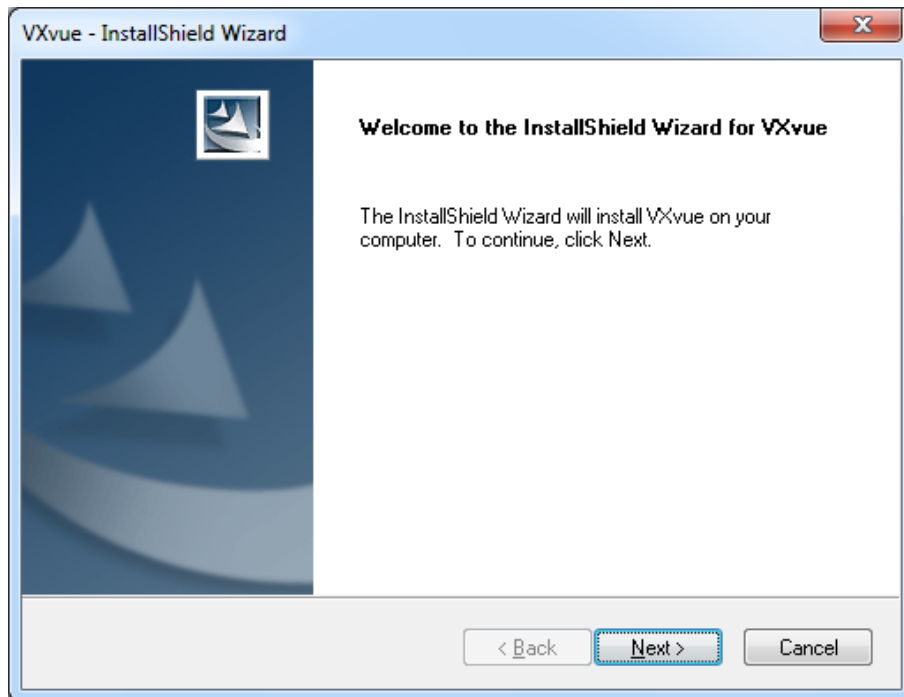

- 6 A driver for recognizing license hardware key will be installed on your system during setup process. If the window installing the driver appears, do not close the window and wait for the installation to complete.

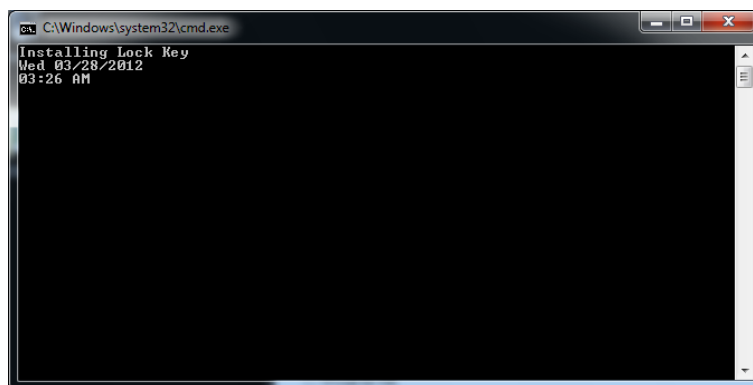

- 7 Choose the application type and click the **Next** button.

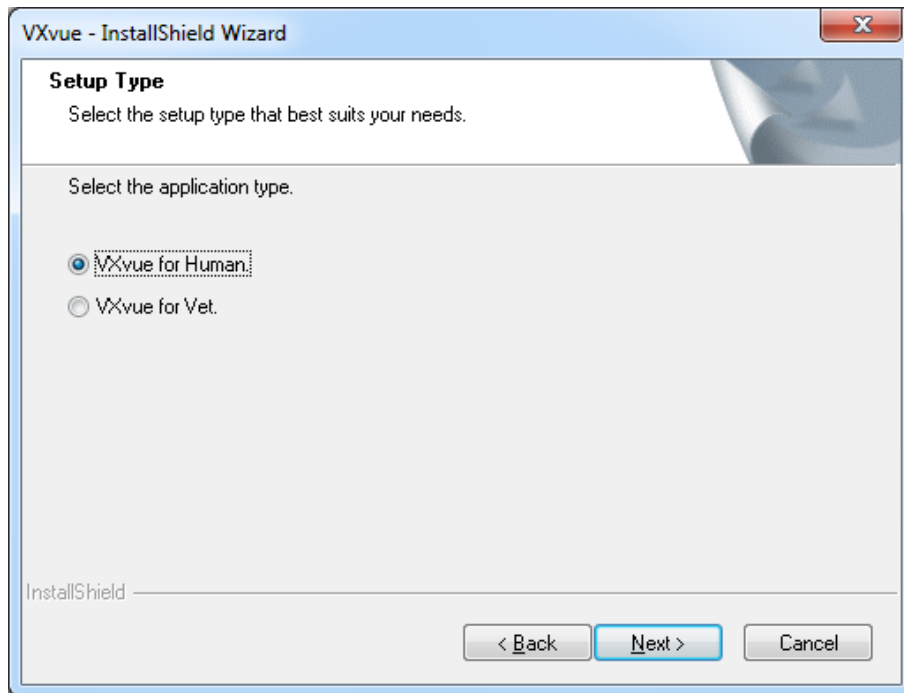

- 8 Choose the folder location where you want to save VXvue data. The default destination is D:\Database. To change the folder location, click the **Browse** button to locate the folder.

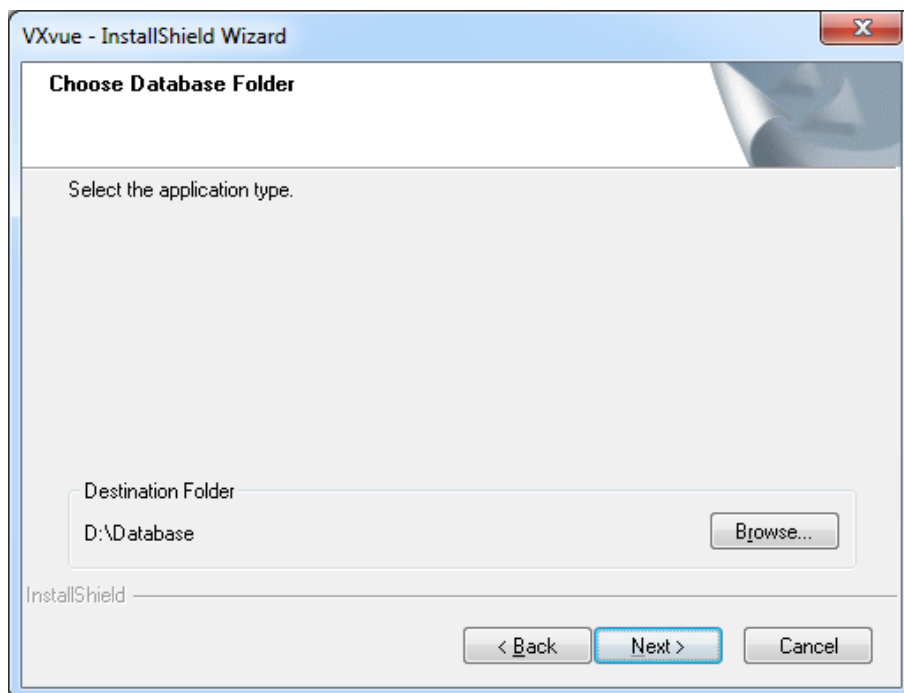

- 9 Click the **Install** button to begin VXvue installation.

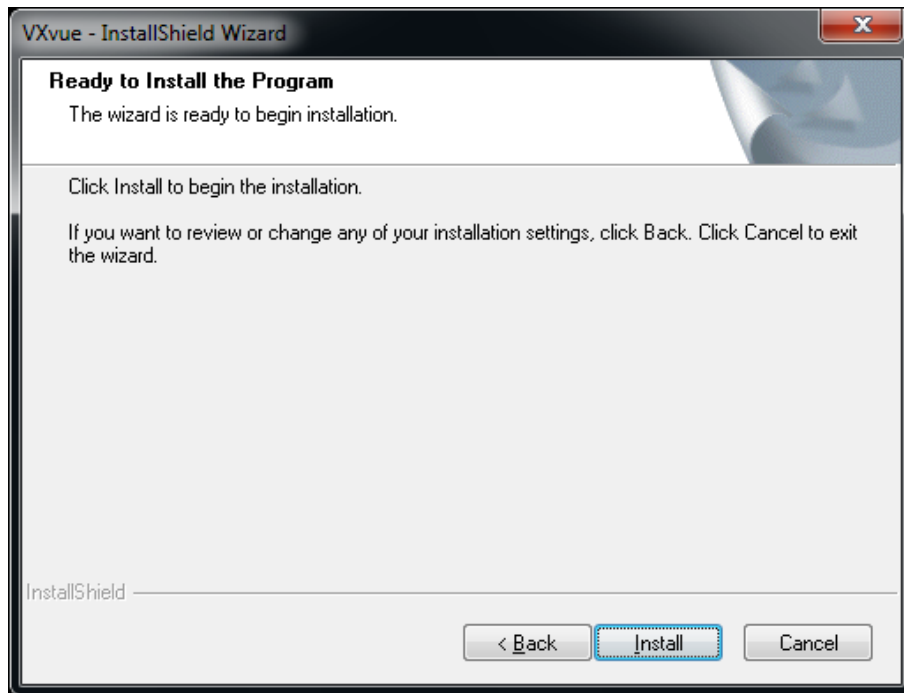

- 10 The installation process will continue and a progress bar will be displayed in the **Setup Status** window.

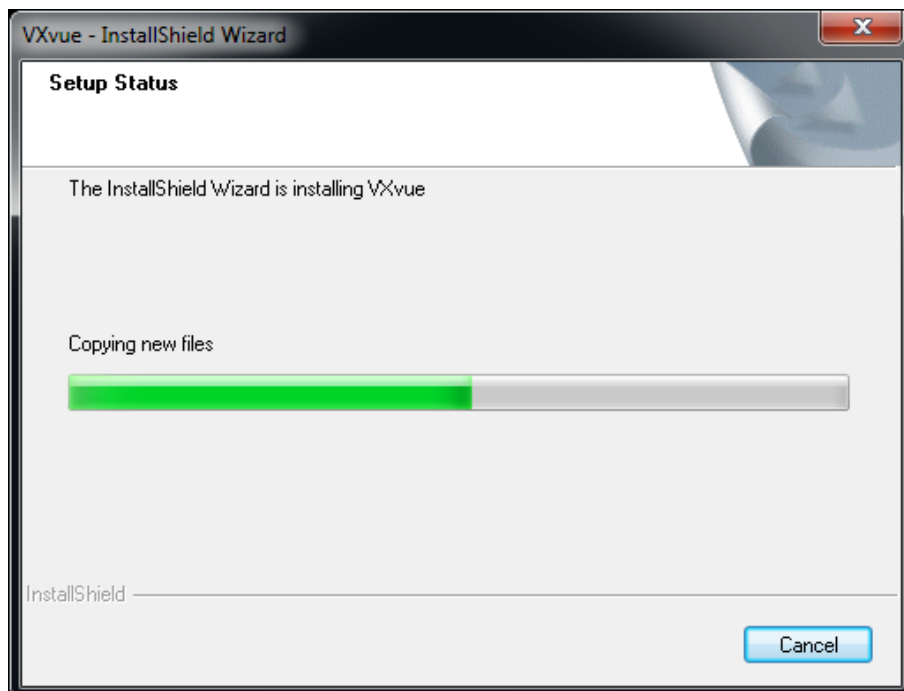

- 11 When the installation is complete, click the **Finish** button.

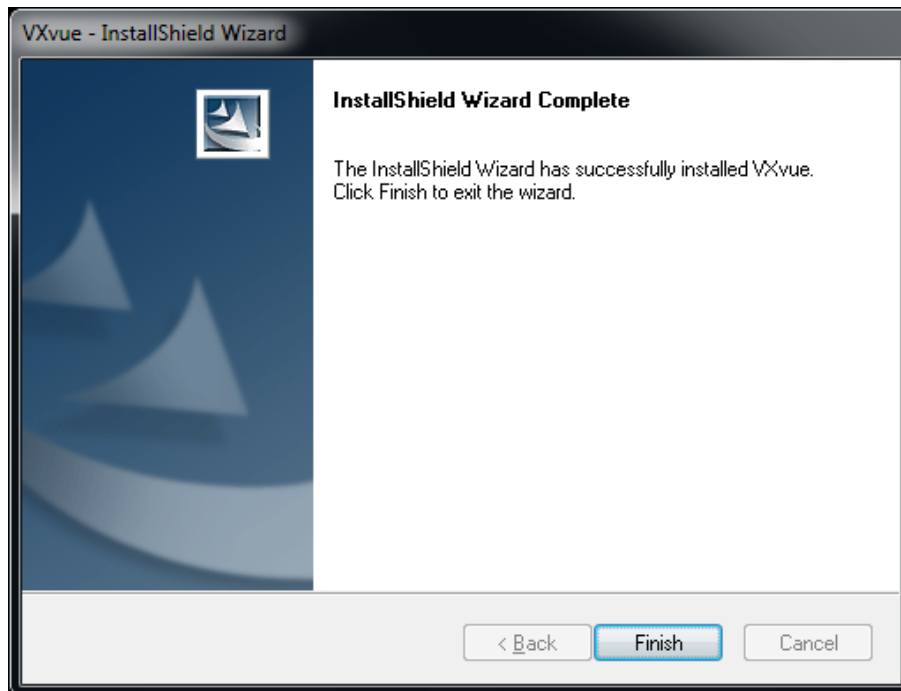

- 12 When Filter Driver installation dialog appears after installing VXvue, choose **BroadLink Universal Filter Driver** and click the **Next** button.

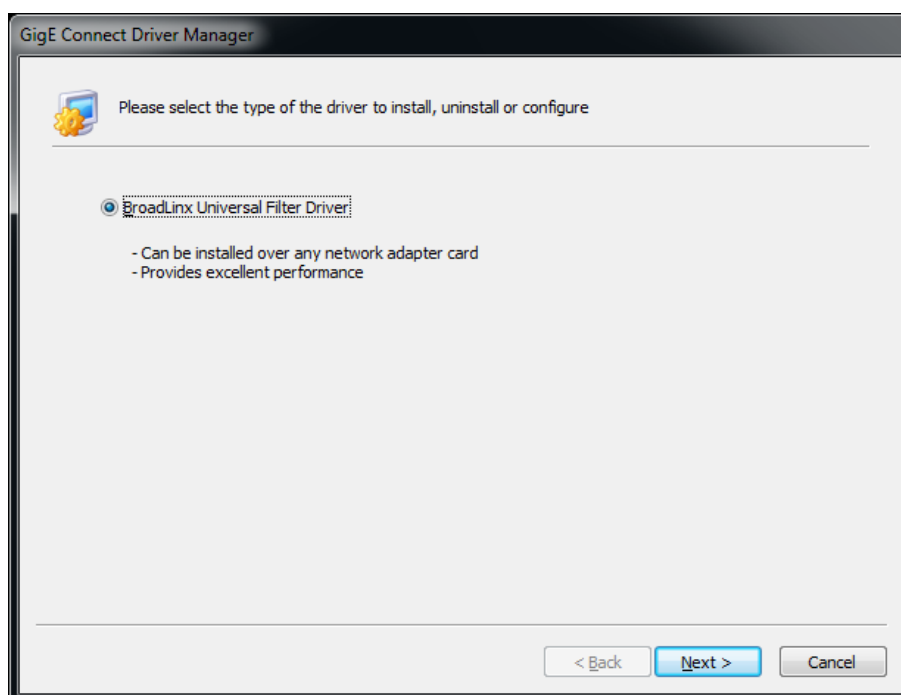

- 13 Select the network interface card connected to SCU and click the **Next** button.

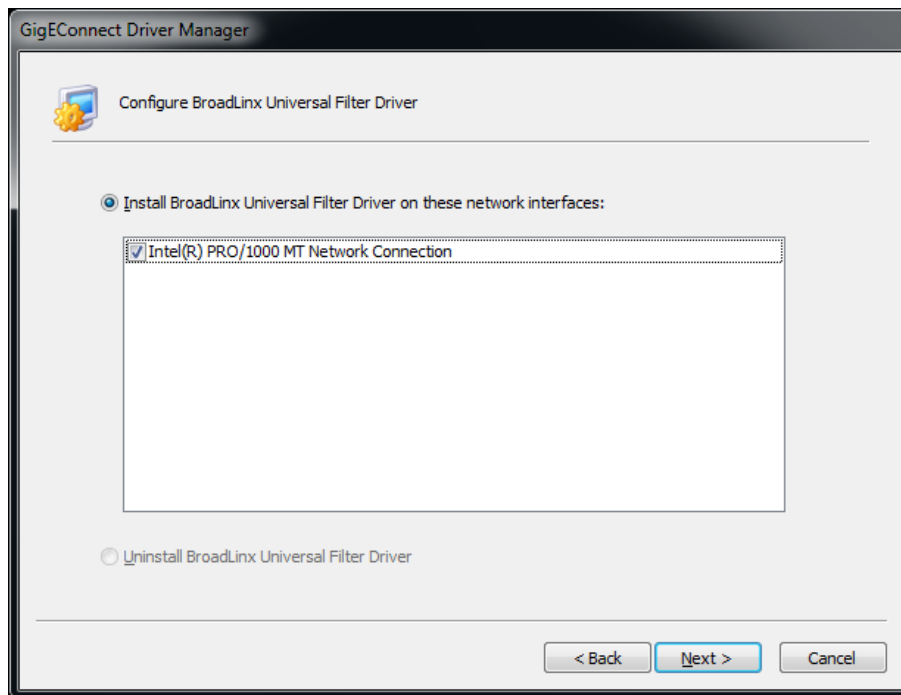

The above figure may vary depending on your system environment.

- 14 The progress of Filter Driver installation will be displayed.

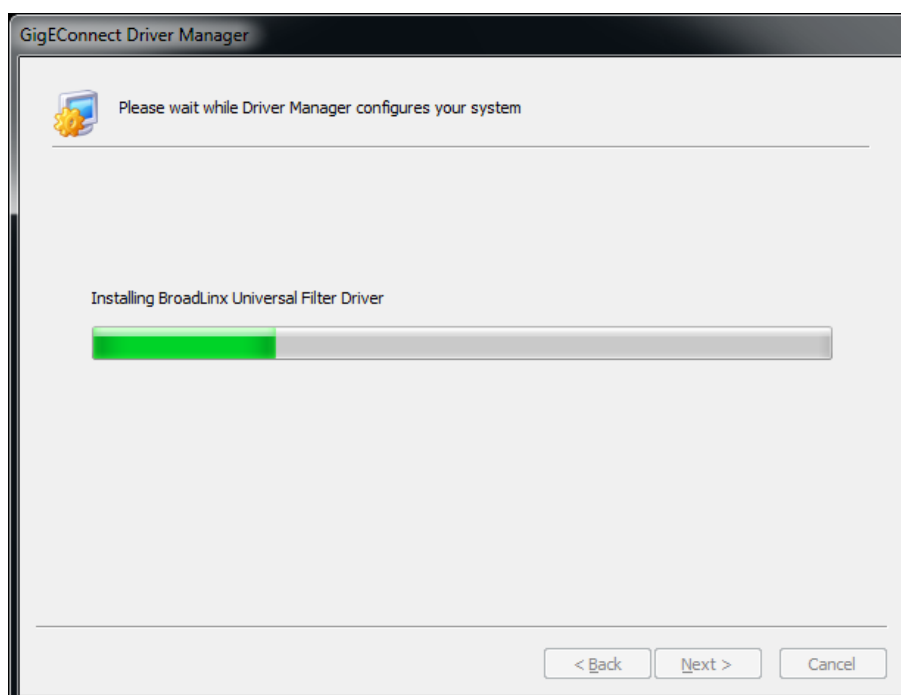

15 Click **Install this driver software anyway** when the following dialog appears.

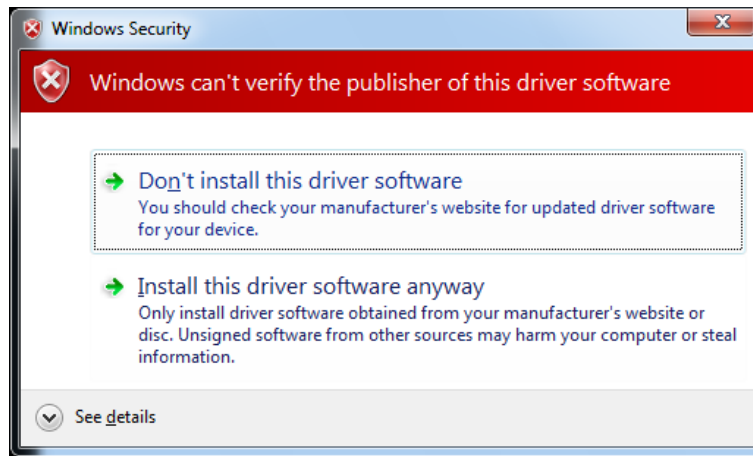

16 After completing installation, click the **Yes** button to restart the computer.

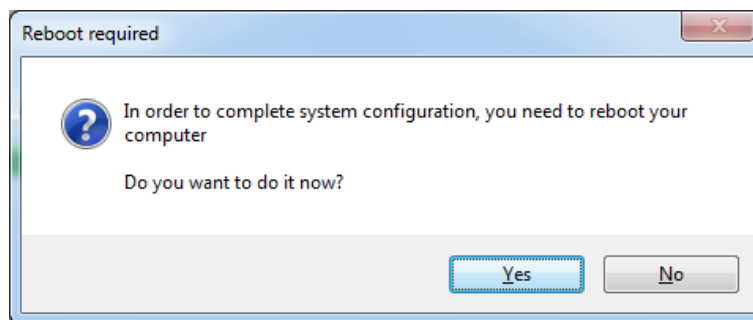

17 Now the VXvue software and data are successfully installed in each directory as shown below.

- Software: C:\program files\VXvue
- Image and other data: D:\Database or user defined folder
- Executable File
 - VXvue.exe: Image Viewer
 - VXSetup.exe: Calibration Software

4.2.5 Allowing VXvue to communicate through Windows Firewall on Windows XP

- 1 Click **Start > Setting > Control Panel > Windows Firewall** and then click the **Exceptions** tab.
- 2 Click the **Add Program...** button.

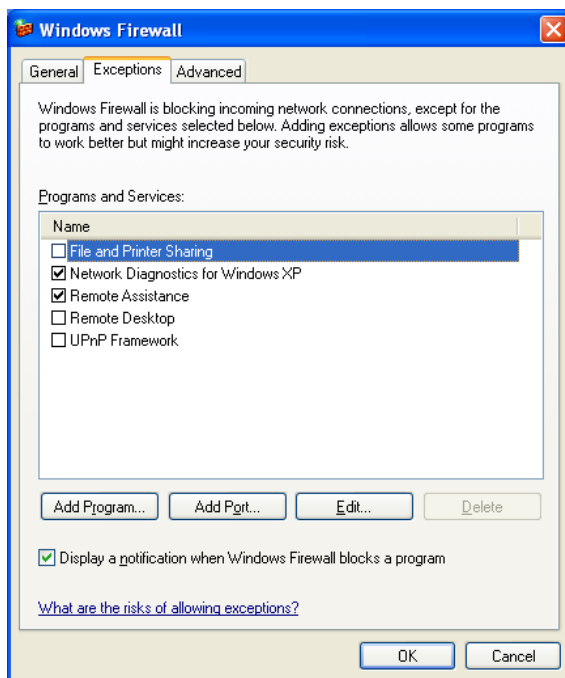

- 3 Click the **Browse** button and locate **C:\Program files\VXvue\VXvue**.

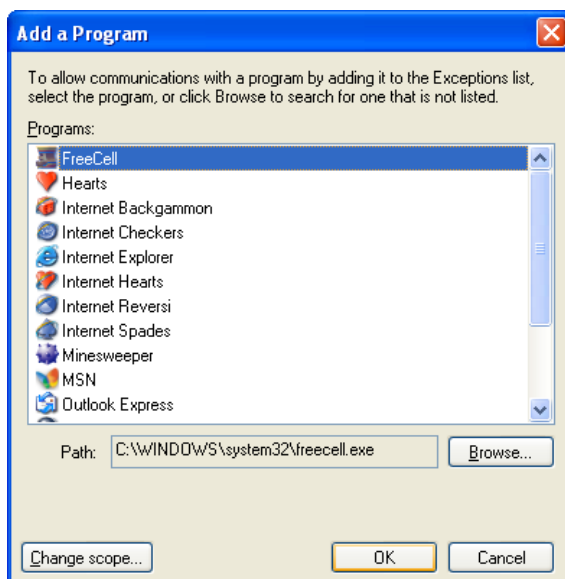

- 4 Click the **Open** button.

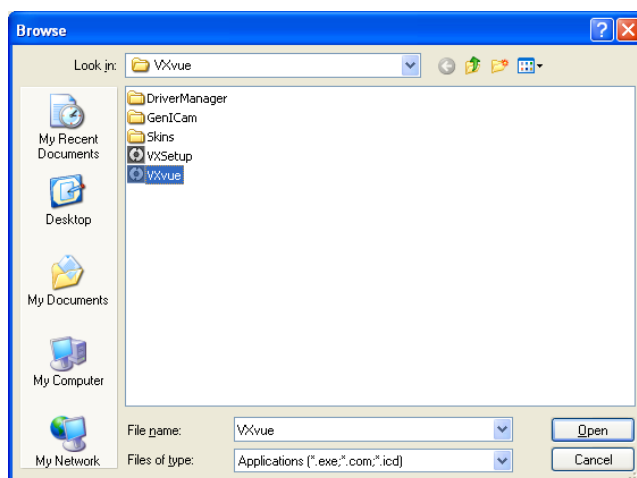

- 5 Select the **VXvue** and then click the **OK** button.

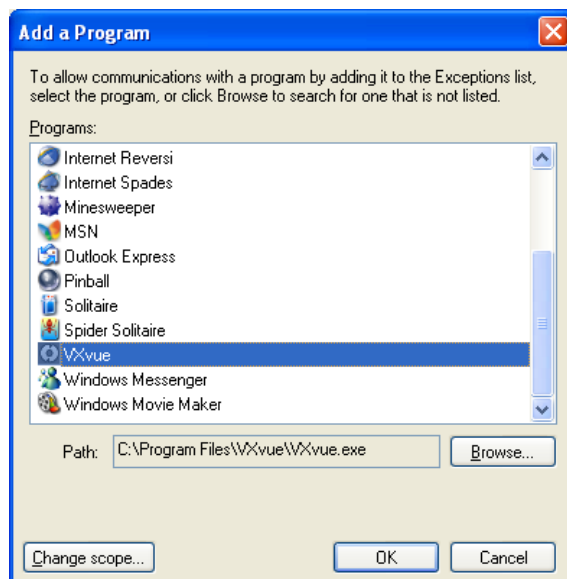

- 6 Check the **VXvue** to select and then click the **OK** button.

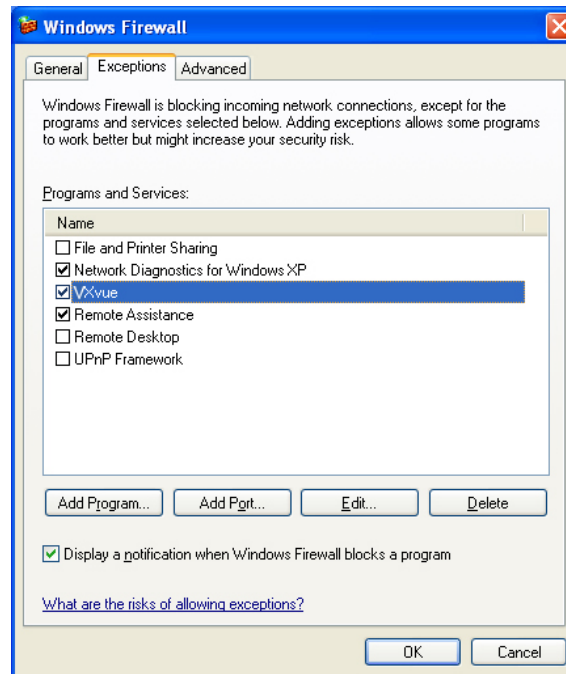



4.2.6 Allowing VXvue to communicate through Windows Firewall on Windows 7

- 1 Click **Start > Control Panel > Windows Firewall**.
- 2 Click **Allow a program or feature through Windows Firewall**.

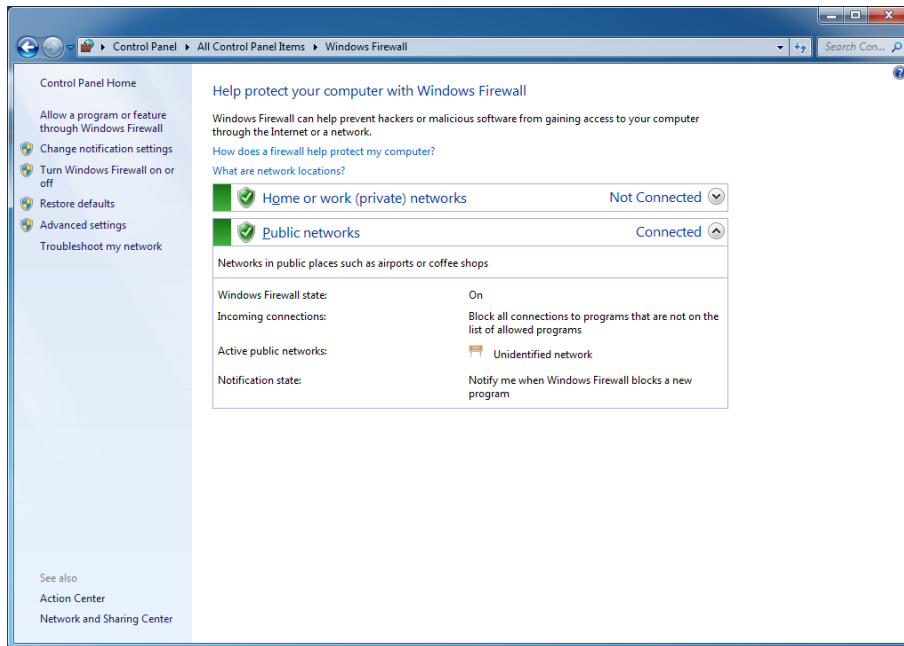

- 3 Click the **Change settings** button if it is enabled and then click the **Allow another program** button.

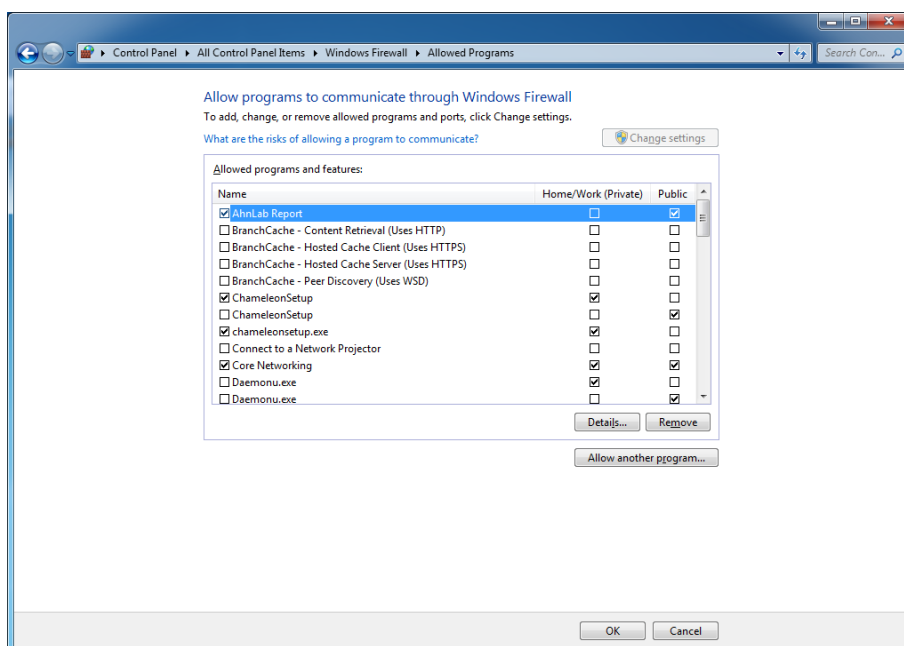



4 Click the **Browse** button and locate C:\Program files\VXvue\VXvue.exe.

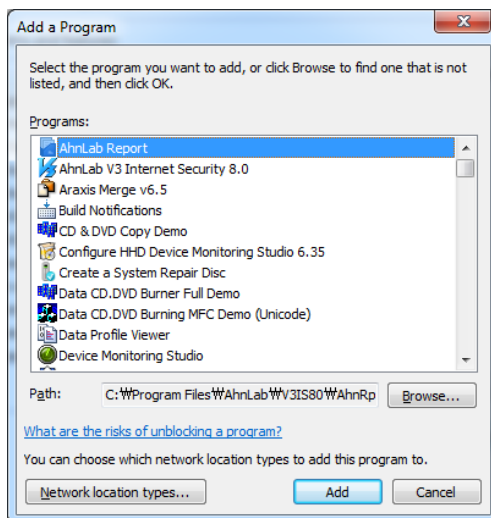

5 Click the **Open** button.

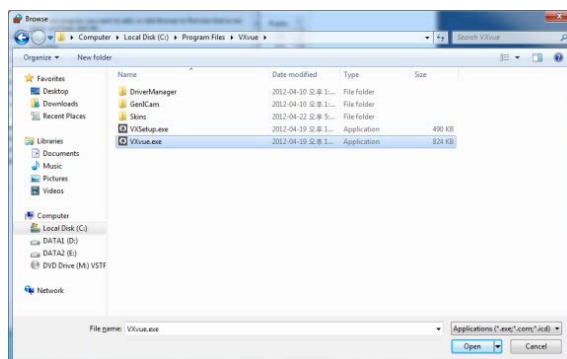

6 Select the **VXvue** and then click the **Add** button.

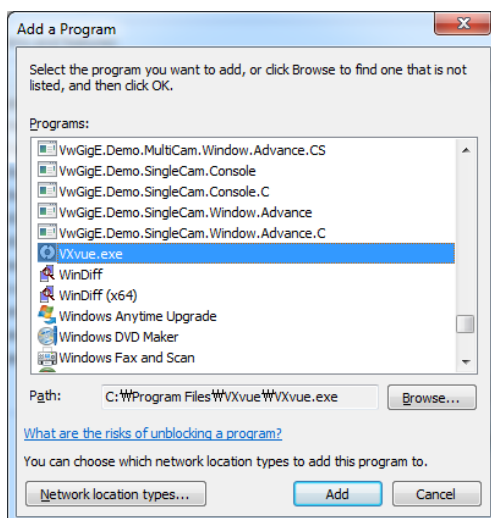

Add **VXSetup** (located in C:\Program files\VXvue\VXSetup.exe) in the same manner as described above.

5. Prerequisite for Operation

5.1 Preparing the SCU

- 1 Turn on the System Control Unit (SCU).



- 2 Make sure the LED lamp (power and status) is lit green. It means SCU is ready to work normally.
- 3 Press and hold the power button of the detector for 3 seconds.
- 4 The detector Power LED is lit green and Active LED is lit orange simultaneously when the detector is ready to operate.
- 5 Blinking green status LED indicates the startup process is in progress. Then status LED turns blue indicating Wi-Fi network is connected.

5.2 Generator Configuration

- 1 Run VXSetup.

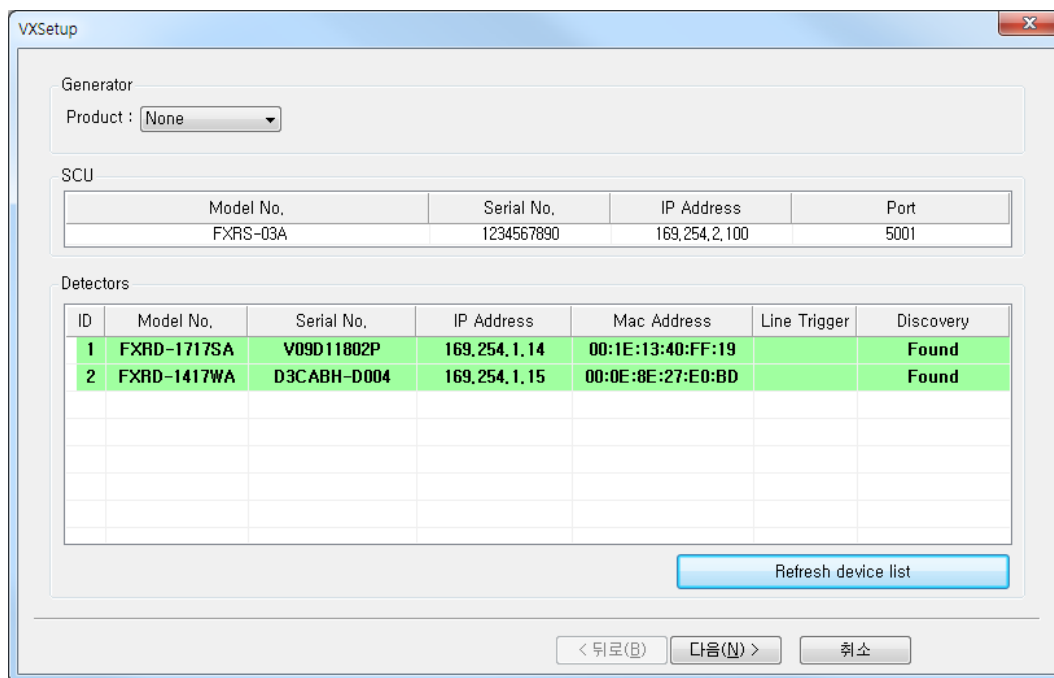

- 2 Select a generator model from the dropdown list located beside Product in the Generator item. Input proper values into Param1 and Param2 according to the generator model.

| Generator | Communication | Settings | Remarks |
|--------------|-------------------------|---|-------------|
| None | | | No console |
| LISTEM | Serial | Param 1: Port Param 2: 'true' - Use AEC 'false' - No AEC 115200 bps / data 8 / stop 1 / none / none | |
| GXR | UDP packet | UDP 5001 Port | |
| POSKOM | Will be supported soon. | | |
| DK (Accuray) | Serial | Port COM 1 19200 bps / data 8 / stop 1 / none / none | OCX Control |



| Generator | Communication | Settings | Remarks |
|-----------|---------------|--|---|
| CPI | Serial | Port COM 1 19200 bps / data 8 / stop 2 / none / none | |
| EMD | Serial | Port COM 3 19200 bps / data 8 / stop 1 / none / none | Set WorkStation 2, 3 |
| SEDECAL | Shared memory | Window title: 'window title' | For Human in DRApp.ini [SETTINGS] DRAppName = window title For Vet in AppName.ini [CONFIG] APPNAME= window title |

5.3 Detector Configuration

In this phase, defect pixels are corrected and gained pixels are calibrated using installed x-ray generator and x-ray tube. The detector needs to warm up at least 30 minutes before performing the calibration.

The calibration should be performed on the following cases.

- Detector installation
- X-ray generator replacement
- X-ray tube replacement
- Exposure section Value change
- Gain Type change

5.3.1 Detector Setting

- 1 Run VXSetup.

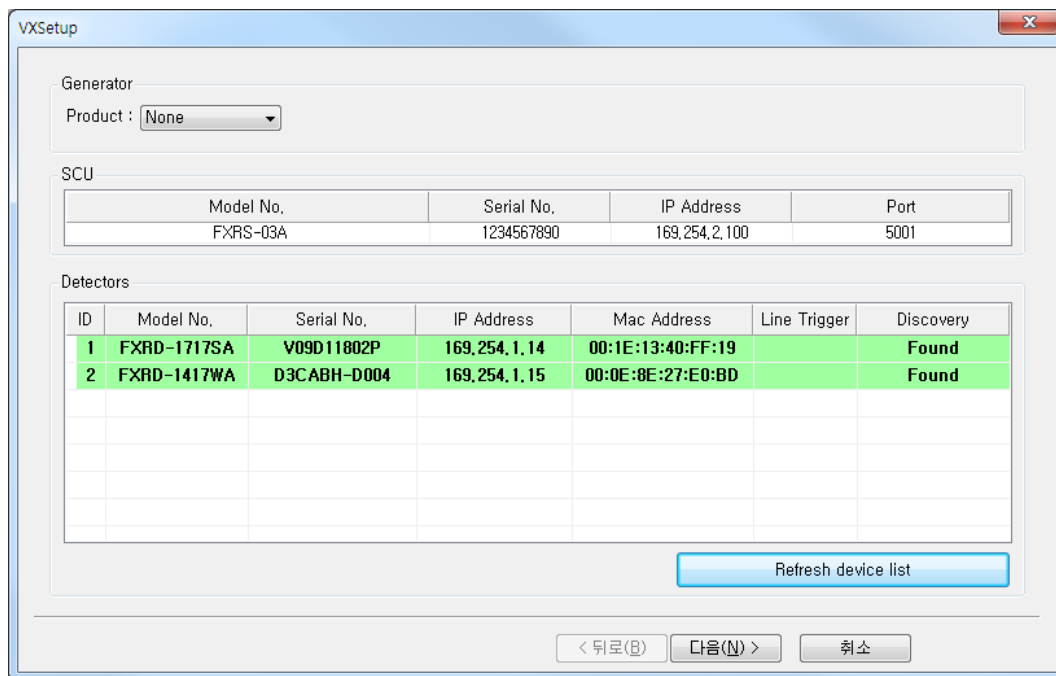

- 2 The connected detectors will be displayed under **Detectors**. If all the detectors are not displayed, click the **Refresh device list** button to refresh the list.



Color used in indicating status

- Green background: Connected normally and selected detectors
- White background, black texts: Connected but not selected detectors
- White background, gray texts: Recorded in the used history but not connected detectors

- 3 To register connected detector to the system, double click the detector or select the detector and then click the **Select** button activated on the bottom left.

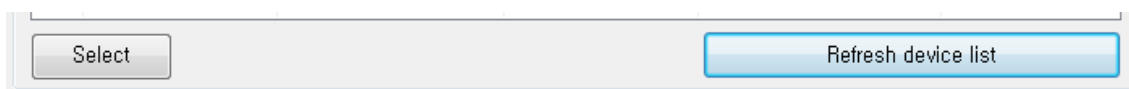

- 4 To deselect the registered detector, double click the detector or select the detector and then click the **Release** button activated on the bottom left.

| ID | Model No. | Serial No. | IP Address | Mac Address | Line Trigger | Discovery |
|----|-------------|-------------|--------------|-------------------|--------------|-----------|
| 1 | FXRD-1717SA | V09D11802P | 169.254.1.14 | 00:1E:13:40:FF:19 | | Found |
| | FXRD-1417WA | D3CABH-D004 | 169.254.1.15 | 00:0E:8E:27:E0:BD | | Found |
| | | | | | | |
| | | | | | | |
| | | | | | | |
| | | | | | | |

- 5 To sort the registered detectors, select the detector and then click the arrow button activated on the bottom left.

- 6 To change the settings of connected detector or SCU, select the item and then click the right mouse button.

- SCU

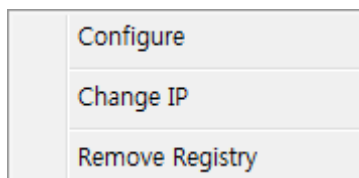

- Configure: Changes the settings related to SCU described in chapter [5.3.2.1](#).
- Change IP: Changes the SCU IP.
- Remove Registry: Removes the data stored in the registry.

- Detector



- Release: Deregisters the selected detector.
- Change IP: Changes the detector IP.

- 7 After completing configuration of detectors, click the **Next** button to synchronize the registered detectors with SCU and proceed to next phase.

5.3.2 Configuring Devices

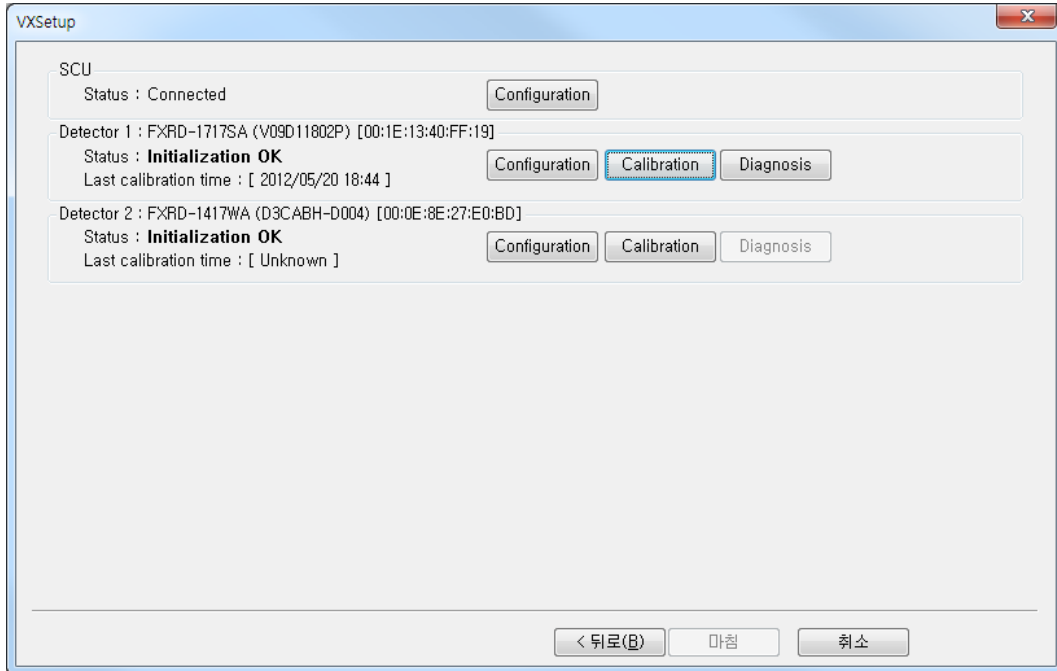

- 1 The list of connected SCU and registered detectors will be displayed.
- 2 Click the **Configuration** button on the right side of SCU to display the **SCU Configuration** window described in chapter [5.3.2.1](#).
- 3 Click the **Configuration** button on the right side of Detector to display the **Detector Configuration** window described in chapter [5.3.2.2](#).
- 4 Click the **Calibrate** button on the right side of Detector to display the **Calibration** window described in chapter [5.4](#).
- 5 After completing calibration of the detector, the **Diagnose** button will be activated. Click the button to move to [Diagnosis Mode](#) described in chapter [5.5](#).

5.3.2.1 Configuring SCU

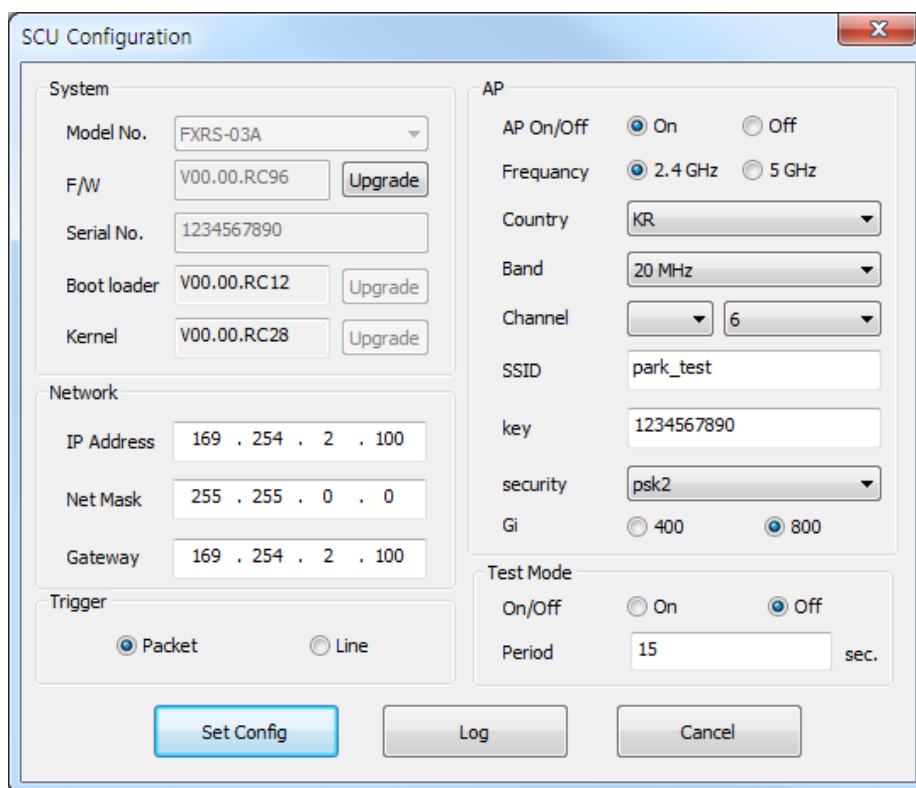

The **SCU Configuration** window allows you to configure the following items.

- System
 - Model No.: Model number of SCU
 - F/W: Version of firmware
 - Serial No.: Serial number of SCU
 - Boot loader: Version of Boot loader
 - Kernel: Version of Kernel

- Network
 - IP Address: IP address of SCU
 - Net Mask: Netmask of SCU
 - Gateway: Gateway address of SCU

- Trigger
 - Packet: Use SW Trigger.
 - Line: Use HW Trigger.



- AP
 - AP On/Off: Configures whether to run SCU as AP mode.
 - Frequency: Frequency channel of wireless network
 - Country: Country code of wireless network
 - Band: Wireless network bandwidth
 - Channel: Wireless network channel
 - SSID: Wireless network ID
 - Key: Wireless network key value
 - Security: Authentication protocol for wireless network
 - Gi: Guard Interval of wireless network

- Test Mode
 - On/Off: Configures whether SCU transmits Trigger Packet within specified period.
 - Period: Configures the period of transmitting Trigger Packet in a second unit.

5.3.2.2 Configuring Detector

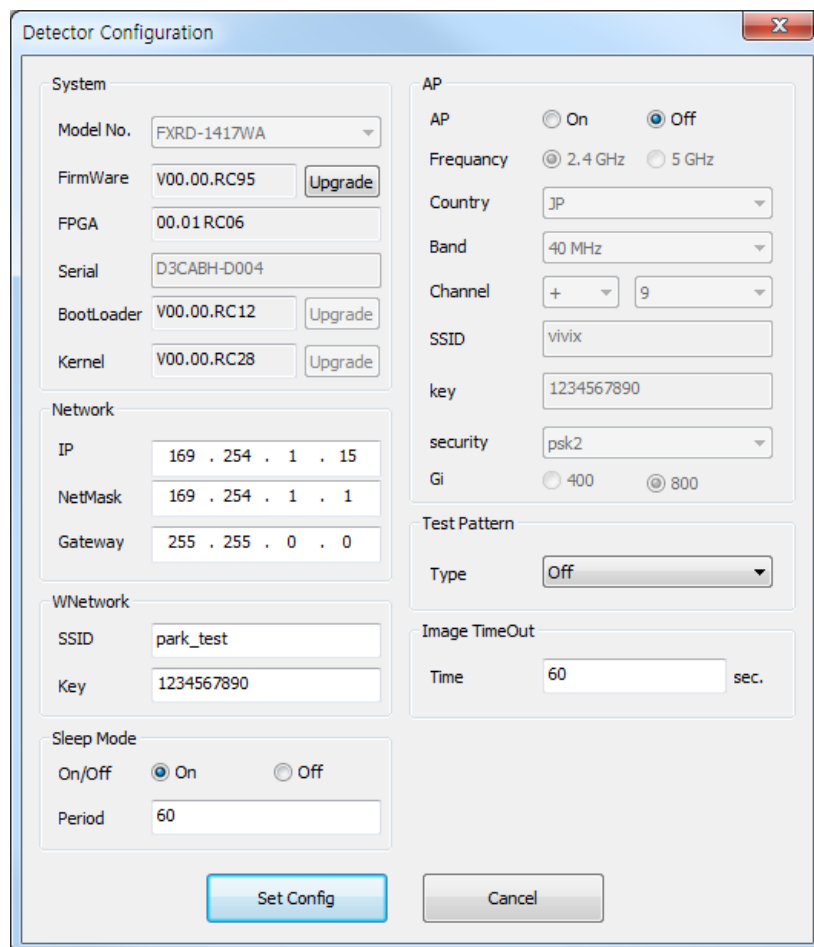

The Detector Configuration window allows you to configure the following items.

- System
 - Model No.: Name of device
 - FirmWare: Version of detector's firmware
 - FPGA: Version of detector's FPGA
 - Serial: Serial number of detector
 - BootLoader: Version of detector's Boot loader
 - Kernel: Version of detector's Kernel

- Network
 - IP: Network IP address of detector
 - NetMask: Network Netmask of detector
 - Gateway: Network Gateway address of detector



- WNetwork
 - SSID: Wireless network ID of detector
 - Key: Wireless network key value of detector

- Sleep Mode
 - On/Off: Configures whether the detector uses Sleep Mode.
 - Period: Configures the time of entering Sleep Mode.

- AP
 - AP On/Off: Configures whether to run Detector as AP mode.
 - Frequency: Frequency channel of wireless network
 - Country: Country code of wireless network
 - Band: Wireless network bandwidth
 - Channel: Wireless network channel
 - SSID: Wireless network ID
 - Key: Wireless network key value
 - Security: Authentication protocol for wireless network
 - Gi: Guard Interval of wireless network

- Test Pattern
 - Type: Type of detector's test pattern image

- Image TimeOut
 - Time Set timeout not to request transmission when acquired image is not transmitted within specified time.



5.4 Detector Calibration

5.4.1 Configuring the Detector

- 1 Select **System Configuration** in the left Step item.

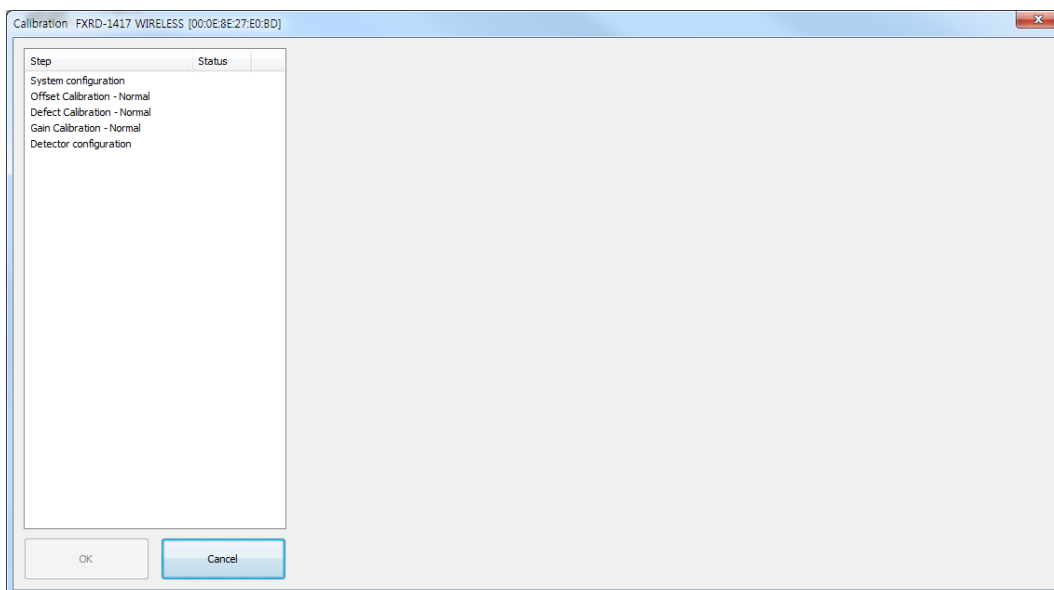

- 2 The information for the selected detector will be displayed.

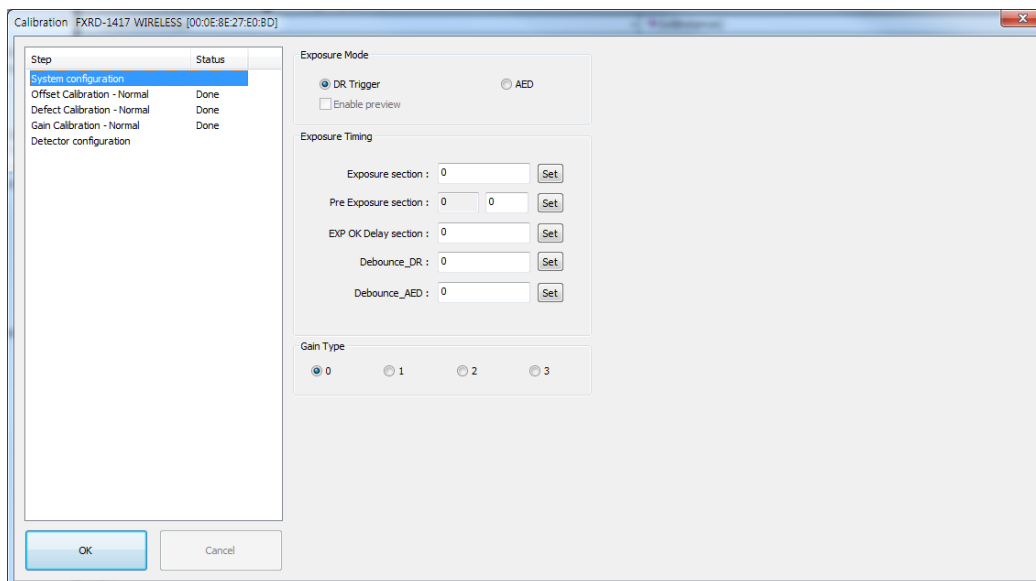

5.4.1.1 Setting Exposure Mode

User can set the detector to three different exposure modes according to the connection type to the X-ray generator. Select the desired mode on **System configuration**.



For detailed information on X-ray exposure mode, refer to [2.6.1 X-ray Exposure Mode](#).

The screenshot shows a configuration window titled "Exposure Mode". It contains two radio button options: "DR Trigger" and "AED". The "AED" option is selected, indicated by a blue dot inside the radio button.

5.4.1.2 Timing Setting

To acquire correct images, exact timing setting must be made according to the characteristics of the X-ray generator.

The screenshot shows a configuration window titled "Exposure Timing". It contains five rows of input fields, each with a "Set" button:

- Exposure section : 500
- Pre Exposure section : 14 0
- EXP OK Delay section : 1
- Debounce_DR : 3
- Debounce_AED : 3

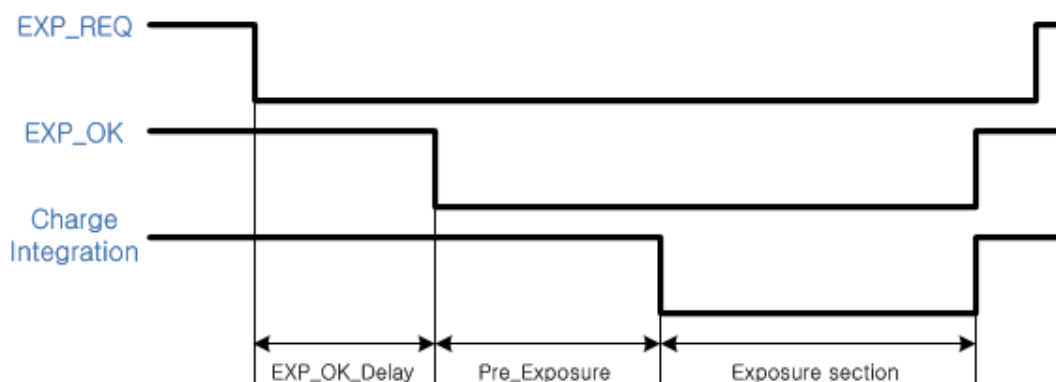

Exposure section

Exposure section :

Exposure section indicates the period (unit: ms) that the detector converts X-rays to image signals. This value needs to be set longer than the exposure time of X-ray generator to prevent X-rays loss while converting X-rays to image signals. If you change the time settings, refresh the Post-offset data and generate new GAIN data to acquire optimized images.



The recommended Exposure section value is 500 ms (Standard).

Pre Exposure section

Pre Exposure section :

The Pre Exposure section is allowed to use when delay is occurred until the generator receives EXP-OK signal from the detector and prepares X-ray generation. Pre Exposure section is set as 0 ms normally, however, it is recommend to set the actual delay time of generator's X-ray generation with measurements to achieve the best performance of the detector. The detector sends EXP_OK signal to the generator, then transforms X-ray into image signal after the time set in the Pre Exposure section.

EXP OK Delay section

EXP OK Delay section :

EXP OK Delay section is delay time from when the detector detects exposure request signal (EXP_REQ) from the X-ray generator to when the detector sends exposure respond signal (EXP_OK) to the X-ray generator. Some X-ray generators need some time to prepare detecting EXP_OK signal after sending EXP_REQ signal. This value is determined according to the specifications of X-ray generator. The default value is 1 ms.



Debounce_DR

Debounce_DR :

Debounce_DR is used to remove unwanted trigger signal occurred due to external noise when DR Trigger is set as Exposure Mode. It is recommended to use the Debounce_DR setting value as default 3 ms. We recommend setting the minimum exposure time of X-ray generator to more than 3 ms. If the value is set to less than 3 ms, the detector may not acquire images.

Debounce_AED

Debounce_AED :

Debounce_AED is used to prevent unwanted imaging occurred due to external noise when AED is set as Exposure Mode. It is recommended to use the default values set by manufacturer. We recommend setting the minimum exposure time of X-ray generator to more than the value set in the Debounce_AED. If the value is set to less than the settings in the Debounce_AED, the detector may not acquire images.

If unwanted images are acquired without X-ray exposure while operating the equipment, set Debounce_AED with 1 ms increments. However, make sure not to exceed 5 ms since an image degradation may appear in the image if Debounce AED exceeds 5 ms.

5.4.1.3 Gain Type Setting

Gain Type

0 1 2 3

To acquire X-ray image with proper brightness, adjust the Gain Type setting. You can select the Gain Type to adjust the sensitivity of the detector, then you can acquire X-ray images with desired brightness according to the specifications of X-ray generator or the type of objects. The default gain type is 1.

The following table describes each Gain Type of the sensitivity ratio.

| Gain Type | | 0 | 1 | 2 | 3 |
|----------------|-------------------|------|---|------|------|
| Gadox Detector | Sensitivity ratio | 0.86 | 1 | 1.2 | 1.5 |
| CsI Detector | Sensitivity ratio | 0.62 | 1 | 1.14 | 1.33 |



The owner is responsible for ensuring that the Gain Pixel Correction is performed after adjusting the Gain Type.

5.4.2 Offset Calibration

5.4.2.1 Pre-offset Calibration

- 1 Select **Dark acquisition–Normal** and click the **Load pre-offset** button to apply pre-offset data which is provided with the flat panel detector.

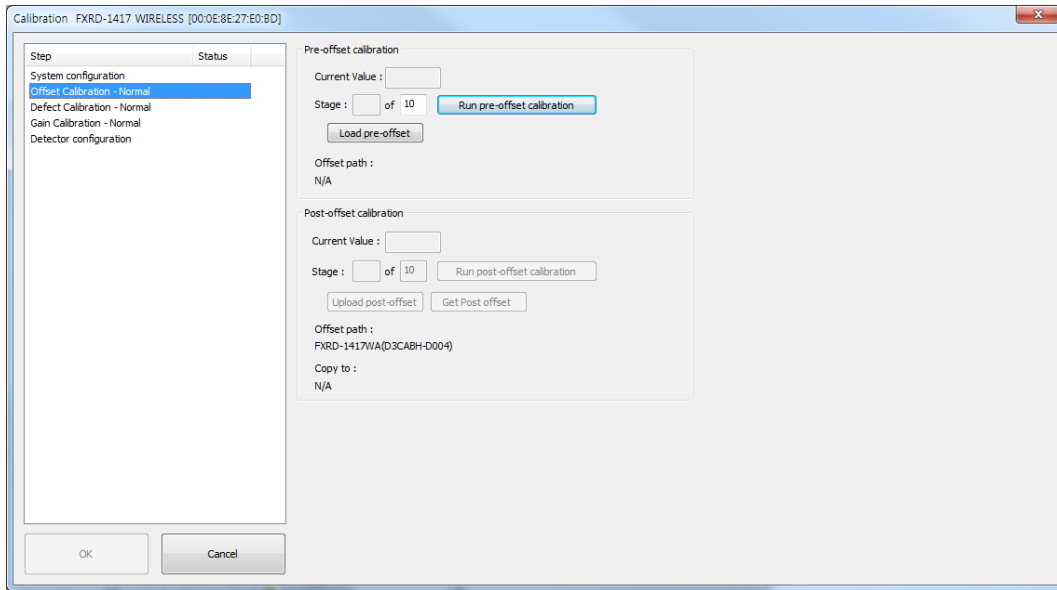

- 2 When you create new pre-offset data, input the number of images to be acquired to **Stage** in the Pre-offset calibration item and then click the **Run pre-offset calibration** button.
- 3 Acquiring image process will be proceeded automatically, then the average value of acquired images will be displayed in **Current Value** and the current status will be displayed in **Stage**.
- 4 After acquiring images, a window for saving created pre-offset data appears, then specify a directory to save the data.

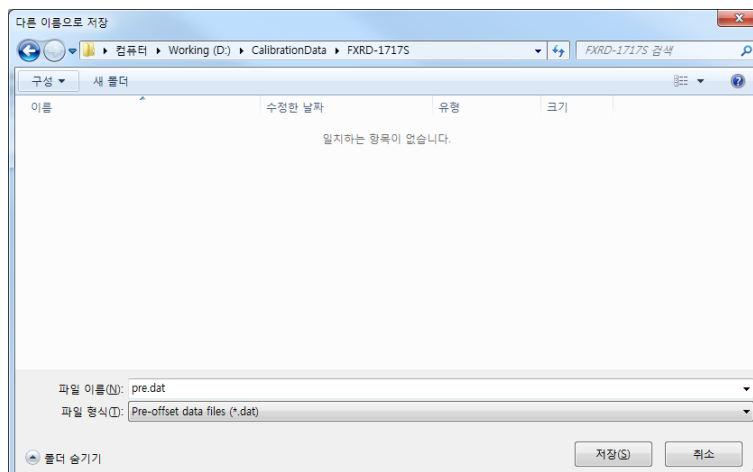

5.4.2.2 Post-offset Calibration

- 1 Click the **Get Post offset** button to locally save the offset file that is backed up on the detector.
- 2 When you create new post-offset data, input the number of images to be acquired to **Stage** in the Post-offset calibration and click the **Run post-offset calibration** button.

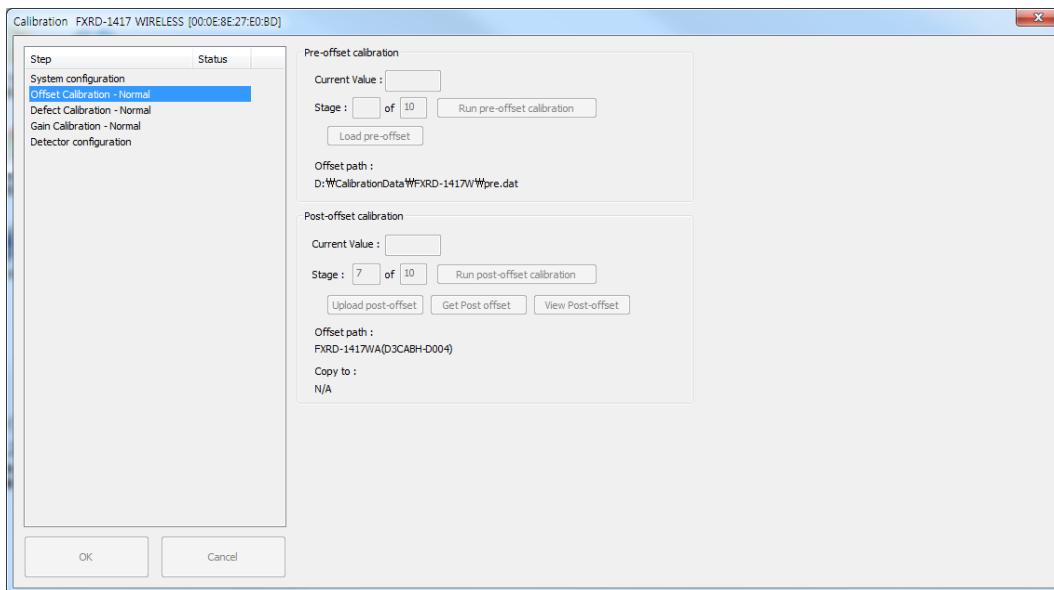

- 3 Acquiring image process will be proceeded automatically, then the average value of acquired images will be displayed in **Current Value** and the current status will be displayed in **Stage**.
- 4 After acquiring images, a window for saving created post-offset data appears, then specify a directory to save the data.
- 5 To save the previously created post-offset file to the detector, click the **Upload post offset** button and then select the file to upload.



The offset data that is already uploaded to the detector will be used for acquiring images with wireless detector instead of the data stored in the local.



5.4.3 Defect Correction

5.4.3.1 Load defect map

- 1 Select **Defect detection – Normal** in the left Step item.

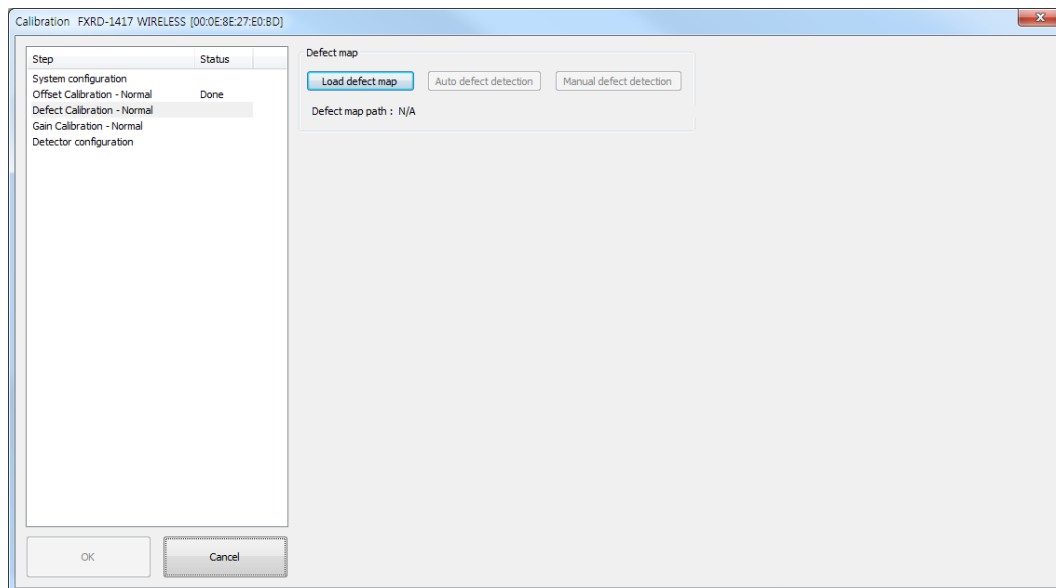

- 2 Click the **Load defect map** button to apply the defect data which is provided with the flat panel detector.

5.4.3.2 Auto defect detection

- 1 To create new defect map, apply the Defect data which is provided with the flat panel detector and then click the **Auto defect detection** button.

- 2 Acquire X-ray images and adjust the doses of radiation to match the Current value to the Target Value of Flat30. When the Current value reaches within 10% of Target Value, keep the doses of radiation at that point.



For Flat30 and Flat60 the recommended Target Values are respectively 250 and 500.

- 3 To save the collected image data, check the **Save acquired data** checkbox. Once the images of Flat30 and Flat 60 are acquired, it is allowed to save as a file.
- 4 Click the **Get Flat30** button to acquire as many images as the number set at the top of the Stage. Or, load the Flat30 image which is previously saved by clicking the **Load Flat30** button.



- 5 Acquire X-ray images and adjust the doses of radiation to match the Current Value to the Target Value of Flat60. When the Current value reaches within 10% of Target Value, keep the doses of radiation at that point.

- 6 Click the **Get Flat60** button and acquire as many images as the number set at the top of the Stage. Or, load the Flat60 image which is previously saved by clicking the **Load Flat60** button.

- 7 Enter the detection range of Defect data into the **Tolerance** field based on the acquired images.



The recommended Tolerance value is 3%.

- 8 Click the **Generate Defect Map** button, create the new Defect Map Data file, and then save it.



No need to click the **Load defect map** button since the Defect Map file is automatically created and loaded.

5.4.3.3 Manual defect detection

- 1 To create the new defect map manually, click the **Manual defect detection** button after applying Defect data provided accordingly.



To use the Manual defect detection feature, the previously acquired dark image is needed. The dark image can be acquired in the Diagnosis Mode.

- 2 Select the original image file of the detector to find the defect data.

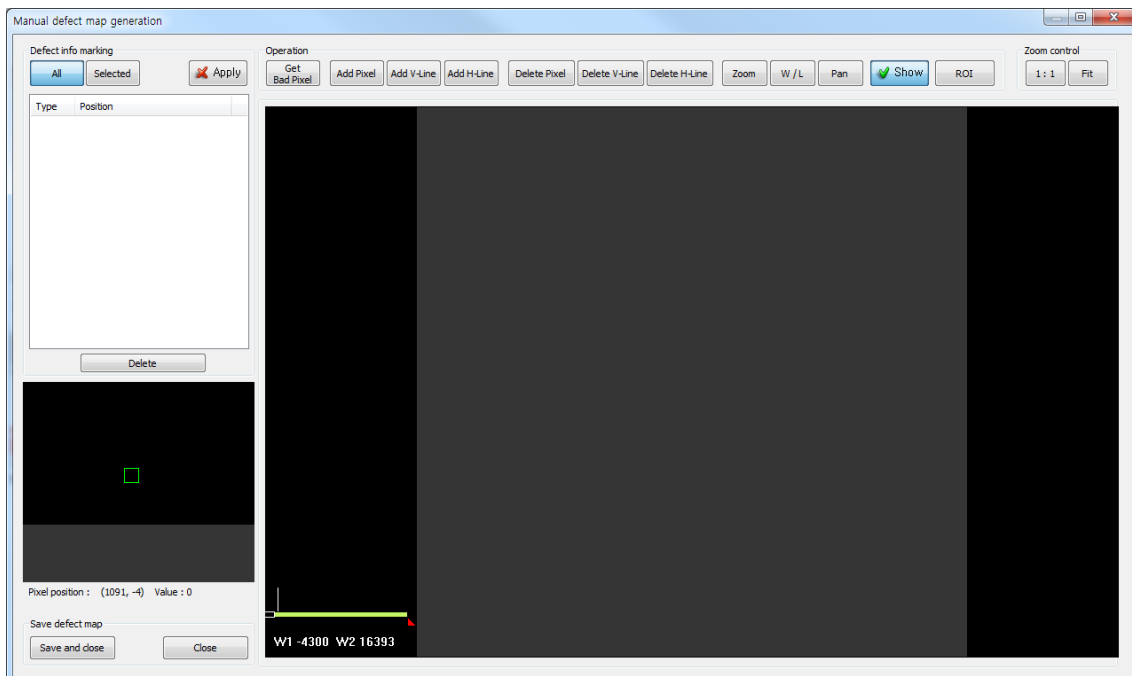

Defect info marking

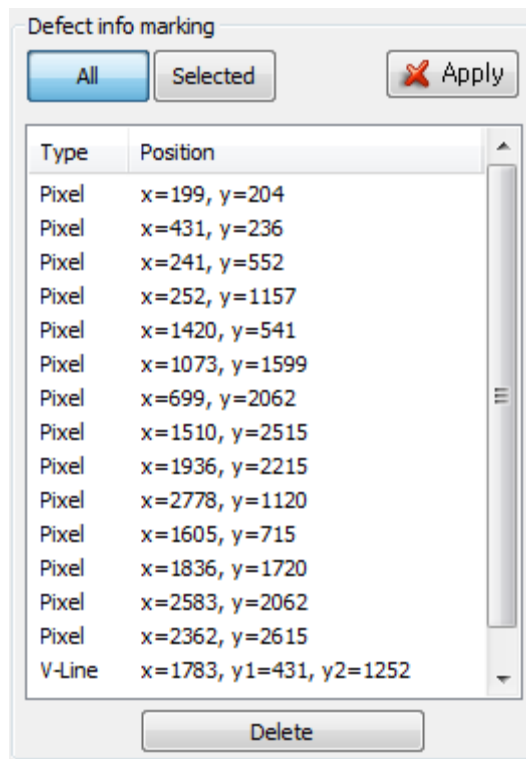

- **Apply:** Apply Defect information of selected items from the list to image.
- **All:** Apply all items from the list.
- **Selected:** Apply the only selected items from the list.
- **Delete:** Delete the selected items from the list.

Operation / Zoom control

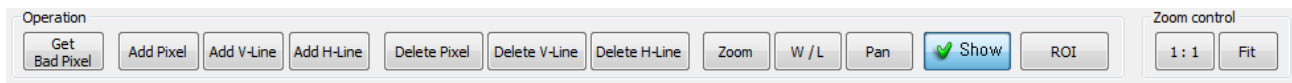

- **Get Bad Pixel:** Automatically detect the defect pixel from the currently displayed image.



When you select the **Get Bad Pixel** feature, all items of the Defect info marking list are automatically applied to the image.

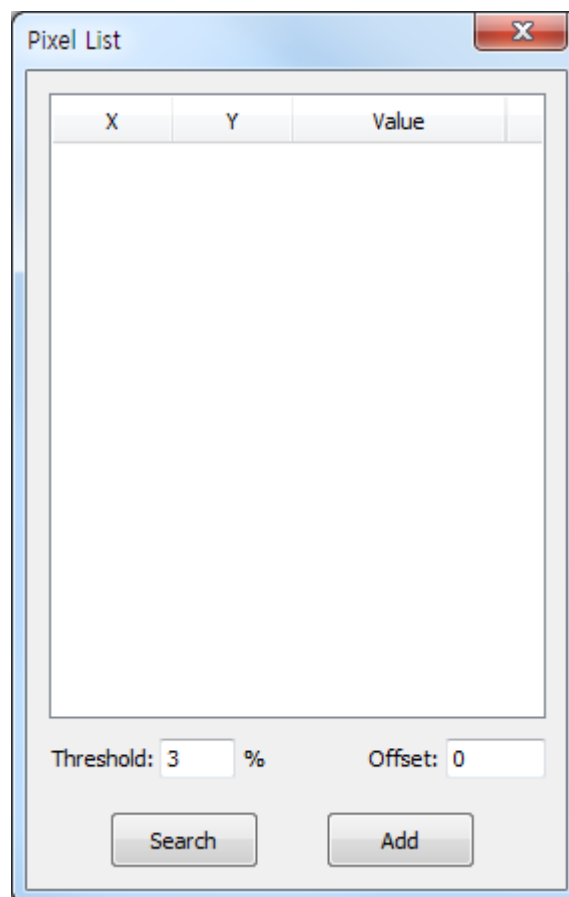

- 1 Enter the value of threshold and offset to detect the defect pixel.
- 2 Click the **Search** button to search the automatically detected list.



- 3 Select an item to add to the Defect list, and then click the **Add** button.
 - Add Pixel: Add one pixel unit of defect pixel.
 - Add V-Line: Add line type of defect pixels vertically.
 - Add H-Line: Add line type of defect pixels horizontally.

 - Delete Pixel: Delete one pixel unit of defect pixel.
 - Delete V-Line: Delete line type of defect pixels vertically.
 - Delete H-Line: Delete line type of defect pixels horizontally.

 - Zoom: Zoom in or out the image.
 - W/L: Adjust the window level of the image.
 - Pan: Move the image.
 - Show: Determine whether to display the selected defect pixel on the image.
 - ROI: Automatically adjust the window level based on the Min. and Max. value of the selected area.
 - 1:1: Display the image at one to one ratio.
 - Fit: Display the image to fit into the screen.

- 4 Once it is finished to display the defect pixels in the image, save the newly created defect map file and complete the process by clicking the **Save and close** button. To cancel it, click the **Close** button.

5.4.4 Gain Pixel Correction

Before performing Gain Pixel Correction, consider followings:

- Recommended SID is 150 cm (distance between X-ray tube and Detector).
- Open the collimator of X-ray tube completely.
- Align the center of the detector with the center of collimator.
- Keep everything away from the detector surface.

- 1 Select **Gain acquisition – Normal** in the left Step item. Expose X-rays and adjust dose of X-rays so that Current Value reaches TargetValue. Keep the quantity of X-rays when Current Value remains within 10% difference of TargetValue.



Recommended TargetValue is 2000.

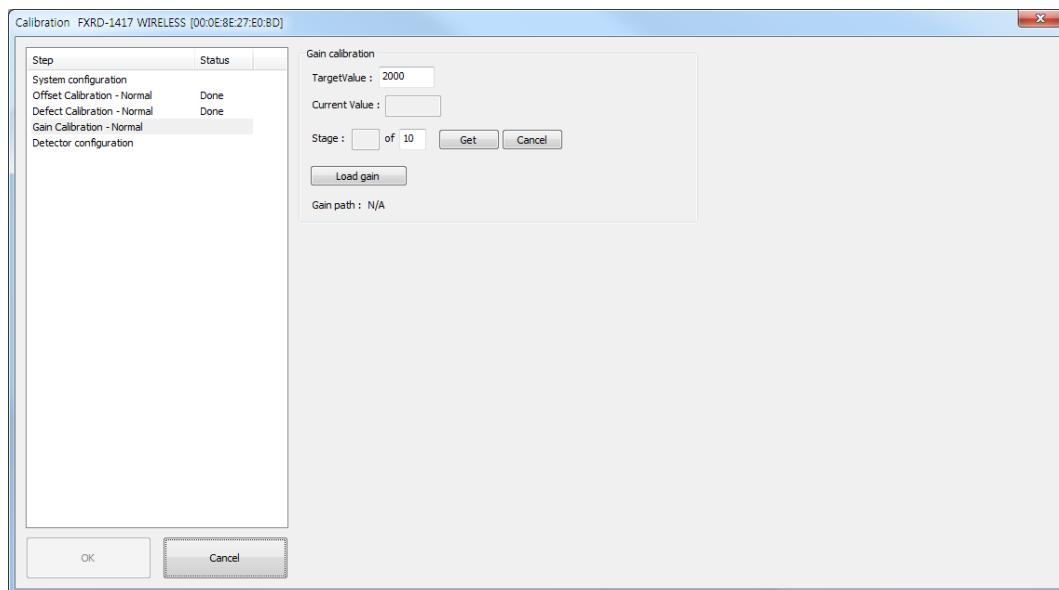

- 2 Click the **Get** button and expose X-rays ten times.
- 3 Save the Gain data to the desired folder.
- 4 Once all the procedures are completed, the OK button will be activated. Click the **OK** button to close the dialog box.

5.4.5 Detector Preference

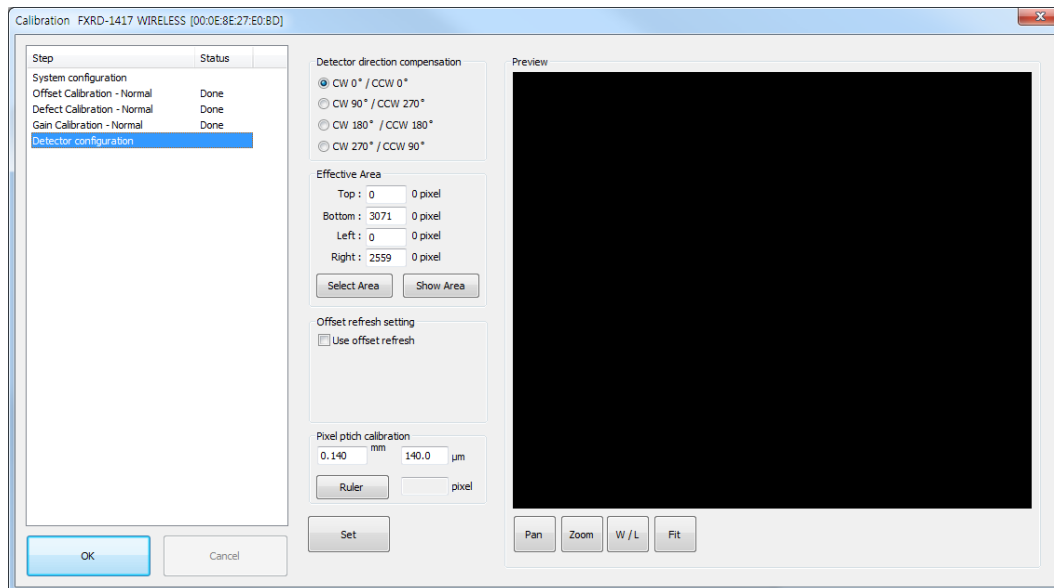

- 1 If you need to rotate the detector, select the value of Detector direction compensation.
- 2 To exclude the particular area of an image, select the desired area by clicking the **Show Area** button after acquiring an image, or click the **Select Area** button after entering the size of image in the **Effective Area** field.
- 3 To renew the automatic offset of the detector, check the **Use offset refresh** checkbox and set time interval, temperature, the number of acquiring images.



Once the **Use offset refresh** checkbox is checked, the temperature of detector is monitored at the time interval specified. If there is difference between the current temperature and the specified one, images are acquired according to the number of acquiring images which you have already set, and then the offset is renewed.

- 4 Click the **Ruler** button after acquiring an image, measure the length of it, and then enter the value.
- 5 Enter all the data you need, and then save the setting by clicking the **Set** button at the bottom.

5.5 Diagnosis Mode

In Diagnosis Mode you can review the images acquired by using the trigger or clicking the **Normal Grab** button. The number of images, pixel value and ROI value will be displayed on the right side of the **Diagnose** window.

Click the **Save Image** button to save the acquired image.

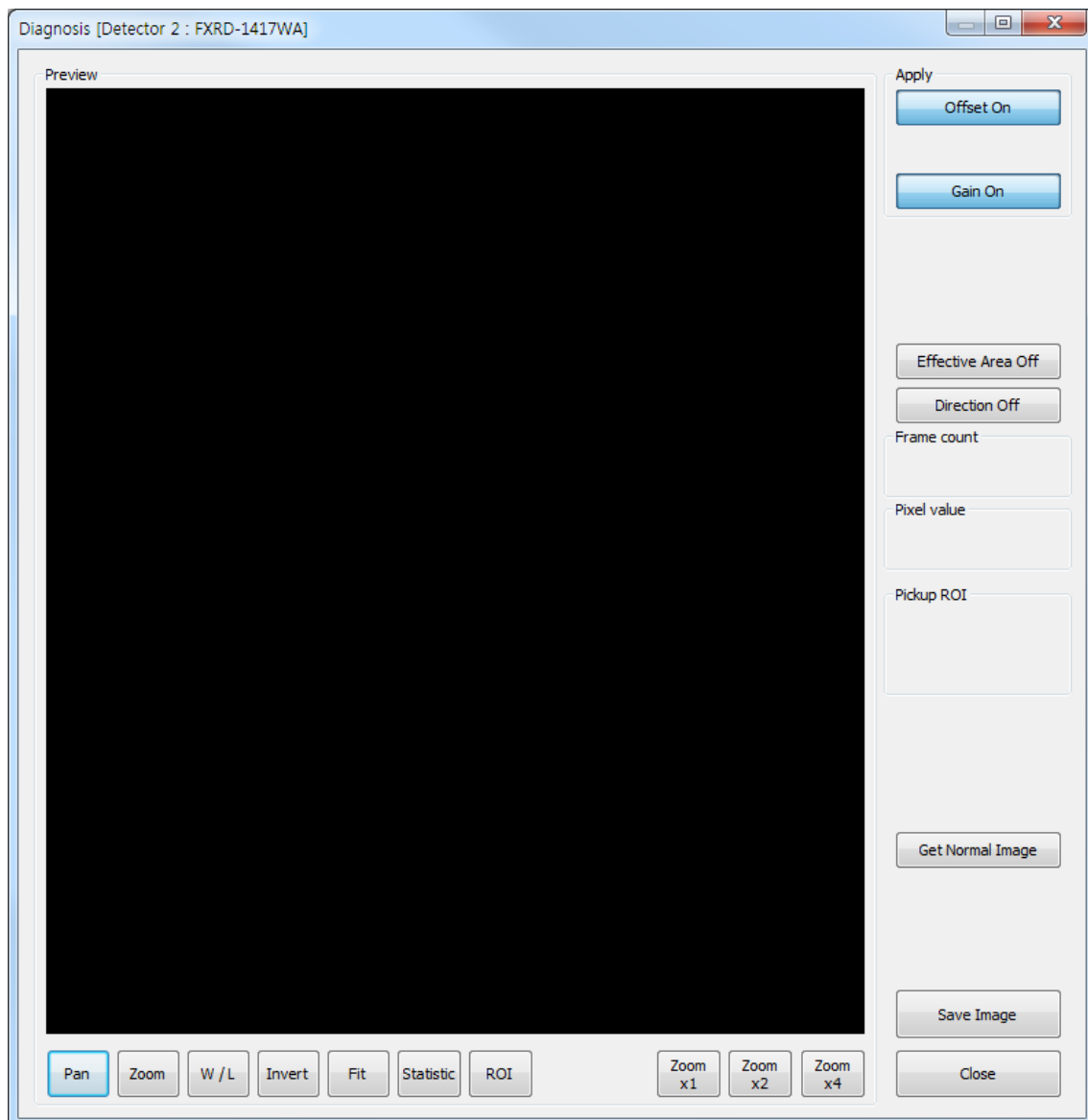



The **Diagnose** window provides the following function buttons to manipulate the acquired image.

- **Pan:** Move an image.
 - **Zoom:** Press and hold the left mouse button and then drag to zoom in or out.
 - **W/L:** Press and hold the left mouse button and then move the mouse up, down, left or down to adjust Window Level. Basically this function is also available by using the right mouse button without clicking the W/L button.
 - **Fit:** Fit the panned image to the center.
 - **Statistic:** Press and hold the left mouse button and then drag to specify a region. The coordinates of image, Min/Max value, mean deviation, standard deviation, etc will be displayed in the Pickup ROI.
 - **ROI:** Press and hold the left mouse button and then drag to specify a region. The Window Level will be adjusted automatically based on Min and Max value of the region.
- Zoom $\times 1 \sim \times 16$: Magnify the image $\times 1$ to $\times 16$.



6. Operation



For the detailed operation, refer to the VXvue User Manual.

- 1 Register a patient.
- 2 Register Body parts.
- 3 Arrange the patient in the correct position to have detector aligned with the target body part.
- 4 Position the X-ray generator to adjust the exposure field.
- 5 Adjust kVp, mA, ms and mAs for best condition depending on body part and projection.
- 6 Press the exposure switch of the X-ray generator. You can check the images on the monitor after image processing.

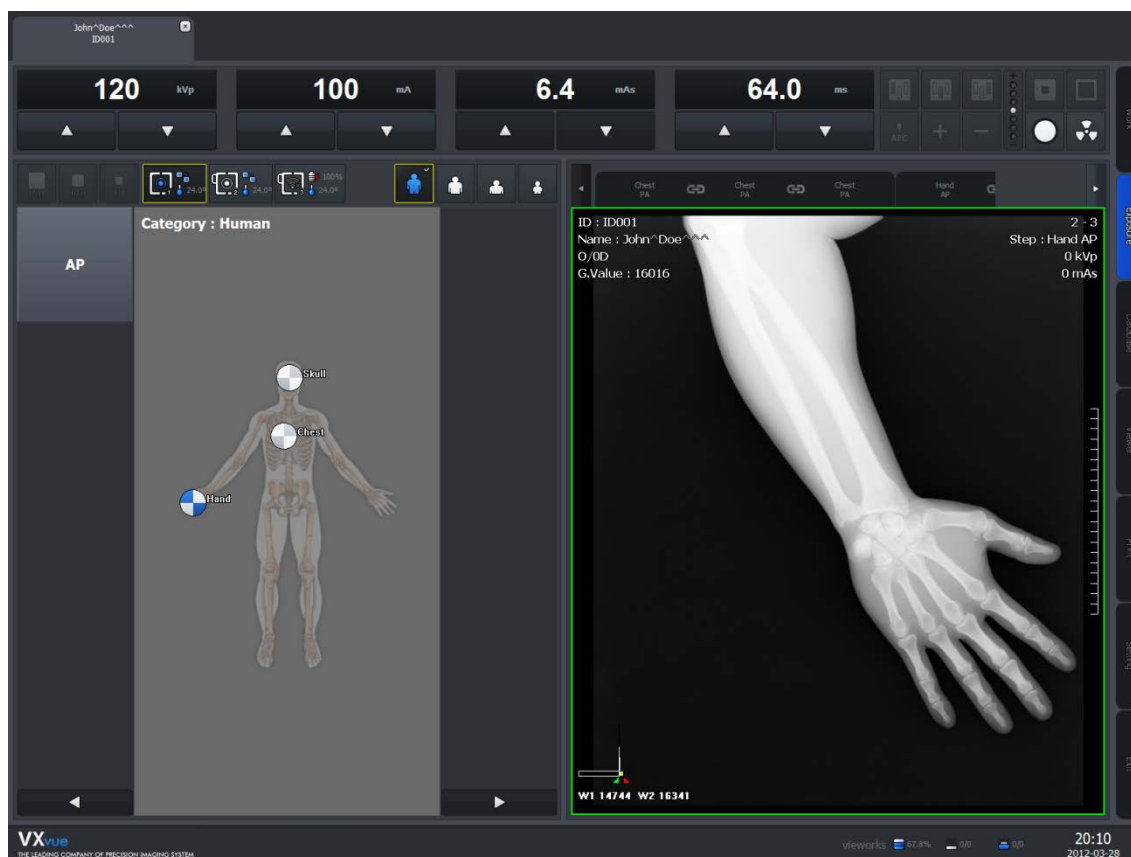



7. Maintenance

7.1 Function Test

| Item | Period | Description |
|------------------------|-----------|--|
| Power consumption | Daily | Confirm that the power operation of detector is normal. |
| Temperature | Daily | Check the monitoring in order to minimize the characteristic changes of Flat panel caused by external temperature changes. |
| Hard disk space | Daily | Check if the hard disk is enough to save images and allow the consecutive shootings. |
| Worklist connection | Daily | Check the worklist connection to allow consecutive shootings. |
| PACS server connection | Daily | Check the PACS server connection to send images. |
| Printing Test | Daily | Check the printer connection and print images |
| Auto offset | Daily | Check that Flat panel's offset changes caused by the increased heat are automatically corrected. |
| Resolution | Monthly | Confirm the resolution of the detector. |
| Image Acquisition Time | Monthly | Confirm the acquisition of time required to get image designed with optimal specifications. |
| Linearity | Quarterly | Evaluate the distinct characteristics of detector through the amount of radiation coming into Flat Panel Detector, resolution and contrast of images/projections, and the unification of noises of projection. |
| DQE | Quarterly | Evaluate the distinct characteristics of detector through the amount of radiation coming into Flat Panel Detector, resolution and contrast of images/projections, and the unification of noises of projection. |
| MTF | Quarterly | Evaluate the distinct characteristics of detector through the amount of radiation coming into Flat Panel Detector, resolution and contrast of images/projections, and the unification of noises of projection. |
| Calibration | Annually | Compensates defect pixels and calibrates pixel gain using the installed X-ray generator and X-ray tube. |



7.2 Maintenance Guidelines for Users and Test Forms

Maintenance

If you have any inquiries about trouble shooting or the product seems to have a problem, please contact Vieworks. For optimal performance, we recommend that the working area be kept clean.



Federal law restricts this device to be dealt or operated by a physician or medical assistant.

Contact Information

Address: Vieworks Co., Ltd
#107-108, 601-610 Suntechcity II
52, Sagimakgol-ro (307-2 Sangdaewon-dong),
Jungwon-gu, Seongnam-si, Gyeonggi-do
462-806 South Korea

Phone: +82-70-7011-6161

Fax: +82-31-737-4954

email: vieworks@vieworks.com

Cleaning

Use a dry cloth to clean surfaces of the system. Do not use detergents or organic solvents to clean the system.



Do not use abrasive brush, scraper, or acid/alkaline cleaner when cleaning your product.



Test Forms

| | | | |
|---|--------------------------|--|--------------------------------------|
| Test ITEM (1) | Power Consumption | | |
| | Frequency | D: Daily <input checked="" type="checkbox"/> | M: Monthly <input type="checkbox"/> |
| | | Q: Quarterly <input type="checkbox"/> | A: Annually <input type="checkbox"/> |
| <p>Objective: Confirm that the power operation of detector is normal.</p> <p>Equipment: Workstation, VXvue S/W Power supply, Power Meter Inspection Report Form,</p> <p>Procedure: Turn on the power of the system. Run VXvue. Read the data indicated by Power Meter.</p> <p>Performance and Corrective Action: Power Consumption of Max. 200VA is secured. Light green colored LED should be turned on. If the power consumption exceeds the tolerance limit, service assistance is necessary. If the LED is not turned on, service assistance is necessary. Record result on Inspection Report Form.</p> | | | |
| <p>Result: Frequency: D: <input type="checkbox"/>, M: <input type="checkbox"/>, Q: <input type="checkbox"/>, A: <input type="checkbox"/> Date: 20**-**-** Operator: Limit of Acceptability: Max. 200VA</p> <p>Remarks:</p> | | | |



| | | | |
|--|--------------------|--|--------------------------------------|
| Test ITEM (2) | Temperature | | |
| | Frequency | D: Daily <input checked="" type="checkbox"/> | M: Monthly <input type="checkbox"/> |
| | | Q: Quarterly <input type="checkbox"/> | A: Annually <input type="checkbox"/> |
| <p>Objective: Check the monitoring in order to minimize the characteristic changes of Flat panel caused by external temperature changes.</p> <p>Equipment: Workstation, VXvue S/W Power supply, Power Meter Inspection Report Form</p> <p>Procedure: Turn on the power of the system. Run VXvue. Check the temperature.</p> <p>Performance and Corrective Action: Confirm that the detector and ambient temperature is lower or higher than the operating temperature stated in this Service Manual. If the detector and ambient temperature deviates from the operating range, adjust the detector and ambient temperature properly to prevent poor image quality. If the image quality is reduced after adjusting the temperature, service assistance is necessary. Record result on Inspection Report Form.</p> | | | |
| <p>Result: Frequency: D: <input type="checkbox"/>, M: <input type="checkbox"/>, Q: <input type="checkbox"/>, A: <input type="checkbox"/> Date: 20**-**-** Operator:</p> <p>Limit of Acceptability: +10 ~ +35°C</p> <p>Remarks:</p> | | | |



| Test ITEM (3) | Hard Disk free space | |
|---|----------------------|--|
| | Frequency | D: Daily <input checked="" type="checkbox"/> M: Monthly <input type="checkbox"/> Q: Quarterly <input type="checkbox"/> A: Annually <input type="checkbox"/> |
| <p>Objective: Confirm that new study can be performed and stored to hard disk drive of workstation.</p> <p>Equipment: Workstation, VXvue S/W Power supply, Power Meter Inspection Report Form</p> <p>Procedure: Turn on the power of the system. Run VXvue. Check hard disk free space indication is not red light.</p> <p>Performance and Corrective Action: If the hard disk free space indication is not red, new study can be performed. If the hard disk free space indication is red, delete old study to make free hard disk space enough to perform new study. Record result on Inspection Report Form.</p> | | |
| <p>Result: Frequency: D: <input type="checkbox"/>, M: <input type="checkbox"/>, Q: <input type="checkbox"/>, A: <input type="checkbox"/> Date: 20**-**-** Operator:</p> <p>Limit of Acceptability: N/A</p> <p>Remarks:</p> | | |



| Test ITEM (4) | Work list connection | |
|--|----------------------|--|
| | Frequency | D: Daily <input checked="" type="checkbox"/> M: Monthly <input type="checkbox"/> Q: Quarterly <input type="checkbox"/> A: Annually <input type="checkbox"/> |
| <p>Objective: Confirm that VXvue is connected normally with Worklist and can register study by querying from Worklist server.</p> <p>Equipment: Workstation, VXvue S/W, Work List Server Power supply, Power Meter Inspection Report Form</p> <p>Procedure: Turn on the power of the system. Run VXvue. Select Setting Mode. Select DICOM tab. Select MWL tab. Select Worklist server. Click the Echo button.</p> <p>Performance and Corrective Action: Check the connection status that is displayed in test result window. If connection test failed, check Worklist server is operating and configuration of Worklist server connection is correct. If still Worklist connection fails, service assistance is necessary. Record result on Inspection Report Form.</p> | | |
| <p>Result: Frequency: D: <input type="checkbox"/>, M: <input type="checkbox"/>, Q: <input type="checkbox"/>, A: <input type="checkbox"/> Date: 20**-**-** Operator:</p> <p>Limit of Acceptability: N/A</p> <p>Remarks:</p> | | |



| Test ITEM (5) | PACS Server connection | |
|---|------------------------|--|
| | Frequency | D: Daily <input checked="" type="checkbox"/> M: Monthly <input type="checkbox"/> Q: Quarterly <input type="checkbox"/> A: Annually <input type="checkbox"/> |
| <p>Objective: Confirm that VXvue is connected normally with PACS Server and can send performed study data to PACS server.</p> <p>Equipment: Workstation, VXvue S/W, PACS Server Power supply, Power Meter Inspection Report Form</p> <p>Procedure: Turn on the power of the system. Run VXvue. Select Setting Mode. Select DICOM tab. Select Storage tab. Select Storage Server. Click the Echo button.</p> <p>Performance and Corrective Action: Check the connection status that is displayed in test result window. If connection test failed, check PACS server is operating and configuration of PACS server connection is correct. If still PACS server connection fails, service assistance is necessary. Record result on Inspection Report Form.</p> | | |
| <p>Result: Frequency: D: <input type="checkbox"/>, M: <input type="checkbox"/>, Q: <input type="checkbox"/>, A: <input type="checkbox"/> Date: 20**-**-** Operator:</p> <p>Limit of Acceptability: N/A</p> <p>Remarks:</p> | | |



| Test ITEM (6) | Printing Test | |
|---|---------------|--|
| | Frequency | D: Daily <input checked="" type="checkbox"/> M: Monthly <input type="checkbox"/> Q: Quarterly <input type="checkbox"/> A: Annually <input type="checkbox"/> |
| <p>Objective: Confirm that VXvue is connected normally with Printer and can print images.</p> <p>Equipment: Workstation, VXvue S/W, DICOM Printer or Paper Printer that is installed. Power supply, Power Meter Inspection Report Form</p> <p>Procedure: Turn on the power of the system. Run VXvue. Select Database Mode. Search database and open study. Click the Print button. Select Print Mode. Click the Print button to print image.</p> <p>Performance and Corrective Action: Confirm that the image is printed normally. If printing failed, check the printer is operating and is configured correctly. If still printing fail, service assistance is necessary. Record result on Daily Report Form.</p> | | |
| <p>Result: Frequency: D: <input type="checkbox"/>, M: <input type="checkbox"/>, Q: <input type="checkbox"/>, A: <input type="checkbox"/> Date: 20**-**-** Operator:</p> <p>Limit of Acceptability: N/A</p> <p>Remarks:</p> | | |



| | | | |
|---|--------------------|--|--------------------------------------|
| Test ITEM (7) | Auto offset | | |
| | Frequency | D: Daily <input checked="" type="checkbox"/> | M: Monthly <input type="checkbox"/> |
| | | Q: Quarterly <input type="checkbox"/> | A: Annually <input type="checkbox"/> |
| <p>Objective: Check that Flat panel's offset changes caused by the increased heat are automatically corrected.</p> <p>Equipment: Workstation, VXvue S/W Power supply, Power Meter Stop watch Inspection Report Form</p> <p>Procedure: Turn on the power of the system. Run VXSetup. Set the period of offset or temperature change. Run VXvue.</p> <p>Performance and Corrective Action: Check if Auto offset is set and performed when operating VXvue. Check if Auto offset operates after the chosen time setting is over. If offset is not set automatically and does not perform, ask for service assistance. If the chosen time setting is exceeded, recheck the time setting. If the image is not normal due to the dislocation of offset, send the image and ask for service assistance. Record result on Inspection Report Form.</p> | | | |
| <p>Result: Frequency: D: <input type="checkbox"/>, M: <input type="checkbox"/>, Q: <input type="checkbox"/>, A: <input type="checkbox"/> Date: 20**-**-** Operator:</p> <p>Limit of Acceptability: N/A</p> <p>Remarks:</p> | | | |



| Test ITEM (8) | Resolution | |
|--|------------|--|
| | Frequency | D: Daily <input type="checkbox"/> M: Monthly <input checked="" type="checkbox"/> Q: Quarterly <input type="checkbox"/> A: Annually <input type="checkbox"/> |
| <p>Objective: Confirm the resolution of the detector.</p> <p>Equipment: Workstation, VXSetup S/W Power supply, Power Meter Resolution Chart (Nuclear Associate, model 07-523-2 or Line pair CHART 0.05mmPb CN37076) X-ray GEN., X-ray Tube Inspection Report Form</p> <p>Procedure: Turn on the power of the system. Run VXSetup. Open the Diagnose window. Attach resolution chart (Line pair CHART 0.05 mm Pb CN37076, model 07-523-2) on the center of the detector with diagonal direction. Set X-ray generator to 50kVp, 2mAs and SID to 1m. Expose X-rays. Confirm that the resolution is over 3.5lp/mm.</p> <p>Performance and Corrective Action: Confirm that the resolution is over 3.5lp/mm. If the resolution is under 3.5lp/mm, then test again by adjusting mAs from 1mAs to 5mAs. If still resolution is under 3.5lp/mm, service assistance is necessary. Record result on Inspection Report Form.</p> | | |
| <p>Result: Frequency: D: <input type="checkbox"/>, M: <input type="checkbox"/>, Q: <input type="checkbox"/>, A: <input type="checkbox"/> Date: 20**-**-** Operator:</p> <p>Limit of Acceptability: 3. 5lp/mm</p> <p>Remarks:</p> | | |



| Test ITEM (9) | Image Acquisition Time | |
|---|------------------------|--|
| | Frequency | D: Daily <input type="checkbox"/> M: Monthly <input checked="" type="checkbox"/> Q: Quarterly <input type="checkbox"/> A: Annually <input type="checkbox"/> |
| <p>Objective: Confirm the acquisition of time required to get image designed with optimal specifications.</p> <p>Equipment: Workstation, VXvue S/W Power supply, Power Meter X-ray GEN., X-ray Tube Stop watch Inspection Report Form</p> <p>Procedure: Turn on the power of the system. Run VXvue. Select Exposure Mode. Register patient. Expose X-rays with the condition of 50kVp and 5 mAs. Check flat Image is acquired and displayed on monitor.</p> <p>Performance and Corrective Action: Check if the image is acquired in 5 to 7 seconds (including the processing time). If image acquisition failed, check the X-ray is exposed normally and the triggering with X-ray generator is properly configured. If still image acquisition fail, service assistance is necessary. Record result on Inspection Report Form.</p> | | |
| <p>Result: Frequency: D: <input type="checkbox"/>, M: <input type="checkbox"/>, Q: <input type="checkbox"/>, A: <input type="checkbox"/> Date: 20**-**-** Operator:</p> <p>Limit of Acceptability:5~7 sec</p> <p>Remarks:</p> | | |



| | | |
|--|------------------|--|
| Test ITEM (10) | Linearity | |
| | Frequency | D: Daily <input type="checkbox"/> M: Monthly <input type="checkbox"/> Q: Quarterly <input checked="" type="checkbox"/> A: Annually <input type="checkbox"/> |
| <p>Objective: Evaluate the image quality according to the amount of radiation coming into Flat Panel Detector.</p> <p>Equipment: Workstation, VXvue S/W Power supply, Power Meter X-ray GEN., X-ray Tube Inspection Report Form</p> <p>Procedure: No Target Gain: 1</p> <p>Performance and Corrective Action: When SID is 150 cm, 1900-2200 Graylevel properties/qualities should be obtained under 70kVp and 2mAs. When SID is 100 cm, 1900-2200 Graylevel properties/qualities should be obtained under 55kVp and 2mAs. If properties/qualities are not obtained, reset the conditions and test again. If properties/qualities are still not obtained after the second test, service assistance is necessary. Record result on Inspection Report Form.</p> | | |
| <p>Result: Frequency: D: <input type="checkbox"/>, M: <input type="checkbox"/>, Q: <input type="checkbox"/>, A: <input type="checkbox"/> Date: 20**-**-** Operator:</p> <p>Limit of Acceptability: SID: 150 cm, 70kVp, 2mAs → 1900 ~ 2200 Graylevel SID: 100 cm, 55kVp, 2mAs → 1900 ~ 2200 Graylevel</p> <p>Remark:</p> | | |



| | | |
|--|------------------|--|
| Test ITEM (11) | DQE | |
| | Frequency | D: Daily <input type="checkbox"/> M: Monthly <input type="checkbox"/> Q: Quarterly <input checked="" type="checkbox"/> A: Annually <input type="checkbox"/> |
| <p>Objective: Evaluate the distinct characteristics of detector through the amount of radiation coming into Flat Panel Detector, resolution and contrast of images/projections, and the unification of noises of projection.</p> <p>Equipment: Workstation, VXvue S/W Power supply, Power Meter X-ray GEN., X-ray Tube Inspection Report Form</p> <p>Procedure: IEC62220-1(RQA 5) in accordance with the conditions</p> <p>Performance and Corrective Action: In case of CSI type, properties/qualities should be obtained more than 45% at 1l/p mm. In case of Gadox type, properties/qualities should be obtained more than 30% at 1l/p mm. If properties/qualities are not obtained, reset the conditions and test again. If properties/qualities are still not obtained after the second test, service assistance is necessary. Record result on Inspection Report Form.</p> | | |
| <p>Result: Frequency: D: <input type="checkbox"/>, M: <input type="checkbox"/>, Q: <input type="checkbox"/>, A: <input type="checkbox"/> Date: 20**-**-** Operator:</p> <p>Limit of Acceptability: CSI: 1l/p mm, more than 45% Gadox: 1l/p mm, more than 30%</p> <p>Remarks:</p> | | |



| | | |
|---|------------------|--|
| Test ITEM (12) | MTF | |
| | Frequency | D: Daily <input type="checkbox"/> M: Monthly <input type="checkbox"/> Q: Quarterly <input checked="" type="checkbox"/> A: Annually <input type="checkbox"/> |
| <p>Objective: Evaluate the distinct characteristics of detector through the amount of radiation coming into Flat Panel Detector, resolution and contrast of images/projections, and the unification of noises of projection.</p> <p>Equipment: Workstation, VXvue S/W D.Q.E Program (Matlab) Power supply, Power Meter X-ray GEN., X-ray Tube Inspection Report Form</p> <p>Procedure: IEC62220-1(RQA 5) in accordance with the conditions</p> <p>Performance and Corrective Action: Properties/qualities should be obtained more than 50% at 1l/p mm. If properties/qualities are not obtained, reset the conditions and test again. If properties/qualities are still not obtained after the second test, service assistance is necessary. Record result on Inspection Report Form.</p> | | |
| <p>Result: Frequency: D: <input type="checkbox"/>, M: <input type="checkbox"/>, Q: <input type="checkbox"/>, A: <input type="checkbox"/> Date: 20**-**-** Operator:</p> <p>Limit of Acceptability: 1l/p mm, more than 50%</p> <p>Remarks:</p> | | |



| Test ITEM (13) | Calibration | |
|--|-------------|--|
| | Frequency | D: Daily <input type="checkbox"/> M: Monthly <input type="checkbox"/> Q: Quarterly <input type="checkbox"/> A: Annually <input checked="" type="checkbox"/> |
| <p>Objective: Compensates defect pixels and calibrates pixel gain using the installed x-ray generator and x-ray tube.</p> <p>Equipment: Workstation, VXSetup S/W Power supply, Power Meter X-ray GEN., X-ray Tube Inspection Report Form</p> <p>Procedure: Turn on the power of the system. Run VXSetup. Operation of calibration: Enter 10 in the Stage of Preoffset and perform the calibration. Operation of calibration: Enter 10 in the Stage of Postoffset and perform the calibration. Operation of calibration: Perform Defect defection. Operation of calibration: Perform Gain correction.</p> <p>Performance and Corrective Action: Featured artifacts are not found if calibration is performed normally. If many artifacts are found, perform calibration again. If many artifacts are still found, service assistance is necessary. Record result on Inspection Report Form.</p> | | |
| <p>Result: Frequency: D: <input type="checkbox"/>, M: <input type="checkbox"/>, Q: <input type="checkbox"/>, A: <input type="checkbox"/> Date: 20**-**-** Operator:</p> <p>Limit of Acceptability: N/A</p> <p>Remarks:</p> | | |



System Discrepancy Form

Installation Site Information: _____

Date: _____ Published by: _____

System Information

X-ray Generator: _____

X-ray Tube: _____

X-ray grid Information: _____

Detector Model: FXRD-1417WA(B)

Serial Number of Detector: _____

Serial Number of Power Supply Unit: _____

Version of VXvue: _____

Version of VXSetup: _____

Comment: _____

System Discrepancy

Date of finding: _____

Operator: _____

How is it found: _____

Comment: _____

Contact Information

Address: Vieworks Co., Ltd
#107-108, 601-610 Suntechcity II,
52, Sagimakgol-ro (307-2 Sangdaewon-dong),
Jungwon-gu, Seongnam-si, Gyeonggi-do
462-806 South Korea

Phone: +82-70-7011-6161

Fax: +82-31-737-4954

email: vieworks@vieworks.com



Modification Request Form

Date: _____ Published by: _____

System Information

X-ray Generator: _____

X-ray Tube: _____

X-ray grid Information: _____

Detector Model: FXRD-1417WA(B)

Serial Number of Detector: _____

Serial Number of Power Supply Unit: _____

Version of VXvue: _____

Version of VXSetup: _____

Comment: _____

Modification Request

Software Name: _____

Request: _____

Comment: _____

Contact Information

Address: Viewworks Co., Ltd
 #107-108, 601-610 Suntechcity II,
 52, Sagimakgol-ro (307-2 Sangdaewon-dong),
 Jungwon-gu, Seongnam-si, Gyeonggi-do
 462-806 South Korea

Phone: +82-70-7011-6161

Fax: +82-31-737-4954

email: viewworks@viewworks.com

8. Troubleshooting



Trouble shooting must be performed by technician who is trained by the Vieworks Co., Ltd or an organization certified by Vieworks Co., Ltd.

If an unqualified person performs troubleshooting on the system resulting in damaging the detector, software or hardware, then the Vieworks Co., Ltd or its representative is not responsible for the detector repair regardless of remain warranty.

For more detailed information, refer to the 9. Warranty section.

8.1 Failure Case

| Failure Case | Solution |
|-------------------------------------|----------------|
| Failed to turn on the power of SCU. | Refer to 8.1.1 |
| Power LED isn't lit up. | Refer to 8.1.2 |
| Status LED isn't lit up with green. | Refer to 8.1.3 |
| Communication Test Failure | Refer to 8.1.4 |

8.1.1 Repairing SCU

Check if AC power cable of System Control Unit is securely plugged. If it still does not work, replace the SCU.

8.1.2 Repairing Power Failure

Check if DC power cable is securely plugged and power switch is turned on. If it still does not work, replace the detector.

8.1.3 Configuration Failure

Turn off the SCU and turn it on again. If it still does not work, replace the detector.

8.1.4 Repairing Communication Failure

Check if LAN cable is securely plugged. If it does not work, do the first step of the following and check again. If it still does not work, do the next step.

- Restart VXvue.
- Turn off the SCU and turn it on again.
- Replace the LAN cable.



9. Warranty

Vieworks Co., Ltd warrants that this product will be free from defects in materials and workmanship for a period of twelve (12) months from the date of delivery. If any such product proves defective during this warranty period, Vieworks Co., Ltd at its option, either will repair the defective product without charge for parts and labor, or will provide a replacement in exchange for the defective product. In order to obtain service under this warranty, Customer must notify Vieworks Co., Ltd of the defect before the expiration of the warranty period and make suitable arrangements for the performance of service. Customer shall be responsible for packaging and shipping the defective product to the service center designated by Vieworks Co., Ltd with shipping charges prepaid. Vieworks Co., Ltd shall pay for the return of the product to customer if the shipment is to a location within the country in which the Vieworks Co., Ltd designated service center is located. Customer shall be responsible for paying all shipping charges, duties, taxes, and any other charges for products returned to any other locations.

This warranty shall not apply to any defect, failure, or damage caused by improper or inadequate maintenance and care. Vieworks shall not be obligated to furnish service under this warranty to repair damage resulting from attempts by personnel other than Vieworks Co., Ltd or its representatives to install, repair, or service this product, to repair damage resulting from improper use or connection to incompatible equipment or power source; or to service a product that has been modified or integrated with other products when the effect of such modification or integration increases the time or difficulty of servicing the product.

THIS WARRANTY IS GIVEN BY VIEWORKS CO.,LTD WITH RESPECT TO THIS PRODUCT IN LIEU OF ANY OTHER WARRANTIES, EXPRESS OR IMPLIED. VIEWORKS CO., LTD AND ITS VENDOR DISCLAIM ANY IMPLIED WARRANTIES OF MERCHANTABILITY OR FITNESS FOR A PARTICULAR PURPOSE. VIEWORKS CO., LTD RESPONSIBILITY TO REPAIR OR REPLACE DEFECTIVE PRODUCTS IS THE SOLE REMEDY PROVIDED TO THE CUSTOMER FOR BREACH OF THIS WARRANTY. VIEWORKS AND ITS VENDORS WILL NOT BE LIABLE FOR ANY INDIRECT, SPECIAL, INCIDENTAL, OR CONSEQUENTIAL DAMAGES IRRESPECTIVE OF WHETHER VIEWORKS CO., LTD OR THE VENDOR HAS ADVANCE NOTICE OF THE POSSIBILITY OF SUCH DAMAGES.

There are no warranties which extend beyond the description mentioned in this document.



Vieworks



Vieworks Co., Ltd.

#107-108, 601-610, Suntechcity 2,

52, Sagimakgol-ro (307-2, Sangdaewon-dong),

Jungwon-gu, Seongnam-si, Gyeonggi-do, 462-806, South Korea

Telephone: +82-70-7011-6161 FAX : +82-31-737-4954

Website: <http://www.vieworks.com>

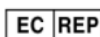

European representative: DONGBANG ACUPRIME

1 Forrest Units, Hennock Road East, Marsh Barton, Exeter EX2 8RU, UK

Tel: +44(0)-1392-829500

Site: <http://www.acuprime.com>

FCC/IC Notice

***5.15- 5.25 GHz band is restricted to indoor operations only.**

***Host device of the approved module shall be marked with the following item:**

Contains Transmitter Module FCC ID: RYK-WPEA121N

Contains IC Number: 6158A-WPEA121NW

Compliance with FCC requirement 15.407(c)

Data transmission is always initiated by software, which is then passed down through the MAC, through the digital and analog baseband, and finally to the RF chip. Several special packets are initiated by the MAC. These are the only ways the digital baseband portion will turn on the RF transmitter, which it then turns off at the end of the packet. Therefore, the transmitter will be on only while one of the aforementioned packets is being transmitted. In other words, this device automatically discontinues transmission in case of either absence of information to transmit or operational failure.

This device complies with part 15 of the FCC Rules. Operation is subject to the following two conditions: (1) This device may not cause harmful interference, and (2) this device must accept any interference received, including interference that may cause undesired operation.

Le présent appareil est conforme aux la partie 15 des règles de la FCC et CNR d'Industrie Canada applicables aux appareils radio exempts de licence. L'exploitation est autorisée aux deux conditions suivantes : (1) l'appareil ne doit pas produire de brouillage, et (2) l'utilisateur de l'appareil doit accepter tout brouillage radioélectrique subi, même si le brouillage est susceptible d'en compromettre le fonctionnement.

This device complies with Industry Canada licence-exempt RSS standard(s). Operation is subject to the following two conditions: (1) this device may not cause interference, and (2) this device must accept any interference, including interference that may cause undesired operation of the device.

Le présent appareil est conforme aux CNR d'Industrie Canada applicables aux appareils radio exempts de licence. L'exploitation est autorisée aux deux conditions suivantes : (1) l'appareil ne doit pas produire de brouillage, et (2) l'utilisateur de l'appareil doit accepter tout brouillage radioélectrique subi, même si le brouillage est susceptible d'en compromettre le fonctionnement.

Under Industry Canada regulations, this radio transmitter may only operate using an antenna of a type and maximum (or lesser) gain approved for the transmitter by Industry Canada. To reduce potential radio interference to other users, the antenna type and its gain should be so chosen that the equivalent isotropically radiated power (e.i.r.p.) is not more than that necessary for successful communication.

Conformément à la réglementation d'Industrie Canada, le présent émetteur radio peut fonctionner avec une antenne d'un type et d'un gain maximal (ou inférieur) approuvé pour l'émetteur par Industrie Canada. Dans le but de réduire les risques de brouillage radioélectrique à l'intention des autres utilisateurs, il faut choisir le type d'antenne et son gain de sorte que la puissance isotrope rayonnée équivalente (p.i.r.e.) ne dépasse pas l'intensité nécessaire à l'établissement d'une communication satisfaisante.

This radio transmitter (identify the device by certification number, or model number if Category II) has been approved by Industry Canada to operate with the antenna types listed below with the maximum permissible gain and required antenna impedance for each antenna type indicated. Antenna types not included in this list, having a gain greater than the maximum gain indicated for that type, are strictly prohibited for use with this device.

Le présent émetteur radio (identifier le dispositif par son numéro de certification ou son numéro de modèle s'il fait partie du matériel de catégorie I) a été approuvé par Industrie Canada pour fonctionner avec les types d'antenne énumérés ci-dessous et ayant un gain admissible maximal et l'impédance requise pour chaque type d'antenne. Les types d'antenne non inclus dans cette liste, ou dont le gain est supérieur au gain maximal indiqué, sont strictement interdits pour l'exploitation de l'émetteur.

FCC CAUTION

- **Changes or modifications not expressly approved by the party responsible for compliance could void the user's authority to operate the equipment.**

This transmitter must not be co-located or operated in conjunction with any other antenna or transmitter.

When installing it in a mobile equipment

This equipment complies with FCC/IC radiation exposure limits set forth for an uncontrolled environment and meets the FCC radio frequency (RF) Exposure Guidelines and RSS-102 of the IC radio frequency (RF) Exposure rules. This equipment has very low levels of RF energy that it deemed to comply without maximum permissive exposure evaluation (MPE). But it is desirable that it should be installed and operated keeping the radiator at least 20cm or more away from person's body in normal use position.

Cet équipement est conforme aux limites d'exposition aux rayonnements énoncées pour un environnement non contrôlé et respecte les règles les radioélectriques (RF) de la FCC lignes directrices d'exposition et d'exposition aux fréquences radioélectriques (RF) CNR-102 de l'IC. Cet équipement émet une énergie RF très faible qui est considérée conforme sans évaluation de l'exposition maximale autorisée. Cependant, il est souhaitable qu'il devrait être installé et utilisé en gardant une distance de 20 cm ou plus entre le dispositif rayonnant et le corps en utilisation normale.)

<LIST OF ACCEPTABLE ANTENNA(S), MODEL, GAIN, IMPEDANCE>

| Model | ANT Model | TYPE | Gain[dBi] | IMPEDANCE |
|----------------------|------------------------|-----------------------|---|------------------|
| FXRD-1417WA/B | AEi-2450/5500DP | PCB Antenna | 4.66 dBi (2.4GHz) 2.19 dBi (5 GHz) | 50 Ω |
| FXRS-03A | JK-450B | Dipole antenna | 3.585 dBi (2.4GHz) 2.830 dBi (5 GHz) | 50 Ω |